

From: Barbadora, Jeff <Jeff.Barbadora@crowncastle.com>

Sent: Thursday, February 8, 2024 4:32 PM

To: LaFountain, Dakota <Dakota.LaFountain@ct.gov>; Victoria Masse
<victoria@northeastsitesolutions.com>

Cc: Jace Raab <jace@northeastsitesolutions.com>; TMO-NSS <tmo-nss@northeastsitesolutions.com>;
DEBORAH CHASE <deborah@northeastsitesolutions.com>; CSC-DL Siting Council
<Siting.Council@ct.gov>

Subject: RE: EM-T-MOBILE-033-220927 - Outstanding Condition

Good afternoon,

Would the Council accept the attached SA. It is the latest SA on the tower with the correct code and does include the T-Mobile antennas.

Thanks,

Jeffrey Barbadora
Permitting Specialist
781-970-0053

Crown Castle
1800 W. Park Drive, Suite 250
Westborough, MA 01581

Date: **October 25, 2023**



Crown Castle
2000 Corporate Drive
Canonsburg, PA 15317
(724) 416-2000

Subject: **Structural Analysis Report**

Carrier Designation: **Verizon Wireless Co-Locate**
Site Number: 5000247946
Site Name: CROMWELL SE CT

Crown Castle Designation: **BU Number:** 876364
Site Name: CROMWELL / FIRST LINE EMERGENC
JDE Job Number: 2103585
Work Order Number: 2265165
Order Number: 658833 Rev. 0

Engineering Firm Designation: **Crown Castle Project Number:** 2265165

Site Data: **201 Main St., CROMWELL, MIDDLESEX County, CT**
Latitude 41° 35' 0.11", Longitude -72° 38' 59.14"
125 Foot - Monopole Tower

Crown Castle is pleased to submit this “**Structural Analysis Report**” to determine the structural integrity of the above-mentioned tower.

The purpose of the analysis is to determine acceptability of the tower stress level. Based on our analysis we have determined the tower stress level for the structure and foundation, under the following load case, to be:

LC7: Proposed Equipment Configuration

Sufficient Capacity – 99.9%

This analysis utilizes an ultimate 3-second gust wind speed of 119 mph as required by the 2022 Connecticut State Building Code. Applicable Standard references and design criteria are listed in Section 2 - Analysis Criteria.

Structural analysis prepared by: Matthew Schmitt

Respectfully submitted by:

Rohit Soni, P.E.
Senior Project Engineer

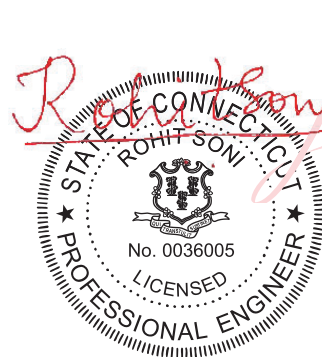

Digitally signed by
Rohit Soni
Date: 2023.10.25
22:14:43 -04'00'

TABLE OF CONTENTS

1) INTRODUCTION

2) ANALYSIS CRITERIA

Table 1 - Proposed Equipment Configuration

Table 2 - Other Considered Equipment

3) ANALYSIS PROCEDURE

Table 3 - Documents Provided

3.1) Analysis Method

3.2) Assumptions

4) ANALYSIS RESULTS

Table 4 - Section Capacity (Summary)

Table 5 - Tower Component Stresses vs. Capacity - LC7

4.1) Recommendations

5) APPENDIX A

tnxTower Output

6) APPENDIX B

Base Level Drawing

7) APPENDIX C

Additional Calculations

1) INTRODUCTION

This tower is a 125 ft Monopole tower designed by Engineered Endeavors, Inc. The tower has been modified multiple times to accommodate additional loading.

2) ANALYSIS CRITERIA

TIA-222 Revision:	TIA-222-H
Risk Category:	II
Wind Speed:	119 mph
Exposure Category:	C
Topographic Factor:	1
Ice Thickness:	1 in
Wind Speed with Ice:	50 mph
Service Wind Speed:	60 mph

Table 1 - Proposed Equipment Configuration

Mounting Level (ft)	Center Line Elevation (ft)	Number of Antennas	Antenna Manufacturer	Antenna Model	Number of Feed Lines	Feed Line Size (in)
105.0	105.0	3	andrew	LNx-6514DS-A1M w/ Mount Pipe	1 11	2 1-5/8
		3	commscope	CBC78T-DS-43-2X		
		6	commscope	JAHH-45B-R3B w/ Mount Pipe		
		2	kaelus	BSF0020F3V1		
		1	raycap	RVZDC-6627-PF-48		
		3	samsung telecommunications	RFV01U-D1A		
		3	samsung telecommunications	RFV01U-D2A		
		1	site pro 1	F4P-14W		
		1	site pro 1	F4P-HRK14		
		3	vzw	Sub6 Antenna - VZS01 w/ Mount Pipe		

Table 2 - Other Considered Equipment

Mounting Level (ft)	Center Line Elevation (ft)	Number of Antennas	Antenna Manufacturer	Antenna Model	Number of Feed Lines	Feed Line Size (in)
125.0	129.0	3	argus technologies	LLPX310R-V1 w/ Mount Pipe	3 1 2 3 3 2	1-1/4 3/4 1/2 5/16 1/4 Conduit
	127.0	3	alcatel lucent	TD-RRH8X20-25		
		3	rfs celwave	APXVSPP18-C-A20 w/ Mount Pipe		
		3	rfs celwave	APXVTM14-C-120 w/ Mount Pipe		
		2	dragonwave	HORIZON COMPACT		
	125.0	3	samsung telecommunications	WIMAX DAP HEAD		
		1	tower mounts	Platform Mount [LP 714-1]		
		1	andrew	VHLP2-11		
	124.0	1	andrew	VHLP2-18		

Mounting Level (ft)	Center Line Elevation (ft)	Number of Antennas	Antenna Manufacturer	Antenna Model	Number of Feed Lines	Feed Line Size (in)
123.0	123.0	3	alcatel lucent	TME-800MHz 2X50W RRH W/FILTER	-	-
		3	alcatel lucent	TME-PCS 1900MHz 4x45W-65MHz		
		1	tower mounts	Side Arm Mount [SO 102-3]		
115.0	117.0	3	cci antennas	HPA-65R-BUU-H6 w/ Mount Pipe	12 4 2 1	1-1/4 13/16 3/8 Conduit
		3	cci antennas	OPA65R-BU6D w/ Mount Pipe		
		3	ericsson	RADIO 4449 B5/B12		
		3	ericsson	RRUS 32 B66		
		3	ericsson	RRUS 4415 B25		
		3	ericsson	RRUS-32 B30		
		3	kathrein	80010798K w/ Mount Pipe		
	2	raycap	DC6-48-60-18-8F			
	115.0	1	tower mounts	Platform Mount [LP 303-1]		
		1	site pro 1	HRK12		
94.0	97.0	3	jma wireless	MX08FRO665-21 w/ Mount Pipe	1	1-3/8
	94.0	3	fujitsu	TA08025-B604		
		3	fujitsu	TA08025-B605		
		1	raycap	RDIDC-9181-PF-48		
		1	tower mounts	Commscope MC-K6MHDX-9-96 (3)		
84.0	84.0	3	ericsson	AIR 6419 B41_TMO w/ Mount Pipe	3	1-5/8
		3	ericsson	RADIO 4449 B71 B85A_T-MOBILE		
		3	ericsson	RADIO 4460 B2/B25 B66_TMO		
		3	rfs celwave	APXVAALL24_43-U-NA20_TMO w/ Mount Pipe		
		1	tower mounts	Miscellaneous [NA 510-1]		
		1	tower mounts	T-Arm Mount [TA 602-3_KCKR]		

3) ANALYSIS PROCEDURE

Table 3 - Documents Provided

Document	Reference	Source
4-GEOTECHNICAL REPORTS	1532312	CCISITES
4-TOWER FOUNDATION DRAWINGS/DESIGN/SPECS	1613909	CCISITES
4-TOWER MANUFACTURER DRAWINGS	2068958	CCISITES
4-TOWER REINFORCEMENT DESIGN/DRAWINGS/DATA	2055765	CCISITES
4-POST-MODIFICATION INSPECTION	1956332	CCISITES
4-TOWER REINFORCEMENT DESIGN/DRAWINGS/DATA	2296089	CCISITES
4-POST-MODIFICATION INSPECTION	2182292	CCISITES
4-TOWER REINFORCEMENT DESIGN/DRAWINGS/DATA	3373019	CCISITES

Document	Reference	Source
4-POST-MODIFICATION INSPECTION	3394680	CCISITES
4-TOWER REINFORCEMENT DESIGN/DRAWINGS/DATA	3669962	CCISITES
4-POST-MODIFICATION INSPECTION	4009982	CCISITES
4-TOWER REINFORCEMENT DESIGN/DRAWINGS/DATA	5685167	CCISITES
4-POST-MODIFICATION INSPECTION	5947318	CCISITES

3.1) Analysis Method

tnxTower (version 8.1.4.0), a commercially available analysis software package, was used to create a three-dimensional model of the tower and calculate member stresses for various loading cases. Selected output from the analysis is included in Appendix A. When applicable, Crown Castle has calculated and provided the effective area for panel antennas using approved methods following the intent of the TIA-222 standard.

tnxTower was used to determine the loads on the modified structure. Additional calculations were performed to determine the stresses in the reinforcing elements. These calculations are presented in Appendix C.

3.2) Assumptions

- 1) Tower and structures were maintained in accordance with the TIA-222 Standard.
- 2) The configuration of antennas, transmission cables, mounts and other appurtenances are as specified in Tables 1 and 2 and the referenced drawings.

This analysis may be affected if any assumptions are not valid or have been made in error. Crown Castle should be notified to determine the effect on the structural integrity of the tower.

4) ANALYSIS RESULTS

Table 4 - Section Capacity (Summary)

Section No.	Elevation (ft)	Component Type	Size	Critical Element	% Capacity	Pass / Fail
L1	125 - 120	Pole	TP19.575x18.5x0.1875	Pole	10.2%	Pass
L2	120 - 115	Pole	TP20.65x19.575x0.1875	Pole	18.1%	Pass
L3	115 - 110	Pole	TP21.724x20.65x0.1875	Pole	33.4%	Pass
L4	110 - 105	Pole	TP22.799x21.724x0.1875	Pole	44.5%	Pass
L5	105 - 100	Pole	TP23.874x22.799x0.1875	Pole	62.5%	Pass
L6	100 - 99.38	Pole	TP24.008x23.874x0.1875	Pole	64.4%	Pass
L7	99.38 - 99.13	Pole + Reinf.	TP24.062x24.008x0.425	Reinf. 8 Tension Rupture	58.2%	Pass
L8	99.13 - 94.46	Pole + Reinf.	TP25.065x24.062x0.4125	Reinf. 8 Tension Rupture	71.4%	Pass
L9	94.46 - 94.21	Pole + Reinf.	TP25.119x25.065x0.6	Reinf. 8 Tension Rupture	50.5%	Pass
L10	94.21 - 89.21	Pole + Reinf.	TP26.194x25.119x0.575	Reinf. 8 Tension Rupture	61.7%	Pass
L11	89.21 - 89	Pole + Reinf.	TP26.239x26.194x0.575	Reinf. 8 Tension Rupture	62.2%	Pass
L12	89 - 88.96	Pole + Reinf.	TP27.09x26.239x0.6625	Reinf. 8 Tension Rupture	54.1%	Pass
L13	88.96 - 84.04	Pole + Reinf.	TP26.918x25.873x0.5	Reinf. 4 Tension Rupture	62.2%	Pass
L14	84.04 - 79.04	Pole + Reinf.	TP27.981x26.918x0.4875	Reinf. 4 Tension Rupture	71.9%	Pass
L15	79.04 - 74.04	Pole + Reinf.	TP29.043x27.981x0.475	Reinf. 4 Tension Rupture	80.6%	Pass
L16	74.04 - 73.5	Pole + Reinf.	TP29.158x29.043x0.475	Reinf. 4 Tension Rupture	81.5%	Pass
L17	73.5 - 73.25	Pole + Reinf.	TP29.211x29.158x0.6125	Reinf. 4 Tension Rupture	64.6%	Pass

Section No.	Elevation (ft)	Component Type	Size	Critical Element	% Capacity	Pass / Fail
L18	73.25 - 73	Pole + Reinf.	TP29.264x29.211x0.6125	Reinf. 4 Tension Rupture	64.9%	Pass
L19	73 - 72.75	Pole + Reinf.	TP29.317x29.264x0.375	Reinf. 3 Tension Rupture	79.8%	Pass
L20	72.75 - 67.75	Pole + Reinf.	TP30.38x29.317x0.375	Reinf. 3 Tension Rupture	86.9%	Pass
L21	67.75 - 63	Pole + Reinf.	TP31.389x30.38x0.3688	Reinf. 3 Tension Rupture	92.9%	Pass
L22	63 - 62.75	Pole + Reinf.	TP31.442x31.389x0.575	Reinf. 7 Tension Rupture	77.2%	Pass
L23	62.75 - 57.75	Pole + Reinf.	TP32.505x31.442x0.5625	Reinf. 7 Tension Rupture	82.7%	Pass
L24	57.75 - 57.5	Pole + Reinf.	TP32.558x32.505x0.6625	Reinf. 7 Tension Rupture	72.0%	Pass
L25	57.5 - 57.33	Pole + Reinf.	TP32.594x32.558x0.6625	Reinf. 7 Tension Rupture	72.1%	Pass
L26	57.33 - 57.08	Pole + Reinf.	TP32.647x32.594x0.45	Reinf. 2 Tension Rupture	81.4%	Pass
L27	57.08 - 52.08	Pole + Reinf.	TP33.71x32.647x0.4438	Reinf. 2 Tension Rupture	86.0%	Pass
L28	52.08 - 47.08	Pole + Reinf.	TP34.773x33.71x0.4375	Reinf. 2 Tension Rupture	90.3%	Pass
L29	47.08 - 45.54	Pole + Reinf.	TP36.18x34.773x0.4375	Reinf. 2 Tension Rupture	91.6%	Pass
L30	45.54 - 39.46	Pole + Reinf.	TP35.889x34.6x0.5	Reinf. 2 Tension Rupture	86.2%	Pass
L31	39.46 - 37.75	Pole + Reinf.	TP36.251x35.889x0.4938	Reinf. 2 Tension Rupture	87.2%	Pass
L32	37.75 - 37.5	Pole + Reinf.	TP36.304x36.251x0.4938	Reinf. 1 Tension Rupture	87.4%	Pass
L33	37.5 - 32.5	Pole + Reinf.	TP37.363x36.304x0.4875	Reinf. 1 Tension Rupture	90.3%	Pass
L34	32.5 - 27.5	Pole + Reinf.	TP38.423x37.363x0.4813	Reinf. 1 Tension Rupture	93.0%	Pass
L35	27.5 - 22.5	Pole + Reinf.	TP39.482x38.423x0.475	Reinf. 1 Tension Rupture	95.4%	Pass
L36	22.5 - 17.5	Pole + Reinf.	TP40.542x39.482x0.475	Reinf. 1 Tension Rupture	97.7%	Pass
L37	17.5 - 12.5	Pole + Reinf.	TP41.601x40.542x0.4625	Reinf. 1 Tension Rupture	99.8%	Pass
L38	12.5 - 12.25	Pole + Reinf.	TP41.654x41.601x0.4625	Reinf. 1 Tension Rupture	99.9%	Pass
L39	12.25 - 12	Pole + Reinf.	TP41.707x41.654x0.6	Reinf. 6 Tension Rupture	85.1%	Pass
L40	12 - 7	Pole + Reinf.	TP42.767x41.707x0.5875	Reinf. 6 Tension Rupture	87.2%	Pass
L41	7 - 2	Pole + Reinf.	TP43.826x42.767x0.5875	Reinf. 6 Tension Rupture	89.1%	Pass
L42	2 - 0	Pole + Reinf.	TP44.25x43.826x0.575	Reinf. 6 Tension Rupture	89.9%	Pass
					Summary	
				Pole	87.8%	Pass
				Reinforcement	99.9%	Pass
				Overall	99.9%	Pass

Table 5 - Tower Component Stresses vs. Capacity - LC7

Notes	Component	Elevation (ft)	% Capacity	Pass / Fail
1	Anchor Rods	0	90.3	Pass
1	Base Plate	0	88.2	Pass
1	Base Foundation (Structure)	0	51.8	Pass
1	Base Foundation (Soil Interaction)	0	84.3	Pass
Structure Rating (max from all components) =				99.9%

Notes:

- 1) See additional documentation in "Appendix C – Additional Calculations" for calculations supporting the % capacity consumed.

4.1) Recommendations

The tower and its foundation have sufficient capacity to carry the proposed load configuration. No modifications are required at this time.

APPENDIX A
TNXTOWER OUTPUT

Section	Length (ft)	Number of Sides	Thickness (in)	Socket Length (ft)	Top Dia (in)	Bot Dia (in)	Grade	Weight (K)
1	5.00	18	0.1875	3.92	21.7245	22.7993	0.1875	0.2
2	5.00	18	0.1875		20.6497	21.7245	0.1875	0.2
3	5.00	18	0.1875		20.6497	21.7245	0.1875	0.2
4	5.00	18	0.1875		21.7245	22.7993	0.1875	0.2
5	5.00	18	0.1875		21.7245	22.7993	0.1875	0.2
6	5.00	18	0.1875		21.7245	22.7993	0.1875	0.2
7	5.00	18	0.1875		21.7245	22.7993	0.1875	0.2
8	5.00	18	0.1875		21.7245	22.7993	0.1875	0.2
9	5.00	18	0.1875		21.7245	22.7993	0.1875	0.2
10	5.00	18	0.1875		21.7245	22.7993	0.1875	0.2
11	5.00	18	0.1875	5.08	27.9805	27.9805	0.1875	0.5
12	5.00	18	0.1875		26.9125	27.9805	0.1875	0.5
13	5.00	18	0.1875		26.9125	27.9805	0.1875	0.5
14	5.00	18	0.1875		26.9125	27.9805	0.1875	0.5
15	5.00	18	0.1875		26.9125	27.9805	0.1875	0.5
16	5.00	18	0.1875		26.9125	27.9805	0.1875	0.5
17	5.00	18	0.1875		26.9125	27.9805	0.1875	0.5
18	5.00	18	0.1875		26.9125	27.9805	0.1875	0.5
19	5.00	18	0.1875		26.9125	27.9805	0.1875	0.5
20	5.00	18	0.1875		26.9125	27.9805	0.1875	0.5
21	5.00	18	0.1875	5.08	30.3725	30.3725	0.1875	0.6
22	5.00	18	0.1875		29.3045	30.3725	0.1875	0.6
23	5.00	18	0.1875		29.3045	30.3725	0.1875	0.6
24	5.00	18	0.1875		29.3045	30.3725	0.1875	0.6
25	5.00	18	0.1875		29.3045	30.3725	0.1875	0.6
26	5.00	18	0.1875		29.3045	30.3725	0.1875	0.6
27	5.00	18	0.1875		29.3045	30.3725	0.1875	0.6
28	5.00	18	0.1875		29.3045	30.3725	0.1875	0.6
29	5.00	18	0.1875		29.3045	30.3725	0.1875	0.6
30	5.00	18	0.1875		29.3045	30.3725	0.1875	0.6
31	5.00	18	0.1875	5.08	33.7069	33.7069	0.1875	0.7
32	5.00	18	0.1875		32.6389	33.7069	0.1875	0.7
33	5.00	18	0.1875		32.6389	33.7069	0.1875	0.7
34	5.00	18	0.1875		32.6389	33.7069	0.1875	0.7
35	5.00	18	0.1875		32.6389	33.7069	0.1875	0.7
36	5.00	18	0.1875		32.6389	33.7069	0.1875	0.7
37	5.00	18	0.1875		32.6389	33.7069	0.1875	0.7
38	5.00	18	0.1875		32.6389	33.7069	0.1875	0.7
39	5.00	18	0.1875		32.6389	33.7069	0.1875	0.7
40	5.00	18	0.1875		32.6389	33.7069	0.1875	0.7
41	5.00	18	0.1875	5.08	37.0413	37.0413	0.1875	0.8
42	5.00	18	0.1875		36.0733	37.0413	0.1875	0.8

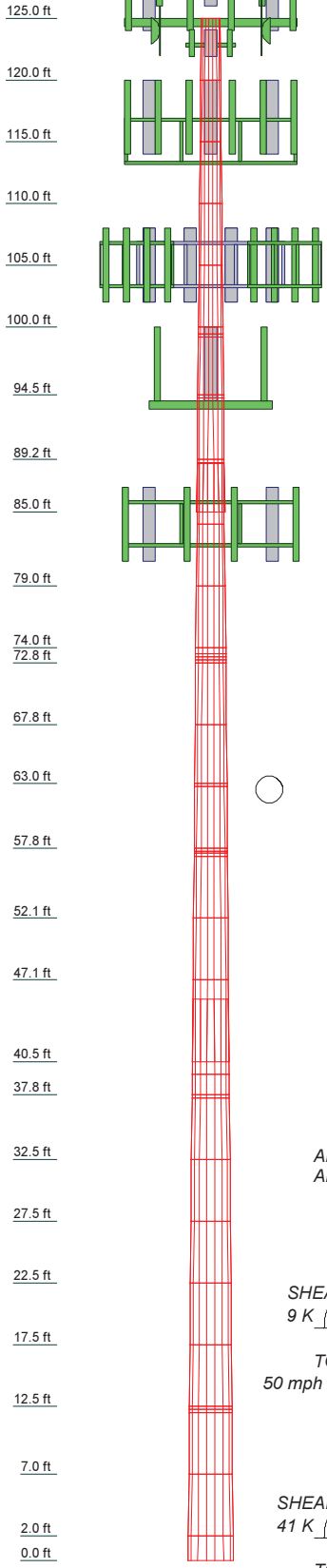

MATERIAL STRENGTH					
GRADE	Fy	Fu	GRADE	Fy	Fu
A572-65	65 ksi	80 ksi			

TOWER DESIGN NOTES

1. Tower is located in Middlesex County, Connecticut.
2. Tower designed for Exposure C to the TIA-222-H Standard.
3. Tower designed for a 119 mph basic wind in accordance with the TIA-222-H Standard.
4. Tower is also designed for a 50 mph basic wind with 1.00 in ice. Ice is considered to increase in thickness with height.
5. Deflections are based upon a 60 mph wind.
6. Tower Risk Category II.
7. Topographic Category 1 with Crest Height of 0.00 ft
8. TOWER RATING: 99.9%

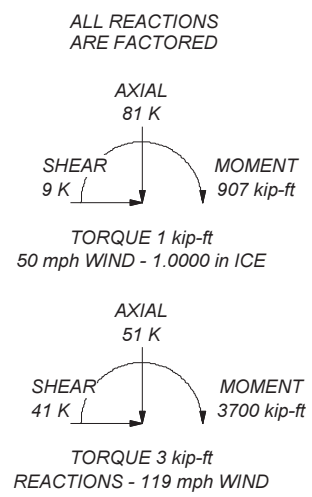

Crown Castle
 2000 Corporate Drive
 Canonsburg, PA 15317
 Phone: (724) 416-2000
 FAX:

Job: BU 876364			
Project:			
Client: Crown Castle	Drawn by: Matthew Schmitt	App'd:	
Code: TIA-222-H	Date: 10/25/23	Scale: NTS	
Path:		Dwg No. E-1	

C:\Users\mschmitt\SAI Work Area\876364\WQ 2265165 - SAI\Prof\876364_R.en

Tower Input Data

The tower is a monopole.
 This tower is designed using the TIA-222-H standard.
 The following design criteria apply:

- Tower is located in Middlesex County, Connecticut.
- Tower base elevation above sea level: 14.00 ft.
- Basic wind speed of 119 mph.
- Risk Category II.
- Exposure Category C.
- Simplified Topographic Factor Procedure for wind speed-up calculations is used.
- Topographic Category: 1.
- Crest Height: 0.00 ft.
- Nominal ice thickness of 1.0000 in.
- Ice thickness is considered to increase with height.
- Ice density of 56 pcf.
- A wind speed of 50 mph is used in combination with ice.
- Temperature drop of 50 °F.
- Deflections calculated using a wind speed of 60 mph.
- TOWER RATING: 99.9%.
- A non-linear (P-delta) analysis was used.
- Pressures are calculated at each section.
- Stress ratio used in pole design is 1.
- Tower analysis based on target reliabilities in accordance with Annex S.
- Load Modification Factors used: $K_{es}(F_w) = 0.95$, $K_{es}(t_i) = 0.85$.
- Maximum demand-capacity ratio is: 1.05.
- Local bending stresses due to climbing loads, feed line supports, and appurtenance mounts are not considered.

Options

Consider Moments - Legs Consider Moments - Horizontals Consider Moments - Diagonals Use Moment Magnification ✓ Use Code Stress Ratios ✓ Use Code Safety Factors - Guys Escalate Ice Always Use Max Kz Use Special Wind Profile Include Bolts In Member Capacity Leg Bolts Are At Top Of Section Secondary Horizontal Braces Leg Use Diamond Inner Bracing (4 Sided) SR Members Have Cut Ends SR Members Are Concentric	Distribute Leg Loads As Uniform Assume Legs Pinned ✓ Assume Rigid Index Plate ✓ Use Clear Spans For Wind Area Use Clear Spans For KL/r Retension Guys To Initial Tension ✓ Bypass Mast Stability Checks ✓ Use Azimuth Dish Coefficients ✓ Project Wind Area of Appurt. Autocalc Torque Arm Areas Add IBC .6D+W Combination Sort Capacity Reports By Component Triangulate Diamond Inner Bracing Treat Feed Line Bundles As Cylinder Ignore KL/ry For 60 Deg. Angle Legs	Use ASCE 10 X-Brace Ly Rules Calculate Forces in Supporting Bracing Members Ignore Redundant Members in FEA SR Leg Bolts Resist Compression All Leg Panels Have Same Allowable Offset Girt At Foundation ✓ Consider Feed Line Torque Include Angle Block Shear Check Use TIA-222-H Bracing Resist. Exemption Use TIA-222-H Tension Splice Exemption <div style="background-color: #e0e0e0; text-align: center; padding: 2px;">Poles</div> ✓ Include Shear-Torsion Interaction Always Use Sub-Critical Flow Use Top Mounted Sockets Pole Without Linear Attachments Pole With Shroud Or No Appurtenances Outside and Inside Corner Radii Are Known
--	---	--

Tapered Pole Section Geometry

Section	Elevation ft	Section Length ft	Splice Length ft	Number of Sides	Top Diameter in	Bottom Diameter in	Wall Thickness in	Bend Radius in	Pole Grade
L1	125.00-120.00	5.00	0.00	18	18.5000	19.5748	0.1875	0.7500	A572-65

Section	Elevation ft	Section Length ft	Splice Length ft	Number of Sides	Top Diameter in	Bottom Diameter in	Wall Thickness in	Bend Radius in	Pole Grade
L2	120.00-115.00	5.00	0.00	18	19.5748	20.6497	0.1875	0.7500	(65 ksi) A572-65
L3	115.00-110.00	5.00	0.00	18	20.6497	21.7245	0.1875	0.7500	(65 ksi) A572-65
L4	110.00-105.00	5.00	0.00	18	21.7245	22.7993	0.1875	0.7500	(65 ksi) A572-65
L5	105.00-100.00	5.00	0.00	18	22.7993	23.8741	0.1875	0.7500	(65 ksi) A572-65
L6	100.00-99.38	0.63	0.00	18	23.8741	24.0085	0.1875	0.7500	(65 ksi) A572-65
L7	99.38-99.13	0.25	0.00	18	24.0085	24.0622	0.4250	1.7000	(65 ksi) A572-65
L8	99.13-94.46	4.67	0.00	18	24.0622	25.0650	0.4125	1.6500	(65 ksi) A572-65
L9	94.46-94.21	0.25	0.00	18	25.0650	25.1188	0.6000	2.4000	(65 ksi) A572-65
L10	94.21-89.21	5.00	0.00	18	25.1188	26.1936	0.5750	2.3000	(65 ksi) A572-65
L11	89.21-89.00	0.21	0.00	18	26.1936	26.2387	0.5750	2.3000	(65 ksi) A572-65
L12	89.00-85.04	3.96	3.92	18	26.2387	27.0900	0.6625	2.6500	(65 ksi) A572-65
L13	85.04-84.04	4.92	0.00	18	25.8730	26.9179	0.5000	2.0000	(65 ksi) A572-65
L14	84.04-79.04	5.00	0.00	18	26.9179	27.9805	0.4875	1.9500	(65 ksi) A572-65
L15	79.04-74.04	5.00	0.00	18	27.9805	29.0431	0.4750	1.9000	(65 ksi) A572-65
L16	74.04-73.50	0.54	0.00	18	29.0431	29.1578	0.4750	1.9000	(65 ksi) A572-65
L17	73.50-73.25	0.25	0.00	18	29.1578	29.2110	0.6125	2.4500	(65 ksi) A572-65
L18	73.25-73.00	0.25	0.00	18	29.2110	29.2641	0.6125	2.4500	(65 ksi) A572-65
L19	73.00-72.75	0.25	0.00	18	29.2641	29.3172	0.3750	1.5000	(65 ksi) A572-65
L20	72.75-67.75	5.00	0.00	18	29.3172	30.3798	0.3750	1.5000	(65 ksi) A572-65
L21	67.75-63.00	4.75	0.00	18	30.3798	31.3893	0.3688	1.4750	(65 ksi) A572-65
L22	63.00-62.75	0.25	0.00	18	31.3893	31.4424	0.5750	2.3000	(65 ksi) A572-65
L23	62.75-57.75	5.00	0.00	18	31.4424	32.5050	0.5625	2.2500	(65 ksi) A572-65
L24	57.75-57.50	0.25	0.00	18	32.5050	32.5581	0.6625	2.6500	(65 ksi) A572-65
L25	57.50-57.33	0.17	0.00	18	32.5581	32.5942	0.6625	2.6500	(65 ksi) A572-65
L26	57.33-57.08	0.25	0.00	18	32.5942	32.6473	0.4500	1.8000	(65 ksi) A572-65
L27	57.08-52.08	5.00	0.00	18	32.6473	33.7099	0.4437	1.7750	(65 ksi) A572-65
L28	52.08-47.08	5.00	0.00	18	33.7099	34.7725	0.4375	1.7500	(65 ksi) A572-65
L29	47.08-40.46	6.62	5.08	18	34.7725	36.1800	0.4375	1.7500	(65 ksi) A572-65
L30	40.46-39.46	6.08	0.00	18	34.5998	35.8888	0.5000	2.0000	(65 ksi) A572-65
L31	39.46-37.75	1.71	0.00	18	35.8888	36.2505	0.4938	1.9750	(65 ksi) A572-65
L32	37.75-37.50	0.25	0.00	18	36.2505	36.3035	0.4938	1.9750	(65 ksi) A572-65
L33	37.50-32.50	5.00	0.00	18	36.3035	37.3630	0.4875	1.9500	(65 ksi) A572-65
L34	32.50-27.50	5.00	0.00	18	37.3630	38.4226	0.4813	1.9250	(65 ksi) A572-65
L35	27.50-22.50	5.00	0.00	18	38.4226	39.4821	0.4750	1.9000	(65 ksi) A572-65

Section	Elevation ft	Section Length ft	Splice Length ft	Number of Sides	Top Diameter in	Bottom Diameter in	Wall Thickness in	Bend Radius in	Pole Grade
L36	22.50-17.50	5.00	0.00	18	39.4821	40.5416	0.4750	1.9000	A572-65 (65 ksi)
L37	17.50-12.50	5.00	0.00	18	40.5416	41.6012	0.4625	1.8500	A572-65 (65 ksi)
L38	12.50-12.25	0.25	0.00	18	41.6012	41.6541	0.4625	1.8500	A572-65 (65 ksi)
L39	12.25-12.00	0.25	0.00	18	41.6541	41.7071	0.6000	2.4000	A572-65 (65 ksi)
L40	12.00-7.00	5.00	0.00	18	41.7071	42.7667	0.5875	2.3500	A572-65 (65 ksi)
L41	7.00-2.00	5.00	0.00	18	42.7667	43.8262	0.5875	2.3500	A572-65 (65 ksi)
L42	2.00-0.00	2.00		18	43.8262	44.2500	0.5750	2.3000	A572-65 (65 ksi)

Tapered Pole Properties

Section	Tip Dia. in	Area in ²	I in ⁴	r in	C in	I/C in ³	J in ⁴	It/Q in ²	w in	w/t
L1	18.7565	10.8982	461.7305	6.5009	9.3980	49.1307	924.0685	5.4501	2.9260	15.605
	19.8479	11.5379	547.8975	6.8825	9.9440	55.0982	1096.5159	5.7700	3.1152	16.614
L2	19.8479	11.5379	547.8975	6.8825	9.9440	55.0982	1096.5159	5.7700	3.1152	16.614
	20.9393	12.1775	644.1684	7.2641	10.4900	61.4077	1289.1845	6.0899	3.3043	17.623
L3	20.9393	12.1775	644.1684	7.2641	10.4900	61.4077	1289.1845	6.0899	3.3043	17.623
	22.0307	12.8172	751.1033	7.6456	11.0360	68.0592	1503.1950	6.4098	3.4935	18.632
L4	22.0307	12.8172	751.1033	7.6456	11.0360	68.0592	1503.1950	6.4098	3.4935	18.632
	23.1221	13.4568	869.2626	8.0272	11.5820	75.0526	1739.6690	6.7297	3.6827	19.641
L5	23.1221	13.4568	869.2626	8.0272	11.5820	75.0526	1739.6690	6.7297	3.6827	19.641
	24.2135	14.0965	999.2063	8.4088	12.1281	82.3880	1999.7273	7.0496	3.8718	20.65
L6	24.2135	14.0965	999.2063	8.4088	12.1281	82.3880	1999.7273	7.0496	3.8718	20.65
	24.3499	14.1765	1016.3057	8.4564	12.1963	83.3290	2033.9486	7.0896	3.8955	20.776
L7	24.3133	31.8129	2235.4080	8.3721	12.1963	183.2857	4473.7575	15.9095	3.4775	8.182
	24.3679	31.8854	2250.7247	8.3912	12.2236	184.1293	4504.4110	15.9457	3.4870	8.205
L8	24.3698	30.9640	2187.9945	8.3956	12.2236	178.9975	4378.8680	15.4849	3.5090	8.507
	25.3881	32.2769	2478.2939	8.7516	12.7330	194.6350	4959.8489	16.1415	3.6854	8.934
L9	25.3591	46.5912	3523.1642	8.6851	12.7330	276.6948	7050.9642	23.3000	3.3554	5.592
	25.4137	46.6935	3546.4326	8.7042	12.7603	277.9263	7097.5318	23.3512	3.3649	5.608
L10	25.4176	44.7936	3409.0713	8.7130	12.7603	267.1616	6822.6284	22.4011	3.4089	5.929
	26.5090	46.7552	3876.8428	9.0946	13.3063	291.3529	7758.7869	23.3821	3.5981	6.258
L11	26.5090	46.7552	3876.8428	9.0946	13.3063	291.3529	7758.7869	23.3821	3.5981	6.258
	26.5548	46.8376	3897.3733	9.1106	13.3293	292.3919	7799.8749	23.4233	3.6060	6.271
L12	26.5413	53.7811	4444.6780	9.0796	13.3293	333.4522	8895.2044	26.8956	3.4520	5.211
	27.4057	55.5711	4903.4133	9.3818	13.7617	356.3082	9813.2786	27.7908	3.6018	5.437
L13	27.0402	40.2669	3275.1328	9.0074	13.1435	249.1832	6554.5751	20.1373	3.6736	7.347
	27.2560	41.9252	3696.6675	9.3784	13.6743	270.3368	7398.1991	20.9666	3.8576	7.715
L14	27.2580	40.8965	3609.3694	9.3828	13.6743	263.9527	7223.4881	20.4521	3.8796	7.958
	28.3369	42.5406	4062.4262	9.7600	14.2141	285.8027	8130.1978	21.2743	4.0666	8.342
L15	28.3389	41.4687	3963.6629	9.7645	14.2141	278.8544	7932.5412	20.7383	4.0886	8.608
	29.4178	43.0707	4441.0042	10.1417	14.7539	301.0057	8887.8521	21.5394	4.2756	9.001
L16	29.4178	43.0707	4441.0042	10.1417	14.7539	301.0057	8887.8521	21.5394	4.2756	9.001
	29.5344	43.2437	4494.7381	10.1824	14.8122	303.4487	8995.3904	21.6260	4.2958	9.044
L17	29.5132	55.4943	5712.8929	10.1336	14.8122	385.6888	11433.302	27.7524	4.0538	6.618
	29.5671	55.5976	5744.8510	10.1525	14.8392	387.1409	11497.261	27.8041	4.0631	6.634
L18	29.5671	55.5976	5744.8510	10.1525	14.8392	387.1409	11497.261	27.8041	4.0631	6.634
	29.6211	55.7009	5776.9282	10.1713	14.8662	388.5958	11561.457	27.8557	4.0725	6.649
L19	29.6577	34.3852	3625.5804	10.2556	14.8662	243.8814	7255.9315	17.1959	4.4905	11.975
	29.7116	34.4485	3645.6203	10.2745	14.8932	244.7850	7296.0376	17.2275	4.4998	12
L20	29.7116	34.4485	3645.6203	10.2745	14.8932	244.7850	7296.0376	17.2275	4.4998	12
	30.7906	35.7132	4062.0762	10.6517	15.4329	263.2082	8129.4974	17.8600	4.6868	12.498
L21	30.7916	35.1253	3996.8715	10.6539	15.4329	258.9831	7999.0023	17.5660	4.6978	12.74
	31.8166	36.3068	4413.9055	11.0123	15.9457	276.8078	8833.6190	18.1568	4.8755	13.222

Section	Tip Dia. in	Area in ²	I in ⁴	r in	C in	I/C in ³	J in ⁴	It/Q in ²	w in	w/t
L22	31.7848	56.2376	6746.3253	10.9391	15.9457	423.0800	13501.5275	28.1241	4.5125	7.848
	31.8387	56.3345	6781.2809	10.9579	15.9727	424.5536	13571.4848	28.1726	4.5219	7.864
L23	31.8407	55.1322	6641.9243	10.9624	15.9727	415.8290	13292.5882	27.5713	4.5439	8.078
	32.9196	57.0293	7351.4353	11.3396	16.5125	445.2037	14712.5439	28.5201	4.7309	8.41
L24	32.9042	66.9575	8577.2932	11.3041	16.5125	519.4418	17165.8726	33.4851	4.5549	6.875
	32.9582	67.0693	8620.2984	11.3229	16.5395	521.1943	17251.9395	33.5410	4.5642	6.889
L25	32.9582	67.0693	8620.2984	11.3229	16.5395	521.1943	17251.9395	33.5410	4.5642	6.889
	32.9948	67.1452	8649.6233	11.3358	16.5579	522.3876	17310.6279	33.5790	4.5706	6.899
L26	33.0276	45.9116	5993.2937	11.4112	16.5579	361.9606	11994.4736	22.9602	4.9446	10.988
	33.0816	45.9875	6023.0606	11.4301	16.5849	363.1663	12054.0465	22.9981	4.9539	11.009
L27	33.0825	45.3576	5942.8664	11.4323	16.5849	358.3310	11893.5526	22.6831	4.9649	11.189
	34.1615	46.8542	6550.7565	11.8095	17.1246	382.5339	13110.1328	23.4315	5.1519	11.61
L28	34.1625	46.2029	6462.1333	11.8117	17.1246	377.3587	12932.7696	23.1059	5.1629	11.801
	35.2414	47.6785	7101.2351	12.1889	17.6644	402.0075	14211.8141	23.8438	5.3500	12.228
L29	35.2414	47.6785	7101.2351	12.1889	17.6644	402.0075	14211.8141	23.8438	5.3500	12.228
	36.6706	49.6329	8010.8243	12.6886	18.3794	435.8579	16032.1895	24.8212	5.5977	12.795
L30	36.1501	54.1164	7950.0376	12.1054	17.5767	452.3058	15910.5361	27.0633	5.2096	10.419
	36.3653	56.1620	8886.1209	12.5630	18.2315	487.4044	17783.9344	28.0864	5.4364	10.873
L31	36.3663	55.4698	8779.6945	12.5652	18.2315	481.5669	17570.9415	27.7402	5.4474	11.033
	36.7336	56.0367	9051.6301	12.6937	18.4153	491.5285	18115.1706	28.0237	5.5111	11.162
L32	36.7336	56.0367	9051.6301	12.6937	18.4153	491.5285	18115.1706	28.0237	5.5111	11.162
	36.7874	56.1197	9091.9222	12.7125	18.4422	492.9960	18195.8078	28.0652	5.5204	11.181
L33	36.7883	55.4190	8981.5357	12.7147	18.4422	487.0104	17974.8895	27.7148	5.5314	11.346
	37.8642	57.0584	9802.4408	13.0908	18.9804	516.4500	19617.7800	28.5346	5.7179	11.729
L34	37.8652	56.3365	9681.6897	13.0930	18.9804	510.0881	19376.1188	28.1736	5.7289	11.904
	38.9411	57.9549	10540.2900	13.4692	19.5187	540.0107	21094.4492	28.9830	5.9154	12.292
L35	38.9420	57.2117	10408.5452	13.4714	19.5187	533.2611	20830.7862	28.6113	5.9264	12.477
	40.0179	58.8091	11304.9637	13.8475	20.0569	563.6443	22624.8028	29.4101	6.1129	12.869
L36	40.0179	58.8091	11304.9637	13.8475	20.0569	563.6443	22624.8028	29.4101	6.1129	12.869
	41.0938	60.4065	12251.4273	14.2237	20.5952	594.8695	24518.9754	30.2090	6.2993	13.262
L37	41.0957	58.8352	11940.1897	14.2281	20.5952	579.7573	23896.0906	29.4232	6.3213	13.668
	42.1716	60.3905	12912.3964	14.6042	21.1334	610.9949	25841.7833	30.2010	6.5078	14.071
L38	42.1716	60.3905	12912.3964	14.6042	21.1334	610.9949	25841.7833	30.2010	6.5078	14.071
	42.2254	60.4683	12962.3442	14.6230	21.1603	612.5783	25941.7446	30.2399	6.5171	14.091
L39	42.2042	78.1835	16648.1772	14.5742	21.1603	786.7645	33318.2605	39.0992	6.2751	10.459

Section	Tip Dia. in	Area in ²	I in ⁴	r in	C in	I/C in ³	J in ⁴	It/Q in ²	w in	w/t
	42.2580	78.2844	16712.709 7	14.5930	21.1872	788.8109	33447.410 5	39.1496	6.2845	10.474
L40	42.2599	76.6768	16379.461 4	14.5975	21.1872	773.0822	32780.475 3	38.3457	6.3065	10.734
	43.3358	78.6525	17678.518 6	14.9736	21.7255	813.7235	35380.299 0	39.3337	6.4929	11.052
L41	43.3358	78.6525	17678.518 6	14.9736	21.7255	813.7235	35380.299 0	39.3337	6.4929	11.052
	44.4116	80.6283	19044.507 1	15.3497	22.2637	855.4061	38114.073 4	40.3218	6.6794	11.369
L42	44.4136	78.9356	18655.474 9	15.3542	22.2637	837.9323	37335.497 2	39.4753	6.7014	11.655
	44.8439	79.7091	19209.274 3	15.5046	22.4790	854.5431	38443.824 7	39.8621	6.7760	11.784

Tower Elevation	Gusset Area (per face)	Gusset Thickness	Gusset Grade	Adjust. Factor A _r	Adjust. Factor A _r	Weight Mult.	Double Angle Stitch Bolt Spacing Diagonals	Double Angle Stitch Bolt Spacing Horizontals	Double Angle Stitch Bolt Spacing Redundants
ft	ft ²	in					in	in	in
L1 125.00-120.00				1	1	1			
L2 120.00-115.00				1	1	1			
L3 115.00-110.00				1	1	1			
L4 110.00-105.00				1	1	1			
L5 105.00-100.00				1	1	1			
L6 100.00-99.38				1	1	1			
L7 99.38-99.13				1	1	0.955265			
L8 99.13-94.46				1	1	0.962168			
L9 94.46-94.21				1	1	0.922788			
L10 94.21-89.21				1	1	0.935252			
L11 89.21-89.00				1	1	0.93418			
L12 89.00-85.04				1	1	0.924907			
L13 85.04-84.04				1	1	0.934083			
L14 84.04-79.04				1	1	0.940391			
L15 79.04-74.04				1	1	0.948394			
L16 74.04-73.50				1	1	0.946705			
L17 73.50-73.25				1	1	0.92934			
L18 73.25-73.00				1	1	0.928374			
L19 73.00-72.75				1	1	0.979803			
L20 72.75-67.75				1	1	0.968714			
L21 67.75-63.00				1	1	0.974938			
L22 63.00-62.75				1	1	0.948614			
L23 62.75-57.75				1	1	0.951842			
L24 57.75-57.50				1	1	0.92321			
L25 57.50-				1	1	0.922593			

Tower Elevation	Gusset Area (per face)	Gusset Thickness	Gusset Grade	Adjust. Factor A_r	Adjust. Factor A_r	Weight Mult.	Double Angle Stitch Bolt Spacing Diagonals in	Double Angle Stitch Bolt Spacing Horizontals in	Double Angle Stitch Bolt Spacing Redundants in
ft	ft ²	in							
57.33									
L26 57.33-57.08				1	1	0.956548			
L27 57.08-52.08				1	1	0.956849			
L28 52.08-47.08				1	1	0.957991			
L29 47.08-40.46				1	1	0.954341			
L30 40.46-39.46				1	1	0.953832			
L31 39.46-37.75				1	1	0.962369			
L32 37.75-37.50				1	1	0.961881			
L33 37.50-32.50				1	1	0.964474			
L34 32.50-27.50				1	1	0.967689			
L35 27.50-22.50				1	1	0.971504			
L36 22.50-17.50				1	1	0.963211			
L37 17.50-12.50				1	1	0.980867			
L38 12.50-12.25				1	1	0.980475			
L39 12.25-12.00				1	1	1.06938			
L40 12.00-7.00				1	1	1.07774			
L41 7.00-2.00				1	1	1.06437			
L42 2.00-0.00				1	1	1.08191			

Feed Line/Linear Appurtenances - Entered As Round Or Flat

Description	Sector	Exclude From Torque Calculation	Component Type	Placement ft	Total Number	Number Per Row	Start/End Position	Width or Diameter in	Perimeter in	Weight plf
Safety Line 3/8"	B	No	Surface Ar (CaAa)	125.00 - 10.00	1	1	-0.450 -0.450	0.3750		0.22
Climbing Pegs	B	No	Surface Ar (CaAa)	125.00 - 10.00	1	1	-0.500 -0.400	0.7050		1.80
CONDUIT (2)	B	No	Surface Ar (CaAa)	125.00 - 8.00	2	2	0.000 0.100	2.0000		2.80

LDF6-50A(1-1/4)	C	No	Surface Ar (CaAa)	115.00 - 8.00	7	7	-0.360 0.000	1.5500		0.60
CONDUIT (2)	C	No	Surface Ar (CaAa)	115.00 - 8.00	1	1	-0.480 -0.480	2.0000		2.80

PWRT-608-S(13/16)	C	No	Surface Ar (CaAa)	115.00 - 8.00	4	4	-0.480 -0.380	0.8200		0.62
FB-L98B-034-XXX(3/8)	C	No	Surface Ar (CaAa)	115.00 - 8.00	1	1	-0.380 -0.380	0.3937		0.06

LDF7-50A(1-5/8)	C	No	Surface Ar (CaAa)	105.00 - 3.00	11	6	0.100 0.500	1.9800		0.82

MLCH 12/24 LOW INDUCTION(2)	C	No	Surface Ar (CaAa)	105.00 - 3.00	1	1	0.500 0.500	2.0160		3.04

Description	Sector	Exclude From Torque Calculation	Component Type	Placement ft	Total Number	Number Per Row	Start/End Position	Width or Diameter in	Perimeter in	Weight plf
CU12PSM9P8XXX(1-3/8) *****	C	No	Surface Ar (CaAa)	94.00 - 0.00	1	1	0.100 0.100	1.4110		1.66
MP406 [4.875" x 1.25"]	A	No	Surface Af (CaAa)	40.50 - 0.50	1	1	0.000 0.000	4.8750	12.2500	0.00
MP406 [4.875" x 1.25"]	B	No	Surface Af (CaAa)	40.50 - 0.50	1	1	0.000 0.000	4.8750	12.2500	0.00
MP406 [4.875" x 1.25"]	C	No	Surface Af (CaAa)	40.50 - 0.50	1	1	0.000 0.000	4.8750	12.2500	0.00

MP406 [4.875" x 1.25"]	A	No	Surface Af (CaAa)	60.50 - 35.50	1	1	0.100 0.100	4.8750	12.2500	0.00
MP406 [4.875" x 1.25"]	B	No	Surface Af (CaAa)	60.50 - 35.50	1	1	0.100 0.100	4.8750	12.2500	0.00
MP406 [4.875" x 1.25"]	C	No	Surface Af (CaAa)	60.50 - 35.50	1	1	0.100 0.100	4.8750	12.2500	0.00

MP404 [4.75" x 0.75"]	A	No	Surface Af (CaAa)	75.50 - 55.50	1	1	0.000 0.000	4.7500	11.0000	0.00
MP404 [4.75" x 0.75"]	B	No	Surface Af (CaAa)	75.50 - 55.50	1	1	0.000 0.000	4.7500	11.0000	0.00
MP404 [4.75" x 0.75"]	C	No	Surface Af (CaAa)	75.50 - 55.50	1	1	0.000 0.000	4.7500	11.0000	0.00

MS600 [6" x 1"]	A	No	Surface Af (CaAa)	96.46 - 71.00	1	1	0.250 0.250	6.0000	14.0000	0.00
MS600 [6" x 1"]	B	No	Surface Af (CaAa)	96.46 - 71.00	1	1	0.250 0.250	6.0000	14.0000	0.00
MS600 [6" x 1"]	C	No	Surface Af (CaAa)	96.46 - 71.00	1	1	0.250 0.250	6.0000	14.0000	0.00

CCI-WSFP-065125	A	No	Surface Af (CaAa)	15.00 - 0.00	1	1	0.000 0.000	6.5000	15.5000	0.00
CCI-WSFP-065125	B	No	Surface Af (CaAa)	15.00 - 0.00	1	1	0.000 0.000	6.5000	15.5000	0.00
CCI-WSFP-065125	C	No	Surface Af (CaAa)	15.00 - 0.00	1	1	0.000 0.000	6.5000	15.5000	0.00

CCI-SFP-060100	A	No	Surface Af (CaAa)	65.00 - 55.00	1	1	0.000 0.000	6.0000	14.0000	0.00
CCI-SFP-060100	B	No	Surface Af (CaAa)	65.00 - 55.00	1	1	0.000 0.000	6.0000	14.0000	0.00
CCI-SFP-060100	C	No	Surface Af (CaAa)	65.00 - 55.00	1	1	0.000 0.000	6.0000	14.0000	0.00

CCI-CFP-0325125	A	No	Surface Af (CaAa)	100.63 - 85.63	1	1	0.000 0.000	3.2500	9.0000	0.00
CCI-CFP-0325125	B	No	Surface Af (CaAa)	100.63 - 85.63	1	1	0.250 0.250	3.2500	9.0000	0.00
CCI-CFP-0325125	B	No	Surface Af (CaAa)	100.63 - 85.63	1	1	0.000 0.000	3.2500	9.0000	0.00
CCI-CFP-0325125	C	No	Surface Af (CaAa)	100.63 - 85.63	1	1	0.000 0.000	3.2500	9.0000	0.00

Feed Line/Linear Appurtenances - Entered As Area

Description	Face or Leg	Allow Shield	Exclude From Torque Calculation	Component Type	Placement ft	Total Number		C _{AA} ft ² /ft	Weight plf

ATCB-B01-005(5/16)	B	No	No	Inside Pole	125.00 - 8.00	3	No Ice 1/2" Ice 1" Ice	0.00 0.00 0.00	0.07 0.07 0.07

Description	Face or Leg	Allow Shield	Exclude From Torque Calculation	Component Type	Placement ft	Total Number		C _{AA} ft ² /ft	Weight plf
FSJ4-50B(1/2)	B	No	No	Inside Pole	125.00 - 8.00	2	No Ice	0.00	0.14
							1/2" Ice	0.00	0.14
							1" Ice	0.00	0.14
LDF1-50A(1/4)	B	No	No	Inside Pole	125.00 - 8.00	3	No Ice	0.00	0.06
							1/2" Ice	0.00	0.06
							1" Ice	0.00	0.06
HB114-1-08U4-M5J(1-1/4)	C	No	No	Inside Pole	125.00 - 8.00	2	No Ice	0.00	1.08
							1/2" Ice	0.00	1.08
							1" Ice	0.00	1.08
HB114-21U3M12-XXXF(1-1/4)	C	No	No	Inside Pole	125.00 - 8.00	1	No Ice	0.00	1.22
							1/2" Ice	0.00	1.22
							1" Ice	0.00	1.22
RLSS 8AWG DC(3/4)	C	No	No	Inside Pole	125.00 - 8.00	1	No Ice	0.00	0.49
							1/2" Ice	0.00	0.49
							1" Ice	0.00	0.49
FB-L98B-002-75000(3/8)	C	No	No	Inside Pole	115.00 - 8.00	1	No Ice	0.00	0.06
							1/2" Ice	0.00	0.06
							1" Ice	0.00	0.06
LDF6-50A(1-1/4)	C	No	No	Inside Pole	115.00 - 8.00	5	No Ice	0.00	0.60
							1/2" Ice	0.00	0.60
							1" Ice	0.00	0.60

HCS 6X12 4AWG(1-5/8)	B	No	No	Inside Pole	84.00 - 0.00	1	No Ice	0.00	2.40
							1/2" Ice	0.00	2.40
							1" Ice	0.00	2.40
HB158-21U6S24-xxM_TMO(1-5/8)	B	No	No	Inside Pole	84.00 - 0.00	2	No Ice	0.00	2.50
							1/2" Ice	0.00	2.50
							1" Ice	0.00	2.50

Feed Line/Linear Appurtenances Section Areas

Tower Section	Tower Elevation ft	Face	A _R ft ²	A _F ft ²	C _{AA} In Face ft ²	C _{AA} Out Face ft ²	Weight K
L1	125.00-120.00	A	0.000	0.000	0.000	0.000	0.00
		B	0.000	0.000	2.540	0.000	0.04
		C	0.000	0.000	0.000	0.000	0.02
L2	120.00-115.00	A	0.000	0.000	0.000	0.000	0.00
		B	0.000	0.000	2.540	0.000	0.04
		C	0.000	0.000	0.000	0.000	0.02
L3	115.00-110.00	A	0.000	0.000	0.000	0.000	0.00
		B	0.000	0.000	2.540	0.000	0.04
		C	0.000	0.000	8.262	0.000	0.08
L4	110.00-105.00	A	0.000	0.000	0.000	0.000	0.00
		B	0.000	0.000	2.540	0.000	0.04
		C	0.000	0.000	8.262	0.000	0.08
L5	105.00-100.00	A	0.000	0.000	0.339	0.000	0.00
		B	0.000	0.000	3.217	0.000	0.04
		C	0.000	0.000	15.548	0.000	0.14
L6	100.00-99.38	A	0.000	0.000	0.339	0.000	0.00
		B	0.000	0.000	0.995	0.000	0.01
		C	0.000	0.000	2.240	0.000	0.02
L7	99.38-99.13	A	0.000	0.000	0.135	0.000	0.00
		B	0.000	0.000	0.398	0.000	0.00
		C	0.000	0.000	0.896	0.000	0.01
L8	99.13-94.46	A	0.000	0.000	4.527	0.000	0.00
		B	0.000	0.000	9.424	0.000	0.04
		C	0.000	0.000	18.718	0.000	0.13
L9	94.46-94.21	A	0.000	0.000	0.385	0.000	0.00
		B	0.000	0.000	0.648	0.000	0.00

Tower Sectio n	Tower Elevation ft	Face	A _R ft ²	A _F ft ²	C _{AA} In Face ft ²	C _{AA} Out Face ft ²	Weight K
L10	94.21-89.21	C	0.000	0.000	1.146	0.000	0.01
		A	0.000	0.000	7.708	0.000	0.00
		B	0.000	0.000	12.957	0.000	0.04
L11	89.21-89.00	C	0.000	0.000	23.594	0.000	0.15
		A	0.000	0.000	0.324	0.000	0.00
		B	0.000	0.000	0.544	0.000	0.00
L12	89.00-85.04	C	0.000	0.000	0.992	0.000	0.01
		A	0.000	0.000	5.788	0.000	0.00
		B	0.000	0.000	9.628	0.000	0.03
L13	85.04-84.04	C	0.000	0.000	18.393	0.000	0.12
		A	0.000	0.000	1.000	0.000	0.00
		B	0.000	0.000	1.508	0.000	0.01
L14	84.04-79.04	C	0.000	0.000	4.183	0.000	0.03
		A	0.000	0.000	5.000	0.000	0.00
		B	0.000	0.000	7.540	0.000	0.08
L15	79.04-74.04	C	0.000	0.000	20.915	0.000	0.15
		A	0.000	0.000	6.156	0.000	0.00
		B	0.000	0.000	8.696	0.000	0.08
L16	74.04-73.50	C	0.000	0.000	22.071	0.000	0.15
		A	0.000	0.000	0.968	0.000	0.00
		B	0.000	0.000	1.242	0.000	0.01
L17	73.50-73.25	C	0.000	0.000	2.686	0.000	0.02
		A	0.000	0.000	0.448	0.000	0.00
		B	0.000	0.000	0.575	0.000	0.00
L18	73.25-73.00	C	0.000	0.000	1.244	0.000	0.01
		A	0.000	0.000	0.448	0.000	0.00
		B	0.000	0.000	0.575	0.000	0.00
L19	73.00-72.75	C	0.000	0.000	1.244	0.000	0.01
		A	0.000	0.000	0.448	0.000	0.00
		B	0.000	0.000	0.575	0.000	0.00
L20	72.75-67.75	C	0.000	0.000	1.244	0.000	0.01
		A	0.000	0.000	5.708	0.000	0.00
		B	0.000	0.000	8.248	0.000	0.08
L21	67.75-63.00	C	0.000	0.000	21.624	0.000	0.15
		A	0.000	0.000	5.585	0.000	0.00
		B	0.000	0.000	7.998	0.000	0.07
L22	63.00-62.75	C	0.000	0.000	20.704	0.000	0.14
		A	0.000	0.000	0.426	0.000	0.00
		B	0.000	0.000	0.553	0.000	0.00
L23	62.75-57.75	C	0.000	0.000	1.222	0.000	0.01
		A	0.000	0.000	10.753	0.000	0.00
		B	0.000	0.000	13.293	0.000	0.08
L24	57.75-57.50	C	0.000	0.000	26.669	0.000	0.15
		A	0.000	0.000	0.629	0.000	0.00
		B	0.000	0.000	0.756	0.000	0.00
L25	57.50-57.33	C	0.000	0.000	1.425	0.000	0.01
		A	0.000	0.000	0.428	0.000	0.00
		B	0.000	0.000	0.514	0.000	0.00
L26	57.33-57.08	C	0.000	0.000	0.969	0.000	0.01
		A	0.000	0.000	0.629	0.000	0.00
		B	0.000	0.000	0.756	0.000	0.00
L27	57.08-52.08	C	0.000	0.000	1.425	0.000	0.01
		A	0.000	0.000	7.211	0.000	0.00
		B	0.000	0.000	9.751	0.000	0.08
L28	52.08-47.08	C	0.000	0.000	23.126	0.000	0.15
		A	0.000	0.000	4.063	0.000	0.00
		B	0.000	0.000	6.603	0.000	0.08
L29	47.08-40.46	C	0.000	0.000	19.978	0.000	0.15
		A	0.000	0.000	5.416	0.000	0.00
		B	0.000	0.000	8.781	0.000	0.10
L30	40.46-39.46	C	0.000	0.000	26.498	0.000	0.20
		A	0.000	0.000	1.625	0.000	0.00
		B	0.000	0.000	2.133	0.000	0.02
L31	39.46-37.75	C	0.000	0.000	4.808	0.000	0.03
		A	0.000	0.000	2.774	0.000	0.00
		B	0.000	0.000	3.641	0.000	0.03
L32	37.75-37.50	C	0.000	0.000	8.207	0.000	0.05
		A	0.000	0.000	0.406	0.000	0.00
		B	0.000	0.000	0.533	0.000	0.00

Tower Section	Tower Elevation ft	Face	A_R	A_F	C_{AA}	C_{AA}	Weight
			ft ²	ft ²	In Face ft ²	Out Face ft ²	
L33	37.50-32.50	C	0.000	0.000	1.202	0.000	0.01
		A	0.000	0.000	5.688	0.000	0.00
		B	0.000	0.000	8.227	0.000	0.08
L34	32.50-27.50	C	0.000	0.000	21.603	0.000	0.15
		A	0.000	0.000	4.063	0.000	0.00
		B	0.000	0.000	6.603	0.000	0.08
L35	27.50-22.50	C	0.000	0.000	19.978	0.000	0.15
		A	0.000	0.000	4.063	0.000	0.00
		B	0.000	0.000	6.603	0.000	0.08
L36	22.50-17.50	C	0.000	0.000	19.978	0.000	0.15
		A	0.000	0.000	4.063	0.000	0.00
		B	0.000	0.000	6.603	0.000	0.08
L37	17.50-12.50	C	0.000	0.000	19.978	0.000	0.15
		A	0.000	0.000	6.771	0.000	0.00
		B	0.000	0.000	9.311	0.000	0.08
L38	12.50-12.25	C	0.000	0.000	22.686	0.000	0.15
		A	0.000	0.000	0.474	0.000	0.00
		B	0.000	0.000	0.601	0.000	0.00
L39	12.25-12.00	C	0.000	0.000	1.270	0.000	0.01
		A	0.000	0.000	0.474	0.000	0.00
		B	0.000	0.000	0.601	0.000	0.00
L40	12.00-7.00	C	0.000	0.000	1.270	0.000	0.01
		A	0.000	0.000	9.479	0.000	0.00
		B	0.000	0.000	11.295	0.000	0.07
L41	7.00-2.00	C	0.000	0.000	23.742	0.000	0.13
		A	0.000	0.000	9.479	0.000	0.00
		B	0.000	0.000	9.479	0.000	0.04
L42	2.00-0.00	C	0.000	0.000	15.743	0.000	0.06
		A	0.000	0.000	3.385	0.000	0.00
		B	0.000	0.000	3.385	0.000	0.01
		C	0.000	0.000	3.668	0.000	0.00

Feed Line/Linear Appurtenances Section Areas - With Ice

Tower Section	Tower Elevation ft	Face or Leg	Ice Thickness in	A_R	A_F	C_{AA}	C_{AA}	Weight
				ft ²	ft ²	In Face ft ²	Out Face ft ²	
L1	125.00-120.00	A	0.969	0.000	0.000	0.000	0.000	0.00
		B		0.000	0.000	6.190	0.000	0.09
		C		0.000	0.000	0.000	0.000	0.02
L2	120.00-115.00	A	0.965	0.000	0.000	0.000	0.000	0.00
		B		0.000	0.000	6.177	0.000	0.09
		C		0.000	0.000	0.000	0.000	0.02
L3	115.00-110.00	A	0.961	0.000	0.000	0.000	0.000	0.00
		B		0.000	0.000	6.163	0.000	0.09
		C		0.000	0.000	14.352	0.000	0.18
L4	110.00-105.00	A	0.957	0.000	0.000	0.000	0.000	0.00
		B		0.000	0.000	6.149	0.000	0.09
		C		0.000	0.000	14.333	0.000	0.18
L5	105.00-100.00	A	0.952	0.000	0.000	0.458	0.000	0.00
		B		0.000	0.000	7.049	0.000	0.09
		C		0.000	0.000	25.345	0.000	0.34
L6	100.00-99.38	A	0.949	0.000	0.000	0.457	0.000	0.00
		B		0.000	0.000	1.680	0.000	0.02
		C		0.000	0.000	3.566	0.000	0.04
L7	99.38-99.13	A	0.949	0.000	0.000	0.183	0.000	0.00
		B		0.000	0.000	0.672	0.000	0.01
		C		0.000	0.000	1.426	0.000	0.02
L8	99.13-94.46	A	0.947	0.000	0.000	5.789	0.000	0.03
		B		0.000	0.000	14.905	0.000	0.14
		C		0.000	0.000	28.974	0.000	0.35
L9	94.46-94.21	A	0.944	0.000	0.000	0.480	0.000	0.00
		B		0.000	0.000	0.968	0.000	0.01
		C		0.000	0.000	1.722	0.000	0.02
L10	94.21-89.21	A	0.941	0.000	0.000	9.591	0.000	0.06
		B		0.000	0.000	19.341	0.000	0.16

Tower Section	Tower Elevation ft	Face or Leg	Ice Thickness in	A _R ft ²	A _F ft ²	C _A A _A In Face ft ²	C _A A _A Out Face ft ²	Weight K
L11	89.21-89.00	C		0.000	0.000	35.985	0.000	0.41
		A	0.939	0.000	0.000	0.403	0.000	0.00
		B		0.000	0.000	0.812	0.000	0.01
		C		0.000	0.000	1.513	0.000	0.02
L12	89.00-85.04	A	0.937	0.000	0.000	7.162	0.000	0.04
		B		0.000	0.000	14.441	0.000	0.12
		C		0.000	0.000	28.090	0.000	0.32
L13	85.04-84.04	A	0.934	0.000	0.000	1.187	0.000	0.01
		B		0.000	0.000	2.404	0.000	0.02
		C		0.000	0.000	6.472	0.000	0.08
L14	84.04-79.04	A	0.930	0.000	0.000	5.930	0.000	0.03
		B		0.000	0.000	11.994	0.000	0.15
		C		0.000	0.000	32.308	0.000	0.38
L15	79.04-74.04	A	0.925	0.000	0.000	7.350	0.000	0.04
		B		0.000	0.000	13.395	0.000	0.16
		C		0.000	0.000	33.683	0.000	0.39
L16	74.04-73.50	A	0.921	0.000	0.000	1.166	0.000	0.01
		B		0.000	0.000	1.818	0.000	0.02
		C		0.000	0.000	4.008	0.000	0.04
L17	73.50-73.25	A	0.921	0.000	0.000	0.540	0.000	0.00
		B		0.000	0.000	0.842	0.000	0.01
		C		0.000	0.000	1.855	0.000	0.02
L18	73.25-73.00	A	0.920	0.000	0.000	0.540	0.000	0.00
		B		0.000	0.000	0.842	0.000	0.01
		C		0.000	0.000	1.855	0.000	0.02
L19	73.00-72.75	A	0.920	0.000	0.000	0.540	0.000	0.00
		B		0.000	0.000	0.841	0.000	0.01
		C		0.000	0.000	1.855	0.000	0.02
L20	72.75-67.75	A	0.917	0.000	0.000	6.946	0.000	0.04
		B		0.000	0.000	12.965	0.000	0.16
		C		0.000	0.000	33.217	0.000	0.39
L21	67.75-63.00	A	0.910	0.000	0.000	6.645	0.000	0.04
		B		0.000	0.000	12.343	0.000	0.15
		C		0.000	0.000	31.554	0.000	0.37
L22	63.00-62.75	A	0.907	0.000	0.000	0.496	0.000	0.00
		B		0.000	0.000	0.795	0.000	0.01
		C		0.000	0.000	1.805	0.000	0.02
L23	62.75-57.75	A	0.903	0.000	0.000	12.638	0.000	0.07
		B		0.000	0.000	18.612	0.000	0.19
		C		0.000	0.000	38.800	0.000	0.42
L24	57.75-57.50	A	0.899	0.000	0.000	0.743	0.000	0.00
		B		0.000	0.000	1.041	0.000	0.01
		C		0.000	0.000	2.050	0.000	0.02
L25	57.50-57.33	A	0.898	0.000	0.000	0.505	0.000	0.00
		B		0.000	0.000	0.708	0.000	0.01
		C		0.000	0.000	1.394	0.000	0.01
L26	57.33-57.08	A	0.898	0.000	0.000	0.743	0.000	0.00
		B		0.000	0.000	1.041	0.000	0.01
		C		0.000	0.000	2.049	0.000	0.02
L27	57.08-52.08	A	0.894	0.000	0.000	8.587	0.000	0.05
		B		0.000	0.000	14.532	0.000	0.17
		C		0.000	0.000	34.681	0.000	0.39
L28	52.08-47.08	A	0.885	0.000	0.000	4.948	0.000	0.03
		B		0.000	0.000	10.865	0.000	0.14
		C		0.000	0.000	30.975	0.000	0.37
L29	47.08-40.46	A	0.874	0.000	0.000	6.582	0.000	0.04
		B		0.000	0.000	14.372	0.000	0.19
		C		0.000	0.000	40.945	0.000	0.49
L30	40.46-39.46	A	0.866	0.000	0.000	1.975	0.000	0.01
		B		0.000	0.000	3.151	0.000	0.03
		C		0.000	0.000	7.163	0.000	0.08
L31	39.46-37.75	A	0.863	0.000	0.000	3.363	0.000	0.02
		B		0.000	0.000	5.359	0.000	0.06
		C		0.000	0.000	12.191	0.000	0.13
L32	37.75-37.50	A	0.861	0.000	0.000	0.492	0.000	0.00
		B		0.000	0.000	0.784	0.000	0.01
		C		0.000	0.000	1.784	0.000	0.02
L33	37.50-32.50	A	0.855	0.000	0.000	6.884	0.000	0.04
		B		0.000	0.000	12.703	0.000	0.15

Tower Section	Tower Elevation ft	Face or Leg	Ice Thickness in	A _R ft ²	A _F ft ²	C _A A _A In Face ft ²	C _A A _A Out Face ft ²	Weight K
L34	32.50-27.50	C		0.000	0.000	32.677	0.000	0.37
		A	0.842	0.000	0.000	4.904	0.000	0.03
		B		0.000	0.000	10.681	0.000	0.14
L35	27.50-22.50	C		0.000	0.000	30.596	0.000	0.36
		A	0.827	0.000	0.000	4.889	0.000	0.02
		B		0.000	0.000	10.616	0.000	0.14
L36	22.50-17.50	C		0.000	0.000	30.463	0.000	0.35
		A	0.808	0.000	0.000	4.871	0.000	0.02
		B		0.000	0.000	10.538	0.000	0.14
L37	17.50-12.50	C		0.000	0.000	30.303	0.000	0.35
		A	0.785	0.000	0.000	7.866	0.000	0.04
		B		0.000	0.000	13.459	0.000	0.15
L38	12.50-12.25	C		0.000	0.000	33.120	0.000	0.36
		A	0.771	0.000	0.000	0.543	0.000	0.00
		B		0.000	0.000	0.820	0.000	0.01
L39	12.25-12.00	C		0.000	0.000	1.800	0.000	0.02
		A	0.769	0.000	0.000	0.543	0.000	0.00
		B		0.000	0.000	0.820	0.000	0.01
L40	12.00-7.00	C		0.000	0.000	1.799	0.000	0.02
		A	0.750	0.000	0.000	10.831	0.000	0.05
		B		0.000	0.000	14.397	0.000	0.14
L41	7.00-2.00	C		0.000	0.000	33.132	0.000	0.33
		A	0.696	0.000	0.000	10.749	0.000	0.04
		B		0.000	0.000	10.749	0.000	0.08
L42	2.00-0.00	C		0.000	0.000	20.150	0.000	0.17
		A	0.599	0.000	0.000	3.774	0.000	0.01
		B		0.000	0.000	3.774	0.000	0.03
		C		0.000	0.000	4.296	0.000	0.02

Feed Line Center of Pressure

Section	Elevation ft	CP _x in	CP _z in	CP _x Ice in	CP _z Ice in
L1	125.00-120.00	2.3508	-1.6439	1.9823	-2.0766
L2	120.00-115.00	2.3773	-1.6645	2.0259	-2.1242
L3	115.00-110.00	4.0347	3.5169	3.4124	2.1647
L4	110.00-105.00	4.1460	3.6146	3.5235	2.2376
L5	105.00-100.00	0.8355	5.3253	1.0790	3.7072
L6	100.00-99.38	1.4173	4.2707	1.4884	3.3406
L7	99.38-99.13	1.4225	4.2845	1.4935	3.3512
L8	99.13-94.46	1.2252	3.6812	1.3656	3.0600
L9	94.46-94.21	1.0356	3.1044	1.2248	2.7407
L10	94.21-89.21	1.0085	3.2873	1.1745	2.9770
L11	89.21-89.00	1.0267	3.3512	1.1927	3.0355
L12	89.00-85.04	0.9702	3.4610	1.1515	3.1108
L13	85.04-84.04	0.4463	3.9500	0.7606	3.3691
L14	84.04-79.04	0.4572	4.0227	0.7747	3.4287
L15	79.04-74.04	0.4394	3.8313	0.7553	3.3336
L16	74.04-73.50	0.3796	3.2945	0.6785	2.9905
L17	73.50-73.25	0.3808	3.3024	0.6802	2.9975
L18	73.25-73.00	0.3815	3.3072	0.6813	3.0016
L19	73.00-72.75	0.3822	3.3116	0.6821	3.0052
L20	72.75-67.75	0.4771	4.1166	0.7957	3.5014
L21	67.75-63.00	0.4870	4.1708	0.8156	3.5831
L22	63.00-62.75	0.4219	3.5998	0.7435	3.2645
L23	62.75-57.75	0.3816	3.2436	0.6893	3.0246
L24	57.75-57.50	0.3559	3.0147	0.6532	2.8650
L25	57.50-57.33	0.3564	3.0179	0.6539	2.8681
L26	57.33-57.08	0.3568	3.0206	0.6545	2.8707
L27	57.08-52.08	0.4789	4.0407	0.8119	3.5599
L28	52.08-47.08	0.6060	5.0816	0.9543	4.1843
L29	47.08-40.46	0.6236	5.1942	0.9769	4.2864
L30	40.46-39.46	0.4870	4.0500	0.8208	3.5979
L31	39.46-37.75	0.4906	4.0736	0.8229	3.6212

Section	Elevation	CP _x	CP _z	CP _x	CP _z
	ft	in	in	Ice in	Ice in
L32	37.75-37.50	0.4932	4.0906	0.8262	3.6369
L33	37.50-32.50	0.5780	4.7814	0.9272	4.0858
L34	32.50-27.50	0.6607	5.4376	1.0187	4.5016
L35	27.50-22.50	0.6760	5.5373	1.0350	4.5917
L36	22.50-17.50	0.6910	5.6354	1.0495	4.6816
L37	17.50-12.50	0.5943	4.8265	0.9468	4.2571
L38	12.50-12.25	0.5194	4.2091	0.8585	3.8821
L39	12.25-12.00	0.5201	4.2134	0.8589	3.8863
L40	12.00-7.00	0.0668	4.0971	0.3546	4.0175
L41	7.00-2.00	-1.7673	2.3971	-1.8974	2.6170
L42	2.00-0.00	-0.0840	0.3953	-0.1174	0.5521

Note: For pole sections, center of pressure calculations do not consider feed line shielding.

Shielding Factor Ka

Tower Section	Feed Line Record No.	Description	Feed Line Segment Elev.	K _a No Ice	K _a Ice
L1	1	Safety Line 3/8"	120.00 - 125.00	1.0000	1.0000
L1	2	Climbing Pegs	120.00 - 125.00	1.0000	1.0000
L1	10	CONDUIT (2)	120.00 - 125.00	1.0000	1.0000
L2	1	Safety Line 3/8"	115.00 - 120.00	1.0000	1.0000
L2	2	Climbing Pegs	115.00 - 120.00	1.0000	1.0000
L2	10	CONDUIT (2)	115.00 - 120.00	1.0000	1.0000
L3	1	Safety Line 3/8"	110.00 - 115.00	1.0000	1.0000
L3	2	Climbing Pegs	110.00 - 115.00	1.0000	1.0000
L3	10	CONDUIT (2)	110.00 - 115.00	1.0000	1.0000
L3	12	LDF6-50A(1-1/4)	110.00 - 115.00	1.0000	1.0000
L3	16	CONDUIT (2)	110.00 - 115.00	1.0000	1.0000
L3	18	PWRT-608-S(13/16)	110.00 - 115.00	1.0000	1.0000
L3	19	FB-L98B-034-XXX(3/8)	110.00 - 115.00	1.0000	1.0000
L4	1	Safety Line 3/8"	105.00 - 110.00	1.0000	1.0000
L4	2	Climbing Pegs	105.00 - 110.00	1.0000	1.0000
L4	10	CONDUIT (2)	105.00 - 110.00	1.0000	1.0000
L4	12	LDF6-50A(1-1/4)	105.00 - 110.00	1.0000	1.0000
L4	16	CONDUIT (2)	105.00 - 110.00	1.0000	1.0000
L4	18	PWRT-608-S(13/16)	105.00 - 110.00	1.0000	1.0000
L4	19	FB-L98B-034-XXX(3/8)	105.00 - 110.00	1.0000	1.0000
L5	1	Safety Line 3/8"	100.00 - 105.00	1.0000	1.0000
L5	2	Climbing Pegs	100.00 - 105.00	1.0000	1.0000

Tower Section	Feed Line Record No.	Description	Feed Line Segment Elev.	K _a No Ice	K _a Ice
			105.00		
L5	10	CONDUIT (2)	100.00 -	1.0000	1.0000
			105.00		
L5	12	LDF6-50A(1-1/4)	100.00 -	1.0000	1.0000
			105.00		
L5	16	CONDUIT (2)	100.00 -	1.0000	1.0000
			105.00		
L5	18	PWRT-608-S(13/16)	100.00 -	1.0000	1.0000
			105.00		
L5	19	FB-L98B-034-XXX(3/8)	100.00 -	1.0000	1.0000
			105.00		
L5	21	LDF7-50A(1-5/8)	100.00 -	1.0000	1.0000
			105.00		
L5	25	MLCH 12/24 LOW INDUCTION(2)	100.00 -	1.0000	1.0000
			105.00		
L5	59	CCI-CFP-0325125	100.00 -	1.0000	1.0000
			100.63		
L5	60	CCI-CFP-0325125	100.00 -	1.0000	1.0000
			100.63		
L5	61	CCI-CFP-0325125	100.00 -	1.0000	1.0000
			100.63		
L5	62	CCI-CFP-0325125	100.00 -	1.0000	1.0000
			100.63		
L6	1	Safety Line 3/8"	99.38 -	1.0000	1.0000
			100.00		
L6	2	Climbing Pegs	99.38 -	1.0000	1.0000
			100.00		
L6	10	CONDUIT (2)	99.38 -	1.0000	1.0000
			100.00		
L6	12	LDF6-50A(1-1/4)	99.38 -	1.0000	1.0000
			100.00		
L6	16	CONDUIT (2)	99.38 -	1.0000	1.0000
			100.00		
L6	18	PWRT-608-S(13/16)	99.38 -	1.0000	1.0000
			100.00		
L6	19	FB-L98B-034-XXX(3/8)	99.38 -	1.0000	1.0000
			100.00		
L6	21	LDF7-50A(1-5/8)	99.38 -	1.0000	1.0000
			100.00		
L6	25	MLCH 12/24 LOW INDUCTION(2)	99.38 -	1.0000	1.0000
			100.00		
L6	59	CCI-CFP-0325125	99.38 -	1.0000	1.0000
			100.00		
L6	60	CCI-CFP-0325125	99.38 -	1.0000	1.0000
			100.00		
L6	61	CCI-CFP-0325125	99.38 -	1.0000	1.0000
			100.00		
L6	62	CCI-CFP-0325125	99.38 -	1.0000	1.0000
			100.00		
L7	1	Safety Line 3/8"	99.13 -	1.0000	1.0000
			99.38		
L7	2	Climbing Pegs	99.13 -	1.0000	1.0000
			99.38		
L7	10	CONDUIT (2)	99.13 -	1.0000	1.0000
			99.38		
L7	12	LDF6-50A(1-1/4)	99.13 -	1.0000	1.0000
			99.38		
L7	16	CONDUIT (2)	99.13 -	1.0000	1.0000
			99.38		
L7	18	PWRT-608-S(13/16)	99.13 -	1.0000	1.0000
			99.38		
L7	19	FB-L98B-034-XXX(3/8)	99.13 -	1.0000	1.0000
			99.38		
L7	21	LDF7-50A(1-5/8)	99.13 -	1.0000	1.0000
			99.38		
L7	25	MLCH 12/24 LOW INDUCTION(2)	99.13 -	1.0000	1.0000
			99.38		
L7	59	CCI-CFP-0325125	99.13 -	1.0000	1.0000
			99.38		

Tower Section	Feed Line Record No.	Description	Feed Line Segment Elev.	K _a No Ice	K _a Ice
L7	60	CCI-CFP-0325125	99.13 - 99.38	1.0000	1.0000
L7	61	CCI-CFP-0325125	99.13 - 99.38	1.0000	1.0000
L7	62	CCI-CFP-0325125	99.13 - 99.38	1.0000	1.0000
L8	1	Safety Line 3/8"	94.46 - 99.13	1.0000	1.0000
L8	2	Climbing Pegs	94.46 - 99.13	1.0000	1.0000
L8	10	CONDUIT (2)	94.46 - 99.13	1.0000	1.0000
L8	12	LDF6-50A(1-1/4)	94.46 - 99.13	1.0000	1.0000
L8	16	CONDUIT (2)	94.46 - 99.13	1.0000	1.0000
L8	18	PWRT-608-S(13/16)	94.46 - 99.13	1.0000	1.0000
L8	19	FB-L98B-034-XXX(3/8)	94.46 - 99.13	1.0000	1.0000
L8	21	LDF7-50A(1-5/8)	94.46 - 99.13	1.0000	1.0000
L8	25	MLCH 12/24 LOW INDUCTION(2)	94.46 - 99.13	1.0000	1.0000
L8	47	MS600 [6" x 1"]	94.46 - 96.46	1.0000	1.0000
L8	48	MS600 [6" x 1"]	94.46 - 96.46	1.0000	1.0000
L8	49	MS600 [6" x 1"]	94.46 - 96.46	1.0000	1.0000
L8	59	CCI-CFP-0325125	94.46 - 99.13	1.0000	1.0000
L8	60	CCI-CFP-0325125	94.46 - 99.13	1.0000	1.0000
L8	61	CCI-CFP-0325125	94.46 - 99.13	1.0000	1.0000
L8	62	CCI-CFP-0325125	94.46 - 99.13	1.0000	1.0000
L9	1	Safety Line 3/8"	94.21 - 94.46	1.0000	1.0000
L9	2	Climbing Pegs	94.21 - 94.46	1.0000	1.0000
L9	10	CONDUIT (2)	94.21 - 94.46	1.0000	1.0000
L9	12	LDF6-50A(1-1/4)	94.21 - 94.46	1.0000	1.0000
L9	16	CONDUIT (2)	94.21 - 94.46	1.0000	1.0000
L9	18	PWRT-608-S(13/16)	94.21 - 94.46	1.0000	1.0000
L9	19	FB-L98B-034-XXX(3/8)	94.21 - 94.46	1.0000	1.0000
L9	21	LDF7-50A(1-5/8)	94.21 - 94.46	1.0000	1.0000
L9	25	MLCH 12/24 LOW INDUCTION(2)	94.21 - 94.46	1.0000	1.0000
L9	47	MS600 [6" x 1"]	94.21 - 94.46	1.0000	1.0000
L9	48	MS600 [6" x 1"]	94.21 - 94.46	1.0000	1.0000
L9	49	MS600 [6" x 1"]	94.21 - 94.46	1.0000	1.0000
L9	59	CCI-CFP-0325125	94.21 - 94.46	1.0000	1.0000
L9	60	CCI-CFP-0325125	94.21 - 94.46	1.0000	1.0000
L9	61	CCI-CFP-0325125	94.21 - 94.46	1.0000	1.0000
L9	62	CCI-CFP-0325125	94.21 - 94.46	1.0000	1.0000

Tower Section	Feed Line Record No.	Description	Feed Line Segment Elev.	K _a No Ice	K _a Ice
L10	1	Safety Line 3/8"	94.46 89.21 - 94.21	1.0000	1.0000
L10	2	Climbing Pegs	89.21 - 94.21	1.0000	1.0000
L10	10	CONDUIT (2)	89.21 - 94.21	1.0000	1.0000
L10	12	LDF6-50A(1-1/4)	89.21 - 94.21	1.0000	1.0000
L10	16	CONDUIT (2)	89.21 - 94.21	1.0000	1.0000
L10	18	PWRT-608-S(13/16)	89.21 - 94.21	1.0000	1.0000
L10	19	FB-L98B-034-XXX(3/8)	89.21 - 94.21	1.0000	1.0000
L10	21	LDF7-50A(1-5/8)	89.21 - 94.21	1.0000	1.0000
L10	25	MLCH 12/24 LOW INDUCTION(2)	89.21 - 94.21	1.0000	1.0000
L10	27	CU12PSM9P8XXX(1-3/8)	89.21 - 94.00	1.0000	1.0000
L10	47	MS600 [6" x 1"]	89.21 - 94.21	1.0000	1.0000
L10	48	MS600 [6" x 1"]	89.21 - 94.21	1.0000	1.0000
L10	49	MS600 [6" x 1"]	89.21 - 94.21	1.0000	1.0000
L10	59	CCI-CFP-0325125	89.21 - 94.21	1.0000	1.0000
L10	60	CCI-CFP-0325125	89.21 - 94.21	1.0000	1.0000
L10	61	CCI-CFP-0325125	89.21 - 94.21	1.0000	1.0000
L10	62	CCI-CFP-0325125	89.21 - 94.21	1.0000	1.0000
L11	1	Safety Line 3/8"	89.00 - 89.21	1.0000	1.0000
L11	2	Climbing Pegs	89.00 - 89.21	1.0000	1.0000
L11	10	CONDUIT (2)	89.00 - 89.21	1.0000	1.0000
L11	12	LDF6-50A(1-1/4)	89.00 - 89.21	1.0000	1.0000
L11	16	CONDUIT (2)	89.00 - 89.21	1.0000	1.0000
L11	18	PWRT-608-S(13/16)	89.00 - 89.21	1.0000	1.0000
L11	19	FB-L98B-034-XXX(3/8)	89.00 - 89.21	1.0000	1.0000
L11	21	LDF7-50A(1-5/8)	89.00 - 89.21	1.0000	1.0000
L11	25	MLCH 12/24 LOW INDUCTION(2)	89.00 - 89.21	1.0000	1.0000
L11	27	CU12PSM9P8XXX(1-3/8)	89.00 - 89.21	1.0000	1.0000
L11	47	MS600 [6" x 1"]	89.00 - 89.21	1.0000	1.0000
L11	48	MS600 [6" x 1"]	89.00 - 89.21	1.0000	1.0000
L11	49	MS600 [6" x 1"]	89.00 - 89.21	1.0000	1.0000
L11	59	CCI-CFP-0325125	89.00 - 89.21	1.0000	1.0000
L11	60	CCI-CFP-0325125	89.00 - 89.21	1.0000	1.0000
L11	61	CCI-CFP-0325125	89.00 - 89.21	1.0000	1.0000
L11	62	CCI-CFP-0325125	89.00 - 89.21	1.0000	1.0000

Tower Section	Feed Line Record No.	Description	Feed Line Segment Elev.	K _a No Ice	K _a Ice
L12	1	Safety Line 3/8"	85.04 - 89.00	1.0000	1.0000
L12	2	Climbing Pegs	85.04 - 89.00	1.0000	1.0000
L12	10	CONDUIT (2)	85.04 - 89.00	1.0000	1.0000
L12	12	LDF6-50A(1-1/4)	85.04 - 89.00	1.0000	1.0000
L12	16	CONDUIT (2)	85.04 - 89.00	1.0000	1.0000
L12	18	PWRT-608-S(13/16)	85.04 - 89.00	1.0000	1.0000
L12	19	FB-L98B-034-XXX(3/8)	85.04 - 89.00	1.0000	1.0000
L12	21	LDF7-50A(1-5/8)	85.04 - 89.00	1.0000	1.0000
L12	25	MLCH 12/24 LOW INDUCTION(2)	85.04 - 89.00	1.0000	1.0000
L12	27	CU12PSM9P8XXX(1-3/8)	85.04 - 89.00	1.0000	1.0000
L12	47	MS600 [6" x 1"]	85.04 - 89.00	1.0000	1.0000
L12	48	MS600 [6" x 1"]	85.04 - 89.00	1.0000	1.0000
L12	49	MS600 [6" x 1"]	85.04 - 89.00	1.0000	1.0000
L12	59	CCI-CFP-0325125	85.63 - 89.00	1.0000	1.0000
L12	60	CCI-CFP-0325125	85.63 - 89.00	1.0000	1.0000
L12	61	CCI-CFP-0325125	85.63 - 89.00	1.0000	1.0000
L12	62	CCI-CFP-0325125	85.63 - 89.00	1.0000	1.0000
L13	1	Safety Line 3/8"	84.04 - 85.04	1.0000	1.0000
L13	2	Climbing Pegs	84.04 - 85.04	1.0000	1.0000
L13	10	CONDUIT (2)	84.04 - 85.04	1.0000	1.0000
L13	12	LDF6-50A(1-1/4)	84.04 - 85.04	1.0000	1.0000
L13	16	CONDUIT (2)	84.04 - 85.04	1.0000	1.0000
L13	18	PWRT-608-S(13/16)	84.04 - 85.04	1.0000	1.0000
L13	19	FB-L98B-034-XXX(3/8)	84.04 - 85.04	1.0000	1.0000
L13	21	LDF7-50A(1-5/8)	84.04 - 85.04	1.0000	1.0000
L13	25	MLCH 12/24 LOW INDUCTION(2)	84.04 - 85.04	1.0000	1.0000
L13	27	CU12PSM9P8XXX(1-3/8)	84.04 - 85.04	1.0000	1.0000
L13	47	MS600 [6" x 1"]	84.04 - 85.04	1.0000	1.0000
L13	48	MS600 [6" x 1"]	84.04 - 85.04	1.0000	1.0000
L13	49	MS600 [6" x 1"]	84.04 - 85.04	1.0000	1.0000
L14	1	Safety Line 3/8"	79.04 - 84.04	1.0000	1.0000
L14	2	Climbing Pegs	79.04 - 84.04	1.0000	1.0000
L14	10	CONDUIT (2)	79.04 - 84.04	1.0000	1.0000
L14	12	LDF6-50A(1-1/4)	79.04 - 84.04	1.0000	1.0000
L14	16	CONDUIT (2)	79.04 -	1.0000	1.0000

Tower Section	Feed Line Record No.	Description	Feed Line Segment Elev.	K _a No Ice	K _a Ice
L14	18	PWRT-608-S(13/16)	84.04 79.04 - 84.04	1.0000	1.0000
L14	19	FB-L98B-034-XXX(3/8)	79.04 - 84.04	1.0000	1.0000
L14	21	LDF7-50A(1-5/8)	79.04 - 84.04	1.0000	1.0000
L14	25	MLCH 12/24 LOW INDUCTION(2)	79.04 - 84.04	1.0000	1.0000
L14	27	CU12PSM9P8XXX(1-3/8)	79.04 - 84.04	1.0000	1.0000
L14	47	MS600 [6" x 1"]	79.04 - 84.04	1.0000	1.0000
L14	48	MS600 [6" x 1"]	79.04 - 84.04	1.0000	1.0000
L14	49	MS600 [6" x 1"]	79.04 - 84.04	1.0000	1.0000
L15	1	Safety Line 3/8"	74.04 - 79.04	1.0000	1.0000
L15	2	Climbing Pegs	74.04 - 79.04	1.0000	1.0000
L15	10	CONDUIT (2)	74.04 - 79.04	1.0000	1.0000
L15	12	LDF6-50A(1-1/4)	74.04 - 79.04	1.0000	1.0000
L15	16	CONDUIT (2)	74.04 - 79.04	1.0000	1.0000
L15	18	PWRT-608-S(13/16)	74.04 - 79.04	1.0000	1.0000
L15	19	FB-L98B-034-XXX(3/8)	74.04 - 79.04	1.0000	1.0000
L15	21	LDF7-50A(1-5/8)	74.04 - 79.04	1.0000	1.0000
L15	25	MLCH 12/24 LOW INDUCTION(2)	74.04 - 79.04	1.0000	1.0000
L15	27	CU12PSM9P8XXX(1-3/8)	74.04 - 79.04	1.0000	1.0000
L15	43	MP404 [4.75" x 0.75"]	74.04 - 75.50	1.0000	1.0000
L15	44	MP404 [4.75" x 0.75"]	74.04 - 75.50	1.0000	1.0000
L15	45	MP404 [4.75" x 0.75"]	74.04 - 75.50	1.0000	1.0000
L15	47	MS600 [6" x 1"]	74.04 - 79.04	1.0000	1.0000
L15	48	MS600 [6" x 1"]	74.04 - 79.04	1.0000	1.0000
L15	49	MS600 [6" x 1"]	74.04 - 79.04	1.0000	1.0000
L16	1	Safety Line 3/8"	73.50 - 74.04	1.0000	1.0000
L16	2	Climbing Pegs	73.50 - 74.04	1.0000	1.0000
L16	10	CONDUIT (2)	73.50 - 74.04	1.0000	1.0000
L16	12	LDF6-50A(1-1/4)	73.50 - 74.04	1.0000	1.0000
L16	16	CONDUIT (2)	73.50 - 74.04	1.0000	1.0000
L16	18	PWRT-608-S(13/16)	73.50 - 74.04	1.0000	1.0000
L16	19	FB-L98B-034-XXX(3/8)	73.50 - 74.04	1.0000	1.0000
L16	21	LDF7-50A(1-5/8)	73.50 - 74.04	1.0000	1.0000
L16	25	MLCH 12/24 LOW INDUCTION(2)	73.50 - 74.04	1.0000	1.0000
L16	27	CU12PSM9P8XXX(1-3/8)	73.50 - 74.04	1.0000	1.0000

Tower Section	Feed Line Record No.	Description	Feed Line Segment Elev.	K _a No Ice	K _a Ice
L16	43	MP404 [4.75" x 0.75"]	73.50 - 74.04	1.0000	1.0000
L16	44	MP404 [4.75" x 0.75"]	73.50 - 74.04	1.0000	1.0000
L16	45	MP404 [4.75" x 0.75"]	73.50 - 74.04	1.0000	1.0000
L16	47	MS600 [6" x 1"]	73.50 - 74.04	1.0000	1.0000
L16	48	MS600 [6" x 1"]	73.50 - 74.04	1.0000	1.0000
L16	49	MS600 [6" x 1"]	73.50 - 74.04	1.0000	1.0000
L17	1	Safety Line 3/8"	73.25 - 73.50	1.0000	1.0000
L17	2	Climbing Pegs	73.25 - 73.50	1.0000	1.0000
L17	10	CONDUIT (2)	73.25 - 73.50	1.0000	1.0000
L17	12	LDF6-50A(1-1/4)	73.25 - 73.50	1.0000	1.0000
L17	16	CONDUIT (2)	73.25 - 73.50	1.0000	1.0000
L17	18	PWRT-608-S(13/16)	73.25 - 73.50	1.0000	1.0000
L17	19	FB-L98B-034-XXX(3/8)	73.25 - 73.50	1.0000	1.0000
L17	21	LDF7-50A(1-5/8)	73.25 - 73.50	1.0000	1.0000
L17	25	MLCH 12/24 LOW INDUCTION(2)	73.25 - 73.50	1.0000	1.0000
L17	27	CU12PSM9P8XXX(1-3/8)	73.25 - 73.50	1.0000	1.0000
L17	43	MP404 [4.75" x 0.75"]	73.25 - 73.50	1.0000	1.0000
L17	44	MP404 [4.75" x 0.75"]	73.25 - 73.50	1.0000	1.0000
L17	45	MP404 [4.75" x 0.75"]	73.25 - 73.50	1.0000	1.0000
L17	47	MS600 [6" x 1"]	73.25 - 73.50	1.0000	1.0000
L17	48	MS600 [6" x 1"]	73.25 - 73.50	1.0000	1.0000
L17	49	MS600 [6" x 1"]	73.25 - 73.50	1.0000	1.0000
L18	1	Safety Line 3/8"	73.00 - 73.25	1.0000	1.0000
L18	2	Climbing Pegs	73.00 - 73.25	1.0000	1.0000
L18	10	CONDUIT (2)	73.00 - 73.25	1.0000	1.0000
L18	12	LDF6-50A(1-1/4)	73.00 - 73.25	1.0000	1.0000
L18	16	CONDUIT (2)	73.00 - 73.25	1.0000	1.0000
L18	18	PWRT-608-S(13/16)	73.00 - 73.25	1.0000	1.0000
L18	19	FB-L98B-034-XXX(3/8)	73.00 - 73.25	1.0000	1.0000
L18	21	LDF7-50A(1-5/8)	73.00 - 73.25	1.0000	1.0000
L18	25	MLCH 12/24 LOW INDUCTION(2)	73.00 - 73.25	1.0000	1.0000
L18	27	CU12PSM9P8XXX(1-3/8)	73.00 - 73.25	1.0000	1.0000
L18	43	MP404 [4.75" x 0.75"]	73.00 - 73.25	1.0000	1.0000
L18	44	MP404 [4.75" x 0.75"]	73.00 - 73.25	1.0000	1.0000
L18	45	MP404 [4.75" x 0.75"]	73.00 - 73.25	1.0000	1.0000

Tower Section	Feed Line Record No.	Description	Feed Line Segment Elev.	K _a No Ice	K _a Ice
L18	47	MS600 [6" x 1"]	73.25 73.00 -	1.0000	1.0000
L18	48	MS600 [6" x 1"]	73.25 73.00 -	1.0000	1.0000
L18	49	MS600 [6" x 1"]	73.25 73.00 -	1.0000	1.0000
L19	1	Safety Line 3/8"	73.25 72.75 -	1.0000	1.0000
L19	2	Climbing Pegs	73.00 72.75 -	1.0000	1.0000
L19	10	CONDUIT (2)	73.00 72.75 -	1.0000	1.0000
L19	12	LDF6-50A(1-1/4)	73.00 72.75 -	1.0000	1.0000
L19	16	CONDUIT (2)	73.00 72.75 -	1.0000	1.0000
L19	18	PWRT-608-S(13/16)	73.00 72.75 -	1.0000	1.0000
L19	19	FB-L98B-034-XXX(3/8)	73.00 72.75 -	1.0000	1.0000
L19	21	LDF7-50A(1-5/8)	73.00 72.75 -	1.0000	1.0000
L19	25	MLCH 12/24 LOW INDUCTION(2)	73.00 72.75 -	1.0000	1.0000
L19	27	CU12PSM9P8XXX(1-3/8)	73.00 72.75 -	1.0000	1.0000
L19	43	MP404 [4.75" x 0.75"]	73.00 72.75 -	1.0000	1.0000
L19	44	MP404 [4.75" x 0.75"]	73.00 72.75 -	1.0000	1.0000
L19	45	MP404 [4.75" x 0.75"]	73.00 72.75 -	1.0000	1.0000
L19	47	MS600 [6" x 1"]	73.00 72.75 -	1.0000	1.0000
L19	48	MS600 [6" x 1"]	73.00 72.75 -	1.0000	1.0000
L19	49	MS600 [6" x 1"]	73.00 72.75 -	1.0000	1.0000
L20	1	Safety Line 3/8"	72.75 67.75 -	1.0000	1.0000
L20	2	Climbing Pegs	72.75 67.75 -	1.0000	1.0000
L20	10	CONDUIT (2)	72.75 67.75 -	1.0000	1.0000
L20	12	LDF6-50A(1-1/4)	72.75 67.75 -	1.0000	1.0000
L20	16	CONDUIT (2)	72.75 67.75 -	1.0000	1.0000
L20	18	PWRT-608-S(13/16)	72.75 67.75 -	1.0000	1.0000
L20	19	FB-L98B-034-XXX(3/8)	72.75 67.75 -	1.0000	1.0000
L20	21	LDF7-50A(1-5/8)	72.75 67.75 -	1.0000	1.0000
L20	25	MLCH 12/24 LOW INDUCTION(2)	72.75 67.75 -	1.0000	1.0000
L20	27	CU12PSM9P8XXX(1-3/8)	72.75 67.75 -	1.0000	1.0000
L20	43	MP404 [4.75" x 0.75"]	72.75 67.75 -	1.0000	1.0000
L20	44	MP404 [4.75" x 0.75"]	72.75 67.75 -	1.0000	1.0000
L20	45	MP404 [4.75" x 0.75"]	72.75 67.75 -	1.0000	1.0000
L20	47	MS600 [6" x 1"]	72.75 71.00 -	1.0000	1.0000
L20	48	MS600 [6" x 1"]	72.75 71.00 -	1.0000	1.0000

Tower Section	Feed Line Record No.	Description	Feed Line Segment Elev.	K _a No Ice	K _a Ice
L20	49	MS600 [6" x 1"]	71.00 - 72.75	1.0000	1.0000
L21	1	Safety Line 3/8"	63.00 - 67.75	1.0000	1.0000
L21	2	Climbing Pegs	63.00 - 67.75	1.0000	1.0000
L21	10	CONDUIT (2)	63.00 - 67.75	1.0000	1.0000
L21	12	LDF6-50A(1-1/4)	63.00 - 67.75	1.0000	1.0000
L21	16	CONDUIT (2)	63.00 - 67.75	1.0000	1.0000
L21	18	PWRT-608-S(13/16)	63.00 - 67.75	1.0000	1.0000
L21	19	FB-L98B-034-XXX(3/8)	63.00 - 67.75	1.0000	1.0000
L21	21	LDF7-50A(1-5/8)	63.00 - 67.75	1.0000	1.0000
L21	25	MLCH 12/24 LOW INDUCTION(2)	63.00 - 67.75	1.0000	1.0000
L21	27	CU12PSM9P8XXX(1-3/8)	63.00 - 67.75	1.0000	1.0000
L21	43	MP404 [4.75" x 0.75"]	63.00 - 67.75	1.0000	1.0000
L21	44	MP404 [4.75" x 0.75"]	63.00 - 67.75	1.0000	1.0000
L21	45	MP404 [4.75" x 0.75"]	63.00 - 67.75	1.0000	1.0000
L21	55	CCI-SFP-060100	63.00 - 65.00	1.0000	1.0000
L21	56	CCI-SFP-060100	63.00 - 65.00	1.0000	1.0000
L21	57	CCI-SFP-060100	63.00 - 65.00	1.0000	1.0000
L22	1	Safety Line 3/8"	62.75 - 63.00	1.0000	1.0000
L22	2	Climbing Pegs	62.75 - 63.00	1.0000	1.0000
L22	10	CONDUIT (2)	62.75 - 63.00	1.0000	1.0000
L22	12	LDF6-50A(1-1/4)	62.75 - 63.00	1.0000	1.0000
L22	16	CONDUIT (2)	62.75 - 63.00	1.0000	1.0000
L22	18	PWRT-608-S(13/16)	62.75 - 63.00	1.0000	1.0000
L22	19	FB-L98B-034-XXX(3/8)	62.75 - 63.00	1.0000	1.0000
L22	21	LDF7-50A(1-5/8)	62.75 - 63.00	1.0000	1.0000
L22	25	MLCH 12/24 LOW INDUCTION(2)	62.75 - 63.00	1.0000	1.0000
L22	27	CU12PSM9P8XXX(1-3/8)	62.75 - 63.00	1.0000	1.0000
L22	43	MP404 [4.75" x 0.75"]	62.75 - 63.00	1.0000	1.0000
L22	44	MP404 [4.75" x 0.75"]	62.75 - 63.00	1.0000	1.0000
L22	45	MP404 [4.75" x 0.75"]	62.75 - 63.00	1.0000	1.0000
L22	55	CCI-SFP-060100	62.75 - 63.00	1.0000	1.0000
L22	56	CCI-SFP-060100	62.75 - 63.00	1.0000	1.0000
L22	57	CCI-SFP-060100	62.75 - 63.00	1.0000	1.0000
L23	1	Safety Line 3/8"	57.75 - 62.75	1.0000	1.0000
L23	2	Climbing Pegs	57.75 -	1.0000	1.0000

Tower Section	Feed Line Record No.	Description	Feed Line Segment Elev.	K _a No Ice	K _a Ice
L23	10	CONDUIT (2)	62.75 57.75 -	1.0000	1.0000
L23	12	LDF6-50A(1-1/4)	62.75 57.75 -	1.0000	1.0000
L23	16	CONDUIT (2)	62.75 57.75 -	1.0000	1.0000
L23	18	PWRT-608-S(13/16)	62.75 57.75 -	1.0000	1.0000
L23	19	FB-L98B-034-XXX(3/8)	62.75 57.75 -	1.0000	1.0000
L23	21	LDF7-50A(1-5/8)	62.75 57.75 -	1.0000	1.0000
L23	25	MLCH 12/24 LOW INDUCTION(2)	62.75 57.75 -	1.0000	1.0000
L23	27	CU12PSM9P8XXX(1-3/8)	62.75 57.75 -	1.0000	1.0000
L23	39	MP406 [4.875" x 1.25"]	62.75 57.75 -	1.0000	1.0000
L23	40	MP406 [4.875" x 1.25"]	60.50 57.75 -	1.0000	1.0000
L23	41	MP406 [4.875" x 1.25"]	60.50 57.75 -	1.0000	1.0000
L23	43	MP404 [4.75" x 0.75"]	60.50 57.75 -	1.0000	1.0000
L23	44	MP404 [4.75" x 0.75"]	62.75 57.75 -	1.0000	1.0000
L23	45	MP404 [4.75" x 0.75"]	62.75 57.75 -	1.0000	1.0000
L23	55	CCI-SFP-060100	62.75 57.75 -	1.0000	1.0000
L23	56	CCI-SFP-060100	62.75 57.75 -	1.0000	1.0000
L23	57	CCI-SFP-060100	62.75 57.75 -	1.0000	1.0000
L24	1	Safety Line 3/8"	62.75 57.50 -	1.0000	1.0000
L24	2	Climbing Pegs	57.75 57.50 -	1.0000	1.0000
L24	10	CONDUIT (2)	57.75 57.50 -	1.0000	1.0000
L24	12	LDF6-50A(1-1/4)	57.75 57.50 -	1.0000	1.0000
L24	16	CONDUIT (2)	57.75 57.50 -	1.0000	1.0000
L24	18	PWRT-608-S(13/16)	57.75 57.50 -	1.0000	1.0000
L24	19	FB-L98B-034-XXX(3/8)	57.75 57.50 -	1.0000	1.0000
L24	21	LDF7-50A(1-5/8)	57.75 57.50 -	1.0000	1.0000
L24	25	MLCH 12/24 LOW INDUCTION(2)	57.75 57.50 -	1.0000	1.0000
L24	27	CU12PSM9P8XXX(1-3/8)	57.75 57.50 -	1.0000	1.0000
L24	39	MP406 [4.875" x 1.25"]	57.75 57.50 -	1.0000	1.0000
L24	40	MP406 [4.875" x 1.25"]	57.75 57.50 -	1.0000	1.0000
L24	41	MP406 [4.875" x 1.25"]	57.75 57.50 -	1.0000	1.0000
L24	43	MP404 [4.75" x 0.75"]	57.75 57.50 -	1.0000	1.0000
L24	44	MP404 [4.75" x 0.75"]	57.75 57.50 -	1.0000	1.0000
L24	45	MP404 [4.75" x 0.75"]	57.75 57.50 -	1.0000	1.0000
L24	55	CCI-SFP-060100	57.75 57.50 -	1.0000	1.0000

Tower Section	Feed Line Record No.	Description	Feed Line Segment Elev.	K _a No Ice	K _a Ice
L24	56	CCI-SFP-060100	57.50 - 57.75	1.0000	1.0000
L24	57	CCI-SFP-060100	57.50 - 57.75	1.0000	1.0000
L25	1	Safety Line 3/8"	57.33 - 57.50	1.0000	1.0000
L25	2	Climbing Pegs	57.33 - 57.50	1.0000	1.0000
L25	10	CONDUIT (2)	57.33 - 57.50	1.0000	1.0000
L25	12	LDF6-50A(1-1/4)	57.33 - 57.50	1.0000	1.0000
L25	16	CONDUIT (2)	57.33 - 57.50	1.0000	1.0000
L25	18	PWRT-608-S(13/16)	57.33 - 57.50	1.0000	1.0000
L25	19	FB-L98B-034-XXX(3/8)	57.33 - 57.50	1.0000	1.0000
L25	21	LDF7-50A(1-5/8)	57.33 - 57.50	1.0000	1.0000
L25	25	MLCH 12/24 LOW INDUCTION(2)	57.33 - 57.50	1.0000	1.0000
L25	27	CU12PSM9P8XXX(1-3/8)	57.33 - 57.50	1.0000	1.0000
L25	39	MP406 [4.875" x 1.25"]	57.33 - 57.50	1.0000	1.0000
L25	40	MP406 [4.875" x 1.25"]	57.33 - 57.50	1.0000	1.0000
L25	41	MP406 [4.875" x 1.25"]	57.33 - 57.50	1.0000	1.0000
L25	43	MP404 [4.75" x 0.75"]	57.33 - 57.50	1.0000	1.0000
L25	44	MP404 [4.75" x 0.75"]	57.33 - 57.50	1.0000	1.0000
L25	45	MP404 [4.75" x 0.75"]	57.33 - 57.50	1.0000	1.0000
L25	55	CCI-SFP-060100	57.33 - 57.50	1.0000	1.0000
L25	56	CCI-SFP-060100	57.33 - 57.50	1.0000	1.0000
L25	57	CCI-SFP-060100	57.33 - 57.50	1.0000	1.0000
L26	1	Safety Line 3/8"	57.08 - 57.33	1.0000	1.0000
L26	2	Climbing Pegs	57.08 - 57.33	1.0000	1.0000
L26	10	CONDUIT (2)	57.08 - 57.33	1.0000	1.0000
L26	12	LDF6-50A(1-1/4)	57.08 - 57.33	1.0000	1.0000
L26	16	CONDUIT (2)	57.08 - 57.33	1.0000	1.0000
L26	18	PWRT-608-S(13/16)	57.08 - 57.33	1.0000	1.0000
L26	19	FB-L98B-034-XXX(3/8)	57.08 - 57.33	1.0000	1.0000
L26	21	LDF7-50A(1-5/8)	57.08 - 57.33	1.0000	1.0000
L26	25	MLCH 12/24 LOW INDUCTION(2)	57.08 - 57.33	1.0000	1.0000
L26	27	CU12PSM9P8XXX(1-3/8)	57.08 - 57.33	1.0000	1.0000
L26	39	MP406 [4.875" x 1.25"]	57.08 - 57.33	1.0000	1.0000
L26	40	MP406 [4.875" x 1.25"]	57.08 - 57.33	1.0000	1.0000
L26	41	MP406 [4.875" x 1.25"]	57.08 - 57.33	1.0000	1.0000
L26	43	MP404 [4.75" x 0.75"]	57.08 -	1.0000	1.0000

Tower Section	Feed Line Record No.	Description	Feed Line Segment Elev.	K _a No Ice	K _a Ice
			57.33		
L26	44	MP404 [4.75" x 0.75"]	57.08 -	1.0000	1.0000
			57.33		
L26	45	MP404 [4.75" x 0.75"]	57.08 -	1.0000	1.0000
			57.33		
L26	55	CCI-SFP-060100	57.08 -	1.0000	1.0000
			57.33		
L26	56	CCI-SFP-060100	57.08 -	1.0000	1.0000
			57.33		
L26	57	CCI-SFP-060100	57.08 -	1.0000	1.0000
			57.33		
L27	1	Safety Line 3/8"	52.08 -	1.0000	1.0000
			57.08		
L27	2	Climbing Pegs	52.08 -	1.0000	1.0000
			57.08		
L27	10	CONDUIT (2)	52.08 -	1.0000	1.0000
			57.08		
L27	12	LDF6-50A(1-1/4)	52.08 -	1.0000	1.0000
			57.08		
L27	16	CONDUIT (2)	52.08 -	1.0000	1.0000
			57.08		
L27	18	PWRT-608-S(13/16)	52.08 -	1.0000	1.0000
			57.08		
L27	19	FB-L98B-034-XXX(3/8)	52.08 -	1.0000	1.0000
			57.08		
L27	21	LDF7-50A(1-5/8)	52.08 -	1.0000	1.0000
			57.08		
L27	25	MLCH 12/24 LOW INDUCTION(2)	52.08 -	1.0000	1.0000
			57.08		
L27	27	CU12PSM9P8XXX(1-3/8)	52.08 -	1.0000	1.0000
			57.08		
L27	39	MP406 [4.875" x 1.25"]	52.08 -	1.0000	1.0000
			57.08		
L27	40	MP406 [4.875" x 1.25"]	52.08 -	1.0000	1.0000
			57.08		
L27	41	MP406 [4.875" x 1.25"]	52.08 -	1.0000	1.0000
			57.08		
L27	43	MP404 [4.75" x 0.75"]	55.50 -	1.0000	1.0000
			57.08		
L27	44	MP404 [4.75" x 0.75"]	55.50 -	1.0000	1.0000
			57.08		
L27	45	MP404 [4.75" x 0.75"]	55.50 -	1.0000	1.0000
			57.08		
L27	55	CCI-SFP-060100	55.00 -	1.0000	1.0000
			57.08		
L27	56	CCI-SFP-060100	55.00 -	1.0000	1.0000
			57.08		
L27	57	CCI-SFP-060100	55.00 -	1.0000	1.0000
			57.08		
L28	1	Safety Line 3/8"	47.08 -	1.0000	1.0000
			52.08		
L28	2	Climbing Pegs	47.08 -	1.0000	1.0000
			52.08		
L28	10	CONDUIT (2)	47.08 -	1.0000	1.0000
			52.08		
L28	12	LDF6-50A(1-1/4)	47.08 -	1.0000	1.0000
			52.08		
L28	16	CONDUIT (2)	47.08 -	1.0000	1.0000
			52.08		
L28	18	PWRT-608-S(13/16)	47.08 -	1.0000	1.0000
			52.08		
L28	19	FB-L98B-034-XXX(3/8)	47.08 -	1.0000	1.0000
			52.08		
L28	21	LDF7-50A(1-5/8)	47.08 -	1.0000	1.0000
			52.08		
L28	25	MLCH 12/24 LOW INDUCTION(2)	47.08 -	1.0000	1.0000
			52.08		
L28	27	CU12PSM9P8XXX(1-3/8)	47.08 -	1.0000	1.0000
			52.08		

Tower Section	Feed Line Record No.	Description	Feed Line Segment Elev.	K _a No Ice	K _a Ice
L28	39	MP406 [4.875" x 1.25"]	47.08 - 52.08	1.0000	1.0000
L28	40	MP406 [4.875" x 1.25"]	47.08 - 52.08	1.0000	1.0000
L28	41	MP406 [4.875" x 1.25"]	47.08 - 52.08	1.0000	1.0000
L29	1	Safety Line 3/8"	40.46 - 47.08	1.0000	1.0000
L29	2	Climbing Pegs	40.46 - 47.08	1.0000	1.0000
L29	10	CONDUIT (2)	40.46 - 47.08	1.0000	1.0000
L29	12	LDF6-50A(1-1/4)	40.46 - 47.08	1.0000	1.0000
L29	16	CONDUIT (2)	40.46 - 47.08	1.0000	1.0000
L29	18	PWRT-608-S(13/16)	40.46 - 47.08	1.0000	1.0000
L29	19	FB-L98B-034-XXX(3/8)	40.46 - 47.08	1.0000	1.0000
L29	21	LDF7-50A(1-5/8)	40.46 - 47.08	1.0000	1.0000
L29	25	MLCH 12/24 LOW INDUCTION(2)	40.46 - 47.08	1.0000	1.0000
L29	27	CU12PSM9P8XXX(1-3/8)	40.46 - 47.08	1.0000	1.0000
L29	35	MP406 [4.875" x 1.25"]	40.46 - 40.50	1.0000	1.0000
L29	36	MP406 [4.875" x 1.25"]	40.46 - 40.50	1.0000	1.0000
L29	37	MP406 [4.875" x 1.25"]	40.46 - 40.50	1.0000	1.0000
L29	39	MP406 [4.875" x 1.25"]	40.46 - 47.08	1.0000	1.0000
L29	40	MP406 [4.875" x 1.25"]	40.46 - 47.08	1.0000	1.0000
L29	41	MP406 [4.875" x 1.25"]	40.46 - 47.08	1.0000	1.0000
L30	1	Safety Line 3/8"	39.46 - 40.46	1.0000	1.0000
L30	2	Climbing Pegs	39.46 - 40.46	1.0000	1.0000
L30	10	CONDUIT (2)	39.46 - 40.46	1.0000	1.0000
L30	12	LDF6-50A(1-1/4)	39.46 - 40.46	1.0000	1.0000
L30	16	CONDUIT (2)	39.46 - 40.46	1.0000	1.0000
L30	18	PWRT-608-S(13/16)	39.46 - 40.46	1.0000	1.0000
L30	19	FB-L98B-034-XXX(3/8)	39.46 - 40.46	1.0000	1.0000
L30	21	LDF7-50A(1-5/8)	39.46 - 40.46	1.0000	1.0000
L30	25	MLCH 12/24 LOW INDUCTION(2)	39.46 - 40.46	1.0000	1.0000
L30	27	CU12PSM9P8XXX(1-3/8)	39.46 - 40.46	1.0000	1.0000
L30	35	MP406 [4.875" x 1.25"]	39.46 - 40.46	1.0000	1.0000
L30	36	MP406 [4.875" x 1.25"]	39.46 - 40.46	1.0000	1.0000
L30	37	MP406 [4.875" x 1.25"]	39.46 - 40.46	1.0000	1.0000
L30	39	MP406 [4.875" x 1.25"]	39.46 - 40.46	1.0000	1.0000
L30	40	MP406 [4.875" x 1.25"]	39.46 - 40.46	1.0000	1.0000
L30	41	MP406 [4.875" x 1.25"]	39.46 -	1.0000	1.0000

Tower Section	Feed Line Record No.	Description	Feed Line Segment Elev.	K _a No Ice	K _a Ice
			40.46		
L31	1	Safety Line 3/8"	37.75 - 39.46	1.0000	1.0000
L31	2	Climbing Pegs	37.75 - 39.46	1.0000	1.0000
L31	10	CONDUIT (2)	37.75 - 39.46	1.0000	1.0000
L31	12	LDF6-50A(1-1/4)	37.75 - 39.46	1.0000	1.0000
L31	16	CONDUIT (2)	37.75 - 39.46	1.0000	1.0000
L31	18	PWRT-608-S(13/16)	37.75 - 39.46	1.0000	1.0000
L31	19	FB-L98B-034-XXX(3/8)	37.75 - 39.46	1.0000	1.0000
L31	21	LDF7-50A(1-5/8)	37.75 - 39.46	1.0000	1.0000
L31	25	MLCH 12/24 LOW INDUCTION(2)	37.75 - 39.46	1.0000	1.0000
L31	27	CU12PSM9P8XXX(1-3/8)	37.75 - 39.46	1.0000	1.0000
L31	35	MP406 [4.875" x 1.25"]	37.75 - 39.46	1.0000	1.0000
L31	36	MP406 [4.875" x 1.25"]	37.75 - 39.46	1.0000	1.0000
L31	37	MP406 [4.875" x 1.25"]	37.75 - 39.46	1.0000	1.0000
L31	39	MP406 [4.875" x 1.25"]	37.75 - 39.46	1.0000	1.0000
L31	40	MP406 [4.875" x 1.25"]	37.75 - 39.46	1.0000	1.0000
L31	41	MP406 [4.875" x 1.25"]	37.75 - 39.46	1.0000	1.0000
L32	1	Safety Line 3/8"	37.50 - 37.75	1.0000	1.0000
L32	2	Climbing Pegs	37.50 - 37.75	1.0000	1.0000
L32	10	CONDUIT (2)	37.50 - 37.75	1.0000	1.0000
L32	12	LDF6-50A(1-1/4)	37.50 - 37.75	1.0000	1.0000
L32	16	CONDUIT (2)	37.50 - 37.75	1.0000	1.0000
L32	18	PWRT-608-S(13/16)	37.50 - 37.75	1.0000	1.0000
L32	19	FB-L98B-034-XXX(3/8)	37.50 - 37.75	1.0000	1.0000
L32	21	LDF7-50A(1-5/8)	37.50 - 37.75	1.0000	1.0000
L32	25	MLCH 12/24 LOW INDUCTION(2)	37.50 - 37.75	1.0000	1.0000
L32	27	CU12PSM9P8XXX(1-3/8)	37.50 - 37.75	1.0000	1.0000
L32	35	MP406 [4.875" x 1.25"]	37.50 - 37.75	1.0000	1.0000
L32	36	MP406 [4.875" x 1.25"]	37.50 - 37.75	1.0000	1.0000
L32	37	MP406 [4.875" x 1.25"]	37.50 - 37.75	1.0000	1.0000
L32	39	MP406 [4.875" x 1.25"]	37.50 - 37.75	1.0000	1.0000
L32	40	MP406 [4.875" x 1.25"]	37.50 - 37.75	1.0000	1.0000
L32	41	MP406 [4.875" x 1.25"]	37.50 - 37.75	1.0000	1.0000
L33	1	Safety Line 3/8"	32.50 - 37.50	1.0000	1.0000
L33	2	Climbing Pegs	32.50 - 37.50	1.0000	1.0000

Tower Section	Feed Line Record No.	Description	Feed Line Segment Elev.	K _a No Ice	K _a Ice
L33	10	CONDUIT (2)	32.50 - 37.50	1.0000	1.0000
L33	12	LDF6-50A(1-1/4)	32.50 - 37.50	1.0000	1.0000
L33	16	CONDUIT (2)	32.50 - 37.50	1.0000	1.0000
L33	18	PWRT-608-S(13/16)	32.50 - 37.50	1.0000	1.0000
L33	19	FB-L98B-034-XXX(3/8)	32.50 - 37.50	1.0000	1.0000
L33	21	LDF7-50A(1-5/8)	32.50 - 37.50	1.0000	1.0000
L33	25	MLCH 12/24 LOW INDUCTION(2)	32.50 - 37.50	1.0000	1.0000
L33	27	CU12PSM9P8XXX(1-3/8)	32.50 - 37.50	1.0000	1.0000
L33	35	MP406 [4.875" x 1.25"]	32.50 - 37.50	1.0000	1.0000
L33	36	MP406 [4.875" x 1.25"]	32.50 - 37.50	1.0000	1.0000
L33	37	MP406 [4.875" x 1.25"]	32.50 - 37.50	1.0000	1.0000
L33	39	MP406 [4.875" x 1.25"]	35.50 - 37.50	1.0000	1.0000
L33	40	MP406 [4.875" x 1.25"]	35.50 - 37.50	1.0000	1.0000
L33	41	MP406 [4.875" x 1.25"]	35.50 - 37.50	1.0000	1.0000
L34	1	Safety Line 3/8"	27.50 - 32.50	1.0000	1.0000
L34	2	Climbing Pegs	27.50 - 32.50	1.0000	1.0000
L34	10	CONDUIT (2)	27.50 - 32.50	1.0000	1.0000
L34	12	LDF6-50A(1-1/4)	27.50 - 32.50	1.0000	1.0000
L34	16	CONDUIT (2)	27.50 - 32.50	1.0000	1.0000
L34	18	PWRT-608-S(13/16)	27.50 - 32.50	1.0000	1.0000
L34	19	FB-L98B-034-XXX(3/8)	27.50 - 32.50	1.0000	1.0000
L34	21	LDF7-50A(1-5/8)	27.50 - 32.50	1.0000	1.0000
L34	25	MLCH 12/24 LOW INDUCTION(2)	27.50 - 32.50	1.0000	1.0000
L34	27	CU12PSM9P8XXX(1-3/8)	27.50 - 32.50	1.0000	1.0000
L34	35	MP406 [4.875" x 1.25"]	27.50 - 32.50	1.0000	1.0000
L34	36	MP406 [4.875" x 1.25"]	27.50 - 32.50	1.0000	1.0000
L34	37	MP406 [4.875" x 1.25"]	27.50 - 32.50	1.0000	1.0000
L35	1	Safety Line 3/8"	22.50 - 27.50	1.0000	1.0000
L35	2	Climbing Pegs	22.50 - 27.50	1.0000	1.0000
L35	10	CONDUIT (2)	22.50 - 27.50	1.0000	1.0000
L35	12	LDF6-50A(1-1/4)	22.50 - 27.50	1.0000	1.0000
L35	16	CONDUIT (2)	22.50 - 27.50	1.0000	1.0000
L35	18	PWRT-608-S(13/16)	22.50 - 27.50	1.0000	1.0000
L35	19	FB-L98B-034-XXX(3/8)	22.50 - 27.50	1.0000	1.0000
L35	21	LDF7-50A(1-5/8)	22.50 -	1.0000	1.0000

Tower Section	Feed Line Record No.	Description	Feed Line Segment Elev.	K _a No Ice	K _a Ice
L35	25	MLCH 12/24 LOW INDUCTION(2)	27.50 - 22.50	1.0000	1.0000
L35	27	CU12PSM9P8XXX(1-3/8)	27.50 - 22.50	1.0000	1.0000
L35	35	MP406 [4.875" x 1.25"]	27.50 - 22.50	1.0000	1.0000
L35	36	MP406 [4.875" x 1.25"]	27.50 - 22.50	1.0000	1.0000
L35	37	MP406 [4.875" x 1.25"]	27.50 - 22.50	1.0000	1.0000
L36	1	Safety Line 3/8"	17.50 - 22.50	1.0000	1.0000
L36	2	Climbing Pegs	17.50 - 22.50	1.0000	1.0000
L36	10	CONDUIT (2)	17.50 - 22.50	1.0000	1.0000
L36	12	LDF6-50A(1-1/4)	17.50 - 22.50	1.0000	1.0000
L36	16	CONDUIT (2)	17.50 - 22.50	1.0000	1.0000
L36	18	PWRT-608-S(13/16)	17.50 - 22.50	1.0000	1.0000
L36	19	FB-L98B-034-XXX(3/8)	17.50 - 22.50	1.0000	1.0000
L36	21	LDF7-50A(1-5/8)	17.50 - 22.50	1.0000	1.0000
L36	25	MLCH 12/24 LOW INDUCTION(2)	17.50 - 22.50	1.0000	1.0000
L36	27	CU12PSM9P8XXX(1-3/8)	17.50 - 22.50	1.0000	1.0000
L36	35	MP406 [4.875" x 1.25"]	17.50 - 22.50	1.0000	1.0000
L36	36	MP406 [4.875" x 1.25"]	17.50 - 22.50	1.0000	1.0000
L36	37	MP406 [4.875" x 1.25"]	17.50 - 22.50	1.0000	1.0000
L37	1	Safety Line 3/8"	12.50 - 17.50	1.0000	1.0000
L37	2	Climbing Pegs	12.50 - 17.50	1.0000	1.0000
L37	10	CONDUIT (2)	12.50 - 17.50	1.0000	1.0000
L37	12	LDF6-50A(1-1/4)	12.50 - 17.50	1.0000	1.0000
L37	16	CONDUIT (2)	12.50 - 17.50	1.0000	1.0000
L37	18	PWRT-608-S(13/16)	12.50 - 17.50	1.0000	1.0000
L37	19	FB-L98B-034-XXX(3/8)	12.50 - 17.50	1.0000	1.0000
L37	21	LDF7-50A(1-5/8)	12.50 - 17.50	1.0000	1.0000
L37	25	MLCH 12/24 LOW INDUCTION(2)	12.50 - 17.50	1.0000	1.0000
L37	27	CU12PSM9P8XXX(1-3/8)	12.50 - 17.50	1.0000	1.0000
L37	35	MP406 [4.875" x 1.25"]	12.50 - 17.50	1.0000	1.0000
L37	36	MP406 [4.875" x 1.25"]	12.50 - 17.50	1.0000	1.0000
L37	37	MP406 [4.875" x 1.25"]	12.50 - 17.50	1.0000	1.0000
L37	51	CCI-WSFP-065125	12.50 - 15.00	1.0000	1.0000
L37	52	CCI-WSFP-065125	12.50 - 15.00	1.0000	1.0000
L37	53	CCI-WSFP-065125	12.50 - 15.00	1.0000	1.0000

Tower Section	Feed Line Record No.	Description	Feed Line Segment Elev.	K _a No Ice	K _a Ice
L38	1	Safety Line 3/8"	12.25 - 12.50	1.0000	1.0000
L38	2	Climbing Pegs	12.25 - 12.50	1.0000	1.0000
L38	10	CONDUIT (2)	12.25 - 12.50	1.0000	1.0000
L38	12	LDF6-50A(1-1/4)	12.25 - 12.50	1.0000	1.0000
L38	16	CONDUIT (2)	12.25 - 12.50	1.0000	1.0000
L38	18	PWRT-608-S(13/16)	12.25 - 12.50	1.0000	1.0000
L38	19	FB-L98B-034-XXX(3/8)	12.25 - 12.50	1.0000	1.0000
L38	21	LDF7-50A(1-5/8)	12.25 - 12.50	1.0000	1.0000
L38	25	MLCH 12/24 LOW INDUCTION(2)	12.25 - 12.50	1.0000	1.0000
L38	27	CU12PSM9P8XXX(1-3/8)	12.25 - 12.50	1.0000	1.0000
L38	35	MP406 [4.875" x 1.25"]	12.25 - 12.50	1.0000	1.0000
L38	36	MP406 [4.875" x 1.25"]	12.25 - 12.50	1.0000	1.0000
L38	37	MP406 [4.875" x 1.25"]	12.25 - 12.50	1.0000	1.0000
L38	51	CCI-WSFP-065125	12.25 - 12.50	1.0000	1.0000
L38	52	CCI-WSFP-065125	12.25 - 12.50	1.0000	1.0000
L38	53	CCI-WSFP-065125	12.25 - 12.50	1.0000	1.0000
L39	1	Safety Line 3/8"	12.00 - 12.25	1.0000	1.0000
L39	2	Climbing Pegs	12.00 - 12.25	1.0000	1.0000
L39	10	CONDUIT (2)	12.00 - 12.25	1.0000	1.0000
L39	12	LDF6-50A(1-1/4)	12.00 - 12.25	1.0000	1.0000
L39	16	CONDUIT (2)	12.00 - 12.25	1.0000	1.0000
L39	18	PWRT-608-S(13/16)	12.00 - 12.25	1.0000	1.0000
L39	19	FB-L98B-034-XXX(3/8)	12.00 - 12.25	1.0000	1.0000
L39	21	LDF7-50A(1-5/8)	12.00 - 12.25	1.0000	1.0000
L39	25	MLCH 12/24 LOW INDUCTION(2)	12.00 - 12.25	1.0000	1.0000
L39	27	CU12PSM9P8XXX(1-3/8)	12.00 - 12.25	1.0000	1.0000
L39	35	MP406 [4.875" x 1.25"]	12.00 - 12.25	1.0000	1.0000
L39	36	MP406 [4.875" x 1.25"]	12.00 - 12.25	1.0000	1.0000
L39	37	MP406 [4.875" x 1.25"]	12.00 - 12.25	1.0000	1.0000
L39	51	CCI-WSFP-065125	12.00 - 12.25	1.0000	1.0000
L39	52	CCI-WSFP-065125	12.00 - 12.25	1.0000	1.0000
L39	53	CCI-WSFP-065125	12.00 - 12.25	1.0000	1.0000
L40	1	Safety Line 3/8"	10.00 - 12.00	1.0000	1.0000
L40	2	Climbing Pegs	10.00 - 12.00	1.0000	1.0000
L40	10	CONDUIT (2)	8.00 - 12.00	1.0000	1.0000

Tower Section	Feed Line Record No.	Description	Feed Line Segment Elev.	K _a No Ice	K _a Ice
L40	12	LDF6-50A(1-1/4)	8.00 - 12.00	1.0000	1.0000
L40	16	CONDUIT (2)	8.00 - 12.00	1.0000	1.0000
L40	18	PWRT-608-S(13/16)	8.00 - 12.00	1.0000	1.0000
L40	19	FB-L98B-034-XXX(3/8)	8.00 - 12.00	1.0000	1.0000
L40	21	LDF7-50A(1-5/8)	7.00 - 12.00	1.0000	1.0000
L40	25	MLCH 12/24 LOW INDUCTION(2)	7.00 - 12.00	1.0000	1.0000
L40	27	CU12PSM9P8XXX(1-3/8)	7.00 - 12.00	1.0000	1.0000
L40	35	MP406 [4.875" x 1.25"]	7.00 - 12.00	1.0000	1.0000
L40	36	MP406 [4.875" x 1.25"]	7.00 - 12.00	1.0000	1.0000
L40	37	MP406 [4.875" x 1.25"]	7.00 - 12.00	1.0000	1.0000
L40	51	CCI-WSFP-065125	7.00 - 12.00	1.0000	1.0000
L40	52	CCI-WSFP-065125	7.00 - 12.00	1.0000	1.0000
L40	53	CCI-WSFP-065125	7.00 - 12.00	1.0000	1.0000
L41	21	LDF7-50A(1-5/8)	3.00 - 7.00	1.0000	1.0000
L41	25	MLCH 12/24 LOW INDUCTION(2)	3.00 - 7.00	1.0000	1.0000
L41	27	CU12PSM9P8XXX(1-3/8)	2.00 - 7.00	1.0000	1.0000
L41	35	MP406 [4.875" x 1.25"]	2.00 - 7.00	1.0000	1.0000
L41	36	MP406 [4.875" x 1.25"]	2.00 - 7.00	1.0000	1.0000
L41	37	MP406 [4.875" x 1.25"]	2.00 - 7.00	1.0000	1.0000
L41	51	CCI-WSFP-065125	2.00 - 7.00	1.0000	1.0000
L41	52	CCI-WSFP-065125	2.00 - 7.00	1.0000	1.0000
L41	53	CCI-WSFP-065125	2.00 - 7.00	1.0000	1.0000
L42	27	CU12PSM9P8XXX(1-3/8)	0.00 - 2.00	1.0000	1.0000
L42	35	MP406 [4.875" x 1.25"]	0.50 - 2.00	1.0000	1.0000
L42	36	MP406 [4.875" x 1.25"]	0.50 - 2.00	1.0000	1.0000
L42	37	MP406 [4.875" x 1.25"]	0.50 - 2.00	1.0000	1.0000
L42	51	CCI-WSFP-065125	0.00 - 2.00	1.0000	1.0000
L42	52	CCI-WSFP-065125	0.00 - 2.00	1.0000	1.0000
L42	53	CCI-WSFP-065125	0.00 - 2.00	1.0000	1.0000

Effective Width of Flat Linear Attachments / Feed Lines

Tower Section	Attachment Record No.	Description	Attachment Segment Elev.	Ratio Calculation Method	Effective Width Ratio
L5	59	CCI-CFP-0325125	100.00 - 100.63	Auto	0.0000
L5	60	CCI-CFP-0325125	100.00 - 100.63	Auto	0.0000
L5	61	CCI-CFP-0325125	100.00 - 100.63	Auto	0.0000
L5	62	CCI-CFP-0325125	100.00 - 100.63	Auto	0.0000
L6	59	CCI-CFP-0325125	99.38 - 100.00	Auto	0.0000
L6	60	CCI-CFP-0325125	99.38 - 100.00	Auto	0.0000
L6	61	CCI-CFP-0325125	99.38 - 100.00	Auto	0.0000
L6	62	CCI-CFP-0325125	99.38 - 100.00	Auto	0.0000
L7	59	CCI-CFP-0325125	99.13 - 99.38	Auto	0.0000
L7	60	CCI-CFP-0325125	99.13 - 99.38	Auto	0.0000
L7	61	CCI-CFP-0325125	99.13 - 99.38	Auto	0.0000
L7	62	CCI-CFP-0325125	99.13 -	Auto	0.0000

Tower Section	Attachment Record No.	Description	Attachment Segment Elev.	Ratio Calculation Method	Effective Width Ratio
L8	47	MS600 [6" x 1"]	99.38 94.46 - 96.46	Auto	0.3921
L8	48	MS600 [6" x 1"]	94.46 - 96.46	Auto	0.3921
L8	49	MS600 [6" x 1"]	94.46 - 96.46	Auto	0.3921
L8	59	CCI-CFP-0325125	94.46 - 99.13	Auto	0.0000
L8	60	CCI-CFP-0325125	94.46 - 99.13	Auto	0.0000
L8	61	CCI-CFP-0325125	94.46 - 99.13	Auto	0.0000
L8	62	CCI-CFP-0325125	94.46 - 99.13	Auto	0.0000
L9	47	MS600 [6" x 1"]	94.21 - 94.46	Auto	0.4400
L9	48	MS600 [6" x 1"]	94.21 - 94.46	Auto	0.4400
L9	49	MS600 [6" x 1"]	94.21 - 94.46	Auto	0.4400
L9	59	CCI-CFP-0325125	94.21 - 94.46	Auto	0.0000
L9	60	CCI-CFP-0325125	94.21 - 94.46	Auto	0.0000
L9	61	CCI-CFP-0325125	94.21 - 94.46	Auto	0.0000
L9	62	CCI-CFP-0325125	94.21 - 94.46	Auto	0.0000
L10	47	MS600 [6" x 1"]	89.21 - 94.21	Auto	0.4161
L10	48	MS600 [6" x 1"]	89.21 - 94.21	Auto	0.4161
L10	49	MS600 [6" x 1"]	89.21 - 94.21	Auto	0.4161
L10	59	CCI-CFP-0325125	89.21 - 94.21	Auto	0.0000
L10	60	CCI-CFP-0325125	89.21 - 94.21	Auto	0.0000
L10	61	CCI-CFP-0325125	89.21 - 94.21	Auto	0.0000
L10	62	CCI-CFP-0325125	89.21 - 94.21	Auto	0.0000
L11	47	MS600 [6" x 1"]	89.00 - 89.21	Auto	0.3997
L11	48	MS600 [6" x 1"]	89.00 - 89.21	Auto	0.3997
L11	49	MS600 [6" x 1"]	89.00 - 89.21	Auto	0.3997
L11	59	CCI-CFP-0325125	89.00 - 89.21	Auto	0.0000
L11	60	CCI-CFP-0325125	89.00 - 89.21	Auto	0.0000
L11	61	CCI-CFP-0325125	89.00 - 89.21	Auto	0.0000
L11	62	CCI-CFP-0325125	89.00 - 89.21	Auto	0.0000
L12	47	MS600 [6" x 1"]	85.04 - 89.00	Auto	0.4122
L12	48	MS600 [6" x 1"]	85.04 - 89.00	Auto	0.4122
L12	49	MS600 [6" x 1"]	85.04 - 89.00	Auto	0.4122
L12	59	CCI-CFP-0325125	85.63 - 89.00	Auto	0.0000
L12	60	CCI-CFP-0325125	85.63 - 89.00	Auto	0.0000
L12	61	CCI-CFP-0325125	85.63 -	Auto	0.0000

Tower Section	Attachment Record No.	Description	Attachment Segment Elev.	Ratio Calculation Method	Effective Width Ratio
L12	62	CCI-CFP-0325125	89.00 85.63 - 89.00	Auto	0.0000
L13	47	MS600 [6" x 1"]	84.04 - 85.04	Auto	0.3602
L13	48	MS600 [6" x 1"]	84.04 - 85.04	Auto	0.3602
L13	49	MS600 [6" x 1"]	84.04 - 85.04	Auto	0.3602
L14	47	MS600 [6" x 1"]	79.04 - 84.04	Auto	0.3378
L14	48	MS600 [6" x 1"]	79.04 - 84.04	Auto	0.3378
L14	49	MS600 [6" x 1"]	79.04 - 84.04	Auto	0.3378
L15	43	MP404 [4.75" x 0.75"]	74.04 - 75.50	Auto	0.1056
L15	44	MP404 [4.75" x 0.75"]	74.04 - 75.50	Auto	0.1056
L15	45	MP404 [4.75" x 0.75"]	74.04 - 75.50	Auto	0.1056
L15	47	MS600 [6" x 1"]	74.04 - 79.04	Auto	0.3030
L15	48	MS600 [6" x 1"]	74.04 - 79.04	Auto	0.3030
L15	49	MS600 [6" x 1"]	74.04 - 79.04	Auto	0.3030
L16	43	MP404 [4.75" x 0.75"]	73.50 - 74.04	Auto	0.0978
L16	44	MP404 [4.75" x 0.75"]	73.50 - 74.04	Auto	0.0978
L16	45	MP404 [4.75" x 0.75"]	73.50 - 74.04	Auto	0.0978
L16	47	MS600 [6" x 1"]	73.50 - 74.04	Auto	0.2857
L16	48	MS600 [6" x 1"]	73.50 - 74.04	Auto	0.2857
L16	49	MS600 [6" x 1"]	73.50 - 74.04	Auto	0.2857
L17	43	MP404 [4.75" x 0.75"]	73.25 - 73.50	Auto	0.1456
L17	44	MP404 [4.75" x 0.75"]	73.25 - 73.50	Auto	0.1456
L17	45	MP404 [4.75" x 0.75"]	73.25 - 73.50	Auto	0.1456
L17	47	MS600 [6" x 1"]	73.25 - 73.50	Auto	0.3236
L17	48	MS600 [6" x 1"]	73.25 - 73.50	Auto	0.3236
L17	49	MS600 [6" x 1"]	73.25 - 73.50	Auto	0.3236
L18	43	MP404 [4.75" x 0.75"]	73.00 - 73.25	Auto	0.1436
L18	44	MP404 [4.75" x 0.75"]	73.00 - 73.25	Auto	0.1436
L18	45	MP404 [4.75" x 0.75"]	73.00 - 73.25	Auto	0.1436
L18	47	MS600 [6" x 1"]	73.00 - 73.25	Auto	0.3220
L18	48	MS600 [6" x 1"]	73.00 - 73.25	Auto	0.3220
L18	49	MS600 [6" x 1"]	73.00 - 73.25	Auto	0.3220
L19	43	MP404 [4.75" x 0.75"]	72.75 - 73.00	Auto	0.0537
L19	44	MP404 [4.75" x 0.75"]	72.75 - 73.00	Auto	0.0537
L19	45	MP404 [4.75" x 0.75"]	72.75 -	Auto	0.0537

Tower Section	Attachment Record No.	Description	Attachment Segment Elev.	Ratio Calculation Method	Effective Width Ratio
L19	47	MS600 [6" x 1"]	73.00 72.75 - 73.00	Auto	0.2508
L19	48	MS600 [6" x 1"]	72.75 - 73.00	Auto	0.2508
L19	49	MS600 [6" x 1"]	72.75 - 73.00	Auto	0.2508
L20	43	MP404 [4.75" x 0.75"]	67.75 - 72.75	Auto	0.0330
L20	44	MP404 [4.75" x 0.75"]	67.75 - 72.75	Auto	0.0330
L20	45	MP404 [4.75" x 0.75"]	67.75 - 72.75	Auto	0.0330
L20	47	MS600 [6" x 1"]	71.00 - 72.75	Auto	0.2446
L20	48	MS600 [6" x 1"]	71.00 - 72.75	Auto	0.2446
L20	49	MS600 [6" x 1"]	71.00 - 72.75	Auto	0.2446
L21	43	MP404 [4.75" x 0.75"]	63.00 - 67.75	Auto	0.0016
L21	44	MP404 [4.75" x 0.75"]	63.00 - 67.75	Auto	0.0016
L21	45	MP404 [4.75" x 0.75"]	63.00 - 67.75	Auto	0.0016
L21	55	CCI-SFP-060100	63.00 - 65.00	Auto	0.1936
L21	56	CCI-SFP-060100	63.00 - 65.00	Auto	0.1936
L21	57	CCI-SFP-060100	63.00 - 65.00	Auto	0.1936
L22	43	MP404 [4.75" x 0.75"]	62.75 - 63.00	Auto	0.0490
L22	44	MP404 [4.75" x 0.75"]	62.75 - 63.00	Auto	0.0490
L22	45	MP404 [4.75" x 0.75"]	62.75 - 63.00	Auto	0.0490
L22	55	CCI-SFP-060100	62.75 - 63.00	Auto	0.2471
L22	56	CCI-SFP-060100	62.75 - 63.00	Auto	0.2471
L22	57	CCI-SFP-060100	62.75 - 63.00	Auto	0.2471
L23	39	MP406 [4.875" x 1.25"]	57.75 - 60.50	Auto	0.0401
L23	40	MP406 [4.875" x 1.25"]	57.75 - 60.50	Auto	0.0401
L23	41	MP406 [4.875" x 1.25"]	57.75 - 60.50	Auto	0.0401
L23	43	MP404 [4.75" x 0.75"]	57.75 - 62.75	Auto	0.0237
L23	44	MP404 [4.75" x 0.75"]	57.75 - 62.75	Auto	0.0237
L23	45	MP404 [4.75" x 0.75"]	57.75 - 62.75	Auto	0.0237
L23	55	CCI-SFP-060100	57.75 - 62.75	Auto	0.2271
L23	56	CCI-SFP-060100	57.75 - 62.75	Auto	0.2271
L23	57	CCI-SFP-060100	57.75 - 62.75	Auto	0.2271
L24	39	MP406 [4.875" x 1.25"]	57.50 - 57.75	Auto	0.0647
L24	40	MP406 [4.875" x 1.25"]	57.50 - 57.75	Auto	0.0647
L24	41	MP406 [4.875" x 1.25"]	57.50 - 57.75	Auto	0.0647
L24	43	MP404 [4.75" x 0.75"]	57.50 -	Auto	0.0401

Tower Section	Attachment Record No.	Description	Attachment Segment Elev.	Ratio Calculation Method	Effective Width Ratio
L24	44	MP404 [4.75" x 0.75"]	57.75 57.50 - 57.75	Auto	0.0401
L24	45	MP404 [4.75" x 0.75"]	57.50 - 57.75	Auto	0.0401
L24	55	CCI-SFP-060100	57.50 - 57.75	Auto	0.2401
L24	56	CCI-SFP-060100	57.50 - 57.75	Auto	0.2401
L24	57	CCI-SFP-060100	57.50 - 57.75	Auto	0.2401
L25	39	MP406 [4.875" x 1.25"]	57.33 - 57.50	Auto	0.0631
L25	40	MP406 [4.875" x 1.25"]	57.33 - 57.50	Auto	0.0631
L25	41	MP406 [4.875" x 1.25"]	57.33 - 57.50	Auto	0.0631
L25	43	MP404 [4.75" x 0.75"]	57.33 - 57.50	Auto	0.0384
L25	44	MP404 [4.75" x 0.75"]	57.33 - 57.50	Auto	0.0384
L25	45	MP404 [4.75" x 0.75"]	57.33 - 57.50	Auto	0.0384
L25	55	CCI-SFP-060100	57.33 - 57.50	Auto	0.2388
L25	56	CCI-SFP-060100	57.33 - 57.50	Auto	0.2388
L25	57	CCI-SFP-060100	57.33 - 57.50	Auto	0.2388
L26	39	MP406 [4.875" x 1.25"]	57.08 - 57.33	Auto	0.0000
L26	40	MP406 [4.875" x 1.25"]	57.08 - 57.33	Auto	0.0000
L26	41	MP406 [4.875" x 1.25"]	57.08 - 57.33	Auto	0.0000
L26	43	MP404 [4.75" x 0.75"]	57.08 - 57.33	Auto	0.0000
L26	44	MP404 [4.75" x 0.75"]	57.08 - 57.33	Auto	0.0000
L26	45	MP404 [4.75" x 0.75"]	57.08 - 57.33	Auto	0.0000
L26	55	CCI-SFP-060100	57.08 - 57.33	Auto	0.1751
L26	56	CCI-SFP-060100	57.08 - 57.33	Auto	0.1751
L26	57	CCI-SFP-060100	57.08 - 57.33	Auto	0.1751
L27	39	MP406 [4.875" x 1.25"]	52.08 - 57.08	Auto	0.0000
L27	40	MP406 [4.875" x 1.25"]	52.08 - 57.08	Auto	0.0000
L27	41	MP406 [4.875" x 1.25"]	52.08 - 57.08	Auto	0.0000
L27	43	MP404 [4.75" x 0.75"]	55.50 - 57.08	Auto	0.0000
L27	44	MP404 [4.75" x 0.75"]	55.50 - 57.08	Auto	0.0000
L27	45	MP404 [4.75" x 0.75"]	55.50 - 57.08	Auto	0.0000
L27	55	CCI-SFP-060100	55.00 - 57.08	Auto	0.1660
L27	56	CCI-SFP-060100	55.00 - 57.08	Auto	0.1660
L27	57	CCI-SFP-060100	55.00 - 57.08	Auto	0.1660
L28	39	MP406 [4.875" x 1.25"]	47.08 - 52.08	Auto	0.0000
L28	40	MP406 [4.875" x 1.25"]	47.08 -	Auto	0.0000

Tower Section	Attachment Record No.	Description	Attachment Segment Elev.	Ratio Calculation Method	Effective Width Ratio
L28	41	MP406 [4.875" x 1.25"]	52.08 47.08 - 52.08	Auto	0.0000
L29	35	MP406 [4.875" x 1.25"]	40.46 - 40.50	Auto	0.0000
L29	36	MP406 [4.875" x 1.25"]	40.46 - 40.50	Auto	0.0000
L29	37	MP406 [4.875" x 1.25"]	40.46 - 40.50	Auto	0.0000
L29	39	MP406 [4.875" x 1.25"]	40.46 - 47.08	Auto	0.0000
L29	40	MP406 [4.875" x 1.25"]	40.46 - 47.08	Auto	0.0000
L29	41	MP406 [4.875" x 1.25"]	40.46 - 47.08	Auto	0.0000
L30	35	MP406 [4.875" x 1.25"]	39.46 - 40.46	Auto	0.0000
L30	36	MP406 [4.875" x 1.25"]	39.46 - 40.46	Auto	0.0000
L30	37	MP406 [4.875" x 1.25"]	39.46 - 40.46	Auto	0.0000
L30	39	MP406 [4.875" x 1.25"]	39.46 - 40.46	Auto	0.0000
L30	40	MP406 [4.875" x 1.25"]	39.46 - 40.46	Auto	0.0000
L30	41	MP406 [4.875" x 1.25"]	39.46 - 40.46	Auto	0.0000
L31	35	MP406 [4.875" x 1.25"]	37.75 - 39.46	Auto	0.0000
L31	36	MP406 [4.875" x 1.25"]	37.75 - 39.46	Auto	0.0000
L31	37	MP406 [4.875" x 1.25"]	37.75 - 39.46	Auto	0.0000
L31	39	MP406 [4.875" x 1.25"]	37.75 - 39.46	Auto	0.0000
L31	40	MP406 [4.875" x 1.25"]	37.75 - 39.46	Auto	0.0000
L31	41	MP406 [4.875" x 1.25"]	37.75 - 39.46	Auto	0.0000
L32	35	MP406 [4.875" x 1.25"]	37.50 - 37.75	Auto	0.0000
L32	36	MP406 [4.875" x 1.25"]	37.50 - 37.75	Auto	0.0000
L32	37	MP406 [4.875" x 1.25"]	37.50 - 37.75	Auto	0.0000
L32	39	MP406 [4.875" x 1.25"]	37.50 - 37.75	Auto	0.0000
L32	40	MP406 [4.875" x 1.25"]	37.50 - 37.75	Auto	0.0000
L32	41	MP406 [4.875" x 1.25"]	37.50 - 37.75	Auto	0.0000
L33	35	MP406 [4.875" x 1.25"]	32.50 - 37.50	Auto	0.0000
L33	36	MP406 [4.875" x 1.25"]	32.50 - 37.50	Auto	0.0000
L33	37	MP406 [4.875" x 1.25"]	32.50 - 37.50	Auto	0.0000
L33	39	MP406 [4.875" x 1.25"]	35.50 - 37.50	Auto	0.0000
L33	40	MP406 [4.875" x 1.25"]	35.50 - 37.50	Auto	0.0000
L33	41	MP406 [4.875" x 1.25"]	35.50 - 37.50	Auto	0.0000
L34	35	MP406 [4.875" x 1.25"]	27.50 - 32.50	Auto	0.0000
L34	36	MP406 [4.875" x 1.25"]	27.50 - 32.50	Auto	0.0000
L34	37	MP406 [4.875" x 1.25"]	27.50 -	Auto	0.0000

Tower Section	Attachment Record No.	Description	Attachment Segment Elev.	Ratio Calculation Method	Effective Width Ratio
L35	35	MP406 [4.875" x 1.25"]	32.50 22.50 - 27.50	Auto	0.0000
L35	36	MP406 [4.875" x 1.25"]	22.50 - 27.50	Auto	0.0000
L35	37	MP406 [4.875" x 1.25"]	22.50 - 27.50	Auto	0.0000
L36	35	MP406 [4.875" x 1.25"]	17.50 - 22.50	Auto	0.0000
L36	36	MP406 [4.875" x 1.25"]	17.50 - 22.50	Auto	0.0000
L36	37	MP406 [4.875" x 1.25"]	17.50 - 22.50	Auto	0.0000
L37	35	MP406 [4.875" x 1.25"]	12.50 - 17.50	Auto	0.0000
L37	36	MP406 [4.875" x 1.25"]	12.50 - 17.50	Auto	0.0000
L37	37	MP406 [4.875" x 1.25"]	12.50 - 17.50	Auto	0.0000
L37	51	CCI-WSFP-065125	12.50 - 15.00	Auto	0.0060
L37	52	CCI-WSFP-065125	12.50 - 15.00	Auto	0.0060
L37	53	CCI-WSFP-065125	12.50 - 15.00	Auto	0.0060
L38	35	MP406 [4.875" x 1.25"]	12.25 - 12.50	Auto	0.0000
L38	36	MP406 [4.875" x 1.25"]	12.25 - 12.50	Auto	0.0000
L38	37	MP406 [4.875" x 1.25"]	12.25 - 12.50	Auto	0.0000
L38	51	CCI-WSFP-065125	12.25 - 12.50	Auto	0.0000
L38	52	CCI-WSFP-065125	12.25 - 12.50	Auto	0.0000
L38	53	CCI-WSFP-065125	12.25 - 12.50	Auto	0.0000
L39	35	MP406 [4.875" x 1.25"]	12.00 - 12.25	Auto	0.0000
L39	36	MP406 [4.875" x 1.25"]	12.00 - 12.25	Auto	0.0000
L39	37	MP406 [4.875" x 1.25"]	12.00 - 12.25	Auto	0.0000
L39	51	CCI-WSFP-065125	12.00 - 12.25	Auto	0.0339
L39	52	CCI-WSFP-065125	12.00 - 12.25	Auto	0.0339
L39	53	CCI-WSFP-065125	12.00 - 12.25	Auto	0.0339
L40	35	MP406 [4.875" x 1.25"]	7.00 - 12.00	Auto	0.0000
L40	36	MP406 [4.875" x 1.25"]	7.00 - 12.00	Auto	0.0000
L40	37	MP406 [4.875" x 1.25"]	7.00 - 12.00	Auto	0.0000
L40	51	CCI-WSFP-065125	7.00 - 12.00	Auto	0.0154
L40	52	CCI-WSFP-065125	7.00 - 12.00	Auto	0.0154
L40	53	CCI-WSFP-065125	7.00 - 12.00	Auto	0.0154
L41	35	MP406 [4.875" x 1.25"]	2.00 - 7.00	Auto	0.0000
L41	36	MP406 [4.875" x 1.25"]	2.00 - 7.00	Auto	0.0000
L41	37	MP406 [4.875" x 1.25"]	2.00 - 7.00	Auto	0.0000
L41	51	CCI-WSFP-065125	2.00 - 7.00	Auto	0.0000
L41	52	CCI-WSFP-065125	2.00 - 7.00	Auto	0.0000
L41	53	CCI-WSFP-065125	2.00 - 7.00	Auto	0.0000
L42	35	MP406 [4.875" x 1.25"]	0.50 - 2.00	Auto	0.0000
L42	36	MP406 [4.875" x 1.25"]	0.50 - 2.00	Auto	0.0000
L42	37	MP406 [4.875" x 1.25"]	0.50 - 2.00	Auto	0.0000
L42	51	CCI-WSFP-065125	0.00 - 2.00	Auto	0.0000
L42	52	CCI-WSFP-065125	0.00 - 2.00	Auto	0.0000
L42	53	CCI-WSFP-065125	0.00 - 2.00	Auto	0.0000

Discrete Tower Loads

Description	Face or Leg	Offset Type	Offsets: Horz Lateral Vert ft ft ft	Azimuth Adjustment °	Placement ft
APXVTM14-C-120 w/ Mount Pipe	A	From Leg	4.00 0.00 2.00	0.0000	125.00
APXVTM14-C-120 w/ Mount Pipe	B	From Leg	4.00 0.00 2.00	0.0000	125.00
APXVTM14-C-120 w/ Mount Pipe	C	From Leg	4.00 0.00 2.00	0.0000	125.00
APXVSPP18-C-A20 w/ Mount Pipe	A	From Leg	4.00 0.00 2.00	0.0000	125.00
APXVSPP18-C-A20 w/ Mount Pipe	B	From Leg	4.00 0.00 2.00	0.0000	125.00
APXVSPP18-C-A20 w/ Mount Pipe	C	From Leg	4.00 0.00 2.00	0.0000	125.00
TD-RRH8X20-25	A	From Leg	4.00 0.00 2.00	0.0000	125.00
TD-RRH8X20-25	B	From Leg	4.00 0.00 2.00	0.0000	125.00
TD-RRH8X20-25	C	From Leg	4.00 0.00 2.00	0.0000	125.00
7'x2" Antenna Mount Pipe	A	From Leg	4.00 0.00 0.00	0.0000	125.00
7'x2" Antenna Mount Pipe	B	From Leg	4.00 0.00 0.00	0.0000	125.00
7'x2" Antenna Mount Pipe	C	From Leg	4.00 0.00 0.00	0.0000	125.00
5' x 2" Pipe Mount	A	From Leg	4.00 0.00 0.00	0.0000	125.00
5' x 2" Pipe Mount	B	From Leg	4.00 0.00 0.00	0.0000	125.00
5' x 2" Pipe Mount	C	From Leg	4.00 0.00 0.00	0.0000	125.00
Climbing Ladder (Flat)	A	From Leg	3.00 0.00 -2.00	0.0000	125.00
Platform Mount [LP 714-1] ***	A	None		0.0000	125.00
LLPX310R-V1 w/ Mount Pipe	A	From Leg	4.00 0.00 4.00	0.0000	125.00
LLPX310R-V1 w/ Mount Pipe	B	From Leg	4.00 0.00 4.00	0.0000	125.00
LLPX310R-V1 w/ Mount Pipe	C	From Leg	4.00	0.0000	125.00

Description	Face or Leg	Offset Type	Offsets: Horz Lateral Vert ft ft ft	Azimuth Adjustment °	Placement ft
			0.00		
WIMAX DAP HEAD	A	From Leg	4.00	0.0000	125.00
			0.00		
WIMAX DAP HEAD	B	From Leg	4.00	0.0000	125.00
			0.00		
WIMAX DAP HEAD	C	From Leg	4.00	0.0000	125.00
			0.00		
HORIZON COMPACT	B	From Leg	4.00	0.0000	125.00
			0.00		
HORIZON COMPACT	C	From Leg	4.00	0.0000	125.00
			0.00		
*****			0.00		
TME-PCS 1900MHz 4x45W-65MHz	A	From Leg	1.00	0.0000	123.00
			0.00		
TME-PCS 1900MHz 4x45W-65MHz	B	From Leg	1.00	0.0000	123.00
			0.00		
TME-PCS 1900MHz 4x45W-65MHz	C	From Leg	1.00	0.0000	123.00
			0.00		
TME-800MHz 2X50W RRH W/FILTER	A	From Leg	1.00	0.0000	123.00
			0.00		
TME-800MHz 2X50W RRH W/FILTER	B	From Leg	1.00	0.0000	123.00
			0.00		
TME-800MHz 2X50W RRH W/FILTER	C	From Leg	1.00	0.0000	123.00
			0.00		
6' x 2" Mount Pipe	A	From Leg	1.00	0.0000	123.00
			0.00		
6' x 2" Mount Pipe	B	From Leg	1.00	0.0000	123.00
			0.00		
6' x 2" Mount Pipe	C	From Leg	1.00	0.0000	123.00
			0.00		
Side Arm Mount [SO 102-3]	A	None		0.0000	123.00

HPA-65R-BUU-H6 w/ Mount Pipe	A	From Leg	4.00	0.0000	115.00
			0.00		
HPA-65R-BUU-H6 w/ Mount Pipe	B	From Leg	2.00	0.0000	115.00
			4.00		
HPA-65R-BUU-H6 w/ Mount Pipe	C	From Leg	0.00	0.0000	115.00
			2.00		
DC6-48-60-18-8F	A	From Leg	4.00	0.0000	115.00
			0.00		
3.5' x 2.375" Mount Pipe	A	From Leg	2.00	0.0000	115.00
			3.00		
3.5' x 2.375" Mount Pipe	B	From Leg	0.00	0.0000	115.00
			3.00		
			0.00		
			0.00		

Description	Face or Leg	Offset Type	Offsets: Horz Lateral Vert ft ft ft	Azimuth Adjustment °	Placement ft
3.5' x 2.375" Mount Pipe	C	From Leg	3.00 0.00 0.00	0.0000	115.00
Platform Mount [LP 303-1] ***	A	None		0.0000	115.00
OPA65R-BU6D w/ Mount Pipe	A	From Leg	4.00 0.00 2.00	0.0000	115.00
OPA65R-BU6D w/ Mount Pipe	B	From Leg	4.00 0.00 2.00	0.0000	115.00
OPA65R-BU6D w/ Mount Pipe	C	From Leg	4.00 0.00 2.00	0.0000	115.00
80010798K w/ Mount Pipe	A	From Leg	4.00 0.00 2.00	0.0000	115.00
80010798K w/ Mount Pipe	B	From Leg	4.00 0.00 2.00	0.0000	115.00
80010798K w/ Mount Pipe	C	From Leg	4.00 0.00 2.00	0.0000	115.00
RADIO 4449 B5/B12	A	From Leg	4.00 0.00 2.00	0.0000	115.00
RADIO 4449 B5/B12	B	From Leg	4.00 0.00 2.00	0.0000	115.00
RADIO 4449 B5/B12	C	From Leg	4.00 0.00 2.00	0.0000	115.00
RRUS-32 B30	A	From Leg	4.00 0.00 2.00	0.0000	115.00
RRUS-32 B30	B	From Leg	4.00 0.00 2.00	0.0000	115.00
RRUS-32 B30	C	From Leg	4.00 0.00 2.00	0.0000	115.00
RRUS 32 B66	A	From Leg	4.00 0.00 2.00	0.0000	115.00
RRUS 32 B66	B	From Leg	4.00 0.00 2.00	0.0000	115.00
RRUS 32 B66	C	From Leg	4.00 0.00 2.00	0.0000	115.00
RRUS 4415 B25	A	From Leg	4.00 0.00 2.00	0.0000	115.00
RRUS 4415 B25	B	From Leg	4.00 0.00 2.00	0.0000	115.00
RRUS 4415 B25	C	From Leg	4.00 0.00 2.00	0.0000	115.00
DC6-48-60-18-8F	A	From Leg	2.00 0.00 2.00	0.0000	115.00
6' Mount Pipe [#P2.0 STD]	A	From Leg	2.00 0.00 0.00	0.0000	115.00

Description	Face or Leg	Offset Type	Offsets: Horz Lateral Vert ft ft ft	Azimuth Adjustment °	Placement ft
6' Mount Pipe [#P2.0 STD]	B	From Leg	2.00 0.00 0.00	0.0000	115.00
6' Mount Pipe [#P2.0 STD]	C	From Leg	2.00 0.00 0.00	0.0000	115.00
12' Top Rail Kit [#HRK12] *****	A	None		0.0000	115.00
(2) JAHH-45B-R3B w/ Mount Pipe	A	From Leg	4.00 0.00 0.00	0.0000	105.00
(2) JAHH-45B-R3B w/ Mount Pipe	B	From Leg	4.00 0.00 0.00	0.0000	105.00
(2) JAHH-45B-R3B w/ Mount Pipe	C	From Leg	4.00 0.00 0.00	0.0000	105.00
Sub6 Antenna - VZS01 w/ Mount Pipe	A	From Leg	4.00 0.00 0.00	0.0000	105.00
Sub6 Antenna - VZS01 w/ Mount Pipe	B	From Leg	4.00 0.00 0.00	0.0000	105.00
Sub6 Antenna - VZS01 w/ Mount Pipe	C	From Leg	4.00 0.00 0.00	0.0000	105.00
CBC78T-DS-43-2X	A	From Leg	4.00 0.00 0.00	0.0000	105.00
CBC78T-DS-43-2X	B	From Leg	4.00 0.00 0.00	0.0000	105.00
CBC78T-DS-43-2X	C	From Leg	4.00 0.00 0.00	0.0000	105.00
(2) BSF0020F3V1	A	From Leg	4.00 0.00 0.00	0.0000	105.00
RVZDC-6627-PF-48	A	From Leg	4.00 0.00 0.00	0.0000	105.00
RFV01U-D1A	A	From Leg	4.00 0.00 0.00	0.0000	105.00
RFV01U-D1A	B	From Leg	4.00 0.00 0.00	0.0000	105.00
RFV01U-D1A	C	From Leg	4.00 0.00 0.00	0.0000	105.00
RFV01U-D2A	A	From Leg	4.00 0.00 0.00	0.0000	105.00
RFV01U-D2A	B	From Leg	4.00 0.00 0.00	0.0000	105.00
RFV01U-D2A	C	From Leg	4.00 0.00 0.00	0.0000	105.00
LNx-6514DS-A1M w/ Mount Pipe	A	From Leg	4.00 0.00 0.00	0.0000	105.00
LNx-6514DS-A1M w/ Mount Pipe	B	From Leg	4.00 0.00 0.00	0.0000	105.00

Description	Face or Leg	Offset Type	Offsets: Horz Lateral Vert ft ft ft	Azimuth Adjustment °	Placement ft
LNx-6514DS-A1M w/ Mount Pipe	C	From Leg	4.00 0.00 0.00	0.0000	105.00
14' Top Rail Kit [#F4P-HRK14]	A	None		0.0000	105.00
14' Fortress Quad-Platform Mount [#F4P-14W]	A	None		0.0000	105.00
(2) 8' x 2" Mount Pipe	A	From Leg	4.00 0.00 0.00	0.0000	105.00
(4) 8' x 2" Mount Pipe	B	From Face	4.00 0.00 0.00	0.0000	105.00
(2) 8' x 2" Mount Pipe	B	From Leg	4.00 0.00 0.00	0.0000	105.00
(2) 8' x 2" Mount Pipe	C	From Leg	4.00 0.00 0.00	0.0000	105.00
Side-By-Side Antenna Mounting Kit	A	From Leg	4.00 0.00 0.00	0.0000	105.00
Side-By-Side Antenna Mounting Kit	B	From Leg	4.00 0.00 0.00	0.0000	105.00
Side-By-Side Antenna Mounting Kit	C	From Leg	4.00 0.00 0.00	0.0000	105.00
*** *****					
MX08FRO665-21 w/ Mount Pipe	A	From Leg	4.00 0.00 3.00	0.0000	94.00
MX08FRO665-21 w/ Mount Pipe	B	From Leg	4.00 0.00 3.00	0.0000	94.00
MX08FRO665-21 w/ Mount Pipe	C	From Leg	4.00 0.00 3.00	0.0000	94.00
TA08025-B604	A	From Leg	4.00 0.00 0.00	0.0000	94.00
TA08025-B604	B	From Leg	4.00 0.00 0.00	0.0000	94.00
TA08025-B604	C	From Leg	4.00 0.00 0.00	0.0000	94.00
TA08025-B605	A	From Leg	4.00 0.00 0.00	0.0000	94.00
TA08025-B605	B	From Leg	4.00 0.00 0.00	0.0000	94.00
TA08025-B605	C	From Leg	4.00 0.00 0.00	0.0000	94.00
RDIDC-9181-PF-48	A	From Leg	2.00 0.00 0.00	0.0000	94.00
4' x 2" Pipe Mount	A	From Leg	2.00 0.00 0.00	0.0000	94.00
(2) 8' x 2" Mount Pipe	A	From Leg	4.00 0.00 0.00	0.0000	94.00
(2) 8' x 2" Mount Pipe	B	From Leg	4.00	0.0000	94.00

Description	Face or Leg	Offset Type	Offsets: Horz Lateral Vert ft ft ft	Azimuth Adjustment °	Placement ft
			0.00		
(2) 8' x 2" Mount Pipe	C	From Leg	0.00 0.00 4.00 0.00 0.00	0.0000	94.00
Commscope MC-K6MHDX-9-96 (3) *****	A	None		0.0000	94.00
8' x 2" Mount Pipe	A	From Leg	4.00 0.00 0.00	0.0000	84.00
8' x 2" Mount Pipe	B	From Leg	4.00 0.00 0.00	0.0000	84.00
8' x 2" Mount Pipe	C	From Leg	4.00 0.00 0.00	0.0000	84.00
12.5' x 2.375" Horizontal Mount Pipe	A	From Leg	4.00 0.00 0.00	0.0000	84.00
12.5' x 2.375" Horizontal Mount Pipe	B	From Leg	4.00 0.00 0.00	0.0000	84.00
12.5' x 2.375" Horizontal Mount Pipe	C	From Leg	4.00 0.00 0.00	0.0000	84.00
(2) 3.5' Hor 2.5x2.5 Angle	A	From Leg	2.00 0.00 0.00	0.0000	84.00
(2) 3.5' Hor 2.5x2.5 Angle	B	From Leg	2.00 0.00 0.00	0.0000	84.00
(2) 3.5' Hor 2.5x2.5 Angle	C	From Leg	2.00 0.00 0.00	0.0000	84.00
Miscellaneous [NA 510-1] T-Arm Mount [TA 602-3_KCKR] ***	A A	None None		0.0000 0.0000	84.00 84.00
AIR 6419 B41_TMO w/ Mount Pipe	A	From Leg	4.00 0.00 0.00	0.0000	84.00
AIR 6419 B41_TMO w/ Mount Pipe	B	From Leg	4.00 0.00 0.00	0.0000	84.00
AIR 6419 B41_TMO w/ Mount Pipe	C	From Leg	4.00 0.00 0.00	0.0000	84.00
APXVAALL24_43-U-NA20_TMO w/ Mount Pipe	A	From Leg	4.00 0.00 0.00	0.0000	84.00
APXVAALL24_43-U-NA20_TMO w/ Mount Pipe	B	From Leg	4.00 0.00 0.00	0.0000	84.00
APXVAALL24_43-U-NA20_TMO w/ Mount Pipe	C	From Leg	4.00 0.00 0.00	0.0000	84.00
RADIO 4449 B71 B85A_T-MOBILE	A	From Leg	4.00 0.00 0.00	0.0000	84.00
RADIO 4449 B71 B85A_T-MOBILE	B	From Leg	4.00 0.00 0.00	0.0000	84.00
RADIO 4449 B71 B85A_T-MOBILE	C	From Leg	4.00 0.00 0.00	0.0000	84.00
RADIO 4460 B2/B25 B66_TMO	A	From Leg	4.00	0.0000	84.00

Description	Face or Leg	Offset Type	Offsets: Horz Lateral Vert ft ft ft	Azimuth Adjustment °	Placement ft
RADIO 4460 B2/B25 B66_TMO	B	From Leg	0.00 0.00 4.00 0.00 0.00	0.0000	84.00
RADIO 4460 B2/B25 B66_TMO	C	From Leg	0.00 0.00 4.00 0.00 0.00	0.0000	84.00

Dishes

Description	Face or Leg	Dish Type	Offset Type	Offsets: Horz Lateral Vert ft	Azimuth Adjustment °	3 dB Beam Width °	Elevation ft	Outside Diameter ft
VHLP2-18	B	Paraboloid w/o Radome	From Leg	4.00 0.00 -1.00	62.0000		125.00	2.17
VHLP2-11	C	Paraboloid w/o Radome	From Leg	4.00 0.00 -1.00	90.0000		125.00	2.17

Load Combinations

Comb. No.	Description
1	Dead Only
2	1.2 Dead+1.0 Wind 0 deg - No Ice
3	0.9 Dead+1.0 Wind 0 deg - No Ice
4	1.2 Dead+1.0 Wind 30 deg - No Ice
5	0.9 Dead+1.0 Wind 30 deg - No Ice
6	1.2 Dead+1.0 Wind 60 deg - No Ice
7	0.9 Dead+1.0 Wind 60 deg - No Ice
8	1.2 Dead+1.0 Wind 90 deg - No Ice
9	0.9 Dead+1.0 Wind 90 deg - No Ice
10	1.2 Dead+1.0 Wind 120 deg - No Ice
11	0.9 Dead+1.0 Wind 120 deg - No Ice
12	1.2 Dead+1.0 Wind 150 deg - No Ice
13	0.9 Dead+1.0 Wind 150 deg - No Ice
14	1.2 Dead+1.0 Wind 180 deg - No Ice
15	0.9 Dead+1.0 Wind 180 deg - No Ice
16	1.2 Dead+1.0 Wind 210 deg - No Ice
17	0.9 Dead+1.0 Wind 210 deg - No Ice
18	1.2 Dead+1.0 Wind 240 deg - No Ice
19	0.9 Dead+1.0 Wind 240 deg - No Ice
20	1.2 Dead+1.0 Wind 270 deg - No Ice
21	0.9 Dead+1.0 Wind 270 deg - No Ice
22	1.2 Dead+1.0 Wind 300 deg - No Ice
23	0.9 Dead+1.0 Wind 300 deg - No Ice
24	1.2 Dead+1.0 Wind 330 deg - No Ice
25	0.9 Dead+1.0 Wind 330 deg - No Ice
26	1.2 Dead+1.0 Ice+1.0 Temp
27	1.2 Dead+1.0 Wind 0 deg+1.0 Ice+1.0 Temp

Comb. No.	Description
28	1.2 Dead+1.0 Wind 30 deg+1.0 Ice+1.0 Temp
29	1.2 Dead+1.0 Wind 60 deg+1.0 Ice+1.0 Temp
30	1.2 Dead+1.0 Wind 90 deg+1.0 Ice+1.0 Temp
31	1.2 Dead+1.0 Wind 120 deg+1.0 Ice+1.0 Temp
32	1.2 Dead+1.0 Wind 150 deg+1.0 Ice+1.0 Temp
33	1.2 Dead+1.0 Wind 180 deg+1.0 Ice+1.0 Temp
34	1.2 Dead+1.0 Wind 210 deg+1.0 Ice+1.0 Temp
35	1.2 Dead+1.0 Wind 240 deg+1.0 Ice+1.0 Temp
36	1.2 Dead+1.0 Wind 270 deg+1.0 Ice+1.0 Temp
37	1.2 Dead+1.0 Wind 300 deg+1.0 Ice+1.0 Temp
38	1.2 Dead+1.0 Wind 330 deg+1.0 Ice+1.0 Temp
39	Dead+Wind 0 deg - Service
40	Dead+Wind 30 deg - Service
41	Dead+Wind 60 deg - Service
42	Dead+Wind 90 deg - Service
43	Dead+Wind 120 deg - Service
44	Dead+Wind 150 deg - Service
45	Dead+Wind 180 deg - Service
46	Dead+Wind 210 deg - Service
47	Dead+Wind 240 deg - Service
48	Dead+Wind 270 deg - Service
49	Dead+Wind 300 deg - Service
50	Dead+Wind 330 deg - Service

Maximum Member Forces

Section No.	Elevation ft	Component Type	Condition	Gov. Load Comb.	Axial K	Major Axis Moment kip-ft	Minor Axis Moment kip-ft
L1	125 - 120	Pole	Max Tension	1	0.00	0.00	0.00
			Max. Compression	26	-8.18	-0.08	-0.07
			Max. Mx	8	-3.59	-33.16	-0.76
			Max. My	2	-3.61	-0.00	33.67
			Max. Vy	8	6.35	-33.16	-0.76
			Max. Vx	2	-6.49	-0.00	33.67
			Max. Torque	23			-1.32
L2	120 - 115	Pole	Max Tension	1	0.00	0.00	0.00
			Max. Compression	26	-8.67	-0.16	-0.03
			Max. Mx	8	-3.88	-65.74	-1.81
			Max. My	2	-3.91	-0.06	66.92
			Max. Vy	8	6.67	-65.74	-1.81
			Max. Vx	2	-6.81	-0.06	66.92
			Max. Torque	23			-1.32
L3	115 - 110	Pole	Max Tension	1	0.00	0.00	0.00
			Max. Compression	26	-16.17	-0.25	0.20
			Max. Mx	8	-7.54	-132.84	-2.82
			Max. My	2	-7.61	-0.14	134.62
			Max. Vy	8	12.16	-132.84	-2.82
			Max. Vx	2	-12.25	-0.14	134.62
			Max. Torque	22			-1.51
L4	110 - 105	Pole	Max Tension	1	0.00	0.00	0.00
			Max. Compression	26	-16.87	-0.35	0.08
			Max. Mx	8	-7.98	-194.48	-3.95
			Max. My	2	-8.05	-0.21	196.63
			Max. Vy	8	12.49	-194.48	-3.95
			Max. Vx	2	-12.57	-0.21	196.63
			Max. Torque	22			-1.51
L5	105 - 100	Pole	Max Tension	1	0.00	0.00	0.00
			Max. Compression	26	-29.73	-1.63	1.29
			Max. Mx	8	-14.82	-292.84	-4.55
			Max. My	2	-14.97	-0.78	294.69
			Max. Vy	8	19.89	-292.84	-4.55
			Max. Vx	2	-19.63	-0.78	294.69
			Max. Torque	22			-3.29
L6	100 - 99.375	Pole	Max Tension	1	0.00	0.00	0.00
			Max. Compression	26	-29.85	-1.64	1.25
			Max. Mx	8	-14.89	-305.29	-4.70

Section No.	Elevation ft	Component Type	Condition	Gov. Load Comb.	Axial K	Major Axis Moment kip-ft	Minor Axis Moment kip-ft			
L7	99.375 - 99.125	Pole	Max. My	2	-15.05	-0.79	306.95			
			Max. Vy	8	19.97	-305.29	-4.70			
			Max. Vx	2	-19.67	-0.79	306.95			
			Max. Torque	22			-3.29			
			Max Tension	1	0.00	0.00	0.00			
			Max. Compression	26	-29.92	-1.65	1.24			
			Max. Mx	8	-14.94	-310.29	-4.77			
			Max. My	2	-15.11	-0.79	311.86			
			Max. Vy	8	20.01	-310.29	-4.77			
			Max. Vx	2	-19.69	-0.79	311.86			
L8	99.125 - 94.46	Pole	Max. Torque	22			-3.29			
			Max Tension	1	0.00	0.00	0.00			
			Max. Compression	26	-31.18	-1.78	0.93			
			Max. Mx	8	-15.72	-405.37	-5.92			
			Max. My	2	-15.92	-0.86	404.50			
			Max. Vy	8	20.75	-405.37	-5.92			
			Max. Vx	2	-20.09	-0.86	404.50			
			Max. Torque	22			-3.29			
			Max Tension	1	0.00	0.00	0.00			
			L9	94.46 - 94.21	Pole	Max. Compression	26	-31.27	-1.79	0.91
Max. Mx	8	-15.78				-410.57	-5.98			
Max. My	2	-15.98				-0.87	409.52			
Max. Vy	8	20.79				-410.57	-5.98			
Max. Vx	2	-20.11				-0.87	409.52			
Max. Torque	22						-3.29			
Max Tension	1	0.00				0.00	0.00			
Max. Compression	26	-37.50				-1.94	0.88			
Max. Mx	8	-19.24				-530.18	-7.09			
L10	94.21 - 89.21	Pole				Max. My	2	-19.49	-0.95	524.84
			Max. Vy	8	24.05	-530.18	-7.09			
			Max. Vx	2	-23.00	-0.95	524.84			
			Max. Torque	22			-3.47			
			Max Tension	1	0.00	0.00	0.00			
			Max. Compression	26	-37.57	-1.94	0.87			
			Max. Mx	8	-19.29	-535.24	-7.14			
			Max. My	2	-19.55	-0.95	529.67			
			Max. Vy	8	24.09	-535.24	-7.14			
			Max. Vx	2	-23.02	-0.95	529.67			
L11	89.21 - 89	Pole	Max. Torque	22			-3.44			
			Max Tension	1	0.00	0.00	0.00			
			Max. Compression	26	-37.59	-1.94	0.86			
			Max. Mx	8	-19.30	-536.27	-7.15			
			Max. My	2	-19.56	-0.95	530.66			
			Max. Vy	8	24.09	-536.27	-7.15			
			Max. Vx	2	-23.02	-0.95	530.66			
			Max. Torque	22			-3.43			
			Max Tension	1	0.00	0.00	0.00			
			L12	89 - 85.04	Pole	Max. Compression	26	-40.07	-2.08	0.48
Max. Mx	8	-21.07				-657.11	-8.41			
Max. My	2	-21.36				-1.03	645.08			
Max. Vy	8	25.02				-657.11	-8.41			
Max. Vx	2	-23.56				-1.03	645.08			
Max. Torque	22						-3.40			
Max Tension	1	0.00				0.00	0.00			
Max. Compression	26	-50.23				-2.21	0.08			
Max. Mx	8	-25.48				-804.86	-9.70			
L13	85.04 - 84.04	Pole				Max. My	2	-25.83	-1.12	784.18
			Max. Vy	8	29.98	-804.86	-9.70			
			Max. Vx	2	-28.08	-1.12	784.18			
			Max. Torque	22			-3.39			
			Max Tension	1	0.00	0.00	0.00			
			Max. Compression	26	-51.86	-2.35	-0.34			
			L14	84.04 - 79.04	Pole	Max. My	2	-25.83	-1.12	784.18
						Max. Vy	8	29.98	-804.86	-9.70
						Max. Vx	2	-28.08	-1.12	784.18
						Max. Torque	22			-3.39
Max Tension	1	0.00				0.00	0.00			
Max. Compression	26	-51.86				-2.35	-0.34			
L15	79.04 - 74.04	Pole				Max. My	2	-25.83	-1.12	784.18
						Max. Vy	8	29.98	-804.86	-9.70
						Max. Vx	2	-28.08	-1.12	784.18
						Max. Torque	22			-3.39
			Max Tension	1	0.00	0.00	0.00			
			Max. Compression	26	-51.86	-2.35	-0.34			

Section No.	Elevation ft	Component Type	Condition	Gov. Load Comb.	Axial K	Major Axis Moment kip-ft	Minor Axis Moment kip-ft			
L16	74.04 - 73.5	Pole	Max. Mx	8	-26.65	-956.66	-11.01			
			Max. My	2	-27.03	-1.20	925.22			
			Max. Vy	8	30.75	-956.66	-11.01			
			Max. Vx	2	-28.43	-1.20	925.22			
			Max. Torque	22			-3.39			
			Max Tension	1	0.00	0.00	0.00			
			Max. Compression	26	-52.04	-2.36	-0.38			
			Max. Mx	8	-26.79	-973.28	-11.15			
			Max. My	2	-27.17	-1.21	940.55			
			Max. Vy	8	30.83	-973.28	-11.15			
L17	73.5 - 73.25	Pole	Max. Vx	2	-28.46	-1.21	940.55			
			Max. Torque	22			-3.39			
			Max Tension	1	0.00	0.00	0.00			
			Max. Compression	26	-52.13	-2.37	-0.41			
			Max. Mx	8	-26.86	-981.00	-11.21			
			Max. My	2	-27.24	-1.22	947.66			
			Max. Vy	8	30.87	-981.00	-11.21			
			Max. Vx	2	-28.47	-1.22	947.66			
			Max. Torque	22			-3.39			
			L18	73.25 - 73	Pole	Max Tension	1	0.00	0.00	0.00
Max. Compression	26	-52.23				-2.37	-0.43			
Max. Mx	8	-26.93				-988.72	-11.28			
Max. My	2	-27.31				-1.22	954.77			
Max. Vy	8	30.91				-988.72	-11.28			
Max. Vx	2	-28.49				-1.22	954.77			
Max. Torque	22						-3.39			
L19	73 - 72.75	Pole				Max Tension	1	0.00	0.00	0.00
						Max. Compression	26	-52.31	-2.38	-0.45
						Max. Mx	8	-26.99	-996.45	-11.34
			Max. My	2	-27.37	-1.22	961.89			
			Max. Vy	8	30.95	-996.45	-11.34			
			Max. Vx	2	-28.51	-1.22	961.89			
			Max. Torque	22			-3.39			
			L20	72.75 - 67.75	Pole	Max Tension	1	0.00	0.00	0.00
						Max. Compression	26	-53.80	-2.51	-0.88
						Max. Mx	8	-28.08	-1153.03	-12.65
Max. My	2	-28.48				-1.31	1104.92			
Max. Vy	8	31.69				-1153.03	-12.65			
Max. Vx	2	-28.79				-1.31	1104.92			
Max. Torque	22						-3.39			
L21	67.75 - 63	Pole				Max Tension	1	0.00	0.00	0.00
						Max. Compression	26	-55.24	-2.64	-1.30
						Max. Mx	8	-29.17	-1305.15	-13.88
			Max. My	2	-29.58	-1.39	1242.04			
			Max. Vy	8	32.39	-1305.15	-13.88			
			Max. Vx	2	-29.05	-1.39	1242.04			
			Max. Torque	22			-3.39			
			L22	63 - 62.75	Pole	Max Tension	1	0.00	0.00	0.00
						Max. Compression	26	-55.34	-2.64	-1.32
						Max. Mx	8	-29.27	-1313.25	-13.95
Max. My	2	-29.67				-1.39	1249.29			
Max. Vy	8	32.41				-1313.25	-13.95			
Max. Vx	2	-29.04				-1.39	1249.29			
Max. Torque	22						-3.38			
L23	62.75 - 57.75	Pole				Max Tension	1	0.00	0.00	0.00
						Max. Compression	26	-57.34	-2.77	-1.77
						Max. Mx	8	-30.72	-1477.41	-15.25
			Max. My	14	-31.13	-11.40	-1395.25			
			Max. Vy	8	33.26	-1477.41	-15.25			
			Max. Vx	2	-29.40	-1.47	1395.17			
			Max. Torque	22			-3.38			
			L24	57.75 - 57.5	Pole	Max Tension	1	0.00	0.00	0.00
						Max. Compression	26	-57.45	-2.78	-1.80
						Max. Mx	8	-30.82	-1485.72	-15.31
Max. My	14	-31.23				-11.44	-1402.60			
Max. Vy	8	33.29				-1485.72	-15.31			
Max. Vx	24	-29.42				741.60	1312.18			

Section No.	Elevation ft	Component Type	Condition	Gov. Load Comb.	Axial K	Major Axis Moment kip-ft	Minor Axis Moment kip-ft
L25	57.5 - 57.33	Pole	Max. Torque	22			-3.38
			Max Tension	1	0.00	0.00	0.00
			Max. Compression	26	-57.52	-2.79	-1.81
			Max. Mx	8	-30.87	-1491.39	-15.36
			Max. My	14	-31.28	-11.47	-1407.61
			Max. Vy	8	33.32	-1491.39	-15.36
			Max. Vx	24	-29.45	744.45	1317.18
L26	57.33 - 57.08	Pole	Max. Torque	22			-3.38
			Max Tension	1	0.00	0.00	0.00
			Max. Compression	26	-57.62	-2.79	-1.83
			Max. Mx	8	-30.94	-1499.72	-15.42
			Max. My	14	-31.35	-11.51	-1414.97
			Max. Vy	8	33.36	-1499.72	-15.42
			Max. Vx	24	-29.49	748.63	1324.54
L27	57.08 - 52.08	Pole	Max. Torque	22			-3.38
			Max Tension	1	0.00	0.00	0.00
			Max. Compression	26	-59.36	-2.93	-2.30
			Max. Mx	8	-32.25	-1668.45	-16.72
			Max. My	14	-32.66	-12.34	-1562.95
			Max. Vy	8	34.13	-1668.45	-16.72
			Max. Vx	24	-30.17	833.41	1473.46
L28	52.08 - 47.08	Pole	Max. Torque	22			-3.38
			Max Tension	1	0.00	0.00	0.00
			Max. Compression	26	-61.05	-3.06	-2.77
			Max. Mx	8	-33.62	-1840.89	-18.02
			Max. My	14	-34.01	-13.17	-1712.33
			Max. Vy	8	34.86	-1840.89	-18.02
			Max. Vx	24	-30.82	920.09	1625.67
L29	47.08 - 40.457	Pole	Max. Torque	22			-3.38
			Max Tension	1	0.00	0.00	0.00
			Max. Compression	26	-61.58	-3.10	-2.92
			Max. Mx	8	-34.03	-1894.72	-18.42
			Max. My	14	-34.42	-13.42	-1758.61
			Max. Vy	8	35.09	-1894.72	-18.42
			Max. Vx	24	-31.03	947.17	1673.20
L30	40.457 - 39.457	Pole	Max. Torque	22			-3.38
			Max Tension	1	0.00	0.00	0.00
			Max. Compression	26	-65.02	-3.26	-3.50
			Max. Mx	8	-36.76	-2111.29	-20.01
			Max. My	14	-37.14	-14.42	-1943.19
			Max. Vy	8	36.12	-2111.29	-20.01
			Max. Vx	24	-31.94	1056.11	1864.39
L31	39.457 - 37.75	Pole	Max. Torque	22			-3.37
			Max Tension	1	0.00	0.00	0.00
			Max. Compression	26	-65.68	-3.30	-3.66
			Max. Mx	8	-37.27	-2173.15	-20.45
			Max. My	14	-37.65	-14.70	-1995.45
			Max. Vy	8	36.39	-2173.15	-20.45
			Max. Vx	24	-32.18	1087.24	1919.01
L32	37.75 - 37.5	Pole	Max. Torque	22			-3.37
			Max Tension	1	0.00	0.00	0.00
			Max. Compression	26	-65.78	-3.31	-3.68
			Max. Mx	8	-37.38	-2182.24	-20.51
			Max. My	14	-37.75	-14.74	-2003.12
			Max. Vy	8	36.39	-2182.24	-20.51
			Max. Vx	24	-32.18	1091.82	1927.04
L33	37.5 - 32.5	Pole	Max. Torque	22			-3.37
			Max Tension	1	0.00	0.00	0.00
			Max. Compression	26	-67.69	-3.42	-4.15
			Max. Mx	8	-38.93	-2365.98	-21.81
			Max. My	14	-39.27	-15.56	-2157.11
			Max. Vy	8	37.11	-2365.98	-21.81
Max. Vx	24	-32.82	1184.32	2089.28			

Section No.	Elevation ft	Component Type	Condition	Gov. Load Comb.	Axial K	Major Axis Moment kip-ft	Minor Axis Moment kip-ft
L34	32.5 - 27.5	Pole	Max. Torque	22			-3.37
			Max Tension	1	0.00	0.00	0.00
			Max. Compression	26	-69.60	-3.54	-4.62
			Max. Mx	8	-40.53	-2553.15	-23.11
			Max. My	14	-40.83	-16.37	-2312.33
			Max. Vy	8	37.78	-2553.15	-23.11
			Max. Vx	24	-33.41	1278.58	2254.55
L35	27.5 - 22.5	Pole	Max. Torque	22			-3.37
			Max Tension	1	0.00	0.00	0.00
			Max. Compression	26	-71.51	-3.66	-5.10
			Max. Mx	8	-42.16	-2743.58	-24.40
			Max. My	14	-42.42	-17.18	-2468.66
			Max. Vy	8	38.42	-2743.58	-24.40
			Max. Vx	24	-33.98	1374.52	2422.71
L36	22.5 - 17.5	Pole	Max. Torque	22			-3.37
			Max Tension	1	0.00	0.00	0.00
			Max. Compression	26	-73.45	-3.78	-5.58
			Max. Mx	8	-43.83	-2937.09	-25.68
			Max. My	14	-44.03	-17.98	-2626.03
			Max. Vy	8	39.01	-2937.09	-25.68
			Max. Vx	24	-34.51	1472.04	2593.60
L37	17.5 - 12.5	Pole	Max. Torque	22			-3.37
			Max Tension	1	0.00	0.00	0.00
			Max. Compression	26	-75.43	-3.90	-6.07
			Max. Mx	8	-45.52	-3133.50	-26.96
			Max. My	14	-45.66	-18.78	-2784.30
			Max. Vy	8	39.57	-3133.50	-26.96
			Max. Vx	24	-35.00	1571.06	2767.04
L38	12.5 - 12.25	Pole	Max. Torque	22			-3.37
			Max Tension	1	0.00	0.00	0.00
			Max. Compression	26	-75.54	-3.91	-6.10
			Max. Mx	8	-45.62	-3143.39	-27.03
			Max. My	14	-45.76	-18.82	-2792.23
			Max. Vy	8	39.58	-3143.39	-27.03
			Max. Vx	24	-35.01	1576.05	2775.78
L39	12.25 - 12	Pole	Max. Torque	22			-3.37
			Max Tension	1	0.00	0.00	0.00
			Max. Compression	26	-75.66	-3.91	-6.12
			Max. Mx	8	-45.73	-3153.29	-27.09
			Max. My	14	-45.87	-18.86	-2800.17
			Max. Vy	8	39.61	-3153.29	-27.09
			Max. Vx	24	-35.04	1581.04	2784.52
L40	12 - 7	Pole	Max. Torque	22			-3.37
			Max Tension	1	0.00	0.00	0.00
			Max. Compression	26	-78.12	-4.00	-6.59
			Max. Mx	8	-47.85	-3352.91	-28.36
			Max. My	24	-47.84	1681.75	2960.86
			Max. Vy	8	40.24	-3352.91	-28.36
			Max. Vx	24	-35.61	1681.75	2960.86
L41	7 - 2	Pole	Max. Torque	22			-3.37
			Max Tension	1	0.00	0.00	0.00
			Max. Compression	26	-80.36	-4.00	-6.84
			Max. Mx	8	-49.88	-3554.63	-29.54
			Max. My	24	-49.88	1783.66	3139.22
			Max. Vy	8	40.49	-3554.63	-29.54
			Max. Vx	24	-35.83	1783.66	3139.22
L42	2 - 0	Pole	Max. Torque	22			-3.37
			Max Tension	1	0.00	0.00	0.00
			Max. Compression	26	-81.19	-4.00	-6.86
			Max. Mx	8	-50.68	-3635.62	-29.97
			Max. My	24	-50.68	1824.59	3210.90
			Max. Vy	8	40.56	-3635.62	-29.97
			Max. Vx	24	-35.90	1824.59	3210.90
			Max. Torque	22			-3.37

Maximum Reactions

Location	Condition	Gov. Load Comb.	Vertical K	Horizontal, X K	Horizontal, Z K
Pole	Max. Vert	32	81.19	-4.67	-8.11
	Max. H _x	21	38.02	40.46	0.02
	Max. H _z	25	38.02	20.48	35.87
	Max. M _x	24	3210.90	20.48	35.87
	Max. M _z	8	3635.62	-40.53	-0.21
	Max. Torsion	10	1.71	-28.82	-16.90
	Min. Vert	7	38.02	-27.32	16.10
	Min. H _x	9	38.02	-40.53	-0.21
	Min. H _z	13	38.02	-20.61	-35.81
	Min. M _x	12	-3206.94	-20.61	-35.81
	Min. M _z	20	-3622.12	40.46	0.02
	Min. Torsion	22	-3.37	28.78	16.94

Tower Mast Reaction Summary

Load Combination	Vertical K	Shear _x K	Shear _z K	Overturning Moment, M _x kip-ft	Overturning Moment, M _z kip-ft	Torque kip-ft
Dead Only	42.25	0.00	0.00	2.02	-1.55	-0.00
1.2 Dead+1.0 Wind 0 deg - No Ice	50.70	0.00	-32.23	-3180.29	-2.32	1.70
0.9 Dead+1.0 Wind 0 deg - No Ice	38.02	0.00	-32.23	-3136.14	-1.80	1.69
1.2 Dead+1.0 Wind 30 deg - No Ice	50.70	16.32	-28.69	-2805.13	-1592.10	0.41
0.9 Dead+1.0 Wind 30 deg - No Ice	38.02	16.32	-28.69	-2766.43	-1569.35	0.41
1.2 Dead+1.0 Wind 60 deg - No Ice	50.70	27.32	-16.10	-1591.25	-2691.57	-0.51
0.9 Dead+1.0 Wind 60 deg - No Ice	38.02	27.32	-16.10	-1569.41	-2653.22	-0.50
1.2 Dead+1.0 Wind 90 deg - No Ice	50.70	40.53	0.21	29.97	-3635.62	0.76
0.9 Dead+1.0 Wind 90 deg - No Ice	38.02	40.53	0.21	28.88	-3586.22	0.79
1.2 Dead+1.0 Wind 120 deg - No Ice	50.70	28.82	16.90	1661.35	-2818.38	-1.71
0.9 Dead+1.0 Wind 120 deg - No Ice	38.02	28.82	16.90	1637.47	-2778.52	-1.68
1.2 Dead+1.0 Wind 150 deg - No Ice	50.70	20.61	35.81	3206.94	-1844.91	-0.72
0.9 Dead+1.0 Wind 150 deg - No Ice	38.02	20.61	35.81	3163.23	-1819.62	-0.69
1.2 Dead+1.0 Wind 180 deg - No Ice	50.70	0.14	32.23	3184.17	-20.62	-0.70
0.9 Dead+1.0 Wind 180 deg - No Ice	38.02	0.14	32.23	3138.75	-19.79	-0.68
1.2 Dead+1.0 Wind 210 deg - No Ice	50.70	-16.25	28.72	2813.65	1578.70	0.87
0.9 Dead+1.0 Wind 210 deg - No Ice	38.02	-16.25	28.72	2773.60	1557.16	0.88
1.2 Dead+1.0 Wind 240 deg - No Ice	50.70	-27.36	15.88	1567.79	2692.70	1.21
0.9 Dead+1.0 Wind 240 deg - No Ice	38.02	-27.36	15.88	1545.12	2655.32	1.19
1.2 Dead+1.0 Wind 270 deg - No Ice	50.70	-40.46	-0.02	0.42	3622.12	0.33
0.9 Dead+1.0 Wind 270 deg - No Ice	38.02	-40.46	-0.02	-0.19	3573.91	0.31
1.2 Dead+1.0 Wind 300 deg - No Ice	50.70	-28.78	-16.94	-1661.91	2809.12	3.37
0.9 Dead+1.0 Wind 300 deg - No Ice	38.02	-28.78	-16.94	-1639.24	2770.39	3.34

Load Combination	Vertical K	Shear _x K	Shear _z K	Overturning Moment, M _x kip-ft	Overturning Moment, M _z kip-ft	Torque kip-ft
- No Ice						
1.2 Dead+1.0 Wind 330 deg	50.70	-20.48	-35.87	-3210.90	1824.59	1.95
- No Ice						
0.9 Dead+1.0 Wind 330 deg	38.02	-20.48	-35.87	-3168.32	1800.60	1.93
- No Ice						
1.2 Dead+1.0 Ice+1.0 Temp	81.19	0.00	0.00	6.86	-4.00	-0.00
1.2 Dead+1.0 Wind 0 deg+1.0 Ice+1.0 Temp	81.19	0.00	-8.28	-823.96	-4.15	0.50
1.2 Dead+1.0 Wind 30 deg+1.0 Ice+1.0 Temp	81.19	4.09	-7.17	-713.08	-413.26	0.01
1.2 Dead+1.0 Wind 60 deg+1.0 Ice+1.0 Temp	81.19	7.10	-4.16	-411.60	-713.99	-0.37
1.2 Dead+1.0 Wind 90 deg+1.0 Ice+1.0 Temp	81.19	9.35	0.04	12.87	-897.80	-0.15
1.2 Dead+1.0 Wind 120 deg+1.0 Ice+1.0 Temp	81.19	7.21	4.21	430.55	-725.68	-0.75
1.2 Dead+1.0 Wind 150 deg+1.0 Ice+1.0 Temp	81.19	4.67	8.11	785.71	-452.22	-0.51
1.2 Dead+1.0 Wind 180 deg+1.0 Ice+1.0 Temp	81.19	0.03	8.28	837.66	-8.07	-0.29
1.2 Dead+1.0 Wind 210 deg+1.0 Ice+1.0 Temp	81.19	-4.08	7.18	727.78	403.09	0.24
1.2 Dead+1.0 Wind 240 deg+1.0 Ice+1.0 Temp	81.19	-7.10	4.12	419.43	706.94	0.51
1.2 Dead+1.0 Wind 270 deg+1.0 Ice+1.0 Temp	81.19	-9.33	-0.00	6.53	887.59	0.38
1.2 Dead+1.0 Wind 300 deg+1.0 Ice+1.0 Temp	81.19	-7.20	-4.22	-417.80	716.40	1.10
1.2 Dead+1.0 Wind 330 deg+1.0 Ice+1.0 Temp	81.19	-4.64	-8.12	-773.69	440.57	0.76
Dead+Wind 0 deg - Service	42.25	0.00	-7.72	-754.41	-1.73	0.41
Dead+Wind 30 deg - Service	42.25	3.91	-6.87	-665.27	-379.61	0.09
Dead+Wind 60 deg - Service	42.25	6.54	-3.86	-376.70	-640.87	-0.13
Dead+Wind 90 deg - Service	42.25	9.71	0.05	8.60	-865.76	0.18
Dead+Wind 120 deg - Service	42.25	6.90	4.05	396.38	-671.12	-0.41
Dead+Wind 150 deg - Service	42.25	4.94	8.57	764.17	-439.94	-0.17
Dead+Wind 180 deg - Service	42.25	0.03	7.72	758.30	-6.07	-0.17
Dead+Wind 210 deg - Service	42.25	-3.89	6.88	670.26	374.09	0.21
Dead+Wind 240 deg - Service	42.25	-6.55	3.80	374.08	638.79	0.30
Dead+Wind 270 deg - Service	42.25	-9.69	-0.00	1.58	860.19	0.09
Dead+Wind 300 deg - Service	42.25	-6.89	-4.06	-393.56	666.57	0.82
Dead+Wind 330 deg - Service	42.25	-4.91	-8.59	-762.15	432.76	0.48

Solution Summary

Load Comb.	Sum of Applied Forces			Sum of Reactions			% Error
	PX K	PY K	PZ K	PX K	PY K	PZ K	
1	0.00	-42.25	0.00	0.00	42.25	0.00	0.000%
2	0.00	-50.70	-32.23	-0.00	50.70	32.23	0.000%
3	0.00	-38.02	-32.23	-0.00	38.02	32.23	0.000%
4	16.32	-50.70	-28.69	-16.32	50.70	28.69	0.000%
5	16.32	-38.02	-28.69	-16.32	38.02	28.69	0.000%
6	27.32	-50.70	-16.10	-27.32	50.70	16.10	0.000%
7	27.32	-38.02	-16.10	-27.32	38.02	16.10	0.000%
8	40.53	-50.70	0.21	-40.53	50.70	-0.21	0.000%
9	40.53	-38.02	0.21	-40.53	38.02	-0.21	0.000%
10	28.82	-50.70	16.90	-28.82	50.70	-16.90	0.000%

Load Comb.	Sum of Applied Forces			Sum of Reactions			% Error
	PX K	PY K	PZ K	PX K	PY K	PZ K	
11	28.82	-38.02	16.90	-28.82	38.02	-16.90	0.000%
12	20.61	-50.70	35.81	-20.61	50.70	-35.81	0.000%
13	20.61	-38.02	35.81	-20.61	38.02	-35.81	0.000%
14	0.14	-50.70	32.23	-0.14	50.70	-32.23	0.000%
15	0.14	-38.02	32.23	-0.14	38.02	-32.23	0.000%
16	-16.25	-50.70	28.72	16.25	50.70	-28.72	0.000%
17	-16.25	-38.02	28.72	16.25	38.02	-28.72	0.000%
18	-27.36	-50.70	15.88	27.36	50.70	-15.88	0.000%
19	-27.36	-38.02	15.88	27.36	38.02	-15.88	0.000%
20	-40.46	-50.70	-0.02	40.46	50.70	0.02	0.000%
21	-40.46	-38.02	-0.02	40.46	38.02	0.02	0.000%
22	-28.78	-50.70	-16.94	28.78	50.70	16.94	0.000%
23	-28.78	-38.02	-16.94	28.78	38.02	16.94	0.000%
24	-20.48	-50.70	-35.87	20.48	50.70	35.87	0.000%
25	-20.48	-38.02	-35.87	20.48	38.02	35.87	0.000%
26	0.00	-81.19	0.00	-0.00	81.19	-0.00	0.000%
27	0.00	-81.19	-8.28	-0.00	81.19	8.28	0.000%
28	4.09	-81.19	-7.17	-4.09	81.19	7.17	0.000%
29	7.10	-81.19	-4.16	-7.10	81.19	4.16	0.000%
30	9.35	-81.19	0.04	-9.35	81.19	-0.04	0.000%
31	7.21	-81.19	4.21	-7.21	81.19	-4.21	0.000%
32	4.67	-81.19	8.11	-4.67	81.19	-8.11	0.000%
33	0.03	-81.19	8.28	-0.03	81.19	-8.28	0.000%
34	-4.08	-81.19	7.18	4.08	81.19	-7.18	0.000%
35	-7.10	-81.19	4.12	7.10	81.19	-4.12	0.000%
36	-9.33	-81.19	-0.00	9.33	81.19	0.00	0.000%
37	-7.20	-81.19	-4.22	7.20	81.19	4.22	0.000%
38	-4.64	-81.19	-8.12	4.64	81.19	8.12	0.000%
39	0.00	-42.25	-7.72	-0.00	42.25	7.72	0.000%
40	3.91	-42.25	-6.87	-3.91	42.25	6.87	0.000%
41	6.54	-42.25	-3.86	-6.54	42.25	3.86	0.000%
42	9.71	-42.25	0.05	-9.71	42.25	-0.05	0.000%
43	6.90	-42.25	4.05	-6.90	42.25	-4.05	0.000%
44	4.94	-42.25	8.57	-4.94	42.25	-8.57	0.000%
45	0.03	-42.25	7.72	-0.03	42.25	-7.72	0.000%
46	-3.89	-42.25	6.88	3.89	42.25	-6.88	0.000%
47	-6.55	-42.25	3.80	6.55	42.25	-3.80	0.000%
48	-9.69	-42.25	-0.00	9.69	42.25	0.00	0.000%
49	-6.89	-42.25	-4.06	6.89	42.25	4.06	0.000%
50	-4.91	-42.25	-8.59	4.91	42.25	8.59	0.000%

Non-Linear Convergence Results

Load Combination	Converged?	Number of Cycles	Displacement Tolerance	Force Tolerance
1	Yes	4	0.00000001	0.00001119
2	Yes	7	0.00000001	0.00017117
3	Yes	6	0.00000001	0.00089914
4	Yes	8	0.00000001	0.00022668
5	Yes	7	0.00000001	0.00083953
6	Yes	8	0.00000001	0.00022211
7	Yes	7	0.00000001	0.00082648
8	Yes	7	0.00000001	0.00008564
9	Yes	6	0.00000001	0.00043181
10	Yes	8	0.00000001	0.00022424
11	Yes	7	0.00000001	0.00082528
12	Yes	8	0.00000001	0.00025106
13	Yes	7	0.00000001	0.00090127
14	Yes	7	0.00000001	0.00013808
15	Yes	6	0.00000001	0.00070731
16	Yes	8	0.00000001	0.00022758
17	Yes	7	0.00000001	0.00084369
18	Yes	8	0.00000001	0.00021374
19	Yes	7	0.00000001	0.00079481
20	Yes	7	0.00000001	0.00012114

21	Yes	6	0.00000001	0.00062986
22	Yes	8	0.00000001	0.00024365
23	Yes	7	0.00000001	0.00089937
24	Yes	8	0.00000001	0.00023675
25	Yes	7	0.00000001	0.00084778
26	Yes	6	0.00000001	0.00013646
27	Yes	8	0.00000001	0.00022138
28	Yes	8	0.00000001	0.00035329
29	Yes	8	0.00000001	0.00035688
30	Yes	8	0.00000001	0.00023262
31	Yes	8	0.00000001	0.00036123
32	Yes	8	0.00000001	0.00040344
33	Yes	8	0.00000001	0.00022272
34	Yes	8	0.00000001	0.00035139
35	Yes	8	0.00000001	0.00034446
36	Yes	8	0.00000001	0.00023026
37	Yes	8	0.00000001	0.00036949
38	Yes	8	0.00000001	0.00037432
39	Yes	6	0.00000001	0.00015004
40	Yes	6	0.00000001	0.00089177
41	Yes	6	0.00000001	0.00085305
42	Yes	5	0.00000001	0.00092311
43	Yes	6	0.00000001	0.00086712
44	Yes	7	0.00000001	0.00006813
45	Yes	6	0.00000001	0.00008867
46	Yes	6	0.00000001	0.00089959
47	Yes	6	0.00000001	0.00076986
48	Yes	6	0.00000001	0.00012065
49	Yes	7	0.00000001	0.00006171
50	Yes	7	0.00000001	0.00005837

Maximum Tower Deflections - Service Wind

Section No.	Elevation ft	Horz. Deflection in	Gov. Load Comb.	Tilt °	Twist °
L1	125 - 120	24.335	44	1.6971	0.0103
L2	120 - 115	22.563	44	1.6852	0.0092
L3	115 - 110	20.812	44	1.6567	0.0082
L4	110 - 105	19.102	44	1.6063	0.0072
L5	105 - 100	17.455	44	1.5371	0.0064
L6	100 - 99.375	15.890	44	1.4484	0.0049
L7	99.375 - 99.125	15.701	44	1.4359	0.0047
L8	99.125 - 94.46	15.626	44	1.4335	0.0047
L9	94.46 - 94.21	14.249	44	1.3847	0.0041
L10	94.21 - 89.21	14.177	44	1.3828	0.0041
L11	89.21 - 89	12.751	44	1.3386	0.0037
L12	89 - 85.04	12.693	44	1.3367	0.0037
L13	88.957 - 84.04	12.681	44	1.3363	0.0037
L14	84.04 - 79.04	11.318	44	1.3049	0.0034
L15	79.04 - 74.04	9.985	44	1.2397	0.0030
L16	74.04 - 73.5	8.724	44	1.1679	0.0027
L17	73.5 - 73.25	8.593	44	1.1599	0.0027
L18	73.25 - 73	8.532	44	1.1570	0.0026
L19	73 - 72.75	8.471	44	1.1541	0.0026
L20	72.75 - 67.75	8.411	44	1.1494	0.0026
L21	67.75 - 63	7.257	44	1.0538	0.0022
L22	63 - 62.75	6.256	44	0.9586	0.0019
L23	62.75 - 57.75	6.206	44	0.9553	0.0019
L24	57.75 - 57.5	5.241	44	0.8868	0.0017
L25	57.5 - 57.33	5.195	44	0.8839	0.0017
L26	57.33 - 57.08	5.164	44	0.8819	0.0016
L27	57.08 - 52.08	5.118	44	0.8776	0.0016
L28	52.08 - 47.08	4.244	44	0.7905	0.0014
L29	47.08 - 40.457	3.463	44	0.7017	0.0012
L30	45.54 - 39.457	3.241	44	0.6742	0.0011
L31	39.457 - 37.75	2.415	44	0.6145	0.0010
L32	37.75 - 37.5	2.201	44	0.5868	0.0009

Section No.	Elevation ft	Horz. Deflection in	Gov. Load Comb.	Tilt °	Twist °
L33	37.5 - 32.5	2.170	44	0.5826	0.0009
L34	32.5 - 27.5	1.604	44	0.4994	0.0008
L35	27.5 - 22.5	1.125	44	0.4156	0.0006
L36	22.5 - 17.5	0.733	44	0.3316	0.0005
L37	17.5 - 12.5	0.430	44	0.2486	0.0003
L38	12.5 - 12.25	0.213	44	0.1644	0.0002
L39	12.25 - 12	0.205	44	0.1602	0.0002
L40	12 - 7	0.197	44	0.1570	0.0002
L41	7 - 2	0.067	44	0.0911	0.0001
L42	2 - 0	0.005	44	0.0262	0.0000

Critical Deflections and Radius of Curvature - Service Wind

Elevation ft	Appurtenance	Gov. Load Comb.	Deflection in	Tilt °	Twist °	Radius of Curvature ft
125.00	APXVTM14-C-120 w/ Mount Pipe	44	24.335	1.6971	0.0103	13990
124.00	VHLP2-18	44	23.979	1.6953	0.0100	13990
123.00	TME-PCS 1900MHz 4x45W-65MHz	44	23.625	1.6934	0.0098	13990
115.00	HPA-65R-BUU-H6 w/ Mount Pipe	44	20.812	1.6567	0.0082	7371
105.00	(2) JAHH-45B-R3B w/ Mount Pipe	44	17.455	1.5371	0.0064	3641
94.00	MX08FRO665-21 w/ Mount Pipe	44	14.116	1.3811	0.0041	6039
84.00	8' x 2" Mount Pipe	44	11.307	1.3046	0.0034	5585

Maximum Tower Deflections - Design Wind

Section No.	Elevation ft	Horz. Deflection in	Gov. Load Comb.	Tilt °	Twist °
L1	125 - 120	102.102	12	7.1426	0.0407
L2	120 - 115	94.675	12	7.0924	0.0363
L3	115 - 110	87.337	12	6.9728	0.0324
L4	110 - 105	80.169	12	6.7605	0.0287
L5	105 - 100	73.263	12	6.4692	0.0256
L6	100 - 99.375	66.699	12	6.0947	0.0195
L7	99.375 - 99.125	65.907	12	6.0417	0.0188
L8	99.125 - 94.46	65.592	12	6.0319	0.0187
L9	94.46 - 94.21	59.815	12	5.8260	0.0164
L10	94.21 - 89.21	59.511	12	5.8177	0.0164
L11	89.21 - 89	53.531	12	5.6316	0.0147
L12	89 - 85.04	53.285	12	5.6233	0.0147
L13	88.957 - 84.04	53.234	12	5.6218	0.0147
L14	84.04 - 79.04	47.515	12	5.4895	0.0138
L15	79.04 - 74.04	41.923	12	5.2146	0.0123
L16	74.04 - 73.5	36.631	12	4.9121	0.0109
L17	73.5 - 73.25	36.078	12	4.8786	0.0107
L18	73.25 - 73	35.824	12	4.8663	0.0107
L19	73 - 72.75	35.570	12	4.8540	0.0106
L20	72.75 - 67.75	35.317	12	4.8343	0.0105
L21	67.75 - 63	30.473	12	4.4315	0.0090
L22	63 - 62.75	26.270	12	4.0304	0.0076
L23	62.75 - 57.75	26.059	12	4.0165	0.0076
L24	57.75 - 57.5	22.009	12	3.7282	0.0067
L25	57.5 - 57.33	21.814	12	3.7158	0.0067
L26	57.33 - 57.08	21.682	12	3.7074	0.0067
L27	57.08 - 52.08	21.489	12	3.6894	0.0066
L28	52.08 - 47.08	17.821	12	3.3228	0.0057

Section No.	Elevation ft	Horz. Deflection in	Gov. Load Comb.	Tilt °	Twist °
L29	47.08 - 40.457	14.540	12	2.9487	0.0048
L30	45.54 - 39.457	13.608	12	2.8333	0.0045
L31	39.457 - 37.75	10.142	12	2.5822	0.0040
L32	37.75 - 37.5	9.240	12	2.4653	0.0038
L33	37.5 - 32.5	9.111	12	2.4480	0.0037
L34	32.5 - 27.5	6.733	12	2.0977	0.0031
L35	27.5 - 22.5	4.721	12	1.7457	0.0025
L36	22.5 - 17.5	3.078	12	1.3927	0.0019
L37	17.5 - 12.5	1.803	12	1.0436	0.0014
L38	12.5 - 12.25	0.896	12	0.6900	0.0009
L39	12.25 - 12	0.860	12	0.6725	0.0009
L40	12 - 7	0.825	12	0.6589	0.0008
L41	7 - 2	0.280	12	0.3823	0.0005
L42	2 - 0	0.023	12	0.1100	0.0001

Critical Deflections and Radius of Curvature - Design Wind

Elevation ft	Appurtenance	Gov. Load Comb.	Deflection in	Tilt °	Twist °	Radius of Curvature ft
125.00	APXVTM14-C-120 w/ Mount Pipe	12	102.102	7.1426	0.0407	3426
124.00	VHLP2-18	12	100.613	7.1351	0.0398	3426
123.00	TME-PCS 1900MHz 4x45W-65MHz	12	99.126	7.1270	0.0389	3426
115.00	HPA-65R-BUU-H6 w/ Mount Pipe	12	87.337	6.9728	0.0324	1803
105.00	(2) JAHH-45B-R3B w/ Mount Pipe	12	73.263	6.4692	0.0256	888
94.00	MX08FRO665-21 w/ Mount Pipe	12	59.256	5.8108	0.0163	1468
84.00	8' x 2" Mount Pipe	12	47.469	5.4880	0.0138	1352

Compression Checks

Pole Design Data

Section No.	Elevation ft	Size	L ft	L _u ft	KI/r	A in ²	P _u K	φP _n K	Ratio P _u / φP _n
L1	125 - 120 (1)	TP19.5748x18.5x0.1875	5.00	0.00	0.0	11.5379	-3.56	674.97	0.005
L2	120 - 115 (2)	TP20.6497x19.5748x0.1875	5.00	0.00	0.0	12.1775	-3.85	712.39	0.005
L3	115 - 110 (3)	TP21.7245x20.6497x0.1875	5.00	0.00	0.0	12.8172	-7.50	749.81	0.010
L4	110 - 105 (4)	TP22.7993x21.7245x0.1875	5.00	0.00	0.0	13.4568	-7.94	787.23	0.010
L5	105 - 100 (5)	TP23.8741x22.7993x0.1875	5.00	0.00	0.0	14.0965	-14.76	824.64	0.018
L6	100 - 99.375 (6)	TP24.0085x23.8741x0.1875	0.63	0.00	0.0	14.1765	-14.84	829.32	0.018
L7	99.375 - 99.125 (7)	TP24.0622x24.0085x0.425	0.25	0.00	0.0	31.8854	-14.88	1865.30	0.008
L8	99.125 - 94.46 (8)	TP25.065x24.0622x0.4125	4.66	0.00	0.0	32.2769	-15.65	1888.20	0.008
L9	94.46 - 94.21 (9)	TP25.1188x25.065x0.6	0.25	0.00	0.0	46.6935	-15.72	2731.57	0.006
L10	94.21 - 89.21	TP26.1936x25.1188x0.57	5.00	0.00	0.0	46.755	-19.17	2735.18	0.007

Section No.	Elevation ft	Size	L ft	L _u ft	KI/r	A in ²	P _u K	φP _n K	Ratio P _u / φP _n
L11	(10) 89.21 - 89	5 TP26.2387x26.1936x0.57	0.21	0.00	0.0	2 46.837	-19.22	2740.00	0.007
L12	(11) 89 - 85.04	5 TP27.09x26.2387x0.6625	3.96	0.00	0.0	6 53.800	-19.23	3147.33	0.006
L13	(12) 85.04 - 84.04	5 TP26.9179x25.873x0.5	4.92	0.00	0.0	5 41.925	-20.99	2452.63	0.009
L14	(13) 84.04 - 79.04	2 TP27.9805x26.9179x0.48	5.00	0.00	0.0	2 42.540	-25.39	2488.63	0.010
L15	(14) 79.04 - 74.04	75 TP29.0431x27.9805x0.47	5.00	0.00	0.0	6 43.070	-26.57	2519.63	0.011
L16	(15) 74.04 - 73.5	5 TP29.1578x29.0431x0.47	0.54	0.00	0.0	7 43.243	-26.71	2529.76	0.011
L17	(16) 73.5 - 73.25	5 TP29.211x29.1578x0.612	0.25	0.00	0.0	7 55.597	-26.78	3252.46	0.008
L18	(17) 73.25 - 73	5 TP29.2641x29.211x0.612	0.25	0.00	0.0	6 55.700	-26.85	3258.50	0.008
L19	(18) 73 - 72.75	5 TP29.3172x29.2641x0.37	0.25	0.00	0.0	9 34.448	-26.90	2015.24	0.013
L20	(19) 72.75 - 67.75	5 TP30.3798x29.3172x0.37	5.00	0.00	0.0	5 35.713	-28.01	2089.22	0.013
L21	(20) 67.75 - 63	5 TP31.3893x30.3798x0.36	4.75	0.00	0.0	2 36.306	-29.10	2123.95	0.014
L22	(21) 63 - 62.75	88 TP31.4424x31.3893x0.57	0.25	0.00	0.0	8 56.334	-29.20	3295.57	0.009
L23	(22) 63 - 62.75	5 TP32.505x31.4424x0.562	5.00	0.00	0.0	5 57.029	-30.65	3336.21	0.009
L24	(23) 62.75 - 57.75	5 TP32.5581x32.505x0.662	0.25	0.00	0.0	3 67.069	-30.75	3923.55	0.008
L25	(24) 57.75 - 57.33	5 TP32.5942x32.5581x0.66	0.17	0.00	0.0	3 67.145	-30.80	3928.00	0.008
L26	(25) 57.33 - 57.08	25 TP32.6473x32.5942x0.45	0.25	0.00	0.0	2 45.987	-30.87	2690.27	0.011
L27	(26) 57.08 - 52.08	5 TP33.7099x32.6473x0.44	5.00	0.00	0.0	5 46.854	-32.19	2740.97	0.012
L28	(27) 52.08 - 47.08	38 TP34.7725x33.7099x0.43	5.00	0.00	0.0	2 47.678	-33.56	2789.19	0.012
L29	(28) 47.08 - 40.457	75 TP36.18x34.7725x0.4375	6.62	0.00	0.0	5 48.132	-33.98	2815.78	0.012
L30	(29) 40.457 - 39.457	9 TP35.8888x34.5998x0.5	6.08	0.00	0.0	9 56.162	-36.70	3285.48	0.011
L31	(30) 39.457 - 37.75	0 TP36.2505x35.8888x0.49	1.71	0.00	0.0	0 56.036	-37.22	3278.15	0.011
L32	(31) 37.75 - 37.5	38 TP36.3035x36.2505x0.49	0.25	0.00	0.0	7 56.119	-37.33	3283.00	0.011
L33	(32) 37.5 - 32.5	38 TP37.363x36.3035x0.487	5.00	0.00	0.0	7 57.058	-38.88	3337.92	0.012
L34	(33) 32.5 - 27.5	5 TP38.4226x37.363x0.481	5.00	0.00	0.0	4 57.954	-40.49	3390.36	0.012
L35	(34) 27.5 - 22.5	3 TP39.4821x38.4226x0.47	5.00	0.00	0.0	9 58.809	-42.13	3440.33	0.012
L36	(35) 22.5 - 17.5	5 TP40.5416x39.4821x0.47	5.00	0.00	0.0	1 60.406	-43.80	3533.78	0.012
L37	(36) 17.5 - 12.5	5 TP41.6012x40.5416x0.46	5.00	0.00	0.0	5 60.390	-45.50	3532.85	0.013
L38	(37) 12.5 - 12.25	25 TP41.6541x41.6012x0.46	0.25	0.00	0.0	5 60.468	-45.61	3537.40	0.013
L39	(38) 12.25 - 12	25 TP41.7071x41.6541x0.6	0.25	0.00	0.0	3 78.284	-45.72	4579.64	0.010
L40	(39) 12 - 7	4 TP42.7667x41.7071x0.58	5.00	0.00	0.0	4 78.652	-47.84	4601.17	0.010
L41	(40) 7 - 2	75 TP43.8262x42.7667x0.58	5.00	0.00	0.0	5 80.628	-49.88	4716.75	0.011
L42	(41) 2 - 0	75 TP44.25x43.8262x0.575	2.00	0.00	0.0	3 79.709	-50.68	4662.98	0.011
	(42)					1			

Pole Bending Design Data

Section No.	Elevation ft	Size	M_{ux}	ϕM_{nx}	Ratio	M_{uy}	ϕM_{ny}	Ratio
			kip-ft	kip-ft	$\frac{M_{ux}}{\phi M_{nx}}$	kip-ft	kip-ft	$\frac{M_{uy}}{\phi M_{ny}}$
L1	125 - 120 (1)	TP19.5748x18.5x0.1875	33.82	334.00	0.101	0.00	334.00	0.000
L2	120 - 115 (2)	TP20.6497x19.5748x0.1875	67.23	366.78	0.183	0.00	366.78	0.000
L3	115 - 110 (3)	TP21.7245x20.6497x0.1875	135.17	400.45	0.338	0.00	400.45	0.000
L4	110 - 105 (4)	TP22.7993x21.7245x0.1875	197.50	434.92	0.454	0.00	434.92	0.000
L5	105 - 100 (5)	TP23.8741x22.7993x0.1875	296.75	470.09	0.631	0.00	470.09	0.000
L6	100 - 99.375 (6)	TP24.0085x23.8741x0.1875	309.36	474.53	0.652	0.00	474.53	0.000
L7	99.375 - 99.125 (7)	TP24.0622x24.0085x0.425	314.43	1139.99	0.276	0.00	1139.99	0.000
L8	99.125 - 94.46 (8)	TP25.065x24.0622x0.4125	410.84	1205.03	0.341	0.00	1205.03	0.000
L9	94.46 - 94.21 (9)	TP25.1188x25.065x0.6	416.11	1720.71	0.242	0.00	1720.71	0.000
L10	94.21 - 89.21 (10)	TP26.1936x25.1188x0.575	537.64	1803.84	0.298	0.00	1803.84	0.000
L11	89.21 - 89 (11)	TP26.2387x26.1936x0.575	542.77	1810.28	0.300	0.00	1810.28	0.000
L12	89 - 85.04 (12)	TP27.09x26.2387x0.6625	543.82	2066.00	0.263	0.00	2066.00	0.000
L13	85.04 - 84.04 (13)	TP26.9179x25.873x0.5	666.72	1673.72	0.398	0.00	1673.72	0.000
L14	84.04 - 79.04 (14)	TP27.9805x26.9179x0.4875	816.84	1769.47	0.462	0.00	1769.47	0.000
L15	79.04 - 74.04 (15)	TP29.0431x27.9805x0.475	971.13	1863.60	0.521	0.00	1863.60	0.000
L16	74.04 - 73.5 (16)	TP29.1578x29.0431x0.475	988.04	1878.72	0.526	0.00	1878.72	0.000
L17	73.5 - 73.25 (17)	TP29.211x29.1578x0.6125	995.88	2396.88	0.415	0.00	2396.88	0.000
L18	73.25 - 73 (18)	TP29.2641x29.211x0.6125	1003.73	2405.89	0.417	0.00	2405.89	0.000
L19	73 - 72.75 (19)	TP29.3172x29.2641x0.375	1011.60	1515.53	0.667	0.00	1515.53	0.000
L20	72.75 - 67.75 (20)	TP30.3798x29.3172x0.375	1170.83	1629.59	0.718	0.00	1629.59	0.000
L21	67.75 - 63 (21)	TP31.3893x30.3798x0.3688	1325.58	1713.78	0.773	0.00	1713.78	0.000
L22	63 - 62.75 (22)	TP31.4424x31.3893x0.575	1333.82	2628.52	0.507	0.00	2628.52	0.000
L23	62.75 - 57.75 (23)	TP32.505x31.4424x0.5625	1500.87	2756.37	0.545	0.00	2756.37	0.000
L24	57.75 - 57.5 (24)	TP32.5581x32.505x0.6625	1509.33	3226.84	0.468	0.00	3226.84	0.000
L25	57.5 - 57.33 (25)	TP32.5942x32.5581x0.6625	1515.10	3234.23	0.468	0.00	3234.23	0.000
L26	57.33 - 57.08 (26)	TP32.6473x32.5942x0.45	1523.58	2248.45	0.678	0.00	2248.45	0.000
L27	57.08 - 52.08 (27)	TP33.7099x32.6473x0.4438	1695.33	2368.37	0.716	0.00	2368.37	0.000
L28	52.08 - 47.08 (28)	TP34.7725x33.7099x0.4375	1870.89	2488.93	0.752	0.00	2488.93	0.000
L29	47.08 - 40.457 (29)	TP36.18x34.7725x0.4375	1925.72	2536.91	0.759	0.00	2536.91	0.000
L30	40.457 - 39.457 (30)	TP35.8888x34.5998x0.5	2146.28	3017.64	0.711	0.00	3017.64	0.000
L31	39.457 - 37.75 (31)	TP36.2505x35.8888x0.4938	2209.28	3043.18	0.726	0.00	3043.18	0.000
L32	37.75 - 37.5 (32)	TP36.3035x36.2505x0.4938	2218.54	3052.26	0.727	0.00	3052.26	0.000
L33	37.5 - 32.5 (33)	TP37.363x36.3035x0.4875	2405.72	3197.47	0.752	0.00	3197.47	0.000
L34	32.5 - 27.5	TP38.4226x37.363x0.481	2596.42	3343.34	0.777	0.00	3343.34	0.000

Section No.	Elevation ft	Size	M_{ux} kip-ft	ϕM_{nx} kip-ft	Ratio $\frac{M_{ux}}{\phi M_{nx}}$	M_{uy} kip-ft	ϕM_{ny} kip-ft	Ratio $\frac{M_{uy}}{\phi M_{ny}}$
L35	(34) 27.5 - 22.5	3 TP39.4821x38.4226x0.47	2790.46	3489.67	0.800	0.00	3489.67	0.000
L36	(35) 22.5 - 17.5	5 TP40.5416x39.4821x0.47	2987.68	3682.98	0.811	0.00	3682.98	0.000
L37	(36) 17.5 - 12.5	5 TP41.6012x40.5416x0.46	3187.85	3782.82	0.843	0.00	3782.82	0.000
L38	(37) 12.5 - 12.25	25 TP41.6541x41.6012x0.46	3197.93	3792.63	0.843	0.00	3792.63	0.000
L39	(38) 12.25 - 12	25 TP41.7071x41.6541x0.6	3208.03	4883.73	0.657	0.00	4883.73	0.000
L40	(39) 12 - 7 (40)	75 TP42.7667x41.7071x0.58	3411.53	5037.97	0.677	0.00	5037.97	0.000
L41	(41) 7 - 2 (41)	75 TP43.8262x42.7667x0.58	3617.19	5296.03	0.683	0.00	5296.03	0.000
L42	(42) 2 - 0 (42)	575 TP44.25x43.8262x0.575	3699.76	5290.69	0.699	0.00	5290.69	0.000

Pole Shear Design Data

Section No.	Elevation ft	Size	Actual V_u K	ϕV_n K	Ratio $\frac{V_u}{\phi V_n}$	Actual T_u kip-ft	ϕT_n kip-ft	Ratio $\frac{T_u}{\phi T_n}$
L1	125 - 120 (1)	TP19.5748x18.5x0.1875	6.52	202.49	0.032	0.48	343.80	0.001
L2	120 - 115 (2)	TP20.6497x19.5748x0.1875	6.84	213.72	0.032	0.48	382.97	0.001
L3	115 - 110 (3)	TP21.7245x20.6497x0.1875	12.32	224.94	0.055	0.89	424.26	0.002
L4	110 - 105 (4)	TP22.7993x21.7245x0.1875	12.64	236.17	0.054	0.89	467.67	0.002
L5	105 - 100 (5)	TP23.8741x22.7993x0.1875	20.17	247.39	0.082	2.60	513.18	0.005
L6	100 - 99.375 (6)	TP24.0085x23.8741x0.1875	20.26	248.80	0.081	2.59	519.02	0.005
L7	99.375 - 99.125 (7)	TP24.0622x24.0085x0.425	20.30	559.59	0.036	2.59	1158.37	0.002
L8	99.125 - 94.46 (8)	TP25.065x24.0622x0.4125	21.10	566.46	0.037	2.57	1222.96	0.002
L9	94.46 - 94.21 (9)	TP25.1188x25.065x0.6	21.14	819.47	0.026	2.57	1759.59	0.001
L10	94.21 - 89.21 (10)	TP26.1936x25.1188x0.575	24.46	820.55	0.030	2.66	1840.95	0.001
L11	89.21 - 89 (11)	TP26.2387x26.1936x0.575	24.49	822.00	0.030	2.65	1847.45	0.001
L12	89 - 85.04 (12)	TP27.09x26.2387x0.6625	24.50	944.20	0.026	2.65	2115.62	0.001
L13	85.04 - 84.04 (13)	TP26.9179x25.873x0.5	25.46	735.79	0.035	1.39	1702.28	0.001
L14	84.04 - 79.04 (14)	TP27.9805x26.9179x0.4875	30.44	746.59	0.041	1.35	1797.56	0.001
L15	79.04 - 74.04 (15)	TP29.0431x27.9805x0.475	31.24	755.89	0.041	1.32	1891.13	0.001
L16	74.04 - 73.5 (16)	TP29.1578x29.0431x0.475	31.32	758.93	0.041	1.31	1906.35	0.001
L17	73.5 - 73.25 (17)	TP29.211x29.1578x0.6125	31.36	975.74	0.032	1.31	2443.74	0.001
L18	73.25 - 73 (18)	TP29.2641x29.211x0.6125	31.40	977.55	0.032	1.31	2452.83	0.001
L19	73 - 72.75 (19)	TP29.3172x29.2641x0.375	31.44	604.57	0.052	1.30	1532.36	0.001
L20	72.75 - 67.75 (20)	TP30.3798x29.3172x0.375	32.21	626.77	0.051	1.27	1646.93	0.001
L21	67.75 - 63 (21)	TP31.3893x30.3798x0.3688	32.93	637.18	0.052	1.23	1730.98	0.001
L22	63 - 62.75 (22)	TP31.4424x31.3893x0.575	32.95	988.67	0.033	1.22	2672.58	0.000

Section No.	Elevation ft	Size	Actual V_u K	ϕV_n K	Ratio V_u ϕV_n	Actual T_u kip-ft	ϕT_n kip-ft	Ratio T_u ϕT_n
L23	62.75 - 57.75 (23)	TP32.505x31.4424x0.562 5	33.82	1000.86	0.034	1.19	2799.78	0.000
L24	57.75 - 57.5 (24)	TP32.5581x32.505x0.662 5	33.86	1177.07	0.029	1.18	3287.84	0.000
L25	57.5 - 57.33 (25)	TP32.5942x32.5581x0.66 25	33.89	1178.40	0.029	1.18	3295.30	0.000
L26	57.33 - 57.08 (26)	TP32.6473x32.5942x0.45	33.93	807.08	0.042	1.18	2275.71	0.001
L27	57.08 - 52.08 (27)	TP33.7099x32.6473x0.44 38	34.72	822.29	0.042	1.15	2395.57	0.000
L28	52.08 - 47.08 (28)	TP34.7725x33.7099x0.43 75	35.47	836.76	0.042	1.10	2516.03	0.000
L29	47.08 - 40.457 (29)	TP36.18x34.7725x0.4375	35.71	844.73	0.042	1.09	2564.22	0.000
L30	40.457 - 39.457 (30)	TP35.8888x34.5998x0.5	36.76	985.64	0.037	1.03	3054.68	0.000
L31	39.457 - 37.75 (31)	TP36.2505x35.8888x0.49 38	37.04	983.44	0.038	1.02	3079.56	0.000
L32	37.75 - 37.5 (32)	TP36.3035x36.2505x0.49 38	37.04	984.90	0.038	1.00	3088.69	0.000
L33	37.5 - 32.5 (33)	TP37.363x36.3035x0.487 5	37.78	1001.38	0.038	0.96	3233.82	0.000
L34	32.5 - 27.5 (34)	TP38.4226x37.363x0.481 3	38.47	1017.11	0.038	0.92	3379.56	0.000
L35	27.5 - 22.5 (35)	TP39.4821x38.4226x0.47 5	39.12	1032.10	0.038	0.87	3525.70	0.000
L36	22.5 - 17.5 (36)	TP40.5416x39.4821x0.47 5	39.73	1060.13	0.037	0.82	3719.83	0.000
L37	17.5 - 12.5 (37)	TP41.6012x40.5416x0.46 25	40.31	1059.85	0.038	0.77	3818.36	0.000
L38	12.5 - 12.25 (38)	TP41.6541x41.6012x0.46 25	40.31	1061.22	0.038	0.77	3828.19	0.000
L39	12.25 - 12 (39)	TP41.7071x41.6541x0.6	40.34	1373.89	0.029	0.76	4945.95	0.000
L40	12 - 7 (40)	TP42.7667x41.7071x0.58 75	41.00	1380.35	0.030	0.73	5098.80	0.000
L41	7 - 2 (41)	TP43.8262x42.7667x0.58 75	41.27	1415.03	0.029	0.72	5358.18	0.000
L42	2 - 0 (42)	TP44.25x43.8262x0.575	41.34	1398.89	0.030	0.72	5350.54	0.000

Pole Interaction Design Data

Section No.	Elevation ft	Ratio P_u ϕP_n	Ratio M_{ux} ϕM_{nx}	Ratio M_{uy} ϕM_{ny}	Ratio V_u ϕV_n	Ratio T_u ϕT_n	Comb. Stress Ratio	Allow. Stress Ratio	Criteria
L1	125 - 120 (1)	0.005	0.101	0.000	0.032	0.001	0.108	1.050	4.8.2
L2	120 - 115 (2)	0.005	0.183	0.000	0.032	0.001	0.190	1.050	4.8.2
L3	115 - 110 (3)	0.010	0.338	0.000	0.055	0.002	0.351	1.050	4.8.2
L4	110 - 105 (4)	0.010	0.454	0.000	0.054	0.002	0.467	1.050	4.8.2
L5	105 - 100 (5)	0.018	0.631	0.000	0.082	0.005	0.657	1.050	4.8.2
L6	100 - 99.375 (6)	0.018	0.652	0.000	0.081	0.005	0.677	1.050	4.8.2
L7	99.375 - 99.125 (7)	0.008	0.276	0.000	0.036	0.002	0.285	1.050	4.8.2
L8	99.125 - 94.46 (8)	0.008	0.341	0.000	0.037	0.002	0.351	1.050	4.8.2
L9	94.46 - 94.21 (9)	0.006	0.242	0.000	0.026	0.001	0.248	1.050	4.8.2
L10	94.21 - 89.21 (10)	0.007	0.298	0.000	0.030	0.001	0.306	1.050	4.8.2
L11	89.21 - 89 (11)	0.007	0.300	0.000	0.030	0.001	0.308	1.050	4.8.2
L12	89 - 85.04	0.006	0.263	0.000	0.026	0.001	0.270	1.050	4.8.2

Section No.	Elevation ft	Ratio	Ratio	Ratio	Ratio	Ratio	Comb. Stress Ratio	Allow. Stress Ratio	Criteria
		P_u ϕP_n	M_{ux} ϕM_{nx}	M_{uy} ϕM_{ny}	V_u ϕV_n	T_u ϕT_n			
L13	85.04 - 84.04 (12)	0.009	0.398	0.000	0.035	0.001	0.408	1.050	4.8.2
L14	84.04 - 79.04 (13)	0.010	0.462	0.000	0.041	0.001	0.474	1.050	4.8.2
L15	79.04 - 74.04 (14)	0.011	0.521	0.000	0.041	0.001	0.533	1.050	4.8.2
L16	74.04 - 73.5 (15)	0.011	0.526	0.000	0.041	0.001	0.538	1.050	4.8.2
L17	73.5 - 73.25 (16)	0.008	0.415	0.000	0.032	0.001	0.425	1.050	4.8.2
L18	73.25 - 73 (17)	0.008	0.417	0.000	0.032	0.001	0.427	1.050	4.8.2
L19	73 - 72.75 (18)	0.013	0.667	0.000	0.052	0.001	0.684	1.050	4.8.2
L20	72.75 - 67.75 (19)	0.013	0.718	0.000	0.051	0.001	0.735	1.050	4.8.2
L21	67.75 - 63 (20)	0.014	0.773	0.000	0.052	0.001	0.790	1.050	4.8.2
L22	63 - 62.75 (21)	0.009	0.507	0.000	0.033	0.000	0.517	1.050	4.8.2
L23	62.75 - 57.75 (22)	0.009	0.545	0.000	0.034	0.000	0.555	1.050	4.8.2
L24	57.75 - 57.5 (23)	0.008	0.468	0.000	0.029	0.000	0.476	1.050	4.8.2
L25	57.5 - 57.33 (24)	0.008	0.468	0.000	0.029	0.000	0.477	1.050	4.8.2
L26	57.33 - 57.08 (25)	0.011	0.678	0.000	0.042	0.001	0.691	1.050	4.8.2
L27	57.08 - 52.08 (26)	0.012	0.716	0.000	0.042	0.000	0.729	1.050	4.8.2
L28	52.08 - 47.08 (27)	0.012	0.752	0.000	0.042	0.000	0.766	1.050	4.8.2
L29	47.08 - (28)	0.012	0.759	0.000	0.042	0.000	0.773	1.050	4.8.2
L30	40.457 - (29)	0.011	0.711	0.000	0.037	0.000	0.724	1.050	4.8.2
L31	39.457 - (30)	0.011	0.726	0.000	0.038	0.000	0.739	1.050	4.8.2
L32	37.75 - 37.5 (31)	0.011	0.727	0.000	0.038	0.000	0.740	1.050	4.8.2
L33	37.5 - 32.5 (32)	0.012	0.752	0.000	0.038	0.000	0.765	1.050	4.8.2
L34	32.5 - 27.5 (33)	0.012	0.777	0.000	0.038	0.000	0.790	1.050	4.8.2
L35	27.5 - 22.5 (34)	0.012	0.800	0.000	0.038	0.000	0.813	1.050	4.8.2
L36	22.5 - 17.5 (35)	0.012	0.811	0.000	0.037	0.000	0.825	1.050	4.8.2
L37	17.5 - 12.5 (36)	0.013	0.843	0.000	0.038	0.000	0.857	1.050	4.8.2
L38	12.5 - 12.25 (37)	0.013	0.843	0.000	0.038	0.000	0.858	1.050	4.8.2
L39	12.25 - 12 (38)	0.010	0.657	0.000	0.029	0.000	0.668	1.050	4.8.2
L40	12 - 7 (40)	0.010	0.677	0.000	0.030	0.000	0.688	1.050	4.8.2
L41	7 - 2 (41)	0.011	0.683	0.000	0.029	0.000	0.694	1.050	4.8.2
L42	2 - 0 (42)	0.011	0.699	0.000	0.030	0.000	0.711	1.050	4.8.2

Section Capacity Table

Section No.	Elevation ft	Component Type	Size	Critical Element	P K	ϕP_{allow} K	% Capacity	Pass Fail	
L1	125 - 120	Pole	TP19.5748x18.5x0.1875	1	-3.56	708.71	10.3	Pass	
L2	120 - 115	Pole	TP20.6497x19.5748x0.1875	2	-3.85	748.01	18.1	Pass	
L3	115 - 110	Pole	TP21.7245x20.6497x0.1875	3	-7.50	787.30	33.4	Pass	
L4	110 - 105	Pole	TP22.7993x21.7245x0.1875	4	-7.94	826.59	44.5	Pass	
L5	105 - 100	Pole	TP23.8741x22.7993x0.1875	5	-14.76	865.88	62.5	Pass	
L6	100 - 99.375	Pole	TP24.0085x23.8741x0.1875	6	-14.84	870.79	64.5	Pass	
L7	99.375 - 99.125	Pole	TP24.0622x24.0085x0.425	7	-14.88	1958.56	27.2	Pass	
L8	99.125 - 94.46	Pole	TP25.065x24.0622x0.4125	8	-15.65	1982.61	33.4	Pass	
L9	94.46 - 94.21	Pole	TP25.1188x25.065x0.6	9	-15.72	2868.15	23.6	Pass	
L10	94.21 - 89.21	Pole	TP26.1936x25.1188x0.575	10	-19.17	2871.94	29.1	Pass	
L11	89.21 - 89	Pole	TP26.2387x26.1936x0.575	11	-19.22	2877.00	29.3	Pass	
L12	89 - 85.04	Pole	TP27.09x26.2387x0.6625	12	-19.23	3304.70	25.7	Pass	
L13	85.04 - 84.04	Pole	TP26.9179x25.873x0.5	13	-20.99	2575.26	38.9	Pass	
L14	84.04 - 79.04	Pole	TP27.9805x26.9179x0.4875	14	-25.39	2613.06	45.1	Pass	
L15	79.04 - 74.04	Pole	TP29.0431x27.9805x0.475	15	-26.57	2645.61	50.8	Pass	
L16	74.04 - 73.5	Pole	TP29.1578x29.0431x0.475	16	-26.71	2656.25	51.3	Pass	
L17	73.5 - 73.25	Pole	TP29.211x29.1578x0.6125	17	-26.78	3415.08	40.5	Pass	
L18	73.25 - 73	Pole	TP29.2641x29.211x0.6125	18	-26.85	3421.42	40.6	Pass	
L19	73 - 72.75	Pole	TP29.3172x29.2641x0.375	19	-26.90	2116.00	65.1	Pass	
L20	72.75 - 67.75	Pole	TP30.3798x29.3172x0.375	20	-28.01	2193.68	70.0	Pass	
L21	67.75 - 63	Pole	TP31.3893x30.3798x0.3688	21	-29.10	2230.15	75.2	Pass	
L22	63 - 62.75	Pole	TP31.4424x31.3893x0.575	22	-29.20	3460.35	49.3	Pass	
L23	62.75 - 57.75	Pole	TP32.505x31.4424x0.5625	23	-30.65	3503.02	52.8	Pass	
L24	57.75 - 57.5	Pole	TP32.5581x32.505x0.6625	24	-30.75	4119.73	45.4	Pass	
L25	57.5 - 57.33	Pole	TP32.5942x32.5581x0.6625	25	-30.80	4124.40	45.4	Pass	
L26	57.33 - 57.08	Pole	TP32.6473x32.5942x0.45	26	-30.87	2824.78	65.8	Pass	
L27	57.08 - 52.08	Pole	TP33.7099x32.6473x0.4438	27	-32.19	2878.02	69.5	Pass	
L28	52.08 - 47.08	Pole	TP34.7725x33.7099x0.4375	28	-33.56	2928.65	72.9	Pass	
L29	47.08 - 40.457	Pole	TP36.18x34.7725x0.4375	29	-33.98	2956.57	73.6	Pass	
L30	40.457 - 39.457	Pole	TP35.8888x34.5998x0.5	30	-36.70	3449.75	68.9	Pass	
L31	39.457 - 37.75	Pole	TP36.2505x35.8888x0.4938	31	-37.22	3442.06	70.4	Pass	
L32	37.75 - 37.5	Pole	TP36.3035x36.2505x0.4938	32	-37.33	3447.15	70.4	Pass	
L33	37.5 - 32.5	Pole	TP37.363x36.3035x0.4875	33	-38.88	3504.82	72.9	Pass	
L34	32.5 - 27.5	Pole	TP38.4226x37.363x0.4813	34	-40.49	3559.88	75.2	Pass	
L35	27.5 - 22.5	Pole	TP39.4821x38.4226x0.475	35	-42.13	3612.35	77.5	Pass	
L36	22.5 - 17.5	Pole	TP40.5416x39.4821x0.475	36	-43.80	3710.47	78.6	Pass	
L37	17.5 - 12.5	Pole	TP41.6012x40.5416x0.4625	37	-45.50	3709.49	81.6	Pass	
L38	12.5 - 12.25	Pole	TP41.6541x41.6012x0.4625	38	-45.61	3714.27	81.7	Pass	
L39	12.25 - 12	Pole	TP41.7071x41.6541x0.6	39	-45.72	4808.62	63.6	Pass	
L40	12 - 7	Pole	TP42.7667x41.7071x0.5875	40	-47.84	4831.23	65.6	Pass	
L41	7 - 2	Pole	TP43.8262x42.7667x0.5875	41	-49.88	4952.59	66.1	Pass	
L42	2 - 0	Pole	TP44.25x43.8262x0.575	42	-50.68	4896.13	67.7	Pass	
							Summary		
							Pole (L38)	81.7	Pass
							RATING =	81.7	Pass

***NOTE: Above stress ratios for reinforced sections are approximate. More exact calculations are presented in Appendix C.**

APPENDIX B
BASE LEVEL DRAWING



(PROPOSED EQUIPMENT CONFIGURATION)
(1) 1-5/8" TO 105 FT LEVEL
(1) 2" TO 105 FT LEVEL

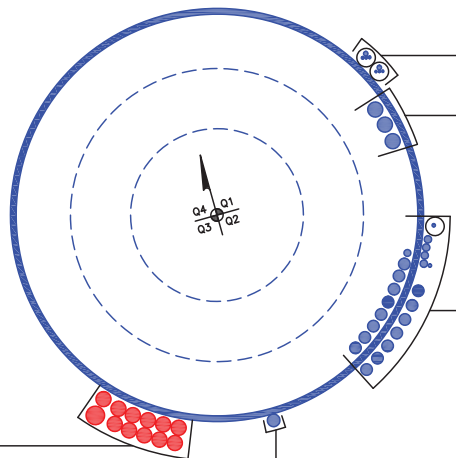

(OTHER CONSIDERED EQUIPMENT-IN CONDUITS)
(3) 1/4" TO 125 FT LEVEL
(3) 5/16" TO 125 FT LEVEL
(2) 1/2" TO 125 FT LEVEL

(OTHER CONSIDERED EQUIPMENT)
(3) 1-5/8" TO 84 FT LEVEL

(OTHER CONSIDERED EQUIPMENT-IN CONDUIT)
(1) 3/8" TO 115 FT LEVEL
(OTHER CONSIDERED EQUIPMENT)
(1) 3/8" TO 115 FT LEVEL
(4) 13/16" TO 115 FT LEVEL
(12) 1-1/4" TO 115 FT LEVEL

(OTHER CONSIDERED EQUIPMENT)
(1) 3/4" TO 125 FT LEVEL
(3) 1-1/4" TO 125 FT LEVEL

(OTHER CONSIDERED EQUIPMENT)
(1) 1-3/8" TO 94 FT LEVEL

APPENDIX C
ADDITIONAL CALCULATIONS

Site BU: 876364
Work Order: 2265165

Copyright © 2019 Crown Castle

Pole Geometry

	Pole Height Above Base (ft)	Section Length (ft)	Lap Splice Length (ft)	Number of Sides	Top Diameter (in)	Bottom Diameter (in)	Wall Thickness (in)	Bend Radius (in)	Pole Material
1	125	39.96	3.917	18	18.5	27.09	0.1875	Auto	A572-65
2	88.957	48.5	5.083	18	25.87	36.18	0.25	Auto	A572-65
3	45.54	45.54	0	18	34.60	44.25	0.3125	Auto	A572-65

Reinforcement Configuration

	Bottom Effective Elevation (ft)	Top Effective Elevation (ft)	Type	Model	Number	1	2	3	4	5	6	7	8	9	10	11	12	13	14	15	16	17	18
1	0	37.75	plate	MS-406	3																		
2	37.75	57.75	plate	MS-406	3																		
3	57.75	73.5	plate	MS-404	3																		
4	73	89	plate	MS-600K	3																		
5	89	94.46	plate	MS-600 Notched (2")	3																		
6	0	12.25	plate	CCI-WSFP-065125	3																		
7	57.33	63	plate	CCI-SFP-060100	3																		
8	86.875	99.375	plate	CCI 3.25X1.25	4																		
9																							
10																							

Reinforcement Details

	B (in)	H (in)	Gross Area (in ²)	Pole Face to Centroid (in)	Bottom Termination Type	Bottom Termination Length (in)	Top Termination Type	Top Termination Length (in)	Lu (in)	Net Area (in ²)	Bolt Hole Size (in)	Reinforcement Material
1	4.875	1.25	6.09375	0.625	PC 8.8 - M20 (100)	33	PC 8.8 - M20 (100)	33.000	23.000	4.492	1.2188	A514-GR100
2	4.875	1.25	6.09375	0.625	PC 8.8 - M20 (100)	33	PC 8.8 - M20 (100)	33.000	23.000	4.492	1.2188	A514-GR100
3	4.75	0.75	3.5625	0.375	PC 8.8 - M20 (100)	24	PC 8.8 - M20 (100)	24.000	14.000	2.602	1.2188	A514-GR100
4	6	1	6	0.5	PC 8.8 - M20 (100)	24	PC 8.8 - M20 (100)	24.000	16.375	4.719	1.2188	A572-65
5	4	1	4	0.5	PC 8.8 - M20 (100)	24	PC 8.8 - M20 (100)	24.000	16.375	2.719	1.2188	A572-65
6	6.5	1.25	8.125	0.625	Welded	n/a	PC 8.8 - M20 (100)	33.000	19.000	6.563	1.1875	A572-65
7	6	1	6	0.5	PC 8.8 - M20 (100)	24	PC 8.8 - M20 (100)	24.000	16.000	4.750	1.1875	A572-65
8	3.25	1.25	4.0625	0.625	PC 8.8 - M20 (100)	15	PC 8.8 - M20 (100)	15.000	24.000	2.461	1.2188	A572-65

Connection Details for Custom Reinforcements

Reinforcement	End	# Bolts	N or X	Bolt Spacing (in)	Edge Dist (in)	Weld Grade (ksi)	Transverse (Horiz.) Weld Type	Horiz. Weld Length (in)	Horiz. Groove Depth (in)	Horiz. Groove Angle (deg)	Horiz. Fillet Size (in)	Vertical Weld Length (in)	Vertical Fillet Size (in)	Rev H Connection Capacity (kip)
MS-406	Top	11	N	3	3	-	-	-	-	-	-	-	-	-
	Bottom	11	N	3	3	-	-	-	-	-	-	-	-	-
MS-404	Top	8	N	3	3	-	-	-	-	-	-	-	-	-
	Bottom	8	N	3	3	-	-	-	-	-	-	-	-	-
MS-600K	Top	8	N	3	3	-	-	-	-	-	-	-	-	-
	Bottom	8	N	3	3	-	-	-	-	-	-	-	-	-
MS-600 Notched (2")	Top	8	N	3	3	-	-	-	-	-	-	-	-	-
	Bottom	8	N	3	3	-	-	-	-	-	-	-	-	-
CCI 3.25X1.25	Top	5	N	3	3	-	-	-	-	-	-	-	-	-
	Bottom	5	N	3	3	-	-	-	-	-	-	-	-	-

TNX Geometry Input

Increment (ft): 5 [Export to TNX](#)

	Section Height (ft)	Section Length (ft)	Lap Splice Length (ft)	Number of Sides	Top Diameter (in)	Bottom Diameter (in)	Wall Thickness (in)	Tapered Pole Grade	Weight Multiplier
1	125 - 120	5		18	18.500	19.575	0.1875	A572-65	1.000
2	120 - 115	5		18	19.575	20.650	0.1875	A572-65	1.000
3	115 - 110	5		18	20.650	21.724	0.1875	A572-65	1.000
4	110 - 105	5		18	21.724	22.799	0.1875	A572-65	1.000
5	105 - 100	5		18	22.799	23.874	0.1875	A572-65	1.000
6	100 - 99.375	0.625		18	23.874	24.008	0.1875	A572-65	1.000
7	99.375 - 99.125	0.25		18	24.008	24.062	0.425	A572-65	0.955
8	99.125 - 94.46	4.665		18	24.062	25.065	0.4125	A572-65	0.962
9	94.46 - 94.21	0.25		18	25.065	25.119	0.6	A572-65	0.923
10	94.21 - 89.21	5		18	25.119	26.194	0.575	A572-65	0.935
11	89.21 - 89	0.21		18	26.194	26.239	0.575	A572-65	0.934
12	89 - 88.957	3.96	3.917	18	26.239	27.090	0.6625	A572-65	0.925
13	88.957 - 84.04	4.917		18	25.873	26.918	0.5	A572-65	0.934
14	84.04 - 79.04	5		18	26.918	27.981	0.4875	A572-65	0.940
15	79.04 - 74.04	5		18	27.981	29.043	0.475	A572-65	0.948
16	74.04 - 73.5	0.54		18	29.043	29.158	0.475	A572-65	0.947
17	73.5 - 73.25	0.25		18	29.158	29.211	0.6125	A572-65	0.929
18	73.25 - 73	0.25		18	29.211	29.264	0.6125	A572-65	0.928
19	73 - 72.75	0.25		18	29.264	29.317	0.375	A572-65	0.980
20	72.75 - 67.75	5		18	29.317	30.380	0.375	A572-65	0.969
21	67.75 - 63	4.75		18	30.380	31.389	0.36875	A572-65	0.975
22	63 - 62.75	0.25		18	31.389	31.442	0.575	A572-65	0.949
23	62.75 - 57.75	5		18	31.442	32.505	0.5625	A572-65	0.952
24	57.75 - 57.5	0.25		18	32.505	32.558	0.6625	A572-65	0.923
25	57.5 - 57.33	0.17		18	32.558	32.594	0.6625	A572-65	0.923
26	57.33 - 57.08	0.25		18	32.594	32.647	0.45	A572-65	0.957
27	57.08 - 52.08	5		18	32.647	33.710	0.44375	A572-65	0.957
28	52.08 - 47.08	5		18	33.710	34.773	0.4375	A572-65	0.958
29	47.08 - 45.54	6.623	5.083	18	34.773	36.180	0.4375	A572-65	0.954
30	45.54 - 39.457	6.083		18	34.600	35.889	0.5	A572-65	0.954
31	39.457 - 37.75	1.707		18	35.889	36.251	0.49375	A572-65	0.962
32	37.75 - 37.5	0.25		18	36.251	36.304	0.49375	A572-65	0.962
33	37.5 - 32.5	5		18	36.304	37.363	0.4875	A572-65	0.964
34	32.5 - 27.5	5		18	37.363	38.423	0.48125	A572-65	0.968
35	27.5 - 22.5	5		18	38.423	39.482	0.475	A572-65	0.972
36	22.5 - 17.5	5		18	39.482	40.542	0.475	A572-65	0.963
37	17.5 - 12.5	5		18	40.542	41.601	0.4625	A572-65	0.981
38	12.5 - 12.25	0.25		18	41.601	41.654	0.4625	A572-65	0.980
39	12.25 - 12	0.25		18	41.654	41.707	0.6	A572-65	1.069
40	12 - 7	5		18	41.707	42.767	0.5875	A572-65	1.078
41	7 - 2	5		18	42.767	43.826	0.5875	A572-65	1.064
42	2 - 0	2		18	43.826	44.250	0.575	A572-65	1.082

TNX Section Forces

Increment (ft):		TNX Output			
	5	Section Height (ft)	P _u (K)	M _{ux} (kip-ft)	V _u (K)
1	125 - 120		3.56	33.82	6.52
2	120 - 115		3.85	67.23	6.84
3	115 - 110		7.50	135.17	12.32
4	110 - 105		7.94	197.53	12.65
5	105 - 100		14.76	296.75	20.17
6	100 - 99.375		14.84	309.36	20.26
7	99.375 - 99.125		14.88	314.43	20.30
8	99.125 - 94.46		15.65	410.84	21.10
9	94.46 - 94.21		15.72	416.11	21.14
10	94.21 - 89.21		19.17	537.64	24.46
11	89.21 - 89		19.22	542.77	24.49
12	89 - 88.957		19.23	543.82	24.50
13	88.957 - 84.04		20.99	666.72	25.46
14	84.04 - 79.04		25.39	816.84	30.44
15	79.04 - 74.04		26.57	971.14	31.24
16	74.04 - 73.5		26.71	988.04	31.32
17	73.5 - 73.25		26.78	995.88	31.36
18	73.25 - 73		26.85	1003.73	31.40
19	73 - 72.75		26.90	1011.60	31.44
20	72.75 - 67.75		28.01	1170.83	32.21
21	67.75 - 63		29.10	1325.58	32.93
22	63 - 62.75		29.20	1333.82	32.95
23	62.75 - 57.75		30.65	1500.87	33.82
24	57.75 - 57.5		30.75	1509.33	33.86
25	57.5 - 57.33		30.80	1515.10	33.89
26	57.33 - 57.08		30.87	1523.58	33.93
27	57.08 - 52.08		32.19	1695.33	34.72
28	52.08 - 47.08		33.56	1870.89	35.47
29	47.08 - 45.54		33.98	1925.72	35.71
30	45.54 - 39.457		36.70	2146.27	36.76
31	39.457 - 37.75		37.22	2209.28	37.04
32	37.75 - 37.5		37.33	2218.54	37.04
33	37.5 - 32.5		38.88	2405.72	37.78
34	32.5 - 27.5		40.49	2596.42	38.47
35	27.5 - 22.5		42.13	2790.46	39.12
36	22.5 - 17.5		43.80	2987.67	39.73
37	17.5 - 12.5		45.50	3187.85	40.31
38	12.5 - 12.25		45.61	3197.93	40.31
39	12.25 - 12		45.72	3208.03	40.34
40	12 - 7		47.84	3411.53	41.00
41	7 - 2		49.88	3617.19	41.27
42	2 - 0		50.68	3699.75	41.34

Analysis Results

Elevation (ft)	Component Type	Size	Critical Element	% Capacity	Pass / Fail
125 - 120	Pole	TP19.575x18.5x0.1875	Pole	10.2%	Pass
120 - 115	Pole	TP20.65x19.575x0.1875	Pole	18.1%	Pass
115 - 110	Pole	TP21.724x20.65x0.1875	Pole	33.4%	Pass
110 - 105	Pole	TP22.799x21.724x0.1875	Pole	44.5%	Pass
105 - 100	Pole	TP23.874x22.799x0.1875	Pole	62.5%	Pass
100 - 99.38	Pole	TP24.008x23.874x0.1875	Pole	64.4%	Pass
99.38 - 99.13	Pole + Reinf.	TP24.062x24.008x0.425	Reinf. 8 Tension Rupture	58.2%	Pass
99.13 - 94.46	Pole + Reinf.	TP25.065x24.062x0.4125	Reinf. 8 Tension Rupture	71.4%	Pass
94.46 - 94.21	Pole + Reinf.	TP25.119x25.065x0.6	Reinf. 8 Tension Rupture	50.5%	Pass
94.21 - 89.21	Pole + Reinf.	TP26.194x25.119x0.575	Reinf. 8 Tension Rupture	61.7%	Pass
89.21 - 89	Pole + Reinf.	TP26.239x26.194x0.575	Reinf. 8 Tension Rupture	62.2%	Pass
89 - 88.96	Pole + Reinf.	TP27.09x26.239x0.6625	Reinf. 8 Tension Rupture	54.1%	Pass
88.96 - 84.04	Pole + Reinf.	TP26.918x25.873x0.5	Reinf. 4 Tension Rupture	62.2%	Pass
84.04 - 79.04	Pole + Reinf.	TP27.981x26.918x0.4875	Reinf. 4 Tension Rupture	71.9%	Pass
79.04 - 74.04	Pole + Reinf.	TP29.043x27.981x0.475	Reinf. 4 Tension Rupture	80.6%	Pass
74.04 - 73.5	Pole + Reinf.	TP29.158x29.043x0.475	Reinf. 4 Tension Rupture	81.5%	Pass
73.5 - 73.25	Pole + Reinf.	TP29.211x29.158x0.6125	Reinf. 4 Tension Rupture	64.6%	Pass
73.25 - 73	Pole + Reinf.	TP29.264x29.211x0.6125	Reinf. 4 Tension Rupture	64.9%	Pass
73 - 72.75	Pole + Reinf.	TP29.317x29.264x0.375	Reinf. 3 Tension Rupture	79.8%	Pass
72.75 - 67.75	Pole + Reinf.	TP30.38x29.317x0.375	Reinf. 3 Tension Rupture	86.9%	Pass
67.75 - 63	Pole + Reinf.	TP31.389x30.38x0.3688	Reinf. 3 Tension Rupture	92.9%	Pass
63 - 62.75	Pole + Reinf.	TP31.442x31.389x0.575	Reinf. 7 Tension Rupture	77.2%	Pass
62.75 - 57.75	Pole + Reinf.	TP32.505x31.442x0.5625	Reinf. 7 Tension Rupture	82.7%	Pass
57.75 - 57.5	Pole + Reinf.	TP32.558x32.505x0.6625	Reinf. 7 Tension Rupture	72.0%	Pass
57.5 - 57.33	Pole + Reinf.	TP32.594x32.558x0.6625	Reinf. 7 Tension Rupture	72.1%	Pass
57.33 - 57.08	Pole + Reinf.	TP32.647x32.594x0.45	Reinf. 2 Tension Rupture	81.4%	Pass
57.08 - 52.08	Pole + Reinf.	TP33.71x32.647x0.4438	Reinf. 2 Tension Rupture	86.0%	Pass
52.08 - 47.08	Pole + Reinf.	TP34.773x33.71x0.4375	Reinf. 2 Tension Rupture	90.3%	Pass
47.08 - 45.54	Pole + Reinf.	TP36.18x34.773x0.4375	Reinf. 2 Tension Rupture	91.6%	Pass
45.54 - 39.46	Pole + Reinf.	TP35.889x34.6x0.5	Reinf. 2 Tension Rupture	86.2%	Pass
39.46 - 37.75	Pole + Reinf.	TP36.251x35.889x0.4938	Reinf. 2 Tension Rupture	87.2%	Pass
37.75 - 37.5	Pole + Reinf.	TP36.304x36.251x0.4938	Reinf. 1 Tension Rupture	87.4%	Pass
37.5 - 32.5	Pole + Reinf.	TP37.363x36.304x0.4875	Reinf. 1 Tension Rupture	90.3%	Pass
32.5 - 27.5	Pole + Reinf.	TP38.423x37.363x0.4813	Reinf. 1 Tension Rupture	93.0%	Pass
27.5 - 22.5	Pole + Reinf.	TP39.482x38.423x0.475	Reinf. 1 Tension Rupture	95.4%	Pass
22.5 - 17.5	Pole + Reinf.	TP40.542x39.482x0.475	Reinf. 1 Tension Rupture	97.7%	Pass
17.5 - 12.5	Pole + Reinf.	TP41.601x40.542x0.4625	Reinf. 1 Tension Rupture	99.8%	Pass
12.5 - 12.25	Pole + Reinf.	TP41.654x41.601x0.4625	Reinf. 1 Tension Rupture	99.9%	Pass
12.25 - 12	Pole + Reinf.	TP41.707x41.654x0.6	Reinf. 6 Tension Rupture	85.1%	Pass
12 - 7	Pole + Reinf.	TP42.767x41.707x0.5875	Reinf. 6 Tension Rupture	87.2%	Pass
7 - 2	Pole + Reinf.	TP43.826x42.767x0.5875	Reinf. 6 Tension Rupture	89.1%	Pass
2 - 0	Pole + Reinf.	TP44.25x43.826x0.575	Reinf. 6 Tension Rupture	89.9%	Pass
				Summary	
			Pole	87.8%	Pass
			Reinforcement	99.9%	Pass
			Overall	99.9%	Pass

Additional Calculations

Section Elevation (ft)	Moment of Inertia (in ⁴)			Area (in ²)			% Capacity* (100% Max. Allowable)								
	Pole	Reinf.	Total	Pole	Reinf.	Total	Pole	R1	R2	R3	R4	R5	R6	R7	R8
125 - 120	548	n/a	548	11.54	n/a	11.54	10.2%								
120 - 115	644	n/a	644	12.18	n/a	12.18	18.1%								
115 - 110	751	n/a	751	12.82	n/a	12.82	33.4%								
110 - 105	869	n/a	869	13.46	n/a	13.46	44.5%								
105 - 100	999	n/a	999	14.10	n/a	14.10	62.5%								
100 - 99.38	1016	n/a	1016	14.18	n/a	14.18	64.4%								
99.38 - 99.13	1025	1229	2254	14.21	16.25	30.46	30.4%								58.2%
99.13 - 94.46	1160	1328	2488	14.80	16.25	31.05	37.8%								71.4%
94.46 - 94.21	1166	2368	3534	14.84	28.25	43.09	26.8%					44.6%			50.5%
94.21 - 89.21	1324	2564	3888	15.48	28.25	43.73	33.3%					54.5%			61.7%
89.21 - 89	1330	2573	3903	15.50	28.25	43.75	33.6%					54.9%			62.2%
89 - 88.96	1332	3152	4483	15.51	34.25	49.76	29.2%				49.8%				54.1%
88.96 - 84.04	1901	1781	3682	21.16	18.00	39.16	39.7%				62.2%				
84.04 - 79.04	2137	1917	4054	22.00	18.00	40.00	46.4%				71.9%				
79.04 - 74.04	2392	2059	4451	22.85	18.00	40.85	52.6%				80.6%				
74.04 - 73.5	2421	2074	4495	22.94	18.00	40.94	53.3%				81.5%				
73.5 - 73.25	2434	3291	5725	22.98	28.69	51.67	42.2%			50.4%	64.6%				
73.25 - 73	2448	3302	5750	23.02	28.69	51.71	42.4%			50.6%	64.9%				
73 - 72.75	2461	1218	3679	23.06	10.69	33.75	66.9%				79.8%				
72.75 - 67.75	2741	1305	4046	23.91	10.69	34.59	73.7%				86.9%				
67.75 - 63	3026	1390	4416	24.71	10.69	35.40	79.7%				92.9%				
63 - 62.75	3041	3791	6832	24.75	28.69	53.44	52.0%				60.6%				77.2%
62.75 - 57.75	3363	4041	7404	25.59	28.69	54.28	56.4%				65.0%				82.7%
57.75 - 57.5	3380	5193	8572	25.64	36.28	61.92	49.1%		56.8%						72.0%
57.5 - 57.33	3391	5204	8595	25.66	36.28	61.95	49.3%		56.9%						72.1%
57.33 - 57.08	3408	2645	6053	25.71	18.28	43.99	70.4%				81.4%				
57.08 - 52.08	3754	2812	6566	26.55	18.28	44.83	75.4%				86.0%				
52.08 - 47.08	4123	2985	7108	27.39	18.28	45.67	80.2%				90.3%				
47.08 - 45.54	4242	3039	7280	27.65	18.28	45.93	81.6%				91.6%				
45.54 - 39.46	5641	3171	8812	35.29	18.28	53.57	71.8%				86.2%				
39.46 - 37.75	5814	3233	9047	35.64	18.28	53.93	72.9%				87.2%				
37.75 - 37.5	5840	3242	9082	35.70	18.28	53.98	73.0%	87.4%							
37.5 - 32.5	6371	3426	9798	36.75	18.28	55.03	76.2%				90.3%				
32.5 - 27.5	6934	3616	10550	37.80	18.28	56.08	79.3%				93.0%				
27.5 - 22.5	7528	3811	11339	38.85	18.28	57.13	82.2%				95.4%				
22.5 - 17.5	8156	4010	12166	39.90	18.28	58.18	85.0%				97.7%				
17.5 - 12.5	8817	4215	13033	40.95	18.28	59.23	87.6%				99.8%				
12.5 - 12.25	8851	4226	13077	41.00	18.28	59.29	87.8%				99.9%				
12.25 - 12	9052	7786	16838	41.06	42.66	83.71	75.7%	79.0%					85.1%		
12 - 7	9760	8175	17935	42.11	42.66	84.76	78.2%	80.8%						87.2%	
7 - 2	10504	8575	19079	43.16	42.66	85.81	80.5%	82.5%						89.1%	
2 - 0	10812	8737	19549	43.58	42.66	86.24	81.4%	83.1%						89.9%	

Note: Section capacity checked using 5 degree increments.
 *Rating per TIA-222-H Section 15.5.

Monopole Base Plate Connection



Site Info	
BU #	876364
Site Name	nwell / First Line Emer
Order #	658833 Rev 0

Analysis Considerations	
TIA-222 Revision	H
Grout Considered:	See Custom Sheet
I_{gr} (in)	See Custom Sheet

Applied Loads	
Moment (kip-ft)	3699.75
Axial Force (kips)	50.68
Shear Force (kips)	41.34

*TIA-222-H Section 15.5 Applied

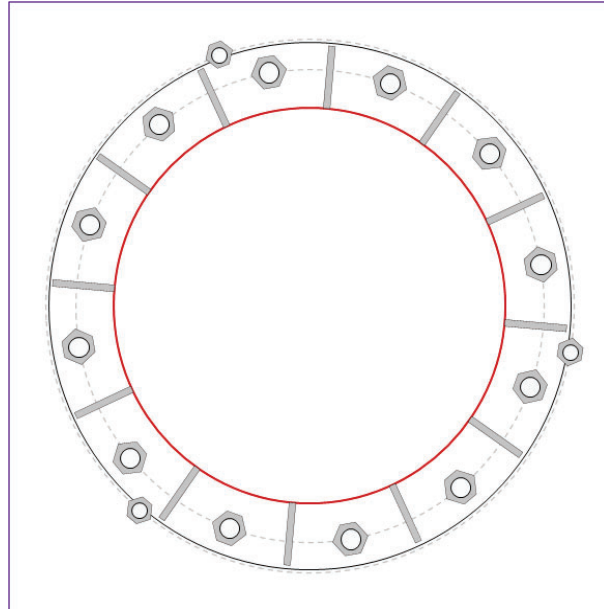

Connection Properties	Analysis Results
-----------------------	------------------

Anchor Rod Data
 GROUP 1: (12) 2-1/4" ϕ bolts (A615-75 N; $F_y=75$ ksi, $F_u=100$ ksi) on 53" BC
 GROUP 2: (3) 1-3/4" ϕ bolts (F1554-105 N; $F_y=105$ ksi, $F_u=125$ ksi) on 59.75" BC

Base Plate Data
 59" OD x 1.75" Plate (A572-60; $F_y=60$ ksi, $F_u=75$ ksi)

Stiffener Data
 (12) 22"H x 7"W x 0.75"T, Notch: 0.75"
 plate: $F_y=50$ ksi ; weld: $F_y=70$ ksi
 horiz. weld: 0.625" fillet
 vert. weld: 0.375" fillet

Pole Data
 44.25" x 0.3125" 18-sided pole (A572-65; $F_y=65$ ksi, $F_u=80$ ksi)

Anchor Rod Summary (units of kips, kip-in)
 GROUP 1:

$Pu_t = 231.1$	$\phi Pn_t = 243.75$	Stress Rating
$Vu = 3.44$	$\phi Vn = 149.1$	90.3%
$Mu = n/a$	$\phi Mn = n/a$	Pass

GROUP 2:

$Pu_t = 155.1$	$\phi Pn_t = 178.13$	Stress Rating
$Vu = 0$	$\phi Vn = 112.75$	82.9%
$Mu = n/a$	$\phi Mn = n/a$	Pass

Base Plate Summary

Max Stress (ksi):	46.98	(Roark's Flexural)
Allowable Stress (ksi):	54	
Stress Rating:	82.9%	Pass

Stiffener Summary

Horizontal Weld:	88.2%	Pass
Vertical Weld:	47.0%	Pass
Plate Flexure+Shear:	20.7%	Pass
Plate Tension+Shear:	78.5%	Pass
Plate Compression:	77.5%	Pass

Pole Summary

Punching Shear:	14.6%	Pass
-----------------	--------------	-------------

CClplate

Elevation (ft) 0 (Base)

note: Bending interaction not considered when Grout Considered = "Yes"

Bolt Group	Resist Axial	Resist Shear	Induce Plate Bending	Grout Considered	Apply at BARB Elevation	BARB CL Elevation (ft)
1	Yes	Yes	Yes	Yes	No	
2	No	No	No	Yes	No	

Custom Bolt Connection

Bolt	Bolt Group ID	Location (deg.)	Diameter (in)	Material	Bolt Circle (in)	Eta Factor, n:	l_u (in):	Thread Type	Area Override, in ²	Tension Only
1	1	10	2.25	A615-75	53	0.55	0	N-Included		No
2	1	40	2.25	A615-75	53	0.55	0	N-Included		No
3	1	70	2.25	A615-75	53	0.55	0	N-Included		No
4	1	100	2.25	A615-75	53	0.55	0	N-Included		No
5	1	130	2.25	A615-75	53	0.55	0	N-Included		No
6	1	160	2.25	A615-75	53	0.55	0	N-Included		No
7	1	190	2.25	A615-75	53	0.55	0	N-Included		No
8	1	220	2.25	A615-75	53	0.55	0	N-Included		No
9	1	250	2.25	A615-75	53	0.55	0	N-Included		No
10	1	280	2.25	A615-75	53	0.55	0	N-Included		No
11	1	310	2.25	A615-75	53	0.55	0	N-Included		No
12	1	340	2.25	A615-75	53	0.55	0	N-Included		No
13	2	110	1.75	F1554-105	59.75	0.55	0	N-Included		No
14	2	230	1.75	F1554-105	59.75	0.55	0	N-Included		No
15	2	350	1.75	F1554-105	59.75	0.55	0	N-Included		No

Custom Stiffener Connection

Stiffener	Stiffener Group ID	Location (deg.)	Width (in)	Height (in)	Thickness (in)	H. Notch (in)	V. Notch (in)	Grade (ksi)	Weld Type	Groove Depth (in)	Groove Angle (deg.)	H. Fillet Weld Size (in)	V. Fillet Weld Size (in)	Weld Strength (ksi)
1	1	25	7	22	0.75	0.75	0.75	50	Fillet			0.625	0.375	70
2	1	55	7	22	0.75	0.75	0.75	50	Fillet			0.625	0.375	70
3	1	85	7	22	0.75	0.75	0.75	50	Fillet			0.625	0.375	70
4	1	115	7	22	0.75	0.75	0.75	50	Fillet			0.625	0.375	70
5	1	145	7	22	0.75	0.75	0.75	50	Fillet			0.625	0.375	70
6	1	175	7	22	0.75	0.75	0.75	50	Fillet			0.625	0.375	70
7	1	205	7	22	0.75	0.75	0.75	50	Fillet			0.625	0.375	70
8	1	235	7	22	0.75	0.75	0.75	50	Fillet			0.625	0.375	70
9	1	265	7	22	0.75	0.75	0.75	50	Fillet			0.625	0.375	70
10	1	295	7	22	0.75	0.75	0.75	50	Fillet			0.625	0.375	70
11	1	325	7	22	0.75	0.75	0.75	50	Fillet			0.625	0.375	70
12	1	355	7	22	0.75	0.75	0.75	50	Fillet			0.625	0.375	70

Plot Graphic

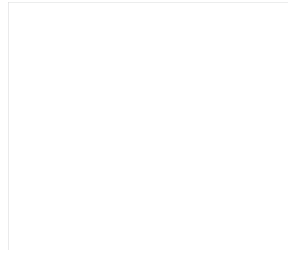
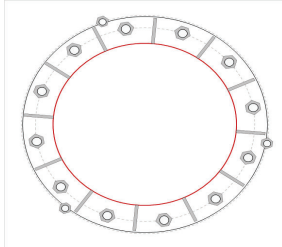

Pier and Pad Foundation



BU #: 876364
 Site Name: Cromwell / First Line Emergenc
 App. Number: 658833 Rev 0

TIA-222 Revision: H
 Tower Type: Monopole

Top & Bot. Pad Rein. Different?:
 Block Foundation?:
 Rectangular Pad?:

Superstructure Analysis Reactions		
Compression, P_{comp} :	50.7	kips
Base Shear, V_u_{comp} :	41.32	kips
Moment, M_u :	3699.75	ft-kips
Tower Height, H :	125	ft
BP Dist. Above Fdn, bp_{dist} :	2.625	in

Foundation Analysis Checks				
	Capacity	Demand	Rating*	Check
<i>Lateral (Sliding) (kips)</i>	239.31	41.32	16.4%	Pass
<i>Bearing Pressure (ksf)</i>	6.00	3.31	55.2%	Pass
<i>Overturning (kip*ft)</i>	4695.20	3956.71	84.3%	Pass
<i>Pier Flexure (Comp.) (kip*ft)</i>	7036.51	3823.71	51.8%	Pass
<i>Pier Compression (kip)</i>	80196.48	156.54	0.2%	Pass
<i>Pad Flexure (kip*ft)</i>	3256.22	816.66	23.9%	Pass
<i>Pad Shear - 1-way (kips)</i>	745.34	168.02	21.5%	Pass
<i>Pad Shear - 2-way (Comp) (ksi)</i>	0.164	0.000	0.0%	Pass
<i>Flexural 2-way (Comp) (kip*ft)</i>	5561.26	2294.23	39.3%	Pass

Pier Properties		
Pier Shape:	Square	
Pier Diameter, $dpier$:	14	ft
Ext. Above Grade, E :	1	ft
Pier Rebar Size, Sc :	8	
Pier Rebar Quantity, mc :	24	
Pier Tie/Spiral Size, St :	4	
Pier Tie/Spiral Quantity, mt :	7	
Pier Reinforcement Type:	Tie	
Pier Clear Cover, cc_{pier} :	3	in

*Rating per TIA-222-H Section 15.5

Structural Rating*:	51.8%
Soil Rating*:	84.3%

Pad Properties		
Depth, D :	5	ft
Pad Width, W_1 :	24	ft
Pad Thickness, T :	3	ft
Pad Rebar Size (Top dir. 2), Sp_{top2} :	8	
Pad Rebar Quantity (Top dir. 2), mp_{top2} :	24	
Pad Rebar Size (Bottom dir. 2), Sp_2 :	8	
Pad Rebar Quantity (Bottom dir. 2), mp_2 :	30	
Pad Clear Cover, cc_{pad} :	3	in

Material Properties		
Rebar Grade, F_y :	60	ksi
Concrete Compressive Strength, F'_c :	3	ksi
Dry Concrete Density, δ_c :	150	pcf

Soil Properties		
Total Soil Unit Weight, γ :	125	pcf
Ultimate Gross Bearing, Q_{ult} :	8.000	ksf
Cohesion, C_u :	0.000	ksf
Friction Angle, ϕ :	30	degrees
SPT Blow Count, N_{blows} :		
Base Friction, μ :	0.6	
Neglected Depth, N :	3.50	ft
Foundation Bearing on Rock?	No	
Groundwater Depth, gw :	N/A	ft

<--Toggle between Gross and Net

ASCE 7 Hazards Report

Address:
No Address at This Location

Standard: ASCE/SEI 7-16
Risk Category: II
Soil Class: D - Default (see Section 11.4.3)

Latitude: 41.583364
Longitude: -72.649761
Elevation: 14.386150929516921 ft (NAVD 88)

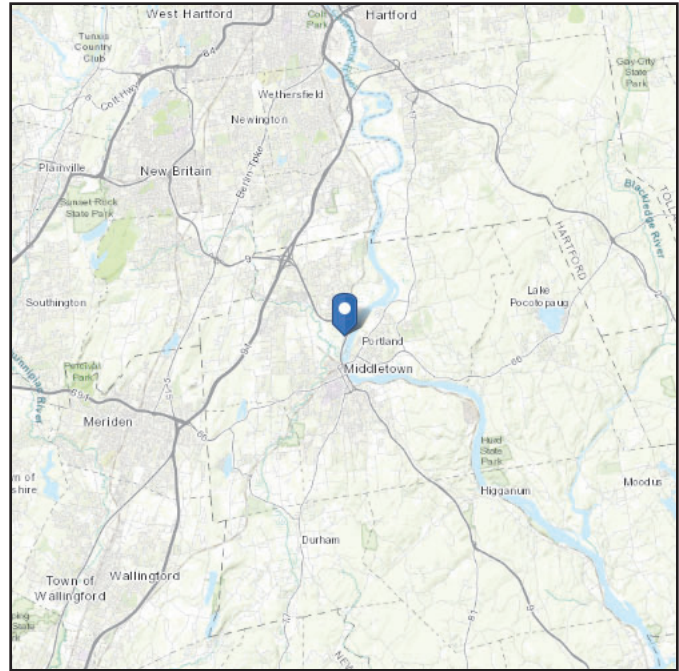
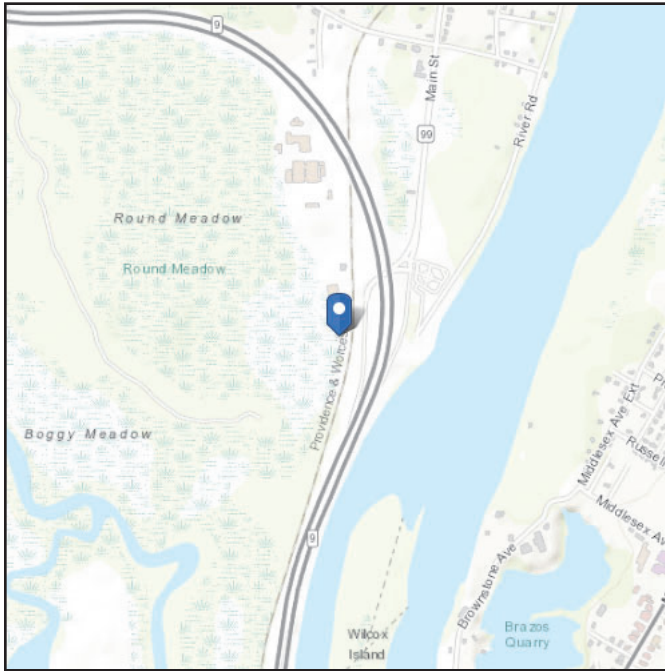

Wind

Results:

Wind Speed	119 Vmph
10-year MRI	75 Vmph
25-year MRI	84 Vmph
50-year MRI	91 Vmph
100-year MRI	98 Vmph

Data Source: ASCE/SEI 7-16, Fig. 26.5-1B and Figs. CC.2-1–CC.2-4, and Section 26.5.2

Date Accessed: Wed Oct 25 2023

Value provided is 3-second gust wind speeds at 33 ft above ground for Exposure C Category, based on linear interpolation between contours. Wind speeds are interpolated in accordance with the 7-16 Standard. Wind speeds correspond to approximately a 7% probability of exceedance in 50 years (annual exceedance probability = 0.00143, MRI = 700 years).

Site is in a hurricane-prone region as defined in ASCE/SEI 7-16 Section 26.2. Glazed openings need not be protected against wind-borne debris.

Site Soil Class:

Results:

S_s :	0.207	S_{D1} :	0.089
S_1 :	0.056	T_L :	6
F_a :	1.6	PGA :	0.115
F_v :	2.4	PGA _M :	0.181
S_{MS} :	0.332	F_{PGA} :	1.57
S_{M1} :	0.133	I_e :	1
S_{DS} :	0.221	C_v :	0.715

Seismic Design Category: B

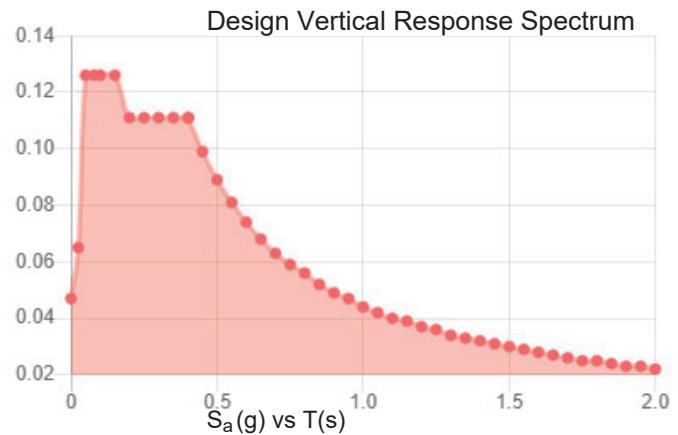
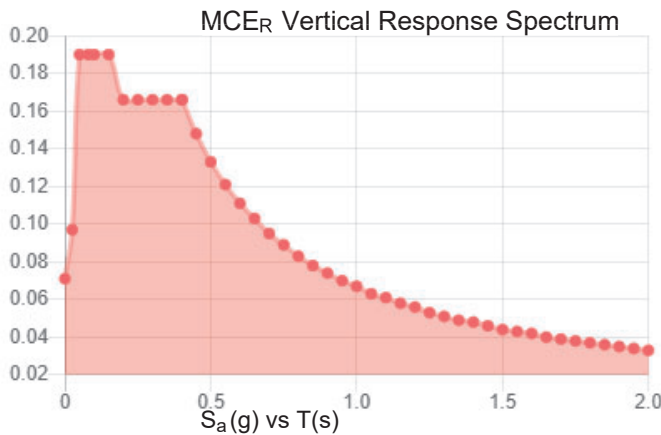
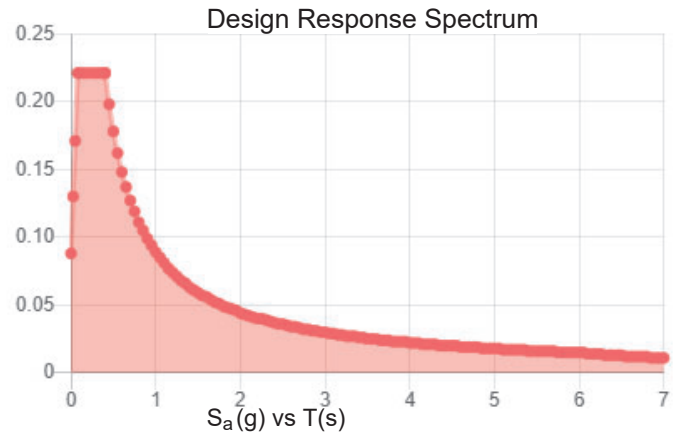
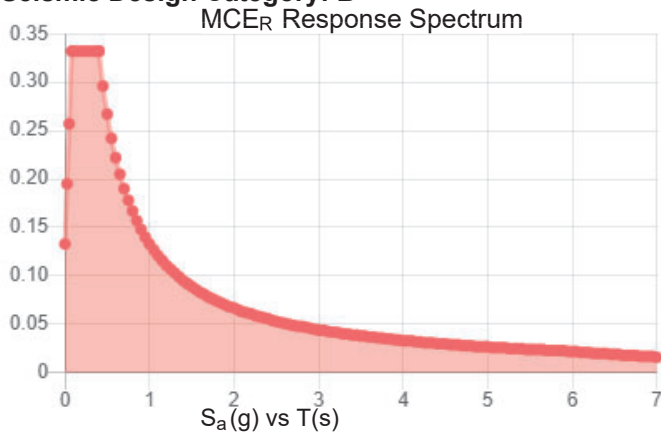

Data Accessed:

Wed Oct 25 2023

Date Source:

USGS Seismic Design Maps based on ASCE/SEI 7-16 and ASCE/SEI 7-16 Table 1.5-2. Additional data for site-specific ground motion procedures in accordance with ASCE/SEI 7-16 Ch. 21 are available from USGS.

Ice

Results:

Ice Thickness: 1.00 in.

Concurrent Temperature: 15 F

Gust Speed 50 mph

Data Source: Standard ASCE/SEI 7-16, Figs. 10-2 through 10-8

Date Accessed: Wed Oct 25 2023

Ice thicknesses on structures in exposed locations at elevations higher than the surrounding terrain and in valleys and gorges may exceed the mapped values.

Values provided are equivalent radial ice thicknesses due to freezing rain with concurrent 3-second gust speeds, for a 500-year mean recurrence interval, and temperatures concurrent with ice thicknesses due to freezing rain. Thicknesses for ice accretions caused by other sources shall be obtained from local meteorological studies. Ice thicknesses in exposed locations at elevations higher than the surrounding terrain and in valleys and gorges may exceed the mapped values.

The ASCE 7 Hazard Tool is provided for your convenience, for informational purposes only, and is provided “as is” and without warranties of any kind. The location data included herein has been obtained from information developed, produced, and maintained by third party providers; or has been extrapolated from maps incorporated in the ASCE 7 standard. While ASCE has made every effort to use data obtained from reliable sources or methodologies, ASCE does not make any representations or warranties as to the accuracy, completeness, reliability, currency, or quality of any data provided herein. Any third-party links provided by this Tool should not be construed as an endorsement, affiliation, relationship, or sponsorship of such third-party content by or from ASCE.

ASCE does not intend, nor should anyone interpret, the results provided by this Tool to replace the sound judgment of a competent professional, having knowledge and experience in the appropriate field(s) of practice, nor to substitute for the standard of care required of such professionals in interpreting and applying the contents of this Tool or the ASCE 7 standard.

In using this Tool, you expressly assume all risks associated with your use. Under no circumstances shall ASCE or its officers, directors, employees, members, affiliates, or agents be liable to you or any other person for any direct, indirect, special, incidental, or consequential damages arising from or related to your use of, or reliance on, the Tool or any information obtained therein. To the fullest extent permitted by law, you agree to release and hold harmless ASCE from any and all liability of any nature arising out of or resulting from any use of data provided by the ASCE 7 Hazard Tool.