

# STATE OF CONNECTICUT

## CONNECTICUT SITING COUNCIL

Ten Franklin Square, New Britain, CT 06051

Phone: (860) 827-2935 Fax: (860) 827-2950

E-Mail: [siting.council@po.state.ct.us](mailto:siting.council@po.state.ct.us)

[www.ct.gov/csc](http://www.ct.gov/csc)

June 28, 2006

Elizabeth H. Lankenau, AICP  
Planner  
Kise Straw & Kolodner, Inc.  
123 South Broad St., Suite 1270  
Philadelphia, PA 19109

RE: **EM-CING-033-080-083-060525** - New Cingular Wireless PCS, LLC notice of intent to modify existing telecommunications facilities located at 27 Butler Street, Meriden; 290 Preston Avenue, Middletown; and off Christian Hill Road, Cromwell, Connecticut.

Dear Ms. Lankenau:

At a public meeting held on June 27, 2006, the Connecticut Siting Council (Council) acknowledged your notice to modify these existing telecommunications facilities, pursuant to Section 16-50j-73 of the Regulations of Connecticut State Agencies. The Council strongly encourages that all reasonable measures be taken to substantially improve the condition of the compound including the removal of debris and unnecessary clutter at the Middletown tower site.

The proposed modifications are to be implemented as specified here and in your notice dated June 13, 2006, including the placement of all necessary equipment and shelters within the tower compounds. The modifications are in compliance with the exception criteria in Section 16-50j-72 (b) of the Regulations of Connecticut State Agencies as changes to existing facility sites that would not increase tower heights, extend the boundaries of the tower sites, increase noise levels at the tower site boundaries by six decibels, and increase the total radio frequencies electromagnetic radiation power densities measured at the tower site boundaries to or above the standard adopted by the State Department of Environmental Protection pursuant to General Statutes § 22a-162. These facilities have also been carefully modeled to ensure that radio frequency emissions are conservatively below State and federal standards applicable to the frequencies now used on these towers.

This decision is under the exclusive jurisdiction of the Council. Please be advised that the validity of this action shall expire one year from the date of this letter. Any additional change to any of these facilities will require explicit notice to this agency pursuant to Regulations of Connecticut State Agencies Section 16-50j-73. Such notice shall include all relevant information regarding the proposed change with cumulative worst-case modeling of radio frequency exposure at the closest point of uncontrolled access to the tower base, consistent with Federal Communications Commission, Office of Engineering and Technology, Bulletin 65. Any deviation from this format may result in the Council implementing enforcement proceedings pursuant to General Statutes § 16-50u including, without limitation, imposition of expenses resulting from such failure and of civil penalties in an amount not less than one thousand dollars per day for each day of construction or operation in material violation.

Thank you for your attention and cooperation.

Very truly yours,

  
Pamela B. Katz, P.E.  
Chairman

PBK/laf

c: See Attached List.

I:\siting\forms\exam\mod\emdc\tr.doc



List Attachment.

- c: The Honorable Sebastian N. Giuliano, Mayor, City of Middletown
- William Warner, AICP Director, City of Middletown
- The Honorable Mark Benigni, Mayor, City of Meriden
- Lawrence Kendzior, City Manager, City of Meriden
- Dominick Caruso, City Planner, City of Meriden
- The Honorable Paul C. Beaulieu, First Selectman, Town of Cromwell
- Frederic Curtin, Zoning Enforcement Officer, Town of Cromwell
- Douglas J. Hulbert, Project Manager, CH2M Hill
- Christopher B. Fisher, Esq., Cuddy & Feder LLP
- Michele G. Briggs, Cingular Wireless PCS, LLC
- Christine Farrell, T-Mobile
- Thomas J. Regan, Esq., Brown Rudnick Berlack Israels, LLP
- Kenneth C. Baldwin, Esq., Robinson & Cole LLP

ORIGINAL

13 June 2006

Ms. Pam Katz, Chairman, and  
Members of the Connecticut Siting Council  
10 Franklin Square  
New Britain, CT 06051

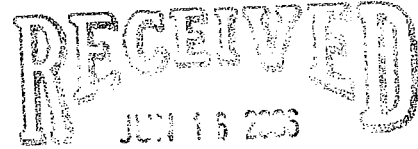

CONNECTICUT  
SITING COUNCIL

**RE: Notice of Exempt Modification – REVISED SUBMISSION**  
**Three (3) Existing Telecommunications Tower Facilities in:**  
**Middletown, New Haven County (Docket EM-CING-033-080-083-060525)**  
**Meriden, New Haven County**  
**Cromwell, Hartford County**

Dear Chairman Katz and Members of the Council:

Kise Straw & Kolodner Inc., in association with Network Building & Consulting, LLC, submits this notice of intent to modify existing telecommunications facilities. New Cingular Wireless PCS, LLC (“Cingular”) proposes to remove and replace telecommunications antennas and associated equipment located on an existing facility in the above-referenced municipalities. *Please note that the Middletown site has been revised for a new proposal.* Cingular operates under licenses issued by the Federal Communications Commission (FCC) to provide cellular and PCS mobile telephone service in the areas to be served by the proposed installations.

Please accept this letter and attachments as notification to the Council, pursuant to Regulations of Connecticut State Agencies (RCSA) Section 16-50j-73. This submission will demonstrate that the proposed changes fall within the limits of an exempt modification as described under the RCSA Section 16-50j-72(b)(2).

In accordance with RCSA Section 16-50j-73, the chief elected officials will receive notification of the work proposed at locations within their jurisdiction.

Attached you will find summary sheets detailing the planned changes, including power density calculations reflecting the change in the effect of Cingular’s operations at each site. Also included is documentation of the structural sufficiency of each tower to accommodate the revised antenna configuration.

The planned changes to these facilities fall within those activities explicitly provided for in RCSA Section 16-50j-72(b)(2). As such, the proposed work does not result in any substantial adverse environmental effect.

1. The proposed work does not affect the height of the structure.

*James Bennett Straw, AIA*

*Harvey D. Kolodner, MBA*

*James Nelson Kise, AIA/AICP/PP*

*Scott W. Killinger, AIA*

*John R. Gibbons, AIA/AICP*

*Philip E. Scott, EA*

*Suzanna Barucco*

*Katherine Bottom, LEED*

*LaVern Browne*

*Johnette Davies*

*Petar D. Glumac, Ph.D*

*Douglas S. Heckrone, RA/LEED*

*Jody Holton, AICP*

*Marian Maxfield Hull, AICP/PP*

Kise Straw & Kolodner Inc.  
123 South Broad St.  
Suite 1270  
Philadelphia, PA 19109  
(215) 790-1050 FAX (215) 790-0215  
www.ksk1.com

2. The proposed changes do not affect the existing property boundaries. All proposed work will occur on the property controlled by Cingular.
3. The proposed work will not increase noise levels at the site boundary by six (6) decibels or more.
4. Addition of the UMTS broadcasts will not increase the exposure to radio frequency electromagnetic energy, measured at the base of the tower, to or above the standard adopted by the state of Connecticut and the FCC. The power density tables provided for each facility summarize the cumulative results for a point of interest at the tower's base of the "worst-case" exposure calculations resulting from all carriers co-located on this tower. The calculations are in accordance with the Federal Communications Commission's Office of Engineering and Technology Bulletin No. 65 (1997), and for simplicity, an assumption is made that the antennas are all pointed down, thus focusing their energy at the tower's base.

For the foregoing reasons, Cingular respectfully submits that proposed changes at the these facilities constitute an exempt modification under RCOSA Section 16-50j-72(b)(2).

Please do not hesitate to call me at 215.790.1050 ext. 138 with questions concerning this notice. Thank you for your consideration of this matter.

Sincerely,

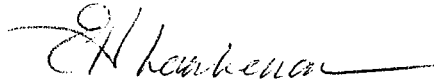

Elizabeth H. Lankenau, AICP  
Planner

Attachments

cc: Honorable Sebastian N. Giuliano, Mayor, City of Middletown

**290 Preston Road, Middletown, CT**

---

**Summary Sheet  
Project Location Map  
Site Plan and Elevation  
Structural Analysis  
Elected Official Letter**

**CINGULAR WIRELESS  
Proposed Modifications**

---

**Site Address:** 290 Preston Avenue, Middletown, CT; *Project Location Map attached*

**Site Owner:** Cingular

**Type of Existing Facility:** 150' high monopole; Cingular has an equipment shelter within a compound that is approximately 52' x 65'

**Antenna Configuration:** Center-line – 150'; Existing AT&T units to be replaced with six (6) Cingular Powerwave 7770 units; *specification attached*

**TMA Configuration:** Existing units to be removed and replaced with twelve (12) LGP 214nn units; *specification attached*

**Coaxial Cables:** Twelve (12) existing cables to remain

**Other Work:** The Cingular antenna, cables, and platform at 100' will be removed

**Power Density:**

As the table demonstrates, the cumulative worst-case exposure would be approximately 50.93% of the ANSI/IEEE standard, as calculated for mixed frequency sites. Total power density levels resulting from Cingular's use of the monopole facility would be within applicable standards.

Site # 1142								
Carrier	Antenna Height (ft)	Freq. (MHz) For Limit	# of Channels	W ERP/Channel (ref 1/2-w dipole)	W EIRP/Sector	Power Density ( $\mu\text{W}/\text{cm}^2$ )	FCC Limit ( $\mu\text{W}/\text{cm}^2$ )	Percent of Limit (%)
Cingular UMTS	150	1935.0	1	500.0	820.0	8.0	1000	0.80%
Cingular 800	150	880.0	20	250.0	8200.0	79.9	587	13.62%
Cingular 1900	150	1900.0	3	427.0	2100.8	20.5	1000	2.05%
T-Mobile	140	1900.0	12	250.0	4920.0	55.0	1000	5.50%
Sprint	130	1900.0	12	500.0	9840.0	127.7	1000	12.77%
Nextel	120	851.0	12	100.0	1968.0	30.0	567	5.28%
Verizon 800	110	880.0	9	200.0	2952.0	53.5	587	9.12%
Verizon 1900	110	1900.0	3	200.0	984.0	17.8	1000	1.78%
<b>TOTAL</b>								<b>50.93%</b>

**Structural Analysis:** *Structural Analysis* attached.

290 Preston Avenue  
Middletown, CT

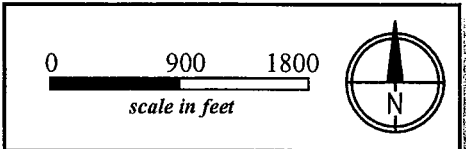
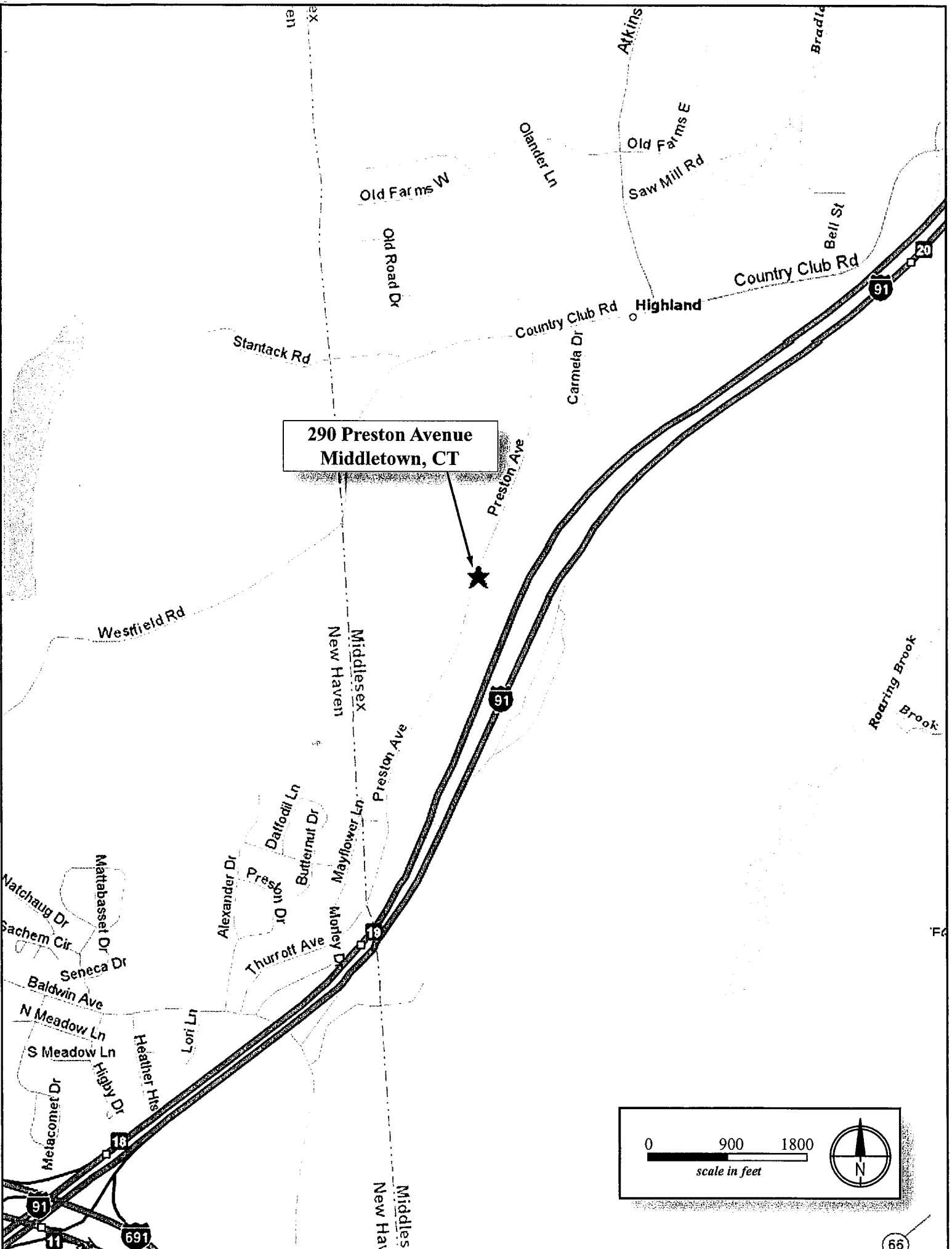

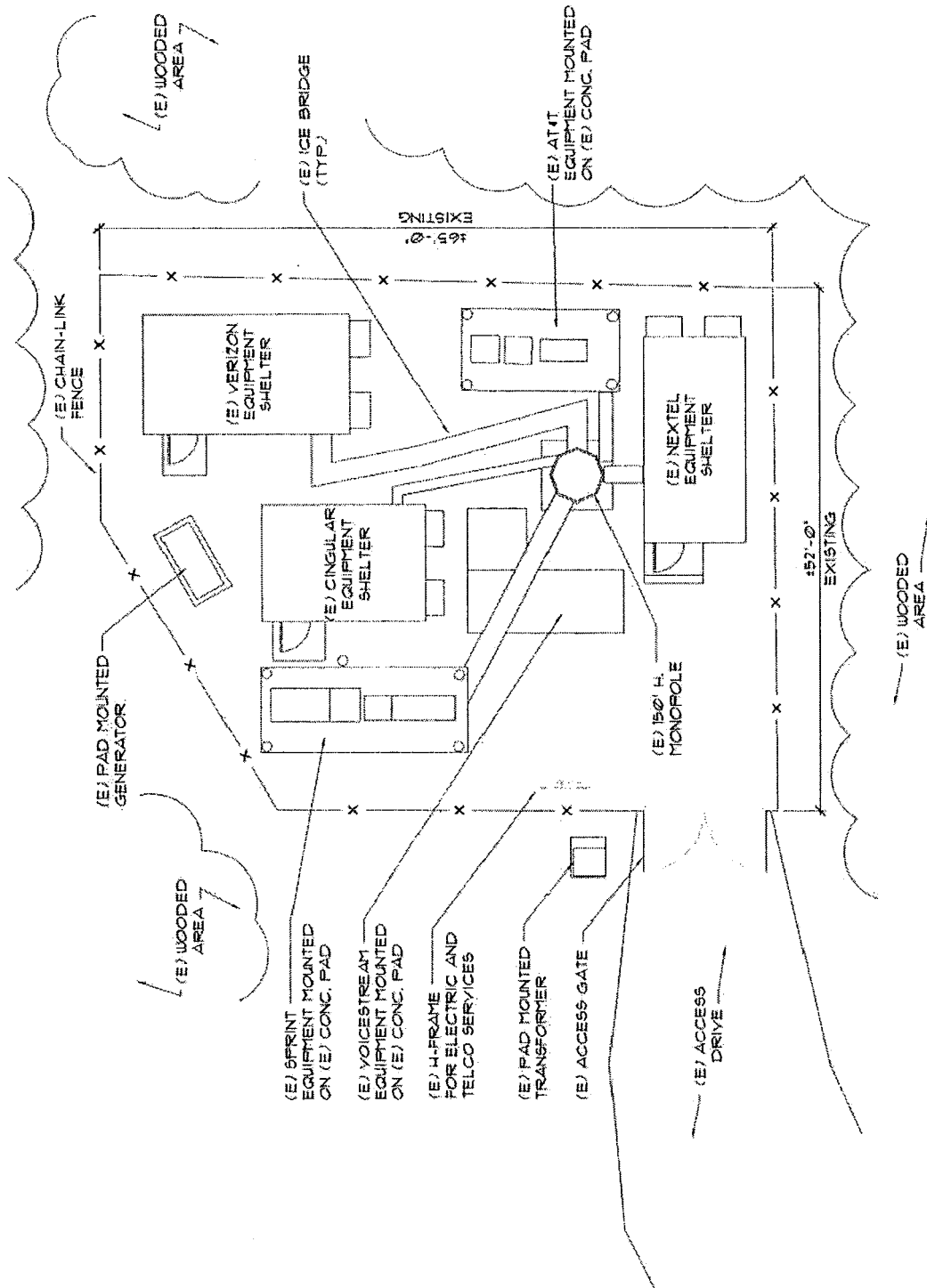

NORTH

1 EXISTING SITE PLAN

1/16" = 1'-0"

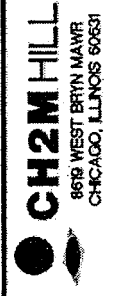
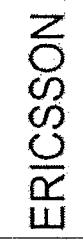

NO.	DATE	REVISION DESCRIPTION	BY	CHECKED BY	DATE
3	08-12-08	RESUBMITTED FOR CSC SUBMITTAL	JZ	JZ	
2	08-07-08	RESUBMITTED FOR CSC SUBMITTAL	JZ	JZ	
1	05-22-08	ISSUED FOR CSC REVIEW	PK	JZ	
CINGULAR WIRELESS SITE # 1142 SITE NAME: MIDDLETOWN 290 PRESSION AVE., MIDDLETOWN, IL 62457 DRAWING NUMBER: 1142 REV: 0					



14 June 2006

Honorable Sebastian N. Giuliano  
Mayor, City of Middletown  
245 deKoven Drive  
Middletown, CT 06457

**RE: Notice of Exempt Modification – Existing Cingular  
Telecommunications Tower Facility at 290 Preston Avenue,  
Middletown, Connecticut**

Dear Mr. Giuliano:

New Cingular Wireless PCS, LLC (“Cingular”) proposes to remove and replace telecommunications antennas and associated equipment located on an existing tower at the above-referenced location. The facility is now controlled and operated by Cingular whose corporate office is located at 500 Enterprise Drive, Rocky Hill, CT 06067.

**Proposed Modifications**

Cingular proposes to remove the existing antennas and replace them with a total of six (6) new antennas, located at an existing centerline height of approximately 150’ above ground level. Cingular will keep the existing coaxial cables but remove the existing tower mounted amplifiers and replace them with twelve (12) new units at the same height as the antennas.

In summary, the final antenna configuration at 290 Preston Avenue will include:

- 6 antennas,
- 12 coaxial cables, and
- 12 tower mounted amplifiers.

A structural evaluation has demonstrated that the monopole will be structurally capable of supporting the proposed Cingular telecommunications equipment once the proposed modifications are complete.

*James Nelson Kise, AIA/AICP/PP*

*James Bennett Straw, AIA*

*Harvey D. Kolodner, MBA*

*John R. Gibbons, AIA/AICP*

*Philip E. Scott, RA*

*Suzanna Barucco*

*LaVern Browne*

*Katherine E. Cowing, LEED*

*Johnette Davies*

*Petar D. Glumac, Ph.D.*

*Douglas S. Heckrotte, RA/LEED*

*Jody Holton, AICP*

*Marian Maxfield Hull, AICP/PP*

---

Kise Straw & Kolodner Inc.  
123 South Broad St.  
Suite 1270  
Philadelphia, PA 19109  
(215) 790-1050 FAX (215) 790-0215  
www.kskl.com

## 5. CONCLUSIONS AND RECOMMENDATIONS

The results of the analysis indicate that the tower structure is in compliance with the proposed loading conditions. **The tower and its foundation are structurally adequate under the wind load classification specified above and the proposed antenna loadings.**

### Limitations/Assumptions:

This report is based on the following:

1. Tower inventory as listed in this report.
2. Tower is properly installed and maintained.
3. All members are as specified in the original design documents and are in good condition.
4. All required members are in place.
5. All bolts are in place and are properly tightened.
6. Tower is in plumb condition.
7. All member protective coatings are in good condition.
8. All tower members were properly designed, detailed, fabricated, and installed and have been properly maintained since erection.
9. Foundations were properly constructed to support original design loads as specified in the original design documents.
10. All coaxial cable is installed within the monopole unless specified otherwise.

URS is not responsible for any modifications completed prior to or hereafter in which URS is not or was not directly involved. Modifications include but are not limited to:

- A. Adding antennas
- B. Removing/replacing antennas
- C. Adding coaxial cables

URS hereby states that this document represents the entire report and that it assumes no liability for any factual changes that may occur after the date of this report. All representations, recommendations, and conclusions are based upon information contained and set forth herein. If you are aware of any information which conflicts with that which is contained herein, or you are aware of any defects arising from original design, material, fabrication, or erection deficiencies, you should disregard this report and immediately contact URS. URS disclaims all liability for any representation, recommendation, or conclusion not expressly stated herein.

### Ongoing and Periodic Inspection and Maintenance:

After the Contractor has successfully completed the installation and the work has been accepted, the owner will be responsible for the ongoing and periodic inspection and maintenance of the tower.

The owner shall refer to TIA/EIA-222-F for recommendations for maintenance and inspection. The frequency of the inspection and maintenance intervals is to be determined by the owner based upon actual site and environmental conditions. It is recommended that a complete and thorough inspection of the entire tower structural system be performed at least yearly and more frequently as conditions warrant. According to TIA/EIA-222-F section 14.1, Note 1: It is recommended that the structure be inspected after severe wind and/or ice storms or other extreme loading conditions.

### 3. ANALYSIS METHODOLOGY AND LOADING CONDITIONS

The structural analysis was done in accordance with the 2005 Connecticut State Building Code, TIA/EIA-222-F—Structural Standard for Steel Antenna Towers and Antenna Supporting Structures, and the American Institute of Steel Construction (AISC) Manual of Steel Construction—Allowable Stress Design (ASD).

The analysis was conducted using RISA Tower 4.5. Two load conditions were evaluated as shown below which were compared to allowable stresses according to AISC and TIA/EIA.

Load Condition 1 = 85 mph Wind Load (without ice) + Tower Dead Load  
Load Condition 2 = 74 mph Wind Load (with ice) + Ice Load + Tower Dead Load

Please note that wind pressure is a function of velocity squared. Under Load Condition 2, a 25 percent reduction in wind pressure is allowed by code to account for the unlikelihood of the full wind pressure and ice load occurring at the same time. The same results may be achieved by utilizing a lower wind pressure without taking the 25 percent reduction, as shown above.

The TIA/EIA standard permits a one-third increase in allowable stresses for towers and monopoles less than 700 feet tall. For the purposes of this analysis, in computing the load capacity the allowable stresses of the tower members were increased by one-third.

### 4. FINDINGS AND EVALUATION

Combined axial and bending stresses on the monopole structure were evaluated to compare with allowable stresses in accordance with AISC. The calculated stresses under the proposed loading were within the allowable stresses. Detailed analysis and calculations for the proposed load condition are provided in section 6 of this report. The anchor bolts, base plate, and foundation were also found to be within allowable limits.

## 2. INTRODUCTION

The subject tower is located at 290 Preston Avenue in Middletown, Connecticut. The structure is a 148' steel monopole designed by Paul J. Ford And Company and manufactured by PennSummit Tubular, LLC.

The inventory is summarized in the table below:

<i>Antenna Type</i>	<i>Carrier</i>	<i>Mount</i>	<i>Antenna Centerline Elevation</i>	<i>Cable</i>
(6) Powerwave 7770.00 antennas and (12) Powerwave LGP21401 TMA's	Cingular (proposed)	Low-Profile Platform	150'	(12) new 1 5/8" coax cables (outside monopole) (1 row of 12 cables)
(9) EMS RR90-17-XXDP antennas and (9) TMA's	T-Mobile (existing)	Low-Profile Platform	140'	(18) 1 5/8" coax cables (within monopole)
(9) Decibel DB980 antennas	Sprint (existing)	Low-Profile Platform	130'	(9) 1 5/8" coax cables (within monopole)
(12) Decibel DB844H90E-XY	Nextel (existing)	Low-Profile Platform	120'	(12) 7/8" coax cables (within monopole)
(6) Decibel DB844H90E-XY antennas and (6) Decibel DB950F85E-M antennas	Verizon (existing)	Low-Profile Platform	110'	(12) 1 5/8" coax cables (within monopole)
(1) GPS antenna	(existing)	Stand-Off Mount	75'	(1) 1/2" coax cable (outside monopole)
(1) GPS antenna	(existing)	Stand-Off Mount	75'	(1) 1/2" coax cable (outside monopole)
(1) GPS antenna	(existing)	Stand-Off Mount	50'	(1) 1/2" coax cable (outside monopole)

This structural analysis of the communications tower was performed by URS Corporation (URS) for CH2Mhill/Cingular Wireless. The purpose of this analysis was to investigate the structural integrity of the existing tower with its existing and proposed antenna loads. This analysis was conducted to evaluate stress on the tower and the effect of forces to the foundation of the tower resulting from existing and proposed antenna arrangements.

1. EXECUTIVE SUMMARY

This report summarizes the structural analysis of the existing 148' steel monopole structure located at 290 Preston Avenue in Middletown, Connecticut. The analysis was conducted in accordance with the 2005 Connecticut State Building Code and the TIA/EIA-222-F standard for wind velocity of 85 mph and 74 mph concurrent with 1/2" ice. The antenna loading considered in the analysis consists of all existing and proposed antennas, transmission lines, and ancillary items as outlined in the Introduction Section of this report. The proposed Cingular modification is as follows:

Proposed Antenna and Mount	Carrier	Antenna Center Elevation
<b>Remove:</b> (1) Low Profile Platform, (9) existing antennas, all existing TMA's and coax cables	Cingular (Proposed)	@ 100'
<b>Remove:</b> (12) existing antennas and all existing TMA's and coax cables	Cingular (Proposed)	@ 150'
<b>Install:</b> (6) Powerwave 7770.00 antennas (12) Powerwave LGP21401 TMA's on the existing low-profile platform with (12) new 1 5/8" coax cables outside the monopole (flush to the tower—1 row of 12 cables).	Cingular (Proposed)	@ 150'

The results of the analysis indicate that the tower structure is in compliance with the proposed loading conditions. **The tower and its foundation are considered structurally adequate with the wind load classification specified above and all the existing and proposed antenna loading.**

This analysis is based on:

- 1) The tower structure's theoretical capacity, not including any assessment of the condition of the tower.
- 2) Tower geometry and structural member sizes taken from original construction drawings and structural calculations prepared by Paul J. Ford And Company, job number 29201-0230, dated February 26, 2000.
- 3) Antenna and mount configuration as specified on the following page of this report.

This report is only valid as per the assumptions and data utilized in this report for antenna inventory, mounts and associated cables. The user of this report shall field verify the assumption of the antenna and mount configuration as well as the physical condition of the tower. Notify the engineer in writing immediately if any of the information in this report is found to be other than specified.

If you should have any questions, please call

Sincerely,

URS Corporation

  
Richard A. Sambor, P.E.  
Manager Facilities Design



RAS/jek

cc: AA, DR, IA, CF/Book – URS

## **TABLE OF CONTENTS**

- 1. EXECUTIVE SUMMARY**
- 2. INTRODUCTION**
- 3. ANALYSIS METHODOLOGY AND LOADING CONDITIONS**
- 4. FINDINGS AND EVALUATION**
- 5. CONCLUSIONS AND RECOMMENDATIONS**
- 6. DRAWINGS AND DATA**
  - **RISA TOWER INPUT / OUTPUT SUMMARY**
  - **RISA TOWER DETAILED OUTPUT**
  - **ANCHOR BOLT AND BASE PLATE ANALYSIS**
  - **FOUNDATION ANALYSIS**

---

# DETAILED STRUCTURAL ANALYSIS AND EVALUATION OF EXISTING 148' MONOPOLE FOR NEW ANTENNA ARRANGEMENT

Cingular Site #1142  
290 Preston Avenue  
Middletown, Connecticut

---

*prepared for*

**CH2MHILL**

8619 West Bryn Mawr, Suite 615  
Chicago, IL 60631



Cingular Wireless  
580 Main Street  
Bolton, MA 01740

*prepared by*



URS CORPORATION  
500 ENTERPRISE DR, SUITE 3B  
ROCKY HILL, CT 06067  
TEL. 860-529-8882

36922916.00008  
CH2-006

Revision 2 June 13, 2006

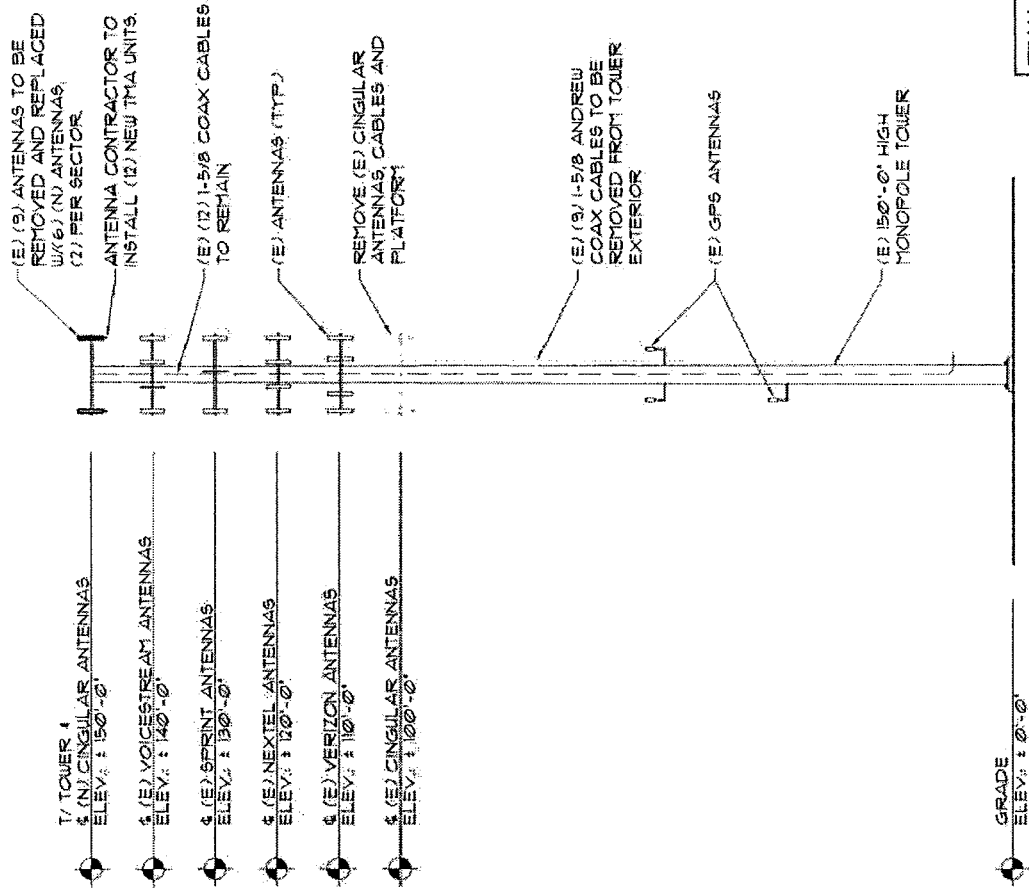

**FINAL ANTENNA CONFIGURATION**  
 (6) DIRECTIONAL ANTENNAS POWERWAVE # 7770  
 (12) 1-5/8" DIA. COAX CABLES  
 (12) TMAS

1 TOWER ELEVATION  
 T - 30'-0"



4	06-12-06	REISSUED FOR CSC SUBMITTAL	RR	JZ	JZ	CINGULAR WIRELESS SITE # 1142 SITE NAME: MIDDLETOWN 230 PRESTON AVE., MIDDLETOWN, IL 06452 DRAWING NUMBER REV
3	06-07-06	REISSUED FOR CSC SUBMITTAL	RR	JZ	JZ	
2	05-23-06	ISSUED FOR CSC REVIEW	EH	JZ	JZ	
1	04-04-06	SCOPING REVIEW	JZ	JZ	JZ	
		REVISION DESCRIPTION	BT	CHK/APPD		
SCALE: 1" = 30'-0"			CHECKED BY:	JZ	DRAWN BY:	JR
						1142
						0



### Statutory Considerations

The proposed work will not affect the height of the existing structure, nor will it alter the existing property boundaries. Furthermore, the proposed work will not increase noise levels at the facility's site boundary by six (6) decibels or more. Operation of additional antennas will not increase the radio frequency electromagnetic radiation power density, measured at the monopole base, to or above the standard adopted by the State of Connecticut and the Federal Communications Commission.

A Notice of Exempt Modification has been filed with the Connecticut Siting Council (CSC) as required by the Regulations of Connecticut State Agencies (RCSA), Section 16-50j-73. Please accept this letter as notification to the City of Middletown under Section 16-50j-73 that the proposed work constitutes an exempt modification pursuant to RCSA Section 16-50j-72(b)(2).

Should you have any questions or require additional information about the plans or the CSC's procedures, please do not hesitate to contact me (215.790.1050 ext. 138) or Mr. Derek Phelps, Executive Director, Connecticut Siting Council (860.827.2935).

Sincerely,

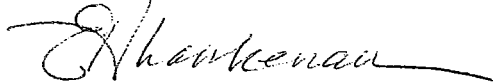
A handwritten signature in cursive script, appearing to read "Elizabeth H. Lankenau", with a long horizontal flourish extending to the right.

Elizabeth H. Lankenau, AICP  
Planner

**27 Butler Street, Meriden, CT**

---

**Summary Sheet  
Project Location Map  
Site Plan and Elevation  
Structural Analysis**

**CINGULAR WIRELESS  
Proposed Modifications**

---

**Site Address:** 27 Butler Street, Meriden, CT; *Project Location Map attached*

**Site Owner:** AT&T

**Type of Existing Facility:** Rooftop antenna

**Antenna Configuration:** Center line – 86’ above ground level; remove existing antennas and replace with six (6) Powerwave 7770 units; *specification attached*

**TMA Configuration:** Existing units to be removed and replaced with twelve (12) new LGP 214nn units; *specification attached*

**Coaxial Cables:** Nine (9) existing 1 5/8” diameter cables to remain and add three (3) new cables of the same diameter

**Power Density:**

As the table demonstrates, the cumulative worst-case exposure would be approximately 53.79% of the ANSI/IEEE standard, as calculated for mixed frequency sites. Total power density levels resulting from Cingular’s use of the facility would be within applicable standards.

Site # 1013								
Carrier	Antenna Height (ft)	Freq. (MHz) For Limit	# of Channels	W ERP/Channel (ref 1/2-w dipole)	W EIRP/Sector	Power Density ( $\mu\text{W}/\text{cm}^2$ )	FCC Limit ( $\mu\text{W}/\text{cm}^2$ )	Percent of Limit (%)
Cingular UMTS	83	1935.0	1	500.0	820.0	26.1	1000	2.61%
Cingular 800	83	880.0	20	250.0	8200.0	261.0	587	44.49%
Cingular 1900	83	1900.0	3	427.0	2100.8	66.9	1000	6.69%
<b>TOTAL</b>								<b>53.79%</b>

**Structural Analysis:** *Structural Analysis attached.*

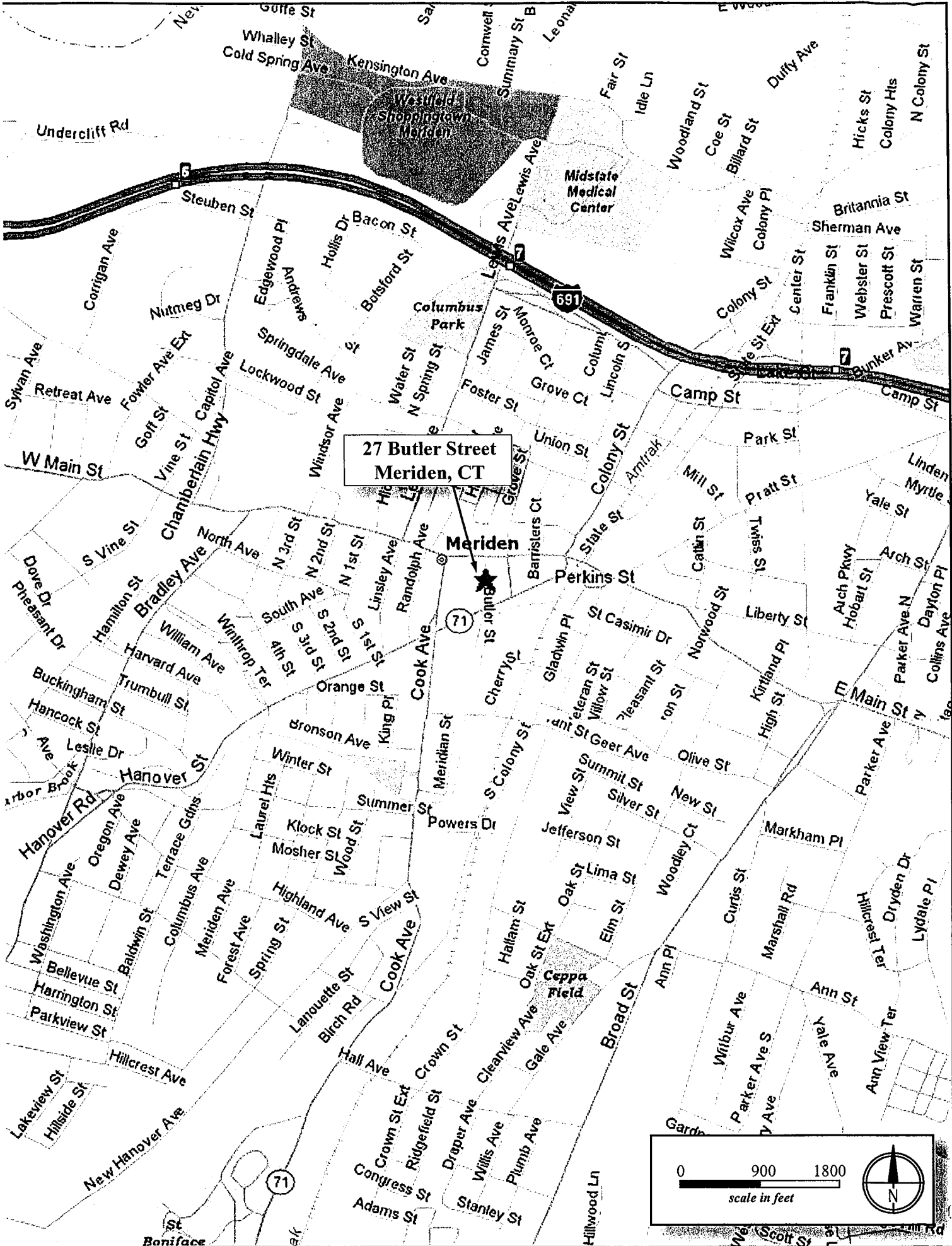

27 Butler Street  
Meriden, CT

Meriden

71

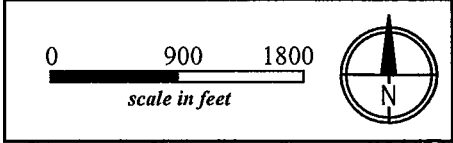

(E) ANTENNAS TO BE REMOVED AND REPLACED W/ (6) NEW ANTENNAS (2) PER SECTOR

ANTENNA CONTRACTOR TO INSTALL (12) NEW TMA UNITS. CONTRACTOR SHALL EXHAUST HIS EFFORTS TO CONCEAL TMA UNITS FROM VIEW

(E) (9) 1 5/8" ANDREW COAX TO REMAIN. ADD (3) (N) 1 5/8" COAX CABLES.

TOP (E) CINGULAR ANTENNAS  
ELEV.: ±80'-0"

TOP OF PENTHOUSE  
ELEV.: ±80'-0"

TOP OF WALL  
ELEV.: ±67'-0"

GRADE  
ELEV.: 0'-0"

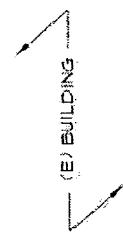

**FINAL ANTENNA CONFIGURATION**  
 (6) DIRECTIONAL ANTENNAS POWERWAVE # 7770  
 (12) 1-5/8" DIA. COAX CABLES  
 (12) TMAS

1 BUILDING ELEVATION  
1" = 20'-0"



2	08-16-08	ISSUED FOR ESC REVIEW	RR	JZ	JZ	CINGULAR WIRELESS	
1	03-19-08	SCOPING REVIEW	RR	JZ	JZ		
NO.	DATE	REVISION DESCRIPTION	BY	CHKD	APP'D		
SCALE: 1" = 20'-0"						CHECKED BY: JZ	DRAWN BY: RR
SITE #:						1013	REV
SITE NAME:						MERIDEN	
27 BUTLER STREET MERIDEN, CT 06450							
DRAWING NUMBER						1013	0



May 19, 2006

Mr. Thomas Sun, AIA  
CH2M Hill Communications Group  
8619 W. Bryn Mawr, Suite 615  
Chicago, IL 60631

Re: *Level 1 Structural Evaluation*  
*Cingular Site #1013*  
*27 Butler St.,*  
*Meriden, CT 06451*

Natcomm Project No. 06500.Co02-1013

Dear Mr. Sun,

We have reviewed the proposed Cingular UMTS antenna upgrade at the above referenced site. The purpose of the review is to determine the adequacy of an existing rooftop and third floor equipment room to support the proposed antennas and equipment cabinet respectively. The host building is a reinforced concrete structure originally designed for housing telephone-switching equipment. The review considered the effects of wind load, dead load, ice load and seismic forces in accordance with TIA/EIA-222-F and Connecticut State Building Code. Site assessment information obtained by Natcomm personnel on May 10, 2006 was used as reference material.

The existing antenna configuration is as follows:

- Cingular: Nine (9) DUO1417-8686-4-0 panel antennas individually sled mounted and fastened to cable tray support leg on rooftop at a rad center elevation of 42' AGL.

The proposed modified antenna loading is as follows:

- Cingular: Six (6) Powerwave 7770.00 panel antennas w/ twelve (12) Powerwave LGP21401 TMA's on existing sleds to replace six (6) of the existing panel antennas, the remaining three (3) antennas will be removed along with any associated mounting hardware.

Based on the information provided, the rooftop antenna mounting assemblies meet the requirements of the TIA/EIA-222-F Standard considering the basic wind speed (fastest mile) of 85 mph for New Haven County.

An (1) Ericsson RBS 3206F/E WCDMA Macro Indoor Base Station (maximum of 441lbs.) equipment cabinet is proposed at existing third floor equipment room. The weight of this equipment is within tolerable loading limits for the host building.

In conclusion, the host building (both rooftop and third floor equipment room) is adequate to support the proposed Cingular UMTS antenna upgrade and related equipment. If there are any questions regarding this matter, please feel free to call.

Submitted by

  
Carlo F. Centore, PE  
Project Manager

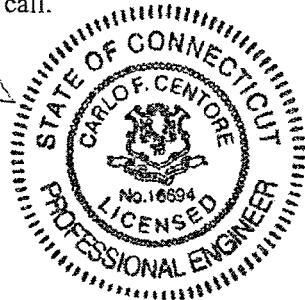

**Christian Hill Road, Cromwell, CT**

---

**Summary Sheet  
Project Location Map  
Site Plan and Elevation  
Structural Analysis**

**CINGULAR WIRELESS  
Proposed Modifications**

---

**Site Address:** Christian Hill Road, Cromwell, CT

**Site Owner:** Verizon Wireless

**Type of Existing Facility:** 82' tower linked to a concrete equipment pad by an ice bridge

**Antenna Configuration:** Center line – 102' above ground level; remove existing antennas and replace with six (6) Powerwave 7770 units; *specification attached*

**TMA Configuration:** Existing units to be replaced with twelve (12) new LGP 214nn units; *specification attached*

**Coaxial Cables:** Existing 1 5/8" diameter cables to remain

**Other Equipment:** One (1) Ericsson RBS 3106 equipment cabinet to be placed on an existing concrete pad

**Power Density:**

As the table demonstrates, the cumulative worst-case exposure would be approximately 52.66% of the ANSI/IEEE standard, as calculated for mixed frequency sites. Total power density levels resulting from Cingular's use of the facility would be within applicable standards.

Carrier	Antenna Height (ft)	Freq. (MHz) For Limit	# of Channels	W ERP/Channel (ref 1/2-w dipole)	W EIRP/Sector	Power Density ( $\mu\text{W}/\text{cm}^2$ )	FCC Limit ( $\mu\text{W}/\text{cm}^2$ )	Percent of Limit (%)
Cingular UMTS	102	1935.0	1	500.0	820.0	17.3	1000	1.73%
Cingular 800	102	880.0	20	250.0	8200.0	172.8	587	29.46%
Cingular 1900	102	1900.0	3	427.0	2100.8	44.3	1000	4.43%
Verizon 800	88	880.0	9	200.0	2952.0	83.6	587	14.25%
Verizon 1900	88	1900.0	3	200.0	984.0	27.9	1000	2.79%
<b>TOTAL</b>								<b>52.66%</b>

**Structural Analysis:** *Structural Analysis* attached.





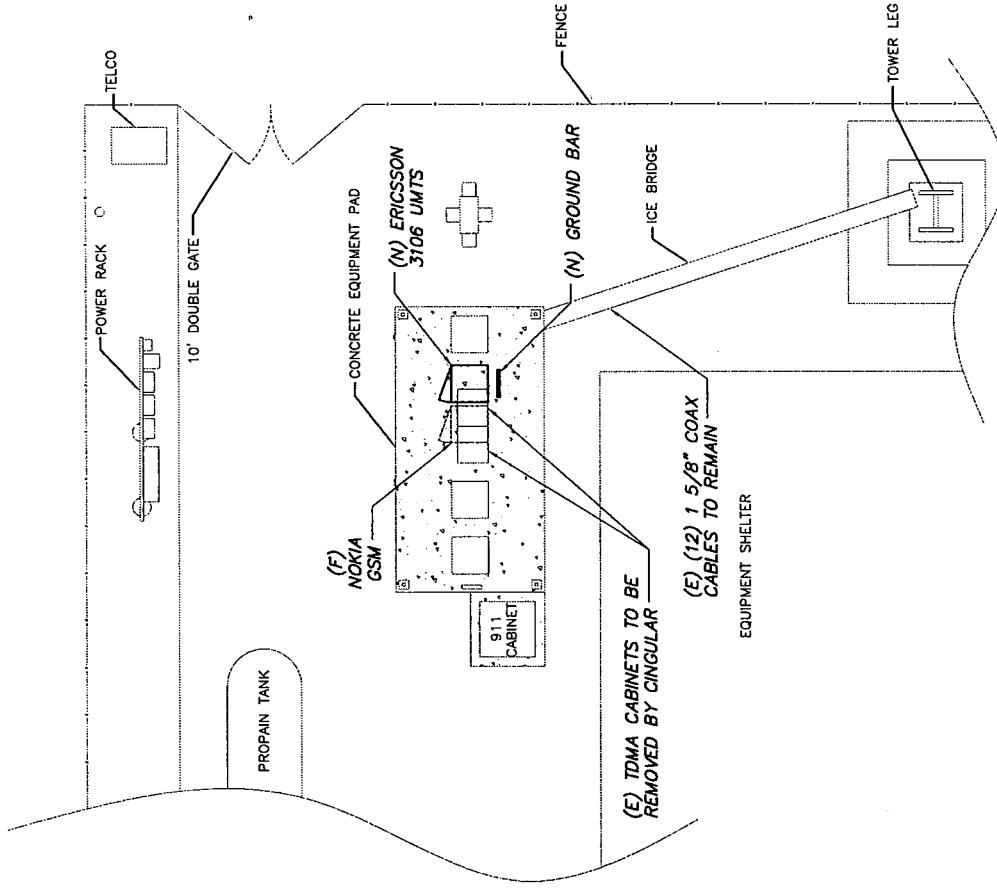

**SITE LAYOUT**  
SCALE: 1" = 10'-0"

LATITUDE: 41° 36' 20"  
LONGITUDE: 72° 42' 07"

CINGULAR WIRELESS  
580 MAIN STREET  
BOLTON, MA 01740

**ERICSSON**  
6300 LEGACY DRIVE  
PLANO, TX 75024

**CH2MHILL**  
8619 WEST BRYN MAWR  
CHICAGO, ILLINOIS 60631

infinigy  
engineering  
300 GREAT OAKS BLVD.  
SUITE 312203  
ALBANY, NY 12203  
OFFICE: (518) 480-0790  
FAX: (518) 680-0793  
185-047

**SITE NAME: CROMWELL SOUTH**  
**SITE NUMBER: 5144**  
CHRISTIAN HILL ROAD  
CROMWELL, CT 06416

NO.	DATE	REVISION DESCRIPTION	BY	CHK	APP'D
3	05/18/06	MISC. REVISIONS	PHR	CJW	CJW
2	05/09/06	MISC. REVISIONS	PHR	CJW	CJW
1	04/11/06	MISC. REVISIONS	PHR	CJW	CJW
0	04/10/06		MAK	CJW	CJW
SITE NUMBER			5144		

## **Specifications for Proposed New Equipment**

---

**290 Preston Avenue, Middletown, CT  
27 Butler Street, Meriden, CT  
Christian Hill Road, Cromwell, CT**

## 5. CONCLUSIONS

The results of the analysis indicate that the existing sign structure, pipe mast, and foundation are in compliance with the proposed loading conditions. **The sign structure, pipe mast, and foundation are considered structurally adequate with the wind load classification specified above and all the existing, future, and proposed antenna loading.**

### Limitations/Assumptions:

This report is based on the following:

1. Sign Structure inventory as listed in this report.
2. Sign Structure is properly installed and maintained.
3. All members are as specified in the original design documents and are in good condition.
4. All required members are in place.
5. All bolts are in place and are properly tightened.
6. Sign Structure is in plumb condition.
7. All member protective coatings are in good condition.
8. All tower members were properly designed, detailed, fabricated, and installed and have been properly maintained since erection.
9. Foundations were properly constructed to support original design loads as specified in the original design documents.
10. The installation of the pipe mast must be complete and approved by the Engineer of Record based on the Pipe Mast Construction Drawings (URS Job No. 36922058) prepared by URS Corporation AES, dated January 12, 2006, prior to any Cingular antenna work.

URS is not responsible for any modifications completed prior to or hereafter in which URS is not or was not directly involved. Modifications include but are not limited to:

- A. Adding antennas
- B. Removing/replacing antennas
- C. Adding coaxial cables

URS hereby states that this document represents the entire report and that it assumes no liability for any factual changes that may occur after the date of this report. All representations, recommendations, and conclusions are based upon information contained and set forth herein. If you are aware of any information which conflicts with that which is contained herein, or you are aware of any defects arising from original design, material, fabrication, or erection deficiencies, you should disregard this report and immediately contact URS. URS disclaims all liability for any representation, recommendation, or conclusion not expressly stated herein.

### Ongoing and Periodic Inspection and Maintenance:

After the Contractor has successfully completed the installation and the work has been accepted, the owner will be responsible for the ongoing and periodic inspection and maintenance of the structure.

The owner shall refer to TIA/EIA-222-F for recommendations for maintenance and inspection. The frequency of the inspection and maintenance intervals is to be determined by the owner based upon actual site and environmental conditions. It is recommended that a complete and thorough inspection of the entire structural system be performed at least yearly and more frequently as conditions warrant. According to TIA/EIA-222-F section 14.1, Note 1: It is recommended that the structure be inspected after severe wind and/or ice storms or other extreme loading conditions.

### 3. ANALYSIS METHODOLOGY AND LOADING CONDITIONS

The structural analysis was done in accordance with the 2005 Connecticut State Building Code, the TIA/EIA-222-F—Structural Standard for Steel Antenna Towers and Antenna Supporting Structures, and the American Institute of Steel Construction (AISC) Manual of Steel Construction—Allowable Stress Design (ASD).

The analysis was conducted using Staad.Pro.2005. Two load conditions were evaluated as shown below which were compared to allowable stresses according to AISC and TIA/EIA.

Load Condition 1 = 85 mph (fastest mile) Wind Load (without ice) + Tower Dead Load  
Load Condition 2 = 74 mph (fastest mile) Wind Load (with ice) + Ice Load + Tower Dead Load

The TIA/EIA standard permits a one-third increase in allowable stresses for towers and monopoles less than 700 feet tall. For the purposes of this analysis, in computing the load capacity the allowable stresses of the tower members were increased by one-third.

### 4. FINDINGS AND EVALUATION

Combined axial and bending stresses on the sign structure and pipe mast were evaluated to compare with allowable stresses in accordance with AISC. Detailed analysis and calculations for the proposed load condition are provided in section 6 of this report.

## 2. INTRODUCTION

This structural analysis of the communications structure was performed by URS Corporation AES (URS) for CH2MHILL/Cingular Wireless. The subject structure is located on Christian Hill Road in Cromwell, Connecticut. The structure is a 82' self-supporting sign structure with a 111' pipe mast. This analysis was conducted to evaluate stress on the sign structure and the effect of forces to the foundation of the structure resulting from existing, future, and proposed antenna arrangements.

The inventory is summarized in the table below:

<i>Antenna Type</i>	<i>Carrier</i>	<i>Mount</i>	<i>Antenna Centerline Elevation</i>	<i>Cable</i>
(9) EMS DR65-19-00DPQ antennas	T-Mobile (future)	Low Profile Platform on (1) 111' Pipe Mast	108'	(24) 1 5/8" coax cables (within pipe mast)
(6) Powerwave 7770.00 antennas (12) Powerwave LGP21401 TMA's	Cingular (proposed)	Pipe Mounts	98'	(12) 1 5/8" coax cables
(9) ALP 9212 antennas and (6) Antel LPA-185090/8CF antennas	Verizon (existing)	(1) Platform with handrails	88'	(15) 7/8" coax cables
(1) VIC-100 GPS antenna	T-Mobile (future)	Side Arm Mount on Leg of Sign Structure	50'	(1) 1/2" coax cable

1. EXECUTIVE SUMMARY

This report summarizes the structural analysis of the existing 82' sign structure with 111' pipe mast located on Christian Hill Road in Cromwell, Connecticut. The analysis was conducted in accordance with the 2005 Connecticut State Building Code and the TIA/EIA-222-F standard for wind velocity of 85 mph (fastest mile) and 74 mph (fastest mile) concurrent with 1/2" ice. The antenna loading considered in the analysis consists of all existing, future, and proposed antennas, transmission lines, and ancillary items as outlined in the Introduction Section of this report. The proposed Cingular modification is as follows:

Proposed Antenna and Mount	Carrier	Antenna Center Elevation
<b>Remove:</b>		
<b>(12) existing antennas</b>		
<b>Install:</b>		
<b>(6) Powerwave 7770.00 antennas</b>	<b>Cingular (Proposed)</b>	<b>@ 98'</b>
<b>(12) Powerwave LGP21401 TMA's on the existing pipe mounts with (12) existing 1 5/8" coax cables mounted to the leg of the sign structure.</b>		

The results of the analysis indicate that the existing sign structure, pipe mast, and foundation are in compliance with the proposed loading conditions. **The sign structure, pipe mast, and foundation are considered structurally adequate with the wind load classification specified above and all the existing, future, and proposed antenna loading.**

This analysis is based on:

- 1) The sign structure's theoretical capacity, not including any assessment of the condition of the tower.
- 2) Sign structure's geometry and structural member sizes taken from Tower Climb Report prepared by Pinnacle Site Development, dated July 20, 2000; and reinforcement construction drawings (URS Job No. F301824.59) prepared by URS Corporation AES, dated March 28, 2001.
- 3) Antenna and mount configuration as specified on the following page of this report.
- 4) The installation of the pipe mast must be complete and approved by the Engineer of Record based on the Pipe Mast Construction Drawings (URS Job No. 36922058) prepared by URS Corporation AES, dated January 12, 2006, prior to any Cingular antenna work.

This report is only valid as per the assumptions and data utilized in this report for antenna inventory, mounts and associated cables. The user of this report shall field verify the assumption of the antenna and mount configuration as well as the physical condition of the structure and all connections. Notify the engineer in writing immediately if any of the information in this report is found to be other than specified.

If you should have any questions, please call.

Sincerely,

URS Corporation AES

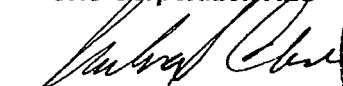
  
Richard A. Sambor, P.E.  
Manager Facilities Design

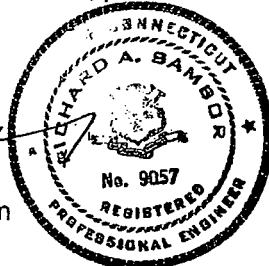

RAS/jek

cc: AA, DR, IA – URS  
CF/Book

## **TABLE OF CONTENTS**

- 1. EXECUTIVE SUMMARY**
- 2. INTRODUCTION**
- 3. ANALYSIS METHODOLOGY AND LOADING CONDITIONS**
- 4. FINDINGS AND EVALUATION**
- 5. CONCLUSIONS**
- 6. DRAWINGS AND DATA**
  - **WIND LOAD CALCULATIONS**
  - **STAAD INPUT / OUTPUT**



---

# DETAILED STRUCTURAL ANALYSIS AND EVALUATION OF EXISTING 82' SIGN STRUCTURE WITH 111' PIPE MAST FOR NEW ANTENNA ARRANGEMENT

Cingular Site #5144  
Christian Hill Road  
Cromwell, Connecticut

---

*prepared for*

**CH2MHILL**

8619 West Bryn Mawr, Suite 615  
Chicago, IL 60631



Cingular Wireless  
580 Main Street  
Bolton, MA 01740

*prepared by*



URS CORPORATION  
500 ENTERPRISE DR, SUITE 3B  
ROCKY HILL, CT 06067  
TEL. 860-529-8882

36922936.00008  
CH2-026

May 12, 2006

(E) CINGULAR ANTENNAS TO BE REPLACED WITH (6) POWERWAVE ANTENNAS. (2) PER SECTOR, (3) SECTORS TOTAL (TYP.)

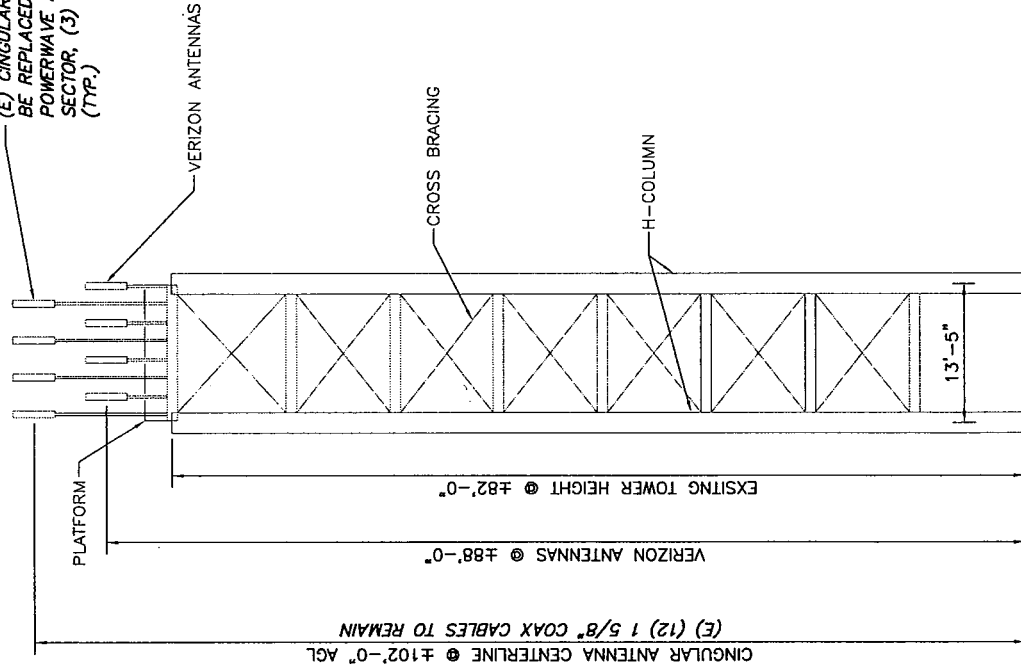

ANTENNA CONTRACTOR TO INSTALL (12) NEW TMA UNITS. (TOTAL TMA UNITS = 12)

**TOWER ELEVATION**

SCALE: NTS

LATITUDE: 41° 36' 20"  
LONGITUDE: 72° 42' 07"



CINGULAR WIRELESS  
540 MAIN STREET  
BOLTON, MA 01740

ERICSSON  
6300 LEGACY DRIVE  
PLANO, TX 75024

**CH2MHILL**  
8619 WEST BRYN MAWR  
CHICAGO, ILLINOIS 60631

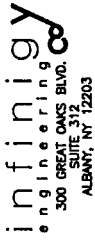

SUITE 312  
300 GREAT OAKS BLVD.  
ALBANY, NY 12203  
OFFICE: (518) 890-0790  
FAX: (518) 890-0795  
185-047

SITE NAME: CROMWELL SOUTH  
SITE NUMBER: 5144  
CHRISTIAN HILL ROAD  
CROMWELL, CT 06416

3	05/18/06	MISC. REVISIONS	PHR	CJW	CJW
2	05/09/06	MISC. REVISIONS	PHR	CJW	CJW
1	04/11/06	MISC. REVISIONS	PHR	CJW	CJW
0	04/10/06		MAX	CJW	CJW
NO.	DATE	REVISION DESCRIPTION	BY	CHK	APP'D
					SITE NUMBER
					5144

### 3 Dimensions

This section describes the physical characteristics of the RBS: dimensions, weight, and color.

Table 1 The RBS Dimensions

Unit	Dimensions (mm)
Height	1626
Width	1300
Depth	710
Depth including door	926

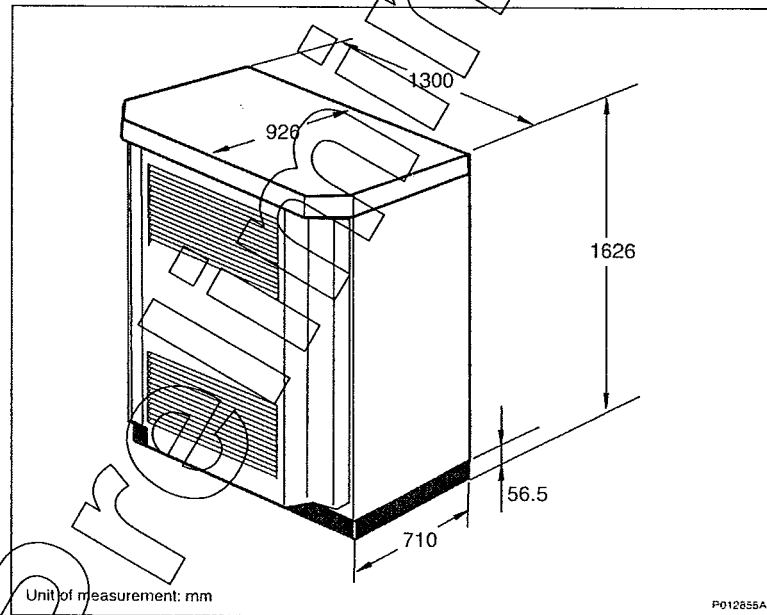

Figure 2 RBS 3106 Dimensions

The RBS weight is shown in the table below.

Table 2 The RBS Weight

Unit	Weight (kg)
RBS fully equipped excluding batteries	560
RBS fully equipped including batteries	850
RBS fully equipped including batteries and future expansion of hardware (not yet available)	875
Installation frame	12

The RBS color is shown in the table below.

Table 3 The RBS Color

Color	Color Standard
Grey	RAL 7035
Green	NCS 8010-G 10 Y

Preliminary

# Dual Broadband Antenna

90° 1.4 m MET Antenna

806-960/1710-2170 MHz

Part Number:  
7770.00

Horizontal Beamwidth: 90°  
Gain: 13.5/16 dBi

Electrical Downtilt: Adjustable  
Connector Type: 7/16 female

The Powerwave dual band dual polarized broadband antenna has individual adjustable electrical downtilt per band (upgradeable to Remote Electrical Tilt (RET)). Four connector ports allow separate tilts on each frequency band and ensure the use of diversity concepts. The phase shifter technology, based on a patented sliding dielectric, minimizes intermodulation distortion and maximizes efficiency. The slant +/- 45° dual polarization system provides the independent fading signals needed for achieving top-quality coverage via diversity concepts. The Powerwave Broadband antenna design is based on a patented stacked aperture-coupled patch technology, which provides high isolation performance and a wide VSWR bandwidth. The antennas have superior radiation patterns due to a unique reflector design which provides a very small variation of the -3dB horizontal beam width over the frequency band as well as a high front-to-back ratio.



## Key Benefits

- Excellent broad- and multi-band capabilities
- Polarization purity makes good diversity gain
- Excellent pattern performance and high gain over frequency
- High passive intermodulation performance
- Light, slim and robust design

# Preliminary

ANTENNA  
SYSTEMS

BASE STATION  
SYSTEMS

COVERAGE  
SYSTEMS

THE POWER IN WIRELESS®

 **Powerwave**  
technologies

806-960/1710-2170 MHz

## Dual Broadband Antenna

### Electrical Specifications (Preliminary)

Frequency band (MHz)	806-960	1710-2170
Gain, $\pm 0.5$ dB (dBi)	13.5	16.0
Polarization	Dual linear $\pm 45^\circ$	
Nominal Impedance (Ohm)	50	
VSWR	1.5:1	
VSWR		1.5:1
Isolation between inputs (dB)	30	
Isolation between inputs (dB)		30
Inter band isolation (dB)	40	
Horizontal -3 dB beamwidth	$85 \pm 5^\circ$	$85 \pm 5^\circ$
Tracking, Horizontal plane, $\pm 60^\circ$ (dB)	<2.0	
Tracking, Horizontal plane, $\pm 60^\circ$ (dB)		<2.0
Electrical downtilt range (adjustable)	$0^\circ$ to $10^\circ$	$0^\circ$ to $8^\circ$
Vertical -3 dB beamwidth	$14.3 \pm 2.0^\circ$	$6.6 \pm 1^\circ$
Sidelobe suppression, Vertical 1 st upper (dB)	>17,16,15 x=0, 5, 10° MET	> 17, 16,15 x=0, 4, 8° MET
Vertical beam squint	<0.8°	<0.5°
First null-fill (dB)	<-25	<-25
Front-to-back ratio (dB)	>25	>27
Front-to-back ratio, total power (dB)	>20	>23
IM3, 2Tx@43dBm (dBc)	<-153	
IM3, 2Tx@43dBm (dBc)		<-153
IM7, 2Tx@43dBm (dBc)		<-160
Power Handling, Average per input (W)	400	250
Power Handling, Average total (W)	800	500

All specifications are subject to change without notice.  
Contact your Powerwave representative for complete performance data.

### Mechanical Specifications

Connector Type	4 x 7/16 DIN female
Connector Position	Bottom
Dimensions, HxWxD	1408mm x 280mm x 125mm (55"x11"x5")
Weight Including Brackets	15.8 kg (35 lbs)
Wind Load, Frontal, 42m/s Cd=1	435N (98 lbf)
Survival Wind Speed (m/s)	70 (156mph)
Lightning Protection	DC grounded
Radome Material	GRP
Radome Color	Light Gray
Mounting	Pre-mounted Standard Brackets
Packing Size	1550mm x 355mm x 255mm (61"x14"x10")

Corporate Headquarters  
Powerwave Technologies, Inc.  
1801 East St. Andrew Place  
Santa Ana, CA 92705 USA  
Tel: 714-466-1000  
Fax: 714-466-5800  
www.powerwave.com

Main European Office  
Antennvägen 6  
SE-187 80 Täby  
Sweden  
Tel: +46 8 540 822 00  
Fax: +46 8 540 823 40

Main Asia Pacific Office  
23 F Tai Yau Building  
181 Johnston Road  
Wanchai, Hong Kong  
Tel: +852 2512 6123  
Fax: +852 2575 4860



©Copyright March 2005, Powerwave Technologies, Inc. All Rights reserved. Powerwave, Powerwave Technologies, The Power in Wireless and the Powerwave logo are registered trademarks of Powerwave Technologies, Inc.

COVERAGE AND CAPACITY

TECHNOLOGY LEADERSHIP

GLOBAL PARTNER

INTEGRATED SOLUTIONS

QUALITY AND RELIABILITY

# Tower Mounted Amplifier

Dual Band 1900 MHz with 850 MHz Bypass

1900/850 MHz

Part Number:  
LGP 214nn

Up-link: 1850-1910 MHz  
Down-link: 1930-1990 MHz  
Bypass: 824-894 MHz

Gain: 12 dB  
Noise Figure: < 1.7 dB

The Powerwave® TMA-DD 1900/850 is a dual band Tower Mounted Amplifier (TMA) to be installed near the antenna. Deployed in an AMPS, GSM, GPRS, EDGE and CDMA network it will increase capacity and coverage as well as extend the battery life time for the handsets. The TMA System will provide enhanced coverage and improved up-link signal quality. Appropriate for new rollouts by optimizing coverage with a reduced number of BTSs or as an upgrade to existing BTSs for enhancing the existing coverage.

Extended band TMA facilitates simplified logistics, especially when the frequency bands are scattered. The unit comprises of high Q band-pass filters, dual balanced low noise amplifiers with circuits for active bias, supervision, alarms and lightning protection circuit. The Powerwave patented design with all active components integrated within the filter body provides an extremely reliable, compact and lightweight TMA solution. The vented enclosure design is employed to prevent the effect of condensation, thereby guaranteeing long, reliable, maintenance-free service in all environmental conditions. These TMAs offer an easy to install, maintenance free, cost effective solution for coverage enhancement and increased quality in mobile communication networks.

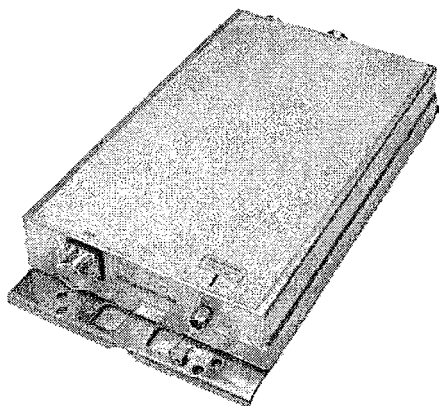

#### Key Benefits:

- 850 MHz Bypass
- Improved Network Quality
- Increased Coverage
- State of the Art Performance
- Excellent Power Handling
- Low Tx Loss
- Exceptional Reliability

ANTENNA  
SYSTEMS

BASE STATION  
SYSTEMS

COVERAGE  
SYSTEMS

# Tower Mounted Amplifier

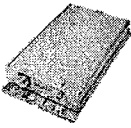

1900/850 MHz

## Technical Specifications

Product Number	LGP214nn	824-894
850 MHz	Bypass (MHz)	> 20
	Return loss* (dB)	< 0.3
	Insertion loss* (dB)	< 0.3
1900 MHz		
Up-link	Frequency range, full band (60 MHz)	1850-1910
	Nominal gain (dB)	12
	Return loss* (dB)	> 20
	Noise figure* (dB)	< 1.7
	Output 3rd order Intercept Point* (dBm)	> +23
Down-link	Frequency range, full band (60 MHz)	1930-1990
	Insertion loss* (dB)	< 0.6
	Return loss* (dB)	> 20
Intermodulation	2 Tx@x43 dBm (dBc)	<-158
Alarm Functionality	Two levels, individually supervised LNAs	
Power Consumption	@12 VDC	1.2 W

\* Typical

All specifications subject to change without notice. Please contact your Powerwave representative for complete performance data.

## Mechanical Specifications

Size, W x H x D (without mounting plate)	235 x 366 x 66 mm (9.2 x 14.4 x 2.6 in)
Weight	6.4 kg (14.1 lbs)
Color	Off white (NCS 1502-R)
Housing	Aluminum
RF-connectors	DIN 7/16 female.
Mounting kit	Mounting kit for pole and wall is included
Temperature range	-40 °C to +65 °C (-40 °F to +149 °F)
MTBF	>1 million hours
Safety	UL 60 950
Ingress protection, IP 65	EN 60 529
Environmental	ETS 300 019
EMC	FCC Part 15

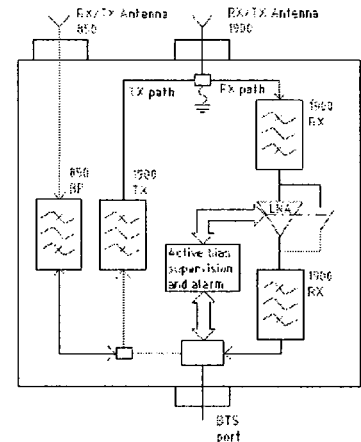

D031-08422 Rev. A Pg. 2 of 2

Corporate Headquarters  
 Powerwave Technologies, Inc.  
 1801 East St. Andrew Place  
 Santa Ana, CA 92705 USA  
 Tel: 714-466-1000  
 Fax: 714-466-5800  
 www.powerwave.com

Main European Office  
 Antennvägen 6  
 SE-187 80 Täby  
 Sweden  
 Tel: +46 8 540 822 00  
 Fax: +46 8 540 823 40

Main Asia-Pacific Office  
 23 F Tai Yau Building  
 181 Johnston Road  
 Wanchai, Hong Kong  
 Tel: +852 2512 6123  
 Fax: +852 2575 4860



©Copyright 2006, Powerwave Technologies, Inc. All Rights reserved. Powerwave, Powerwave Technologies, The Power in Wireless and the Powerwave logo are registered trademarks of Powerwave Technologies, Inc.





## **Specification for Existing Antennas**

---

**DUO 1417**



*Directing our energies for you.*

## Dual Band Antenna DUO1417-8686

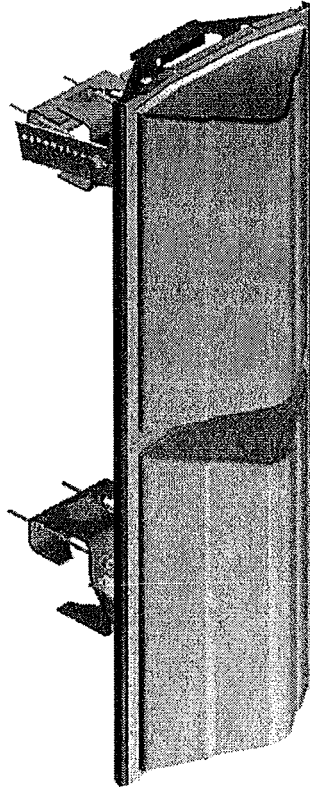

86 & 86 Azimuth Beams  
15 & 7 Elevation Beams  
14.0 & 16.0 dBi Gain

- PCS & Cellular in One Package
- Independent Control of Electrical Beam Downtilt
- High Power Handling Capability
- Anti-Corrosion Design for Superb IM Performance
- Available With Optional Internal Dual Band Combiner



Directing our energies for you.

# Dual Band Antenna DUO1417- 8686

## Electrical Specifications

Frequency Range  
Gain  
Electrical Downtilt Options  
VSWR  
VSWR (with -i option)  
Front-to-Back at Horizon  
Upper Side Lobe Suppression  
Elevation Beam (3-dB Points)  
Azimuth Beam (3-dB Points)  
Polarization  
Impedance  
Power Input Rating  
Intermodulation Specification

## Cellular

806-900 MHz  
14.0 dBi  
0, 2, 4 or 6 Degrees  
1.35:1 Maximum  
1.40:1 Maximum  
> 25 dB  
< -17 dB  
15 Degrees  
86 Degrees  
Vertical  
50 Ohms  
500 CW  
<-110dBm at 2x10W

## PCS

1850-1990 MHz  
16.0 dBi  
0 or 4 Degrees  
1.35:1 Maximum  
1.40:1 Maximum  
> 30 dB  
< -18 dB  
7 Degrees  
86 Degrees  
Vertical  
50 Ohms  
200 CW  
<-110dBm at 2x10W

## Mechanical Specifications

Input Connectors (female)  
Antenna Dimensions  
Antenna Weight  
Antenna Weight (w/opt. 'i')  
Bracket Weight  
Lightning Protection  
RF Distribution

Two Back Mounted 7/16 DIN (Silver Finish)  
48.4 x 14 x 9 Inches (10.7" deep with option 'i')  
20.3 lbs  
32.0 lbs  
10.5 lbs  
Direct Ground  
Cellular: Silver Plated Brass  
PCS: Printed Microstrip Substrate  
Ultra High-Strength Luran  
UV Stabilized, ASTM D1925  
ASTM D570, 0.45%  
MIL-STD-810E  
150 mph  
124 lbs  
2.54 sq-ft. (c=2)  
Fits 2.5 to 3 Inch Schedule 40 Pipe  
0-12 Degrees in 1 Degree Increments  
Hot Dip Galvanized Steel/Stainless Steel

Radome  
Weatherability  
Radome Water Absorption  
Environmental  
Wind Survival  
Front Wind Load at 100 mph  
Front Flat Plate Equivalent  
Mounting Brackets  
Mechanical Downtilt Range  
Clamps/Bolts

## Ordering Information

### Model

DUO1417- 8686-xy

DUO1417-8686-xyi

### Options

x=Electrical Downtilt at 800 MHz in Degrees (0, 2, 4 or 6)

y=Electrical Downtilt at 1900 MHz in Degrees (0 or 4)

i=Dual Band Combiner included as an internal device