

# STATE OF CONNECTICUT

## CONNECTICUT SITING COUNCIL

Ten Franklin Square, New Britain, CT 06051

Phone: (860) 827-2935 Fax: (860) 827-2950

E-Mail: [siting.council@ct.gov](mailto:siting.council@ct.gov)

Internet: [ct.gov/csc](http://ct.gov/csc)

Daniel F. Caruso  
Chairman

April 13, 2009

Carrie L. Larson, Esq.  
Pullman & Comley, LLC  
90 State House Square  
Hartford, CT 06103-3702

RE: **EM-POCKET-033-090320** – Youghiogheny Communications-Northeast, LLC d/b/a Pocket Communications notice of intent to modify an existing telecommunications facility located at 100 Berlin Road (a/k/a Christian Hill Road Site), Cromwell, Connecticut.

Dear Attorney Larson:

The Connecticut Siting Council (Council) hereby acknowledges your notice to modify this existing telecommunications facility, pursuant to Section 16-50j-73 of the Regulations of Connecticut State Agencies.

The proposed modifications are to be implemented as specified here and in your notice dated March 19, 2009, including the placement of all necessary equipment and shelters within the tower compound. The modifications are in compliance with the exception criteria in Section 16-50j-72 (b) of the Regulations of Connecticut State Agencies as changes to an existing facility site that would not increase tower height, extend the boundaries of the tower site, increase noise levels at the tower site boundary by six decibels, and increase the total radio frequencies electromagnetic radiation power density measured at the tower site boundary to or above the standard adopted by the State Department of Environmental Protection pursuant to General Statutes § 22a-162. This facility has also been carefully modeled to ensure that radio frequency emissions are conservatively below State and federal standards applicable to the frequencies now used on this tower.

This decision is under the exclusive jurisdiction of the Council. Please be advised that the validity of this action shall expire one year from the date of this letter. Any additional change to this facility will require explicit notice to this agency pursuant to Regulations of Connecticut State Agencies Section 16-50j-73. Such notice shall include all relevant information regarding the proposed change with cumulative worst-case modeling of radio frequency exposure at the closest point of uncontrolled access to the tower base, consistent with Federal Communications Commission, Office of Engineering and Technology, Bulletin 65. Any deviation from this format may result in the Council implementing enforcement proceedings pursuant to General Statutes § 16-50u including, without limitation, imposition of expenses resulting from such failure and of civil penalties in an amount not less than one thousand dollars per day for each day of construction or operation in material violation.

Thank you for your attention and cooperation.

Very truly yours,

  
S. Derek Phelps  
Executive Director

SDP/CDM/laf

c: The Honorable Jeremy J. Shingleton, First Selectman, Town of Cromwell  
Frederic Curtin, Zoning Enforcement Officer, Town of Cromwell  
Shanner Hotel Group



CONNECTICUT SITING COUNCIL

Affirmative Action / Equal Opportunity Employer

**PULLMAN & COMLEY, LLC**  
ATTORNEYS AT LAW

**CARRIE L. LARSON**  
90 State House Square  
Hartford, CT 06103-3702  
p (860) 424-4312  
f (860) 424-4370

**EM-POCKET-033-090320**

www.pullcom.com

March 19, 2009

**Via Federal Express**

S. Derek Phelps, Executive Director  
Connecticut Siting Council  
Ten Franklin Square  
New Britain, CT 06051

ORIGINAL  
RECEIVED  
MAR 20 2009

**Re: Notice of Exempt Modification  
Shaner Hotel Group Telecommunications Facility  
100 Berlin Road (a/k/a Christian Hill Road site), Cromwell, Connecticut**

Dear Mr. Phelps:

Youghioghenny Communications-Northeast, LLC, doing business as Pocket Communications ("Pocket"), intends to install antennas and appurtenant equipment at the existing 82-foot sign structure tower facility owned by Shanner Hotel Group and located at 100 Berlin Road (a/k/a Christian Hill Road site), Cromwell, Connecticut ("Facility"). Pocket Communications provides prepaid, flat rate wireless voice and data services to more than a quarter of a million subscribers. Pocket is licensed by the Federal Communications Commission (FCC) to provide PCS wireless telecommunications service in the State of Connecticut, which includes the area to be served by the proposed installation. This installation constitutes an exempt modification pursuant to the Public Utility Environmental Standards Act, Connecticut General Statutes Section 16-50g et. seq. (PUESA), and Section 16-50j-72(b)(2) of the Regulations of the Connecticut State Agencies adopted pursuant to PUESA. In accordance with R.C.S.A. Section 16-50j-73, a copy of this notice has been sent to Jeremy Shingleton, First Selectman, Town of Cromwell.

The existing Facility consists of a 82-foot sign structure tower capable of supporting multiple carriers within a fenced compound. The coordinates for the Facility are **Lat: 41°-36'-20"** and **Long: 72°-42'-07"**. The tower is located in the southwest portion of Cromwell behind the Crowne Plaza Hotel, roughly 750 feet north of Berlin Road (Route 372) and approximately 300 feet east of I-91, 1.4 miles south of it's intersection with Route 9. The Facility is approximately 100 feet east of the on-ramp running from Berlin Road (Route 372) to I-91. The Facility is near the end of the cul-de-sac end of Christian Hill Road, slightly to the north (see Site Map, attached as Exhibit A). The Facility is listed on the Siting Council database as Christian Hill Road. The tower currently supports Verizon antennas at the eighty eight foot (88') level centerline AGL (above ground level), AT&T antennas at the ninety eight foot level (98') AGL, and T-Mobile antennas at the one hundred eight foot level (108') AGL in an existing pipe-mount configuration. Pocket proposes to install three RFS APXV18-206517S-C flush mount antennas on the tower

**PULLMAN & COMLEY, LLC**  
ATTORNEYS AT LAW

Page 2

legs at the seventy seven foot centerline (77') AGL, and a Nortel CDMA Micro BTS 3231 cabinet, mounted on an "H-Frame," contained within a six foot by six foot (6'-0" x 6'-0") lease area. A small GPS antenna will be mounted to an ice bridge which will run from the lease area to the tower. Utilities will be run via a proposed underground conduit from an existing utility backboard, within the compound (See Design Drawings and Equipment Specifications, attached as Exhibits B and C respectively).

For the following reasons, the proposed modifications to the Berlin Road Facility meet the exempt modification criteria set forth in R.C.S.A. Section 16-50j-72(b)(2):

1. The proposed modification will not increase the height of the tower as Pocket's antennas will be installed at a center line height of approximately 77 feet.
2. The installation of Pocket's equipment and shelter will not require an extension of the site boundaries.
3. The proposed modifications will not increase the noise levels at the existing Facility by six decibels or more.
4. The operation of the additional antennas will not increase the total radio frequency (RF) power density, measured at the site boundary, to a level at or above the standard adopted by the Connecticut Department of Environmental Protection as set forth in Section 22a-162 of the Connecticut General Statutes and MPE limits established by the Federal Communications Commission. The worst-case RF power density calculations for the proposed Pocket antennas would be 35.13% of the FCC standard (see general power density calculations table, attached as Exhibit D).

Also attached, Exhibit E, is a structural analysis confirming that the tower can support the existing and proposed antennas and associated equipment. The entire structural analysis report with all of the calculation sheets is 112 pages long. It is available upon request.

For the foregoing reasons, Pocket respectfully submits that the proposed antenna installation and equipment at the Cromwell Facility constitutes an exempt modification under R.C.S.A. Section 16-50j-72(b)(2)

Respectfully Submitted,



Carrie L. Larson

cc: Jeremy Shingleton, First Selectman, Town of Cromwell  
Shaner Hotel Group, underlying property owner

# **Exhibit A**

## **Site Map**

**Pocket Site HFCT1509A**

**100 Berlin Road**

**Cromwell, Connecticut**







# **Exhibit B**

## **Design Drawings**

**Pocket Site HFCT1509A**

**100 Berlin Road**

**Cromwell, Connecticut**

**PROJECT INFORMATION**

TOWER OWNER:  
SHANER HOTEL GROUP  
1985 WADDLE ROAD  
STATE COLLEGE, PA 16803  
CONTACT: PETE NEBROSKI  
814-278-7518

OWNER SITE ID#:  
N/A

APPLICANT:  
YOUNGROBERTSON COMMUNICATIONS-  
NORTHEAST LLC  
1100 W. 410  
SAN ANTONIO, TX 78230

SITE ADDRESS:  
100 BERLIN ROAD  
CROWMELL, CT 06416

COUNTY:  
HARTFORD

LATITUDE:  
41.6055

LONGITUDE:  
-72.7024

STRUCTURE HEIGHT:  
82' AGL

ZONING CLASSIFICATION:  
N/A

ZONING JURISDICTION:  
CONNECTICUT SITING COUNCIL

POWER COMPANY:  
CL&P

TELEPHONE COMPANY:  
AT&T  
1-860-947-2121

DESIGN FIRM:  
URS CORPORATION, ASS.  
500 ENTERPRISE DRIVE, SUITE 3B  
ROCKY HILL, CT 06067  
PHONE: 860-529-8882

**DRAWING INDEX**

01	TITLE SHEET	1
02	SITE PLAN, DETAILS AND NOTES	1
03	TOWER ELEVATION, ANTENNA PLAN AND DETAILS	1
04	GROUNDING DETAILS	1
05	GROUNDING PLAN AND DETAILS	1
06	ELECTRICAL DETAILS	1

**STRUCTURAL REVIEW**

FOR ADDITIONAL TOWER AND FOUNDATION INFORMATION REFER TO STRUCTURAL ANALYSIS REPORT, 82' SIGN STRUCTURE WITH 111' PIPE MAST, POCKET WIRELESS SITE REPORT, REVISED 08/15/06, BY URS CORPORATION, PROJECT# 08156-00-15, DATED MARCH 1, 2006.

**APPROVALS**

REAL ESTATE	_____
RF	_____
OPS/CONSTRUCTION	_____
LEGAL/COMPLIANCE	_____
NET DESIGN	_____

# POCKET<sup>TM</sup>

SMART WIRELESS

## HFCT1509A

### 100 BERLIN ROAD

### 82' SIGN STRUCTURE

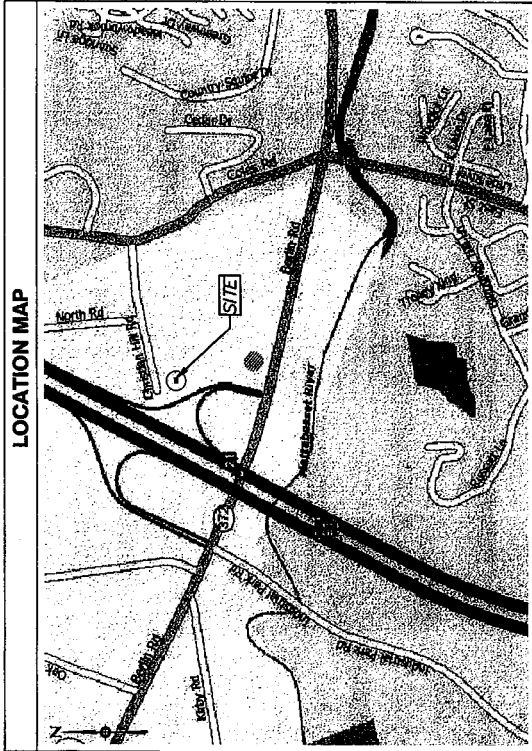

**DRIVING DIRECTIONS**

FROM HARTFORD:  
TAKE I-91 SOUTH TO EXIT 21 (ROUTE 372). TURN LEFT ONTO BERLIN ROAD. SITE IS BEHIND CROWMELL PLAZA HOTEL.

**APPLICABLE BUILDING CODES AND STANDARDS**

CONTRACTOR'S WORK SHALL COMPLY WITH ALL APPLICABLE NATIONAL, STATE, AND LOCAL CODES AS ADOPTED BY THE LOCAL AUTHORITY, HAVING JURISDICTION (AHJ) FOR THE LOCATION. THE EDITION OF THE AHJ ADOPTED CODES AND STANDARDS IN EFFECT ON THE DATE OF CONTRACT AWARD SHALL GOVERN THE DESIGN.

CONNECTICUT STATE BUILDING CODE  
2003 INTERNATIONAL BUILDING CODE  
2003 INTERNATIONAL PLUMBING CODE  
2003 INTERNATIONAL MECHANICAL CODE  
2003 INTERNATIONAL FIRE AND SAFETY CODE  
2003 CONNECTICUT SUPPLEMENT  
ELECTRICAL CODE:  
2005 NATIONAL ELECTRICAL CODE  
CONNECTICUT STATE FIRE SAFETY CODE  
2003 INTERNATIONAL FIRE CODE

CONTRACTOR'S WORK SHALL COMPLY WITH THE LATEST APPROVED EDITION OF THE FOLLOWING STANDARDS:

AMERICAN CONCRETE INSTITUTE (ACI) 318, BUILDING CODE REQUIREMENTS FOR STRUCTURAL CONCRETE  
AMERICAN INSTITUTE OF STEEL CONSTRUCTION (AISC), MANUAL OF STEEL CONSTRUCTION, ASD, NINTH EDITION  
AMERICAN WIRELESS INDUSTRY ASSOCIATION (AWII) 222-F, STRUCTURAL STANDARD FOR STRUCTURAL ANTENNA TOWER AND ANTENNA SUPPORTING STRUCTURES  
TIA 607 COMMERCIAL BUILDING GROUNDING AND BONDING REQUIREMENTS FOR TELECOMMUNICATIONS  
INSTITUTE FOR ELECTRICAL AND ELECTRONICS ENGINEERS (IEEE) 81, GUIDE FOR MEASURING EARTH RESISTIVITY, GROUND IMPEDANCE, AND EARTH SURFACE POTENTIALS OF A GROUND SYSTEM  
IEEE 1100 (1999) RECOMMENDED PRACTICE FOR POWERING AND GROUNDING OF ELECTRONIC EQUIPMENT  
IEEE 625-41, RECOMMENDED PRACTICES ON SURGE VOLTAGES IN LOW VOLTAGE AC POWER CIRCUITS (FOR LOCATION CATEGORY "C3" AND "HIGH SYSTEM EXPOSURE")  
TELECORDIA GR-1275 GENERAL INSTALLATION REQUIREMENTS  
TELECORDIA GR-1503 COAXIAL CABLE CONNECTIONS  
ANSI T1.311, FOR TELECOM - DC POWER SYSTEMS - TELECOM ENVIRONMENTAL PROTECTION FOR ANY CONFLICTS BETWEEN SECTIONS OF LISTED CODES AND STANDARDS REGARDING MATERIAL, METHODS OF CONSTRUCTION, OR OTHER REQUIREMENTS. THE MOST RESTRICTIVE REQUIREMENT SHALL GOVERN, WHERE THERE IS CONFLICT BETWEEN A GENERAL REQUIREMENT AND A SPECIFIC REQUIREMENT, THE SPECIFIC REQUIREMENT SHALL GOVERN.

**SITE NOTES**

- THIS SITE IS UNMANNED AND IS RESTRICTED TO OUTDOOR EQUIPMENT. IT WILL BE USED FOR CELLULAR SERVICE.
- PROVIDE PROTECTION SERVICES THAT THIS TELEPHONE EQUIPMENT FACILITY WILL BE SERVICED ONLY BY POCKET COMMUNICATIONS EMPLOYEES AND THE WORK ASSOCIATED WITH ANY EQUIPMENT CANNOT BE PERFORMED BY HANDICAPPED PERSONS. THIS FACILITY WILL BE FREQUENTED ONLY BY SERVICE PERSONNEL FOR REPAIR PURPOSES ONLY. THIS FACILITY IS NOT TO BE USED OR IS TO BE USED ONLY BY PERSONS WITH DISABILITIES ACT (ADA) APPENDIX B, SECTION 4.11.5(16).
- NO POTABLE WATER SUPPLY IS TO BE PROVIDED AT THIS LOCATION.
- NO WASTE WATER WILL BE GENERATED AT THIS LOCATION.
- NO SOLID WASTE WILL BE GENERATED AT THIS LOCATION.
- POCKET COMMUNICATIONS MAINTENANCE CREW (TYPICALLY ONE PERSON) WILL MAKE AN AVERAGE OF ONE TRIP PER MONTH AT ONE HOUR PER VISIT.

**STRUCTURAL ANALYSIS REPORT**

FOR ADDITIONAL TOWER AND FOUNDATION INFORMATION REFER TO STRUCTURAL ANALYSIS REPORT, 82' SIGN STRUCTURE WITH 111' PIPE MAST, POCKET WIRELESS SITE REPORT, REVISED 08/15/06, BY URS CORPORATION, PROJECT# 08156-00-15, DATED MARCH 1, 2006.

NO.	DATE	ISSUED FOR	REVISIONS
1	03/06/06	DESIGNED FOR MATCH STRUCTURE	
2	07/23/06	ISSUED FOR CONSTRUCTION	

URS CORPORATION  
500 ENTERPRISE DRIVE, SUITE 3B  
ROCKY HILL, CT 06067  
TEL: 860-529-8882  
FAX: 860-529-8883  
WWW.URS.COM

PROJECT NO: HFCT1509A, 100 BERLIN ROAD  
SHEET NO: 01  
DATE: 11/24/08  
CHECKED BY: JCF  
DESIGNED BY: JCF  
SCALE: AS SHOWN  
PROJECT NO: PC1052/58923872  
DATE: 11/24/08

THE INFORMATION CONTAINED HEREIN IS THE PROPERTY OF URS CORPORATION. IT IS TO BE USED ONLY FOR THE PROJECT AND SITE SPECIFICALLY IDENTIFIED HEREIN. NO PART OF THIS DOCUMENT IS TO BE REPRODUCED OR TRANSMITTED IN ANY FORM OR BY ANY MEANS, ELECTRONIC OR MECHANICAL, INCLUDING PHOTOCOPYING, RECORDING, OR BY ANY INFORMATION STORAGE AND RETRIEVAL SYSTEM, WITHOUT THE WRITTEN PERMISSION OF URS CORPORATION.

**URS**

STATE OF CONNECTICUT  
REGISTERED PROFESSIONAL ENGINEER  
NO. 10000  
JCF

01

**CONSTRUCTION NOTES**

1. FIELD VERIFICATION: CONTRACTOR SHALL FIELD VERIFY SCOPE OF WORK, POCKET COMMUNICATIONS ANTENNA MOUNT LOCATION AND ANTENNAS TO BE INSTALLED.
2. COORDINATION OF WORK: CONTRACTOR SHALL COORDINATE ALL WORK WITH THE OWNER'S REPRESENTATIVE AND PROCEDURES WITH POCKET COMMUNICATIONS.
3. GRAVEL SURFACE IN AREAS OF COMPOUND THAT ARE DISTURBED DURING CONSTRUCTION SHALL BE REPLACED TO ORIGINAL CONDITION BY CONTRACTOR.

**GENERAL NOTES**

1. FOR THE PURPOSE OF CONSTRUCTION DRAWING, THE FOLLOWING DEFINITIONS SHALL APPLY:  
CONTRACTOR - GENERAL CONTRACTOR (CONSTRUCTION)  
OWNER - POCKET COMMUNICATIONS  
OEM - ORIGINAL EQUIPMENT MANUFACTURER
2. PRIOR TO THE SUBMISSION OF BIDS THE BIDDING DOCUMENTS SHALL BE REVIEWED BY THE BIDDING COMMITTEE TO CONFIRM THAT THE WORK CAN BE ACCOMPLISHED AS SHOWN ON THE DRAWINGS AND TO IDENTIFY ANY DISCREPANCY FOUND SHALL BE BROUGHT TO THE ATTENTION OF THE CONSTRUCTION MANAGER AND THE ENGINEER.
3. ALL WORKMANSHIP SHALL BE IN STRICT ACCORDANCE WITH ALL APPLICABLE CODES, REGULATIONS, AND ORDINANCES. CONTRACTOR SHALL ISSUE PERMITS FOR ALL WORKMANSHIP AND SHALL OBTAIN ORDINANCES, RULES, REGULATIONS, AND LAWFUL ORDERS OF ANY PUBLIC AUTHORITY REGARDING THE PERFORMANCE OF THE WORK.

4. ALL WORK CARRIED OUT SHALL COMPLY WITH ALL APPLICABLE MUNICIPAL AND UTILITY COMPANY SPECIFICATIONS AND LOCAL JURISDICTIONAL CODES, ORDINANCES AND APPLICABLE REGULATIONS.
5. UNLESS FURTHER SPECIFIED OTHERWISE, CONTRACTOR SHALL BE RESPONSIBLE FOR OBTAINING ALL NECESSARY PERMITS, APPROPRIATEANCES, AND LABOR NECESSARY TO COMPLETE ALL INSTALLATIONS AS INDICATED ON THE DRAWINGS.
6. THE CONTRACTOR SHALL INSTALL ALL EQUIPMENT AND MATERIALS IN ACCORDANCE WITH MANUFACTURER'S RECOMMENDATIONS UNLESS SPECIFICALLY STATED OTHERWISE.
7. CONTRACTOR SHALL BE RESPONSIBLE FOR THE ROUTING OF COMMUNICATIONS AND POWER CABLES AND GROUNDING CABLES AS SHOWN ON THE SITE PLAN.

8. THE CONTRACTOR SHALL PROTECT EXISTING IMPROVEMENTS, PAVEMENTS, CURBS, LANDSCAPING AND STRUCTURES. ANY DAMAGED PART SHALL BE REPAIRED AT CONTRACTOR'S EXPENSE TO THE SATISFACTION OF OWNER.
9. CONTRACTOR SHALL LEGALLY AND PROPERLY DISPOSE OF ALL DEBRIS AND WASTE MATERIALS. ALL CABLES AND WIRING SHALL BE PROPERLY DISPOSED OF. OTHER ITEMS REMOVED FROM THE PROJECT SHALL BE RETURNED TO THE OWNER'S DESIGNATED LOCATION.
10. CONTRACTOR TO OBTAIN REQUIRED NOTICE TO PROCEED DOCUMENTS FROM THE TOWER OWNER BEFORE COMMENCING CONSTRUCTION.

NO.	DATE	REVISIONS
1	02/09/08	REVISED TO MATCH STRUCTURAL
0	01/23/08	ISSUED FOR CONSTRUCTION

**URS**  
**POCKET COMMUNICATIONS**  
**SHAW-WALKER**  
**100 BERLIN ROAD**  
**HFC1509A**  
**SITE PLAN, DETAILS AND NOTES**

THE INFORMATION CONTAINED HEREIN IS THE PROPERTY OF URS CORPORATION. IT IS TO BE USED ONLY FOR THE PROJECT AND SITE SPECIFICALLY IDENTIFIED HEREIN. NO PART OF THIS DOCUMENT IS TO BE REPRODUCED OR TRANSMITTED IN ANY FORM OR BY ANY MEANS, ELECTRONIC OR MECHANICAL, INCLUDING PHOTOCOPYING, RECORDING, OR BY ANY INFORMATION STORAGE AND RETRIEVAL SYSTEM, WITHOUT THE WRITTEN PERMISSION OF URS CORPORATION.

**URS**  
 100 BERLIN ROAD  
 WILMINGTON, MA 01897  
 PHONE: 617-489-8800  
 FAX: 617-489-8801  
 PROJECT NO: JCF  
 DRAWING NO: JCF  
 DATE: 11/24/08  
 JOB NO: M08002  
 PC1052/38923912  
 DRAWING NO: 02

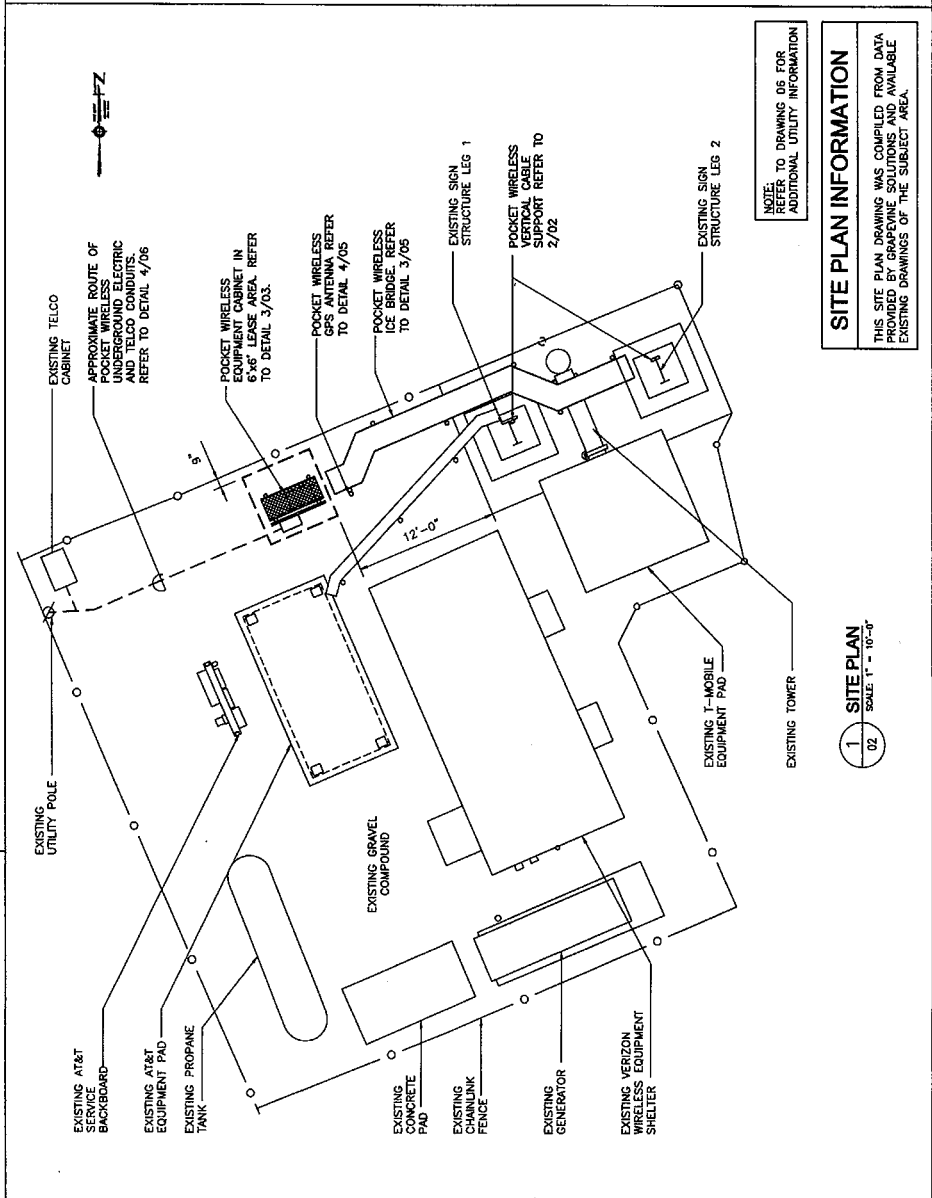
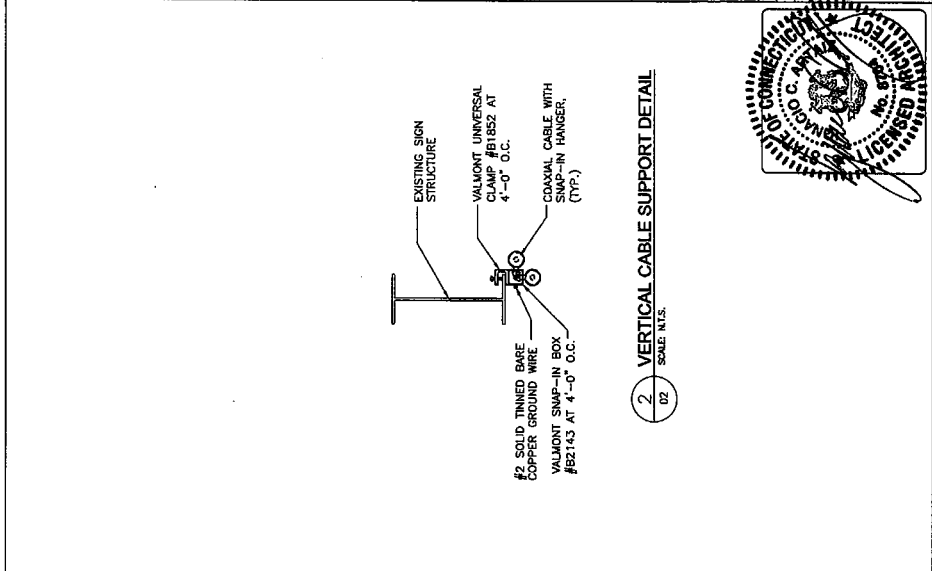

FOR ADDITIONAL TOWER AND FOUNDATION INFORMATION REFER TO STRUCTURAL ANALYSIS REPORT, 82' SIGN STRUCTURE WITH 111' PIPE MAST, POCKET WIRELESS SITE REF: HFC1509A, PREPARED BY NATCOM, INC., NATCOM PROJECT# 08136-CO-15, DATED MARCH 1, 2009.

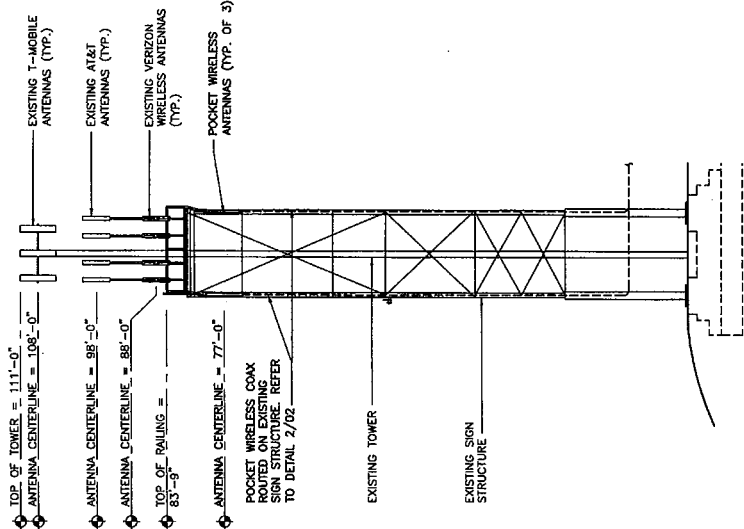

1 TOWER ELEVATION  
SCALE: N.T.S.

**ANTENNA KEY**

ANTENNAS PER SECTOR	ANTENNA NUMBER	COAX COLOR CODE	ANTENNA VENDOR	MODEL NUMBER	AZIMUTH	C/L HEIGHT	MECHANICAL DOWN TILT	ELECTRICAL DOWN TILT	COAX SIZE	CABLES PER ANTENNA	COAX MANUFACTURER
ALPHA	1	(1) RED BAND	RFS	APXV18-206517S-C	25°	77'-0"	0°	0°	1 5/8"	2 @ 125'	RFS
BETA	1	(1) BLUE BAND	RFS	APXV18-206517S-C	130°	77'-0"	0°	0°	1 5/8"	2 @ 125'	RFS
GAMMA	1	(1) GREEN BAND	RFS	APXV18-206517S-C	240°	77'-0"	0°	0°	1 5/8"	2 @ 110'	RFS
GPS	1	YELLOW	NORTEL	NT8601MA	-	9'-0"	-	-	1/2"	1 @ 10'	RFS

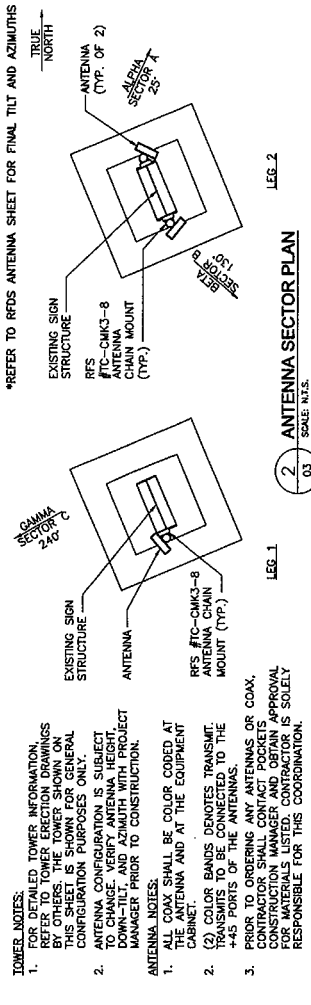

2 ANTENNA SECTOR PLAN  
SCALE: N.T.S.

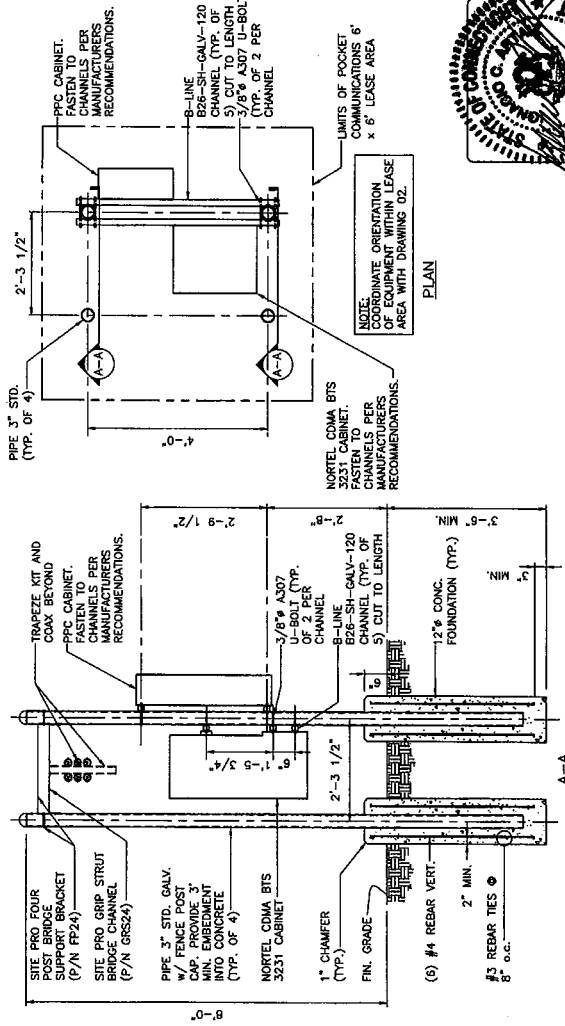

3 CABINET SUPPORT FRAME  
SCALE: N.T.S.

**POCKET WIRELESS**

HFC1509A, 100 BERLIN ROAD  
TOWER ELEVATION, ANTENNA PLAN AND DETAILS

NO. DATE REVISIONS

1	03/09/08	REVISED TO MATCH STRUCTURAL
2	01/23/09	REVISED FOR CONSTRUCTION

THE INFORMATION CONTAINED HEREIN IS THE PROPERTY OF POCKET WIRELESS. IT IS TO BE USED ONLY FOR THE PROJECT AND SITE SPECIFICALLY IDENTIFIED IN THE WRITTEN PERMISSION OF POCKET WIRELESS.

**URS**

PROJECT MANAGER: JCF  
DESIGNER: JCF  
DATE: 11/24/08  
PROJECT NO: HFC1509/36923972

**03**

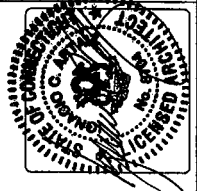

NO.	DATE	REVISIONS
1	02/09/08	ISSUED FOR CONSTRUCTION
2	02/09/08	REVISED TO MATCH STRUCTURAL
3		
4		
5		
6		
7		

HFC11509A, 100 BERLIN ROAD  
**POCKET**  
 SMART WIRELESS

THE INFORMATION CONTAINED IN THIS DOCUMENT IS THE PROPERTY OF SMART WIRELESS. IT IS TO BE USED ONLY IN ACCORDANCE WITH THE WRITTEN PERMISSION OF SMART WIRELESS.

**URS**

PROJECT NO. JCF  
 DATE: 11/24/08  
 DRAWING NO. PC-1052/56923972  
 SHEET NUMBER  
 DRAWING NAME

**04**

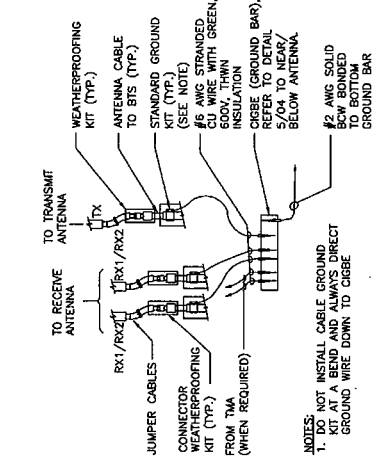

**NOTES:**  
 1. DO NOT INSTALL CABLE GROUND KIT AT A BEND AND ALWAYS DIRECT GROUND WIRE DOWN TO CIGRE

**4 CONNECTION OF GROUND WIRE TO GROUND BAR**  
 SCALE: N.T.S.

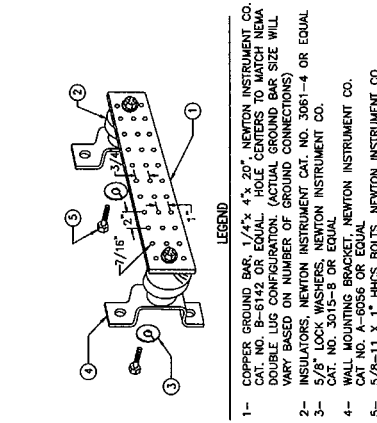

**LEGEND:**  
 1- COPPER GROUND BAR, 1/4" x 4" x 20", NEWTON INSTRUMENT CO. CAT. NO. B-6142 OR EQUAL. HOLE CENTERS TO MATCH NEMA DOUBLE LUG CONFIGURATION. (ACTUAL GROUND BAR SIZE WILL VARY BASED ON NUMBER OF GROUNDING CONNECTIONS)  
 2- 1/2" DIAMETER WASHER, NEWTON INSTRUMENT CO. CAT. NO. 3011-4 OR EQUAL  
 3- 1/2" DIAMETER WASHER, NEWTON INSTRUMENT CO. CAT. NO. 3015-8 OR EQUAL  
 4- WALL MOUNTING BRACKET, NEWTON INSTRUMENT CO. CAT. NO. A-8056 OR EQUAL  
 5- 5/8"-11 X 1" HHCS BOLTS, NEWTON INSTRUMENT CO. CAT. NO. 3012-1 OR EQUAL

**5 MASTER/EQUIPMENT GROUND BAR DETAIL**  
 SCALE: N.T.S.

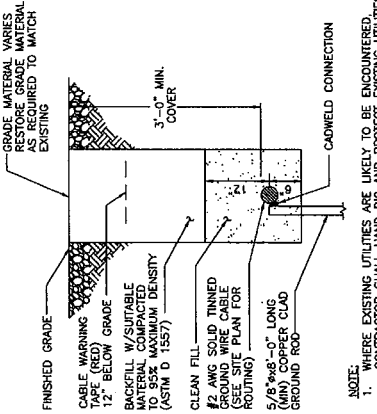

**NOTE:**  
 1. WHERE EXISTING UTILITIES ARE LIKELY TO BE ENCOUNTERED, CONTRACTOR SHALL HAND DIG AND PROTECT EXISTING UTILITIES.  
 2. CADWELD GROUND ROD TO GROUND RING AFTER GROUND ROD HAS BEEN DRIVEN INTO PLACE

**6 EGR DETAIL**  
 SCALE: N.T.S.

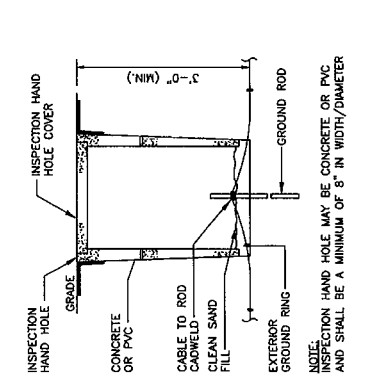

**NOTE:**  
 INSPECTION HAND HOLE MAY BE CONCRETE OR PVC AND SHALL BE A MINIMUM OF 8" IN WIDTH/DIAMETER

**7 GROUND ROD WITH INSPECTION HANDHOLE**  
 SCALE: N.T.S.

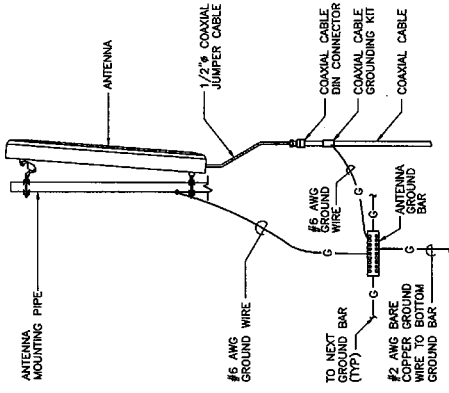

**1 TYPICAL ANTENNA GROUNDING DETAIL**  
 SCALE: N.T.S.

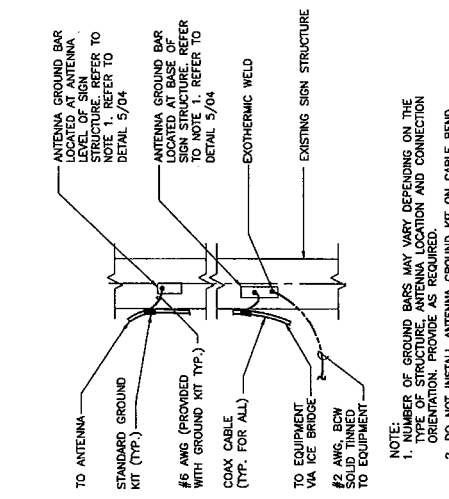

**2 ANTENNA CABLE GROUNDING- SIGN STRUCTURE**  
 SCALE: N.T.S.

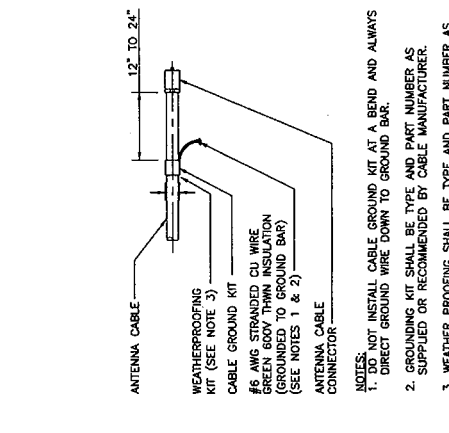

**3 CONNECTION OF CABLE GROUND KIT TO ANTENNA CABLE**  
 SCALE: N.T.S.

**NOTES:**  
 1. DO NOT INSTALL CABLE GROUND KIT AT A BEND AND ALWAYS DIRECT GROUND WIRE DOWN TO GROUND BAR.  
 2. GROUNDING KIT SHALL BE TYPE AND PART NUMBER AS SUPPLIED OR RECOMMENDED BY CABLE MANUFACTURER.  
 3. WEATHER PROOFING SHALL BE TYPE AND PART NUMBER AS SUPPLIED OR RECOMMENDED BY CABLE MANUFACTURER.

NO.	DATE	REVISIONS
1	03/29/09	REVISED TO MATCH STRUCTURAL
0	01/23/08	REVISED FOR CONSTRUCTION

HCT1809A, 100 BURLIN ROAD  
**Pocket**  
 DRAFT WINKLER

THE INFORMATION CONTAINED IN THIS DOCUMENT IS THE PROPERTY OF URS CORPORATION. IT IS TO BE USED ONLY FOR THE PROJECT AND SITE SPECIFICALLY IDENTIFIED HEREIN. THIS DOCUMENT IS NOT TO BE REPRODUCED OR TRANSMITTED IN ANY FORM OR BY ANY MEANS, ELECTRONIC OR MECHANICAL, INCLUDING PHOTOCOPYING, RECORDING, OR BY ANY INFORMATION STORAGE AND RETRIEVAL SYSTEM, WITHOUT THE WRITTEN PERMISSION OF URS CORPORATION.

**URS**  
 500 SOUTHWEST DRIVE  
 SUITE 1000  
 WESTFIELD, CT 06097  
 PHONE: 860.234.1000  
 FAX: 860.234.1001  
 PROJECT NO.: HCT1809A/268933972  
 SHEET NUMBER: 05

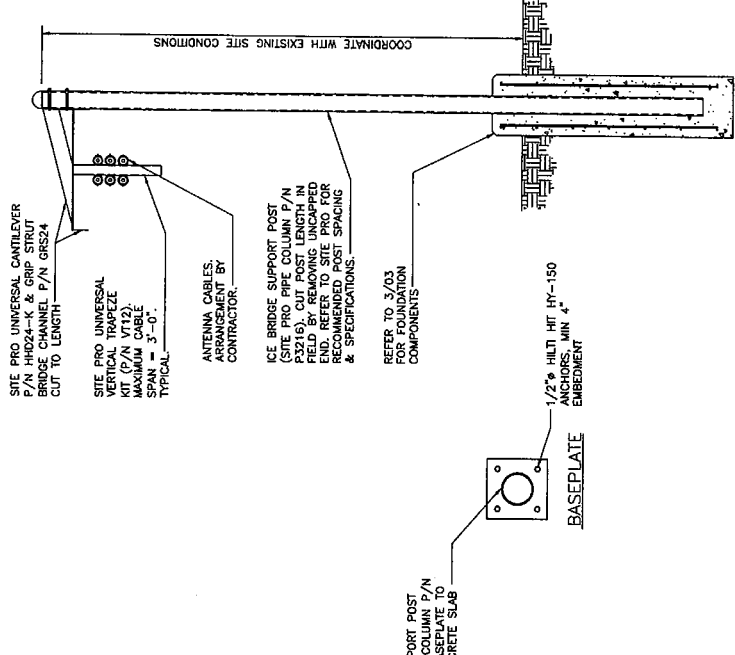
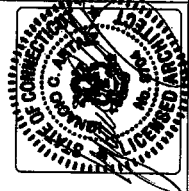

3 ICE BRIDGE DETAIL  
 SCALE: N.T.S.

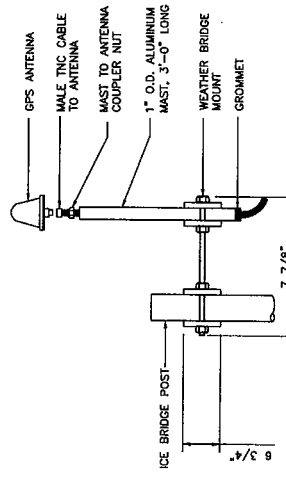

4 GPS MOUNTING DETAIL  
 SCALE: N.T.S.

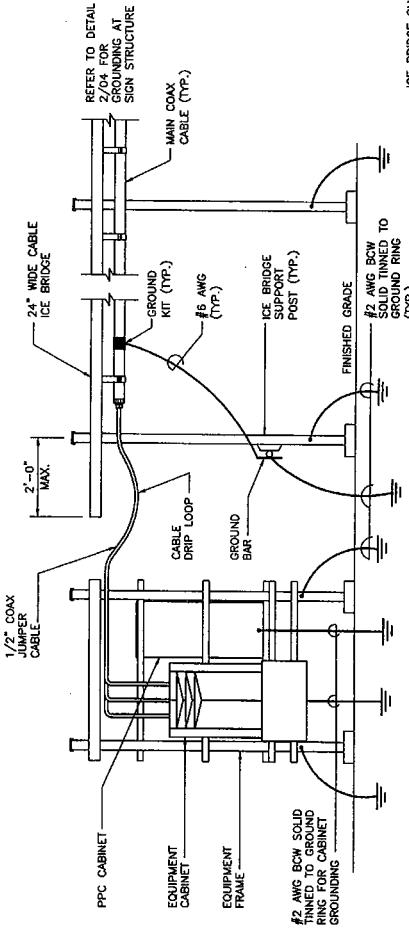

1 GROUNDING AT EQUIPMENT CABINET  
 SCALE: N.T.S.

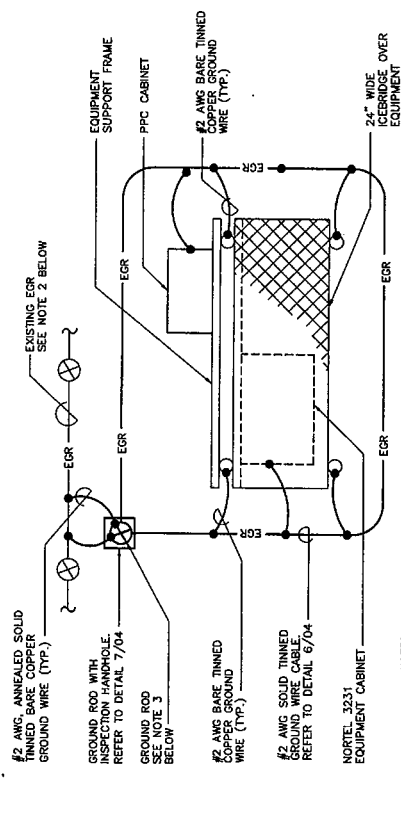

2 EQUIPMENT GROUNDING PLAN  
 SCALE: N.T.S.

NOTES:  
 1. SEE SHEET 02 FOR EQUIPMENT ORIENTATION AND LOCATION.  
 2. EXISTING EGR, VERIFY LOCATION IN FIELD. CONTRACTOR SHALL HAND DIG AND LOCATE EXISTING EGR. IF ANY CHANGE IS LEAST TO EXISTING EGR, THE CONTRACTOR SHALL REPAIR THE DAMAGE AT HIS OWN COST TO THE SATISFACTION OF RESPECTIVE CELL ENGINEERS.  
 3. GROUNDING ELECTRODE SHALL BE 2/8" DIA. x 8'-0" COPPER CLAD STEEL ROD. ADJUST LOCATION OF GROUNDING ELECTRODES TO AVOID ROCKS AND BouldERS. SPACING OF GROUNDING ELECTRODES SHALL NOT BE LESS THAN 6 FEET. ONLY WITH PROPER DRIVER SLEEVE TO PREVENT MUSHROOMING TOP OF ROD. WHEN ROCK BOTTOM IS ENCOUNTERED, THE ELECTRODE SHALL BE DRIVEN AT AN OBlique ANGLE NOT TO EXCEED 45° FROM THE VERTICAL. THE GROUNDING ELECTRODE SHALL BE DRIVEN TO A MINIMUM OF 3 FEET BELOW FINISH GRADE. IF IT IS IMPRACTICAL TO DRIVE THE 8'-0" GROUND ROD TO FINISH GRADE, THE ROD SHALL BE DRIVEN HORIZONTALLY IN A TRENCH AWAY FROM STRUCTURE, NOT LESS THAN 36" BELOW FINISHED GRADE AND UNDER NO CIRCUMSTANCES SHALL THE GROUND ROD BE CUT OR MODIFIED TO ACCOMMODATE VERTICAL INSTALLATION INTO LEDGE. REFER TO THE NEC 2005, ARTICLE #250 FOR MORE INFORMATION ON GROUNDING.

NOTES:  
 1. LOCATION OF ANTENNA MUST HAVE A CLEAR VIEW OF SOUTHERN SKY AND CANNOT HAVE ANY BLOCKAGES EXCEEDING 15 DEGREES FROM THE HEMISPHERE AROUND THE GPS ANTENNA.  
 2. ALL GPS ANTENNA LOCATIONS MUST BE HANDHELD GPS BEFORE FINAL LOCATION OF GPS ANTENNA.  
 3. ALL GPS ANTENNA LOCATIONS MUST BE MINIMUM OF 30 FEET FROM A MINIMUM OF 3 SATELLITES.





# **Exhibit C**

## **Equipment Specifications**

**Pocket Site HFCT1509A**

**100 Berlin Road**

**Cromwell, Connecticut**



**Product Description**

This variable tilt antenna provides exceptional suppression of all upper sidelobes at all downtilt angles. It also features null fill and a wide downtilt range with optional remote tilt.

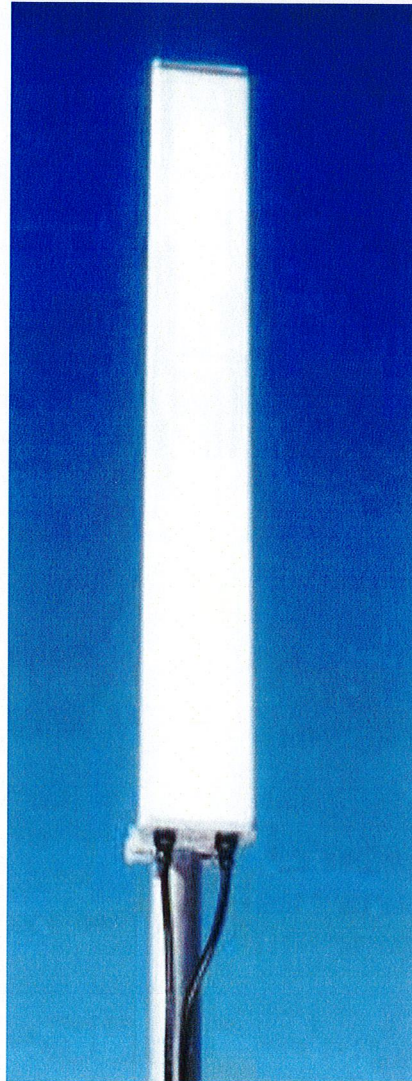

**Features/Benefits**

- Variable electrical downtilt - provides enhanced precision in controlling intercell interference. The tilt is infield adjustable 0-10 deg.
- High Suppression of all Upper Sidelobes (Typically <-20dB).
- Optional remote tilt - can be retrofitted.
- Broadband design.
- Dual polarization.
- Low profile for low visual impact.

**Technical Features**

Frequency Band	3G/UMTS (Single, Broad, Dual and Triple-Band)
Horizontal Pattern	Directional
Antenna Type	Panel Dual Polarized
Electrical Down Tilt Option	Variable



Gain, dBi (dBd)	18.8 (16.7) , 19.0 (16.9)
Frequency Range, MHz	1710-1900, 1900-2170
Connector Type	(2) 7-16 DIN Female
Connector Location	Bottom
Mount Type	Downtilt
Electrical Downtilt, deg	0-10
Horizontal Beamwidth, deg	67 , 63
Mounting Hardware	APM40-2
Rated Wind Speed, km/h (mph)	160 (100)
VSWR	< 1.5:1
Vertical Beamwidth, deg	5.0 , 4.6
Upper Sidelobe Suppression, dB	>17 , >18 all (Typically >20)
Polarization	Dual pol +/-45°
Front-To-Back Ratio, dB	>30
Maximum Power Input, W	300
Isolation between Ports, dB	>30
Lightning Protection	Direct Ground
3rd Order IMP @ 2 x 43 dBm, dBc	>150
7th Order IMP @ 2x46 dBm, dBc	>170
Impedance, Ohms	50
Overall Length, m (ft)	1.85 (6.06)
Mounting Hardware Weight, kg (lb)	3.4 (7.5)
Dimensions - HxWxD, mm (in)	1850 x 175 x 80 (72.0 x 6.8 x 3.15)
Weight w/o Mtg Hardware, kg (lb)	12 (26.4)
Weight w/ Mtg Hardware, kg (lb)	14.8 (32.5)
Radiating Element Material	Brass
Radome Color	Light Grey RAL7035
Radome Material	Fiberglass
Mounting Hardware Material	Diecasted Aluminum
Reflector Material	Aluminum
Max Wind Loading Area, m <sup>2</sup> (ft <sup>2</sup> )	0.31 (3.3)
Survival Wind Speed, km/h (mph)	200 (125)
Maximum Thrust @ Rated Wind, N (lbf)	558 (125)
Front Thrust @ Rated Wind, N (lbf)	558 (125)
Shipping Weight, kg (lb)	18.3 (39.8)
Packing Dimensions, HxWxD, mm (in)	2021 x 260 x 200 (79.5 x 10.2 x 7.8)
Packing Dimensions - HxWxD, m (ft)	2.0 x 0.26 x 0.2 (6.6 x 0.85 x 0.65)

**Notes**

For additional mounting information please click "External Document Link" below.



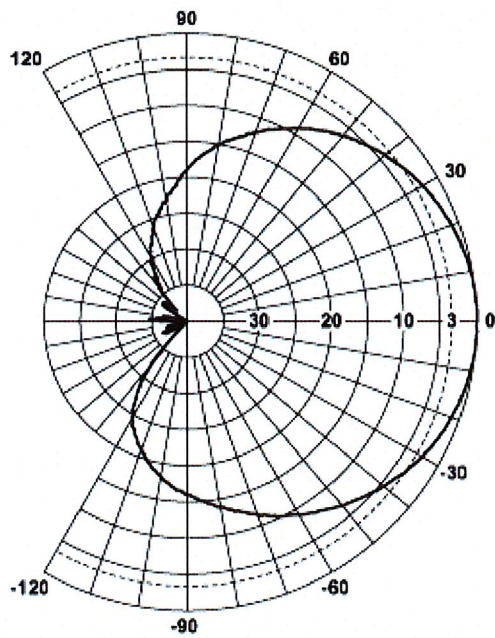
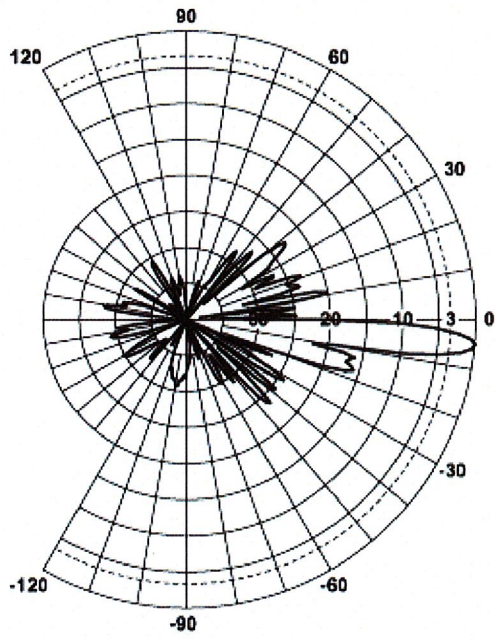

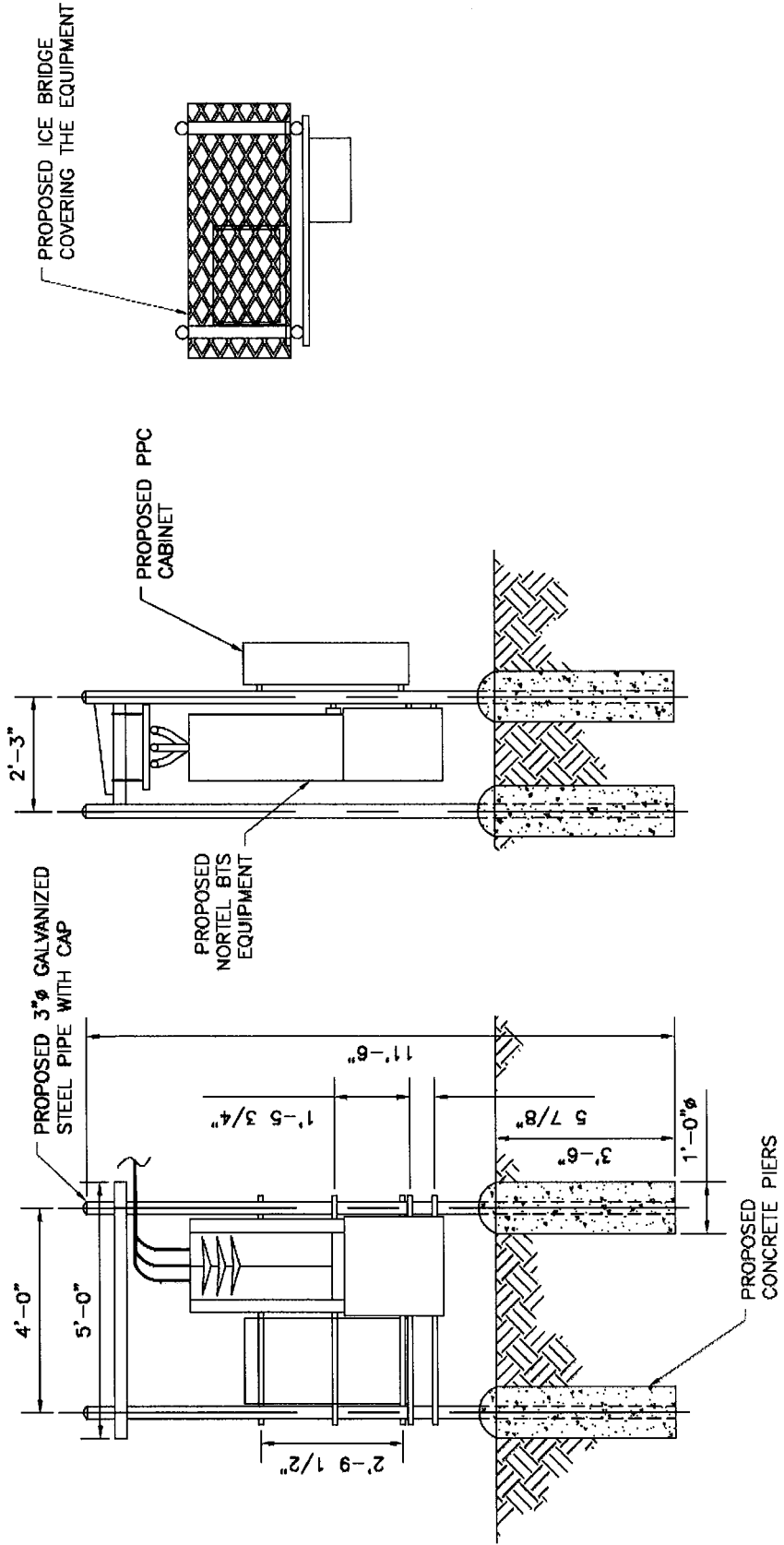

Pocket/Youghioheny Communications – Northeast, LLC  
 Rack Detail



## CDMA BTS 3231 AWS 1.7/2.1 GHz (Outdoor/Indoor)

### CDMA BTS 3231

---

#### *Industry's Highest Capacity AWS Micro BTS*

The CDMA BTS 3231 is the latest extension to Nortel Networks BTS (Base Transceiver Station) portfolio providing the ideal solution for urban, sub-urban and rural deployments. The CDMA BTS 3231 is a 3-carrier, 3-sector outdoor/indoor BTS operating at the AWS band of 1.7/2.1 GHz supporting IS-95, 1XRTT and 1xEV-DO simultaneously. BTS 3231 provides flexible deployments solutions including floor, rack, and wall mount options. The power consumption of BTS3231 is industry leading consuming only 630W for 3C3S. The BTS 3231 is also very light at 240lbs making it easy

to transport to hard to reach locations such as the top of a high rise building.

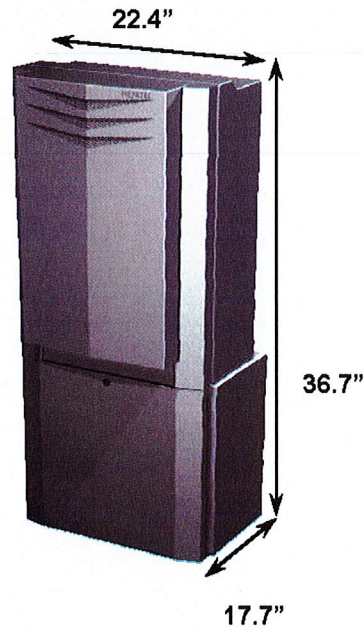



# **Exhibit D**

## **Power Density Calculations**

**Pocket Site HFCT1509A**

**100 Berlin Road**

**Cromwell, Connecticut**



C Squared Systems, LLC  
920 Candia Road  
Manchester, NH 03109  
Phone: (603) 657 9702  
E-mail:  
[support@csquaredsystems.com](mailto:support@csquaredsystems.com)

---

## Calculated Radio Frequency Emissions



HFCT1509

100 Berlin Road, Cromwell, CT

---

## Table of Contents

1. Introduction.....	1
2. FCC Guidelines for Evaluating RF Radiation Exposure Limits.....	2
3. RF Exposure Prediction Methods.....	2
4. Calculation Results.....	3
5. Conclusion.....	3
6. Statement of Certification.....	5
Attachment A: References.....	6
Attachment B: FCC Limits For Maximum Permissible Exposure (MPE).....	7

## List of Tables

Table 1: Proposed Carrier Information.....	3
--	---

## 1. Introduction

The purpose of this report is to investigate compliance with applicable FCC regulations for the proposed Pocket antennas to be installed on the existing tower at 100 Berlin Road, Cromwell, CT.

These calculations assume that the antennas are operating at 100 percent capacity, that all antenna channels are transmitting simultaneously, and that the radio transmitters are operating at full power. Obstructions (trees, buildings etc.) that would normally attenuate the signal are not taken into account. As a result, the predicted signal levels are much more conservative (higher) than the actual signal levels will be from the finished installation.

Public exposure to radio frequencies is regulated and enforced in units of microwatts per square centimeter ( $\text{mW}/\text{cm}^2$ ). The number of  $\text{mW}/\text{cm}^2$  emitted is called the power density. The general population exposure limit for the cellular band is 0.567-0.593  $\text{mW}/\text{cm}^2$ , and the general population exposure limit for the PCS/AWS band is 1.0  $\text{mW}/\text{cm}^2$ . Because each carrier will be using different frequency bands, and each frequency band has different exposure limits, it is necessary to report percent of MPE rather than power density.

The FCC general population / uncontrolled limits set the maximum exposure to which most people may be subjected. General population / uncontrolled exposures apply in situations in which the general public may be exposed, or in which persons that are exposed as a consequence of their employment may not be fully aware of the potential for exposure or cannot exercise control over their exposure.

Higher exposure limits are permitted under the occupational / controlled exposure category, but only for persons who are exposed as a consequence of their employment and who have been made fully aware of the potential for exposure (through training), and they must be able to exercise control over their exposure. General population / uncontrolled limits are five times more stringent than the levels that are acceptable for occupational, or radio frequency trained individuals.

The FCC describes exposure to radio frequency (RF) energy in terms of percentage of maximum permissible exposure (MPE) with 100% being the maximum allowed. Rather than the FCC presenting the user specification in terms of complex power density figures over a specified surface area, this MPE measure is particularly useful, and even more so when considering that power density limits actually vary by frequency because of the different absorptive properties of the human body at different frequencies.

MPE limits are specified as time-averaged exposure limits. This means that exposure can be averaged over 30 minutes for general population / uncontrolled exposure (or 6 minutes for occupational / controlled exposure). However, for the case of exposure of the general public, time averaging is usually not applied because of uncertainties over exact exposure conditions and difficulty in controlling time of exposure. Therefore, the typical conservative approach is to assume that any RF exposure to the general public will be continuous.

Finally, it should be noted that the MPE limits adopted by the FCC for both general population / uncontrolled exposure and for occupational / controlled exposure incorporate a substantial margin of safety and have been established to be well below levels generally accepted as having the potential to cause adverse health effects.

## 2. FCC Guidelines for Evaluating RF Radiation Exposure Limits

In 1985, the FCC established rules to regulate radio frequency (RF) exposure from FCC licensed antenna facilities. In 1996, the FCC updated these rules, which were further amended in August 1997 by OET Bulletin 65 Edition 97-01. These new rules include limits for Maximum Permissible Exposure (MPE) for transmitters operating between 300 kHz and 100 GHz. The FCC MPE limits are based on exposure limits recommended by the National Council on Radiation Protection and Measurements (NCRP), the exposure limits developed by the Institute of Electrical and Electronics Engineers, Inc., (IEEE) and adopted by the American National Standards Institute (ANSI).

Attachment B contains excerpts from OET Bulletin 65 and defines the Maximum Exposure Limit. As shown in these excerpts, each frequency band has different exposure limits, requiring power density to be reported as a percent of Maximum Permissible Exposure (MPE) when dealing with carriers transmitting in different frequency bands.

## 3. RF Exposure Prediction Methods

The emission field calculation results displayed in the following figures were generated using the following formula as outlined in FCC bulletin OET 65:

$$\text{Power Density} = \left( \frac{0.64 \times EIRP}{\pi \times R^2} \right)$$

Where:

EIRP = Effective Isotropic Radiated Power

R = Radial Distance =  $\sqrt{(H^2 + V^2)}$

H = Horizontal Distance from antenna

V = Vertical Distance from bottom of antenna

0.64 is the ground reflection factor

## 4. Calculation Results

Table 1 below outlines the power density information for the site. All information for carriers other than Pocket was obtained from current CSC database except where otherwise noted.<sup>1</sup>

Carrier	Number of Trans.	Effective Radiated Power (ERP) Per Transmitter (Watts)	Antenna Height (Feet)	Operating Frequency (MHz)	Total ERP (Watts)	Power Density (mw/cm <sup>2</sup> )	Limit	%MPE
T-Mobile	8	133	108	1935	1064	0.0328	1.0000	3.28%
Verizon	N/A	N/A	88	880	N/A	N/A	N/A	8.31%
Verizon	N/A	N/A	88	1900	N/A	N/A	N/A	2.77%
Verizon Paging	N/A	N/A	N/A	N/A	N/A	N/A	N/A	0.91%
Verizon Paging	N/A	N/A	N/A	N/A	N/A	N/A	N/A	1.30%
AT&T (New Cingular)	N/A	N/A	98	1900	N/A	N/A	N/A	7.08%
Pocket	3	631	77	2130-2133.75	1893	0.1148	1.0000	11.48%
							Total	35.13%

**Table 1: Proposed Carrier Information**

## 5. Conclusion

The above analysis verifies that emissions from the proposed site will be well below the maximum power density levels as outlined by the FCC in the OET Bulletin 65 Ed. 97-01. Even when using conservative methods, the cumulative power density from the proposed transmit antennas at the existing facility is well below the limits for the general public. The highest expected percent of Maximum Permissible Exposure at the base of the tower is 35.13% of the FCC limit.

<sup>1</sup> According to CSC notes, RF details for the existing carriers were not provided by T-Mobile during their application process; only the MPE percentages were supplied, as reflected in this report. Centerlines for Verizon Wireless and AT&T were added based on the Structural Analysis Report submitted by Natcomm Inc, on March 1, 2009.

Please note that as indicated in the introduction, obstructions (trees, buildings etc.) that would normally attenuate the signal are not taken into account. As a result, the predicted signal levels are more conservative (higher) than the actual signal levels will be from the finished installation.



## 6. Statement of Certification

I certify to the best of my knowledge that the statements in this report are true and accurate. The calculations follow guidelines set forth in ANSI/IEEE Std. C95.3, ANSI/IEE Std. C95.1 and FCC OET Bulletin 65 Edition 97-01.

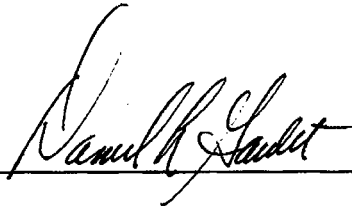

---

Daniel I. Goulet  
C Squared Systems, LLC

March 11, 2009  
Date

## **Attachment A: References**

OET Bulletin 65 - Edition 97-01 - August 1997 Federal Communications Commission Office of Engineering & Technology

ANSI C95.1-1982, American National Standard Safety Levels With Respect to Human Exposure to Radio Frequency Electromagnetic Fields, 300 kHz to 100 GHz. IEEE-SA Standards Board

IEEE Std C95.3-1991 (Reaff 1997), IEEE Recommended Practice for the Measurement of Potentially Hazardous Electromagnetic Fields - RF and Microwave. IEEE-SA Standards Board

## Attachment B: FCC Limits For Maximum Permissible Exposure (MPE)

### (A) Limits for Occupational/Controlled Exposure

Frequency Range (MHz)	Electric Field Strength (E) (V/m)	Magnetic Field Strength (E) (A/m)	Power Density (S) (mW/cm <sup>2</sup> )	Averaging Time  E  <sup>2</sup> ,  H  <sup>2</sup> or S (minutes)
0.3-3.0	614	1.63	(100)*	6
3.0-30	1842/f	4.89/f	(900/f <sup>2</sup> )*	6
30-300	61.4	0.163	1.0	6
300-1500	-	-	f/300	6
1500-100,000	-	-	5	6

### (B) Limits for General Population/Uncontrolled Exposure

Frequency Range (MHz)	Electric Field Strength (E) (V/m)	Magnetic Field Strength (E) (A/m)	Power Density (S) (mW/cm <sup>2</sup> )	Averaging Time  E  <sup>2</sup> ,  H  <sup>2</sup> or S (minutes)
0.3-1.34	614	1.63	(100)*	30
1.34-30	824/f	2.19/f	(180/f <sup>2</sup> )*	30
30-300	27.5	0.073	0.2	30
300-1500	-	-	f/1500	30
1500-100,000	-	-	1.0	30

f = frequency in MHz \* Plane-wave equivalent power density

NOTE 1: Occupational/controlled limits apply in situations in which persons are exposed as a consequence of their employment provided those persons are fully aware of the potential for exposure and can exercise control over their exposure. Limits for occupational/controlled exposure also apply in situations when an individual is transient through a location where occupational/controlled limits apply provided he or she is made aware of the potential for exposure.

NOTE 2: General population/uncontrolled exposures apply in situations in which the general public may be exposed, or in which persons that are exposed as a consequence of their employment may not be fully aware of the potential for exposure or can not exercise control over their exposure.

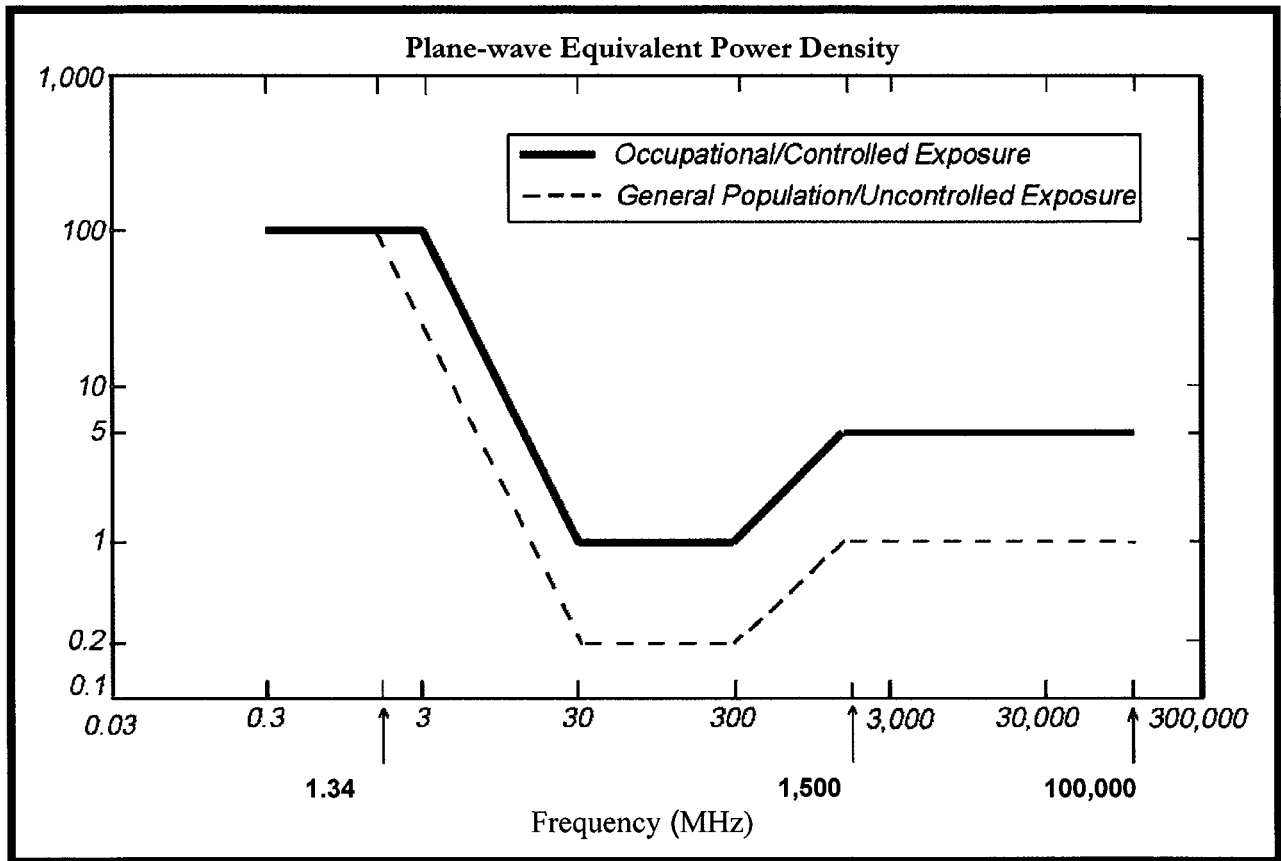

• FCC Limits for Maximum Permissible Exposure (MPE)

# **Exhibit E**

## **Structural Analysis**

**Pocket Site HFCT1509A**

**100 Berlin Road**

**Cromwell, Connecticut**



## Structural Analysis Report

*82' Sign Structure w/ 111' Pipe Mast*

*Pocket Wireless Site Ref: HFCT1509A*

*100 Berlin Road  
Cromwell, CT*

*Natcomm Project No. 08136-CO-15*

*Date: March 01, 2009*



**Prepared for:**

**Verizon Wireless**  
99 East River Road, 9<sup>th</sup> Floor  
East Hartford, CT 06108

p: 203.488.0580  
f: 203.488.6587  
w: nat-eng.com  
63-2 N. Branford Rd.  
Branford, CT 06405

## **Table of Contents**

### **SECTION 1 - REPORT**

- INTRODUCTION.
- ANTENNA AND APPURTENANCE SUMMARY.
- PRIMARY ASSUMPTIONS USED IN THE ANALYSIS.
- ANALYSIS.
- TOWER LOADING.
- TOWER CAPACITY.
- FOUNDATION AND ANCHORS.
- CONCLUSION.

### **SECTION 2 – CONDITIONS & SOFTWARE**

- STANDARD ENGINEERING CONDITIONS.
- GENERAL DESCRIPTION OF STRUCTURAL ANALYSIS PROGRAM.

### **SECTION 3 – WIND LOAD CALCULATIONS**

- EIA/TIA WIND LOADS ON STRUCTURAL MEMBERS.
- EIA/TIA WIND LOADS ON ANTENNAS AND MOUNTS.

### **SECTION 4 – RISA-3D**

- RISA-3D REPORT

### **SECTION 5 – CALCULATIONS**

- ANCHOR BOLTS AND BASE PLATE (MAST)
- FLANGE BOLTS AND FLANGE PLATE (MAST)
- ANCHOR BOLTS AND BASE PLATE (LEG)
- FOUNDATION

### **SECTION 5 – REFERENCE MATERIALS**

- ANTENNA CUT SHEETS



Natcomm, Inc.  
Structural Analysis  
82' Sign Structure w/ 111' Pipe Mast  
Cromwell, CT  
March 01, 2009

## Introduction

The purpose of this report is to summarize the results of the non-linear, P- $\Delta$  structural analysis of the antenna installation proposed by Pocket Wireless on the existing 82-ft sign structure located in Cromwell, Connecticut.

The host structure is a 82-ft sign structure with a 111-ft pipe mast. The existing structure geometry, member sizes, foundation system and antenna and appurtenance information were obtained from a previous structural design report prepared by URS Corporation dated December 1, 2005 and visual verification of the existing structure conducted from existing grade by Natcomm personnel during February 2009.

The structure is made up of two (2) W24x68 vertical steel legs, one (1) HSS18x0.5 steel pipe mast, L5x5x5/16 horizontal and diagonal steel bracing and WT6x15 steel bracing.

Pocket Wireless is proposing the installation of three (3) panel antennas and six (6) coax cables. Refer to the Antenna and Appurtenance Summary below for a detailed description of the proposed antenna and appurtenance configuration.

## Antenna and Appurtenance Summary

The existing structure was designed to support several communication antennas. The existing, proposed and future loads considered in this analysis consist of the following:

- T-MOBILE: (Existing/Reserved)  
Antennas: Nine (9) EMS DR65-19-00DPQ panel antennas on a low profile platform mounted on a 111-ft pipe mast with a RAD center elevation of 108-ft AGL.  
Coax Cables: Twenty four (24) 1-5/8"  $\emptyset$  coax cables, twelve (12) within existing 111-ft pipe mast and twelve (12) exterior of the pipe mast.
- CINGULAR/AT&T: (Existing)  
Antennas: Six (6) Powerwave 7770.00 panel antennas, six (6) Powerwave LPG21401 TMA's and six (6) Powerwave LPG13519 diplexers on pipe mounts with a RAD center elevation of 98-ft AGL.  
Coax Cables: Twelve (12) 1-5/8"  $\emptyset$  coax cables run on the exterior of existing sign structure.
- VERIZON: (Existing)  
Antennas: Nine (9) Swedcom ALP-9212 and six (6) Decibel 948F85T2E-M\_2 panel antennas with a RAD center elevation of 88-ft AGL.  
Coax Cables: Fifteen (15) 1-5/8"  $\emptyset$  coax cables run on the exterior of the existing sign structure.

Natcomm, Inc.  
Structural Analysis  
82' Sign Structure w/ 111' Pipe Mast  
Cromwell, CT  
March 01, 2009

- T-MOBILE (Existing/Reserved)  
Antennas: One (1) VIC-100 GPS antenna on a side arm mounted to the leg of the sign structure with a RAD center elevation of 50-ft AGL.  
Coax Cables: One (1) 1/2" Ø coax cable run on the exterior of the existing sign structure.
- POCKET WIRELESS (Proposed)  
Antennas: Three (3) RFS APXV18-206517S-C panel antennas mounted to the steel flanges (legs) of the existing sign structure with a RAD center elevation of 77-ft AGL.  
Coax Cable: Six (6) 1-5/8" Ø coaxial cables vertically supported on the existing legs of the sign structure per detail 2/02 on URS drawing 02, dated 11/24/08.

### Primary Assumptions Used in the Analysis

- The structure's theoretical capacity not including any assessment of the condition of the tower.
- The structure carries the horizontal and vertical loads due to the weight of antennas, ice load and wind.
- Structure is properly installed and maintained.
- Structure is in plumb condition.
- Structure loading for antennas and mounts as listed in this report.
- All bolts are appropriately tightened providing the necessary connection continuity.
- All welds are fabricated with ER-70S-6 electrodes.
- All members are assumed to be as specified in the original structure design documents or reinforcement drawings.
- All members are "hot dipped" galvanized in accordance with ASTM A123 and ASTM A153 Standards.
- All member protective coatings are in good condition.
- All structure members were properly designed, detailed, fabricated, installed and have been properly maintained since erection.
- Any deviation from the analyzed antenna loading will require a new analysis for verification of structural adequacy.

Natcomm, Inc.  
Structural Analysis  
82' Sign Structure w/ 111' Pipe Mast  
Cromwell, CT  
March 01, 2009

## Analysis

The existing tower was analyzed using a comprehensive computer program entitled RISA-3D. The program analyzes the structure, considering the worst case loading condition.

The existing structure was analyzed for 85 mph basic wind speed (fastest mile) with no ice and 75% reduction of wind force with ½ inch accumulative ice to determine stresses in members as per guidelines of TIA/EIA-222-F-96 entitled "Structural Standards for Steel Antenna Towers and Antenna Supporting Structures", the American Institute of Steel Construction (AISC) and the Manual of Steel Construction; Allowable Stress Design (ASD).

## Structure Loading

Structure loading was determined by the basic wind speed as applied to projected surface areas with modification factors per TIA/EIA-222-F, gravity loads of the structure and its components, and the application of ½" radial ice to the structure and its components.

Basic Wind Speed:	Middlesex; v = 85 mph (fastest mile)	[Section 16 of TIA/EIA-222-F-96]
	Cromwell; v = 100 mph (3 second gust) equivalent to v = 80 mph (fastest mile)	[Appendix K of the 2005 CT Building Code Supplement]
	<i>TIA/EIA wind speed criteria controls..</i>	
Load Cases:	<u>Load Case 1</u> ; 85 mph wind speed w/ no ice plus gravity load – used in calculation of tower stresses and rotation. This load case typically controls the design.	[Section 2.3.16 of TIA/EIA-222-F-96]
	<u>Load Case 2</u> ; 74 mph wind speed w/ ½" radial ice plus gravity load – used in calculation of tower stresses. The 74 mph wind speed velocity represents 75% of the wind pressure generated by the 85 mph wind speed.	[Section 2.3.16 of TIA/EIA-222-F-96]
	<u>Load Case 3</u> ; Seismic – not checked	[Section 1614.5 of CT State Bldg. Code 2005] does not control in the design of this structure type

## Structure Capacity

Member stresses were calculated utilizing the structural analysis software RISA-3D. Allowable stresses were determined based on Table 5 of the TIA/EIA code with a 1/3 increase per Section 3.1.1.1 of the same code.

Calculated stresses were found to be within allowable limits. In Load Case 6, per RISA-3D "Steel Code Checks", this structure was found to be at **98.8%** of its total capacity.

Tower Section	Location	Stress Ratio (percentage of capacity)	Result
Leg 2	1.25'	98.8%	<b>PASS</b>

## Foundation and Anchors

The existing foundation consists of an 55-ft long (approx) x 8.5-ft wide x 3-ft deep reinforced concrete strip footing with concrete column pedestals. The sub-grade conditions used in the analysis of the existing foundation were based on normal soil values as permitted by EIA/TIA-222-F Section 7.1.3. The base of the sign structure is connected to the foundation by means of (20) 1"Ø, (assumed ASTM A-615-75) anchor bolts embedded into the existing concrete foundation. The base of the communications pipe structure is connected to the foundation by means of (10) 1.75"Ø, ASTM A615-75 anchor bolts embedded into the existing concrete foundation.

Review of the foundation and anchor design consisted of verification of applied loads obtained from the tower design calculations and code checks of allowable stresses:

Foundation	Design Limit	IBC 2003/2005 CT State Building Code Section 3108.4.2	Proposed Loading	Result
Reinf. Conc. Pad w/ Pedestals	OTM	2.0	3.5	<b>PASS</b>

- The foundation was found to be within allowable limits.

Note: OTM denotes Overturning Moment

Natcomm, Inc.  
Structural Analysis  
82' Sign Structure w/ 111' Pipe Mast  
Cromwell, CT  
March 01, 2009

Structure Component	Design Limit	Stress Ratio (percentage of capacity)	Result
Anchor Bolts (Mast)	Tension	61.4%	PASS
Base Plate (Mast)	Bending	43.5%	PASS
Flange Bolts	Tension	30.7%	PASS
Flange Plate	Bending	26.9%	PASS
Anchor Bolts (Leg)	Tension	29.3%	PASS
Base Plate (Leg)	Bending	98.0%	PASS

- The structure anchor bolts, base plate and flange plates were found to be within allowable limits.

### Conclusion

This analysis shows that the subject structure **is adequate** to support the proposed modified antenna configuration.

The analysis is based, in part, on the information provided to this office by Verizon Wireless. If the existing conditions are different than the information in this report, Natcomm, Inc. must be contacted for resolution of any potential issues.

Please feel free to call with any questions or comments.

Respectfully Submitted by:

  
Carlo F. Centore, PE  
Principal ~ Structural Engineer

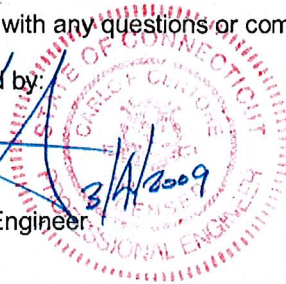



Natcomm, Inc.  
Structural Analysis  
Cromwell, CT  
March 1, 2009

STANDARD CONDITIONS FOR FURNISHING OF  
PROFESSIONAL ENGINEERING SERVICES ON  
EXISTING STRUCTURES

All engineering services are performed on the basis that the information used is current and correct. This information may consist of, but is not necessarily limited to:

- Information supplied by the client regarding the structure itself, its foundations, the soil conditions, the antenna and feed line loading on the structure and its components, or other relevant information.
- Information from the field and/or drawings in the possession of Natcomm, Inc. or generated by field inspections or measurements of the structure.
- It is the responsibility of the client to ensure that the information provided to Natcomm, Inc. and used in the performance of our engineering services is correct and complete. In the absence of information to the contrary, we assume that all structures were constructed in accordance with the drawings and specifications and are in an un-corroded condition and have not deteriorated. It is therefore assumed that its capacity has not significantly changed from the "as new" condition.
- All services will be performed to the codes specified by the client, and we do not imply to meet any other codes or requirements unless explicitly agreed in writing. If wind and ice loads or other relevant parameters are to be different from the minimum values recommended by the codes, the client shall specify the exact requirement. In the absence of information to the contrary, all work will be performed in accordance with the latest revision of ANSI/ASCE10 & ANSI/EIA-222.
- All services are performed, results obtained, and recommendations made in accordance with generally accepted engineering principles and practices. Natcomm, Inc. is not responsible for the conclusions, opinions and recommendations made by others based on the information we supply.

## GENERAL DESCRIPTION OF STRUCTURAL ANALYSIS PROGRAM ~ RISA - 3 D

RISA-3D Structural Analysis Program is an integrated structural analysis and design software package for buildings, bridges, tower structures, etc.

### Modeling Features:

- Comprehensive CAD-like graphic drawing/editing capabilities that let you draw, modify and load elements as well as snap, move, rotate, copy, mirror, scale, split, merge, mesh, delete, apply, etc.
- Versatile drawing grids (orthogonal, radial, skewed)
- Universal snaps and object snaps allow drawing without grids
- Versatile general truss generator
- Powerful graphic select/unselect tools including box, line, polygon, invert, criteria, spreadsheet selection, with locking
- Saved selections to quickly recall desired selections
- Modification tools that modify single items or entire selections
- Real spreadsheets with cut, paste, fill, math, sort, find, etc.
- Dynamic synchronization between spreadsheets and views so you can edit or view any data in the plotted views or in the spreadsheets
- Simultaneous view of multiple spreadsheets
- Constant in-stream error checking and data validation
- Unlimited undo/redo capability
- Generation templates for grids, disks, cylinders, cones, arcs, trusses, tanks, hydrostatic loads, etc.
- Support for all units systems & conversions at any time
- Automatic interaction with RISASection libraries
- Import DXF, RISA-2D, STAAD and ProSteel 3D files
- Export DXF, SDNF and ProSteel 3D files

### Analysis Features:

- Static analysis and P-Delta effects
- Multiple simultaneous dynamic and response spectra analysis using Gupta, CQC or SRSS mode combinations
- Automatic inclusion of mass offset (5% or user defined) for dynamic analysis
- Physical member modeling that does not require members to be broken up at intermediate joints
- State of the art 3 or 4 node plate/shell elements
- High-end automatic mesh generation — draw a polygon with any number of sides to create a mesh of well-formed quadrilateral (NOT triangular) elements.
- Accurate analysis of tapered wide flanges - web, top and bottom flanges may all taper independently
- Automatic rigid diaphragm modeling
- Area loads with one-way or two-way distributions
- Multiple simultaneous moving loads with standard AASHTO loads and custom moving loads for bridges, cranes, etc.
- Torsional warping calculations for stiffness, stress and design
- Automatic Top of Member offset modeling
- Member end releases & rigid end offsets
- Joint master-slave assignments
- Joints detachable from diaphragms
- Enforced joint displacements
- 1-Way members, for tension only bracing, slipping, etc.

- 1-Way springs, for modeling soils and other effects
- Euler members that take compression up to their buckling load, then turn off.
- Stress calculations on any arbitrary shape
- Inactive members, plates, and diaphragms allows you to quickly remove parts of structures from consideration
- Story drift calculations provide relative drift and ratio to height
- Automatic self-weight calculations for members and plates
- Automatic subgrade soil spring generator

Graphics Features:

- Unlimited simultaneous model view windows
- Extraordinary "true to scale" rendering, even when drawing
- High-speed redraw algorithm for instant refreshing
- Dynamic scrolling stops right where you want
- Plot & print virtually everything with color coding & labeling
- Rotate, zoom, pan, scroll and snap views
- Saved views to quickly restore frequent or desired views
- Full render or wire-frame animations of deflected model and dynamic mode shapes with frame and speed control
- Animation of moving loads with speed control
- High quality customizable graphics printing

Design Features:

- Designs concrete, hot rolled steel, cold formed steel and wood
- ACI 1999/2002, BS 8110-97, CSA A23.3-94, IS456:2000, EC 2-1992 with consistent bar sizes through adjacent spans
- Exact integration of concrete stress distributions using parabolic or rectangular stress blocks
- Concrete beam detailing (Rectangular, T and L)
- Concrete column interaction diagrams
- Steel Design Codes: AISC ASD 9th, LRFD 2nd & 3rd, HSS Specification, CAN/CSA-S16.1-1994 & 2004, BS 5950-1-2000, IS 800-1984, Euro 3-1993 including local shape databases
- AISI 1999 cold formed steel design
- NDS 1991/1997/2001 wood design, including Structural Composite Lumber, multi-ply, full sawn
- Automatic spectra generation for UBC 1997, IBC 2000/2003
- Generation of load combinations: ASCE, UBC, IBC, BOCA, SBC, ACI
- Unbraced lengths for physical members that recognize connecting elements and full lengths of members
- Automatic approximation of K factors
- Tapered wide flange design with either ASD or LRFD codes
- Optimization of member sizes for all materials and all design codes, controlled by standard or user-defined lists of available sizes and criteria such as maximum depths
- Automatic calculation of custom shape properties
- Steel Shapes: AISC, HSS, CAN, ARBED, British, Euro, Indian, Chilean
- Light Gage Shapes: AISI, SSMA, Dale / Incor, Dietrich, MarinoWARE
- Wood Shapes: Complete NDS species/grade database
- Full seamless integration with RISAFoot (Ver 2 or better) for advanced footing design and detailing
- Plate force summation tool

*Natcomm, Inc.  
Structural Analysis  
Cromwell, CT  
March 1, 2009*

Results Features:

- Graphic presentation of color-coded results and plotted designs
- Color contours of plate stresses and forces with quadratic smoothing, the contours may also be animated
- Spreadsheet results with sorting and filtering of: reactions, member & joint deflections, beam & plate forces/stresses, optimized sizes, code designs, concrete reinforcing, material takeoffs, frequencies and mode shapes
- Standard and user-defined reports
- Graphic member detail reports with force/stress/deflection diagrams and detailed design calculations and expanded diagrams that display magnitudes at any dialed location
- Saved solutions quickly restore analysis and design results.