



STATE OF CONNECTICUT

CONNECTICUT SITING COUNCIL

Ten Franklin Square, New Britain, CT 06051

Phone: (860) 827-2935 Fax: (860) 827-2950

E-Mail: siting.council@ct.gov

www.ct.gov/csc

October 21, 2011

Kenneth C. Baldwin, Esq.
Robinson & Cole LLP
280 Trumbull Street
Hartford, CT 06103

RE: **EM-VER-030-111005** - Cellco Partnership d/b/a Verizon Wireless notice of intent to modify an existing telecommunications facility located at 14 Thompson Hill Road, Columbia, Connecticut.

Dear Attorney Baldwin:

The Connecticut Siting Council (Council) hereby acknowledges your notice to modify this existing telecommunications facility, pursuant to Section 16-50j-73 of the Regulations of Connecticut State Agencies with the following conditions:

- Any deviation from the proposed modification as specified in this notice and supporting materials with Council shall render this acknowledgement invalid;
- Any material changes to this modification as proposed shall require the filing of a new notice with the Council;
- Not less than 45 days after completion of construction, the Council shall be notified in writing that construction has been completed;
- The validity of this action shall expire one year from the date of this letter; and
- The applicant may file a request for an extension of time beyond the one year deadline provided that such request is submitted to the Council not less than 60 days prior to the expiration;

The proposed modifications including the placement of all necessary equipment and shelters within the tower compound are to be implemented as specified here and in your notice dated October 4, 2011. The modifications are in compliance with the exception criteria in Section 16-50j-72 (b) of the Regulations of Connecticut State Agencies as changes to an existing facility site that would not increase tower height, extend the boundaries of the tower site, increase noise levels at the tower site boundary by six decibels, and increase the total radio frequencies electromagnetic radiation power density measured at the tower site boundary to or above the standard adopted by the State Department of Environmental Protection pursuant to General Statutes § 22a-162. This facility has also been carefully modeled to ensure that radio frequency emissions are conservatively below State and federal standards applicable to the frequencies now used on this tower.

This decision is under the exclusive jurisdiction of the Council. Please be advised that the validity of this action shall expire one year from the date of this letter. Any additional change to this facility will require explicit notice to this agency pursuant to Regulations of Connecticut State Agencies Section 16-50j-73. Such notice shall include all relevant information regarding the proposed change with cumulative worst-case modeling of radio frequency exposure at the closest point of uncontrolled access to the tower base, consistent with Federal Communications Commission, Office of Engineering and Technology, Bulletin 65. Thank you for your attention and cooperation.

Very truly yours,

Linda Roberts
Executive Director

LR/CDM/laf

c: The Honorable Carmen L. Vance, First Selectman, Town of Columbia
Carl S. Fontneau, Town Planner, Town of Columbia
Crown Castle USA, Inc.



Martin, David C.

From: Mayo, Rachel [rmayo@RC.com]
Sent: Friday, October 07, 2011 10:42 AM
To: Martin, David C.
Cc: Mayo, Rachel
Subject: Columbia- revised rf table
Attachments: coventry s rf table (swap).xls; ATT00001..txt

As requested.

Thank you

Rachel A. Mayo
Land Use Analyst

Robinson & Cole LLP
280 Trumbull Street
Hartford, CT 06103-3597
Direct 860-275-8213 | Fax 860-275-8299
rmayo@rc.com | www.rc.com
[Bio](#) | [Contact Card](#)

Boston Providence Hartford New London
Stamford New York Albany White Plains Sarasota



Please consider the environment before printing this email

		General		Power		Density							
Site Name: Coventry S													
Tower Height: Verizon @ 150ft													
CARRIER	# OF CHAN.	WATTS ERP	HEIGHT	CALC. POWER DENS	FREQ.	MAX. PERMISS. EXP.	FRACTION MPE	Total					
*Cingular GSM	2	427	140	0.0157	1900	1.0000	1.57%						
*Cingular GSM	4	296	140	0.0217	880	0.5867	3.70%						
*Cingular UMTS	1	500	140	0.0092	880	0.5867	1.56%						
*Sprint	4	250	178	0.0113	1950	1.0000	1.13%						
*Nextel	9	100	170	0.0112	851	0.5673	1.97%						
*VoiceStream	8	247	160	0.0278	1935	1.0000	2.78%						
Verizon	11	434	150	0.0763	1970	1.0000	7.63%						
Verizon	9	357	150	0.0513	869	0.5793	8.86%						
Verizon	1	616	150	0.0098	757	0.4973	1.98%						
								31.19%					
* Source: Siting Council													

280 Trumbull Street
Hartford, CT 06103-3597
Main (860) 275-8200
Fax (860) 275-8299
kbaldwin@rc.com
Direct (860) 275-8345

October 4, 2011

RECEIVED
OCT - 5 2011

CONNECTICUT
SITING COUNCIL

Linda Roberts
Executive Director
Connecticut Siting Council
10 Franklin Square
New Britain, CT 06051

Re: **Notice of Exempt Modification – Antenna Swap
14 Thompson Hill Road, Columbia, Connecticut**

Dear Ms. Roberts:

Cellco Partnership d/b/a Verizon Wireless (“Cellco”) currently maintains wireless telecommunications antennas at the 146-foot level on the existing 180-foot tower at the above-referenced address. The tower is owned by Crown Castle. Cellco intends to modify its facility by replacing all of its antennas with four (4) model APL868013 cellular antennas; two (2) model APL866513 cellular antennas; three (3) model BXA-171085-8BF PCS antennas; and three (3) model BXA-70063/6CF LTE antennas, at the same 146-foot level on the tower. Cellco also intends to install six (6) coax cable diplexers on its antenna platform. Attached behind Tab 1 are the specifications for the replacement antennas and cable diplexers.

Please accept this letter as notification pursuant to R.C.S.A. § 16-50j-73, for construction that constitutes an exempt modification pursuant to R.C.S.A. § 16-50j-72(b)(2). In accordance with R.C.S.A. § 16-50j-73, a copy of this letter is being sent to Carmen L. Vance, First Selectman for the Town of Columbia. A copy of this letter is also being sent to Thomas Deojay, the owner of the property on which the tower is located.

The planned modifications to the facility fall squarely within those activities explicitly provided for in R.C.S.A. § 16-50j-72(b)(2).

1. The proposed modifications will not result in any increase in the overall height of the existing tower. Cellco’s antennas and diplexers will be located at the same 146-foot level on the existing 180-foot tower.



Law Offices

BOSTON

PROVIDENCE

HARTFORD

NEW LONDON

STAMFORD

WHITE PLAINS

NEW YORK CITY

ALBANY

SARASOTA

www.rc.com

11266008-v1

ROBINSON & COLE_{LLP}

Linda Roberts
October 4, 2011
Page 2

2. The proposed modifications will not involve any modifications to ground-mounted equipment and, therefore, will not require the extension of the site boundaries.

3. The proposed modifications will not increase noise levels at the facility by six decibels or more.

4. The operation of the replacement antennas will not increase radio frequency (RF) power density levels at the facility to a level at or above the Federal Communications Commission (FCC) adopted safety standard. A cumulative power density table for Cellco's modified facility is included behind Tab 2.

Also attached is a Structural Analysis Report confirming that the tower and foundation can support Cellco's proposed antennas modification. (See Tab 3).

For the foregoing reasons, Cellco respectfully submits that the proposed modifications to the above-referenced telecommunications facility constitutes an exempt modification under R.C.S.A. § 16-50j-72(b)(2).

Sincerely,



Kenneth C. Baldwin

Enclosures

Copy to:

Carmen L. Vance, Columbia First Selectman
Thomas Deojay
Sandy M. Carter





Maximizer® Log Periodic Antenna, 806-894, 80deg, 14.1dBi, 1.2m, FET, 0deg

Product Description

The Celwave® Maximizer series is a log periodic dipole array which uses a patented design to achieve a front-to-back ratio of 45 dB, the highest front-to-back ratio in the industry. Maximizers are available to cover ESMR, AMPS, PCS and DCS frequency ranges. They use RFS's patented monolithic CELlite® technology, which eliminates cable and soldered joints to reduce the possibility of inter-modulation products. The CELlite technology assures high reliability and excellent repeatability of electrical characteristics. The cellular Maximizers are available in 65°, 80° and 90° horizontal beamwidths and the PCS/DCS Maximizers are available in 65° and 90° horizontal beamwidths. Patent number 6,133,889.



Features/Benefits

- 45 dB front-to-back ratio reduces co-channel interference.
- Monolithic construction reduces IM.
- No solder joints, high reliability.
- Surface treated components prevent galvanic corrosion.
- UV stabilized radome assures long life without radome deterioration due to UV exposure.

Technical Specifications

Electrical Specifications

Frequency Range, MHz	806-894
Horizontal Beamwidth, deg	80
Vertical Beamwidth, deg	15
Electrical Downtilt, deg	0
Gain, dBi (dBd)	14.1 (12)
Front-To-Back Ratio, dB	45
Polarization	Vertical
VSWR	< 1.5:1
Impedance, Ohms	50
Maximum Power Input, W	500
Lightning Protection	Direct Ground
Connector Type	7-16 DIN Female

Mechanical Specifications

Dimensions - HxWxD, mm (in)	1219 x 152 x 203 (48 x 6 x 8)
Weight w/o Mtg Hardware, kg (lb)	2.8 (6.32)
Survival Wind Speed, km/h (mph)	200 (125)
Rated Wind Speed, km/h (mph)	200 (125)
Max Wind Loading Area, m² (ft²)	0.307 (3.3)
Maximum Thrust @ Rated Wind, N (lbf)	916 (206)
Wind Load - Side @ Rated Wind, N (lbf)	743 (167)
Radome Material	UV Stabilized High Impact ABS
Shipping Weight, kg (lb)	7.9 (17.5)
Packing Dimensions, HxWxD, mm (in)	1270 x 305 x 203 (50 x 12 x 8)

Ordering Information

Mounting Hardware	APM21-3
-------------------	---------

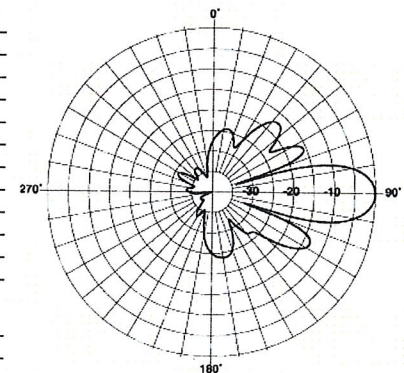

Vertical Pattern

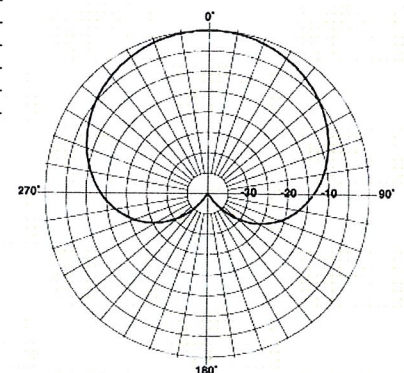

Horizontal Pattern

Other Documentation

All information contained in the present datasheet is subject to confirmation at time of ordering



Maximizer® Log Periodic Antenna, 806-894, 65deg, 15.1dBi, 1.2m, FET, 0deg

Product Description

The Celwave® Maximizer series is a log periodic dipole array which uses a patented design to achieve a front-to-back ratio of 45 dB, the highest front-to-back ratio in the industry. Maximizers are available to cover ESMR, AMPS, PCS and DCS frequency ranges. They use RFS's patented monolithic CELLite® technology, which eliminates cable and soldered joints to reduce the possibility of inter-modulation products. The CELLite technology assures high reliability and excellent repeatability of electrical characteristics. The cellular Maximizers are available in 65°, 80° and 90° horizontal beamwidths and the PCS/DCS Maximizers are available in 65° and 90° horizontal beamwidths. Patent number 6,133,889.

Features/Benefits

- 45 dB front-to-back ratio reduces co-channel interference.
- Monolithic construction reduces IM.
- No solder joints, high reliability.
- Surface treated components prevent galvanic corrosion.
- UV stabilized radome assures long life without radome deterioration due to UV exposure.

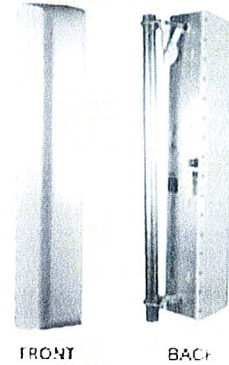

Technical Specifications

Electrical Specifications

Frequency Range, MHz	806-894
Horizontal Beamwidth, deg	65
Vertical Beamwidth, deg	15
Electrical Downtilt, deg	0
Gain, dBi (dBd)	15.1 (13)
1st Upper Sidelobe Suppression, dB	>20
Upper Sidelobe Suppression, dB	>20
Front-To-Back Ratio, dB	45
Polarization	Vertical
VSWR	< 1.5:1
Impedance, Ohms	50
Maximum Power Input, W	500
Lightning Protection	Direct Ground
Connector Type	7-16 DIN Female

Mechanical Specifications

Dimensions - HxWxD, mm (in)	1219 x 234 x 203 (48 x 9.2 x 8)
Weight w/o Mtg Hardware, kg (lb)	7 (15.7)
Survival Wind Speed, km/h (mph)	200 (125)
Rated Wind Speed, km/h (mph)	180 (112)
Max Wind Loading Area, m² (ft²)	0.376 (4.05)
Maximum Thrust @ Rated Wind, N (lbf)	903 (203)
Wind Load - Side @ Rated Wind, N (lbf)	594 (133.5)
Radome Material	UV Stabilized High Impact ABS
Shipping Weight, kg (lb)	9.1 (20)
Packing Dimensions, HxWxD, mm (in)	1594 x 343 x 349 (62.75 x 13.5 x 13.75)

Ordering Information

Mounting Hardware	APM21-3
-------------------	---------

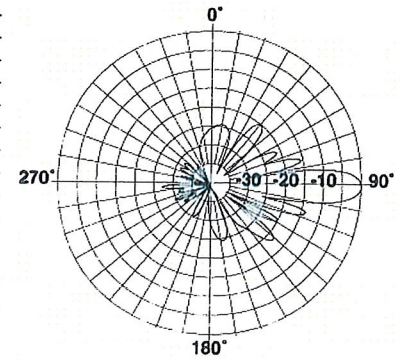

Vertical Pattern

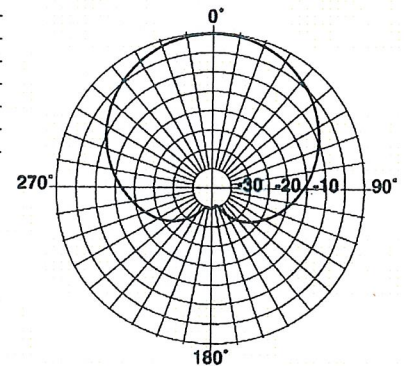

Horizontal Pattern

Other Documentation

All information contained in the present datasheet is subject to confirmation at time of ordering

BXA-171085-8CF-EDIN-X

Replace "X" with desired electrical downtilt.

X-Pol | FET Panel | 85° | 16.4 dBi

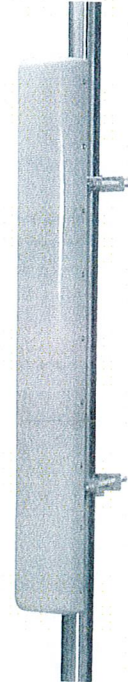

Electrical Characteristics	1710-2170 MHz		
Frequency bands	1710-1880 MHz	1850-1990 MHz	1920-2170 MHz
Polarization	±45°	±45°	±45°
Horizontal beamwidth	88°	85°	80°
Vertical beamwidth	7°	7°	7°
Gain	13.5 dBd / 15.6 dBi	13.9 dBd / 16.0 dBi	14.3 dBd / 16.4 dBi
Electrical downtilt (X)		0, 2, 4	
Impedance		50Ω	
VSWR		≤1.5:1	
First upper sidelobe		< -17 dB	
Front-to-back isolation		> 30 dB	
In-band isolation		> 28 dB	
IM3 (20W carrier)		< -150 dBc	
Input power		300 W	
Lightning protection		Direct Ground	
Connector(s)	2 Ports / EDIN / Female / Center (Back)		
Operating temperature	-40° to +60° C / -40° to +140° F		
Mechanical Characteristics			
Dimensions Length x Width x Depth	1232 x 154 x 105 mm	48.5 x 6.1 x 4.1 in	
Depth with t-brackets	133 mm	5.2 in	
Weight without mounting brackets	4.8 kg	10.5 lbs	
Survival wind speed	296 km/hr	184 mph	
Wind area	Front: 0.19 m ² Side: 0.14 m ²	Front: 2.0 ft ²	Side: 1.5 ft ²
Wind load @ 161 km/hr (100 mph)	Front: 281 N Side: 223 N	Front: 63 lbf	Side: 50 lbf
Mounting Options	Part Number	Fits Pipe Diameter	Weight
2-Point Mounting Bracket Kit	26799997	50-102 mm 2.0-4.0 in	2.3 kg 5 lbs
2-Point Mounting & Downtilt Bracket Kit	26799999	50-102 mm 2.0-4.0 in	3.6 kg 8 lbs
Concealment Configurations	For concealment configurations, order BXA-171085-8CF-EDIN-X-FP		

BXA-171085-8CF-EDIN-X

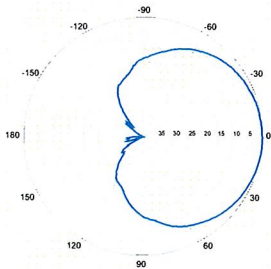

Horizontal | 1710-1880 MHz
BXA-171085-8CF-EDIN-0

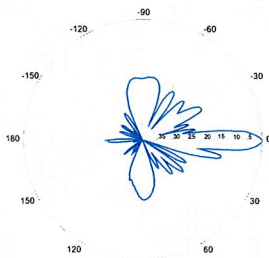

0° | Vertical | 1710-1880 MHz

BXA-171085-8CF-EDIN-X

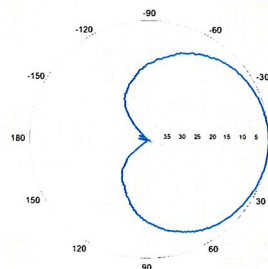

Horizontal | 1850-1990 MHz
BXA-171085-8CF-EDIN-0

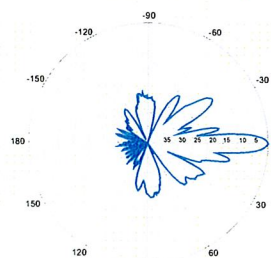

0° | Vertical | 1850-1990 MHz

BXA-171085-8CF-EDIN-X

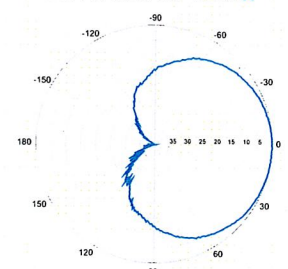

Horizontal | 1920-2170 MHz
BXA-171085-8CF-EDIN-0

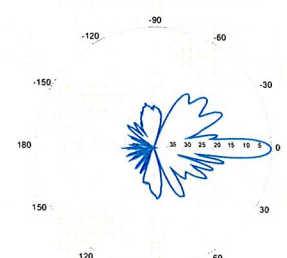

0° | Vertical | 1920-2170 MHz

Quoted performance parameters are provided to offer typical or range values only and may vary as a result of normal manufacturing and operational conditions. Extreme operational conditions and/or stress on structural supports is beyond our control. Such conditions may result in damage to this product. Improvements to product may be made without notice.

BXA-171085-8CF-EDIN-X

X-Pol | FET Panel | 85° | 16.4 dBi

BXA-171085-8CF-EDIN-2

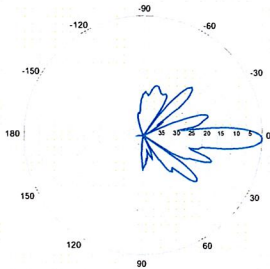

2° | Vertical | 1710-1880 MHz

BXA-171085-8CF-EDIN-4

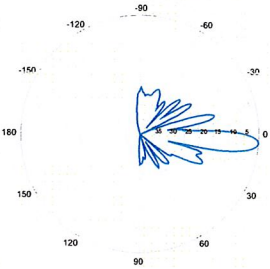

4° | Vertical | 1710-1880 MHz

BXA-171085-8CF-EDIN-2

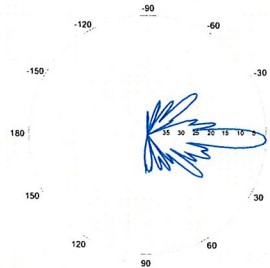

2° | Vertical | 1850-1990 MHz

BXA-171085-8CF-EDIN-4

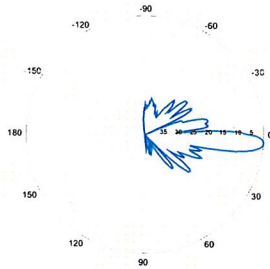

4° | Vertical | 1850-1990 MHz

BXA-171085-8CF-EDIN-2

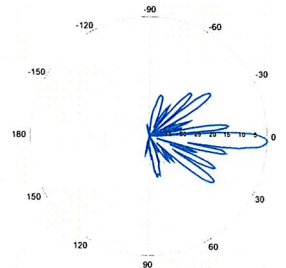

2° | Vertical | 1920-2170 MHz

BXA-171085-8CF-EDIN-4

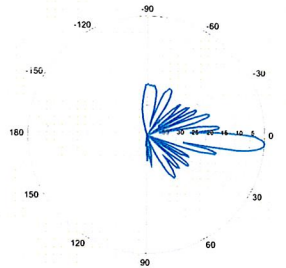

4° | Vertical | 1920-2170 MHz

Quoted performance parameters are provided to offer typical or range values only and may vary as a result of normal manufacturing and operational conditions. Extreme operational conditions and/or stress on structural supports is beyond our control. Such conditions may result in damage to this product. Improvements to product may be made without notice.

BXA-70063-6CF-EDIN-X

X-Pol | FET Panel | 63° | 14.5 dBd

Replace "X" with desired electrical downtilt.

Antenna is also available with NE connector(s). Replace "EDIN" with "NE" in the model number when ordering.



Electrical Characteristics	696-900 MHz		
Frequency bands	696-806 MHz	806-900 MHz	
Polarization	±45°		
Horizontal beamwidth	65°	63°	
Vertical beamwidth	13°	11°	
Gain	14.0 dBd (16.1 dBi)	14.5 dBd (16.6 dBi)	
Electrical downtilt (X)	0, 2, 3, 4, 5, 6, 8, 10		
Impedance	50Ω		
VSWR	≤1.35:1		
Upper sidelobe suppression (0°)	-18.3 dB	-18.2 dB	
Front-to-back ratio (+/-30°)	-33.4 dB	-36.3 dB	
Null fill	5% (-26.02 dB)		
Isolation between ports	< -25 dB		
Input power with EDIN connectors	500 W		
Input power with NE connectors	300 W		
Lightning protection	Direct Ground		
Connector(s)	2 Ports / EDIN or NE / Female / Center (Back)		
Mechanical Characteristics			
Dimensions Length x Width x Depth	1804 x 285 x 132 mm	71.0 x 11.2 x 5.2 in	
Depth with z-brackets	172 mm	6.8 in	
Weight without mounting brackets	7.9 kg	17 lbs	
Survival wind speed	> 201 km/hr	> 125 mph	
Wind area	Front: 0.51 m ² Side: 0.24 m ²	Front: 5.5 ft ² Side: 2.6 ft ²	
Wind load @ 161 km/hr (100 mph)	Front: 759 N Side: 391 N	Front: 169 lbf Side: 89 lbf	
Mounting Options	Part Number	Fits Pipe Diameter	Weight
3-Point Mounting Bracket Kit	36210003	50-160 mm 2.0-6.3 in	6.3 kg 14 lbs
3-Point Downtilt Bracket Kit (0-14°)	36210004	50-160 mm 2.0-6.3 in	7.3 kg 16 lbs
Downtilt Mounting Applications	A mounting bracket and downtilt bracket kit must be ordered for downtilt applications		
Concealment Configurations	For concealment configurations, order BXA-70063-6CF-EDIN-X-FP		

BXA-70063-6CF-EDIN-X

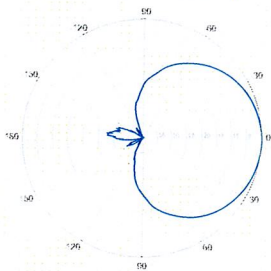

Horizontal | 750 MHz

BXA-70063-6CF-EDIN-0

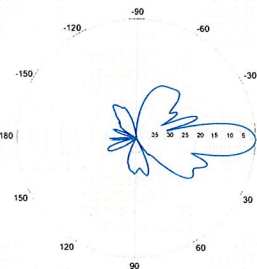

0° | Vertical | 750 MHz

BXA-70063-6CF-EDIN-2

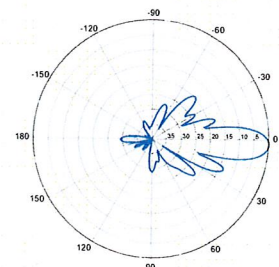

2° | Vertical | 750 MHz

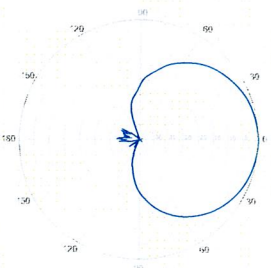

Horizontal | 850 MHz

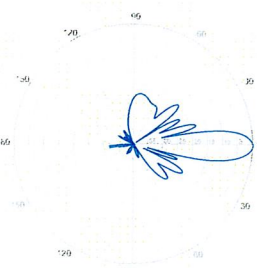

0° | Vertical | 850 MHz

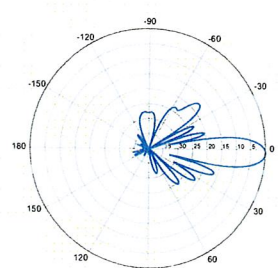

2° | Vertical | 850 MHz

Quoted performance parameters are provided to offer typical or range values only and may vary as a result of normal manufacturing and operational conditions. Extreme operational conditions and/or stress on structural supports is beyond our control. Such conditions may result in damage to this product. Improvements to product may be made without notice.

BXA-70063-6CF-EDIN-X

X-Pol | FET Panel | 63° | 14.5 dBd

BXA-70063-6CF-EDIN-3

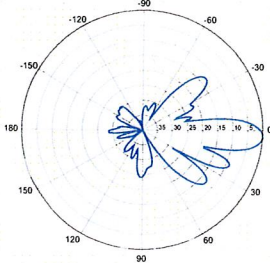

3° | Vertical | 750 MHz

BXA-70063-6CF-EDIN-4

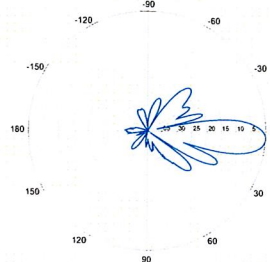

4° | Vertical | 750 MHz

BXA-70063-6CF-EDIN-5

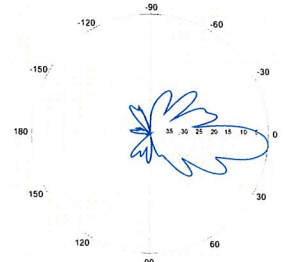

5° | Vertical | 750 MHz

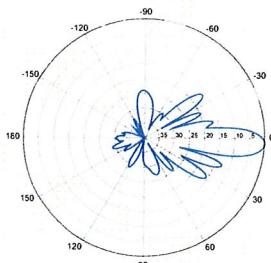

3° | Vertical | 850 MHz

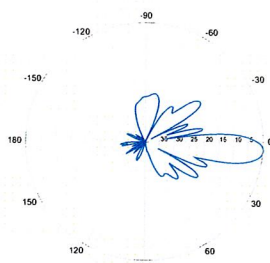

4° | Vertical | 850 MHz

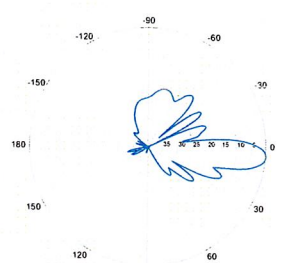

5° | Vertical | 850 MHz

BXA-70063-6CF-EDIN-6

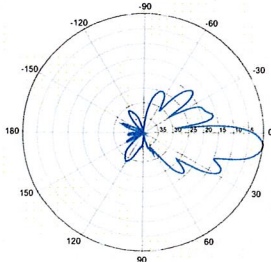

6° | Vertical | 750 MHz

BXA-70063-6CF-EDIN-8

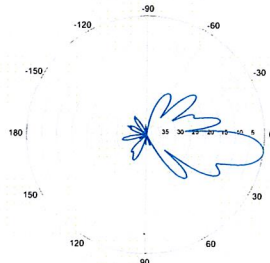

8° | Vertical | 750 MHz

BXA-70063-6CF-EDIN-10

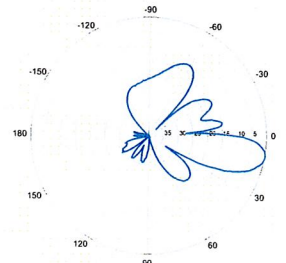

10° | Vertical | 750 MHz

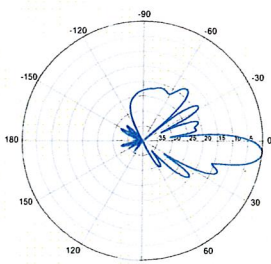

6° | Vertical | 850 MHz

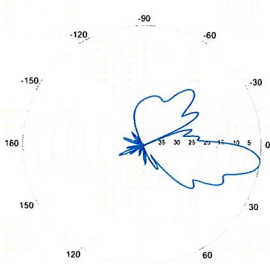

8° | Vertical | 850 MHz

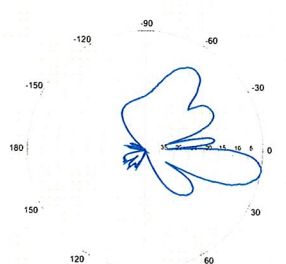

10° | Vertical | 850 MHz

Quoted performance parameters are provided to offer typical or range values only and may vary as a result of normal manufacturing and operational conditions. Extreme operational conditions and/or stress on structural supports is beyond our control. Such conditions may result in damage to this product. Improvements to product may be made without notice.



ShareLite Wideband Diplexer – In-line 698-960 MHz/1710-2200 MHz, full DC pass

Product Description

The ShareLite FD9R6004 Series of diplexers are designed to enable feeder sharing between systems in the 698-960 MHz range and in the 1710-2200 MHz range. The diplexer is equipped with in-line connector placement so it can be installed in the BTS cabinet or at the tower top. This is especially valuable in crowded sites or when the feeders are not easily accessible. Due to its wideband design, the FD9R6004 Series can accommodate many combining solutions between 698-960 MHz and 1710-2200 MHz systems such as LTE 700 MHz, Cellular 800 MHz with PCS, GSM900 with GSM1800, or GSM900 with UMTS. This diplexer features a highly selective filter. It provides a high level of isolation between ports, while keeping the insertion loss on both paths at an extremely low level. The FD9R6004 diplexers are available with various DC pass options, helpful in configurations with or without the Tower Mount Amplifiers installed.

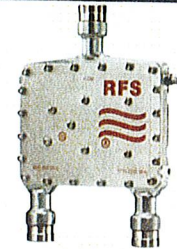

Features/Benefits

- LTE ready design
- Extremely Low Insertion Loss
- High level of Rejection between bands – Protection against interferences
- Extremely High Power Handling Capability
- Integrated DC block/bypass versions available
- Very compact & small size design – Easy installation and reduced tower load
- In-line long-neck connectors for easy connection & waterproofing
- Exceptional reliability & environmental protection (IP 67)
- Equipped with 1 * Breathable Vent – Prevent any humidity inside the product
- Mounting hardware for Wall and Pole mount provided (P/N SEM2-1A)
- Grounding already provided through the mounting bracket
- Kit available for easy dual mount

Technical Specifications

Product Type	Diplexer/Cross Band Coupler
Frequency Range 1, MHz	698-960
Frequency Range 2, MHz	1710-2200
Application	LTE700, GSM900, UMTS, GSM1800, Cellular 800, PCS
Configuration	Sharelite Single diplexer, outdoor, full DC pass, with mounting hardware SEM2-1A
Mounting	Wall Mounting: With 4 screws (maximum 6mm diameter); Pole Mounting: With included clamp set 40-110mm (1.57-4.33)
Return Loss All Ports Min/Typ, dB	19/23
Power Handling Continuous, Max, W	1250 at common port; 750 in low frequency path & 500 in high frequency path
Power Handling Peak, Max, W	15000 in low frequency path & 8000 in high frequency path
Impedance, Ohms	50
Insertion Loss, Path 1, dB	0.07 typ.
Insertion Loss, Path 2, dB	0.13 typ.
Rejection Between Bands Min/Typ, dB	58/64@698-960MHz; 60/70@1710-2200MHz
IMP Level at the COM Port, Typ, dBm	-112 @ 2x43
DC Pass in Low Frequency Path	Yes
DC Pass in High Frequency Path	Yes
Temperature Range, °C (°F)	-40 to +60 (-40 to +140)
Environmental	ETSI 300-019-2-4 Class 4.1E
Ingress Protection	IP 67
Lightning Protection	EN/IEC61000-4-5 Level 4
Connectors	In-line long-neck 7-16-Female
Weight, kg (lb)	1.2 (2.6)
Shipping Weight, kg (lb)	3.2 (7) for 2 * single units in 1 * box, 9.8 (21.6) for 6 * units = 3 * Boxes in 1 * overwrap
Dimensions, H x W x D, mm (in)	147 x 164 x 37 (5.8 x 6.5 x 1.5)
Shipping Dimensions, H x W x D, mm (in)	254 x 406 x 82 (10 x 16 x 3.2) for 2 * Single Units in 1 * box, 280 x 406 x 241 (11 x 16 x 9.5) for 6 * units = 3 * Boxes in 1 * overwrap
Volume, L	0.43
Housing	Aluminum

Notes

All information contained in the present datasheet is subject to confirmation at time of ordering



ShareLite Wideband Diplexer – In-line 698-960 MHz/1710-2200 MHz, full DC pass

Other Documentation

FD9R6004/1C-3L Installation Instructions: [Wideband_Diplexer_Installation_Rev5.pdf](#)

Selection Guide Diplexer 698-960 / 1710-2200MHz					
	Model Number	Full DC Pass	DC Pass High Band	DC Pass Low Band	Mounting Hardware Included
Single	FD9R6004/1C-3L				X
	FD9R6004/2C-3L				X
	FD9R6004/3C-3L				X
Dual	KIT-FD9R6004/1C-DL				X
	KIT-FD9R6004/2C-DL				X
	KIT-FD9R6004/3C-DL				X

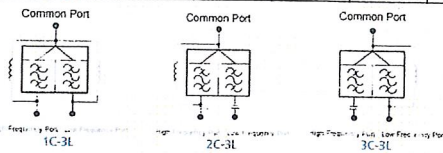

The FD9R6004 Series is upgradeable to a Dual Diplexer kit by means of 2 diplexers and mounting hardware kits SEM2-1A and SEM2-3

Mounting Hardware and Ground Cable Ordering Information		
Model Number	Description	
SEM2-1A	Mounting Hardware, Pole mount ø40-110mm (included with the Single and Dual Diplexer) Wall Screws M6 (Not included with the product)	
SEM2-3	Assembly kit for 2 pcs of FD9R6004/1C-3L (Can be ordered separately but included with the Dual Diplexer Kit)	
CA020-2	Ground Cable, 2m, includes lugs (Optional)	
CA030-2	Ground Cable, 2m, includes lugs (Optional)	
SEM6	Mounting Hardware for 6 Diplexers, Tower Base (Optional)	

All information contained in the present datasheet is subject to confirmation at time of ordering

Date: **September 26, 2011**

Veronica Harris
Crown Castle USA Inc.
1200 McArthur Blvd.
Mahwah, NJ 07430
(201) 236-9094



Tower Engineering Professionals, Inc.
3703 Junction Boulevard
Raleigh, NC 27603
(919) 661-6351
Crown@tepgroup.net

Subject: Structural Analysis Report

Carrier Designation:	Verizon Co-Locate	
	Carrier Site Number:	117993
	Carrier Site Name:	Coventry South
Crown Castle Designation:	Crown Castle BU Number:	876391
	Crown Castle Site Name:	Columbia / Deojay
	Crown Castle JDE Job Number:	166971
	Crown Castle Work Order Number:	438716
Engineering Firm Designation:	TEP Project Number:	113166
Site Data:	14 Thompson Hill Road, Tolland County, Columbia, CT 06237 Latitude 41° 43' 3.44", Longitude -72° 17' 59.09" 180 Foot – Monopole Tower	

Dear Ms. Harris,

Tower Engineering Professionals, Inc. is pleased to submit this "**Structural Analysis Report**" to determine the structural integrity of the above mentioned tower. This analysis has been performed in accordance with the terms of Crown Castle Purchase Order Number 432335, in accordance with application 131125, revision 1.

The purpose of the analysis is to determine acceptability of the tower stress level. Based on our analysis we have determined the tower stress level for the structure and foundation, under the following load case, to be:

LC1: Existing Structure w/ Existing + Reserved + Proposed

Note: See Table I and Table II for the proposed and existing/reserved loading, respectively.

Sufficient Capacity

The analysis has been performed in accordance with the TIA-222-F Structural Standard for Antenna Supporting Structures and Antennas – Addendum 2, ASCE7-05 Minimum Design Loads for Buildings and Other Structures, and the 2003 International Building Code (State Building Code, 2005 CT supplement) based upon a wind speed of 85 mph fastest mile.

All modifications and equipment proposed in this report shall be installed in accordance with the appurtenances listed in Tables 1 and 2 for the determined available structural capacity to be effective.

We at *Tower Engineering Professionals, Inc.* appreciate the opportunity of providing our continuing professional services to you and *Crown Castle USA, Inc.* If you have any questions or need further assistance on this or any other projects please give us a call.

Analysis prepared by: Matt Collins, P.E.

Respectfully submitted by:

Pete Jernigan, P.E.

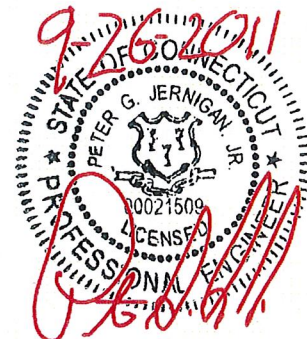

TABLE OF CONTENTS

1) INTRODUCTION

2) ANALYSIS CRITERIA

Table 1 – Proposed Antenna and Cable Information

Table 2 – Existing and Reserved Antenna and Cable Information

Table 3 – Design Antenna and Cable Information

3) ANALYSIS PROCEDURE

Table 4 – Documents Provided

3.1) Analysis Method

3.2) Assumptions

4) ANALYSIS RESULTS

Table 5 – Section Capacity (Summary)

Table 6 – Tower Component Stresses vs. Capacity – LC1

4.1) Recommendations

5) APPENDIX A

RISATower Output

6) APPENDIX B

Base Level Drawing

7) APPENDIX C

Additional Calculations

1) INTRODUCTION

This tower is a 180 ft monopole tower designed by Engineered Endeavors Inc. in December of 1999. The tower was originally designed for a wind speed of 90 mph basic wind speed, 78 mph with 1/2 inch radial ice and 50 mph service wind speed per TIA/EIA-222-F. TEP did not visit the site. All information provided was assumed to be accurate and complete.

2) ANALYSIS CRITERIA

The structural analysis was performed for this tower in accordance with the requirements of TIA/EIA-222-F Structural Standards for Steel Antenna Towers and Antenna Supporting Structures and the ASCE7-05 Minimum Design Loads for Buildings and Other Structures using a fastest mile wind speed of 85 mph with no ice, 38 mph with 1.0 inch ice (ice is considered to increase with height), and 50 mph under service loads.

Table 1 – Proposed Antenna and Cable Information

Mounting Level (ft)	Center Line Elevation (ft)	Number of Antennas	Antenna Manufacturer	Antenna Model	Number of Feed Lines	Feed Line Size (in)	Note
146	150	3	Antel	BXA-171085-8BF-EDIN-2 w/ Mount Pipe	-	-	1
		3	Antel	BXA-70063-6CF-2 w/ Mount Pipe			
		4	RFS Celwave	APL868013 w/ Mount Pipe			
		2	RFS Celwave	APL866513 w/ Mount Pipe			
		6	RFS Celwave	FD9R6004/1C-3L			

Notes:

- 1) Proposed equipment to reuse existing feed lines

Table 2 – Existing and Reserved Antenna and Cable Information

Mounting Level (ft)	Center Line Elevation (ft)	Number of Antennas	Antenna Manufacturer	Antenna Model	Number of Feed Lines	Feed Line Size (in)	Note
180	181	2	Decibel	950F65T2ZE-M w/ Mount Pipe	6	1-5/8	1
		4	Decibel	DB980H90E-M w/ Mount Pipe			
		9	MLA	MLA_ANTENNA w/ Mount Pipe			
	180	1	Tower Mounts	Platform Mount [LP 601-1]	-	-	1
169	170	12	Decibel	DB844H90E-XY w/ Mount Pipe	12	1-1/4	1
	169	1	Tower Mounts	Platform Mount [LP 303-1]			
161	162	3	EMS Wireless	RR90-17-02DP w/ Mount Pipe	6	1-5/8	1
	161	1	Tower Mounts	Platform Mount [LP 305-1]			

Mounting Level (ft)	Center Line Elevation (ft)	Number of Antennas	Antenna Manufacturer	Antenna Model	Number of Feed Lines	Feed Line Size (in)	Note
146	147	6	Decibel	DB844H80E-XY w/ Mount Pipe	-	-	3
		6	Decibel	DB948F85T2E-M w/ Mount Pipe	-	-	
140	150	1	Lucent	KS24019-L112A	1	1/2	1
	146	1	Tower Mounts	Platform Mount [LP 712-1]	12	1-5/8	
	140	6	Powerwave Technologies	7770.00 w/ Mount Pipe	12	1-5/8	1
		6	Powerwave Technologies	LGP 17201			
		6	Powerwave Technologies	LGP13519			
1	Tower Mounts	Platform Mount [LP 303-1]					
83	84	2	Kathrein	OG-860/1920/GPS-A	2	1/2	1
	83	2	Tower Mounts	Side Arm Mount [SO 702-1]			
78	79	1	Lucent	KS24019-L112A	1	1/2	1
	78	1	Tower Mounts	Side Arm Mount [SO 702-1]			

Notes:

- 1) Existing equipment
- 2) MLA equipment controlling, considered in this analysis
- 3) Existing equipment to be removed

Table 3 – Design Antenna and Cable Information

Mounting Level (ft)	Center Line Elevation (ft)	Number of Antennas	Antenna Manufacturer	Antenna Model	Number of Feed Lines	Feed Line Size (in)
180	180	12	Decibel	DB980	-	-
170	170	12	Decibel	DB980	-	-
160	160	12	Decibel	DB980	-	-
150	150	12	Decibel	DB980	-	-
140	140	12	Decibel	DB980	-	-
130	130	12	Decibel	DB980	-	-

3) ANALYSIS PROCEDURE

Table 4 – Documents Provided

Document	Remarks	Reference	Source
Geotechnical Report	Goodkind & O'dea, Inc. dated June 8, 1999	1613526	CCI
Tower Foundation Drawings	Engineered Endeavors Inc. dated December 22, 1999	1613632	CCI
Tower Manufacturer Drawings	Engineered Endeavors Inc. dated December 22, 1999	1614546	CCI
Previous Structural Analysis	Tower Engineering Professionals, Inc. Project No. 113166, dated September 7, 2011	-	TEP

3.1) Analysis Method

RISATower (version 5.4.2.0), a commercially available analysis software package, was used to create a three-dimensional model of the tower and calculate member stresses for various loading cases. Selected output from the analysis is included in Appendix A.

3.2) Assumptions

- 1) Tower and structures were built in accordance with the manufacturer's specifications.
- 2) The tower and structures have been maintained in accordance with the manufacturer's specification.
- 3) The configuration of antennas, transmission cables, mounts and other appurtenances are as specified in Tables 1 and 2.
- 4) When applicable, transmission cables are considered as structural components for calculating wind loads as allowed by the standard.
- 5) Serviceability with respect to antenna twist, tilt, roll, or lateral translation is not checked and is left to the carrier or tower owner to ensure conformance.

This analysis may be affected if any assumptions are not valid or have been made in error. *Tower Engineering Professionals, Inc.* should be notified to determine the effect on the structural integrity of the tower.

4) ANALYSIS RESULTS

Table 5 - Section Capacity (Summary)

Section No.	Elevation (ft)	Component Type	Size	Critical Element	P (K)	SF*P_allow (K)	% Capacity	Pass / Fail
L1	180 - 131.914	Pole	TP31.375x21x0.25	1	-10.17	1244.60	68.4	Pass
L2	131.914 - 86.8465	Pole	TP40.4688x29.9209x0.375	2	-18.76	2407.48	78.9	Pass
L3	86.8465 - 43.3231	Pole	TP48.9688x38.5321x0.4375	3	-30.59	3401.86	80.3	Pass
L4	43.3231 - 0	Pole	TP57.25x46.6859x0.5	4	-48.76	4682.07	76.3	Pass
							Summary	
						Pole (L3)	80.3	Pass
						Rating =	80.3	Pass

Table 6 - Tower Component Stresses vs. Capacity – LC1

Notes	Component	Elevation (ft)	% Capacity	Pass / Fail
1	Anchor Rods	0	75	Pass
1	Base Plate	0	88	Pass
1	Base Foundation	0	100	Pass

Structure Rating (max from all components) =	100%
---	-------------

Notes:

- 1) See additional documentation in "Appendix C – Additional Calculations" for calculations supporting the % capacity listed.

4.1) Recommendations

- 1) If the load differs from that described in Tables 1 and 2 of this report or the provisions of this analysis are found to be invalid, another structural analysis should be performed.
- 2) It should be noted that in order for the tower to pass for the current load scenario the proposed and reserved coax must be configured as shown in "Appendix B – Base Level Drawing".

APPENDIX A
RISATOWER OUTPUT

Section	1	2	3	4
Length (ft)	48.09	49.49	49.09	49.95
Number of Sides	18	18	18	18
Thickness (in)	0.2500	0.3750	0.4375	0.5000
Socket Length (ft)	4.42	5.57	6.62	
Top Dia (in)	21.0000	29.9209	38.5321	46.6859
Bot Dia (in)	31.3750	40.4688	48.9688	57.2500
Grade				A572-65
Weight (K)	3.4	7.0	10.0	13.9

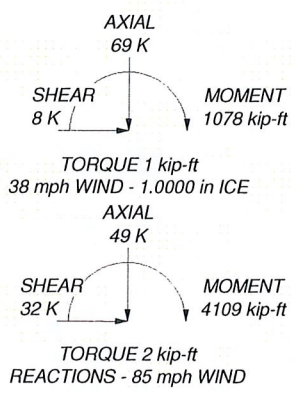
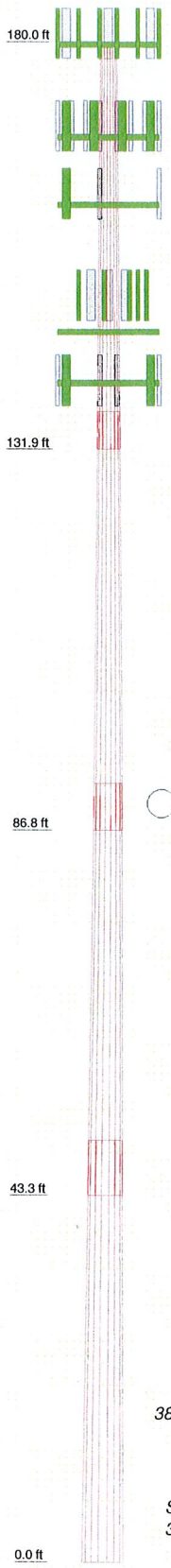

DESIGNED APPURTENANCE LOADING

TYPE	ELEVATION	TYPE	ELEVATION
(3) MLA_ANTENNA w/ Mount Pipe	180	BXA-171085-8BF-EDIN-2 w/ Mount Pipe	146
(3) MLA_ANTENNA w/ Mount Pipe	180	APL866513-42T0 w/ Mount Pipe	146
(3) MLA_ANTENNA w/ Mount Pipe	180	(2) FD9R6004/1C-3L	146
Platform Mount [LP 601-1]	180	(2) FD9R6004/1C-3L	146
2.4" x 5-ft Mount Pipe	180	(2) FD9R6004/1C-3L	146
2.4" x 5-ft Mount Pipe	180	(2) FD9R6004/1C-3L	146
2.4" x 5-ft Mount Pipe	180	KS24019-L112A	146
(4) DB844H90E-XY w/ Mount Pipe	169	Platform Mount [LP 712-1]	146
(4) DB844H90E-XY w/ Mount Pipe	169	(2) 7770.00 w/ Mount Pipe	140
(4) DB844H90E-XY w/ Mount Pipe	169	(2) LGP 17201	140
Platform Mount [LP 303-1]	169	(2) LGP13519	140
RR90-17-02DP w/ Mount Pipe	161	(2) 7770.00 w/ Mount Pipe	140
RR90-17-02DP w/ Mount Pipe	161	(2) LGP 17201	140
RR90-17-02DP w/ Mount Pipe	161	(2) LGP13519	140
Platform Mount [LP 305-1]	161	(2) 7770.00 w/ Mount Pipe	140
2.4" x 5-ft Mount Pipe	161	(2) LGP 17201	140
2.4" x 5-ft Mount Pipe	161	(2) LGP13519	140
2.4" x 5-ft Mount Pipe	161	Platform Mount [LP 303-1]	140
(2) APL868013 w/ Mount Pipe	146	OG-860/1920/GPS-A	83
(2) APL868013 w/ Mount Pipe	146	OG-860/1920/GPS-A	83
BXA-70063-6CF-2 w/ Mount Pipe	146	Side Arm Mount [SO 702-1]	83
BXA-70063-6CF-2 w/ Mount Pipe	146	Side Arm Mount [SO 702-1]	83
BXA-70063-6CF-2 w/ Mount Pipe	146	KS24019-L112A	78
BXA-171085-8BF-EDIN-2 w/ Mount Pipe	146	Side Arm Mount [SO 702-1]	78
BXA-171085-8BF-EDIN-2 w/ Mount Pipe	146		

MATERIAL STRENGTH

GRADE	Fy	Fu	GRADE	Fy	Fu
A572-65	65 ksi	80 ksi			

TOWER DESIGN NOTES

1. Tower is located in Tolland County, Connecticut.
2. Tower designed for a 85 mph basic wind in accordance with the TIA/EIA-222-F Standard.
3. Tower is also designed for a 38 mph basic wind with 1.00 in ice. Ice is considered to increase in thickness with height.
4. Deflections are based upon a 50 mph wind.
5. TOWER RATING: 80.3%

 <p>Tower Engineering Professionals</p>	<p>Tower Engineering Professionals</p> <p>3703 Junction Blvd. Raleigh, NC 27603 Phone: (919) 661-6351 FAX: (919) 661-6350</p>		<p>Job: BU# 876391</p> <p>Project: TEP# 113166</p>
	<p>Client: Crown Castle</p> <p>Code: TIA/EIA-222-F</p> <p>Path: <small>P:\113166_Columbia\Dejay\Structural\Re-Analysis_9-23-2011\RISA\876391.rvt</small></p>	<p>Drawn by: MWC</p> <p>Date: 09/26/11</p>	<p>App'd:</p> <p>Scale: NTS</p> <p>Dwg No. E-1</p>

RISATower Tower Engineering Professionals 3703 Junction Blvd. Raleigh, NC 27603 Phone: (919) 661-6351 FAX: (919) 661-6350	Job BU# 876391	Page 1 of 12
	Project TEP# 113166	Date 16:42:18 09/26/11
	Client Crown Castle	Designed by MWC

Tower Input Data

There is a pole section.

This tower is designed using the TIA/EIA-222-F standard.

The following design criteria apply:

Tower is located in Tolland County, Connecticut.

Basic wind speed of 85 mph.

Nominal ice thickness of 1.0000 in.

Ice thickness is considered to increase with height.

Ice density of 56 pcf.

A wind speed of 38 mph is used in combination with ice.

Temperature drop of 50 °F.

Deflections calculated using a wind speed of 50 mph.

A non-linear (P-delta) analysis was used.

Pressures are calculated at each section.

Stress ratio used in pole design is 1.333.

Local bending stresses due to climbing loads, feedline supports, and appurtenance mounts are not considered.

Options

<ul style="list-style-type: none"> Consider Moments - Legs Consider Moments - Horizontals Consider Moments - Diagonals Use Moment Magnification √ Use Code Stress Ratios √ Use Code Safety Factors - Guys √ Escalate Ice Always Use Max Kz Use Special Wind Profile Include Bolts In Member Capacity Leg Bolts Are At Top Of Section Secondary Horizontal Braces Leg Use Diamond Inner Bracing (4 Sided) Add IBC .6D+W Combination 	<ul style="list-style-type: none"> Distribute Leg Loads As Uniform Assume Legs Pinned √ Assume Rigid Index Plate √ Use Clear Spans For Wind Area Use Clear Spans For KL/r Retension Guys To Initial Tension √ Bypass Mast Stability Checks √ Use Azimuth Dish Coefficients √ Project Wind Area of Appurt. Autocalc Torque Arm Areas SR Members Have Cut Ends Sort Capacity Reports By Component Triangulate Diamond Inner Bracing 	<ul style="list-style-type: none"> Treat Feedline Bundles As Cylinder Use ASCE 10 X-Brace Ly Rules Calculate Redundant Bracing Forces Ignore Redundant Members in FEA SR Leg Bolts Resist Compression All Leg Panels Have Same Allowable Offset Girt At Foundation √ Consider Feedline Torque Include Angle Block Shear Check <li style="padding-left: 20px;">Poles √ Include Shear-Torsion Interaction Always Use Sub-Critical Flow Use Top Mounted Sockets
--	--	---

Tapered Pole Section Geometry

Section	Elevation ft	Section Length ft	Splice Length ft	Number of Sides	Top Diameter in	Bottom Diameter in	Wall Thickness in	Bend Radius in	Pole Grade
L1	180.00-131.91	48.09	4.42	18	21.0000	31.3750	0.2500	1.0000	A572-65 (65 ksi)
L2	131.91-86.85	49.49	5.57	18	29.9209	40.4688	0.3750	1.5000	A572-65 (65 ksi)
L3	86.85-43.32	49.09	6.62	18	38.5321	48.9688	0.4375	1.7500	A572-65 (65 ksi)
L4	43.32-0.00	49.95		18	46.6859	57.2500	0.5000	2.0000	A572-65 (65 ksi)

RISATower Tower Engineering Professionals 3703 Junction Blvd. Raleigh, NC 27603 Phone: (919) 661-6351 FAX: (919) 661-6350	Job BU# 876391	Page 2 of 12
	Project TEP# 113166	Date 16:42:18 09/26/11
	Client Crown Castle	Designed by MWC

Tapered Pole Properties

Section	Tip Dia. in	Area in ²	I in ⁴	r in	C in	I/C in ³	J in ⁴	I/Q in ²	w in	w/t
L1	21.3240	16.4651	895.6507	7.3663	10.6680	83.9568	1792.4800	8.2341	3.2560	13.024
L2	31.8590	24.6977	3022.8212	11.0494	15.9385	189.6553	6049.6199	12.3512	5.0820	20.328
	41.0930	47.7216	9691.8275	14.2333	20.5581	471.4354	19396.4077	23.8653	6.4625	17.233
L3	40.3285	52.8991	9698.6758	13.5236	19.5743	495.4800	19410.1134	26.4546	6.0116	13.741
	49.7242	67.3917	20053.3467	17.2286	24.8761	806.1282	40133.0801	33.7023	7.8485	17.939
L4	48.8284	73.2971	19753.4701	16.3960	23.7165	832.9016	39532.9323	36.6555	7.3367	14.673
	58.1332	90.0622	36644.7678	20.1462	29.0830	1260.0065	73337.7538	45.0397	9.1960	18.392

Tower Elevation	Gusset Area (per face)	Gusset Thickness	Gusset Grade	Adjust. Factor A _f	Adjust. Factor A _r	Weight Mult.	Double Angle Stitch Bolt Spacing Diagonals	Double Angle Stitch Bolt Spacing Horizontals
ft	ft ²	in					in	in
L1 180.00-131.91				1	1	1		
L2 131.91-86.85				1	1	1		
L3 86.85-43.32				1	1	1		
L4 43.32-0.00				1	1	1		

Feed Line/Linear Appurtenances - Entered As Area

Description	Face or Leg	Allow Shield	Component Type	Placement	Total Number	C _A A _A	Weight
				ft		ft ² /ft	plf
LDF7-50A(1-5/8")	A	No	Inside Pole	180.00 - 0.00	9	No Ice	0.82
						1/2" Ice	0.82
						1" Ice	0.82
						2" Ice	0.82
						4" Ice	0.82
LDF6-50A(1-1/4")	B	No	Inside Pole	169.00 - 0.00	12	No Ice	0.66
						1/2" Ice	0.66
						1" Ice	0.66
						2" Ice	0.66
						4" Ice	0.66
LDF7-50A(1-5/8")	B	No	Inside Pole	161.00 - 0.00	6	No Ice	0.82
						1/2" Ice	0.82
						1" Ice	0.82
						2" Ice	0.82
						4" Ice	0.82
LDF4-50A(1/2")	A	No	Inside Pole	146.00 - 0.00	1	No Ice	0.15
						1/2" Ice	0.15
						1" Ice	0.15
						2" Ice	0.15
						4" Ice	0.15
LDF7-50A(1-5/8")	A	No	Inside Pole	146.00 - 0.00	12	No Ice	0.82
						1/2" Ice	0.82
						1" Ice	0.82
						2" Ice	0.82
						4" Ice	0.82
LDF7-50A(1-5/8")	C	No	Inside Pole	140.00 - 0.00	12	No Ice	0.82
						1/2" Ice	0.82
						1" Ice	0.82
						2" Ice	0.82
						4" Ice	0.82

RISATower Tower Engineering Professionals 3703 Junction Blvd. Raleigh, NC 27603 Phone: (919) 661-6351 FAX: (919) 661-6350	Job BU# 876391	Page 3 of 12
	Project TEP# 113166	Date 16:42:18 09/26/11
	Client Crown Castle	Designed by MWC

Description	Face or Leg	Allow Shield	Component Type	Placement ft	Total Number	C _{AA}		Weight
						ft ² /ft	plf	
LDF4-50A(1/2")	B	No	CaAa (Out Of Face)	83.00 - 0.00	1	1/2" Ice	0.00	0.82
						1" Ice	0.00	0.82
						2" Ice	0.00	0.82
						4" Ice	0.00	0.82
						No Ice	0.06	0.15
						1/2" Ice	0.16	0.84
LDF4-50A(1/2")	B	No	CaAa (Out Of Face)	83.00 - 0.00	1	1" Ice	0.26	2.14
						2" Ice	0.46	6.58
						4" Ice	0.86	22.78
						No Ice	0.00	0.15
						1/2" Ice	0.00	0.84
						1" Ice	0.00	2.14
						2" Ice	0.00	6.58
						4" Ice	0.00	22.78

**

Feed Line/Linear Appurtenances Section Areas

Tower Section	Tower Elevation ft	Face	A _R	A _F	C _{AA} In Face	C _{AA} Out Face	Weight
			ft ²	ft ²	ft ²	ft ²	K
L1	180.00-131.91	A	0.000	0.000	0.000	0.000	0.50
		B	0.000	0.000	0.000	0.000	0.44
		C	0.000	0.000	0.000	0.000	0.08
L2	131.91-86.85	A	0.000	0.000	0.000	0.000	0.78
		B	0.000	0.000	0.000	0.000	0.58
		C	0.000	0.000	0.000	0.000	0.44
L3	86.85-43.32	A	0.000	0.000	0.000	0.000	0.76
		B	0.000	0.000	0.000	2.500	0.57
		C	0.000	0.000	0.000	0.000	0.43
L4	43.32-0.00	A	0.000	0.000	0.000	0.000	0.75
		B	0.000	0.000	0.000	2.729	0.57
		C	0.000	0.000	0.000	0.000	0.43

Feed Line/Linear Appurtenances Section Areas - With Ice

Tower Section	Tower Elevation ft	Face or Leg	Ice Thickness in	A _R	A _F	C _{AA} In Face	C _{AA} Out Face	Weight
				ft ²	ft ²	ft ²	ft ²	K
L1	180.00-131.91	A	1.204	0.000	0.000	0.000	0.000	0.50
		B		0.000	0.000	0.000	0.000	0.44
		C		0.000	0.000	0.000	0.000	0.08
L2	131.91-86.85	A	1.154	0.000	0.000	0.000	0.000	0.78
		B		0.000	0.000	0.000	0.000	0.58
		C		0.000	0.000	0.000	0.000	0.44
L3	86.85-43.32	A	1.084	0.000	0.000	0.000	0.000	0.76
		B		0.000	0.000	0.000	11.656	0.78
		C		0.000	0.000	0.000	0.000	0.43
L4	43.32-0.00	A	1.000	0.000	0.000	0.000	0.000	0.75
		B		0.000	0.000	0.000	12.126	0.77
		C		0.000	0.000	0.000	0.000	0.43

RISATower Tower Engineering Professionals 3703 Junction Blvd. Raleigh, NC 27603 Phone: (919) 661-6351 FAX: (919) 661-6350	Job BU# 876391	Page 4 of 12
	Project TEP# 113166	Date 16:42:18 09/26/11
	Client Crown Castle	Designed by MWC

Feed Line Center of Pressure

Section	Elevation	CP _x	CP _z	CP _x	CP _z
	ft	in	in	Ice in	Ice in
L1	180.00-131.91	0.0000	0.0000	0.0000	0.0000
L2	131.91-86.85	0.0000	0.0000	0.0000	0.0000
L3	86.85-43.32	0.0741	0.0428	0.3122	0.1803
L4	43.32-0.00	0.0807	0.0466	0.3291	0.1900

Discrete Tower Loads

Description	Face or Leg	Offset Type	Offsets: Horz Lateral Vert ft ft ft	Azimuth Adjustment °	Placement ft	C _{AA} Front ft ²	C _{AA} Side ft ²	Weight K	
(3) MLA_ANTENNA w/ Mount Pipe	A	From Centroid- Leg	4.00 0.00 1.00	0.0000	180.00	No Ice	8.64	6.95	0.07
						1/2" Ice	9.29	8.13	0.13
						1" Ice	9.91	9.02	0.21
						2" Ice	11.18	10.84	0.39
						4" Ice	13.83	14.85	0.90
(3) MLA_ANTENNA w/ Mount Pipe	B	From Centroid- Leg	4.00 0.00 1.00	0.0000	180.00	No Ice	8.64	6.95	0.07
						1/2" Ice	9.29	8.13	0.13
						1" Ice	9.91	9.02	0.21
						2" Ice	11.18	10.84	0.39
						4" Ice	13.83	14.85	0.90
(3) MLA_ANTENNA w/ Mount Pipe	C	From Centroid- Leg	4.00 0.00 1.00	0.0000	180.00	No Ice	8.64	6.95	0.07
						1/2" Ice	9.29	8.13	0.13
						1" Ice	9.91	9.02	0.21
						2" Ice	11.18	10.84	0.39
						4" Ice	13.83	14.85	0.90
Platform Mount [LP 601-1]	C	None		0.0000	180.00	No Ice	28.47	28.47	1.12
						1/2" Ice	33.59	33.59	1.51
						1" Ice	38.71	38.71	1.91
						2" Ice	48.95	48.95	2.69
						4" Ice	69.43	69.43	4.26
2.4" x 5-ft Mount Pipe	A	From Centroid- Leg	4.00 0.00 1.00	0.0000	180.00	No Ice	1.20	1.20	0.00
						1/2" Ice	1.50	1.50	0.01
						1" Ice	1.81	1.81	0.03
						2" Ice	2.47	2.47	0.06
						4" Ice	3.93	3.93	0.18
2.4" x 5-ft Mount Pipe	B	From Centroid- Leg	4.00 0.00 1.00	0.0000	180.00	No Ice	1.20	1.20	0.00
						1/2" Ice	1.50	1.50	0.01
						1" Ice	1.81	1.81	0.03
						2" Ice	2.47	2.47	0.06
						4" Ice	3.93	3.93	0.18
2.4" x 5-ft Mount Pipe	C	From Centroid- Leg	4.00 0.00 1.00	0.0000	180.00	No Ice	1.20	1.20	0.00
						1/2" Ice	1.50	1.50	0.01
						1" Ice	1.81	1.81	0.03
						2" Ice	2.47	2.47	0.06
						4" Ice	3.93	3.93	0.18

(4) DB844H90E-XY w/ Mount Pipe	A	From Centroid- Face	4.00 0.00 1.00	-15.0000	169.00	No Ice	3.30	4.92	0.03
						1/2" Ice	3.69	5.60	0.07
						1" Ice	4.12	6.28	0.12

RISATower Tower Engineering Professionals 3703 Junction Blvd. Raleigh, NC 27603 Phone: (919) 661-6351 FAX: (919) 661-6350	Job	BU# 876391	Page	5 of 12
	Project	TEP# 113166	Date	16:42:18 09/26/11
	Client	Crown Castle	Designed by	MWC

Description	Face or Leg	Offset Type	Offsets: Horz Lateral Vert ft ft ft	Azimuth Adjustment °	Placement ft	C _{AA} Front ft ²	C _{AA} Side ft ²	Weight K	
(4) DB844H90E-XY w/ Mount Pipe	B	From Centroid-Face	4.00 0.00 1.00	-15.0000	169.00	2" Ice	5.01	7.71	0.23
						4" Ice	6.92	10.83	0.56
						No Ice	3.30	4.92	0.03
						1/2" Ice	3.69	5.60	0.07
						1" Ice	4.12	6.28	0.12
(4) DB844H90E-XY w/ Mount Pipe	C	From Centroid-Face	4.00 0.00 1.00	-15.0000	169.00	2" Ice	5.01	7.71	0.23
						4" Ice	6.92	10.83	0.56
						No Ice	3.30	4.92	0.03
						1/2" Ice	3.69	5.60	0.07
						1" Ice	4.12	6.28	0.12
Platform Mount [LP 303-1]	C	None		0.0000	169.00	2" Ice	5.01	7.71	0.23
						4" Ice	6.92	10.83	0.56
						No Ice	14.66	14.66	1.25
						1/2" Ice	18.87	18.87	1.48
						1" Ice	23.08	23.08	1.71
RR90-17-02DP w/ Mount Pipe	A	From Centroid-Face	4.00 5.00 1.00	-5.0000	161.00	2" Ice	31.50	31.50	2.18
						4" Ice	48.34	48.34	3.10
						No Ice	4.59	3.32	0.03
						1/2" Ice	5.09	4.09	0.07
						1" Ice	5.58	4.78	0.11
RR90-17-02DP w/ Mount Pipe	B	From Centroid-Face	4.00 5.00 1.00	-5.0000	161.00	2" Ice	6.59	6.23	0.22
						4" Ice	8.73	9.31	0.56
						No Ice	4.59	3.32	0.03
						1/2" Ice	5.09	4.09	0.07
						1" Ice	5.58	4.78	0.11
RR90-17-02DP w/ Mount Pipe	C	From Centroid-Face	4.00 5.00 1.00	-5.0000	161.00	2" Ice	6.59	6.23	0.22
						4" Ice	8.73	9.31	0.56
						No Ice	4.59	3.32	0.03
						1/2" Ice	5.09	4.09	0.07
						1" Ice	5.58	4.78	0.11
Platform Mount [LP 305-1]	C	None		0.0000	161.00	2" Ice	6.59	6.23	0.22
						4" Ice	8.73	9.31	0.56
						No Ice	18.01	18.01	1.12
						1/2" Ice	23.33	23.33	1.35
						1" Ice	28.65	28.65	1.58
2.4" x 5-ft Mount Pipe	A	From Centroid-Leg	4.00 -5.00 0.00	-5.0000	161.00	2" Ice	39.29	39.29	2.05
						4" Ice	60.57	60.57	2.97
						No Ice	1.20	1.20	0.00
						1/2" Ice	1.50	1.50	0.01
						1" Ice	1.81	1.81	0.03
2.4" x 5-ft Mount Pipe	B	From Centroid-Leg	4.00 -5.00 0.00	-5.0000	161.00	2" Ice	2.47	2.47	0.06
						4" Ice	3.93	3.93	0.18
						No Ice	1.20	1.20	0.00
						1/2" Ice	1.50	1.50	0.01
						1" Ice	1.81	1.81	0.03
2.4" x 5-ft Mount Pipe	C	From Centroid-Leg	4.00 -5.00 0.00	-5.0000	161.00	2" Ice	2.47	2.47	0.06
						4" Ice	3.93	3.93	0.18
						No Ice	1.20	1.20	0.00
						1/2" Ice	1.50	1.50	0.01
						1" Ice	1.81	1.81	0.03
(2) APL868013 w/ Mount Pipe	A	From Centroid-Leg	4.00 0.00 4.00	30.0000	146.00	2" Ice	2.47	2.47	0.06
						4" Ice	3.93	3.93	0.18
						No Ice	3.10	4.92	0.02
						1/2" Ice	3.48	5.60	0.06
						1" Ice	3.88	6.28	0.11

RISATower Tower Engineering Professionals 3703 Junction Blvd. Raleigh, NC 27603 Phone: (919) 661-6351 FAX: (919) 661-6350	Job		BU# 876391		Page		6 of 12	
	Project		TEP# 113166		Date		16:42:18 09/26/11	
	Client		Crown Castle		Designed by		MWC	

Description	Face or Leg	Offset Type	Offsets:		Azimuth Adjustment	Placement	C _{AA} Front	C _{AA} Side	Weight	
			Horz	Vert						
			ft	ft	°	ft	ft ²	ft ²	K	
							2" Ice	4.76	7.71	0.22
							4" Ice	6.66	10.83	0.54
(2) APL868013 w/ Mount Pipe	B	From Centroid-Leg	4.00	0.00	30.0000	146.00	No Ice	3.10	4.92	0.02
			4.00				1/2" Ice	3.48	5.60	0.06
							1" Ice	3.88	6.28	0.11
							2" Ice	4.76	7.71	0.22
							4" Ice	6.66	10.83	0.54
BXA-70063-6CF-2 w/ Mount Pipe	A	From Centroid-Leg	4.00	-2.00	30.0000	146.00	No Ice	7.97	5.80	0.04
			4.00				1/2" Ice	8.61	6.95	0.10
							1" Ice	9.22	7.82	0.17
							2" Ice	10.46	9.60	0.34
							4" Ice	13.07	13.37	0.80
BXA-70063-6CF-2 w/ Mount Pipe	B	From Centroid-Leg	4.00	-2.00	30.0000	146.00	No Ice	7.97	5.80	0.04
			4.00				1/2" Ice	8.61	6.95	0.10
							1" Ice	9.22	7.82	0.17
							2" Ice	10.46	9.60	0.34
							4" Ice	13.07	13.37	0.80
BXA-70063-6CF-2 w/ Mount Pipe	C	From Centroid-Leg	4.00	-6.00	30.0000	146.00	No Ice	7.97	5.80	0.04
			4.00				1/2" Ice	8.61	6.95	0.10
							1" Ice	9.22	7.82	0.17
							2" Ice	10.46	9.60	0.34
							4" Ice	13.07	13.37	0.80
BXA-171085-8BF-EDIN-2 w/ Mount Pipe	A	From Centroid-Leg	4.00	2.00	30.0000	146.00	No Ice	3.18	3.35	0.03
			4.00				1/2" Ice	3.56	3.97	0.06
							1" Ice	3.96	4.60	0.10
							2" Ice	4.85	5.89	0.19
							4" Ice	6.77	8.89	0.49
BXA-171085-8BF-EDIN-2 w/ Mount Pipe	B	From Centroid-Leg	4.00	2.00	30.0000	146.00	No Ice	3.18	3.35	0.03
			4.00				1/2" Ice	3.56	3.97	0.06
							1" Ice	3.96	4.60	0.10
							2" Ice	4.85	5.89	0.19
							4" Ice	6.77	8.89	0.49
BXA-171085-8BF-EDIN-2 w/ Mount Pipe	C	From Centroid-Leg	4.00	0.00	30.0000	146.00	No Ice	3.18	3.35	0.03
			4.00				1/2" Ice	3.56	3.97	0.06
							1" Ice	3.96	4.60	0.10
							2" Ice	4.85	5.89	0.19
							4" Ice	6.77	8.89	0.49
APL866513-42T0 w/ Mount Pipe	C	From Centroid-Leg	4.00	0.00	30.0000	146.00	No Ice	4.53	4.92	0.03
			4.00				1/2" Ice	4.97	5.60	0.08
							1" Ice	5.41	6.28	0.13
							2" Ice	6.34	7.71	0.25
							4" Ice	8.32	10.83	0.60
(2) FD9R6004/1C-3L	A	From Centroid-Leg	4.00	0.00	30.0000	146.00	No Ice	0.37	0.08	0.00
			4.00				1/2" Ice	0.45	0.14	0.01
							1" Ice	0.54	0.20	0.01
							2" Ice	0.75	0.34	0.02
							4" Ice	1.28	0.74	0.06
(2) FD9R6004/1C-3L	B	From Centroid-Leg	4.00	0.00	30.0000	146.00	No Ice	0.37	0.08	0.00
			4.00				1/2" Ice	0.45	0.14	0.01
							1" Ice	0.54	0.20	0.01
							2" Ice	0.75	0.34	0.02
							4" Ice	1.28	0.74	0.06
(2) FD9R6004/1C-3L	C	From Centroid-Leg	4.00	0.00	30.0000	146.00	No Ice	0.37	0.08	0.00
			4.00				1/2" Ice	0.45	0.14	0.01
							1" Ice	0.54	0.20	0.01
							2" Ice	0.75	0.34	0.02
							4" Ice	1.28	0.74	0.06

RISA Tower Tower Engineering Professionals 3703 Junction Blvd. Raleigh, NC 27603 Phone: (919) 661-6351 FAX: (919) 661-6350	Job		BU# 876391		Page		7 of 12	
	Project		TEP# 113166		Date		16:42:18 09/26/11	
	Client		Crown Castle		Designed by		MWC	

Description	Face or Leg	Offset Type	Offsets:		Azimuth Adjustment	Placement	C _A A _A		Weight	
			Horz	Lateral			Front	Side		
			ft	ft	°	ft	ft ²	ft ²	K	
KS24019-L112A	C	From Centroid-Leg	4.00		0.0000	146.00	No Ice	0.09	0.09	0.01
			6.00				1/2" Ice	0.15	0.15	0.01
			4.00				1" Ice	0.22	0.22	0.01
							2" Ice	0.40	0.40	0.02
							4" Ice	0.89	0.89	0.04
Platform Mount [LP 712-1]	C	None			0.0000	146.00	No Ice	24.53	24.53	1.34
							1/2" Ice	29.94	29.94	1.65
							1" Ice	35.35	35.35	1.96
							2" Ice	46.17	46.17	2.58
							4" Ice	67.81	67.81	3.82

(2) 7770.00 w/ Mount Pipe	A	From Centroid-Face	4.00		10.0000	140.00	No Ice	6.12	4.25	0.06
			0.00				1/2" Ice	6.63	5.01	0.10
			0.00				1" Ice	7.13	5.71	0.16
							2" Ice	8.16	7.16	0.29
							4" Ice	10.36	10.41	0.66
(2) LGP 17201	A	From Centroid-Face	4.00		10.0000	140.00	No Ice	1.95	0.52	0.03
			-6.00				1/2" Ice	2.13	0.64	0.04
			0.00				1" Ice	2.33	0.77	0.06
							2" Ice	2.75	1.06	0.09
							4" Ice	3.69	1.73	0.19
(2) LGP13519	A	From Centroid-Face	4.00		10.0000	140.00	No Ice	0.34	0.21	0.01
			6.00				1/2" Ice	0.42	0.28	0.01
			0.00				1" Ice	0.51	0.36	0.01
							2" Ice	0.73	0.55	0.02
							4" Ice	1.25	1.03	0.07
(2) 7770.00 w/ Mount Pipe	B	From Centroid-Face	4.00		20.0000	140.00	No Ice	6.12	4.25	0.06
			0.00				1/2" Ice	6.63	5.01	0.10
			0.00				1" Ice	7.13	5.71	0.16
							2" Ice	8.16	7.16	0.29
							4" Ice	10.36	10.41	0.66
(2) LGP 17201	B	From Centroid-Face	4.00		20.0000	140.00	No Ice	1.95	0.52	0.03
			-6.00				1/2" Ice	2.13	0.64	0.04
			0.00				1" Ice	2.33	0.77	0.06
							2" Ice	2.75	1.06	0.09
							4" Ice	3.69	1.73	0.19
(2) LGP13519	B	From Centroid-Face	4.00		20.0000	140.00	No Ice	0.34	0.21	0.01
			6.00				1/2" Ice	0.42	0.28	0.01
			0.00				1" Ice	0.51	0.36	0.01
							2" Ice	0.73	0.55	0.02
							4" Ice	1.25	1.03	0.07
(2) 7770.00 w/ Mount Pipe	C	From Centroid-Face	4.00		10.0000	140.00	No Ice	6.12	4.25	0.06
			0.00				1/2" Ice	6.63	5.01	0.10
			0.00				1" Ice	7.13	5.71	0.16
							2" Ice	8.16	7.16	0.29
							4" Ice	10.36	10.41	0.66
(2) LGP 17201	C	From Centroid-Face	4.00		10.0000	140.00	No Ice	1.95	0.52	0.03
			-6.00				1/2" Ice	2.13	0.64	0.04
			0.00				1" Ice	2.33	0.77	0.06
							2" Ice	2.75	1.06	0.09
							4" Ice	3.69	1.73	0.19
(2) LGP13519	C	From Centroid-Face	4.00		10.0000	140.00	No Ice	0.34	0.21	0.01
			6.00				1/2" Ice	0.42	0.28	0.01
			0.00				1" Ice	0.51	0.36	0.01
							2" Ice	0.73	0.55	0.02
							4" Ice	1.25	1.03	0.07
Platform Mount [LP 303-1]	C	None			0.0000	140.00	No Ice	14.66	14.66	1.25

RISATower Tower Engineering Professionals 3703 Junction Blvd. Raleigh, NC 27603 Phone: (919) 661-6351 FAX: (919) 661-6350	Job	BU# 876391	Page	8 of 12
	Project	TEP# 113166	Date	16:42:18 09/26/11
	Client	Crown Castle	Designed by	MWC

Description	Face or Leg	Offset Type	Offsets: Horz Lateral Vert	Azimuth Adjustment	Placement	C _{AA} Front	C _{AA} Side	Weight	
			ft	°	ft	ft ²	ft ²	K	
						1/2" Ice	18.87	18.87	1.48
						1" Ice	23.08	23.08	1.71
						2" Ice	31.50	31.50	2.18
						4" Ice	48.34	48.34	3.10

OG-860/1920/GPS-A	A	From Leg	4.00	30.0000	83.00	No Ice	0.14	0.14	0.00
			0.00			1/2" Ice	0.23	0.23	0.00
			1.00			1" Ice	0.33	0.33	0.01
						2" Ice	0.57	0.57	0.02
						4" Ice	1.17	1.17	0.05
OG-860/1920/GPS-A	B	From Leg	4.00	30.0000	83.00	No Ice	0.14	0.14	0.00
			0.00			1/2" Ice	0.23	0.23	0.00
			1.00			1" Ice	0.33	0.33	0.01
						2" Ice	0.57	0.57	0.02
						4" Ice	1.17	1.17	0.05
Side Arm Mount [SO 702-1]	A	From Leg	2.00	30.0000	83.00	No Ice	1.00	1.43	0.03
			0.00			1/2" Ice	1.00	2.05	0.04
			0.00			1" Ice	1.00	2.67	0.05
						2" Ice	1.00	3.91	0.07
						4" Ice	1.00	6.39	0.12
Side Arm Mount [SO 702-1]	B	From Leg	2.00	30.0000	83.00	No Ice	1.00	1.43	0.03
			0.00			1/2" Ice	1.00	2.05	0.04
			0.00			1" Ice	1.00	2.67	0.05
						2" Ice	1.00	3.91	0.07
						4" Ice	1.00	6.39	0.12

KS24019-L112A	B	From Leg	4.00	10.0000	78.00	No Ice	0.09	0.09	0.01
			0.00			1/2" Ice	0.15	0.15	0.01
			1.00			1" Ice	0.22	0.22	0.01
						2" Ice	0.40	0.40	0.02
						4" Ice	0.89	0.89	0.04
Side Arm Mount [SO 702-1]	B	From Leg	2.00	10.0000	78.00	No Ice	1.00	1.43	0.03
			0.00			1/2" Ice	1.00	2.05	0.04
			0.00			1" Ice	1.00	2.67	0.05
						2" Ice	1.00	3.91	0.07
						4" Ice	1.00	6.39	0.12

Load Combinations

Comb. No.	Description
1	Dead Only
2	Dead+Wind 0 deg - No Ice
3	Dead+Wind 30 deg - No Ice
4	Dead+Wind 60 deg - No Ice
5	Dead+Wind 90 deg - No Ice
6	Dead+Wind 120 deg - No Ice
7	Dead+Wind 150 deg - No Ice
8	Dead+Wind 180 deg - No Ice
9	Dead+Wind 210 deg - No Ice
10	Dead+Wind 240 deg - No Ice

RISATower Tower Engineering Professionals 3703 Junction Blvd. Raleigh, NC 27603 Phone: (919) 661-6351 FAX: (919) 661-6350	Job BU# 876391	Page 9 of 12
	Project TEP# 113166	Date 16:42:18 09/26/11
	Client Crown Castle	Designed by MWC

Comb. No.	Description
11	Dead+Wind 270 deg - No Ice
12	Dead+Wind 300 deg - No Ice
13	Dead+Wind 330 deg - No Ice
14	Dead+Ice+Temp
15	Dead+Wind 0 deg+Ice+Temp
16	Dead+Wind 30 deg+Ice+Temp
17	Dead+Wind 60 deg+Ice+Temp
18	Dead+Wind 90 deg+Ice+Temp
19	Dead+Wind 120 deg+Ice+Temp
20	Dead+Wind 150 deg+Ice+Temp
21	Dead+Wind 180 deg+Ice+Temp
22	Dead+Wind 210 deg+Ice+Temp
23	Dead+Wind 240 deg+Ice+Temp
24	Dead+Wind 270 deg+Ice+Temp
25	Dead+Wind 300 deg+Ice+Temp
26	Dead+Wind 330 deg+Ice+Temp
27	Dead+Wind 0 deg - Service
28	Dead+Wind 30 deg - Service
29	Dead+Wind 60 deg - Service
30	Dead+Wind 90 deg - Service
31	Dead+Wind 120 deg - Service
32	Dead+Wind 150 deg - Service
33	Dead+Wind 180 deg - Service
34	Dead+Wind 210 deg - Service
35	Dead+Wind 240 deg - Service
36	Dead+Wind 270 deg - Service
37	Dead+Wind 300 deg - Service
38	Dead+Wind 330 deg - Service

Maximum Tower Deflections - Service Wind

Section No.	Elevation ft	Horz. Deflection in	Gov. Load Comb.	Tilt °	Twist °
L1	180 - 131.914	43.882	30	2.2662	0.0042
L2	136.336 - 86.8465	24.602	30	1.8183	0.0032
L3	92.4142 - 43.3231	10.750	30	1.1477	0.0014
L4	49.9451 - 0	3.034	30	0.5608	0.0005

Critical Deflections and Radius of Curvature - Service Wind

Elevation ft	Appurtenance	Gov. Load Comb.	Deflection in	Tilt °	Twist °	Radius of Curvature ft
180.00	(3) MLA_ANTENNA w/ Mount Pipe	30	43.882	2.2662	0.0042	29282
169.00	(4) DB844H90E-XY w/ Mount Pipe	30	38.756	2.1678	0.0041	13309
161.00	RR90-17-02DP w/ Mount Pipe	30	35.090	2.0929	0.0039	7705
146.00	(2) APL868013 w/ Mount Pipe	30	28.519	1.9362	0.0035	4304
140.00	(2) 7770.00 w/ Mount Pipe	30	26.052	1.8649	0.0033	3660
83.00	OG-860/1920/GPS-A	30	8.563	1.0058	0.0011	3998
78.00	KS24019-L112A	30	7.509	0.9333	0.0010	3948

RISATower Tower Engineering Professionals 3703 Junction Blvd. Raleigh, NC 27603 Phone: (919) 661-6351 FAX: (919) 661-6350	Job BU# 876391	Page 10 of 12
	Project TEP# 113166	Date 16:42:18 09/26/11
	Client Crown Castle	Designed by MWC

Maximum Tower Deflections - Design Wind

Section No.	Elevation ft	Horz. Deflection in	Gov. Load Comb.	Tilt °	Twist °
L1	180 - 131.914	126.307	5	6.5261	0.0123
L2	136.336 - 86.8465	70.871	5	5.2385	0.0092
L3	92.4142 - 43.3231	30.989	5	3.3084	0.0040
L4	49.9451 - 0	8.750	5	1.6174	0.0015

Critical Deflections and Radius of Curvature - Design Wind

Elevation ft	Appurtenance	Gov. Load Comb.	Deflection in	Tilt °	Twist °	Radius of Curvature ft
180.00	(3) MLA_ANTENNA w/ Mount Pipe	5	126.307	6.5261	0.0123	10395
169.00	(4) DB844H90E-XY w/ Mount Pipe	5	111.572	6.2433	0.0117	4723
161.00	RR90-17-02DP w/ Mount Pipe	5	101.034	6.0280	0.0112	2732
146.00	(2) APL868013 w/ Mount Pipe	5	82.140	5.5775	0.0101	1523
140.00	(2) 7770.00 w/ Mount Pipe	5	75.042	5.3725	0.0096	1294
83.00	OG-860/1920/GPS-A	5	24.688	2.8998	0.0032	1394
78.00	KS24019-L112A	5	21.651	2.6910	0.0028	1376

Compression Checks

Pole Design Data

Section No.	Elevation ft	Size	L ft	L _n ft	Kl/r	F _a ksi	A in ²	Actual P K	Allow. P _a K	Ratio $\frac{P}{P_a}$
L1	180 - 131.914 (1)	TP31.375x21x0.25	48.09	0.00	0.0	39.000	23.9406	-10.17	933.68	0.011
L2	131.914 - 86.8465 (2)	TP40.4688x29.9209x0.375	49.49	0.00	0.0	39.000	46.3092	-18.76	1806.06	0.010
L3	86.8465 - 43.3231 (3)	TP48.9688x38.5321x0.4375	49.09	0.00	0.0	39.000	65.4368	-30.59	2552.03	0.012
L4	43.3231 - 0 (4)	TP57.25x46.6859x0.5	49.95	0.00	0.0	39.000	90.0622	-48.76	3512.43	0.014

Pole Bending Design Data

Section No.	Elevation ft	Size	Actual M _x kip-ft	Actual f _{bx} ksi	Allow. F _{bx} ksi	Ratio $\frac{f_{bx}}{F_{bx}}$	Actual M _y kip-ft	Actual f _{by} ksi	Allow. F _{by} ksi	Ratio $\frac{f_{by}}{F_{by}}$
L1	180 - 131.914 (1)	TP31.375x21x0.25	520.99	35.091	39.000	0.900	0.00	0.000	39.000	0.000
L2	131.914 -	TP40.4688x29.9209x0.375	1500.84	40.580	39.000	1.041	0.00	0.000	39.000	0.000

RISATower Tower Engineering Professionals 3703 Junction Blvd. Raleigh, NC 27603 Phone: (919) 661-6351 FAX: (919) 661-6350	Job BU# 876391	Page 11 of 12
	Project TEP# 113166	Date 16:42:18 09/26/11
	Client Crown Castle	Designed by MWC

Section No.	Elevation ft	Size	Actual M_x kip-ft	Actual f_{bx} ksi	Allow. F_{bx} ksi	Ratio $\frac{f_{bx}}{F_{bx}}$	Actual M_y kip-ft	Actual f_{by} ksi	Allow. F_{by} ksi	Ratio $\frac{f_{by}}{F_{by}}$
L3	86.8465 (2) 86.8465 - 43.3231 (3)	TP48.9688x38.5321x0.4375	2614.08	41.284	39.000	1.059	0.00	0.000	39.000	0.000
L4	43.3231 - 0 (4)	TP57.25x46.6859x0.5	4109.43	39.137	39.000	1.004	0.00	0.000	39.000	0.000

Pole Shear Design Data

Section No.	Elevation ft	Size	Actual V K	Actual f_v ksi	Allow. F_v ksi	Ratio $\frac{f_v}{F_v}$	Actual T kip-ft	Actual f_{vt} ksi	Allow. F_{vt} ksi	Ratio $\frac{f_{vt}}{F_{vt}}$
L1	180 - 131.914 (1)	TP31.375x21x0.25	20.42	0.853	26.000	0.066	1.19	0.039	26.000	0.001
L2	131.914 - 86.8465 (2)	TP40.4688x29.9209x0.375	24.20	0.523	26.000	0.040	1.18	0.016	26.000	0.001
L3	86.8465 - 43.3231 (3)	TP48.9688x38.5321x0.4375	28.04	0.428	26.000	0.033	1.22	0.009	26.000	0.000
L4	43.3231 - 0 (4)	TP57.25x46.6859x0.5	31.75	0.353	26.000	0.027	1.24	0.006	26.000	0.000

Pole Interaction Design Data

Section No.	Elevation ft	Ratio P	Ratio f_{bx}	Ratio f_{by}	Ratio f_v	Ratio f_{vt}	Comb. Stress Ratio	Allow. Stress Ratio	Criteria
		P_a	F_{bx}	F_{by}	F_v	F_{vt}			
L1	180 - 131.914 (1)	0.011	0.900	0.000	0.066	0.001	0.912 ✓	1.333	H1-3+VT ✓
L2	131.914 - 86.8465 (2)	0.010	1.041	0.000	0.040	0.001	1.051 ✓	1.333	H1-3+VT ✓
L3	86.8465 - 43.3231 (3)	0.012	1.059	0.000	0.033	0.000	1.071 ✓	1.333	H1-3+VT ✓
L4	43.3231 - 0 (4)	0.014	1.004	0.000	0.027	0.000	1.018 ✓	1.333	H1-3+VT ✓

Section Capacity Table

Section No.	Elevation ft	Component Type	Size	Critical Element	P K	$SF * P_{allow}$ K	% Capacity	Pass Fail	
L1	180 - 131.914	Pole	TP31.375x21x0.25	1	-10.17	1244.60	68.4	Pass	
L2	131.914 - 86.8465	Pole	TP40.4688x29.9209x0.375	2	-18.76	2407.48	78.9	Pass	
L3	86.8465 - 43.3231	Pole	TP48.9688x38.5321x0.4375	3	-30.59	3401.86	80.3	Pass	
L4	43.3231 - 0	Pole	TP57.25x46.6859x0.5	4	-48.76	4682.07	76.3	Pass	
							Summary		
							Pole (L3)	80.3	Pass
							RATING =	80.3	Pass

<i>RISATower</i> <i>Tower Engineering Professionals</i> <i>3703 Junction Blvd. Raleigh, NC 27603 Phone: (919) 661-6351 FAX: (919) 661-6350</i>	Job BU# 876391	Page 12 of 12
	Project TEP# 113166	Date 16:42:18 09/26/11
	Client Crown Castle	Designed by MWC

Program Version 5.4.2.0 - 6/17/2010 File:P:/3166_Columbia Deojay/Structural/Re-Analysis 9-23-2011/RISA/876391.eri

APPENDIX B
BASE LEVEL DRAWING



(MLA)
(3) 1-5/8" TO 180 FT LEVEL
(INSTALLED)
(1) 1/2" TO 78 FT LEVEL
(INSTALLED)
(6) 1-5/8" TO 180 FT LEVEL

(NOT INSTALLED)
(6) 1-5/8" TO 161 FT LEVEL
(INSTALLED)
(6) 1-5/8" TO 161 FT LEVEL

(INSTALLED)
(1) 1/2" TO 146 FT LEVEL
(12) 1-5/8" TO 146 FT LEVEL

(INSTALLED)
(2) 1/2" TO 83 FT LEVEL
(INSTALLED)
(12) 1-1/4" TO 169 FT LEVEL

(INSTALLED)
(12) 1-5/8" TO 140 FT LEVEL

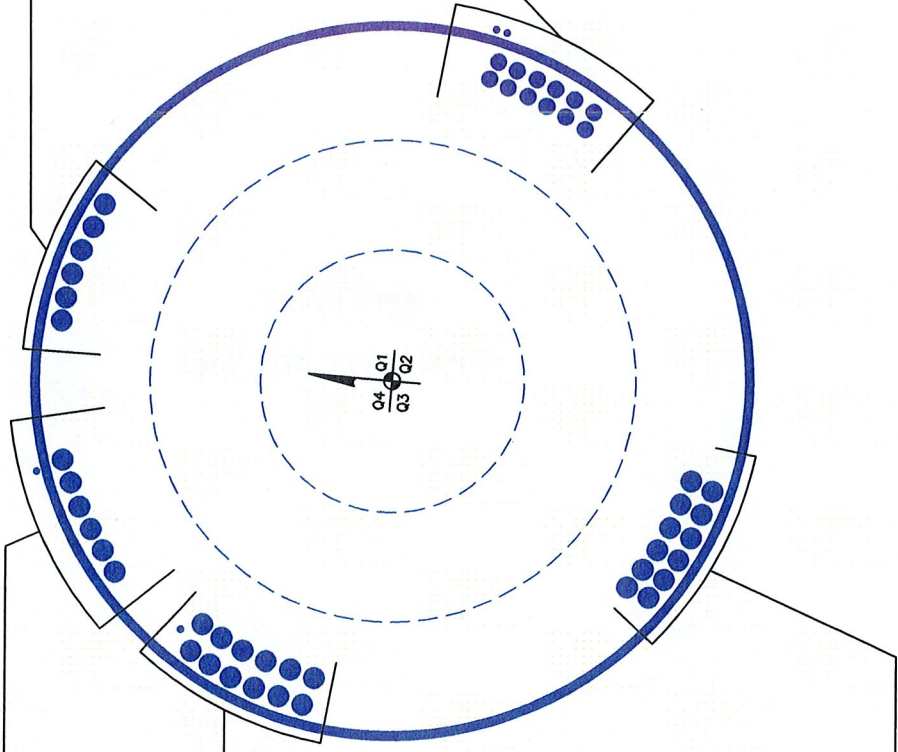

APPENDIX C
ADDITIONAL CALCULATIONS

Stiffened or Unstiffened, UngROUTed, Circular Base Plate - Any Rod Material

TIA Rev F

Site Data

BU#: 876391
Site Name: Columbia / Deojay
App #:
Pole Manufacturer: Other

Anchor Rod Data

Qty:	20	
Diam:	2.25	in
Rod Material:	A615-J	
Strength (Fu):	100	ksi
Yield (Fy):	75	ksi
Bolt Circle:	66	in

Plate Data

Diam:	72	in
Thick:	2.25	in
Grade:	60	ksi
Single-Rod B-eff:	9.09	in

Stiffener Data (Welding at both sides)

Config:	0	*
Weld Type:		
Groove Depth:		in **
Groove Angle:		degrees
Fillet H. Weld:		<-- Disregard
Fillet V. Weld:		in
Width:		in
Height:		in
Thick:		in
Notch:		in
Grade:		ksi
Weld str.:		ksi

Pole Data

Diam:	57.25	in
Thick:	0.5	in
Grade:	65	ksi
# of Sides:	18	"0" IF Round
Fu	80	ksi
Reinf. Fillet Weld	0	"0" if None

Stress Increase Factor

ASIF:	1.333
-------	-------

Reactions

Moment:	4109	ft-kips
Axial:	49	kips
Shear:	32	kips

If No stiffeners, Criteria: AISC ASD <-Only Applicable to Unstiffened Cases

Anchor Rod Results

Maximum Rod Tension: 147.0 Kips
 Allowable Tension: 195.0 Kips
 Anchor Rod Stress Ratio: 75.4% **Pass**

Rigid
Service, ASD
Fty*ASIF

Base Plate Results

Base Plate Stress: 52.8 ksi
 Allowable Plate Stress: 60.0 ksi
 Base Plate Stress Ratio: 88.0% **Pass**

Flexural Check

Rigid
Service ASD
0.75*Fy*ASIF
Y.L. Length:
32.84

n/a

Stiffener Results

Horizontal Weld : n/a
 Vertical Weld: n/a
 Plate Flex+Shear, fb/Fb+(fv/Fv)^2: n/a
 Plate Tension+Shear, ft/Ft+(fv/Fv)^2: n/a
 Plate Comp. (AISC Bracket): n/a

Pole Results

Pole Punching Shear Check: n/a

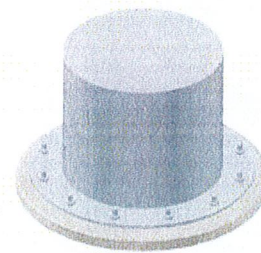
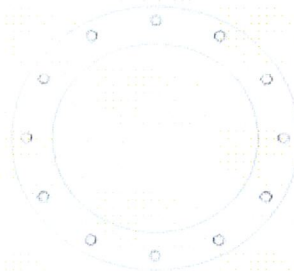

* 0 = none, 1 = every bolt, 2 = every 2 bolts, 3 = 2 per bolt

** Note: for complete joint penetration groove welds the groove depth must be exactly 1/2 the stiffener thickness for calculation purposes

JOB: 113166
 SHEET NUMBER: 1 OF 2
 CALCULATED BY: MWC DATE 9/2/2011
 CHECKED BY: DATE

Pad and Pier Foundation for Monopole - TIA-222-F

Q_a , ALLOWABLE SOIL PRESS. (ksf)	6
NET or GROSS	NET
SOIL DENSITY (pcf)	100

F'_c (ksi)	4
F'_y (ksi)	60

Base Reactions LC1: Maximum Wind

M , MOMENT (k-ft)	4109.0
P_t , TOTAL DOWNLOAD (k)	49.0
H , HORIZONTAL SHEAR (k)	32.0

Base Reaction LC 2: Ice Wind + Ice

M (k-ft)	1078.0
P_t (k)	69.0
H (k)	8.0

Try:	L (ft.)	B (ft.)	t (ft.)	Soil depth to TOP of mat (ft.)	Soil depth to BOT. of mat (ft.)	Pier dia./width (ft.)	Pier Height, h (cu.ft.)	Pier Shape
	26	26	3	4	7	7.00	5.00	Square

W_m , WEIGHT OF PAD (k) =	304.2	CONCRETE VOL. (cu yd)	84.19
W_p , WEIGHT OF PIER (k) =	36.8		
W_{p2} , ADD. WEIGHT OF PIER (k) =	17.3		
W_s , WEIGHT OF SOIL (k) =	250.8		

CHECK DESIGN CRITERIA

CHECK STABILITY:

	LC1	LC2
$Mst = P * (L/2) + (Vf+s * L/2) =$	8554.7 k-ft	8814.7 k-ft
$Mot = M + H*(t+h) =$	4365.0 k-ft	1142 k-ft
$SF = Mot/Mst =$	1.96 > 1.5	7.72 > 1.5

Capacity: 76.5%

CHECK BEARING PRESSURE

	LC1	LC2
$P = P_t + W_f + W_s =$	658.1 k	678.1 k
$e = M / P =$	6.63 ft	1.68 ft
$L/6 =$	4.33 ft	4.33 ft
Width of Wedge, $L' =$	19.10 ft	26.00 ft
0 Deg Wind: $Q_{max} =$	1.95 ksf	0.69 ksf
45 Deg Wind: $Q_{max} =$	2.86 ksf	0.85 ksf

Capacity: 47.6%

JOB: 113166
 SHEET NUMBER: 2 OF 2
 CALCULATED BY: MWC DATE 9/2/2011
 CHECKED BY: DATE

CHECK ONE WAY SHEAR

$V_u = 538.6 \text{ k}$
 $V_c = 943.5 \text{ k}$

Capacity: 57.09%

CHECK TWO WAY SHEAR: PUNCHING + UNBALANCED MOMENT

$V_u = 35.4 \text{ psi}$
 $\phi V_c = 189.7 \text{ psi}$

Capacity: 18.67%

CALCULATE REINFORCING REQUIRED

$F'_c = 4.0 \text{ ksi}$ $F'_y = 60.0 \text{ ksi}$

Temp & Shrinkage reinforcing, $A_{s, temp} = 0.39 \text{ in}^2/\text{ft}$ (ACI 318 Sec. 10.5.4)

BOTTOM REINFORCING

Bar Size = 9
 Bar Spacing, c-c: 9.0
 d = 31.3 in.

$M_u = 740.9 \text{ in-k/ft}$

$\phi M_n = 0.9 * A_s * F_y * d * (1 - 0.59 * A_s * F_y / (b * d * F'_c))$

Solution: $A_{s, req} = 0.44 \text{ in}^2/\text{ft}$

Check, $A_s = 1.33 \text{ in}^2/\text{ft}$

Capacity: 33.21%

TOP REINFORCING

Bar Size = 9
 Bar Spacing, c-c: 16.0
 d = 31.3 in.

$M_u = 588.6 \text{ in-k/ft}$

$\phi M_n = 0.9 * A_s * F_y * d * (1 - 0.59 * A_s * F_y / (b * d * F'_c))$

Solution: $A_{s, req} = 0.35 \text{ in}^2/\text{ft}$

Bar Spacing, c-c:

$A_{s, req} < A_{s, t}$. Use $A_{s, t}$

Check, $A_s = 0.75 \text{ in}^2/\text{ft}$

Top Reinforcing O.K.

Capacity: 51.84%

As,temp controls

Moment Capacity of Drilled Concrete Shaft (Caisson) for TIA Rev F or G

Note: Shaft assumed to have ties, not spiral, transverse reinforcing

Site Data

BU#: 876391	
Site Name: Columbia/Deojay	
App #:	

Maximum Shaft Superimposed Forces		
TIA Revision:	F	
Max. Service Shaft M:	4269	ft-kips (* Note)
Max. Service Shaft P:	49	kips
Max Axial Force Type:	Comp.	

(* Note: Max Shaft Superimposed Moment does not necessarily equal to the shaft top reaction moment

Enter Load Factors Below:		
For M (WL)	1.3	<---- Enter Factor
For P (DL)	1.3	<---- Enter Factor

Load Factor	Shaft Factored Loads	
1.30	Mu:	5549.7 ft-kips
1.30	Pu:	63.7 kips

Pier Properties	
Concrete:	
Pier Width =	7.0 ft
Concrete Area =	7056.0 in ²
Reinforcement:	
Clear Cover to Tie =	4.50 in
Horiz. Tie Bar Size =	4
Vert. Cage Diameter =	6.08 ft
Vert. Cage Diameter =	73.00 in
Vertical Bar Size =	8
Bar Diameter =	1.00 in
Bar Area =	0.79 in ²
Number of Bars =	39
As Total =	30.81 in ²
A s/ Aconc, Rho:	0.0044 0.44%

Material Properties		
Concrete Comp. strength, f'c =	4000	psi
Reinforcement yield strength, Fy =	60	ksi
Reinforcing Modulus of Elasticity, E =	29000	ksi
Reinforcement yield strain =	0.00207	
Limiting compressive strain =	0.003	
ACI 318 Code		
Select Analysis ACI Code =	2005	
Seismic Properties		
Seismic Design Category =	C	
Seismic Risk =	Moderate	

Solve (Run)	<-- Press Upon Completing All Input
-------------	-------------------------------------

ACI 10.5, ACI 21.10.4, and IBC 1810.

Min As for Flexural, Tension Controlled, Shafts:

(3)*(Sqrt(f'c)/Fy):	0.0032
200 / Fy:	0.0033
IBC 1810.1.2:	0.0025 SDC C
Governing:	0.0033 0.33%

ACI 10.8 and 10.9

Min As for Columns, Comp. Controlled, Shafts:

Min As:	0.0050 0.50%
---------	---------------------

Minimum Rho Check:

Actual Req'd Min. Rho:	0.33%	Flexural
Provided Rho:	0.44%	OK

Results:

Governing Orientation Case: 1

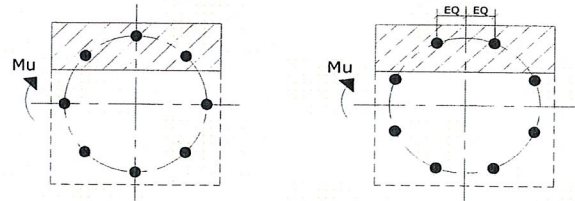

Case 1

Case 2

Dist. From Edge to Neutral Axis: 6.74 in

Extreme Steel Strain, ϵ_t : 0.0319

$\epsilon_t > 0.0050$, Tension Controlled

Reduction Factor, ϕ : 0.90

	<-- Comment Box
--	-----------------

Ref. Shaft Max Axial Capacities, ϕ Max(Pn or Tn):		
Max Pu = ($\phi=0.65$) Pn:		
Pn per ACI 318 (10-2)	13381.81	kips
at Mu=($\phi=0.65$)Mn=	8797.04	ft-kips
Max Tu, ($\phi=0.9$) Tn =	1663.74	kips
at Mu= $\phi(0.90)$ Mn=	0.00	ft-kips

Output Note: Negative Pu=Tension
 For Axial Compression, ϕ Pn = Pu: 63.70 kips
 Drilled Shaft Moment Capacity, ϕ Mn: 5551.42 ft-kips
 Drilled Shaft Superimposed Mu: 5549.70 ft-kips

(Mu/ϕMn, Drilled Shaft Flexure CSR:	100%
--	-------------