



Filed by:
Kri Pelletier, Property Specialist - SBA Communications
134 Flanders Rd., Suite 125, Westborough, MA 01581
508.251.0720 x 3804 - kpelletier@sbsite.com

June 20, 2018

Melanie A. Bachman
Acting Executive Director
Connecticut Siting Council
Ten Franklin Square
New Britain, CT 06051

Notice of Exempt Modification
31 Chestnut Hill Road, Colchester, CT
41 34 16.78 N
-72 18 8.36 W
Sprint #: CT33XC575

Dear Ms. Bachman:

Sprint currently maintains antennas at the 180-foot level of the existing 180-foot Monopole Tower at 31 Chestnut Hill Road in Colchester, CT. The tower is owned by SBA Towers, LLC. The property is owned by John Jr & Mary Przyborowski. Sprint now intends to replace (6) existing cell antennas with (6) newer technology cell antennas at the 99-foot level of the tower. The proposed full scope of work is as follows:

Remove:

- (6) 1-5/8" lines

Remove and Replace:

- Remove:
 - (6) Decibel - DB908H90E-M – Panel Antennas
- Replace with:
 - (3) RFS - APXVTM14-C-I20 – Panel Antennas
 - (3) CommScope - NNVV-65B-R4 - Panel Antennas

Install:

- (3) ALU 1900 Mhz RRUs
- (6) ALU 800 Mhz RRUs
- (3) ALU TD-RRH8x20-25 RRUS
- (1) Handrail kit (SitePro HRK-14)
- (1) V-brace kit (SitePro PRK-SFS)
- (1) Platform Reinforcement Kit (SitePro PRK-1245-L)
- (4) 1-1/4" Fiber

Existing Equipment to Remain (Including entitlements):

- (1) Low Profile Platform

This facility was originally approved by the Town of Colchester on November 3, 1999, prior to the Council's jurisdiction. The Planning & Zoning Commission issued approval under Site Development Plan 99-238. 25% of the total cost was to be posted as bond and Building Permit #8319 was issued February 22, 2000 without any further stipulations noted. This modification complies with all conditions.

Please accept this letter as notification pursuant to Regulations of Connecticut State Agencies §16-50j-73, for construction that constitutes an exempt modification pursuant to R.C.S.A. §16.50j-72(b)(2). In accordance with R.C.S.A. § 16.50j-73, a copy of this letter is being sent to the Town of Colchester's First Selectman, Art Shilosky, and Zoning Enforcement Officer, Daphne Schaub as well as to the property owner. (Separate notice is not being sent to tower owner, as it belongs to SBA.)

The planned modifications to the facility fall squarely within those activities explicitly provided for in R.C.S.A. §16.50j-72(b)(2).

1. The proposed modifications will not result in an increase in the height of the existing structure.
2. The proposed modification will not require the extension of the site boundary.
3. The proposed modifications will not increase noise levels at the facility by six decibels or more, or to levels that exceed state and local criteria.
4. The operation of the replacement antennas will not increase radio frequency emissions at the facility to a level at or above the Federal Communications Commission safety standard.
5. The proposed modification will not cause a change or alteration in the physical or environmental characteristics of the site.
6. The existing structure and its foundation can support the proposed loading.

For the foregoing reasons, Sprint respectfully submits that the proposed modifications to the above-referenced telecommunication facility constitute an exempt modifications under R.C.S.A. § 16-50j-72(b)(2).

Sincerely,



Kri Pelletier
Property Specialist
SBA COMMUNICATIONS CORPORATION
134 Flanders Rd., Suite 125
Westborough, MA 01581
508.251.0720 x3804 + T
508.366.2610 + F
203.446.7700 + C
kpelletier@sbsite.com

Attachments

cc: Art Shilosky, First Selectman / with attachments
Town of Colchester, 127 Norwich Avenue, Colchester, CT 06415
Daphne Schaub, Zoning Enforcement Officer / with attachments
Town of Colchester, 127 Norwich Avenue, Colchester, CT 06415
John Jr & Mary Przyborowski / with attachments
P.O. Box C, Fishers Island NY 06390



POWER DENSITY

SPRINT Site Inventory and Power Data by Antenna

Sector:	A	Sector:	B	Sector:	C
Antenna #:	1	Antenna #:	1	Antenna #:	1
Make / Model:	Commscope NNVV-65B-R4	Make / Model:	Commscope NNVV-65B-R4	Make / Model:	Commscope NNVV-65B-R4
Gain:	12.75 / 15.05 dBd	Gain:	12.75 / 15.05 dBd	Gain:	12.75 / 15.05 dBd
Height (AGL):	180 feet	Height (AGL):	180 feet	Height (AGL):	180 feet
Frequency Bands	850 MHz / 1900 MHz (PCS)	Frequency Bands	850 MHz / 1900 MHz (PCS)	Frequency Bands	850 MHz / 1900 MHz (PCS)
Channel Count	10	Channel Count	10	Channel Count	10
Total TX Power(W):	280 Watts	Total TX Power(W):	280 Watts	Total TX Power(W):	280 Watts
ERP (W):	7,378.61	ERP (W):	7,378.61	ERP (W):	7,378.61
Antenna A1 MPE%	1.08 %	Antenna B1 MPE%	1.08 %	Antenna C1 MPE%	1.08 %
Antenna #:	2	Antenna #:	2	Antenna #:	2
Make / Model:	RFS APXVTM14- ALU- I20	Make / Model:	RFS APXVTM14- ALU- I20	Make / Model:	RFS APXVTM14- ALU- I20
Gain:	15.9 dBd	Gain:	15.9 dBd	Gain:	15.9 dBd
Height (AGL):	180 feet	Height (AGL):	180 feet	Height (AGL):	180 feet
Frequency Bands	2500 MHz (BRS)	Frequency Bands	2500 MHz (BRS)	Frequency Bands	2500 MHz (BRS)
Channel Count	8	Channel Count	8	Channel Count	8
Total TX Power(W):	160 Watts	Total TX Power(W):	160 Watts	Total TX Power(W):	160 Watts
ERP (W):	6,224.72	ERP (W):	6,224.72	ERP (W):	6,224.72
Antenna A2 MPE%	0.74 %	Antenna B2 MPE%	0.74 %	Antenna C2 MPE%	0.74 %

Site Composite MPE%	
Carrier	MPE%
SPRINT – Max per sector	1.82 %
Verizon Wireless	1.47 %
Voicestream (T-Mobile)	1.21 %
Site Total MPE %:	4.50 %

SPRINT Sector A Total:	1.82 %
SPRINT Sector B Total:	1.82 %
SPRINT Sector C Total:	1.82 %
Site Total:	4.50 %

SPRINT _ Frequency Band / Technology (Per	# Chann	Watts ERP (Per	Height (feet)	Total Power Densi	Frequency	Allowable MPE	Calculated % MPE
Sprint 850 MHz CDMA	1	376.73	18	0.	850	5	0.09%
Sprint 850 MHz LTE	2	941.82	18	2.	850	5	0.39%
Sprint 1900 MHz (PCS)	5	511.82	18	3.	1900 MHz (PCS)	10	0.30%
Sprint 1900 MHz (PCS)	2	1,279.56	18	3.	1900 MHz (PCS)	10	0.30%
Sprint 2500 MHz (BRS)	8	778.09	18	7.	2500 MHz (BRS)	10	0.74%
						Total:	1.82 %

ORIGIN ID:BBFA (508) 251-0720
KRIPELLETER
SBA COMMUNICATIONS CORPORATION
134 FLANDERS RD
SUITE 125
WESTBOROUGH MA 01581
UNITED STATES US

SHIP DATE: 20 JUN 18
ACTWGT: 1.00 LB
CAD: 105843304/NET3980

BILL SENDER

TO ART SHILOSKY, FIRST SELECTMAN
TOWN OF COLCHESTER
127 NORWICH AVENUE
COLCHESTER CT 06415

(508) 251-0720 REF: 10-56-92009-6099
INV: DEPT:
PO:

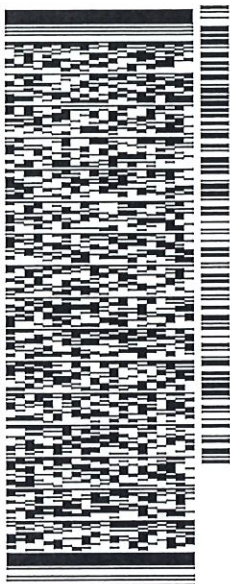

J181118012601uv

552.0293DF/DCA5

TRK# 7725 2413 7330
0201

THU - 21 JUN 10:30A
PRIORITY OVERNIGHT

EB SKKA

06415
BDL
CT-US



After printing this label:

1. Use the 'Print' button on this page to print your label to your laser or inkjet printer.
2. Fold the printed page along the horizontal line.
3. Place label in shipping pouch and affix it to your shipment so that the barcode portion of the label can be read and scanned.

Warning: Use only the printed original label for shipping. Using a photocopy of this label for shipping purposes is fraudulent and could result in additional billing charges, along with the cancellation of your FedEx account number.

Use of this system constitutes your agreement to the service conditions in the current FedEx Service Guide, available on fedex.com. FedEx will not be responsible for any claim in excess of \$100 per package, whether the result of loss, damage, delay, non-delivery, misdelivery, or misinformation, unless you declare a higher value, pay an additional charge, document your actual loss and file a timely claim. Limitations found in the current FedEx Service Guide apply. Your right to recover from FedEx for any loss, including intrinsic value of the package, loss of sales, income interest, profit, attorney's fees, costs, and other forms of damage whether direct, incidental, consequential, or special is limited to the greater of \$100 or the authorized declared value. Recovery cannot exceed actual documented loss. Maximum for items of extraordinary value is \$1,000, e.g. jewelry, precious metals, negotiable instruments and other items listed in our ServiceGuide. Written claims must be filed within strict time limits, see current FedEx Service Guide.

ORIGIN ID:BBFA (508) 251-0720
KRI PELLETIER
SBA COMMUNICATIONS CORPORATION
134 FLANDERS RD
SUITE 125
WESTBOROUGH MA 01581
UNITED STATES US

SHIP DATE: 20 JUN 18
ACTWGT: 1.00 LB
CAD: 105843304/NET3980

BILL SENDER

TO DAPHNE SCHAUB, ZONING ENFORCEMENT
TOWN OF COLCHESTER
127 NORWICH AVENUE

COLCHESTER CT 06415

REF: 10-56-92009-6099

(508) 251-0720
INV:
PO:

DEPT:

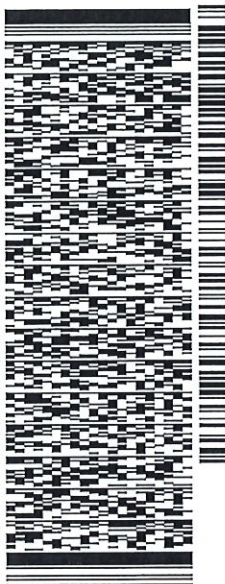

J181118012601uv

552J293DF/DCA5

TRK# 7725 2417 5504
0201

THU - 21 JUN 10:30A
PRIORITY OVERNIGHT

EB SKKA

06415
CT-US BDL



After printing this label:

1. Use the 'Print' button on this page to print your label to your laser or inkjet printer.
2. Fold the printed page along the horizontal line.
3. Place label in shipping pouch and affix it to your shipment so that the barcode portion of the label can be read and scanned.

Warning: Use only the printed original label for shipping. Using a photocopy of this label for shipping purposes is fraudulent and could result in additional billing charges, along with the cancellation of your FedEx account number.

Use of this system constitutes your agreement to the service conditions in the current FedEx Service Guide, available on fedex.com. FedEx will not be responsible for any claim in excess of \$100 per package, whether the result of loss, damage, delay, non-delivery, misdelivery, or misinformation, unless you declare a higher value, pay an additional charge, document your actual loss and file a timely claim. Limitations found in the current FedEx Service Guide apply. Your right to recover from FedEx for any loss, including intrinsic value of the package, loss of sales, income interest, profit, attorney's fees, costs, and other forms of damage whether direct, incidental, consequential, or special is limited to the greater of \$100 or the authorized declared value. Recovery cannot exceed actual documented loss. Maximum for items of extraordinary value is \$1,000, e.g. jewelry, precious metals, negotiable instruments and other items listed in our Service Guide. Written claims must be filed within strict time limits, see current FedEx Service Guide.

ORIGIN ID:BBFA (508) 251-0720
KRI PELLETIER
SBA COMMUNICATIONS CORPORATION
134 FLANDERS RD
SUITE 125
WESTBOROUGH, MA 01581
UNITED STATES US

SHIP DATE: 20JUN18
ACTWGT: 1.00 LB
CAD: 105843304/INET3980
BILL SENDER

TO JOHN JR. & MARY PRZYBOROWSKI

PO BOX C

FISHERS ISLAND NY 06390

(508) 251-0720 REF: 10-56-92009-6089
INV. DEPT:
P.O.



TRK# 7725 2420 7937 THU - 21 JUN 4:30P
0201 PRIORITY OVERNIGHT

EB SKKA 06390
NY-US BDL



552J293DF/DCA5

After printing this label:

1. Use the 'Print' button on this page to print your label to your laser or inkjet printer.
2. Fold the printed page along the horizontal line.
3. Place label in shipping pouch and affix it to your shipment so that the barcode portion of the label can be read and scanned.

Warning: Use only the printed original label for shipping. Using a photocopy of this label for shipping purposes is fraudulent and could result in additional billing charges, along with the cancellation of your FedEx account number.

Use of this system constitutes your agreement to the service conditions in the current FedEx Service Guide, available on fedex.com. FedEx will not be responsible for any claim in excess of \$100 per package, whether the result of loss, damage, delay, non-delivery, misdelivery, or misinformation, unless you declare a higher value, pay an additional charge, document your actual loss and file a timely claim. Limitations found in the current FedEx Service Guide apply. Your right to recover from FedEx for any loss, including intrinsic value of the package, loss of sales, income interest, profit, attorney's fees, costs, and other forms of damage whether direct, incidental, consequential, or special is limited to the greater of \$100 or the authorized declared value. Recovery cannot exceed actual documented loss. Maximum for items of extraordinary value is \$1,000, e.g. jewelry, precious metals, negotiable instruments and other items listed in our ServiceGuide. Written claims must be filed within strict time limits, see current FedEx Service Guide.



Town of Colchester, CT

Property Listing Report

Map Block Lot

4W-01/004-000

Account

P0499600

PID

4018

Property Information

Property Location	31 CHESTNUT HILL RD
Owner	PRZYBOROWSKI JOHN JR + MARY
Co-Owner	
Mailing Address	PO BOX C FISHERS ISLAND NY 06390
Land Use	4010 Ind Whse MDL-96
Land Class	I
Zoning Code	GC
Census Tract	
Sub Lot	
Neighborhood	1000
Acreage	40.25
Utilities	Well,Septic
Lot Setting/Desc	Suburban
Survey Map	
Additional Info	

Photo



Sketch

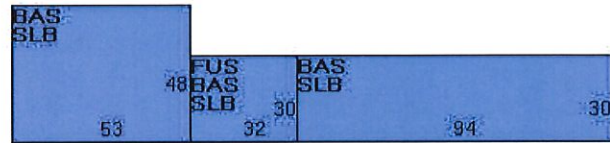

Primary Construction Details

Year Built	1952
Stories	2
Building Style	Warehouse
Building Use	Commercial
Building Condition	C
Floors	Concrete Slab
Total Rooms	

Bedrooms	
Full Bathrooms	0
Half Bathrooms	
Bath Style	
Kitchen Style	
Roof Style	Gable
Roof Cover	Metal/Tin

Exterior Walls	Wood Shingle
Interior Walls	Minimum
Heating Type	None
Heating Fuel	Coal or Wood
AC Type	None
Gross Bldg Area	13608
Total Living Area	7284



Town of Colchester, CT

Property Listing Report

Map Block Lot 4W-01/004-000

Account

P0499600

Valuation Summary (Assessed value = 70% of Appraised Value)

Item	Appraised	Assessed
Buildings	66600	46600
Extras	0	0
Outbuildings	5600	3900
Land	642900	296700
Total	715100	347200

Outbuilding and Extra Items

Type	Description
Kennel GD	376.00 S.F.
Fence 6' Chain	77.00 L.F.
Cabin-Minimal	696.00 S.F.

Sub Areas

Subarea Type	Gross Area (sq ft)	Living Area (sq ft)
First Floor	6324	6324
Slab	6324	0
Upper Story, Finished	960	960
Total Area	13608	7284

Sales History

Owner of Record	Book/ Page	Sale Date	Sale Price
PRZYBOROWSKI JOHN JR + MARY	997/ 101	3/4/2008	0
PRZYBOROWSKI JOHN JR	80/ 485	7/13/1986	0



Town of Colchester, CT

Property Listing Report

Map Block Lot 4W-01/004-000/TW

Account

11AT0008

Valuation Summary (Assessed value = 70% of Appraised Value)

Item	Appraised	Assessed
Buildings	0	0
Extras	0	0
Outbuildings	632200	442500
Land	0	0
Total	632200	442500

Outbuilding and Extra Items

Type	Description
Fence 8' Chain	240.00 L.F.
Cell Tower	3.00 SITES

Sub Areas

Subarea Type	Gross Area (sq ft)	Living Area (sq ft)
Total Area		0

Sales History

Owner of Record	Book/ Page	Sale Date	Sale Price
SBA TOWERS INC	000/ 000	10/1/2011	



Town of Colchester, CT

Property Listing Report

Map Block Lot

4W-01/004-000/TW

Account

11AT0008

PID

105118

Property Information

Property Location	31 CHESTNUT HILL RD
Owner	SBA TOWERS INC
Co-Owner	ATTN TAX DEPARTMENT CT002652
Mailing Address	8051 CONGRESS AVENUE BOCA RATON FL 33487-1307
Land Use	4310 Tel Rel Tw
Land Class	I
Zoning Code	
Census Tract	
Sub Lot	
Neighborhood	
Acreage	0
Utilities	
Lot Setting/Desc	
Survey Map	
Additional Info	

Photo



Sketch

Primary Construction Details

Year Built	
Stories	
Building Style	
Building Use	
Building Condition	
Floors	
Total Rooms	

Bedrooms	
Full Bathrooms	
Half Bathrooms	
Bath Style	
Kitchen Style	
Roof Style	
Roof Cover	

Exterior Walls	
Interior Walls	
Heating Type	
Heating Fuel	
AC Type	
Gross Bldg Area	
Total Living Area	



RADIO FREQUENCY EMISSIONS ANALYSIS REPORT EVALUATION OF HUMAN EXPOSURE POTENTIAL TO NON-IONIZING EMISSIONS

SPRINT Existing Facility

Site ID: CT33XC575

Colchester
31 Chestnut Hill Road
Colchester, CT 06415

June 14, 2018

EBI Project Number: 6218004396

Site Compliance Summary	
Compliance Status:	COMPLIANT
Site total MPE% of FCC general population allowable limit:	4.50 %



June 14, 2018

SPRINT

Attn: RF Engineering Manager
1 International Boulevard, Suite 800
Mahwah, NJ 07495

Emissions Analysis for Site: **CT33XC575 – Colchester**

EBI Consulting was directed to analyze the proposed SPRINT facility located at **31 Chestnut Hill Road, Colchester, CT**, for the purpose of determining whether the emissions from the Proposed SPRINT Antenna Installation located on this property are within specified federal limits.

All information used in this report was analyzed as a percentage of current Maximum Permissible Exposure (% MPE) as listed in the FCC OET Bulletin 65 Edition 97-01 and ANSI/IEEE Std C95.1. The FCC regulates Maximum Permissible Exposure in units of microwatts per square centimeter ($\mu\text{W}/\text{cm}^2$). The number of $\mu\text{W}/\text{cm}^2$ calculated at each sample point is called the power density. The exposure limit for power density varies depending upon the frequencies being utilized. Wireless Carriers and Paging Services use different frequency bands each with different exposure limits, therefore it is necessary to report results and limits in terms of percent MPE rather than power density.

All results were compared to the FCC (Federal Communications Commission) radio frequency exposure rules, 47 CFR 1.1307(b)(1) – (b)(3), to determine compliance with the Maximum Permissible Exposure (MPE) limits for General Population/Uncontrolled environments as defined below.

General population/uncontrolled exposure limits apply to situations in which the general population may be exposed or in which persons who are exposed as a consequence of their employment may not be made fully aware of the potential for exposure or cannot exercise control over their exposure. Therefore, members of the general population would always be considered under this category when exposure is not employment related, for example, in the case of a telecommunications tower that exposes persons in a nearby residential area.

General population exposure to radio frequencies is regulated and enforced in units of microwatts per square centimeter ($\mu\text{W}/\text{cm}^2$). The general population exposure limits for the 850 MHz Band is approximately $567 \mu\text{W}/\text{cm}^2$. The general population exposure limit for the 1900 MHz (PCS) and 2500 MHz (BRS) bands is $1000 \mu\text{W}/\text{cm}^2$. Because each carrier will be using different frequency bands, and each frequency band has different exposure limits, it is necessary to report percent of MPE rather than power density.



Occupational/controlled exposure limits apply to situations in which persons are exposed as a consequence of their employment and in which those persons who are exposed have been made fully aware of the potential for exposure and can exercise control over their exposure. Occupational/controlled exposure limits also apply where exposure is of a transient nature as a result of incidental passage through a location where exposure levels may be above general population/uncontrolled limits (see below), as long as the exposed person has been made fully aware of the potential for exposure and can exercise control over his or her exposure by leaving the area or by some other appropriate means.

Additional details can be found in FCC OET 65.

CALCULATIONS

Calculations were done for the proposed SPRINT Wireless antenna facility located at **31 Chestnut Hill Road, Colchester, CT**, using the equipment information listed below. All calculations were performed per the specifications under FCC OET 65. Since SPRINT is proposing highly focused directional panel antennas, which project most of the emitted energy out toward the horizon, all calculations were performed assuming a lobe representing the maximum gain of the antenna per the antenna manufactures supplied specifications, minus 10 dB, was focused at the base of the tower. For this report the sample point is the top of a 6-foot person standing at the base of the tower.

For all calculations, all equipment was calculated using the following assumptions:

- 1) 1 CDMA channels (850 MHz) were considered for each sector of the proposed installation. These Channels have a transmit power of 20 Watts per Channel.
- 2) 2 LTE channels (850 MHz) were considered for each sector of the proposed installation. These Channels have a transmit power of 50 Watts per Channel.
- 3) 5 CDMA channels (1900 MHz (PCS)) were considered for each sector of the proposed installation. These Channels have a transmit power of 16 Watts per Channel.
- 4) 2 LTE channels (1900 MHz (PCS)) were considered for each sector of the proposed installation. These Channels have a transmit power of 40 Watts per Channel.
- 5) 8 LTE channels (2500 MHz (BRS)) were considered for each sector of the proposed installation. These Channels have a transmit power of 20 Watts per Channel.



- 6) All radios at the proposed installation were considered to be running at full power and were uncombined in their RF transmissions paths per carrier prescribed configuration. Per FCC OET Bulletin No. 65 - Edition 97-01 recommendations to achieve the maximum anticipated value at each sample point, all power levels emitting from the proposed antenna installation are increased by a factor of 2.56 to account for possible in-phase reflections from the surrounding environment. This is rarely the case, and if so, is never continuous.
- 7) For the following calculations, the sample point was the top of a 6-foot person standing at the base of the tower. The maximum gain of the antenna per the antenna manufactures supplied specifications minus 10 dB was used in this direction. This value is a very conservative estimate as gain reductions for these particular antennas are typically much higher in this direction.
- 8) The antennas used in this modeling are the **Commscope NNVV-65B-R4 and the RFS APXVTM14-ALU-I20** for transmission in the 850 MHz, 1900 MHz (PCS) and 2500 MHz (BRS) frequency bands. This is based on feedback from the carrier with regards to anticipated antenna selection. Maximum gain values for all antennas are listed in the Inventory and Power Data table below. The maximum gain of the antenna per the antenna manufactures supplied specifications, minus 10 dB, was used for all calculations. This value is a very conservative estimate as gain reductions for these particular antennas are typically much higher in this direction.
- 9) The antenna mounting height centerlines of the proposed antennas are **180 feet** above ground level (AGL) for **Sector A**, **180 feet** above ground level (AGL) for **Sector B** and **180 feet** above ground level (AGL) for Sector C.
- 10) Emissions values for additional carriers were taken from the Connecticut Siting Council active database. Values in this database are provided by the individual carriers themselves.

All calculations were done with respect to uncontrolled / general population threshold limits.



SPRINT Site Inventory and Power Data by Antenna

Sector:	A	Sector:	B	Sector:	C
Antenna #:	1	Antenna #:	1	Antenna #:	1
Make / Model:	Commscope NNVV-65B-R4	Make / Model:	Commscope NNVV-65B-R4	Make / Model:	Commscope NNVV-65B-R4
Gain:	12.75 / 15.05 dBd	Gain:	12.75 / 15.05 dBd	Gain:	12.75 / 15.05 dBd
Height (AGL):	180 feet	Height (AGL):	180 feet	Height (AGL):	180 feet
Frequency Bands	850 MHz / 1900 MHz (PCS)	Frequency Bands	850 MHz / 1900 MHz (PCS)	Frequency Bands	850 MHz / 1900 MHz (PCS)
Channel Count	10	Channel Count	10	Channel Count	10
Total TX Power(W):	280 Watts	Total TX Power(W):	280 Watts	Total TX Power(W):	280 Watts
ERP (W):	7,378.61	ERP (W):	7,378.61	ERP (W):	7,378.61
Antenna A1 MPE%	1.08 %	Antenna B1 MPE%	1.08 %	Antenna C1 MPE%	1.08 %
Antenna #:	2	Antenna #:	2	Antenna #:	2
Make / Model:	RFS APXVTM14-ALU-I20	Make / Model:	RFS APXVTM14-ALU-I20	Make / Model:	RFS APXVTM14-ALU-I20
Gain:	15.9 dBd	Gain:	15.9 dBd	Gain:	15.9 dBd
Height (AGL):	180 feet	Height (AGL):	180 feet	Height (AGL):	180 feet
Frequency Bands	2500 MHz (BRS)	Frequency Bands	2500 MHz (BRS)	Frequency Bands	2500 MHz (BRS)
Channel Count	8	Channel Count	8	Channel Count	8
Total TX Power(W):	160 Watts	Total TX Power(W):	160 Watts	Total TX Power(W):	160 Watts
ERP (W):	6,224.72	ERP (W):	6,224.72	ERP (W):	6,224.72
Antenna A2 MPE%	0.74 %	Antenna B2 MPE%	0.74 %	Antenna C2 MPE%	0.74 %

Site Composite MPE%	
Carrier	MPE%
SPRINT – Max per sector	1.82 %
Verizon Wireless	1.47 %
Voicestream (T-Mobile)	1.21 %
Site Total MPE %:	4.50 %

SPRINT Sector A Total:	1.82 %
SPRINT Sector B Total:	1.82 %
SPRINT Sector C Total:	1.82 %
Site Total:	4.50 %

SPRINT _ Frequency Band / Technology (Per Sector)	# Channels	Watts ERP (Per Channel)	Height (feet)	Total Power Density ($\mu\text{W}/\text{cm}^2$)	Frequency (MHz)	Allowable MPE ($\mu\text{W}/\text{cm}^2$)	Calculated % MPE
Sprint 850 MHz CDMA	1	376.73	180	0.45	850 MHz	567	0.09%
Sprint 850 MHz LTE	2	941.82	180	2.24	850 MHz	567	0.39%
Sprint 1900 MHz (PCS) CDMA	5	511.82	180	3.04	1900 MHz (PCS)	1000	0.30%
Sprint 1900 MHz (PCS) LTE	2	1,279.56	180	3.04	1900 MHz (PCS)	1000	0.30%
Sprint 2500 MHz (BRS) LTE	8	778.09	180	7.39	2500 MHz (BRS)	1000	0.74%
						Total:	1.82 %



Summary

All calculations performed for this analysis yielded results that were **within** the allowable limits for general population exposure to RF Emissions.

The anticipated maximum composite contributions from the SPRINT facility as well as the site composite emissions value with regards to compliance with FCC's allowable limits for general population exposure to RF Emissions are shown here:

SPRINT Sector	Power Density Value (%)
Sector A:	1.82 %
Sector B:	1.82 %
Sector C:	1.82 %
SPRINT Maximum Total (per sector):	1.82 %
Site Total:	4.50 %
Site Compliance Status:	COMPLIANT

The anticipated composite MPE value for this site assuming all carriers present is **4.50 %** of the allowable FCC established general population limit sampled at the ground level. This is based upon values listed in the Connecticut Siting Council database for existing carrier emissions.

FCC guidelines state that if a site is found to be out of compliance (over allowable thresholds), that carriers over a 5% contribution to the composite value will require measures to bring the site into compliance. For this facility, the composite values calculated were well within the allowable 100% threshold standard per the federal government.



Tower Engineering Solutions

Phone (972) 483-0607, Fax (972) 975-9615
8445 Freepoint Parkway, Suite 375, Irving, Texas 75063

Structural Analysis Report

Existing 180 ft Valmont Monopole
Customer Name: SBA Communications Corp
Customer Site Number: CT02220-S
Customer Site Name: Colchester 2 CT
Carrier Name: Sprint Nextel
Carrier Site ID / Name: CT33XC575 / Colchester
Site Location: 31 Chestnut Hill Road
Colchester, Connecticut
New London County
Latitude: 41.571327
Longitude: -72.302322

Analysis Result:

Max Structural Usage: 51.6% [Pass]
Max Foundation Usage: 46.0% [Pass]
Additional Usage Caused by Mount Modification: +4.5 %
Report Prepared By: Tawfeeq Alajaj

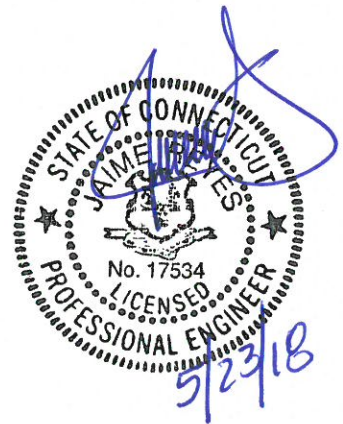

Introduction

The purpose of this report is to summarize the analysis results on the 180 ft Valmont Monopole to support the proposed antennas and transmission lines in addition to those currently installed. Any modification listed under Sources of Information was assumed completed and was included in this analysis.

Sources of Information

Tower Drawings	Tower design prepared by Valmont, job # 19539-99, dated 11/30/1999
Foundation Drawing	Foundation design prepared by Valmont, job # 19539-99, dated 11/29/1999
Geotechnical Report	Geotechnical report prepared by 1207126EG1, dated 08/10/2012
Modification Drawings	Modification inspection prepared by FDH, job # 15BSZU1700, dated 10/14/2015

Analysis Criteria

The rigorous analysis was performed in accordance with the requirements and stipulations of the ANSI/TIA/EIA 222-G. In accordance with this standard, the structure was analyzed using **TESPoles**, a proprietary analysis software. The program considers the structure as an elastic 3-D model with second-order effects and temperature effects incorporated in the analysis. The analysis was performed using multiple wind directions.

Wind Speed Used in the Analysis:	Ultimate Design Wind Speed $V_{ult} = 130.0$ mph (3-Sec. Gust)/ Nominal Design Wind Speed $V_{asd} = 101.0$ mph (3-Sec. Gust)
Wind Speed with Ice:	50 mph (3-Sec. Gust) with 3/4" radial ice concurrent
Operational Wind Speed:	60 mph + 0" Radial ice
Standard/Codes:	ANSI/TIA/EIA 222-G / 2012 IBC / 2016 Connecticut State Building Code
Exposure Category:	B
Structure Class:	II
Topographic Category:	1
Crest Height:	0 ft
Seismic Parameters:	$S_S = 0.174$, $S_1 = 0.061$

This structural analysis is based upon the tower being classified as a Structure Class II; however, if a different classification is required subsequent to the date hereof, the tower classification will be changed to meet such requirement and a new structural analysis will be run.

Existing Antennas, Mounts and Transmission Lines

The table below summarizes the antennas, mounts and transmission lines that were considered in the analysis as existing on the tower.

Items	Elevation (ft)	Qty.	Antenna Descriptions	Mount Type & Qty.	Transmission Lines	Owner
1	180.0	6	Decibel - DB908H90E-M - Panel	Low Profile Platform	(6) 1 5/8"	Sprint Nextel
6	164.5	3	EMS - RR901782DP - Panel	Low Profile Platform	(12) 1 5/8"	T-Mobile
7		3	Commscope - LNX-65651DS - Panel			
8		3	Kathrein - 782 11056 - Bias T			
9	60.0	2	Commscope - HBX-6513DS-A1M - Panel	(3) Standoff	(1) 1 5/8" Fiber	Verizon
10		2	ALU - RRH2x60-AWS			

Proposed Carrier's Final Configuration of Antennas, Mounts and Transmission Lines

Information pertaining to the proposed carrier's final configuration of antennas and transmission lines was provided by SBA Communications Corp. The proposed antennas and lines are listed below.

Items	Elevation (ft)	Qty.	Antenna Descriptions	Mount Type & Qty.	Transmission Lines	Owner
1	180.0	3	RFS - APXVTM14-C-I20 - Panel	Low Profile Platform + (1)Handrail Kit (SitePro HRK-14) +(1) V-Brace Kit (SitePro PRK-SFS) + (1) Platform Reinforcement Kit (SitePro PRK-1245-L)	(4) 1-1/4" Fiber	Sprint Nextel
2		3	CommScope - NNVV-65B-R4 - Panel			
3		3	ALU 1900 Mhz RRUs			
4		6	ALU 800 Mhz RRUs			
5		3	ALU TD-RRH8x20-25 RRUs			

All transmission lines are considered running inside of the pole shafts.

Analysis Results

The results of the structural analysis, performed for the wind and ice loading and antenna equipment as defined above, are summarized as the following:

	Pole shafts	Anchor Bolts	Base Plate
Max. Usage:	51.6%	48.5%	36.0%
Pass/Fail	Pass	Pass	Pass

Foundations

	Moment (Kip-Ft)	Shear (Kips)
Original Design Reactions	5045.0	39.5
Analysis Reactions	3421.7	28.7
Factored Reactions*	6810.8	53.3
% of Design Reactions	50.2%	53.7%

* Per section 15.5.1 of the TIA-222-G standard, factored reactions were obtained by multiplying a 1.35 factor to the original design reactions.

The foundation has been investigated using the supplied documents and soils report and was found adequate. Therefore, no modification to the foundation will be required.

Operational Condition (Rigidity):

Operational characteristics of the tower are found to be within the limits prescribed by ANSI/TIA/EIA 222-G for the installed antennas. The maximum twist/sway at the elevation of the proposed equipment is 1.0892 degrees under the operational wind speed as specified in the Analysis Criteria.

Conclusions

Based on the analysis results, the existing structure and its foundation were found to be adequate to safely support the existing and proposed equipment and meet the minimum requirements per the ANSI/TIA/EIA 222-G Standard under the design basic wind speed as specified in the Analysis Criteria.

Standard Conditions

1. This analysis was performed based on the information supplied to **(TES) Tower Engineering Solutions, LLC**. Verification of the information provided was not included in the Scope of Work for **TES**. The accuracy of the analysis is dependent on the accuracy of the information provided.
2. The analysis is based on the presumption that the tower members and components along with any existing reinforcement items have been correctly and properly designed, manufactured, installed and maintained.
3. All the existing structural members were assumed to be in good condition with no physical damage or deterioration associated with corrosion.
4. An initial tension of 10% of the break strength on all the existing guy wires was assumed in all the structural analyses of guyed towers unless different values were provided by the client. **TES** cannot take responsibility for the deviations in the analysis results because of differences in the initial tension forces of the existing guy wires.
5. Secondary component or connection secondary components, welds and bolts are assumed to be able to carry their intended original design loads. **TES** cannot take responsibility for verification of the adequacy on the connections, bolts and welds present in the structure.
6. The analyses will be performed based on the codes as specified by the client or based on the best knowledge of the engineering staff of **TES**. In the absence of information to the contrary, all work will be performed in accordance with the latest relevant revision of ANSI/TIA-222. If wind speed and/or ice loads are different from the minimum values recommended by the EIA/TIA-222 standard or other codes, **TES** should be notified in writing and the applicable minimum values provided by the client.
7. The configuration of the existing mounts, antennas, coax and other appurtenances were supplied by the customer for the current structural analysis. **TES** has not visited the tower site to verify the adequacy of the information provided. If there is any discrepancy found in the report regarding the existing conditions, **TES** should be notified immediately to evaluate the effect of the discrepancy on the analysis results.
8. The client will assume responsibility for rework associated with the differences in initially provided information, including tower and foundation information, existing and/or proposed equipment and transmission lines.
9. If a feasibility analysis was performed, final acceptance of changed conditions shall be based upon a rigorous structural analysis.

Usage Diagram - Max Ratio 51.59% at 0.0ft

Structure: CT02220-S-SBA
Site Name: Colchester 2 CT
Height: 180.00 (ft)
Base Elev: 0.000 (ft)

Code: EIA/TIA-222-G
Exposure: B
Gh: 1.1

5/23/2018



Page: 1

Dead Load Factor: 1.20
Wind Load Factor: 1.60

Load Case : 1.2D + 1.6W 101 mph Wind

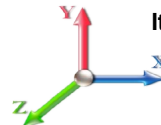

Iterations: 24

Copyright © 2018 by Tower Engineering Solutions, LLC. All rights reserved.

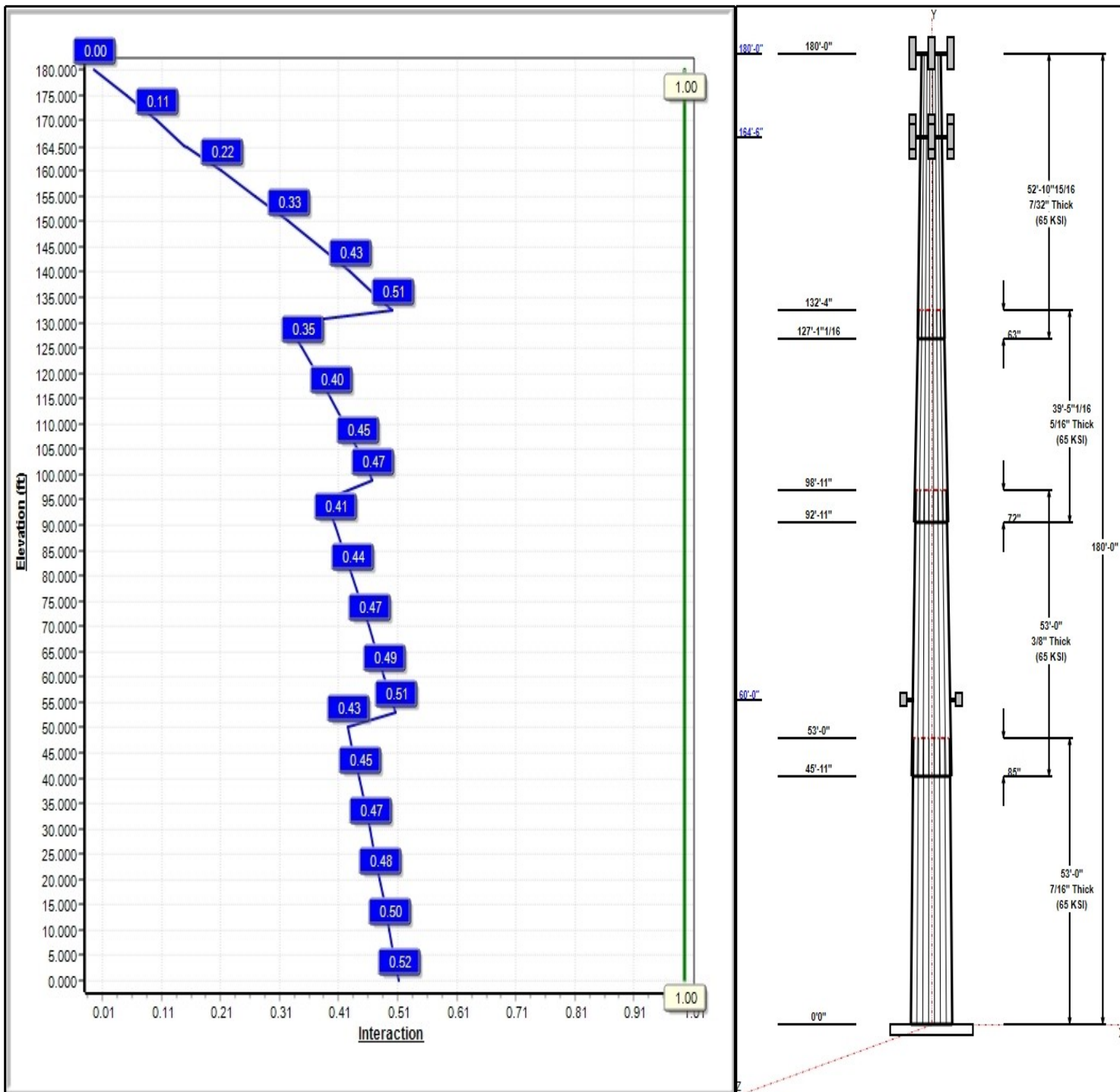

Structure: CT02220-S-SBA

Type: Tapered
Site Name: Colchester 2 CT
Height: 180.00 (ft)
Base Elev: 0.00 (ft)

Base Shape: 16 Sided
Taper: 0.20502

5/23/2018

Page: 2



Shaft Properties

Seq	Length (ft)	Top (in)	Bottom (in)	Thick (in)	Joint Type	Taper	Grade (ksi)
1	53.00	49.13	60.00	0.439		0.20502	65
2	53.00	40.47	51.34	0.375	Slip	0.20502	65
3	39.42	34.24	42.33	0.313	Slip	0.20502	65
4	52.91	24.91	35.76	0.219	Slip	0.20502	65

Discrete Appurtenances

Attach Elev (ft)	Force Elev (ft)	Qty	Description	Carrier
180.00	180.00	3	APXVTM14-C-I20	Sprint Nextel
180.00	180.00	3	ALU 1900 Mhz RRUs	Sprint Nextel
180.00	180.00	6	ALU 800 Mhz RRUs	Sprint Nextel
180.00	180.00	3	ALU TD-RRH8x20-25	Sprint Nextel
180.00	180.00	1	Low Profile Platform	Sprint Nextel
180.00	180.00	1	HRK-14	Sprint Nextel
180.00	180.00	1	PRK-SFS	Sprint Nextel
180.00	180.00	1	PRK-1245L	Sprint Nextel
180.00	180.00	3	NNVV-65B-R4	Sprint Nextel
164.50	164.50	3	RR901782DP	T-Mobile
164.50	164.50	3	LNx-65651DS	T-Mobile
164.50	164.50	3	782 11056	T-Mobile
164.50	164.50	1	Low Profile Platform	T-Mobile
60.00	60.00	2	HBX-6513DS-A1M	Verizon
60.00	60.00	2	RRH2x40-AWS	Verizon
60.00	60.00	3	3 ft Standoff	Verizon

Linear Appurtenances

Elev From (ft)	Elev To (ft)	Placement	Description	Carrier
0.00	180.00	Inside	1-1/4" Fiber	Sprint Nextel
0.00	164.50	Inside	1 5/8" Coax	T-Mobile
0.00	60.00	Inside	1 5/8" Fiber	Verizon

Anchor Bolts

Qty	Specifications	Grade (ksi)	Arrangement
20	2.25" 18J	75.0	Radial

Base Plate

Thickness (in)	Specifications (in)	Grade (ksi)	Geometry
2.7500	74.6	60.0	Polygon

Reactions

Load Case	Moment (FT-Kips)	Shear (Kips)	Axial (Kips)
1.2D + 1.6W 101 mph Wind	3421.7	28.7	48.0
0.9D + 1.6W 101 mph Wind	3391.7	28.6	36.0
1.2D + 1.0Di + 1.0Wi 50 mph Wind	882.6	7.3	69.3
1.2D + 1.0E	247.8	1.8	48.0
0.9D + 1.0E	245.4	1.8	36.0
1.0D + 1.0W 60 mph Wind	750.9	6.3	40.0

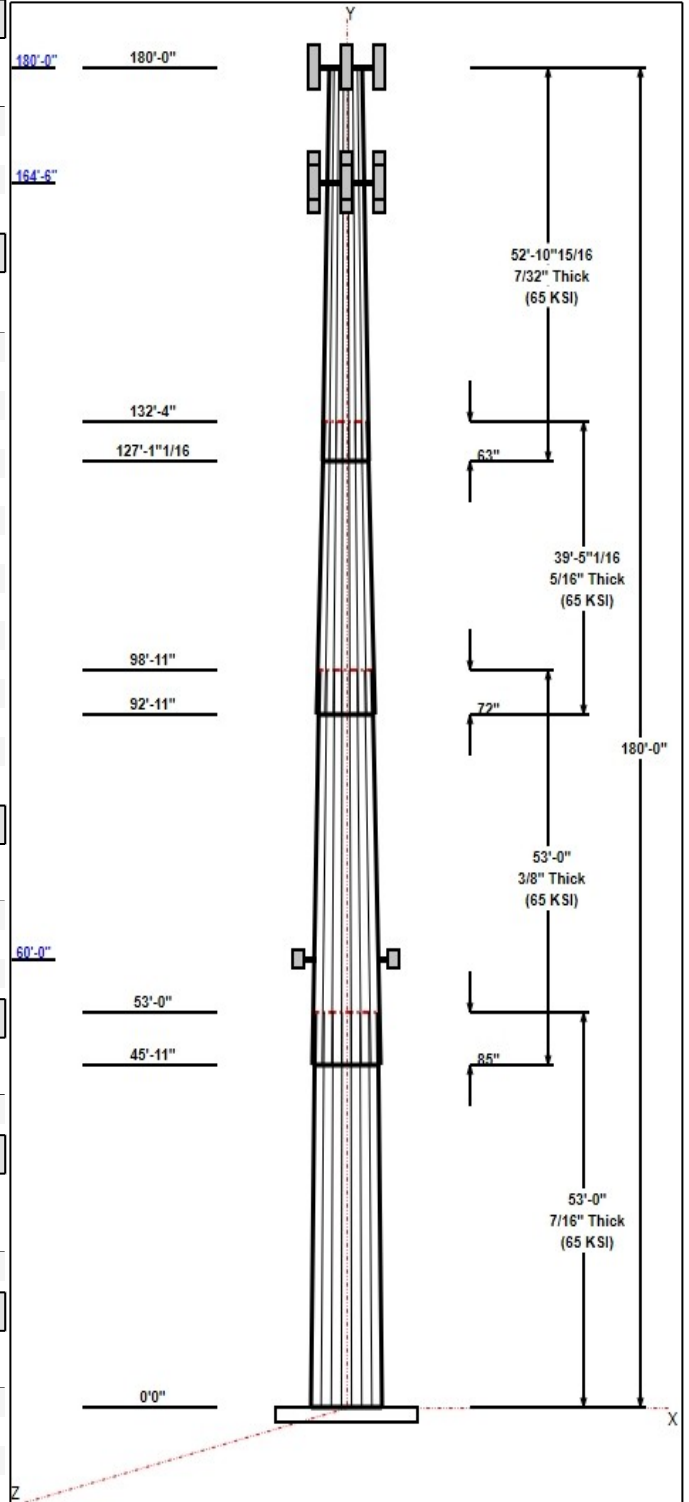

Structure: CT02220-S-SBA - Coax Line Placement

Type: Monopole
Site Name: Colchester 2 CT
Height: 180.00 (ft)

5/23/2018



Page: 3

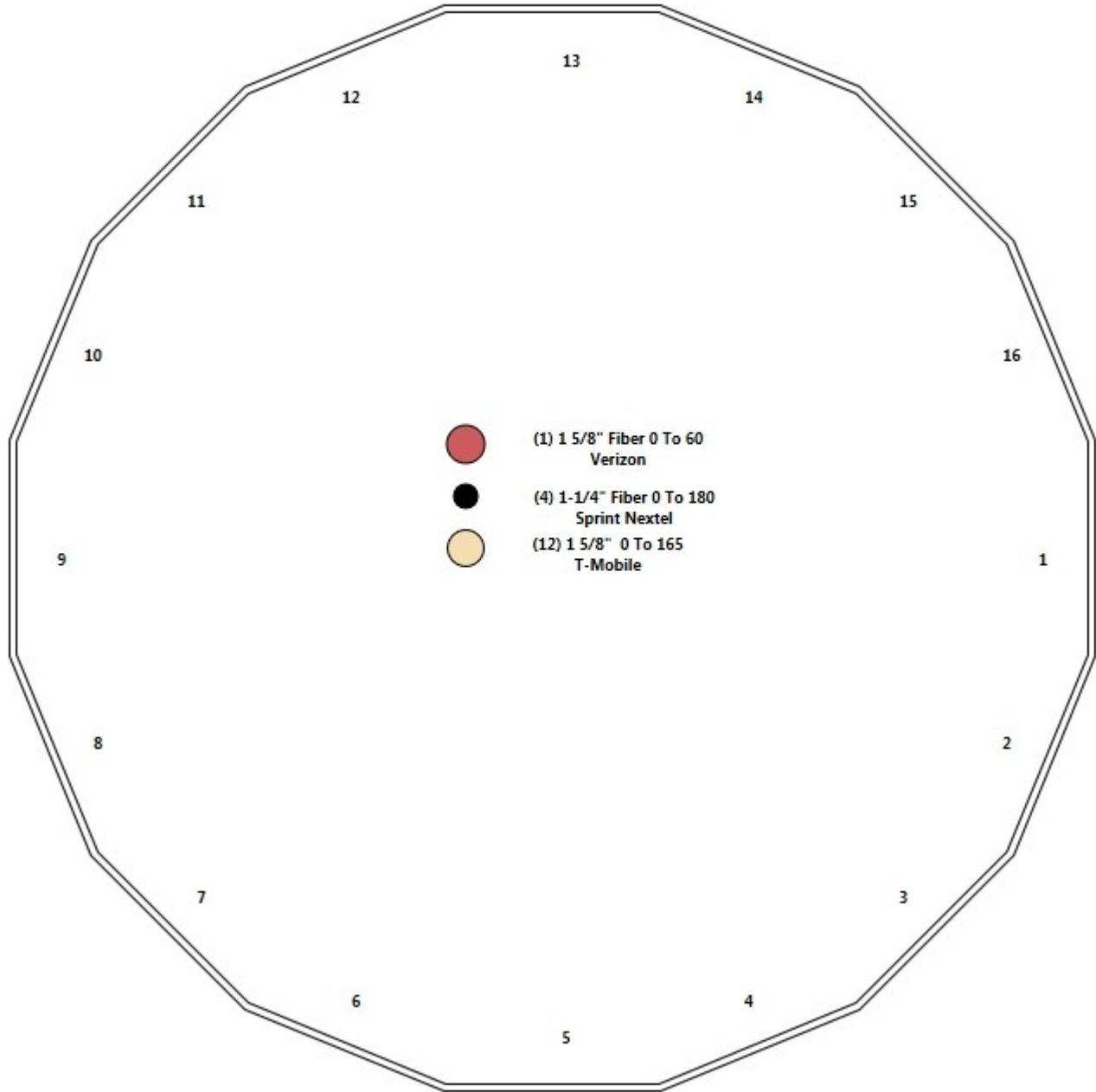

Shaft Properties

Structure: CT02220-S-SBA	Code: EIA/TIA-222-G	5/23/2018
Site Name: Colchester 2 CT	Exposure: B	
Height: 180.00 (ft)	Crest Height: 0.00	
Base Elev: 0.000 (ft)	Site Class: D - Stiff Soil	
Gh: 1.1	Topography: 1	Struct Class: II



Page: 4

Sec. No.	Shape	Length (ft)	Thick (in)	Fy (ksi)	Joint Type	Overlap (in)	Weight (lb)
1	16	53.000	0.4390	65		0.00	13,671
2	16	53.000	0.3750	65	Slip	85.00	9,822
3	16	39.420	0.3130	65	Slip	72.00	5,086
4	16	52.913	0.2190	65	Slip	63.00	3,788
Total Shaft Weight:							32,367

Bottom

Top

Sec. No.	Dia (in)	Elev (ft)	Area (sqin)	Ix (in^4)	W/t Ratio	D/t Ratio	Dia (in)	Elev (ft)	Area (sqin)	Ix (in^4)	W/t Ratio	D/t Ratio	Taper
1	60.00	0.00	83.41	37381.40	25.59	136.67	49.13	53.00	68.19	20427.6	20.67	111.9	0.205022
2	51.34	45.92	60.96	20001.00	25.64	136.90	40.47	98.92	47.96	9740.99	19.88	107.9	0.205022
3	42.33	92.92	41.95	9354.08	25.31	135.23	34.24	132.34	33.88	4927.66	20.17	109.4	0.205022
4	35.76	127.0	24.83	3961.68	30.89	163.28	24.91	180.00	17.25	1328.51	21.03	113.7	0.205022

Load Summary

Structure: CT02220-S-SBA	Code: EIA/TIA-222-G	5/23/2018
Site Name: Colchester 2 CT	Exposure: B	
Height: 180.00 (ft)	Crest Height: 0.00	
Base Elev: 0.000 (ft)	Site Class: D - Stiff Soil	
Gh: 1.1	Topography: 1	Struct Class: II



Page: 5

Discrete Appurtenances

No.	Elev (ft)	Description	Qty	No Ice			Ice			Hor. Ecc. (ft)	Vert Ecc (ft)
				Weight (lb)	CaAa (sf)	CaAa Factor	Weight (lb)	CaAa (sf)	CaAa Factor		
1	180.00	APXVTM14-C-I20	3	56.20	6.34	0.77	220.17	7.475	0.77	0.00	0.00
2	180.00	ALU 1900 Mhz RRUs	3	44.00	3.80	0.67	155.17	5.216	0.67	0.00	0.00
3	180.00	ALU 800 Mhz RRUs	6	53.00	2.49	0.67	128.32	3.655	0.67	0.00	0.00
4	180.00	ALU TD-RRH8x20-25 RRUs	3	70.00	4.05	0.67	182.93	4.879	0.67	0.00	0.00
5	180.00	Low Profile Platform	1	1200.00	25.00	1.00	2266.40	46.328	1.00	0.00	0.00
6	180.00	HRK-14	1	302.00	6.00	1.00	570.38	13.123	1.00	0.00	0.00
7	180.00	PRK-SFS	1	170.00	13.00	1.00	347.73	20.109	1.00	0.00	0.00
8	180.00	PRK-1245L	1	464.91	11.84	1.00	795.43	24.466	1.00	0.00	0.00
9	180.00	NNVV-65B-R4	3	77.40	12.27	0.74	368.21	13.753	0.74	0.00	0.00
10	164.50	RR901782DP	3	13.50	4.36	0.68	113.39	5.356	0.68	0.00	0.00
11	164.50	LNx-65651DS	3	49.80	11.47	0.80	281.48	14.767	0.80	0.00	0.00
12	164.50	782 11056	3	2.90	0.13	0.50	6.93	0.425	0.50	0.00	0.00
13	164.50	Low Profile Platform	1	1200.00	25.00	1.00	2256.84	46.137	1.00	0.00	0.00
14	60.00	HBX-6513DS-A1M	2	5.70	1.58	0.80	39.57	2.566	0.80	0.00	0.00
15	60.00	RRH2x40-AWS	2	44.00	2.16	0.67	99.41	3.116	0.67	0.00	0.00
16	60.00	3 ft Standoff	3	40.00	2.63	0.75	113.25	8.076	0.75	0.00	0.00
Totals:			39	4,815.71			11,609.24				

Linear Appurtenances

Bottom Elev. (ft)	Top Elev. (ft)	Description	Exposed Width	Exposed
0.00	180.00	(4) 1-1/4" Fiber	0.00	Inside
0.00	164.50	(12) 1 5/8" Coax	0.00	Inside
0.00	60.00	(1) 1 5/8" Fiber	0.00	Inside

Shaft Section Properties

Structure: CT02220-S-SBA	Code: EIA/TIA-222-G	5/23/2018
Site Name: Colchester 2 CT	Exposure: B	
Height: 180.00 (ft)	Crest Height: 0.00	
Base Elev: 0.000 (ft)	Site Class: D - Stiff Soil	
Gh: 1.1	Topography: 1	Struct Class: II



Page: 6

Increment Length: 5 (ft)

Elev (ft)	Description	Thick (in)	Dia (in)	Area (in ²)	Ix (in ⁴)	W/t Ratio	D/t Ratio	Fpy (ksi)	S (in ³)	Weight (lb)
0.00		0.4390	60.000	83.410	37381.4	25.59	136.67	73.6	1222.	0.0
5.00		0.4390	58.975	81.974	35484.3	25.13	134.34	74.1	1180.	1406.9
10.00		0.4390	57.950	80.539	33652.5	24.67	132.00	74.7	1139.	1382.5
15.00		0.4390	56.925	79.103	31884.8	24.20	129.67	75.2	1098.	1358.1
20.00		0.4390	55.900	77.668	30180.2	23.74	127.33	75.7	1059.	1333.6
25.00		0.4390	54.874	76.232	28537.4	23.27	125.00	76.2	1020.	1309.2
30.00		0.4390	53.849	74.796	26955.4	22.81	122.66	76.8	981.9	1284.8
35.00		0.4390	52.824	73.361	25432.9	22.34	120.33	77.3	944.4	1260.4
40.00		0.4390	51.799	71.925	23968.9	21.88	117.99	77.8	907.7	1235.9
45.00		0.4390	50.774	70.490	22562.1	21.41	115.66	78.3	871.7	1211.5
45.92	Bot - Section 2	0.4390	50.586	70.226	22310.3	21.33	115.23	78.4	865.1	219.5
50.00		0.4390	49.749	69.054	21211.5	20.95	113.32	78.9	836.4	1807.7
53.00	Top - Section 1	0.3750	49.884	59.225	18339.4	24.87	133.02	0.0	0.0	1308.9
55.00		0.3750	49.474	58.734	17887.4	24.65	131.93	74.7	709.2	401.4
60.00		0.3750	48.449	57.508	16790.3	24.11	129.20	75.3	679.8	988.9
65.00		0.3750	47.424	56.282	15738.9	23.56	126.46	75.9	651.0	968.0
70.00		0.3750	46.398	55.056	14732.4	23.02	123.73	76.5	622.8	947.1
75.00		0.3750	45.373	53.829	13769.7	22.48	121.00	77.1	595.3	926.3
80.00		0.3750	44.348	52.603	12849.9	21.93	118.26	77.8	568.4	905.4
85.00		0.3750	43.323	51.377	11972.0	21.39	115.53	78.4	542.1	884.5
90.00		0.3750	42.298	50.150	11135.1	20.84	112.79	79.0	516.4	863.7
92.92	Bot - Section 3	0.3750	41.700	49.435	10665.4	20.53	111.20	79.3	501.7	494.2
95.00		0.3750	41.273	48.924	10338.1	20.30	110.06	79.6	491.3	644.5
98.92	Top - Section 2	0.3130	41.096	40.720	8556.2	24.53	131.30	0.0	0.0	1193.7
100.00		0.3130	40.874	40.499	8417.2	24.38	130.59	75.0	403.9	149.7
105.00		0.3130	39.849	39.475	7795.0	23.73	127.31	75.7	383.7	680.3
110.00		0.3130	38.824	38.452	7204.2	23.08	124.04	76.5	364.0	662.9
115.00		0.3130	37.798	37.428	6644.1	22.43	120.76	77.2	344.8	645.5
120.00		0.3130	36.773	36.405	6113.8	21.78	117.49	77.9	326.1	628.1
125.00		0.3130	35.748	35.381	5612.5	21.13	114.21	78.7	308.0	610.7
127.09	Bot - Section 4	0.3130	35.320	34.954	5411.6	20.85	112.84	79.0	300.5	249.7
130.00		0.3130	34.723	34.357	5139.3	20.48	110.94	79.4	290.3	587.6
132.34	Top - Section 3	0.2190	34.682	24.076	3612.5	29.91	158.37	0.0	0.0	464.0
135.00		0.2190	34.136	23.695	3443.5	29.41	155.87	69.3	197.9	216.5
140.00		0.2190	33.111	22.979	3140.6	28.48	151.19	70.3	186.1	397.0
145.00		0.2190	32.086	22.262	2856.0	27.55	146.51	71.4	174.6	384.9
150.00		0.2190	31.061	21.546	2589.2	26.62	141.83	72.5	163.5	372.7
155.00		0.2190	30.036	20.830	2339.5	25.69	137.15	73.5	152.8	360.5
160.00		0.2190	29.010	20.114	2106.4	24.76	132.47	74.6	142.4	348.3
164.50		0.2190	28.088	19.469	1910.3	23.92	128.25	75.5	133.4	303.1
165.00		0.2190	27.985	19.398	1889.3	23.83	127.79	75.6	132.4	33.1
170.00		0.2190	26.960	18.682	1687.7	22.90	123.11	76.7	122.8	323.9
175.00		0.2190	25.935	17.966	1500.9	21.96	118.43	77.7	113.5	311.8
180.00		0.2190	24.910	17.249	1328.5	21.03	113.74	78.8	104.6	299.6

32366.5

Wind Loading - Shaft

Structure: CT02220-S-SBA	Code: EIA/TIA-222-G	5/23/2018
Site Name: Colchester 2 CT	Exposure: B	
Height: 180.00 (ft)	Crest Height: 0.00	
Base Elev: 0.000 (ft)	Site Class: D - Stiff Soil	
Gh: 1.1	Topography: 1	Struct Class: II



Page: 7

Load Case: 1.2D + 1.6W 101 mph Wind

Dead Load Factor 1.20
Wind Load Factor 1.60

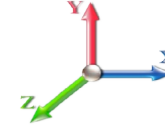

Iterations 24

Elev (ft)	Description	Kzt	Kz	qz (psf)	qzGh (psf)	C (mph-ft)	Cf	Ice Thick (in)	Tributary (ft)	Aa (sf)	CfAa (sf)	Wind Force X (lb)	Dead Load Ice (lb)	Tot Dead Load (lb)
0.00		1.00	0.70	17.366	19.10	430.79	0.750	0.000	0.00	0.000	0.00	0.0	0.0	0.0
5.00		1.00	0.70	17.366	19.10	423.43	0.750	0.000	5.00	25.272	18.95	579.3	0.0	1688.3
10.00		1.00	0.70	17.366	19.10	416.07	0.750	0.000	5.00	24.837	18.63	569.3	0.0	1659.0
15.00		1.00	0.70	17.366	19.10	408.71	0.750	0.000	5.00	24.401	18.30	559.4	0.0	1629.7
20.00		1.00	0.70	17.366	19.10	401.35	0.750	0.000	5.00	23.966	17.97	549.4	0.0	1600.4
25.00		1.00	0.70	17.366	19.10	393.99	0.750	0.000	5.00	23.530	17.65	539.4	0.0	1571.1
30.00		1.00	0.70	17.381	19.12	386.79	0.750	0.000	5.00	23.095	17.32	529.9	0.0	1541.7
35.00		1.00	0.73	18.163	19.98	387.88	0.750	0.000	5.00	22.659	16.99	543.3	0.0	1512.4
40.00		1.00	0.76	18.870	20.76	387.68	0.750	0.000	5.00	22.224	16.67	553.5	0.0	1483.1
45.00		1.00	0.79	19.516	21.47	386.45	0.750	0.000	5.00	21.788	16.34	561.3	0.0	1453.8
45.92 Bot - Section 2		1.00	0.79	19.628	21.59	386.13	0.750	0.000	0.92	3.947	2.96	102.3	0.0	263.4
50.00		1.00	0.81	20.112	22.12	384.39	0.750	0.000	4.08	17.666	13.25	469.0	0.0	2169.3
53.00 Top - Section 1		1.00	0.82	20.450	22.49	382.81	0.750	0.000	3.00	12.794	9.60	345.3	0.0	1570.6
55.00		1.00	0.83	20.667	22.73	387.51	0.750	0.000	2.00	8.442	6.33	230.3	0.0	481.7
60.00 Appurtenance(s)		1.00	0.85	21.187	23.31	384.22	0.750	0.000	5.00	20.800	15.60	581.7	0.0	1186.6
65.00		1.00	0.87	21.678	23.85	380.42	0.750	0.000	5.00	20.365	15.27	582.7	0.0	1161.6
70.00		1.00	0.89	22.142	24.36	376.16	0.750	0.000	5.00	19.929	14.95	582.5	0.0	1136.6
75.00		1.00	0.91	22.582	24.84	371.49	0.750	0.000	5.00	19.494	14.62	581.1	0.0	1111.5
80.00		1.00	0.93	23.003	25.30	366.46	0.750	0.000	5.00	19.058	14.29	578.7	0.0	1086.5
85.00		1.00	0.94	23.404	25.74	361.10	0.750	0.000	5.00	18.623	13.97	575.3	0.0	1061.5
90.00		1.00	0.96	23.790	26.17	355.45	0.750	0.000	5.00	18.187	13.64	571.1	0.0	1036.4
92.92 Bot - Section 3		1.00	0.97	24.008	26.41	352.03	0.750	0.000	2.92	10.408	7.81	329.8	0.0	593.0
95.00		1.00	0.97	24.160	26.58	349.52	0.750	0.000	2.08	7.454	5.59	237.7	0.0	773.4
98.92 Top - Section 2		1.00	0.99	24.441	26.88	344.71	0.750	0.000	3.92	13.810	10.36	445.5	0.0	1432.4
100.00		1.00	0.99	24.517	26.97	348.69	0.750	0.000	1.08	3.773	2.83	122.1	0.0	179.6
105.00		1.00	1.00	24.861	27.35	342.32	0.750	0.000	5.00	17.147	12.86	562.7	0.0	816.4
110.00		1.00	1.02	25.194	27.71	335.74	0.750	0.000	5.00	16.711	12.53	555.7	0.0	795.5
115.00		1.00	1.03	25.516	28.07	328.96	0.750	0.000	5.00	16.276	12.21	548.2	0.0	774.6
120.00		1.00	1.04	25.828	28.41	321.99	0.750	0.000	5.00	15.840	11.88	540.0	0.0	753.7
125.00		1.00	1.05	26.131	28.74	314.84	0.750	0.000	5.00	15.405	11.55	531.3	0.0	732.8
127.09 Bot - Section 4		1.00	1.06	26.255	28.88	311.81	0.750	0.000	2.09	6.300	4.73	218.3	0.0	299.6
130.00		1.00	1.07	26.425	29.07	307.53	0.750	0.000	2.91	8.777	6.58	306.2	0.0	705.1
132.34 Top - Section 3		1.00	1.07	26.560	29.22	304.06	0.750	0.000	2.34	6.933	5.20	243.1	0.0	556.9
135.00		1.00	1.08	26.712	29.38	303.97	0.750	0.000	2.66	7.787	5.84	274.5	0.0	259.8
140.00		1.00	1.09	26.991	29.69	296.38	0.750	0.000	5.00	14.284	10.71	508.9	0.0	476.5
145.00		1.00	1.10	27.263	29.99	288.64	0.750	0.000	5.00	13.849	10.39	498.4	0.0	461.8
150.00		1.00	1.11	27.528	30.28	280.78	0.750	0.000	5.00	13.413	10.06	487.4	0.0	447.2
155.00		1.00	1.12	27.787	30.57	272.79	0.750	0.000	5.00	12.978	9.73	476.0	0.0	432.6
160.00		1.00	1.13	28.040	30.84	264.67	0.750	0.000	5.00	12.542	9.41	464.2	0.0	418.0
164.50 Appurtenance(s)		1.00	1.14	28.264	31.09	257.27	0.750	0.000	4.50	10.916	8.19	407.2	0.0	363.7
165.00		1.00	1.14	28.288	31.12	256.45	0.750	0.000	0.50	1.191	0.89	44.5	0.0	39.7
170.00		1.00	1.15	28.530	31.38	248.11	0.750	0.000	5.00	11.671	8.75	439.5	0.0	388.7
175.00		1.00	1.16	28.768	31.64	239.66	0.750	0.000	5.00	11.236	8.43	426.7	0.0	374.1
180.00 Appurtenance(s)		1.00	1.17	29.000	31.90	231.12	0.750	0.000	5.00	10.800	8.10	413.4	0.0	359.5
Totals:									180.00			19,266.3		38,839.8

Discrete Appurtenance Forces

Structure: CT02220-S-SBA	Code: EIA/TIA-222-G	5/23/2018
Site Name: Colchester 2 CT	Exposure: B	
Height: 180.00 (ft)	Crest Height: 0.00	
Base Elev: 0.000 (ft)	Site Class: D - Stiff Soil	
Gh: 1.1	Topography: 1	Struct Class: II



Page: 8

Load Case: 1.2D + 1.6W 101 mph Wind

Dead Load Factor 1.20
Wind Load Factor 1.60

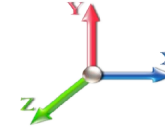

Iterations 24

No.	Elev (ft)	Description	Qty	qz (psf)	qzGh (psf)	CaAa x Ka	Ka	Total CaAa (sf)	Dead Load (lb)	Horiz Ecc (ft)	Vert Ecc (ft)	Wind FX (lb)	Mom Y (lb-ft)	Mom Z (lb-ft)
1	180.00	ALU 1900 Mhz RRUs	3	29.000	31.900	0.67	1.00	7.64	158.40	0.000	0.000	389.85	0.00	0.00
2	180.00	PRK-1245L	1	29.000	31.900	1.00	1.00	11.84	557.89	0.000	0.000	604.32	0.00	0.00
3	180.00	PRK-SFS	1	29.000	31.900	1.00	1.00	13.00	204.00	0.000	0.000	663.52	0.00	0.00
4	180.00	HRK-14	1	29.000	31.900	1.00	1.00	6.00	362.40	0.000	0.000	306.24	0.00	0.00
5	180.00	Low Profile Platform	1	29.000	31.900	1.00	1.00	25.00	1440.00	0.000	0.000	1276.01	0.00	0.00
6	180.00	ALU TD-RRH8x20-25	3	29.000	31.900	0.67	1.00	8.14	252.00	0.000	0.000	415.49	0.00	0.00
7	180.00	ALU 800 Mhz RRUs	6	29.000	31.900	0.67	1.00	10.01	381.60	0.000	0.000	510.90	0.00	0.00
8	180.00	NNVV-65B-R4	3	29.000	31.900	0.74	1.00	27.24	278.64	0.000	0.000	1390.30	0.00	0.00
9	180.00	APXVTM14-C-I20	3	29.000	31.900	0.77	1.00	14.65	202.32	0.000	0.000	747.50	0.00	0.00
10	164.50	Low Profile Platform	1	28.264	31.090	1.00	1.00	25.00	1440.00	0.000	0.000	1243.60	0.00	0.00
11	164.50	782 11056	3	28.264	31.090	0.40	0.80	0.16	10.44	0.000	0.000	7.76	0.00	0.00
12	164.50	LNx-65651DS	3	28.264	31.090	0.64	0.80	22.02	179.28	0.000	0.000	1095.48	0.00	0.00
13	164.50	RR901782DP	3	28.264	31.090	0.54	0.80	7.12	48.60	0.000	0.000	353.95	0.00	0.00
14	60.00	3 ft Standoff	3	21.187	23.306	0.56	0.75	4.44	144.00	0.000	0.000	165.50	0.00	0.00
15	60.00	RRH2x40-AWS	2	21.187	23.306	0.54	0.80	2.32	105.60	0.000	0.000	86.35	0.00	0.00
16	60.00	HBX-6513DS-A1M	2	21.187	23.306	0.64	0.80	2.02	13.68	0.000	0.000	75.42	0.00	0.00
Totals:									5,778.85			9,332.18		

Total Applied Force Summary

Structure: CT02220-S-SBA	Code: EIA/TIA-222-G	5/23/2018
Site Name: Colchester 2 CT	Exposure: B	
Height: 180.00 (ft)	Crest Height: 0.00	
Base Elev: 0.000 (ft)	Site Class: D - Stiff Soil	
Gh: 1.1	Topography: 1	Struct Class: II



Page: 9

Load Case: 1.2D + 1.6W 101 mph Wind

Dead Load Factor 1.20
Wind Load Factor 1.60

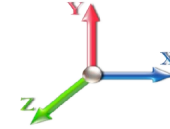

Iterations 24

Elev (ft)	Description	Lateral FX (-) (lb)	Axial FY (-) (lb)	Torsion MY (lb-ft)	Moment MZ (lb-ft)
0.00		0.00	0.00	0.00	0.00
5.00		579.32	1792.67	0.00	0.00
10.00		569.34	1763.36	0.00	0.00
15.00		559.35	1734.05	0.00	0.00
20.00		549.37	1704.74	0.00	0.00
25.00		539.39	1675.43	0.00	0.00
30.00		529.85	1646.12	0.00	0.00
35.00		543.27	1616.81	0.00	0.00
40.00		553.55	1587.50	0.00	0.00
45.00		561.27	1558.19	0.00	0.00
45.92		102.27	282.49	0.00	0.00
50.00		468.98	2254.51	0.00	0.00
53.00		345.35	1633.27	0.00	0.00
55.00		230.30	523.42	0.00	0.00
60.00	(7) attachments	908.99	1554.30	0.00	0.00
65.00		582.72	1259.38	0.00	0.00
70.00		582.47	1234.35	0.00	0.00
75.00		581.08	1209.31	0.00	0.00
80.00		578.67	1184.27	0.00	0.00
85.00		575.33	1159.23	0.00	0.00
90.00		571.12	1134.20	0.00	0.00
92.92		329.83	650.05	0.00	0.00
95.00		237.73	814.15	0.00	0.00
98.92		445.52	1509.01	0.00	0.00
100.00		122.09	200.83	0.00	0.00
105.00		562.69	914.18	0.00	0.00
110.00		555.74	893.28	0.00	0.00
115.00		548.18	872.38	0.00	0.00
120.00		540.03	851.48	0.00	0.00
125.00		531.35	830.59	0.00	0.00
127.09		218.34	340.45	0.00	0.00
130.00		306.17	762.12	0.00	0.00
132.34		243.07	602.55	0.00	0.00
135.00		274.55	311.84	0.00	0.00
140.00		508.92	574.23	0.00	0.00
145.00		498.37	559.61	0.00	0.00
150.00		487.40	544.99	0.00	0.00
155.00		476.01	530.37	0.00	0.00
160.00		464.23	515.75	0.00	0.00
164.50	(10) attachments	3108.03	2129.99	0.00	0.00
165.00		44.48	41.97	0.00	0.00
170.00		439.54	411.62	0.00	0.00
175.00		426.66	397.00	0.00	0.00
180.00	(22) attachments	6717.57	4219.63	0.00	0.00
Totals:		28,598.50	47,985.70	0.00	0.00

Calculated Forces

Structure: CT02220-S-SBA	Code: EIA/TIA-222-G	5/23/2018
Site Name: Colchester 2 CT	Exposure: B	
Height: 180.00 (ft)	Crest Height: 0.00	
Base Elev: 0.000 (ft)	Site Class: D - Stiff Soil	
Gh: 1.1	Topography: 1	Struct Class: II



Page: 10

Load Case: 1.2D + 1.6W 101 mph Wind

Iterations 24

Dead Load Factor 1.20
Wind Load Factor 1.60

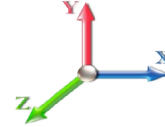

Seg Elev (ft)	Pu FY (-) (kips)	Vu FX (-) (kips)	Tu MY (-) (ft-kips)	Mu MZ (ft-kips)	Mu MX (ft-kips)	Resultant Moment (ft-kips)	phi Pn (kips)	phi Vn (kips)	phi Tn (ft-kips)	phi Mn (ft-kips)	Total Deflect (in)	Rotation Sway (deg)	Rotation Twist (deg)	Stress Ratio
0.00	-47.95	-28.65	0.00	-3421.6	0.00	3421.69	5525.87	2762.94	13590.7	6747.00	0.00	0.000	0.000	0.516
5.00	-46.10	-28.17	0.00	-3278.4	0.00	3278.44	5469.54	2734.77	13218.9	6562.44	0.07	-0.127	0.000	0.508
10.00	-44.27	-27.70	0.00	-3137.5	0.00	3137.57	5411.85	2705.92	12848.7	6378.66	0.27	-0.256	0.000	0.500
15.00	-42.48	-27.23	0.00	-2999.0	0.00	2999.09	5352.80	2676.40	12480.3	6195.75	0.61	-0.386	0.000	0.492
20.00	-40.72	-26.76	0.00	-2862.9	0.00	2862.96	5292.39	2646.19	12113.8	6013.80	1.08	-0.517	0.000	0.484
25.00	-38.99	-26.29	0.00	-2729.1	0.00	2729.18	5230.62	2615.31	11749.3	5832.89	1.70	-0.648	0.000	0.475
30.00	-37.29	-25.83	0.00	-2597.7	0.00	2597.73	5167.50	2583.75	11387.2	5653.11	2.45	-0.781	0.000	0.467
35.00	-35.62	-25.34	0.00	-2468.6	0.00	2468.61	5103.02	2551.51	11027.5	5474.55	3.34	-0.915	0.000	0.458
40.00	-33.99	-24.84	0.00	-2341.8	0.00	2341.89	5037.18	2518.59	10670.5	5297.29	4.37	-1.049	0.000	0.449
45.00	-32.41	-24.30	0.00	-2217.6	0.00	2217.69	4969.98	2484.99	10316.2	5121.42	5.54	-1.185	0.000	0.440
45.92	-32.10	-24.23	0.00	-2195.4	0.00	2195.42	4957.51	2478.76	10251.6	5089.33	5.77	-1.210	0.000	0.438
50.00	-29.81	-23.76	0.00	-2096.4	0.00	2096.49	4901.42	2450.71	9964.95	4947.02	6.85	-1.322	0.000	0.430
53.00	-28.16	-23.41	0.00	-2025.2	0.00	2025.22	3967.43	1983.71	8109.29	4025.79	7.71	-1.405	0.000	0.510
55.00	-27.60	-23.22	0.00	-1978.4	0.00	1978.41	3947.58	1973.79	8001.39	3972.23	8.31	-1.461	0.000	0.505
60.00	-26.01	-22.33	0.00	-1862.3	0.00	1862.33	3897.00	1948.50	7732.70	3838.84	9.92	-1.613	0.000	0.492
65.00	-24.71	-21.78	0.00	-1750.6	0.00	1750.66	3845.06	1922.53	7465.70	3706.29	11.69	-1.766	0.000	0.479
70.00	-23.44	-21.22	0.00	-1641.7	0.00	1641.76	3791.77	1895.89	7200.54	3574.65	13.63	-1.920	0.000	0.466
75.00	-22.20	-20.66	0.00	-1535.6	0.00	1535.66	3737.12	1868.56	6937.41	3444.02	15.72	-2.073	0.000	0.452
80.00	-20.98	-20.09	0.00	-1432.3	0.00	1432.37	3681.11	1840.56	6676.48	3314.49	17.97	-2.226	0.000	0.438
85.00	-19.79	-19.52	0.00	-1331.9	0.00	1331.91	3623.74	1811.87	6417.92	3186.13	20.39	-2.379	0.000	0.424
90.00	-18.64	-18.94	0.00	-1234.3	0.00	1234.30	3565.02	1782.51	6161.91	3059.03	22.96	-2.532	0.000	0.409
92.92	-17.99	-18.61	0.00	-1179.0	0.00	1179.05	3530.13	1765.07	6013.81	2985.51	24.53	-2.622	0.000	0.400
95.00	-17.15	-18.36	0.00	-1140.2	0.00	1140.28	3504.93	1752.47	5908.61	2933.28	25.69	-2.686	0.000	0.394
98.92	-15.64	-17.86	0.00	-1068.3	0.00	1068.36	2742.07	1371.04	4616.42	2291.78	27.94	-2.805	0.000	0.472
100.00	-15.42	-17.76	0.00	-1049.0	0.00	1049.01	2732.96	1366.48	4575.83	2271.63	28.58	-2.839	0.000	0.468
105.00	-14.48	-17.19	0.00	-960.21	0.00	960.21	2690.08	1345.04	4389.32	2179.04	31.65	-3.008	0.000	0.446
110.00	-13.57	-16.63	0.00	-874.24	0.00	874.24	2645.83	1322.92	4204.31	2087.20	34.89	-3.176	0.000	0.424
115.00	-12.69	-16.07	0.00	-791.09	0.00	791.09	2600.23	1300.12	4020.98	1996.19	38.30	-3.340	0.000	0.401
120.00	-11.83	-15.51	0.00	-710.74	0.00	710.74	2553.28	1276.64	3839.50	1906.09	41.88	-3.501	0.000	0.378
125.00	-11.00	-14.95	0.00	-633.17	0.00	633.17	2504.96	1252.48	3660.03	1816.99	45.63	-3.657	0.000	0.353
127.09	-10.66	-14.73	0.00	-601.98	0.00	601.98	2484.39	1242.20	3585.78	1780.13	47.25	-3.723	0.000	0.343
130.00	-9.90	-14.38	0.00	-559.07	0.00	559.07	2455.29	1227.64	3482.76	1728.99	49.54	-3.812	0.000	0.328
132.34	-9.29	-14.11	0.00	-525.46	0.00	525.46	1489.26	744.63	2121.49	1053.20	51.43	-3.882	0.000	0.506
135.00	-8.97	-13.84	0.00	-487.87	0.00	487.87	1477.63	738.82	2071.36	1028.31	53.61	-3.960	0.000	0.481
140.00	-8.39	-13.32	0.00	-418.67	0.00	418.67	1454.76	727.38	1977.27	981.60	57.86	-4.147	0.000	0.433
145.00	-7.83	-12.80	0.00	-352.09	0.00	352.09	1430.53	715.26	1883.34	934.97	62.29	-4.322	0.000	0.382
150.00	-7.29	-12.29	0.00	-288.07	0.00	288.07	1404.94	702.47	1789.74	888.50	66.90	-4.481	0.000	0.330
155.00	-6.77	-11.79	0.00	-226.60	0.00	226.60	1377.99	688.99	1696.65	842.29	71.67	-4.622	0.000	0.274
160.00	-6.28	-11.30	0.00	-167.64	0.00	167.64	1349.68	674.84	1604.25	796.42	76.57	-4.742	0.000	0.215
164.50	-4.41	-8.03	0.00	-116.79	0.00	116.79	1323.05	661.52	1521.82	755.50	81.08	-4.829	0.000	0.158
165.00	-4.37	-7.98	0.00	-112.78	0.00	112.78	1320.02	660.01	1512.71	750.97	81.59	-4.837	0.000	0.154
170.00	-3.99	-7.51	0.00	-72.86	0.00	72.86	1289.00	644.50	1422.20	706.04	86.69	-4.907	0.000	0.106
175.00	-3.62	-7.06	0.00	-35.29	0.00	35.29	1256.62	628.31	1332.89	661.70	91.85	-4.953	0.000	0.056
180.00	0.00	-6.72	0.00	0.00	0.00	0.00	1222.88	611.44	1244.96	618.05	97.04	-4.969	0.000	0.000

Wind Loading - Shaft

Structure: CT02220-S-SBA	Code: EIA/TIA-222-G	5/23/2018
Site Name: Colchester 2 CT	Exposure: B	
Height: 180.00 (ft)	Crest Height: 0.00	
Base Elev: 0.000 (ft)	Site Class: D - Stiff Soil	
Gh: 1.1	Topography: 1	Struct Class: II



Load Case: 0.9D + 1.6W 101 mph Wind	Iterations 24
Dead Load Factor 0.90	
Wind Load Factor 1.60	

Elev (ft)	Description	Kzt	Kz	qz (psf)	qzGh (psf)	C (mph-ft)	Cf	Ice Thick (in)	Tributary (ft)	Aa (sf)	CfAa (sf)	Wind Force X (lb)	Dead Load Ice (lb)	Tot Dead Load (lb)
0.00		1.00	0.70	17.366	19.10	430.79	0.750	0.000	0.00	0.000	0.00	0.0	0.0	0.0
5.00		1.00	0.70	17.366	19.10	423.43	0.750	0.000	5.00	25.272	18.95	579.3	0.0	1266.2
10.00		1.00	0.70	17.366	19.10	416.07	0.750	0.000	5.00	24.837	18.63	569.3	0.0	1244.2
15.00		1.00	0.70	17.366	19.10	408.71	0.750	0.000	5.00	24.401	18.30	559.4	0.0	1222.3
20.00		1.00	0.70	17.366	19.10	401.35	0.750	0.000	5.00	23.966	17.97	549.4	0.0	1200.3
25.00		1.00	0.70	17.366	19.10	393.99	0.750	0.000	5.00	23.530	17.65	539.4	0.0	1178.3
30.00		1.00	0.70	17.381	19.12	386.79	0.750	0.000	5.00	23.095	17.32	529.9	0.0	1156.3
35.00		1.00	0.73	18.163	19.98	387.88	0.750	0.000	5.00	22.659	16.99	543.3	0.0	1134.3
40.00		1.00	0.76	18.870	20.76	387.68	0.750	0.000	5.00	22.224	16.67	553.5	0.0	1112.3
45.00		1.00	0.79	19.516	21.47	386.45	0.750	0.000	5.00	21.788	16.34	561.3	0.0	1090.4
45.92 Bot - Section 2		1.00	0.79	19.628	21.59	386.13	0.750	0.000	0.92	3.947	2.96	102.3	0.0	197.5
50.00		1.00	0.81	20.112	22.12	384.39	0.750	0.000	4.08	17.666	13.25	469.0	0.0	1626.9
53.00 Top - Section 1		1.00	0.82	20.450	22.49	382.81	0.750	0.000	3.00	12.794	9.60	345.3	0.0	1178.0
55.00		1.00	0.83	20.667	22.73	387.51	0.750	0.000	2.00	8.442	6.33	230.3	0.0	361.3
60.00 Appurtenance(s)		1.00	0.85	21.187	23.31	384.22	0.750	0.000	5.00	20.800	15.60	581.7	0.0	890.0
65.00		1.00	0.87	21.678	23.85	380.42	0.750	0.000	5.00	20.365	15.27	582.7	0.0	871.2
70.00		1.00	0.89	22.142	24.36	376.16	0.750	0.000	5.00	19.929	14.95	582.5	0.0	852.4
75.00		1.00	0.91	22.582	24.84	371.49	0.750	0.000	5.00	19.494	14.62	581.1	0.0	833.6
80.00		1.00	0.93	23.003	25.30	366.46	0.750	0.000	5.00	19.058	14.29	578.7	0.0	814.9
85.00		1.00	0.94	23.404	25.74	361.10	0.750	0.000	5.00	18.623	13.97	575.3	0.0	796.1
90.00		1.00	0.96	23.790	26.17	355.45	0.750	0.000	5.00	18.187	13.64	571.1	0.0	777.3
92.92 Bot - Section 3		1.00	0.97	24.008	26.41	352.03	0.750	0.000	2.92	10.408	7.81	329.8	0.0	444.8
95.00		1.00	0.97	24.160	26.58	349.52	0.750	0.000	2.08	7.454	5.59	237.7	0.0	580.1
98.92 Top - Section 2		1.00	0.99	24.441	26.88	344.71	0.750	0.000	3.92	13.810	10.36	445.5	0.0	1074.3
100.00		1.00	0.99	24.517	26.97	348.69	0.750	0.000	1.08	3.773	2.83	122.1	0.0	134.7
105.00		1.00	1.00	24.861	27.35	342.32	0.750	0.000	5.00	17.147	12.86	562.7	0.0	612.3
110.00		1.00	1.02	25.194	27.71	335.74	0.750	0.000	5.00	16.711	12.53	555.7	0.0	596.6
115.00		1.00	1.03	25.516	28.07	328.96	0.750	0.000	5.00	16.276	12.21	548.2	0.0	581.0
120.00		1.00	1.04	25.828	28.41	321.99	0.750	0.000	5.00	15.840	11.88	540.0	0.0	565.3
125.00		1.00	1.05	26.131	28.74	314.84	0.750	0.000	5.00	15.405	11.55	531.3	0.0	549.6
127.09 Bot - Section 4		1.00	1.06	26.255	28.88	311.81	0.750	0.000	2.09	6.300	4.73	218.3	0.0	224.7
130.00		1.00	1.07	26.425	29.07	307.53	0.750	0.000	2.91	8.777	6.58	306.2	0.0	528.9
132.34 Top - Section 3		1.00	1.07	26.560	29.22	304.06	0.750	0.000	2.34	6.933	5.20	243.1	0.0	417.6
135.00		1.00	1.08	26.712	29.38	303.97	0.750	0.000	2.66	7.787	5.84	274.5	0.0	194.8
140.00		1.00	1.09	26.991	29.69	296.38	0.750	0.000	5.00	14.284	10.71	508.9	0.0	357.3
145.00		1.00	1.10	27.263	29.99	288.64	0.750	0.000	5.00	13.849	10.39	498.4	0.0	346.4
150.00		1.00	1.11	27.528	30.28	280.78	0.750	0.000	5.00	13.413	10.06	487.4	0.0	335.4
155.00		1.00	1.12	27.787	30.57	272.79	0.750	0.000	5.00	12.978	9.73	476.0	0.0	324.4
160.00		1.00	1.13	28.040	30.84	264.67	0.750	0.000	5.00	12.542	9.41	464.2	0.0	313.5
164.50 Appurtenance(s)		1.00	1.14	28.264	31.09	257.27	0.750	0.000	4.50	10.916	8.19	407.2	0.0	272.8
165.00		1.00	1.14	28.288	31.12	256.45	0.750	0.000	0.50	1.191	0.89	44.5	0.0	29.8
170.00		1.00	1.15	28.530	31.38	248.11	0.750	0.000	5.00	11.671	8.75	439.5	0.0	291.5
175.00		1.00	1.16	28.768	31.64	239.66	0.750	0.000	5.00	11.236	8.43	426.7	0.0	280.6
180.00 Appurtenance(s)		1.00	1.17	29.000	31.90	231.12	0.750	0.000	5.00	10.800	8.10	413.4	0.0	269.6
Totals:									180.00			19,266.3		29,129.9

Discrete Appurtenance Forces

Structure: CT02220-S-SBA	Code: EIA/TIA-222-G	5/23/2018
Site Name: Colchester 2 CT	Exposure: B	
Height: 180.00 (ft)	Crest Height: 0.00	
Base Elev: 0.000 (ft)	Site Class: D - Stiff Soil	
Gh: 1.1	Topography: 1	Struct Class: II



Page: 12

Load Case: 0.9D + 1.6W 101 mph Wind

Dead Load Factor 0.90
Wind Load Factor 1.60

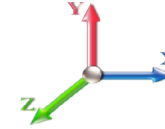

Iterations 24

No.	Elev (ft)	Description	Qty	qz (psf)	qzGh (psf)	CaAa x Ka	Ka	Total CaAa (sf)	Dead Load (lb)	Horiz Ecc (ft)	Vert Ecc (ft)	Wind FX (lb)	Mom Y (lb-ft)	Mom Z (lb-ft)
1	180.00	ALU 1900 Mhz RRUs	3	29.000	31.900	0.67	1.00	7.64	118.80	0.000	0.000	389.85	0.00	0.00
2	180.00	PRK-1245L	1	29.000	31.900	1.00	1.00	11.84	418.42	0.000	0.000	604.32	0.00	0.00
3	180.00	PRK-SFS	1	29.000	31.900	1.00	1.00	13.00	153.00	0.000	0.000	663.52	0.00	0.00
4	180.00	HRK-14	1	29.000	31.900	1.00	1.00	6.00	271.80	0.000	0.000	306.24	0.00	0.00
5	180.00	Low Profile Platform	1	29.000	31.900	1.00	1.00	25.00	1080.00	0.000	0.000	1276.01	0.00	0.00
6	180.00	ALU TD-RRH8x20-25	3	29.000	31.900	0.67	1.00	8.14	189.00	0.000	0.000	415.49	0.00	0.00
7	180.00	ALU 800 Mhz RRUs	6	29.000	31.900	0.67	1.00	10.01	286.20	0.000	0.000	510.90	0.00	0.00
8	180.00	NNVV-65B-R4	3	29.000	31.900	0.74	1.00	27.24	208.98	0.000	0.000	1390.30	0.00	0.00
9	180.00	APXVTM14-C-I20	3	29.000	31.900	0.77	1.00	14.65	151.74	0.000	0.000	747.50	0.00	0.00
10	164.50	Low Profile Platform	1	28.264	31.090	1.00	1.00	25.00	1080.00	0.000	0.000	1243.60	0.00	0.00
11	164.50	782 11056	3	28.264	31.090	0.40	0.80	0.16	7.83	0.000	0.000	7.76	0.00	0.00
12	164.50	LNx-65651DS	3	28.264	31.090	0.64	0.80	22.02	134.46	0.000	0.000	1095.48	0.00	0.00
13	164.50	RR901782DP	3	28.264	31.090	0.54	0.80	7.12	36.45	0.000	0.000	353.95	0.00	0.00
14	60.00	3 ft Standoff	3	21.187	23.306	0.56	0.75	4.44	108.00	0.000	0.000	165.50	0.00	0.00
15	60.00	RRH2x40-AWS	2	21.187	23.306	0.54	0.80	2.32	79.20	0.000	0.000	86.35	0.00	0.00
16	60.00	HBX-6513DS-A1M	2	21.187	23.306	0.64	0.80	2.02	10.26	0.000	0.000	75.42	0.00	0.00
Totals:									4,334.14			9,332.18		

Total Applied Force Summary

Structure: CT02220-S-SBA	Code: EIA/TIA-222-G	5/23/2018
Site Name: Colchester 2 CT	Exposure: B	
Height: 180.00 (ft)	Crest Height: 0.00	
Base Elev: 0.000 (ft)	Site Class: D - Stiff Soil	
Gh: 1.1	Topography: 1	Struct Class: II



Page: 13

Load Case: 0.9D + 1.6W 101 mph Wind

Dead Load Factor 0.90
Wind Load Factor 1.60

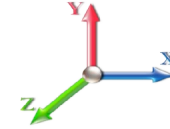

Iterations 24

Elev (ft)	Description	Lateral FX (-) (lb)	Axial FY (-) (lb)	Torsion MY (lb-ft)	Moment MZ (lb-ft)
0.00		0.00	0.00	0.00	0.00
5.00		579.32	1344.50	0.00	0.00
10.00		569.34	1322.52	0.00	0.00
15.00		559.35	1300.54	0.00	0.00
20.00		549.37	1278.56	0.00	0.00
25.00		539.39	1256.57	0.00	0.00
30.00		529.85	1234.59	0.00	0.00
35.00		543.27	1212.61	0.00	0.00
40.00		553.55	1190.63	0.00	0.00
45.00		561.27	1168.65	0.00	0.00
45.92		102.27	211.87	0.00	0.00
50.00		468.98	1690.88	0.00	0.00
53.00		345.35	1224.96	0.00	0.00
55.00		230.30	392.56	0.00	0.00
60.00	(7) attachments	908.99	1165.72	0.00	0.00
65.00		582.72	944.54	0.00	0.00
70.00		582.47	925.76	0.00	0.00
75.00		581.08	906.98	0.00	0.00
80.00		578.67	888.20	0.00	0.00
85.00		575.33	869.43	0.00	0.00
90.00		571.12	850.65	0.00	0.00
92.92		329.83	487.54	0.00	0.00
95.00		237.73	610.61	0.00	0.00
98.92		445.52	1131.76	0.00	0.00
100.00		122.09	150.62	0.00	0.00
105.00		562.69	685.63	0.00	0.00
110.00		555.74	669.96	0.00	0.00
115.00		548.18	654.29	0.00	0.00
120.00		540.03	638.61	0.00	0.00
125.00		531.35	622.94	0.00	0.00
127.09		218.34	255.34	0.00	0.00
130.00		306.17	571.59	0.00	0.00
132.34		243.07	451.91	0.00	0.00
135.00		274.55	233.88	0.00	0.00
140.00		508.92	430.67	0.00	0.00
145.00		498.37	419.71	0.00	0.00
150.00		487.40	408.74	0.00	0.00
155.00		476.01	397.78	0.00	0.00
160.00		464.23	386.81	0.00	0.00
164.50	(10) attachments	3108.03	1597.49	0.00	0.00
165.00		44.48	31.47	0.00	0.00
170.00		439.54	308.72	0.00	0.00
175.00		426.66	297.75	0.00	0.00
180.00	(22) attachments	6717.57	3164.73	0.00	0.00
	Totals:	28,598.50	35,989.27	0.00	0.00

Calculated Forces

Structure: CT02220-S-SBA	Code: EIA/TIA-222-G	5/23/2018
Site Name: Colchester 2 CT	Exposure: B	
Height: 180.00 (ft)	Crest Height: 0.00	
Base Elev: 0.000 (ft)	Site Class: D - Stiff Soil	
Gh: 1.1	Topography: 1	Struct Class: II



Page: 14

Load Case: 0.9D + 1.6W 101 mph Wind

Iterations 24

Dead Load Factor 0.90
Wind Load Factor 1.60

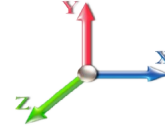

Seg Elev (ft)	Pu FY (-) (kips)	Vu FX (-) (kips)	Tu MY (-) (ft-kips)	Mu MZ (ft-kips)	Mu MX (ft-kips)	Resultant Moment (ft-kips)	phi Pn (kips)	phi Vn (kips)	phi Tn (ft-kips)	phi Mn (ft-kips)	Total Deflect (in)	Rotation Sway (deg)	Rotation Twist (deg)	Stress Ratio
0.00	-35.96	-28.64	0.00	-3391.7	0.00	3391.75	5525.87	2762.94	13590.7	6747.00	0.00	0.000	0.000	0.509
5.00	-34.55	-28.13	0.00	-3248.5	0.00	3248.56	5469.54	2734.77	13218.9	6562.44	0.07	-0.126	0.000	0.501
10.00	-33.17	-27.63	0.00	-3107.8	0.00	3107.89	5411.85	2705.92	12848.7	6378.66	0.27	-0.254	0.000	0.493
15.00	-31.81	-27.14	0.00	-2969.7	0.00	2969.72	5352.80	2676.40	12480.3	6195.75	0.60	-0.382	0.000	0.485
20.00	-30.48	-26.65	0.00	-2834.0	0.00	2834.03	5292.39	2646.19	12113.8	6013.80	1.07	-0.512	0.000	0.477
25.00	-29.16	-26.16	0.00	-2700.7	0.00	2700.79	5230.62	2615.31	11749.3	5832.89	1.68	-0.642	0.000	0.469
30.00	-27.88	-25.68	0.00	-2569.9	0.00	2569.97	5167.50	2583.75	11387.2	5653.11	2.42	-0.773	0.000	0.460
35.00	-26.62	-25.18	0.00	-2441.5	0.00	2441.56	5103.02	2551.51	11027.5	5474.55	3.30	-0.906	0.000	0.451
40.00	-25.38	-24.67	0.00	-2315.6	0.00	2315.65	5037.18	2518.59	10670.5	5297.29	4.32	-1.039	0.000	0.442
45.00	-24.19	-24.12	0.00	-2192.3	0.00	2192.30	4969.98	2484.99	10316.2	5121.42	5.48	-1.173	0.000	0.433
45.92	-23.95	-24.04	0.00	-2170.2	0.00	2170.20	4957.51	2478.76	10251.6	5089.33	5.71	-1.198	0.000	0.431
50.00	-22.23	-23.57	0.00	-2072.0	0.00	2072.03	4901.42	2450.71	9964.95	4947.02	6.78	-1.308	0.000	0.423
53.00	-20.98	-23.22	0.00	-2001.3	0.00	2001.32	3967.43	1983.71	8109.29	4025.79	7.63	-1.390	0.000	0.503
55.00	-20.56	-23.02	0.00	-1954.8	0.00	1954.87	3947.58	1973.79	8001.39	3972.23	8.23	-1.445	0.000	0.497
60.00	-19.36	-22.13	0.00	-1839.7	0.00	1839.78	3897.00	1948.50	7732.70	3838.84	9.82	-1.596	0.000	0.484
65.00	-18.37	-21.57	0.00	-1729.1	0.00	1729.12	3845.06	1922.53	7465.70	3706.29	11.58	-1.747	0.000	0.471
70.00	-17.41	-21.00	0.00	-1621.2	0.00	1621.27	3791.77	1895.89	7200.54	3574.65	13.49	-1.899	0.000	0.458
75.00	-16.47	-20.44	0.00	-1516.2	0.00	1516.25	3737.12	1868.56	6937.41	3444.02	15.56	-2.050	0.000	0.445
80.00	-15.55	-19.87	0.00	-1414.0	0.00	1414.07	3681.11	1840.56	6676.48	3314.49	17.78	-2.202	0.000	0.431
85.00	-14.65	-19.30	0.00	-1314.7	0.00	1314.74	3623.74	1811.87	6417.92	3186.13	20.17	-2.353	0.000	0.417
90.00	-13.79	-18.72	0.00	-1218.2	0.00	1218.27	3565.02	1782.51	6161.91	3059.03	22.71	-2.503	0.000	0.402
92.92	-13.29	-18.38	0.00	-1163.6	0.00	1163.68	3530.13	1765.07	6013.81	2985.51	24.27	-2.592	0.000	0.394
95.00	-12.67	-18.14	0.00	-1125.3	0.00	1125.38	3504.93	1752.47	5908.61	2933.28	25.42	-2.655	0.000	0.387
98.92	-11.53	-17.65	0.00	-1054.3	0.00	1054.34	2742.07	1371.04	4616.42	2291.78	27.64	-2.773	0.000	0.464
100.00	-11.36	-17.55	0.00	-1035.2	0.00	1035.21	2732.96	1366.48	4575.83	2271.63	28.28	-2.806	0.000	0.460
105.00	-10.65	-16.98	0.00	-947.49	0.00	947.49	2690.08	1345.04	4389.32	2179.04	31.30	-2.974	0.000	0.439
110.00	-9.97	-16.42	0.00	-862.59	0.00	862.59	2645.83	1322.92	4204.31	2087.20	34.51	-3.139	0.000	0.417
115.00	-9.30	-15.86	0.00	-780.50	0.00	780.50	2600.23	1300.12	4020.98	1996.19	37.88	-3.301	0.000	0.395
120.00	-8.65	-15.31	0.00	-701.20	0.00	701.20	2553.28	1276.64	3839.50	1906.09	41.42	-3.460	0.000	0.371
125.00	-8.03	-14.75	0.00	-624.66	0.00	624.66	2504.96	1252.48	3660.03	1816.99	45.13	-3.614	0.000	0.347
127.09	-7.77	-14.53	0.00	-593.88	0.00	593.88	2484.39	1242.20	3585.78	1780.13	46.72	-3.678	0.000	0.337
130.00	-7.20	-14.20	0.00	-551.55	0.00	551.55	2455.29	1227.64	3482.76	1728.99	48.99	-3.766	0.000	0.322
132.34	-6.75	-13.93	0.00	-518.37	0.00	518.37	1489.26	744.63	2121.49	1053.20	50.85	-3.835	0.000	0.497
135.00	-6.50	-13.66	0.00	-481.27	0.00	481.27	1477.63	738.82	2071.36	1028.31	53.01	-3.912	0.000	0.473
140.00	-6.07	-13.14	0.00	-412.97	0.00	412.97	1454.76	727.38	1977.27	981.60	57.20	-4.097	0.000	0.425
145.00	-5.65	-12.63	0.00	-347.27	0.00	347.27	1430.53	715.26	1883.34	934.97	61.58	-4.269	0.000	0.376
150.00	-5.25	-12.13	0.00	-284.13	0.00	284.13	1404.94	702.47	1789.74	888.50	66.14	-4.426	0.000	0.324
155.00	-4.86	-11.63	0.00	-223.51	0.00	223.51	1377.99	688.99	1696.65	842.29	70.85	-4.566	0.000	0.269
160.00	-4.50	-11.14	0.00	-165.35	0.00	165.35	1349.68	674.84	1604.25	796.42	75.69	-4.684	0.000	0.211
164.50	-3.15	-7.92	0.00	-115.20	0.00	115.20	1323.05	661.52	1521.82	755.50	80.14	-4.769	0.000	0.155
165.00	-3.12	-7.87	0.00	-111.24	0.00	111.24	1320.02	660.01	1512.71	750.97	80.64	-4.777	0.000	0.151
170.00	-2.84	-7.41	0.00	-71.88	0.00	71.88	1289.00	644.50	1422.20	706.04	85.68	-4.846	0.000	0.104
175.00	-2.58	-6.96	0.00	-34.82	0.00	34.82	1256.62	628.31	1332.89	661.70	90.78	-4.891	0.000	0.055
180.00	0.00	-6.72	0.00	0.00	0.00	0.00	1222.88	611.44	1244.96	618.05	95.91	-4.908	0.000	0.000

Wind Loading - Shaft

Structure: CT02220-S-SBA	Code: EIA/TIA-222-G	5/23/2018
Site Name: Colchester 2 CT	Exposure: B	
Height: 180.00 (ft)	Crest Height: 0.00	
Base Elev: 0.000 (ft)	Site Class: D - Stiff Soil	
Gh: 1.1	Topography: 1	Struct Class: II



Load Case: 1.2D + 1.0Di + 1.0Wi 50 mph Wind

Dead Load Factor 1.20
Wind Load Factor 1.00

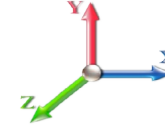

Iterations 24

Elev (ft)	Description	Kzt	Kz	qz (psf)	qzGh (psf)	C (mph-ft)	Cf	Ice Thick (in)	Tributary (ft)	Aa (sf)	CfAa (sf)	Wind Force X (lb)	Dead Load Ice (lb)	Tot Dead Load (lb)
0.00		1.00	0.70	4.256	4.68	0.00	1.200	0.000	0.00	0.000	0.00	0.0	0.0	0.0
5.00		1.00	0.70	4.256	4.68	0.00	1.200	1.242	5.00	26.307	31.57	147.8	472.8	2161.1
10.00		1.00	0.70	4.256	4.68	0.00	1.200	1.331	5.00	25.946	31.14	145.8	498.9	2157.8
15.00		1.00	0.70	4.256	4.68	0.00	1.200	1.386	5.00	25.556	30.67	143.6	511.0	2140.7
20.00		1.00	0.70	4.256	4.68	0.00	1.200	1.427	5.00	25.154	30.19	141.3	517.0	2117.4
25.00		1.00	0.70	4.256	4.68	0.00	1.200	1.459	5.00	24.746	29.69	139.0	519.5	2090.6
30.00		1.00	0.70	4.260	4.69	0.00	1.200	1.486	5.00	24.333	29.20	136.8	519.7	2061.4
35.00		1.00	0.73	4.451	4.90	0.00	1.200	1.509	5.00	23.916	28.70	140.5	518.2	2030.6
40.00		1.00	0.76	4.625	5.09	0.00	1.200	1.529	5.00	23.498	28.20	143.4	515.4	1998.6
45.00		1.00	0.79	4.783	5.26	0.00	1.200	1.547	5.00	23.077	27.69	145.7	511.7	1965.5
45.92 Bot - Section 2		1.00	0.79	4.810	5.29	0.00	1.200	1.550	0.92	4.184	5.02	26.6	93.7	357.0
50.00		1.00	0.81	4.929	5.42	0.00	1.200	1.564	4.08	18.730	22.48	121.9	420.2	2589.5
53.00 Top - Section 1		1.00	0.82	5.012	5.51	0.00	1.200	1.573	3.00	13.580	16.30	89.8	306.9	1877.6
55.00		1.00	0.83	5.065	5.57	0.00	1.200	1.579	2.00	8.968	10.76	60.0	203.8	685.4
60.00 Appurtenance(s)		1.00	0.85	5.193	5.71	0.00	1.200	1.592	5.00	22.127	26.55	151.7	503.6	1690.3
65.00		1.00	0.87	5.313	5.84	0.00	1.200	1.605	5.00	21.702	26.04	152.2	497.4	1659.0
70.00		1.00	0.89	5.426	5.97	0.00	1.200	1.617	5.00	21.277	25.53	152.4	490.8	1627.3
75.00		1.00	0.91	5.534	6.09	0.00	1.200	1.628	5.00	20.851	25.02	152.3	483.7	1595.2
80.00		1.00	0.93	5.637	6.20	0.00	1.200	1.639	5.00	20.424	24.51	152.0	476.3	1562.8
85.00		1.00	0.94	5.736	6.31	0.00	1.200	1.649	5.00	19.997	24.00	151.4	468.6	1530.1
90.00		1.00	0.96	5.830	6.41	0.00	1.200	1.658	5.00	19.569	23.48	150.6	460.7	1497.1
92.92 Bot - Section 3		1.00	0.97	5.884	6.47	0.00	1.200	1.664	2.92	11.217	13.46	87.1	265.9	859.0
95.00		1.00	0.97	5.921	6.51	0.00	1.200	1.667	2.08	8.033	9.64	62.8	191.3	964.7
98.92 Top - Section 2		1.00	0.99	5.990	6.59	0.00	1.200	1.674	3.92	14.902	17.88	117.8	354.4	1786.9
100.00		1.00	0.99	6.008	6.61	0.00	1.200	1.676	1.08	4.075	4.89	32.3	97.6	277.3
105.00		1.00	1.00	6.093	6.70	0.00	1.200	1.684	5.00	18.550	22.26	149.2	442.0	1258.4
110.00		1.00	1.02	6.174	6.79	0.00	1.200	1.692	5.00	18.121	21.75	147.7	433.2	1228.7
115.00		1.00	1.03	6.253	6.88	0.00	1.200	1.699	5.00	17.692	21.23	146.0	424.2	1198.8
120.00		1.00	1.04	6.330	6.96	0.00	1.200	1.707	5.00	17.262	20.71	144.2	415.0	1168.7
125.00		1.00	1.05	6.404	7.04	0.00	1.200	1.714	5.00	16.833	20.20	142.3	405.6	1138.5
127.09 Bot - Section 4		1.00	1.06	6.434	7.08	0.00	1.200	1.717	2.09	6.897	8.28	58.6	167.6	467.3
130.00		1.00	1.07	6.476	7.12	0.00	1.200	1.720	2.91	9.613	11.54	82.2	233.6	938.8
132.34 Top - Section 3		1.00	1.07	6.509	7.16	0.00	1.200	1.723	2.34	7.604	9.13	65.3	185.3	742.1
135.00		1.00	1.08	6.546	7.20	0.00	1.200	1.727	2.66	8.553	10.26	73.9	208.4	468.2
140.00		1.00	1.09	6.615	7.28	0.00	1.200	1.733	5.00	15.729	18.87	137.3	381.6	858.0
145.00		1.00	1.10	6.681	7.35	0.00	1.200	1.739	5.00	15.298	18.36	134.9	371.7	833.5
150.00		1.00	1.11	6.746	7.42	0.00	1.200	1.745	5.00	14.868	17.84	132.4	361.7	808.9
155.00		1.00	1.12	6.810	7.49	0.00	1.200	1.751	5.00	14.437	17.32	129.8	351.6	784.2
160.00		1.00	1.13	6.872	7.56	0.00	1.200	1.757	5.00	14.006	16.81	127.0	341.4	759.4
164.50 Appurtenance(s)		1.00	1.14	6.927	7.62	0.00	1.200	1.761	4.50	12.237	14.68	111.9	298.9	662.6
165.00		1.00	1.14	6.933	7.63	0.00	1.200	1.762	0.50	1.338	1.61	12.2	33.1	72.8
170.00		1.00	1.15	6.992	7.69	0.00	1.200	1.767	5.00	13.144	15.77	121.3	320.7	709.4
175.00		1.00	1.16	7.050	7.76	0.00	1.200	1.772	5.00	12.713	15.26	118.3	310.2	684.3
180.00 Appurtenance(s)		1.00	1.17	7.107	7.82	0.00	1.200	1.777	5.00	12.281	14.74	115.2	299.6	659.1
Totals:									180.00			5,094.6	54,724.5	

Discrete Appurtenance Forces

Structure: CT02220-S-SBA	Code: EIA/TIA-222-G	5/23/2018
Site Name: Colchester 2 CT	Exposure: B	
Height: 180.00 (ft)	Crest Height: 0.00	
Base Elev: 0.000 (ft)	Site Class: D - Stiff Soil	
Gh: 1.1	Topography: 1	Page: 16
	Struct Class: II	



Load Case: 1.2D + 1.0Di + 1.0Wi 50 mph Wind

Dead Load Factor 1.20
Wind Load Factor 1.00

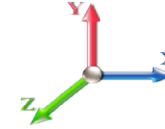

Iterations 24

No.	Elev (ft)	Description	Qty	qz (psf)	qzGh (psf)	CaAa x Ka	Ka	Total CaAa (sf)	Dead Load (lb)	Horiz Ecc (ft)	Vert Ecc (ft)	Wind FX (lb)	Mom Y (lb-ft)	Mom Z (lb-ft)	
1	180.00	ALU 1900 Mhz RRUs	3	7.107	7.818	0.67	1.00	10.48	398.32	0.000	0.000	81.96	0.00	0.00	
2	180.00	PRK-1245L	1	7.107	7.818	1.00	1.00	24.47	793.32	0.000	0.000	191.27	0.00	0.00	
3	180.00	PRK-SFS	1	7.107	7.818	1.00	1.00	20.11	331.73	0.000	0.000	157.21	0.00	0.00	
4	180.00	HRK-14	1	7.107	7.818	1.00	1.00	13.12	732.78	0.000	0.000	102.60	0.00	0.00	
5	180.00	Low Profile Platform	1	7.107	7.818	1.00	1.00	46.33	2206.40	0.000	0.000	362.19	0.00	0.00	
6	180.00	ALU TD-RRH8x20-25	3	7.107	7.818	0.67	1.00	9.81	590.78	0.000	0.000	76.67	0.00	0.00	
7	180.00	ALU 800 Mhz RRUs	6	7.107	7.818	0.67	1.00	14.69	706.93	0.000	0.000	114.86	0.00	0.00	
8	180.00	NNVV-65B-R4	3	7.107	7.818	0.74	1.00	30.53	953.68	0.000	0.000	238.69	0.00	0.00	
9	180.00	APXVTM14-C-I20	3	7.107	7.818	0.77	1.00	17.27	694.23	0.000	0.000	135.00	0.00	0.00	
10	164.50	Low Profile Platform	1	6.927	7.619	1.00	1.00	46.14	2196.84	0.000	0.000	351.53	0.00	0.00	
11	164.50	782 11056	3	6.927	7.619	0.40	0.80	0.51	19.23	0.000	0.000	3.88	0.00	0.00	
12	164.50	LNx-65651DS	3	6.927	7.619	0.64	0.80	28.35	676.92	0.000	0.000	216.03	0.00	0.00	
13	164.50	RR901782DP	3	6.927	7.619	0.54	0.80	8.74	348.26	0.000	0.000	66.60	0.00	0.00	
14	60.00	3 ft Standoff	3	5.193	5.712	0.56	0.75	13.63	294.75	0.000	0.000	77.84	0.00	0.00	
15	60.00	RRH2x40-AWS	2	5.193	5.712	0.54	0.80	3.34	181.62	0.000	0.000	19.08	0.00	0.00	
16	60.00	HBX-6513DS-A1M	2	5.193	5.712	0.64	0.80	3.28	60.22	0.000	0.000	18.76	0.00	0.00	
Totals:									11,186.00						2,214.18

Total Applied Force Summary

Structure: CT02220-S-SBA	Code: EIA/TIA-222-G	5/23/2018
Site Name: Colchester 2 CT	Exposure: B	
Height: 180.00 (ft)	Crest Height: 0.00	
Base Elev: 0.000 (ft)	Site Class: D - Stiff Soil	
Gh: 1.1	Topography: 1	Struct Class: II



Page: 17

Load Case: 1.2D + 1.0Di + 1.0Wi 50 mph Wind

Dead Load Factor 1.20
Wind Load Factor 1.00

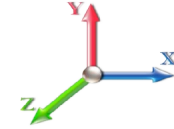

Iterations 24

Elev (ft)	Description	Lateral FX (-) (lb)	Axial FY (-) (lb)	Torsion MY (lb-ft)	Moment MZ (lb-ft)
0.00		0.00	0.00	0.00	0.00
5.00		147.79	2265.49	0.00	0.00
10.00		145.76	2262.22	0.00	0.00
15.00		143.57	2245.04	0.00	0.00
20.00		141.32	2221.76	0.00	0.00
25.00		139.02	2194.95	0.00	0.00
30.00		136.81	2165.81	0.00	0.00
35.00		140.53	2135.01	0.00	0.00
40.00		143.44	2102.94	0.00	0.00
45.00		145.69	2069.88	0.00	0.00
45.92		26.57	376.16	0.00	0.00
50.00		121.86	2674.72	0.00	0.00
53.00		89.84	1940.19	0.00	0.00
55.00		59.96	727.17	0.00	0.00
60.00	(7) attachments	267.35	2331.26	0.00	0.00
65.00		152.19	1756.80	0.00	0.00
70.00		152.40	1725.10	0.00	0.00
75.00		152.32	1693.02	0.00	0.00
80.00		151.98	1660.59	0.00	0.00
85.00		151.40	1627.86	0.00	0.00
90.00		150.60	1594.86	0.00	0.00
92.92		87.11	915.99	0.00	0.00
95.00		62.79	1005.42	0.00	0.00
98.92		117.83	1863.45	0.00	0.00
100.00		32.32	298.46	0.00	0.00
105.00		149.19	1356.18	0.00	0.00
110.00		147.69	1326.45	0.00	0.00
115.00		146.03	1296.55	0.00	0.00
120.00		144.23	1266.47	0.00	0.00
125.00		142.29	1236.24	0.00	0.00
127.09		58.58	508.10	0.00	0.00
130.00		82.18	995.72	0.00	0.00
132.34		65.34	787.82	0.00	0.00
135.00		73.91	520.29	0.00	0.00
140.00		137.33	955.81	0.00	0.00
145.00		134.92	931.32	0.00	0.00
150.00		132.40	906.71	0.00	0.00
155.00		129.77	881.98	0.00	0.00
160.00		127.05	857.15	0.00	0.00
164.50	(10) attachments	749.93	3991.84	0.00	0.00
165.00		12.24	75.08	0.00	0.00
170.00		121.31	732.31	0.00	0.00
175.00		118.31	707.19	0.00	0.00
180.00	(22) attachments	1575.67	8090.13	0.00	0.00
	Totals:	7,308.83	69,277.47	0.00	0.00

Calculated Forces

Structure: CT02220-S-SBA	Code: EIA/TIA-222-G	5/23/2018
Site Name: Colchester 2 CT	Exposure: B	
Height: 180.00 (ft)	Crest Height: 0.00	
Base Elev: 0.000 (ft)	Site Class: D - Stiff Soil	
Gh: 1.1	Topography: 1	Struct Class: II



Page: 18

Load Case: 1.2D + 1.0Di + 1.0Wi 50 mph Wind

Iterations 24

Dead Load Factor 1.20
Wind Load Factor 1.00

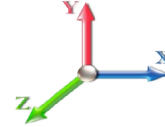

Seg Elev (ft)	Pu FY (-) (kips)	Vu FX (-) (kips)	Tu MY (-) (ft-kips)	Mu MZ (ft-kips)	Mu MX (ft-kips)	Resultant Moment (ft-kips)	phi Pn (kips)	phi Vn (kips)	phi Tn (ft-kips)	phi Mn (ft-kips)	Total Deflect (in)	Rotation Sway (deg)	Rotation Twist (deg)	Stress Ratio
0.00	-69.28	-7.33	0.00	-882.62	0.00	882.62	5525.87	2762.94	13590.7	6747.00	0.00	0.000	0.000	0.143
5.00	-67.01	-7.22	0.00	-845.98	0.00	845.98	5469.54	2734.77	13218.9	6562.44	0.02	-0.033	0.000	0.141
10.00	-64.74	-7.11	0.00	-809.89	0.00	809.89	5411.85	2705.92	12848.7	6378.66	0.07	-0.066	0.000	0.139
15.00	-62.49	-7.00	0.00	-774.34	0.00	774.34	5352.80	2676.40	12480.3	6195.75	0.16	-0.100	0.000	0.137
20.00	-60.27	-6.89	0.00	-739.35	0.00	739.35	5292.39	2646.19	12113.8	6013.80	0.28	-0.133	0.000	0.134
25.00	-58.07	-6.78	0.00	-704.91	0.00	704.91	5230.62	2615.31	11749.3	5832.89	0.44	-0.167	0.000	0.132
30.00	-55.90	-6.67	0.00	-671.02	0.00	671.02	5167.50	2583.75	11387.2	5653.11	0.63	-0.202	0.000	0.130
35.00	-53.76	-6.55	0.00	-637.68	0.00	637.68	5103.02	2551.51	11027.5	5474.55	0.86	-0.236	0.000	0.127
40.00	-51.65	-6.43	0.00	-604.92	0.00	604.92	5037.18	2518.59	10670.5	5297.29	1.13	-0.271	0.000	0.124
45.00	-49.58	-6.29	0.00	-572.76	0.00	572.76	4969.98	2484.99	10316.2	5121.42	1.43	-0.306	0.000	0.122
45.92	-49.20	-6.28	0.00	-567.00	0.00	567.00	4957.51	2478.76	10251.6	5089.33	1.49	-0.312	0.000	0.121
50.00	-46.53	-6.16	0.00	-541.36	0.00	541.36	4901.42	2450.71	9964.95	4947.02	1.77	-0.341	0.000	0.119
53.00	-44.58	-6.07	0.00	-522.87	0.00	522.87	3967.43	1983.71	8109.29	4025.79	1.99	-0.363	0.000	0.141
55.00	-43.86	-6.03	0.00	-510.72	0.00	510.72	3947.58	1973.79	8001.39	3972.23	2.15	-0.377	0.000	0.140
60.00	-41.52	-5.78	0.00	-480.57	0.00	480.57	3897.00	1948.50	7732.70	3838.84	2.56	-0.417	0.000	0.136
65.00	-39.76	-5.64	0.00	-451.69	0.00	451.69	3845.06	1922.53	7465.70	3706.29	3.02	-0.456	0.000	0.132
70.00	-38.04	-5.50	0.00	-423.51	0.00	423.51	3791.77	1895.89	7200.54	3574.65	3.52	-0.496	0.000	0.129
75.00	-36.34	-5.35	0.00	-396.02	0.00	396.02	3737.12	1868.56	6937.41	3444.02	4.06	-0.535	0.000	0.125
80.00	-34.68	-5.21	0.00	-369.25	0.00	369.25	3681.11	1840.56	6676.48	3314.49	4.64	-0.575	0.000	0.121
85.00	-33.05	-5.06	0.00	-343.20	0.00	343.20	3623.74	1811.87	6417.92	3186.13	5.26	-0.614	0.000	0.117
90.00	-31.45	-4.91	0.00	-317.87	0.00	317.87	3565.02	1782.51	6161.91	3059.03	5.93	-0.653	0.000	0.113
92.92	-30.54	-4.83	0.00	-303.54	0.00	303.54	3530.13	1765.07	6013.81	2985.51	6.33	-0.677	0.000	0.110
95.00	-29.53	-4.76	0.00	-293.49	0.00	293.49	3504.93	1752.47	5908.61	2933.28	6.63	-0.693	0.000	0.108
98.92	-27.67	-4.63	0.00	-274.83	0.00	274.83	2742.07	1371.04	4616.42	2291.78	7.21	-0.724	0.000	0.130
100.00	-27.36	-4.61	0.00	-269.81	0.00	269.81	2732.96	1366.48	4575.83	2271.63	7.38	-0.732	0.000	0.129
105.00	-26.01	-4.46	0.00	-246.77	0.00	246.77	2690.08	1345.04	4389.32	2179.04	8.17	-0.776	0.000	0.123
110.00	-24.68	-4.31	0.00	-224.46	0.00	224.46	2645.83	1322.92	4204.31	2087.20	9.01	-0.819	0.000	0.117
115.00	-23.38	-4.17	0.00	-202.89	0.00	202.89	2600.23	1300.12	4020.98	1996.19	9.89	-0.861	0.000	0.111
120.00	-22.12	-4.02	0.00	-182.06	0.00	182.06	2553.28	1276.64	3839.50	1906.09	10.81	-0.902	0.000	0.104
125.00	-20.88	-3.87	0.00	-161.97	0.00	161.97	2504.96	1252.48	3660.03	1816.99	11.78	-0.942	0.000	0.097
127.09	-20.37	-3.81	0.00	-153.91	0.00	153.91	2484.39	1242.20	3585.78	1780.13	12.19	-0.959	0.000	0.095
130.00	-19.38	-3.71	0.00	-142.82	0.00	142.82	2455.29	1227.64	3482.76	1728.99	12.79	-0.982	0.000	0.091
132.34	-18.59	-3.64	0.00	-134.14	0.00	134.14	1489.26	744.63	2121.49	1053.20	13.27	-1.000	0.000	0.140
135.00	-18.07	-3.57	0.00	-124.45	0.00	124.45	1477.63	738.82	2071.36	1028.31	13.84	-1.020	0.000	0.133
140.00	-17.11	-3.43	0.00	-106.60	0.00	106.60	1454.76	727.38	1977.27	981.60	14.93	-1.067	0.000	0.120
145.00	-16.18	-3.29	0.00	-89.46	0.00	89.46	1430.53	715.26	1883.34	934.97	16.07	-1.112	0.000	0.107
150.00	-15.27	-3.15	0.00	-73.03	0.00	73.03	1404.94	702.47	1789.74	888.50	17.26	-1.152	0.000	0.093
155.00	-14.39	-3.01	0.00	-57.29	0.00	57.29	1377.99	688.99	1696.65	842.29	18.48	-1.188	0.000	0.078
160.00	-13.54	-2.87	0.00	-42.26	0.00	42.26	1349.68	674.84	1604.25	796.42	19.75	-1.218	0.000	0.063
164.50	-9.56	-2.04	0.00	-29.35	0.00	29.35	1323.05	661.52	1521.82	755.50	20.91	-1.240	0.000	0.046
165.00	-9.49	-2.02	0.00	-28.33	0.00	28.33	1320.02	660.01	1512.71	750.97	21.04	-1.242	0.000	0.045
170.00	-8.76	-1.89	0.00	-18.22	0.00	18.22	1289.00	644.50	1422.20	706.04	22.35	-1.260	0.000	0.033
175.00	-8.05	-1.76	0.00	-8.78	0.00	8.78	1256.62	628.31	1332.89	661.70	23.67	-1.271	0.000	0.020
180.00	0.00	-1.58	0.00	0.00	0.00	0.00	1222.88	611.44	1244.96	618.05	25.01	-1.275	0.000	0.000

Seismic Segment Forces (Factored)

Structure: CT02220-S-SBA	Code: EIA/TIA-222-G	5/23/2018
Site Name: Colchester 2 CT	Exposure: B	
Height: 180.00 (ft)	Crest Height: 0.00	
Base Elev: 0.000 (ft)	Site Class: D - Stiff Soil	
Gh: 1.1	Topography: 1	Struct Class: II



Page: 19

Load Case: 1.2D + 1.0E					Iterations 22
Gust Response Factor	1.10			Sds	0.19
Dead Load Factor	1.20	Seismic Load Factor	1.00	Sd1	0.10
Wind Load Factor	0.00	Structure Frequency	0.36	SA	0.04
				Seismic Importance Factor	1.00

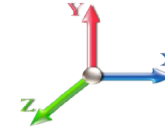

Top Elev (ft)	Description	Wz (lb)	a	b	c	Lateral Fs (lb)	R: 1.50
0.00		0.00	0.00	0.00	0.00	0.00	
5.00		1406.9	0.00	0.03	0.02	21.54	
10.00		1382.4	0.01	0.05	0.03	32.04	
15.00		1358.0	0.01	0.06	0.03	37.37	
20.00		1333.6	0.02	0.07	0.04	39.98	
25.00		1309.2	0.04	0.07	0.04	41.15	
30.00		1284.7	0.05	0.07	0.04	41.60	
35.00		1260.3	0.07	0.07	0.04	41.74	
40.00		1235.9	0.09	0.07	0.04	41.79	
45.00		1211.5	0.12	0.07	0.03	41.78	
45.92	Bot - Section 2	219.46	0.12	0.07	0.03	7.59	
50.00		1807.7	0.15	0.07	0.03	63.42	
53.00	Top - Section 1	1308.8	0.16	0.07	0.03	46.27	
55.00		401.39	0.18	0.07	0.03	14.24	
60.00	Appurtenance(s)	1208.2	0.21	0.06	0.02	42.76	
65.00		968.00	0.25	0.06	0.02	33.44	
70.00		947.14	0.29	0.05	0.01	30.82	
75.00		926.28	0.33	0.04	0.01	26.83	
80.00		905.41	0.37	0.03	0.01	21.26	
85.00		884.55	0.42	0.01	0.01	14.11	
90.00		863.69	0.47	-0.01	0.01	5.70	
92.92	Bot - Section 3	494.18	0.50	-0.02	0.01	0.28	
95.00		644.51	0.53	-0.03	0.01	-2.48	
98.92	Top - Section 2	1193.6	0.57	-0.04	0.01	-14.37	
100.00		149.70	0.58	-0.05	0.01	-2.13	
105.00		680.33	0.64	-0.07	0.02	-15.82	
110.00		662.92	0.71	-0.09	0.03	-19.82	
115.00		645.50	0.77	-0.11	0.05	-21.63	
120.00		628.09	0.84	-0.12	0.07	-21.18	
125.00		610.68	0.91	-0.12	0.09	-18.61	
127.09	Bot - Section 4	249.71	0.94	-0.12	0.10	-7.02	
130.00		587.62	0.99	-0.11	0.12	-13.97	
132.34	Top - Section 3	464.04	1.02	-0.10	0.14	-9.03	
135.00		216.47	1.06	-0.09	0.17	-2.95	
140.00		397.05	1.14	-0.04	0.21	-0.04	
145.00		384.86	1.23	0.03	0.27	6.48	
150.00		372.68	1.31	0.14	0.35	13.86	
155.00		360.49	1.40	0.29	0.43	21.99	
160.00		348.31	1.49	0.48	0.53	30.75	
164.50	Appurtenance(s)	1701.6	1.58	0.71	0.64	197.23	
165.00		33.06	1.59	0.74	0.65	3.94	
170.00		323.94	1.69	1.07	0.79	49.77	
175.00		311.76	1.79	1.48	0.95	59.80	
180.00	Appurtenance(s)	3497.2	1.89	1.98	1.14	817.48	
Totals:		37,182.2				1,698.0	Total Wind: 28,598.5

Seismic Base Shear is Less Than 50% of Wind Force - An Analysis is NOT Required

Calculated Forces

Structure: CT02220-S-SBA	Code: EIA/TIA-222-G	5/23/2018
Site Name: Colchester 2 CT	Exposure: B	
Height: 180.00 (ft)	Crest Height: 0.00	
Base Elev: 0.000 (ft)	Site Class: D - Stiff Soil	
Gh: 1.1	Topography: 1	Struct Class: II

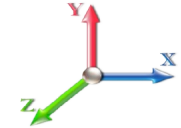

Load Case: 1.2D + 1.0E							Iterations 22
Gust Response Factor	1.10			Sds	0.19		Ss 0.17
Dead Load Factor	1.20	Seismic Load Factor	1.00	Sd1	0.10		S1 0.06
Wind Load Factor	0.00	Structure Frequency	0.36	SA	0.04	Seismic Importance Factor	1.00

Seg Elev (ft)	Pu FY (-) (kips)	Vu FX (-) (kips)	Tu MY (-) (ft-kips)	Mu MZ (ft-kips)	Mu MX (ft-kips)	Resultant Moment (ft-kips)	phi Pn (kips)	phi Vn (kips)	phi Tn (ft-kips)	phi Mn (ft-kips)	Total Deflect (in)	Rotation Sway (deg)	Rotation Twist (deg)	Stress Ratio
0.00	-47.99	-1.85	0.00	-247.77	0.00	247.77	5525.87	2762.94	13590.7	6747.00	0.00	0.00	0.00	0.045
5.00	-46.19	-1.84	0.00	-238.52	0.00	238.52	5469.54	2734.77	13218.9	6562.44	0.00	-0.01	0.045	
10.00	-44.43	-1.81	0.00	-229.34	0.00	229.34	5411.85	2705.92	12848.7	6378.66	0.02	-0.02	0.044	
15.00	-42.69	-1.78	0.00	-220.29	0.00	220.29	5352.80	2676.40	12480.3	6195.75	0.04	-0.03	0.044	
20.00	-40.99	-1.75	0.00	-211.40	0.00	211.40	5292.39	2646.19	12113.8	6013.80	0.08	-0.04	0.043	
25.00	-39.31	-1.71	0.00	-202.67	0.00	202.67	5230.62	2615.31	11749.3	5832.89	0.12	-0.05	0.042	
30.00	-37.67	-1.67	0.00	-194.12	0.00	194.12	5167.50	2583.75	11387.2	5653.11	0.18	-0.06	0.042	
35.00	-36.05	-1.64	0.00	-185.75	0.00	185.75	5103.02	2551.51	11027.5	5474.55	0.24	-0.07	0.041	
40.00	-34.46	-1.60	0.00	-177.57	0.00	177.57	5037.18	2518.59	10670.5	5297.29	0.32	-0.08	0.040	
45.00	-32.90	-1.56	0.00	-169.58	0.00	169.58	4969.98	2484.99	10316.2	5121.42	0.41	-0.09	0.040	
45.92	-32.62	-1.55	0.00	-168.15	0.00	168.15	4957.51	2478.76	10251.6	5089.33	0.42	-0.09	0.040	
50.00	-30.37	-1.49	0.00	-161.81	0.00	161.81	4901.42	2450.71	9964.95	4947.02	0.50	-0.10	0.039	
53.00	-28.73	-1.44	0.00	-157.34	0.00	157.34	3967.43	1983.71	8109.29	4025.79	0.57	-0.10	0.046	
55.00	-28.21	-1.43	0.00	-154.46	0.00	154.46	3947.58	1973.79	8001.39	3972.23	0.61	-0.11	0.046	
60.00	-26.66	-1.39	0.00	-147.30	0.00	147.30	3897.00	1948.50	7732.70	3838.84	0.73	-0.12	0.045	
65.00	-25.40	-1.36	0.00	-140.34	0.00	140.34	3845.06	1922.53	7465.70	3706.29	0.87	-0.13	0.044	
70.00	-24.16	-1.33	0.00	-133.53	0.00	133.53	3791.77	1895.89	7200.54	3574.65	1.01	-0.15	0.044	
75.00	-22.95	-1.31	0.00	-126.87	0.00	126.87	3737.12	1868.56	6937.41	3444.02	1.17	-0.16	0.043	
80.00	-21.77	-1.29	0.00	-120.33	0.00	120.33	3681.11	1840.56	6676.48	3314.49	1.35	-0.17	0.042	
85.00	-20.61	-1.27	0.00	-113.90	0.00	113.90	3623.74	1811.87	6417.92	3186.13	1.53	-0.18	0.041	
90.00	-19.47	-1.27	0.00	-107.52	0.00	107.52	3565.02	1782.51	6161.91	3059.03	1.73	-0.20	0.041	
92.92	-18.82	-1.27	0.00	-103.82	0.00	103.82	3530.13	1765.07	6013.81	2985.51	1.86	-0.21	0.040	
95.00	-18.01	-1.27	0.00	-101.18	0.00	101.18	3504.93	1752.47	5908.61	2933.28	1.95	-0.21	0.040	
98.92	-16.50	-1.26	0.00	-96.21	0.00	96.21	2742.07	1371.04	4616.42	2291.78	2.12	-0.22	0.048	
100.00	-16.30	-1.27	0.00	-94.84	0.00	94.84	2732.96	1366.48	4575.83	2271.63	2.17	-0.22	0.048	
105.00	-15.38	-1.27	0.00	-88.51	0.00	88.51	2690.08	1345.04	4389.32	2179.04	2.42	-0.24	0.046	
110.00	-14.49	-1.27	0.00	-82.17	0.00	82.17	2645.83	1322.92	4204.31	2087.20	2.68	-0.26	0.045	
115.00	-13.62	-1.27	0.00	-75.84	0.00	75.84	2600.23	1300.12	4020.98	1996.19	2.95	-0.27	0.043	
120.00	-12.77	-1.27	0.00	-69.51	0.00	69.51	2553.28	1276.64	3839.50	1906.09	3.25	-0.29	0.041	
125.00	-11.94	-1.26	0.00	-63.18	0.00	63.18	2504.96	1252.48	3660.03	1816.99	3.55	-0.30	0.040	
127.09	-11.59	-1.26	0.00	-60.54	0.00	60.54	2484.39	1242.20	3585.78	1780.13	3.69	-0.31	0.039	
130.00	-10.83	-1.26	0.00	-56.86	0.00	56.86	2455.29	1227.64	3482.76	1728.99	3.88	-0.32	0.037	
132.34	-10.23	-1.26	0.00	-53.91	0.00	53.91	1489.26	744.63	2121.49	1053.20	4.04	-0.32	0.058	
135.00	-9.92	-1.26	0.00	-50.55	0.00	50.55	1477.63	738.82	2071.36	1028.31	4.22	-0.33	0.056	
140.00	-9.34	-1.26	0.00	-44.25	0.00	44.25	1454.76	727.38	1977.27	981.60	4.58	-0.35	0.052	
145.00	-8.78	-1.25	0.00	-37.96	0.00	37.96	1430.53	715.26	1883.34	934.97	4.96	-0.37	0.047	
150.00	-8.24	-1.24	0.00	-31.69	0.00	31.69	1404.94	702.47	1789.74	888.50	5.36	-0.39	0.042	
155.00	-7.71	-1.21	0.00	-25.51	0.00	25.51	1377.99	688.99	1696.65	842.29	5.77	-0.40	0.036	
160.00	-7.19	-1.18	0.00	-19.44	0.00	19.44	1349.68	674.84	1604.25	796.42	6.20	-0.42	0.030	
164.50	-5.06	-0.97	0.00	-14.12	0.00	14.12	1323.05	661.52	1521.82	755.50	6.60	-0.43	0.023	
165.00	-5.02	-0.96	0.00	-13.64	0.00	13.64	1320.02	660.01	1512.71	750.97	6.65	-0.43	0.022	
170.00	-4.61	-0.91	0.00	-8.81	0.00	8.81	1289.00	644.50	1422.20	706.04	7.10	-0.44	0.016	
175.00	-4.21	-0.85	0.00	-4.25	0.00	4.25	1256.62	628.31	1332.89	661.70	7.56	-0.44	0.010	
180.00	0.00	-0.82	0.00	0.00	0.00	0.00	1222.88	611.44	1244.96	618.05	8.03	-0.44	0.000	

Seismic Segment Forces (Factored)

Structure: CT02220-S-SBA	Code: EIA/TIA-222-G	5/23/2018
Site Name: Colchester 2 CT	Exposure: B	
Height: 180.00 (ft)	Crest Height: 0.00	
Base Elev: 0.000 (ft)	Site Class: D - Stiff Soil	
Gh: 1.1	Topography: 1	Struct Class: II



Page: 21

Load Case: 0.9D + 1.0E				Iterations 22
Gust Response Factor	1.10	Sds	0.19	Ss 0.17
Dead Load Factor	0.90	Seismic Load Factor	1.00	S1 0.06
Wind Load Factor	0.00	Structure Frequency	0.36	SA 0.04
				Seismic Importance Factor 1.00

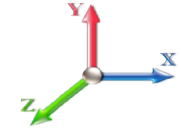

Top Elev (ft)	Description	Wz (lb)	a	b	c	Lateral Fs (lb)	R: 1.50
0.00		0.00	0.00	0.00	0.00	0.00	
5.00		1406.9	0.00	0.03	0.02	21.54	
10.00		1382.4	0.01	0.05	0.03	32.04	
15.00		1358.0	0.01	0.06	0.03	37.37	
20.00		1333.6	0.02	0.07	0.04	39.98	
25.00		1309.2	0.04	0.07	0.04	41.15	
30.00		1284.7	0.05	0.07	0.04	41.60	
35.00		1260.3	0.07	0.07	0.04	41.74	
40.00		1235.9	0.09	0.07	0.04	41.79	
45.00		1211.5	0.12	0.07	0.03	41.78	
45.92	Bot - Section 2	219.46	0.12	0.07	0.03	7.59	
50.00		1807.7	0.15	0.07	0.03	63.42	
53.00	Top - Section 1	1308.8	0.16	0.07	0.03	46.27	
55.00		401.39	0.18	0.07	0.03	14.24	
60.00	Appurtenance(s)	1208.2	0.21	0.06	0.02	42.76	
65.00		968.00	0.25	0.06	0.02	33.44	
70.00		947.14	0.29	0.05	0.01	30.82	
75.00		926.28	0.33	0.04	0.01	26.83	
80.00		905.41	0.37	0.03	0.01	21.26	
85.00		884.55	0.42	0.01	0.01	14.11	
90.00		863.69	0.47	-0.01	0.01	5.70	
92.92	Bot - Section 3	494.18	0.50	-0.02	0.01	0.28	
95.00		644.51	0.53	-0.03	0.01	-2.48	
98.92	Top - Section 2	1193.6	0.57	-0.04	0.01	-14.37	
100.00		149.70	0.58	-0.05	0.01	-2.13	
105.00		680.33	0.64	-0.07	0.02	-15.82	
110.00		662.92	0.71	-0.09	0.03	-19.82	
115.00		645.50	0.77	-0.11	0.05	-21.63	
120.00		628.09	0.84	-0.12	0.07	-21.18	
125.00		610.68	0.91	-0.12	0.09	-18.61	
127.09	Bot - Section 4	249.71	0.94	-0.12	0.10	-7.02	
130.00		587.62	0.99	-0.11	0.12	-13.97	
132.34	Top - Section 3	464.04	1.02	-0.10	0.14	-9.03	
135.00		216.47	1.06	-0.09	0.17	-2.95	
140.00		397.05	1.14	-0.04	0.21	-0.04	
145.00		384.86	1.23	0.03	0.27	6.48	
150.00		372.68	1.31	0.14	0.35	13.86	
155.00		360.49	1.40	0.29	0.43	21.99	
160.00		348.31	1.49	0.48	0.53	30.75	
164.50	Appurtenance(s)	1701.6	1.58	0.71	0.64	197.23	
165.00		33.06	1.59	0.74	0.65	3.94	
170.00		323.94	1.69	1.07	0.79	49.77	
175.00		311.76	1.79	1.48	0.95	59.80	
180.00	Appurtenance(s)	3497.2	1.89	1.98	1.14	817.48	
Totals:		37,182.2				1,698.0	Total Wind: 28,598.5

Seismic Base Shear is Less Than 50% of Wind Force - An Analysis is NOT Required

Calculated Forces

Structure: CT02220-S-SBA	Code: EIA/TIA-222-G	5/23/2018
Site Name: Colchester 2 CT	Exposure: B	
Height: 180.00 (ft)	Crest Height: 0.00	
Base Elev: 0.000 (ft)	Site Class: D - Stiff Soil	
Gh: 1.1	Topography: 1	Struct Class: II



Load Case: 0.9D + 1.0E						Iterations 22
Gust Response Factor	1.10		Sds	0.19		Ss 0.17
Dead Load Factor	0.90	Seismic Load Factor	1.00	Sd1	0.10	S1 0.06
Wind Load Factor	0.00	Structure Frequency	0.36	SA	0.04	Seismic Importance Factor 1.00

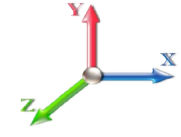

Seg Elev (ft)	Pu FY (-) (kips)	Vu FX (-) (kips)	Tu MY (-) (ft-kips)	Mu MZ (ft-kips)	Mu MX (ft-kips)	Resultant Moment (ft-kips)	phi Pn (kips)	phi Vn (kips)	phi Tn (ft-kips)	phi Mn (ft-kips)	Total Deflect (in)	Rotation Sway (deg)	Rotation Twist (deg)	Stress Ratio
0.00	-35.99	-1.85	0.00	-245.39	0.00	245.39	5525.87	2762.94	13590.7	6747.00	0.00	0.00	0.00	0.043
5.00	-34.64	-1.83	0.00	-236.14	0.00	236.14	5469.54	2734.77	13218.9	6562.44	0.00	-0.01	0.042	
10.00	-33.32	-1.81	0.00	-226.98	0.00	226.98	5411.85	2705.92	12848.7	6378.66	0.02	-0.02	0.042	
15.00	-32.02	-1.77	0.00	-217.95	0.00	217.95	5352.80	2676.40	12480.3	6195.75	0.04	-0.03	0.041	
20.00	-30.74	-1.74	0.00	-209.09	0.00	209.09	5292.39	2646.19	12113.8	6013.80	0.08	-0.04	0.041	
25.00	-29.49	-1.70	0.00	-200.40	0.00	200.40	5230.62	2615.31	11749.3	5832.89	0.12	-0.05	0.040	
30.00	-28.25	-1.66	0.00	-191.90	0.00	191.90	5167.50	2583.75	11387.2	5653.11	0.18	-0.06	0.039	
35.00	-27.04	-1.62	0.00	-183.58	0.00	183.58	5103.02	2551.51	11027.5	5474.55	0.24	-0.07	0.039	
40.00	-25.85	-1.59	0.00	-175.46	0.00	175.46	5037.18	2518.59	10670.5	5297.29	0.32	-0.08	0.038	
45.00	-24.68	-1.54	0.00	-167.53	0.00	167.53	4969.98	2484.99	10316.2	5121.42	0.40	-0.09	0.038	
45.92	-24.47	-1.54	0.00	-166.12	0.00	166.12	4957.51	2478.76	10251.6	5089.33	0.42	-0.09	0.038	
50.00	-22.77	-1.48	0.00	-159.83	0.00	159.83	4901.42	2450.71	9964.95	4947.02	0.50	-0.10	0.037	
53.00	-21.55	-1.43	0.00	-155.41	0.00	155.41	3967.43	1983.71	8109.29	4025.79	0.56	-0.10	0.044	
55.00	-21.16	-1.42	0.00	-152.55	0.00	152.55	3947.58	1973.79	8001.39	3972.23	0.61	-0.11	0.044	
60.00	-19.99	-1.38	0.00	-145.46	0.00	145.46	3897.00	1948.50	7732.70	3838.84	0.73	-0.12	0.043	
65.00	-19.05	-1.35	0.00	-138.58	0.00	138.58	3845.06	1922.53	7465.70	3706.29	0.86	-0.13	0.042	
70.00	-18.12	-1.32	0.00	-131.85	0.00	131.85	3791.77	1895.89	7200.54	3574.65	1.00	-0.14	0.042	
75.00	-17.21	-1.29	0.00	-125.27	0.00	125.27	3737.12	1868.56	6937.41	3444.02	1.16	-0.16	0.041	
80.00	-16.32	-1.27	0.00	-118.82	0.00	118.82	3681.11	1840.56	6676.48	3314.49	1.33	-0.17	0.040	
85.00	-15.46	-1.26	0.00	-112.47	0.00	112.47	3623.74	1811.87	6417.92	3186.13	1.52	-0.18	0.040	
90.00	-14.60	-1.25	0.00	-106.18	0.00	106.18	3565.02	1782.51	6161.91	3059.03	1.71	-0.19	0.039	
92.92	-14.12	-1.25	0.00	-102.53	0.00	102.53	3530.13	1765.07	6013.81	2985.51	1.83	-0.20	0.038	
95.00	-13.51	-1.25	0.00	-99.93	0.00	99.93	3504.93	1752.47	5908.61	2933.28	1.92	-0.21	0.038	
98.92	-12.37	-1.25	0.00	-95.03	0.00	95.03	2742.07	1371.04	4616.42	2291.78	2.10	-0.22	0.046	
100.00	-12.22	-1.25	0.00	-93.68	0.00	93.68	2732.96	1366.48	4575.83	2271.63	2.15	-0.22	0.046	
105.00	-11.54	-1.25	0.00	-87.43	0.00	87.43	2690.08	1345.04	4389.32	2179.04	2.39	-0.24	0.044	
110.00	-10.87	-1.25	0.00	-81.18	0.00	81.18	2645.83	1322.92	4204.31	2087.20	2.65	-0.25	0.043	
115.00	-10.21	-1.25	0.00	-74.93	0.00	74.93	2600.23	1300.12	4020.98	1996.19	2.92	-0.27	0.041	
120.00	-9.57	-1.25	0.00	-68.68	0.00	68.68	2553.28	1276.64	3839.50	1906.09	3.21	-0.28	0.040	
125.00	-8.95	-1.25	0.00	-62.44	0.00	62.44	2504.96	1252.48	3660.03	1816.99	3.51	-0.30	0.038	
127.09	-8.69	-1.25	0.00	-59.84	0.00	59.84	2484.39	1242.20	3585.78	1780.13	3.64	-0.30	0.037	
130.00	-8.12	-1.25	0.00	-56.20	0.00	56.20	2455.29	1227.64	3482.76	1728.99	3.83	-0.31	0.036	
132.34	-7.67	-1.24	0.00	-53.29	0.00	53.29	1489.26	744.63	2121.49	1053.20	3.99	-0.32	0.056	
135.00	-7.44	-1.24	0.00	-49.98	0.00	49.98	1477.63	738.82	2071.36	1028.31	4.17	-0.33	0.054	
140.00	-7.01	-1.24	0.00	-43.75	0.00	43.75	1454.76	727.38	1977.27	981.60	4.53	-0.35	0.049	
145.00	-6.59	-1.24	0.00	-37.53	0.00	37.53	1430.53	715.26	1883.34	934.97	4.90	-0.37	0.045	
150.00	-6.18	-1.22	0.00	-31.34	0.00	31.34	1404.94	702.47	1789.74	888.50	5.29	-0.38	0.040	
155.00	-5.78	-1.20	0.00	-25.23	0.00	25.23	1377.99	688.99	1696.65	842.29	5.70	-0.40	0.034	
160.00	-5.39	-1.17	0.00	-19.23	0.00	19.23	1349.68	674.84	1604.25	796.42	6.13	-0.41	0.028	
164.50	-3.80	-0.96	0.00	-13.98	0.00	13.98	1323.05	661.52	1521.82	755.50	6.52	-0.42	0.021	
165.00	-3.76	-0.96	0.00	-13.50	0.00	13.50	1320.02	660.01	1512.71	750.97	6.57	-0.42	0.021	
170.00	-3.46	-0.90	0.00	-8.73	0.00	8.73	1289.00	644.50	1422.20	706.04	7.02	-0.43	0.015	
175.00	-3.16	-0.84	0.00	-4.21	0.00	4.21	1256.62	628.31	1332.89	661.70	7.47	-0.44	0.009	
180.00	0.00	-0.82	0.00	0.00	0.00	0.00	1222.88	611.44	1244.96	618.05	7.93	-0.44	0.000	

Wind Loading - Shaft

Structure: CT02220-S-SBA	Code: EIA/TIA-222-G	5/23/2018
Site Name: Colchester 2 CT	Exposure: B	
Height: 180.00 (ft)	Crest Height: 0.00	
Base Elev: 0.000 (ft)	Site Class: D - Stiff Soil	
Gh: 1.1	Topography: 1	Struct Class: II



Page: 23

Load Case: 1.0D + 1.0W 60 mph Wind

Dead Load Factor 1.00
Wind Load Factor 1.00

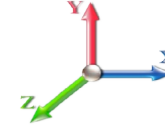

Iterations 23

Elev (ft)	Description	Kzt	Kz	qz (psf)	qzGh (psf)	C (mph-ft)	Cf	Ice Thick (in)	Tributary (ft)	Aa (sf)	CfAa (sf)	Wind Force X (lb)	Dead Load Ice (lb)	Tot Dead Load (lb)
0.00		1.00	0.70	6.129	6.74	255.92	0.750	0.000	0.00	0.000	0.00	0.0	0.0	0.0
5.00		1.00	0.70	6.129	6.74	251.54	0.750	0.000	5.00	25.272	18.95	127.8	0.0	1406.9
10.00		1.00	0.70	6.129	6.74	247.17	0.750	0.000	5.00	24.837	18.63	125.6	0.0	1382.5
15.00		1.00	0.70	6.129	6.74	242.80	0.750	0.000	5.00	24.401	18.30	123.4	0.0	1358.1
20.00		1.00	0.70	6.129	6.74	238.43	0.750	0.000	5.00	23.966	17.97	121.2	0.0	1333.6
25.00		1.00	0.70	6.129	6.74	234.05	0.750	0.000	5.00	23.530	17.65	119.0	0.0	1309.2
30.00		1.00	0.70	6.134	6.75	229.78	0.750	0.000	5.00	23.095	17.32	116.9	0.0	1284.8
35.00		1.00	0.73	6.410	7.05	230.42	0.750	0.000	5.00	22.659	16.99	119.8	0.0	1260.4
40.00		1.00	0.76	6.659	7.33	230.30	0.750	0.000	5.00	22.224	16.67	122.1	0.0	1235.9
45.00		1.00	0.79	6.887	7.58	229.58	0.750	0.000	5.00	21.788	16.34	123.8	0.0	1211.5
45.92 Bot - Section 2		1.00	0.79	6.927	7.62	229.39	0.750	0.000	0.92	3.947	2.96	22.6	0.0	219.5
50.00		1.00	0.81	7.098	7.81	228.35	0.750	0.000	4.08	17.666	13.25	103.4	0.0	1807.7
53.00 Top - Section 1		1.00	0.82	7.217	7.94	227.41	0.750	0.000	3.00	12.794	9.60	76.2	0.0	1308.9
55.00		1.00	0.83	7.294	8.02	230.20	0.750	0.000	2.00	8.442	6.33	50.8	0.0	401.4
60.00 Appurtenance(s)		1.00	0.85	7.477	8.22	228.25	0.750	0.000	5.00	20.800	15.60	128.3	0.0	988.9
65.00		1.00	0.87	7.650	8.42	225.99	0.750	0.000	5.00	20.365	15.27	128.5	0.0	968.0
70.00		1.00	0.89	7.814	8.60	223.46	0.750	0.000	5.00	19.929	14.95	128.5	0.0	947.1
75.00		1.00	0.91	7.969	8.77	220.69	0.750	0.000	5.00	19.494	14.62	128.2	0.0	926.3
80.00		1.00	0.93	8.118	8.93	217.70	0.750	0.000	5.00	19.058	14.29	127.6	0.0	905.4
85.00		1.00	0.94	8.260	9.09	214.52	0.750	0.000	5.00	18.623	13.97	126.9	0.0	884.5
90.00		1.00	0.96	8.396	9.24	211.16	0.750	0.000	5.00	18.187	13.64	126.0	0.0	863.7
92.92 Bot - Section 3		1.00	0.97	8.472	9.32	209.12	0.750	0.000	2.92	10.408	7.81	72.8	0.0	494.2
95.00		1.00	0.97	8.526	9.38	207.64	0.750	0.000	2.08	7.454	5.59	52.4	0.0	644.5
98.92 Top - Section 2		1.00	0.99	8.625	9.49	204.78	0.750	0.000	3.92	13.810	10.36	98.3	0.0	1193.7
100.00		1.00	0.99	8.652	9.52	207.14	0.750	0.000	1.08	3.773	2.83	26.9	0.0	149.7
105.00		1.00	1.00	8.774	9.65	203.36	0.750	0.000	5.00	17.147	12.86	124.1	0.0	680.3
110.00		1.00	1.02	8.891	9.78	199.45	0.750	0.000	5.00	16.711	12.53	122.6	0.0	662.9
115.00		1.00	1.03	9.005	9.91	195.42	0.750	0.000	5.00	16.276	12.21	120.9	0.0	645.5
120.00		1.00	1.04	9.115	10.03	191.28	0.750	0.000	5.00	15.840	11.88	119.1	0.0	628.1
125.00		1.00	1.05	9.222	10.14	187.04	0.750	0.000	5.00	15.405	11.55	117.2	0.0	610.7
127.09 Bot - Section 4		1.00	1.06	9.265	10.19	185.23	0.750	0.000	2.09	6.300	4.73	48.2	0.0	249.7
130.00		1.00	1.07	9.326	10.26	182.69	0.750	0.000	2.91	8.777	6.58	67.5	0.0	587.6
132.34 Top - Section 3		1.00	1.07	9.373	10.31	180.63	0.750	0.000	2.34	6.933	5.20	53.6	0.0	464.0
135.00		1.00	1.08	9.427	10.37	180.57	0.750	0.000	2.66	7.787	5.84	60.6	0.0	216.5
140.00		1.00	1.09	9.525	10.48	176.06	0.750	0.000	5.00	14.284	10.71	112.3	0.0	397.0
145.00		1.00	1.10	9.621	10.58	171.47	0.750	0.000	5.00	13.849	10.39	109.9	0.0	384.9
150.00		1.00	1.11	9.715	10.69	166.80	0.750	0.000	5.00	13.413	10.06	107.5	0.0	372.7
155.00		1.00	1.12	9.806	10.79	162.05	0.750	0.000	5.00	12.978	9.73	105.0	0.0	360.5
160.00		1.00	1.13	9.896	10.89	157.23	0.750	0.000	5.00	12.542	9.41	102.4	0.0	348.3
164.50 Appurtenance(s)		1.00	1.14	9.974	10.97	152.84	0.750	0.000	4.50	10.916	8.19	89.8	0.0	303.1
165.00		1.00	1.14	9.983	10.98	152.34	0.750	0.000	0.50	1.191	0.89	9.8	0.0	33.1
170.00		1.00	1.15	10.069	11.08	147.39	0.750	0.000	5.00	11.671	8.75	96.9	0.0	323.9
175.00		1.00	1.16	10.152	11.17	142.37	0.750	0.000	5.00	11.236	8.43	94.1	0.0	311.8
180.00 Appurtenance(s)		1.00	1.17	10.234	11.26	137.30	0.750	0.000	5.00	10.800	8.10	91.2	0.0	299.6
Totals:									180.00			4,249.5		32,366.5

Discrete Appurtenance Forces

Structure: CT02220-S-SBA	Code: EIA/TIA-222-G	5/23/2018
Site Name: Colchester 2 CT	Exposure: B	
Height: 180.00 (ft)	Crest Height: 0.00	
Base Elev: 0.000 (ft)	Site Class: D - Stiff Soil	
Gh: 1.1	Topography: 1	Struct Class: II



Page: 24

Load Case: 1.0D + 1.0W 60 mph Wind

Dead Load Factor 1.00
Wind Load Factor 1.00



Iterations 23

No.	Elev (ft)	Description	Qty	qz (psf)	qzGh (psf)	CaAa x Ka	Ka	Total CaAa (sf)	Dead Load (lb)	Horiz Ecc (ft)	Vert Ecc (ft)	Wind FX (lb)	Mom Y (lb-ft)	Mom Z (lb-ft)	
1	180.00	ALU 1900 Mhz RRUs	3	10.234	11.258	0.67	1.00	7.64	132.00	0.000	0.000	85.99	0.00	0.00	
2	180.00	PRK-1245L	1	10.234	11.258	1.00	1.00	11.84	464.91	0.000	0.000	133.29	0.00	0.00	
3	180.00	PRK-SFS	1	10.234	11.258	1.00	1.00	13.00	170.00	0.000	0.000	146.35	0.00	0.00	
4	180.00	HRK-14	1	10.234	11.258	1.00	1.00	6.00	302.00	0.000	0.000	67.55	0.00	0.00	
5	180.00	Low Profile Platform	1	10.234	11.258	1.00	1.00	25.00	1200.00	0.000	0.000	281.44	0.00	0.00	
6	180.00	ALU TD-RRH8x20-25	3	10.234	11.258	0.67	1.00	8.14	210.00	0.000	0.000	91.64	0.00	0.00	
7	180.00	ALU 800 Mhz RRUs	6	10.234	11.258	0.67	1.00	10.01	318.00	0.000	0.000	112.69	0.00	0.00	
8	180.00	NNVV-65B-R4	3	10.234	11.258	0.74	1.00	27.24	232.20	0.000	0.000	306.65	0.00	0.00	
9	180.00	APXVTM14-C-I20	3	10.234	11.258	0.77	1.00	14.65	168.60	0.000	0.000	164.87	0.00	0.00	
10	164.50	Low Profile Platform	1	9.974	10.972	1.00	1.00	25.00	1200.00	0.000	0.000	274.30	0.00	0.00	
11	164.50	782 11056	3	9.974	10.972	0.40	0.80	0.16	8.70	0.000	0.000	1.71	0.00	0.00	
12	164.50	LNx-65651DS	3	9.974	10.972	0.64	0.80	22.02	149.40	0.000	0.000	241.63	0.00	0.00	
13	164.50	RR901782DP	3	9.974	10.972	0.54	0.80	7.12	40.50	0.000	0.000	78.07	0.00	0.00	
14	60.00	3 ft Standoff	3	7.477	8.225	0.56	0.75	4.44	120.00	0.000	0.000	36.50	0.00	0.00	
15	60.00	RRH2x40-AWS	2	7.477	8.225	0.54	0.80	2.32	88.00	0.000	0.000	19.04	0.00	0.00	
16	60.00	HBX-6513DS-A1M	2	7.477	8.225	0.64	0.80	2.02	11.40	0.000	0.000	16.63	0.00	0.00	
Totals:									4,815.71						2,058.37

Total Applied Force Summary

Structure: CT02220-S-SBA	Code: EIA/TIA-222-G	5/23/2018
Site Name: Colchester 2 CT	Exposure: B	
Height: 180.00 (ft)	Crest Height: 0.00	
Base Elev: 0.000 (ft)	Site Class: D - Stiff Soil	
Gh: 1.1	Topography: 1	Struct Class: II



Page: 25

Load Case: 1.0D + 1.0W 60 mph Wind

Dead Load Factor 1.00
Wind Load Factor 1.00

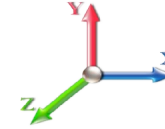

Iterations 23

Elev (ft)	Description	Lateral FX (-) (lb)	Axial FY (-) (lb)	Torsion MY (lb-ft)	Moment MZ (lb-ft)
0.00		0.00	0.00	0.00	0.00
5.00		127.78	1493.89	0.00	0.00
10.00		125.58	1469.47	0.00	0.00
15.00		123.37	1445.04	0.00	0.00
20.00		121.17	1420.62	0.00	0.00
25.00		118.97	1396.19	0.00	0.00
30.00		116.87	1371.77	0.00	0.00
35.00		119.83	1347.34	0.00	0.00
40.00		122.09	1322.92	0.00	0.00
45.00		123.80	1298.50	0.00	0.00
45.92		22.56	235.41	0.00	0.00
50.00		103.44	1878.75	0.00	0.00
53.00		76.17	1361.06	0.00	0.00
55.00		50.80	436.18	0.00	0.00
60.00	(7) attachments	200.49	1295.25	0.00	0.00
65.00		128.53	1049.48	0.00	0.00
70.00		128.47	1028.62	0.00	0.00
75.00		128.17	1007.76	0.00	0.00
80.00		127.64	986.89	0.00	0.00
85.00		126.90	966.03	0.00	0.00
90.00		125.97	945.17	0.00	0.00
92.92		72.75	541.71	0.00	0.00
95.00		52.44	678.46	0.00	0.00
98.92		98.27	1257.51	0.00	0.00
100.00		26.93	167.35	0.00	0.00
105.00		124.11	761.81	0.00	0.00
110.00		122.58	744.40	0.00	0.00
115.00		120.91	726.98	0.00	0.00
120.00		119.11	709.57	0.00	0.00
125.00		117.20	692.16	0.00	0.00
127.09		48.16	283.71	0.00	0.00
130.00		67.53	635.10	0.00	0.00
132.34		53.61	502.12	0.00	0.00
135.00		60.56	259.87	0.00	0.00
140.00		112.25	478.53	0.00	0.00
145.00		109.92	466.34	0.00	0.00
150.00		107.50	454.16	0.00	0.00
155.00		104.99	441.97	0.00	0.00
160.00		102.39	429.79	0.00	0.00
164.50	(10) attachments	685.53	1774.99	0.00	0.00
165.00		9.81	34.97	0.00	0.00
170.00		96.95	343.02	0.00	0.00
175.00		94.11	330.84	0.00	0.00
180.00	(22) attachments	1481.67	3516.36	0.00	0.00
	Totals:	6,307.87	39,988.08	0.00	0.00

Calculated Forces

Structure: CT02220-S-SBA
Site Name: Colchester 2 CT
Height: 180.00 (ft)
Base Elev: 0.000 (ft)
Gh: 1.1

Topography: 1

Code: EIA/TIA-222-G
Exposure: B
Crest Height: 0.00
Site Class: D - Stiff Soil
Struct Class: II

5/23/2018
 Page: 26



Load Case: 1.0D + 1.0W 60 mph Wind

Dead Load Factor 1.00
Wind Load Factor 1.00

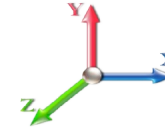

Iterations 23

Seg Elev (ft)	Pu FY (-) (kips)	Vu FX (-) (kips)	Tu MY (-) (ft-kips)	Mu MZ (ft-kips)	Mu MX (ft-kips)	Resultant Moment (ft-kips)	phi Pn (kips)	phi Vn (kips)	phi Tn (ft-kips)	phi Mn (ft-kips)	Total Deflect (in)	Rotation Sway (deg)	Rotation Twist (deg)	Stress Ratio
0.00	-39.99	-6.32	0.00	-750.89	0.00	750.89	5525.87	2762.94	13590.7	6747.00	0.00	0.000	0.000	0.119
5.00	-38.49	-6.21	0.00	-719.30	0.00	719.30	5469.54	2734.77	13218.9	6562.44	0.02	-0.028	0.000	0.117
10.00	-37.02	-6.10	0.00	-688.27	0.00	688.27	5411.85	2705.92	12848.7	6378.66	0.06	-0.056	0.000	0.115
15.00	-35.57	-5.99	0.00	-657.77	0.00	657.77	5352.80	2676.40	12480.3	6195.75	0.13	-0.085	0.000	0.113
20.00	-34.15	-5.89	0.00	-627.81	0.00	627.81	5292.39	2646.19	12113.8	6013.80	0.24	-0.113	0.000	0.111
25.00	-32.75	-5.78	0.00	-598.39	0.00	598.39	5230.62	2615.31	11749.3	5832.89	0.37	-0.142	0.000	0.109
30.00	-31.37	-5.68	0.00	-569.49	0.00	569.49	5167.50	2583.75	11387.2	5653.11	0.54	-0.171	0.000	0.107
35.00	-30.02	-5.57	0.00	-541.11	0.00	541.11	5103.02	2551.51	11027.5	5474.55	0.73	-0.201	0.000	0.105
40.00	-28.70	-5.45	0.00	-513.28	0.00	513.28	5037.18	2518.59	10670.5	5297.29	0.96	-0.230	0.000	0.103
45.00	-27.40	-5.33	0.00	-486.01	0.00	486.01	4969.98	2484.99	10316.2	5121.42	1.21	-0.260	0.000	0.100
45.92	-27.16	-5.32	0.00	-481.12	0.00	481.12	4957.51	2478.76	10251.6	5089.33	1.27	-0.265	0.000	0.100
50.00	-25.28	-5.21	0.00	-459.41	0.00	459.41	4901.42	2450.71	9964.95	4947.02	1.50	-0.290	0.000	0.098
53.00	-23.92	-5.14	0.00	-443.77	0.00	443.77	3967.43	1983.71	8109.29	4025.79	1.69	-0.308	0.000	0.116
55.00	-23.48	-5.09	0.00	-433.50	0.00	433.50	3947.58	1973.79	8001.39	3972.23	1.82	-0.320	0.000	0.115
60.00	-22.18	-4.90	0.00	-408.03	0.00	408.03	3897.00	1948.50	7732.70	3838.84	2.18	-0.354	0.000	0.112
65.00	-21.13	-4.77	0.00	-383.55	0.00	383.55	3845.06	1922.53	7465.70	3706.29	2.56	-0.387	0.000	0.109
70.00	-20.10	-4.65	0.00	-359.67	0.00	359.67	3791.77	1895.89	7200.54	3574.65	2.99	-0.421	0.000	0.106
75.00	-19.09	-4.53	0.00	-336.42	0.00	336.42	3737.12	1868.56	6937.41	3444.02	3.45	-0.454	0.000	0.103
80.00	-18.10	-4.40	0.00	-313.79	0.00	313.79	3681.11	1840.56	6676.48	3314.49	3.94	-0.488	0.000	0.100
85.00	-17.14	-4.28	0.00	-291.78	0.00	291.78	3623.74	1811.87	6417.92	3186.13	4.47	-0.522	0.000	0.096
90.00	-16.19	-4.15	0.00	-270.41	0.00	270.41	3565.02	1782.51	6161.91	3059.03	5.03	-0.555	0.000	0.093
92.92	-15.65	-4.07	0.00	-258.31	0.00	258.31	3530.13	1765.07	6013.81	2985.51	5.38	-0.575	0.000	0.091
95.00	-14.97	-4.02	0.00	-249.82	0.00	249.82	3504.93	1752.47	5908.61	2933.28	5.63	-0.589	0.000	0.089
98.92	-13.71	-3.91	0.00	-234.07	0.00	234.07	2742.07	1371.04	4616.42	2291.78	6.13	-0.615	0.000	0.107
100.00	-13.54	-3.89	0.00	-229.83	0.00	229.83	2732.96	1366.48	4575.83	2271.63	6.27	-0.622	0.000	0.106
105.00	-12.78	-3.77	0.00	-210.38	0.00	210.38	2690.08	1345.04	4389.32	2179.04	6.94	-0.659	0.000	0.101
110.00	-12.04	-3.64	0.00	-191.56	0.00	191.56	2645.83	1322.92	4204.31	2087.20	7.65	-0.696	0.000	0.096
115.00	-11.31	-3.52	0.00	-173.35	0.00	173.35	2600.23	1300.12	4020.98	1996.19	8.40	-0.732	0.000	0.091
120.00	-10.60	-3.40	0.00	-155.75	0.00	155.75	2553.28	1276.64	3839.50	1906.09	9.18	-0.767	0.000	0.086
125.00	-9.91	-3.27	0.00	-138.77	0.00	138.77	2504.96	1252.48	3660.03	1816.99	10.01	-0.802	0.000	0.080
127.09	-9.62	-3.23	0.00	-131.93	0.00	131.93	2484.39	1242.20	3585.78	1780.13	10.36	-0.816	0.000	0.078
130.00	-8.99	-3.15	0.00	-122.54	0.00	122.54	2455.29	1227.64	3482.76	1728.99	10.86	-0.835	0.000	0.075
132.34	-8.49	-3.09	0.00	-115.18	0.00	115.18	1489.26	744.63	2121.49	1053.20	11.28	-0.851	0.000	0.115
135.00	-8.22	-3.03	0.00	-106.94	0.00	106.94	1477.63	738.82	2071.36	1028.31	11.76	-0.868	0.000	0.110
140.00	-7.75	-2.92	0.00	-91.78	0.00	91.78	1454.76	727.38	1977.27	981.60	12.69	-0.909	0.000	0.099
145.00	-7.28	-2.81	0.00	-77.18	0.00	77.18	1430.53	715.26	1883.34	934.97	13.66	-0.947	0.000	0.088
150.00	-6.83	-2.69	0.00	-63.16	0.00	63.16	1404.94	702.47	1789.74	888.50	14.67	-0.982	0.000	0.076
155.00	-6.38	-2.58	0.00	-49.68	0.00	49.68	1377.99	688.99	1696.65	842.29	15.72	-1.013	0.000	0.064
160.00	-5.96	-2.48	0.00	-36.76	0.00	36.76	1349.68	674.84	1604.25	796.42	16.79	-1.039	0.000	0.051
164.50	-4.19	-1.76	0.00	-25.61	0.00	25.61	1323.05	661.52	1521.82	755.50	17.78	-1.058	0.000	0.037
165.00	-4.16	-1.75	0.00	-24.73	0.00	24.73	1320.02	660.01	1512.71	750.97	17.89	-1.060	0.000	0.036
170.00	-3.82	-1.65	0.00	-15.98	0.00	15.98	1289.00	644.50	1422.20	706.04	19.01	-1.076	0.000	0.026
175.00	-3.49	-1.55	0.00	-7.74	0.00	7.74	1256.62	628.31	1332.89	661.70	20.14	-1.085	0.000	0.014
180.00	0.00	-1.48	0.00	0.00	0.00	0.00	1222.88	611.44	1244.96	618.05	21.28	-1.089	0.000	0.000

Final Analysis Summary

Structure: CT02220-S-SBA	Code: EIA/TIA-222-G	5/23/2018
Site Name: Colchester 2 CT	Exposure: B	
Height: 180.00 (ft)	Crest Height: 0.00	
Base Elev: 0.000 (ft)	Site Class: D - Stiff Soil	
Gh: 1.1	Topography: 1	Struct Class: II



Page: 27

Reactions

Load Case	Shear FX (kips)	Shear FZ (kips)	Axial FY (kips)	Moment MX (ft-kips)	Moment MY (ft-kips)	Moment MZ (ft-kips)
1.2D + 1.6W 101 mph Wind	28.7	0.00	47.95	0.00	0.00	3421.69
0.9D + 1.6W 101 mph Wind	28.6	0.00	35.96	0.00	0.00	3391.75
1.2D + 1.0Di + 1.0Wi 50 mph Wind	7.3	0.00	69.28	0.00	0.00	882.62
1.2D + 1.0E	1.8	0.00	47.99	0.00	0.00	247.77
0.9D + 1.0E	1.8	0.00	35.99	0.00	0.00	245.39
1.0D + 1.0W 60 mph Wind	6.3	0.00	39.99	0.00	0.00	750.89

Max Stresses

Load Case	Pu FY (-) (kips)	Vu FX (-) (kips)	Tu MY (-) (ft-kips)	Mu MZ (ft-kips)	Mu MX (ft-kips)	Resultant Moment (ft-kips)	phi Pn (kips)	phi Vn (kips)	phi Tn (ft-kips)	phi Mn (ft-kips)	Elev (ft)	Stress Ratio
1.2D + 1.6W 101 mph Wind	-47.95	-28.65	0.00	-3421.6	0.00	-3421.6	5525.87	2762.9	13590.7	6747.00	0.00	0.516
0.9D + 1.6W 101 mph Wind	-35.96	-28.64	0.00	-3391.7	0.00	-3391.7	5525.87	2762.9	13590.7	6747.00	0.00	0.509
1.2D + 1.0Di + 1.0Wi 50 mph Wind	-69.28	-7.33	0.00	-882.62	0.00	-882.62	5525.87	2762.9	13590.7	6747.00	0.00	0.143
1.2D + 1.0E	-10.23	-1.26	0.00	-53.91	0.00	-53.91	1489.26	744.63	2121.49	1053.20	132.34	0.058
0.9D + 1.0E	-7.67	-1.24	0.00	-53.29	0.00	-53.29	1489.26	744.63	2121.49	1053.20	132.34	0.056
1.0D + 1.0W 60 mph Wind	-39.99	-6.32	0.00	-750.89	0.00	-750.89	5525.87	2762.9	13590.7	6747.00	0.00	0.119

Base Plate Summary

Structure: CT02220-S-SB	Code: EIA/TIA-222-G	5/23/2018
Site Name: Colchester 2 CT	Exposure: B	
Height: 180.00 (ft)	Crest Height: 0.00	
Base Elev: 0.000 (ft)	Site Class: D - Stiff Soil	
Gh: 1.1	Topography: 1	Struct Class: II



Page: 28

Reactions	Base Plate	Anchor Bolts
Original Design	Yield (ksi): 60.00	Bolt Circle: 68.62
Moment (kip-ft): 5045.00	Width (in): 74.62	Number Bolts: 20.00
Axial (kip): 56.10	Style: Polygon	Bolt Type: 2.25" 18J
Shear (kip): 39.50	Polygon Sides: 16.00	Bolt Diameter (in): 2.25
Analysis	Clip Length (in): 0.00	Yield (ksi): 75.00
Moment (kip-ft): 3421.69	Effective Len (in): 14.44	Ultimate (ksi): 100.00
Axial (kip): 69.28	Moment (kip-in): 530.73	Arrangement: Radial
Shear (kip): 28.65	Allow Stress (ksi): 81.00	Cluster Dist (in): 0.00
	Applied Stress (ksi): 0.00	Start Angle (deg): 0.00
Moment Design %: 67.82	Stress Ratio: 0.36	Compression
		Force (kip): 123.14
		Allowable (kip): 260.00
		Ratio: 0.48
		Tension
		Force (kip): 116.21
		Allowable (kip): 260.00
		Ratio: 0.46



Monopole Mat Foundation Design

Date
5/23/2018

Customer Name:	SBA Communcations Corp	EIA/TIA Standard:	EIA-222-G
Site Name:	Colchester 2 CT	Structure Height (Ft.):	180
Site Number:	CT02220-S-SBA	Engineer Name:	T. Alajaj
Engr. Number:	53617	Engineer Login ID:	

Foundation Info Obtained from:

Drawings/Calculations

Structure Type:

Monopole

Analysis or Design?

Analysis

Base Reactions (Factored):

Axial Load (Kips):	48.0	Shear Force (Kips):	28.7
Uplift Force (Kips):	0.0	Moment (Kips-ft):	3421.7

Allowable overstress %: 5.0%

Foundation Geometries:

Anchor Bolt Circle (ft.):	68.63	Depth of Base BG (ft.):	5.50
Thickness of Pad (ft):	6.00	Width of Pad (ft.):	26
Length of Pad (ft.):	26	Final Length of pad (ft)	26.0
		Final width of pad (ft):	26.0

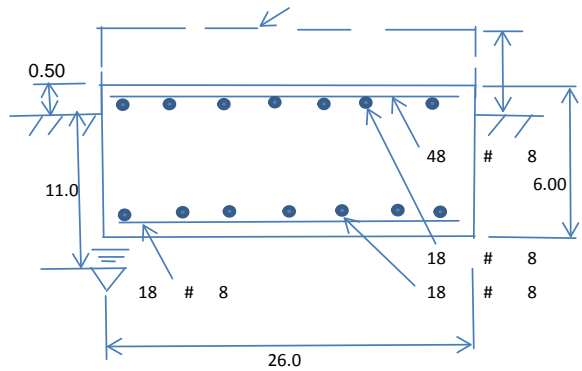

Material Properties and Rebar Info:

Concrete Strength (psi):	3000	Steel Elastic Modulus:	29000	ksi
Pad Rebar Yield (Ksi):	60	Tie Spacing (in):	8.0	
Pad Steel Rebar Size (#):	8	Unit Weight of Concrete:	150.0	pcf
Concrete Cover (in.):	3			
Rebar at the bottom of the concrete pad:				
Qty. of Rebar in Pad (L):	48	Qty. of Rebar in Pad (W):	48	
Rebar at the top of the concrete pad:				
Qty. of Rebar in Pad (L):	18	Qty. of Rebar in Pad (W):	18	

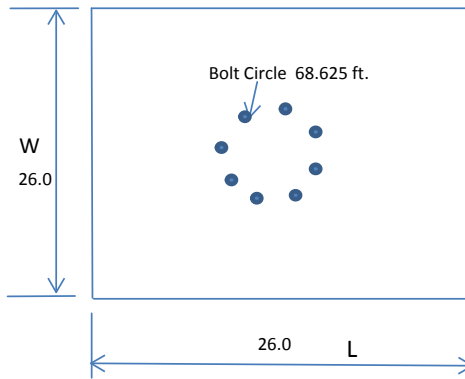

Apply 1.35 factor for e/w Per G: 1.35

Soil Design Parameters:

Water Table B.G.S. (ft):	11.0	Unit Weight of Water:	62.4	pcf	Angle from Top of Pad:	30
Ultimate Bearing Pressure (psf):	25000	Ultimate Skin Friction:	0	Psf	Angle from Bottm of Pad:	25
Consider Friction for O.T.M. (Y/N):	No	Consider Friction for bearing (Y/N):	No		Angle from Bottm of Pad:	25
Consider soil hor. resist. for OTM.:	No	Reduction factor on the maximum soil bearing pressure:	1.00			

Foundation Analysis and Design:

Uplift Strength Reduction Factor:	0.75	Compression Strength Reduction Factor:	0.75
Total Dry Soil Volume (cu. Ft.):	0.00	Total Dry Soil Weight (Kips):	0.00
Total Buoyant Soil Volume (cu. Ft.):	0.00	Total Buoyant Soil Weight (Kips):	0.00
Total Effective Soil Weight (Kips):	0.00	Weight from the Concrete Block at Top (K):	0.00
Total Dry Concrete Volume (cu. Ft.):	4056.00	Total Dry Concrete Weight (Kips):	608.40
Total Buoyant Concrete Volume (cu. Ft.):	0.00	Total Buoyant Concrete Weight (Kips):	0.00
Total Effective Concrete Weight (Kips):	608.40	Total Vertical Load on Base (Kips):	656.35

Check Soil Capacities:

Calculated Maxium Net Soil Pressure under the base (psf):	2767	<	Allowable Factored Soil Bearing (psf):	18750	0.15	OK!
Allowable Foundation Overturning Resistance (kips-ft.):	7741.6	>	Design Factored Momnt (kips-ft):	3595	0.46	OK!
Factor of Safety Against Overturning (O. R. Moment/Design Moment):	2.15					OK!

Load/
Capacity
Ratio

Check the capacities of Reinforcing Concrete:

Strength reduction factor (Flexure and axial tension):	0.90	Strength reduction factor (Shear):	0.75
Strength reduction factor (Axial compression):	0.65	Wind Load Factor on Concrete Design:	1.00

Concrete Pad:

One-Way Design Shear Capacity (L-Direction, Kips):	1755.9	>	One-Way Factored Shear (L-D. Kips):	0.0	0.00	OK!
One-Way Design Shear Capacity (W-Direction, Kips):	1755.9	>	One-Way Factored Shear (W-D., Kips)	0.0	0.00	OK!
One-Way Design Shear Capacity (Corner-Corner. Kips):	2185.1	>	One-Way Factored Shear (C-C, Kips):	724.2	0.33	OK!
Lower Steel Pad Reinforcement Ratio (L-Direct.):	0.0018	OK!	Lower Steel Pad Reinf. Ratio (W-Direc	0.0018		
Lower Steel Pad Moment Capacity (L-Direction. Kips-ft):	11444.8	>	Moment at Bottom (L-Direct. K-Ft):	0.0	0.00	OK!
Lower Steel Pad Moment Capacity (W-Direction. Kips-ft):	11444.8	>	Moment at Bottom (W-Direct. K-Ft):	0.0	0.00	OK!
Lower Steel Pad Moment Capacity (Corner-Corner,K-ft):	16922.6	>	Moment at Bottom (C-C Dir. K-Ft):	0.0	0.00	OK!
Upper Steel Pad Reinforcement Ratio (L-Direct.):	0.0007	OK!	Upper Steel Reinf. Ratio (W-Direct.):	0.0007		
Upper Steel Pad Moment Capacity (L-Direction. Kips-ft):	4349.0	>	Moment at the top (L-Dir Kips-Ft):	803.0	0.18	OK!
Upper Steel Pad Moment Capacity (W-Direction. Kips-ft):	4349.0	>	Moment at the top (W-Dir Kips-Ft):	803.0	0.18	OK!
Upper Steel Pad Moment Capacity (Corner-Corner. K-ft):	6254.1	>	Moment at the top (C-C Direc. K-Ft):	-590.0	-0.09	OK!

Antenna Mount Structural Analysis



Source: SBA Date: 11.14.2017

SBA Site: CT02220-S Colchester 2 CT
Sprint Site Number: CT33XC575
Project: Sprint D0 Macro Upgrade

Prepared For: Sprint

Mount Description: (1) Platform

Site Location: 31 Chestnut Hill Rd, Colchester, CT
New London County
41.571327°, -72.302322°

Design Codes: ANSI/TIA-222-G
IBC 2012 w/ 2016 CT Building Code

Analysis Load Case: Sprint Final Configuration

Analysis Result: Adequate @ 80% - **Once Augmented**
See Conclusion

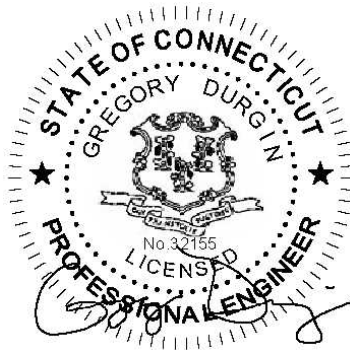

Revision 0
March 21, 2018

CT33XC575-PASSING-MOUNT-STRUCTURAL-ANALYSIS-03-21-18

1.0 Introduction

An antenna mount structural analysis has been performed on Sprint's existing mount assembly located at the CT02220-S Colchester 2 CT communications site in New London County, CT considering the final equipment loading configuration listed in Section 3.0.

2.0 Analysis Criteria

An elastic three-dimensional model of the mount structure has been analyzed pursuant to the following criteria:

- IBC 2012 - International Building Code.
- ANSI/TIA-222-G - Structural Standard for Antenna Supporting Structures and Antennas.
- AISC - Steel Construction Manual.
- ANSI/AWS D1.1 - Structural Welding Code.

Wind w/o ice = 130 mph (3-sec gust Ultimate Wind Speed)	
Wind w/o ice = 101 mph (3-sec gust Equivalent per TIA-222-G Tower Code)	
Wind with ice = 50 mph (3-sec gust, 3/4" Ice)	Topographic Category 1
Exposure Category B	Structure Class II

The following documents were provided:

<ul style="list-style-type: none"> • <u>Mount and Tower Record Documents</u> SBA • <u>Tower Structural Analysis</u> TES, 1/17/18. • <u>RF Design</u> Sprint DOMU Project

The results of the analysis are illustrated in Section 4.0. If any of the existing or proposed conditions reported in this analysis are not properly represented, please contact our office immediately to request an amended report.

3.0 Appurtenance Information

Table 3.1 – Sprint Final Configuration¹

COR	(Quantity) Appurtenance Make/Model	Mount Description
180.0'±	(3) RFS APXVTM14-ALU-I20	(1) Platform
	(3) COMMSCOPE NNVV-65B-R4	
	(6) ALU 800MHz RRH	
	(3) ALU 1900MHz RRH	
	(3) ALU 2500MHz RRH	

1. Refer to antenna installation Construction Drawings (by others, when applicable) for additional information regarding final antenna and equipment orientations.
2. Panel antennas to be installed in Positions 1 and 3 (as close to the center of face near existing standoff as possible. RRH units to be installed on dual swivel brackets behind panel antennas in Positions 1 and 3.

4.0 Analysis Results

Table 4.1 – Existing Mount Capacity

Load Case	Governing Mount Component ¹	% Capacity ²	Result
Final Sprint Configuration	Angle Rail	>200%	Inadequate ³

1. Refer to the Calculations & Software Output portion of this report for mount component and structural information.
2. Listed results are expressed as a percentage of available mount member capacity based upon the assumed material strengths listed in Table 4.3. 105% is an acceptable allowable stress percentage for mount components.
3. Structural augments to the existing mount structure are required to obtain a mount structure capable of supporting the currently proposed final loading configuration in Table 3.1.

Table 4.2 – Augmented Mount Capacity

Load Case	Governing Mount Component ¹	% Capacity ²	Result
Final Sprint Configuration	Angle Rail	80%	Adequate Once Augmented³

1. Refer to the Calculations & Software Output portion of this report for mount component and structural information.
2. Listed results are expressed as a percentage of available mount member capacity based upon the assumed material strengths listed in Table 4.3. 105% is an acceptable allowable stress percentage for mount components.
3. Refer to GeoStructural Mount Augmentation Drawings and Section 5.0 for information regarding required mount augments.

Table 4.3 – Structural Component Material Strengths

Structural Component	Nominal Strength/Material ⁴
Pipe	F _y = 35 ksi (A53, Gr. B)
Tube	F _y = 46 ksi (A500, Gr. B)
Structural Shapes (L, C, W, etc.), Plate / Bar	F _y = 36 ksi (A36)
Uni-Strut	F _y = 33 ksi (A570, Gr. 33)
Connection Bolts	A325
Stainless Steel Bolts	18-8 Stainless, Grade 316/304 F _y = 74 ksi (Yield) & F _u = 29 ksi (Tension)
U-Bolts / Threaded Rod	SAE J429 Grade 2 (Substitution: ASTM A449) F _y = 57 ksi (Yield) & F _u = 74 ksi (Tension)
Welds	E70XX Electrodes

1. Strengths listed were assumed for this analysis and are based upon ASTM, AISC, RCSC, AWS and ACI preferred specification values. Values and materials are consistent with industry standards. Material strengths were taken from original design documents when available.

5.0 Conclusion & Recommendations

Based on Sprint's final equipment loading configuration, the existing mount assembly does not have sufficient capacity to support the loading considered in this analysis pursuant to the listed standards. Structural augments (reinforcements) will be required and are briefly summarized below:

- Install **Platform Reinforcement Kit**; located 4' below the existing collar mount and attaching to the middle of the existing back-to-back angle platform member at the platform corners.
 - Sitepro1 PRK-1245L, (1) total.
- Install **Handrail Kit**; located 3.0' above the existing platform rail and attaching to the mount pipes.
 - Sitepro1 HRK14-U, (1) total. Attach all mount pipes to new handrail with kit-provided cross-over plates. (6) new Pipe2.0STD x 9' tall mount pipes will be required to span between the existing rail and new top and bottom rails.
- Install **V-Brace Kit**; located 2.5' below the existing platform rail and attaching to the new bottom handrail kit.
 - Sitepro1 PRK-SFS-H-L, (1) total. Attach kit ring mount in kit to monopole shaft.
 - If the PRK-SFS-H-L kit is not available, provide (6) total L2-1/2x2-1/2x3/16 x ~8' long replacement angles, field-cut and drill to suit.
 - Pipe2.0STD x 14.0' Horizontal Rail, (3) total. Attach SFS-H-L kit angles to new horizontal bottom rail.
 - Pipe2.0STD x ~4' long corner braces, (3) total. Attach to new horizontal bottom rail w/ Sitepro1 PUCK brackets, (6) total.
 - Sitepro1 SCX1-K, (6) total. Attach all mount pipes to new horizontal bottom rail.
- Panel antennas to be installed in Positions 1 and 3 (as close to the center of face near existing standoff as possible. RRH units to be installed on dual swivel brackets behind panel antennas in Positions 1 and 3.

Once the recommended augments are successfully implemented, the **augmented** mount assembly has sufficient capacity to support the loading considered in this analysis pursuant to the listed standards.

Augmentation Requirements:

- **In order to obtain a mount structure capable of supporting the currently proposed final loading configuration, upgrade augments must be installed in accordance with GeoStructural's Mount Augmentation Drawings.**
- **Antennas and equipment shall be installed centered vertically on the mount front face rails. If this assumption is incorrect, the results of this analysis will be affected.**

This analysis only encompasses the antenna mount assembly. The tower, overall mount support structure, foundation, etc. are beyond the scope of this analysis. If any of the existing or proposed conditions (appurtenance loading, member sizes, etc.) reported in this analysis are not properly represented, please contact our office immediately to request an amended report.

Prepared by:



Jesse Drennen, PE, MLE
208.761.7986
jesse.drennen@geostructural.com

Reviewed and Approved by:



Don George, PE, SE, MLSE
208.602.6569
don.george@geostructural.com

6.0 Standard Conditions

- All data required to complete our structural analysis was furnished by our client and provided record data. GeoStructural has not conducted a site visit or independent study to verify existing conditions and the results of this analysis are based solely on the information provided. It has been assumed that the tower, antenna support structure and foundation have been constructed according to the provided existing drawings, previous structural analysis reports, mapping documents, etc.
- The default Structure Classification is Class II in accordance with ANSI/TIA-222-G §A.2.2 & §A.15.3 and has been assumed for this analysis. The owner shall verify this classification conforms with original or desired reliability criteria.
- This analysis assumes that the structure has been properly installed and maintained in accordance with ANSI/TIA-222-G §15.5 and that no physical deterioration has occurred in any of the components of the structure. Damaged, missing, or rusted members were not considered.
- This analysis verifies the adequacy of the main components of the structure. Not all connections, welds, bolts, plates, etc. were individually detailed and analyzed. Where not specifically analyzed, the existing connection plates, welds, bolts, etc. were assumed adequate to develop the full capacity of the main structural members.
- No consideration has been made for unusual or extreme wind events, rime/in-cloud ice loadings, harmonic or nodal vibration, vortex shedding or other similar conditions.
- It is the owner's responsibility to determine the appropriate design wind speed and amount of ice accumulation beyond code minimum values that should be considered in the analysis.
- This analysis report does not constitute a maintenance and condition assessment. No certifications regarding maintenance and condition are expressed or implied. If desired, GeoStructural can provide these services under a subsequent contract.
- This analysis only encompasses the antenna mount assembly. The tower, overall mount support structure, foundation, etc. are beyond the scope of this analysis. If desired, GeoStructural can provide these services under a subsequent contract.

7.0 Calculations & Software Output

This page intentionally left blank.

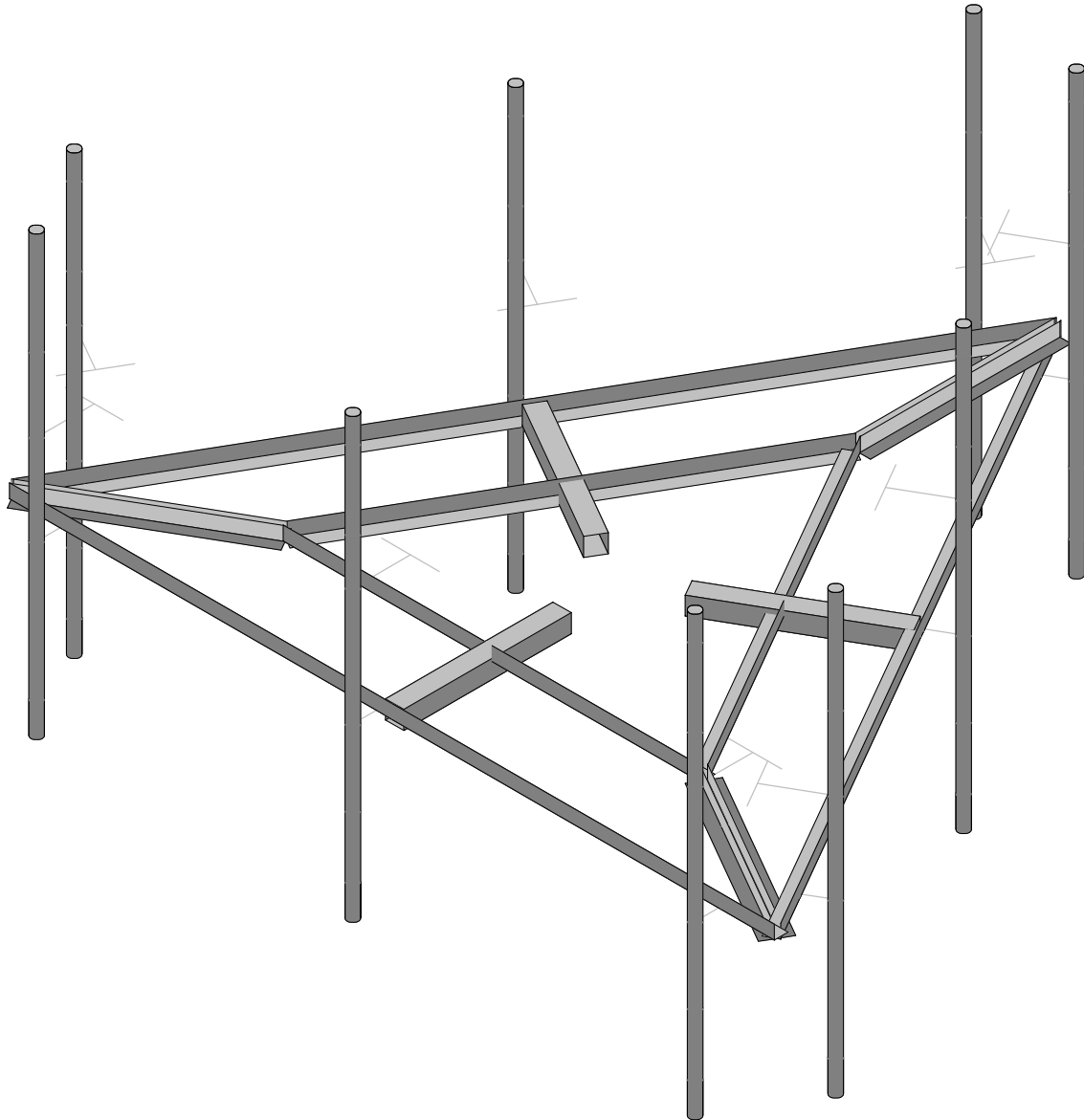
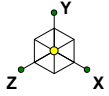

Envelope Only Solution

GeoStructural, LLC

Jesse Drennen, PE

CT33XC575

SK - 1

Mar 21, 2018 at 1:03 PM

CT33XC575_Mount Analysis_R0 1...

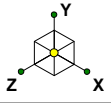

Code Check (Env)	
Black	No Calc
Red	> 1.0
Magenta	.90-1.0
Green	.75-.90
Cyan	.50-.75
Blue	0-.50

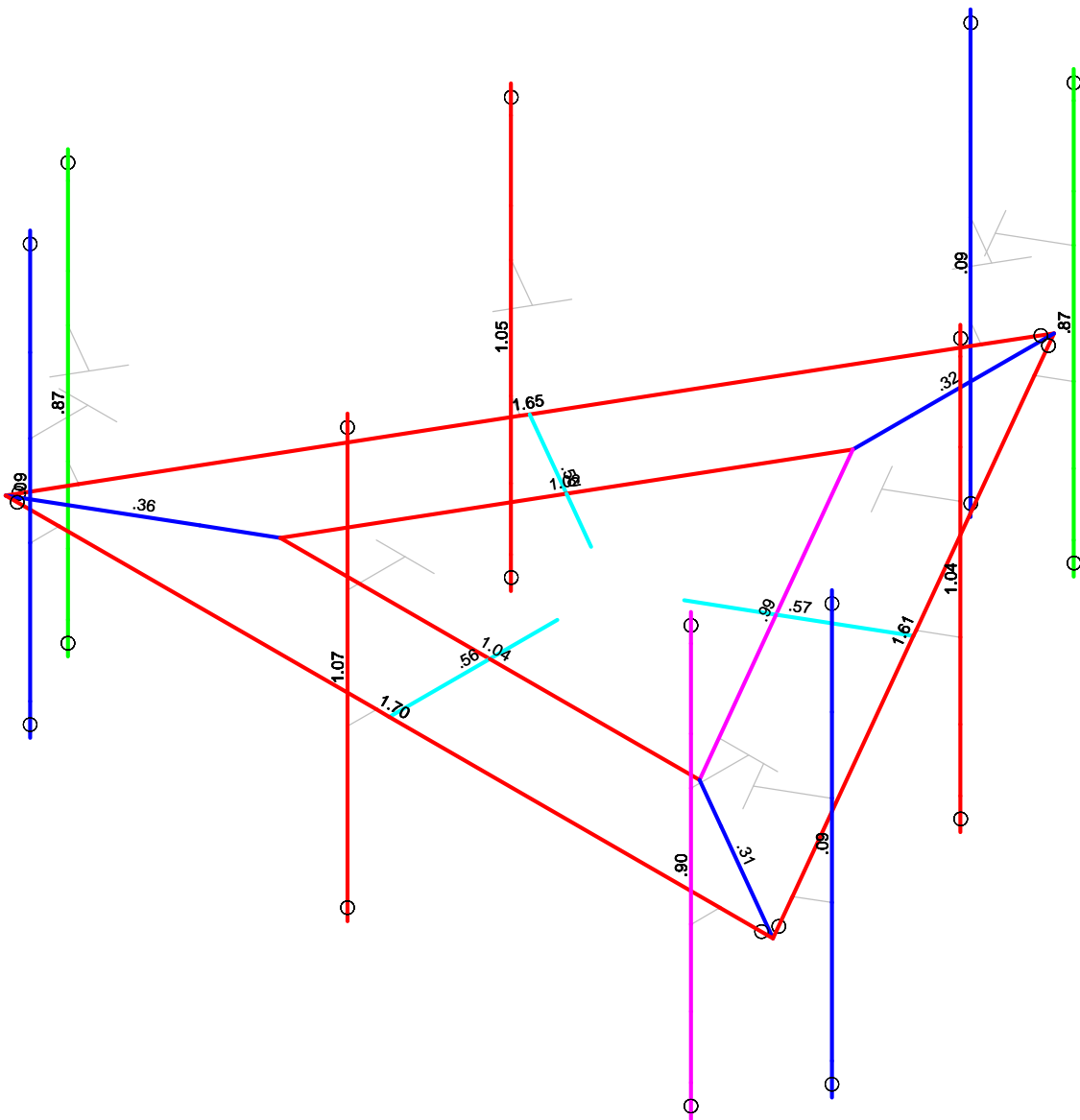

Member Code Checks Displayed (Enveloped)
Envelope Only Solution

GeoStructural, LLC

Jesse Drennen, PE

CT33XC575

SK - 2

Mar 21, 2018 at 1:03 PM

CT33XC575_Mount Analysis_R0 1...

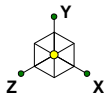

Shear Check
(Env)

- No Calc
- > 1.0
- .90-1.0
- .75-.90
- .50-.75
- 0-.50

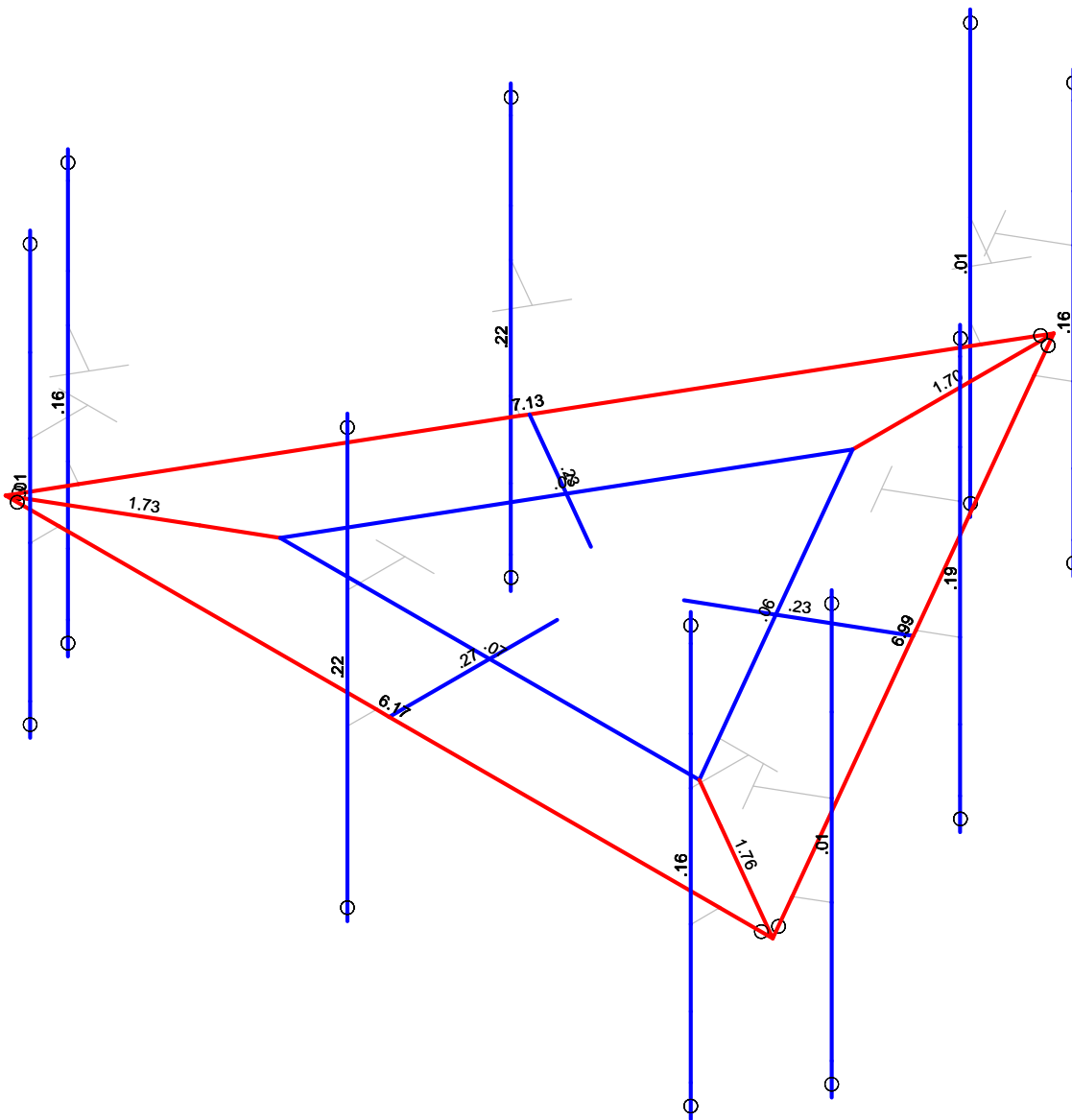

Member Shear Checks Displayed (Enveloped)
Envelope Only Solution

GeoStructural, LLC

Jesse Drennen, PE

CT33XC575

SK - 3

Mar 21, 2018 at 1:03 PM

CT33XC575_Mount Analysis_R0 1...

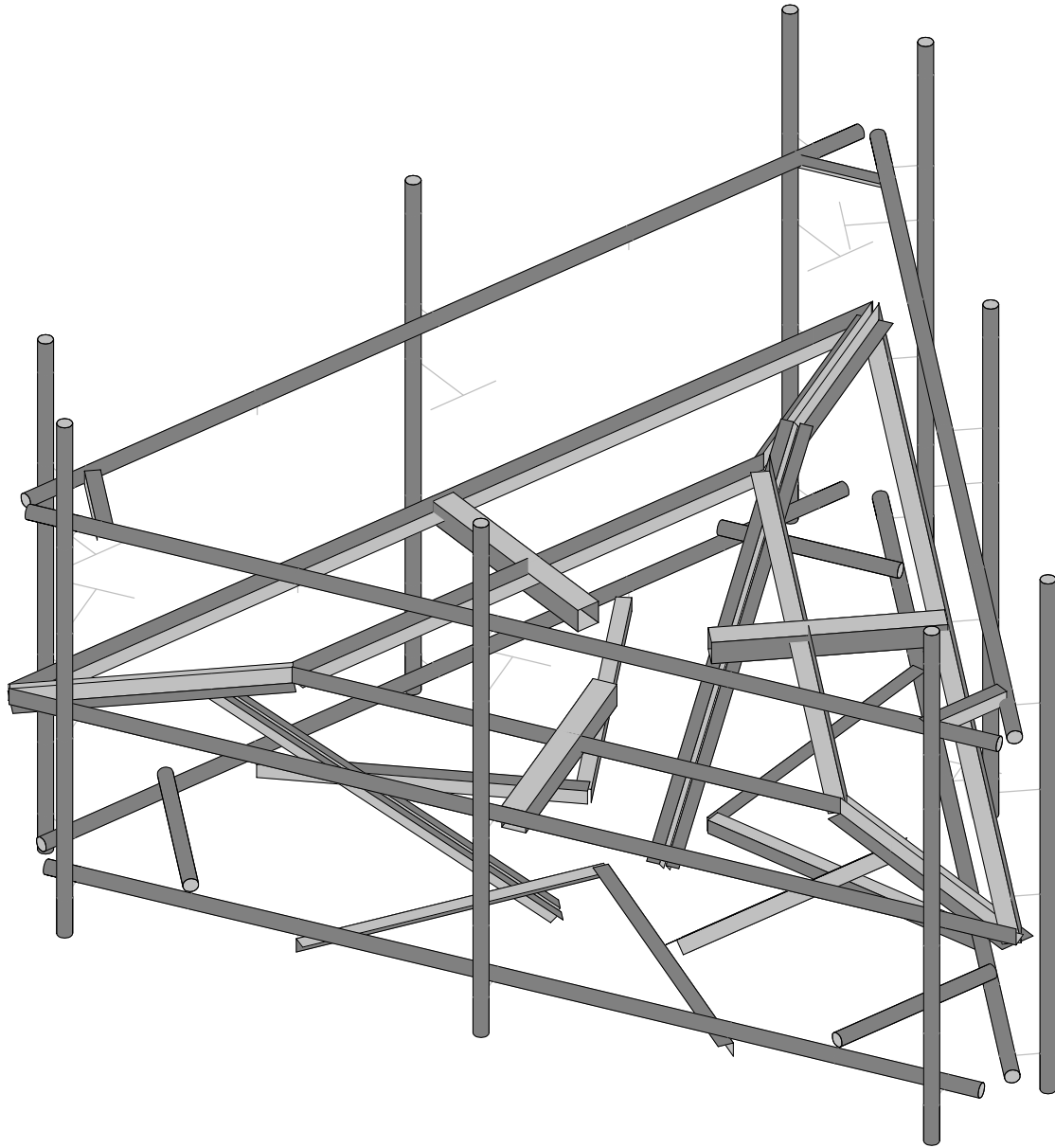
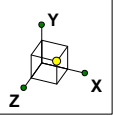

Envelope Only Solution

GeoStructural, LLC

Jesse Drennen, PE

CT33XC575

SK - 1

Mar 21, 2018 at 1:12 PM

CT33XC575_Mount Analysis_R0 1...

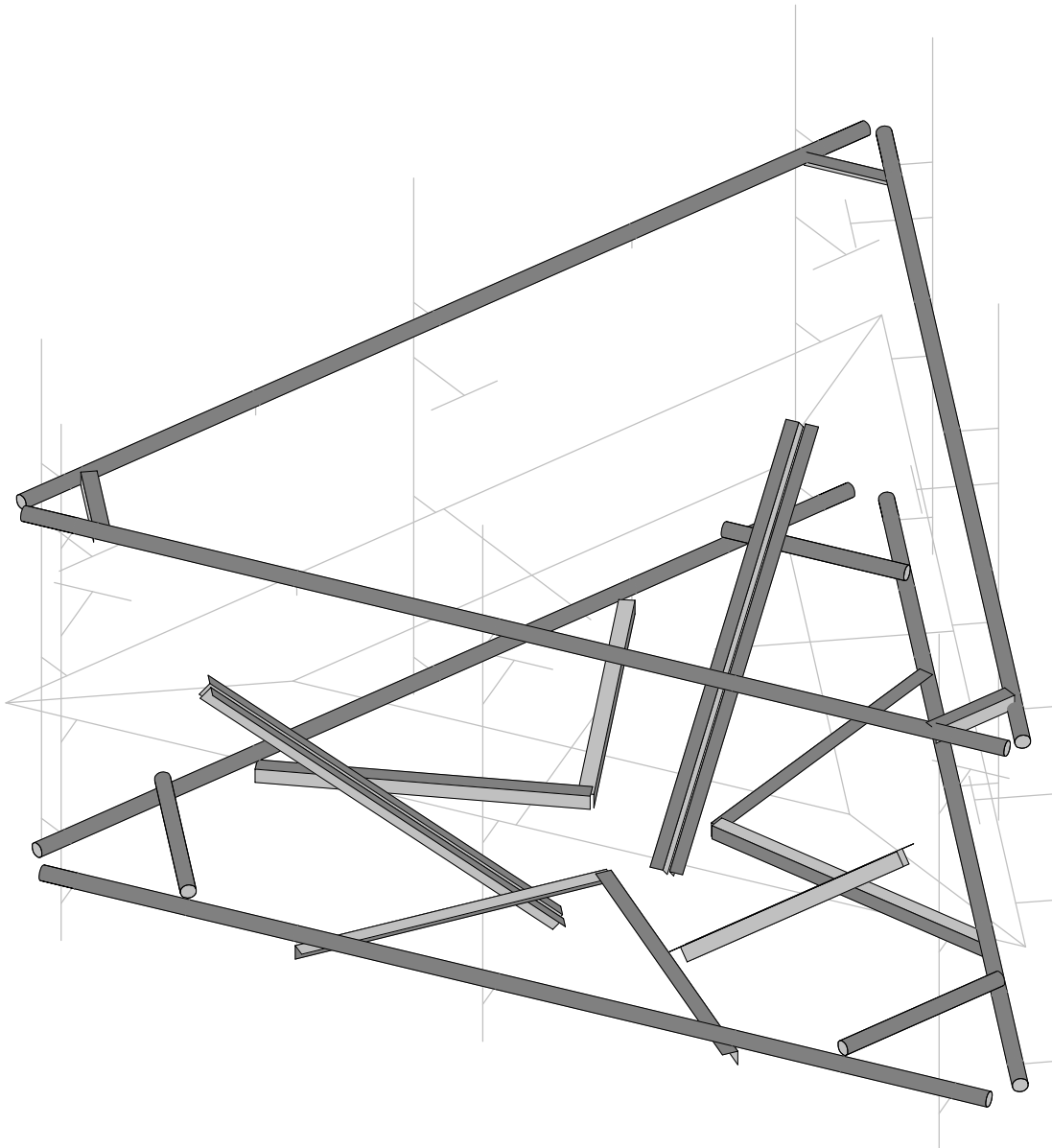
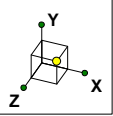

Envelope Only Solution

GeoStructural, LLC

Jesse Drennen, PE

CT33XC575

SK - 7

Mar 21, 2018 at 1:13 PM

CT33XC575_Mount Analysis_R0 1...

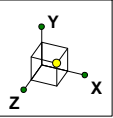

Code Check
(Env)

- █ No Calc
- █ > 1.0
- █ .90-1.0
- █ .75-.90
- █ .50-.75
- █ 0-.50

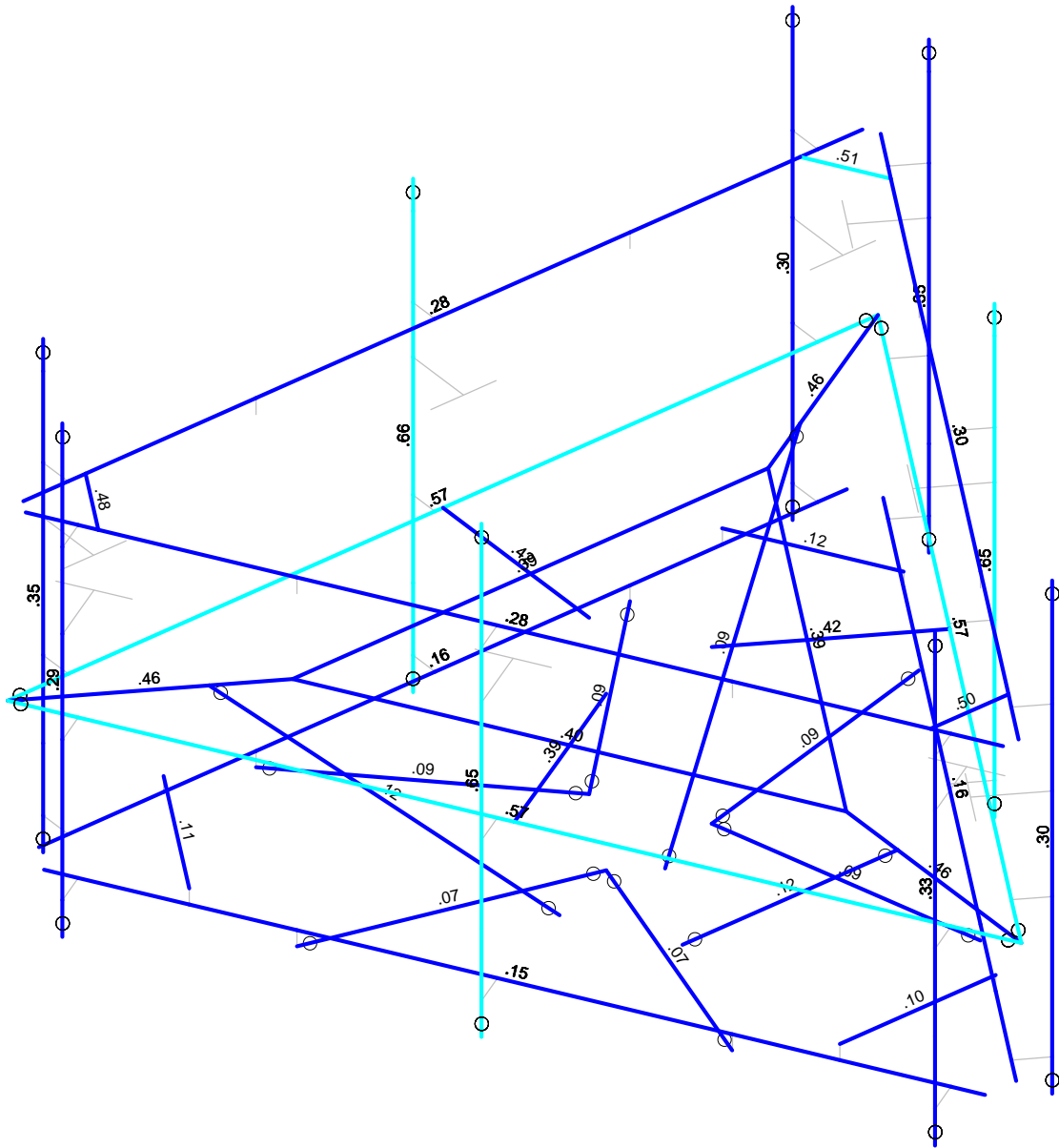

Member Code Checks Displayed (Enveloped)
Envelope Only Solution

GeoStructural, LLC

Jesse Drennen, PE

CT33XC575

SK - 2

Mar 21, 2018 at 1:12 PM

CT33XC575_Mount Analysis_R0 1...

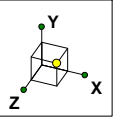

Shear Check
(Env)

- No Calc
- > 1.0
- .90-1.0
- .75-.90
- .50-.75
- 0-.50

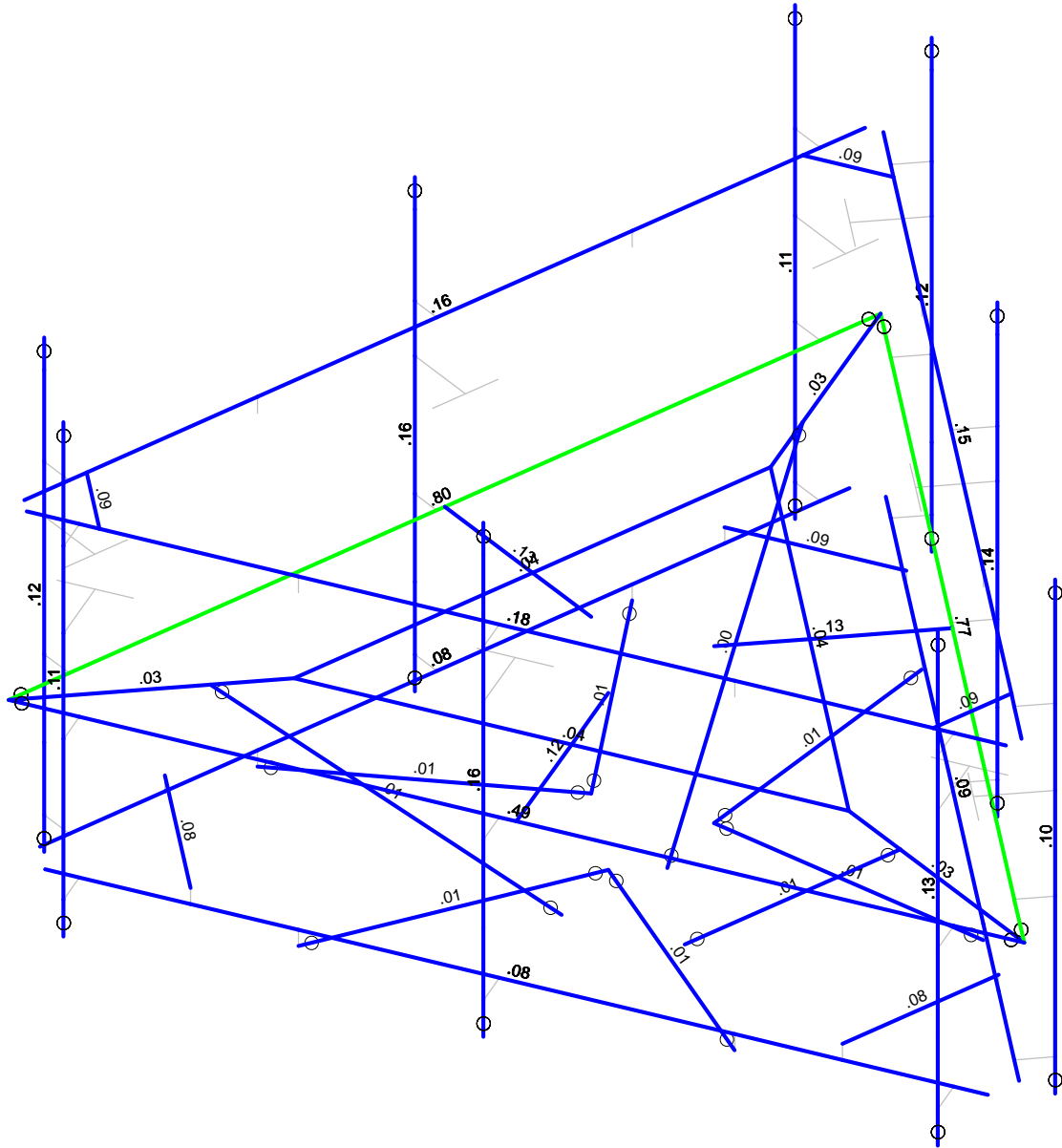

Member Shear Checks Displayed (Enveloped)
Envelope Only Solution

GeoStructural, LLC

Jesse Drennen, PE

CT33XC575

SK - 3

Mar 21, 2018 at 1:12 PM

CT33XC575_Mount Analysis_R0 1...

Basic Load Cases

	BLC Description	Category	X Gravity	Y Gravity	Z Gravity	Joint	Point	Distributed Area(Me...	Surface(P...
1	D	DL		-1		25		6	
2	Di	SL				25		48	
3	Lm [500]	LL				1			
4	Lv [250]	LL				2			
5	Woz	WL				25		48	
6	Wox	WL				25		48	
7	Wiz	WL				25		48	
8	Wix	WL				25		48	
9	Ez	EL				25			
10	Ex	EL				25			

Load Combination Design

	Description	ASIF	CD	Service	Hot Rol...	Cold Form...	Wood	Concrete	Masonry	Aluminum	Stainless	Connection
1	1) 1.4D				Yes	Yes	Yes	Yes	Yes	Yes	Yes	Yes
2	2) 1.2D+1.0...				Yes	Yes	Yes	Yes	Yes	Yes	Yes	Yes
3	2) 1.2D+1.0...				Yes	Yes	Yes	Yes	Yes	Yes	Yes	Yes
4	2) 1.2D+1.0...				Yes	Yes	Yes	Yes	Yes	Yes	Yes	Yes
5	2) 1.2D+1.0...				Yes	Yes	Yes	Yes	Yes	Yes	Yes	Yes
6	2) 1.2D+1.0...				Yes	Yes	Yes	Yes	Yes	Yes	Yes	Yes
7	2) 1.2D+1.0...				Yes	Yes	Yes	Yes	Yes	Yes	Yes	Yes
8	2) 1.2D+1.0...				Yes	Yes	Yes	Yes	Yes	Yes	Yes	Yes
9	2) 1.2D+1.0...				Yes	Yes	Yes	Yes	Yes	Yes	Yes	Yes
10	2) 1.2D+1.0...				Yes	Yes	Yes	Yes	Yes	Yes	Yes	Yes
11	2) 1.2D+1.0...				Yes	Yes	Yes	Yes	Yes	Yes	Yes	Yes
12	2) 1.2D+1.0...				Yes	Yes	Yes	Yes	Yes	Yes	Yes	Yes
13	2) 1.2D+1.0...				Yes	Yes	Yes	Yes	Yes	Yes	Yes	Yes
14	3) 0.9D+1.0...				Yes	Yes	Yes	Yes	Yes	Yes	Yes	Yes
15	3) 0.9D+1.0...				Yes	Yes	Yes	Yes	Yes	Yes	Yes	Yes
16	3) 0.9D+1.0...				Yes	Yes	Yes	Yes	Yes	Yes	Yes	Yes
17	3) 0.9D+1.0...				Yes	Yes	Yes	Yes	Yes	Yes	Yes	Yes
18	3) 0.9D+1.0...				Yes	Yes	Yes	Yes	Yes	Yes	Yes	Yes
19	3) 0.9D+1.0...				Yes	Yes	Yes	Yes	Yes	Yes	Yes	Yes
20	3) 0.9D+1.0...				Yes	Yes	Yes	Yes	Yes	Yes	Yes	Yes
21	3) 0.9D+1.0...				Yes	Yes	Yes	Yes	Yes	Yes	Yes	Yes
22	3) 0.9D+1.0...				Yes	Yes	Yes	Yes	Yes	Yes	Yes	Yes
23	3) 0.9D+1.0...				Yes	Yes	Yes	Yes	Yes	Yes	Yes	Yes
24	3) 0.9D+1.0...				Yes	Yes	Yes	Yes	Yes	Yes	Yes	Yes
25	3) 0.9D+1.0...				Yes	Yes	Yes	Yes	Yes	Yes	Yes	Yes
26	4) 1.2D+1.0...				Yes	Yes	Yes	Yes	Yes	Yes	Yes	Yes
27	4) 1.2D+1.0...				Yes	Yes	Yes	Yes	Yes	Yes	Yes	Yes
28	4) 1.2D+1.0...				Yes	Yes	Yes	Yes	Yes	Yes	Yes	Yes
29	4) 1.2D+1.0...				Yes	Yes	Yes	Yes	Yes	Yes	Yes	Yes
30	4) 1.2D+1.0...				Yes	Yes	Yes	Yes	Yes	Yes	Yes	Yes
31	4) 1.2D+1.0...				Yes	Yes	Yes	Yes	Yes	Yes	Yes	Yes
32	4) 1.2D+1.0...				Yes	Yes	Yes	Yes	Yes	Yes	Yes	Yes
33	4) 1.2D+1.0...				Yes	Yes	Yes	Yes	Yes	Yes	Yes	Yes
34	4) 1.2D+1.0...				Yes	Yes	Yes	Yes	Yes	Yes	Yes	Yes
35	4) 1.2D+1.0...				Yes	Yes	Yes	Yes	Yes	Yes	Yes	Yes
36	4) 1.2D+1.0...				Yes	Yes	Yes	Yes	Yes	Yes	Yes	Yes
37	4) 1.2D+1.0...				Yes	Yes	Yes	Yes	Yes	Yes	Yes	Yes
38	5) 1.2D+1.5L...				Yes	Yes	Yes	Yes	Yes	Yes	Yes	Yes
39	5) 1.2D+1.5L...				Yes	Yes	Yes	Yes	Yes	Yes	Yes	Yes
40	5) 1.2D+1.5L...				Yes	Yes	Yes	Yes	Yes	Yes	Yes	Yes
41	5) 1.2D+1.5L...				Yes	Yes	Yes	Yes	Yes	Yes	Yes	Yes

Load Combination Design (Continued)

	Description	ASIF	CD	Service	Hot Rol...	Cold Form...	Wood	Concrete	Masonry	Aluminum	Stainless	Connection
42	5) 1.2D+1.5L...				Yes	Yes	Yes	Yes	Yes	Yes	Yes	Yes
43	5) 1.2D+1.5L...				Yes	Yes	Yes	Yes	Yes	Yes	Yes	Yes
44	5) 1.2D+1.5L...				Yes	Yes	Yes	Yes	Yes	Yes	Yes	Yes
45	5) 1.2D+1.5L...				Yes	Yes	Yes	Yes	Yes	Yes	Yes	Yes
46	5) 1.2D+1.5L...				Yes	Yes	Yes	Yes	Yes	Yes	Yes	Yes
47	5) 1.2D+1.5L...				Yes	Yes	Yes	Yes	Yes	Yes	Yes	Yes
48	5) 1.2D+1.5L...				Yes	Yes	Yes	Yes	Yes	Yes	Yes	Yes
49	5) 1.2D+1.5L...				Yes	Yes	Yes	Yes	Yes	Yes	Yes	Yes
50	6) 1.2D+1.5Lv				Yes	Yes	Yes	Yes	Yes	Yes	Yes	Yes
51	7) (1.2+0.2Sd...				Yes	Yes	Yes	Yes	Yes	Yes	Yes	Yes
52	7) (1.2+0.2Sd...				Yes	Yes	Yes	Yes	Yes	Yes	Yes	Yes
53	7) (1.2+0.2Sd...				Yes	Yes	Yes	Yes	Yes	Yes	Yes	Yes
54	7) (1.2+0.2Sd...				Yes	Yes	Yes	Yes	Yes	Yes	Yes	Yes
55	7) (1.2+0.2Sd...				Yes	Yes	Yes	Yes	Yes	Yes	Yes	Yes
56	7) (1.2+0.2Sd...				Yes	Yes	Yes	Yes	Yes	Yes	Yes	Yes
57	7) (1.2+0.2Sd...				Yes	Yes	Yes	Yes	Yes	Yes	Yes	Yes
58	7) (1.2+0.2Sd...				Yes	Yes	Yes	Yes	Yes	Yes	Yes	Yes
59	7) (1.2+0.2Sd...				Yes	Yes	Yes	Yes	Yes	Yes	Yes	Yes
60	7) (1.2+0.2Sd...				Yes	Yes	Yes	Yes	Yes	Yes	Yes	Yes
61	7) (1.2+0.2Sd...				Yes	Yes	Yes	Yes	Yes	Yes	Yes	Yes
62	7) (1.2+0.2Sd...				Yes	Yes	Yes	Yes	Yes	Yes	Yes	Yes
63	8) (0.9-0.2Sd...				Yes	Yes	Yes	Yes	Yes	Yes	Yes	Yes
64	8) (0.9-0.2Sd...				Yes	Yes	Yes	Yes	Yes	Yes	Yes	Yes
65	8) (0.9-0.2Sd...				Yes	Yes	Yes	Yes	Yes	Yes	Yes	Yes
66	8) (0.9-0.2Sd...				Yes	Yes	Yes	Yes	Yes	Yes	Yes	Yes
67	8) (0.9-0.2Sd...				Yes	Yes	Yes	Yes	Yes	Yes	Yes	Yes
68	8) (0.9-0.2Sd...				Yes	Yes	Yes	Yes	Yes	Yes	Yes	Yes
69	8) (0.9-0.2Sd...				Yes	Yes	Yes	Yes	Yes	Yes	Yes	Yes
70	8) (0.9-0.2Sd...				Yes	Yes	Yes	Yes	Yes	Yes	Yes	Yes
71	8) (0.9-0.2Sd...				Yes	Yes	Yes	Yes	Yes	Yes	Yes	Yes
72	8) (0.9-0.2Sd...				Yes	Yes	Yes	Yes	Yes	Yes	Yes	Yes
73	8) (0.9-0.2Sd...				Yes	Yes	Yes	Yes	Yes	Yes	Yes	Yes
74	8) (0.9-0.2Sd...				Yes	Yes	Yes	Yes	Yes	Yes	Yes	Yes

Envelope Joint Reactions

	Joint		X [k]	LC	Y [k]	LC	Z [k]	LC	MX [k-ft]	LC	MY [k-ft]	LC	MZ [k-ft]	LC
1	N25	max	0	1	0	1	0	1	0	1	0	1	0	1
2		min	0	1	0	1	0	1	0	1	0	1	0	1
3	N30	max	0	1	0	1	0	1	0	1	0	1	0	1
4		min	0	1	0	1	0	1	0	1	0	1	0	1
5	N35	max	0	1	0	1	0	1	0	1	0	1	0	1
6		min	0	1	0	1	0	1	0	1	0	1	0	1
7	N42	max	2.38	16	1.188	34	3.423	3	2.257	36	3.456	21	3.843	35
8		min	-2.657	10	.291	65	-3.248	21	.457	18	-3.468	3	.8	66
9	N40	max	2.72	6	1.212	26	3.284	13	2.238	27	3.289	25	-.813	71
10		min	-2.434	24	.296	69	-3.132	19	.425	22	-3.3	7	-3.905	28
11	N44	max	3.12	5	1.194	34	1.484	14	-.957	63	2.196	5	.102	23
12		min	-3.094	23	.29	65	-1.809	8	-4.472	32	-2.171	23	-.122	5
13	N128	max	.06	17	1.941	26	-.122	20	0	1	0	66	0	60
14		min	-.06	23	.054	20	-2.066	26	0	1	0	60	0	66
15	N130	max	-.082	24	1.937	30	1.03	30	0	4	0	22	0	22
16		min	-1.784	30	.012	24	.03	23	0	22	0	4	0	4
17	N132	max	1.801	34	1.955	34	1.04	34	0	24	0	24	0	24
18		min	.118	16	.049	16	.055	17	0	6	0	6	0	6
19	N147	max	.074	72	.066	26	.326	57	0	26	0	1	0	23

Envelope Joint Reactions (Continued)

Joint	X [k]	LC	Y [k]	LC	Z [k]	LC	MX [k-ft]	LC	MY [k-ft]	LC	MZ [k-ft]	LC		
20	min	-139	43	.009	69	-.171	63	0	20	0	1	0	5	
21	N152	max	.273	61	.066	30	.099	68	0	15	0	1	0	22
22	min	-.143	67	.009	73	-.19	62	0	9	0	1	0	28	
23	N157	max	.138	71	.066	34	.103	70	0	25	0	1	0	36
24	min	-.289	53	.009	65	-.172	52	0	43	0	1	0	18	
25	Totals:	max	6.916	5	9.308	31	6.801	14						
26	min	-6.916	23	2.223	74	-6.801	8							

Envelope Member Section Deflections Service

Member	Sec	x [in]	LC	y [in]	LC	z [in]	LC	x Rotate [r...	LC	(n) L/y' Ratio	LC	(n) L/z' Ratio	LC
No Data to Print ...													

Envelope AISC 14th(360-10): LRFD Steel Code Checks

Member	Shape	Code Check	Loc[ft]	LC	Shear	Loc[ft]	Dir	LC	phi*Pnc...	phi*Pnt...	phi*Mn...	phi*Mn...	Cb	Eqn
1	M66	L3x3x4	.567	6.983	7	.800	6.983	y	10	32.733	46.656	1.688	2.278	1 H2-1
2	M65	L3x3x4	.569	6.983	3	.772	6.983	y	6	32.733	46.656	1.688	2.278	1 H2-1
3	M64 1	L3x3x4	.569	6.982	5	.488	6.982	y	2	32.733	46.656	1.688	2.278	1 H2-1
4	M41A	PIPE 2.0	.278	1.122	11	.177	1.122		2	17.855	32.13	1.872	1.872	1 H1-1b
5	M28	PIPE 2.0	.648	3.083	2	.164	5.25		5	14.916	32.13	1.872	1.872	2...H1-1b
6	M118	PIPE 2.0	.665	3.083	11	.160	5.25		7	14.916	32.13	1.872	1.872	2...H1-1b
7	M48	PIPE 2.0	.285	6.873	13	.158	12.3...		11	17.855	32.13	1.872	1.872	1 H1-1b
8	M47	PIPE 2.0	.300	6.873	10	.152	12.3...		6	17.855	32.13	1.872	1.872	1 H1-1b
9	M108	PIPE 2.0	.650	3.083	6	.140	5.25		3	14.916	32.13	1.872	1.872	2...H1-1b
10	M53	HSS4x4x3	.423	0	10	.135	0	y	3	102.875	106.812	12.662	12.662	3...H1-1b
11	M52	HSS4x4x3	.416	0	6	.131	0	y	7	102.875	106.812	12.662	12.662	3...H1-1b
12	M54	PIPE 2.0	.326	3.083	11	.125	3.083		12	14.916	32.13	1.872	1.872	2...H1-1b
13	M62B	PIPE 2.0	.351	3.083	3	.122	3.083		4	14.916	32.13	1.872	1.872	1...H1-1b
14	M70	PIPE 2.0	.349	3.083	7	.120	3.083		8	14.916	32.13	1.872	1.872	2...H1-1b
15	M60	HSS4x4x3	.388	0	29	.115	0	y	5	102.875	106.812	12.662	12.662	2...H1-1b
16	M57C	PIPE 2.0	.289	3.083	5	.112	3.083		4	14.916	32.13	1.872	1.872	1...H1-1b
17	M93	PIPE 2.0	.298	3.083	7	.108	3.083		12	14.916	32.13	1.872	1.872	1...H1-1b
18	M75A	PIPE 2.0	.302	3.083	3	.097	3.083		8	14.916	32.13	1.872	1.872	1...H1-1b
19	M51A	L2.5x2.5x3	.508	0	5	.093	1.25	y	5	27.293	29.192	.873	1.972	2... H2-1
20	M72 1	PIPE 2.0	.122	2.5	5	.088	2.5		11	29.81	32.13	1.872	1.872	2...H1-1b
21	M49A	L2.5x2.5x3	.482	0	10	.085	1.25	y	9	27.293	29.192	.873	1.972	1... H2-1
22	M50	L2.5x2.5x3	.495	0	2	.085	1.25	y	13	27.293	29.192	.873	1.972	1... H2-1
23	M61B	PIPE 2.0	.159	6.618	37	.085	10.9...		12	17.855	32.13	1.872	1.872	1 H1-1b
24	M62B 1	PIPE 2.0	.165	6.618	4	.084	10.9...		4	17.855	32.13	1.872	1.872	1 H1-1b
25	M57A 1	PIPE 2.0	.154	6.347	8	.081	2.026		8	17.855	32.13	1.872	1.872	1 H1-1b
26	M71 1	PIPE 2.0	.103	2.5	13	.080	2.5		7	29.81	32.13	1.872	1.872	2...H1-1b
27	M70 1	PIPE 2.0	.106	0	3	.078	2.5		3	29.81	32.13	1.872	1.872	2...H1-1b
28	M61	L3x3x4	.397	7.627	34	.038	7.627	z	34	13.292	46.656	1.688	3.517	2... H2-1
29	M63	L3x3x4	.390	0	26	.038	0	z	26	13.292	46.656	1.688	3.514	2... H2-1
30	M62	L3x3x4	.395	0	34	.038	0	z	34	13.292	46.656	1.688	3.51	2... H2-1
31	M58	LL3x3x4x0	.462	1.067	34	.034	1.105	y	32	79.399	93.312	6.48	4.911	1...H1-1b
32	M59	LL3x3x4x0	.456	1.067	30	.033	1.105	y	28	79.399	93.312	6.48	4.911	1...H1-1b
33	M57	LL3x3x4x0	.455	1.067	26	.033	1.105	y	36	79.399	93.312	6.48	4.911	1...H1-1b
34	M78 1	L2.5x2.5x3	.085	2.141	2	.011	0	y	8	15.939	29.192	.873	1.724	1... H2-1
35	M84 1	L2.5x2.5x3	.085	2.141	2	.010	0	z	8	15.939	29.192	.873	1.724	1... H2-1
36	M82 1	L2.5x2.5x3	.089	2.141	5	.010	4.282	y	12	15.939	29.192	.873	1.724	1... H2-1
37	M80 1	L2.5x2.5x3	.090	2.141	11	.010	4.282	z	4	15.939	29.192	.873	1.724	1... H2-1
38	M74 1	L2.5x2.5x3	.070	2.141	9	.009	4.282	y	4	15.939	29.192	.873	1.724	1... H2-1
39	M76 1	L2.5x2.5x3	.065	2.141	7	.009	0	z	12	15.939	29.192	.873	1.724	1... H2-1
40	M105	LL2.5x2.5x...	.123	3.01	5	.008	6.021	z	4	36.392	58.32	3.954	2.55	1...H1-1b

Envelope AISC 14th(360-10): LRFD Steel Code Checks (Continued)

Member	Shape	Code Check	Loc[ft]	LC	Shear ..	Loc[ft]	Dir	LC	phi*Pnc...	phi*Pnt...	phi*Mn ...	phi*Mn ...	Cb	Eqn
41	M106	LL2.5x2.5x...	.123	3.01	11	.008	0	z	6	36.392	58.32	3.954	2.55	1...H1-1b
42	M104	LL2.5x2.5x...	.085	3.01	27	.004	6.021	y	26	36.392	58.32	3.954	2.55	1...H1-1b

SPECIAL CONSTRUCTION NOTE:
 SPRINT WORK IS CONTINGENT ON THE FOLLOWING:
 * COMPLETION OF A GLOBAL STRUCTURAL STABILITY ANALYSIS.
 * COMPLETION OF AN ANTENNA/RRH MOUNT STRUCTURAL ASSESSMENT.
 * GC SHALL FURNISH, INSTALL AND COMPLETE ALL REQUIRED STRUCTURAL MODIFICATIONS AS INDICATED IN BEFORE-MENTIONED ANALYSIS AND ASSESSMENT.

SPECIAL CONSTRUCTION NOTE:
 GENERAL CONTRACTOR SHALL FURNISH AND INSTALL ALL ANTENNA MOUNT STRUCTURAL AUGMENTS (STRUCTURAL MODIFICATIONS) AT THE SPRINT RAD/VERTICAL EQUIPMENT SPACE PER RECOMMENDATIONS FROM SBA-PROVIDED ANTENNA MOUNT STRUCTURAL ANALYSIS AND ANY SUPPLEMENTAL CONSTRUCTION DRAWINGS (PROVIDED BY OTHERS)

Sprint



PROJECT: DO MACRO UPGRADE
EQUIPMENT DEPLOYMENT

SITE NUMBER: CT33XC575

SITE ADDRESS: 31 CHESTNUT HILL ROAD
COLCHESTER, CT 06415

SITE TYPE: MONOPOLE

PLANS PREPARED FOR:
Sprint
 1 INTERNATIONAL BLVD, SUITE 800
 MAHWAH, NJ 07495
 TEL: (800) 357-7641

PROJECT MANAGER:
SBA
 SBA COMMUNICATIONS CORP.
 134 FLANDERS ROAD, SUITE 125
 WESTBOROUGH, MA 01581
 TEL: (508) 251-0720

PLANS PREPARED BY:
INFINIGY
 FROM ZERO TO INFINIGY
 the solutions are endless
 1033 Watervliet Shaker Rd | Albany, NY 12205
 Phone: 518-690-0790 | Fax: 518-690-0793
 www.infinigy.com
 JOB NUMBER 526-104

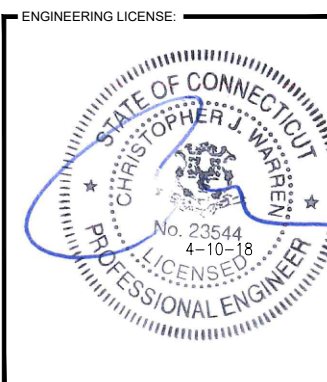

CHECKED BY:

APPROVED BY:

REVISIONS:	DESCRIPTION	DATE	BY	REV.

ISSUED FOR CONSTRUCTION 04/10/18 RWF 0

SITE NUMBER:
CT33XC575

SITE ADDRESS:
 31 CHESTNUT HILL ROAD
 COLCHESTER, CT 06415

SHEET DESCRIPTION:
TITLE SHEET & PROJECT DATA

SHEET NUMBER:
T-1

PROJECT INFORMATION

SITE INFORMATION:
 LATITUDE: 41° 34' 16.73" N
 (PER SBA RECORDS) 41.57131"
 LONGITUDE: -72° 18' 08.37" W
 (PER SBA RECORDS) -72.30236"
 STRUCTURE HEIGHT: 180'±
 STRUCTURE TYPE: MONOPOLE
APPLICANT:
 SPRINT
 1 INTERNATIONAL BLVD, SUITE 800
 MAHWAH, NJ 07495
TOWER OWNER:
 SBA TOWERS LLC.
 8051 CONGRESS AVENUE
 BOCA RATON, FL 33487
 SBA SITE ID: CT02220-S
 SBA SITE NAME: COLCHESTER 2 CT
 SBA CONTACT: STEPHEN ROTH
 (860) 539-4920
 sroth@sbasite.com

AREA MAP

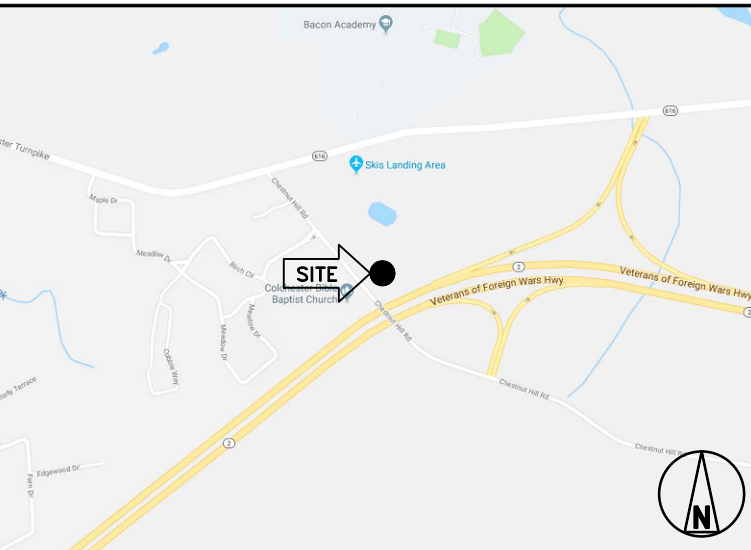

LOCATION MAP

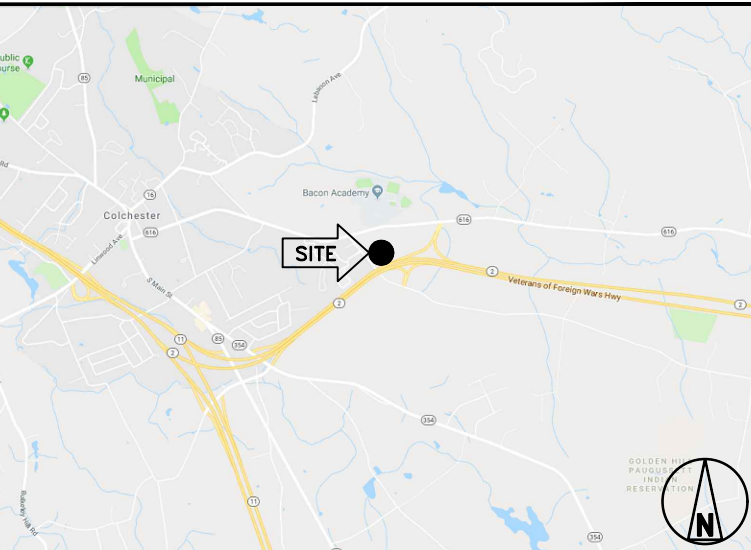

PROJECT DESCRIPTION

SPRINT PROPOSES TO MODIFY AN EXISTING UNMANNED TELECOMMUNICATIONS FACILITY.

- REMOVE (6) PANEL ANTENNAS
- INSTALL (6) PANEL ANTENNAS
- INSTALL (3) 2.5 GHz RRH'S ON PROPOSED PIPE MOUNT
- RELOCATE (3) 1900 MHz RRH'S ON PROPOSED PIPE MOUNT
- INSTALL (6) 800 MHz RRH'S ON PROPOSED PIPE MOUNT
- REMOVE (4) RUNS OF 1 5/8" COAX
- INSTALL (4) HYBRID CABLES
- INSTALL RAN EQUIPMENT INSIDE EXISTING MMBTS CABINET
- INSTALL STRUCTURAL AUGMENTS

THESE PLANS HAVE BEEN DEVELOPED FOR THE MODIFICATION OF AN EXISTING UNMANNED TELECOMMUNICATIONS FACILITY OWNED OR LEASED BY SPRINT IN ACCORDANCE WITH THE SCOPE OF WORK PROVIDED BY SPRINT. INFINIGY HAS INCORPORATED THIS SCOPE OF WORK IN THE PLANS. THESE PLANS ARE NOT FOR CONSTRUCTION UNLESS ACCOMPANIED BY A PASSING STRUCTURAL STABILITY ANALYSIS PREPARED BY A LICENSED STRUCTURAL ENGINEER. STRUCTURAL ANALYSIS MUST INCLUDE BOTH TOWER AND MOUNT.

APPLICABLE CODES

ALL WORK SHALL BE PERFORMED AND MATERIALS INSTALL IN ACCORDANCE WITH THE CURRENT EDITIONS OF THE FOLLOWING CODES AS ADOPTED BY THE LOCAL GOVERNING AUTHORITIES. NOTHING IN THESE PLANS IS TO BE CONSTRUED TO PERMIT WORK NOT CONFORMING TO THESE CODES.

- INTERNATIONAL BUILDING CODE (2012 IBC)
- TIA-222-G OR LATEST EDITION
- NFPA 780 - LIGHTNING PROTECTION CODE
- 2014 NATIONAL ELECTRIC CODE OR LATEST EDITION
- ANY OTHER NATIONAL OR LOCAL APPLICABLE CODES, MOST RECENT EDITIONS
- CT BUILDING CODE
- LOCAL BUILDING CODE
- CITY/COUNTY ORDINANCES

GENERAL NOTES

- THIS IS AN UNMANNED TELECOMMUNICATION FACILITY AND NOT FOR HUMAN HABITATION:
 - ADA COMPLIANCE NOT REQUIRED.
 - POTABLE WATER OR SANITARY SERVICE IS NOT REQUIRED.
 - NO OUTDOOR STORAGE OR ANY SOLID WASTE RECEPTACLES REQUIRED.
- CONTRACTOR SHALL VERIFY ALL PLANS, EXISTING DIMENSIONS, AND CONDITIONS ON JOB SITE. CONTRACTOR SHALL IMMEDIATELY NOTIFY THE ARCHITECT/ENGINEER IN WRITING OF ANY DISCREPANCIES BEFORE PROCEEDING WITH THE WORK. FAILURE TO NOTIFY THE ARCHITECT/ENGINEER PLACE THE RESPONSIBILITY ON THE CONTRACTOR TO CORRECT THE DISCREPANCIES AT THE CONTRACTOR'S EXPENSE.

DRAWING INDEX

SHEET NO.	SHEET TITLE	REV.
T-1	TITLE SHEET & PROJECT DATA	0
SP-1	OUTLINE SPECIFICATIONS	0
SP-2	OUTLINE SPECIFICATIONS	0
SP-3	OUTLINE SPECIFICATIONS	0
A-1	SITE PLAN	0
A-2	TOWER ELEVATION	0
A-3	ANTENNA LAYOUT & MOUNTING DETAILS	0
A-4	EQUIPMENT & MOUNTING DETAILS	0
A-5	DETAILS	0
E-1	ELECTRICAL & GROUNDING DETAILS	0
RF-1	RF DATA SHEET	0
RF-2	PLUMBING DIAGRAM	0

CALL CONNECTICUT ONE CALL
 (800) 922-4455
 CALL 3 WORKING DAYS
 BEFORE YOU DIG!



THESE OUTLINE SPECIFICATIONS IN CONJUNCTION WITH THE SPRINT STANDARD CONSTRUCTION SPECIFICATIONS, INCLUDING CONTRACT DOCUMENTS AND THE CONSTRUCTION DRAWINGS DESCRIBE THE WORK TO BE PERFORMED BY THE CONTRACTOR.

SECTION 01 100 – SCOPE OF WORK

PART 1 – GENERAL

- 1.1 THE WORK: THESE STANDARD CONSTRUCTION SPECIFICATIONS IN CONJUNCTION WITH THE SPRINT CONSTRUCTION STANDARDS FOR WIRELESS SITES, CONTRACT DOCUMENTS AND THE CONSTRUCTION DRAWINGS DESCRIBE THE WORK TO BE PERFORMED BY THE CONTRACTOR.
- 1.2 RELATED DOCUMENTS:
 - A. THE REQUIREMENTS OF THIS SECTION APPLY TO ALL SECTIONS IN THIS SPECIFICATION.
 - B. SPRINT "STANDARD CONSTRUCTION DETAILS FOR WIRELESS SITES" ARE INCLUDED IN AND MADE A PART OF THESE SPECIFICATIONS HERewith.
- 1.3 PRECEDENCE: SHOULD CONFLICTS OCCUR BETWEEN THE STANDARD CONSTRUCTION SPECIFICATIONS FOR WIRELESS SITES INCLUDING THE STANDARD CONSTRUCTION DETAILS FOR WIRELESS SITES AND THE CONSTRUCTION DRAWINGS, INFORMATION ON THE CONSTRUCTION DRAWINGS SHALL TAKE PRECEDENCE. NOTIFY SPRINT CONSTRUCTION MANAGER IF THIS OCCURS.
- 1.4 NATIONALLY RECOGNIZED CODES AND STANDARDS:
 - A. THE WORK SHALL COMPLY WITH APPLICABLE NATIONAL AND LOCAL CODES AND STANDARDS, LATEST EDITION, AND PORTIONS THEREOF, INCLUDED BUT NOT LIMITED TO THE FOLLOWING:
 - 1. GR-63-CORE NEBS REQUIREMENTS: PHYSICAL PROTECTION
 - 5. GR-78-CORE GENERIC REQUIREMENTS FOR THE PHYSICAL DESIGN AND MANUFACTURE OF TELECOMMUNICATIONS EQUIPMENT.
 - 3. GR-1089 CORE, ELECTROMAGNETIC COMPATIBILITY AND ELECTRICAL SAFETY –GENERIC CRITERIA FOR NETWORK TELECOMMUNICATIONS EQUIPMENT.
 - 4. NATIONAL FIRE PROTECTION ASSOCIATION CODES AND STANDARDS (NFPA) INCLUDING NFPA 70 (NATIONAL ELECTRICAL CODE – "NEC") AND NFPA 101 (LIFE SAFETY CODE).
 - 5. AMERICAN SOCIETY FOR TESTING OF MATERIALS (ASTM)
 - 6. INSTITUTE OF ELECTRONIC AND ELECTRICAL ENGINEERS (IEEE)
 - 7. AMERICAN CONCRETE INSTITUTE (ACI)
 - 8. AMERICAN WIRE PRODUCERS ASSOCIATION (AWPA)
 - 9. CONCRETE REINFORCING STEEL INSTITUTE (CRSI)
 - 10. AMERICAN ASSOCIATION OF STATE HIGHWAY AND TRANSPORTATION OFFICIALS (AASHTO)
 - 11. PORTLAND CEMENT ASSOCIATION (PCA)
 - 12. NATIONAL CONCRETE MASONRY ASSOCIATION (NCMA)
 - 13. BRICK INDUSTRY ASSOCIATION (BIA)
 - 14. AMERICAN WELDING SOCIETY (AWS)
 - 15. NATIONAL ROOFING CONTRACTORS ASSOCIATION (NRCA)
 - 16. SHEET METAL AND AIR CONDITIONING CONTRACTORS' NATIONAL ASSOCIATION (SMACNA)
 - 17. DOOR AND HARDWARE INSTITUTE (DHI)
 - 18. OCCUPATIONAL SAFETY AND HEALTH ACT (OSHA)
 - 19. APPLICABLE BUILDING CODES INCLUDING UNIFORM BUILDING CODE, SOUTHERN BUILDING CODE, BOCA, AND THE INTERNATIONAL BUILDING CODE.
- 1.5 DEFINITIONS:
 - A. WORK: THE SUM OF TASKS AND RESPONSIBILITIES IDENTIFIED IN THE CONTRACT DOCUMENTS.
 - B. COMPANY: SPRINT CORPORATION
 - C. ENGINEER: SYNONYMOUS WITH ARCHITECT & ENGINEER AND "A&E". THE DESIGN PROFESSIONAL HAVING PROFESSIONAL RESPONSIBILITY FOR DESIGN OF THE PROJECT.
 - D. CONTRACTOR: CONSTRUCTION CONTRACTOR; CONSTRUCTION VENDOR; INDIVIDUAL OR ENTITY WHO AFTER EXECUTION OF A CONTRACT IS BOUND TO ACCOMPLISH THE WORK.
 - E. THIRD PARTY VENDOR OR AGENCY: A VENDOR OR AGENCY ENGAGED SEPARATELY BY THE COMPANY, A&E, OR CONTRACTOR TO PROVIDE MATERIALS OR TO ACCOMPLISH SPECIFIC TASKS RELATED TO BUT NOT INCLUDED IN THE WORK.
 - F. OFCI: OWNER FURNISHED, CONTRACTOR INSTALLED EQUIPMENT.
 - G. CONSTRUCTION MANAGER – ALL PROJECTS RELATED COMMUNICATION TO FLOW THROUGH SPRINT REPRESENTATIVE IN CHARGE OF PROJECT...

- 1.6 SITE FAMILIARITY: CONTRACTOR SHALL BE RESPONSIBLE FOR FAMILIARIZING HIMSELF WITH ALL CONTRACT DOCUMENTS, FIELD CONDITIONS AND DIMENSIONS PRIOR TO PROCEEDING WITH CONSTRUCTION. ANY DISCREPANCIES SHALL BE BROUGHT TO THE ATTENTION OF THE SPRINT CONSTRUCTION MANAGER PRIOR TO THE COMMENCEMENT OF WORK. NO COMPENSATION WILL BE AWARDED BASED ON CLAIM OF LACK OF KNOWLEDGE OR FIELD CONDITIONS.
- 1.7 POINT OF CONTACT: COMMUNICATION BETWEEN SPRINT AND THE CONTRACTOR SHALL FLOW THROUGH THE SINGLE SPRINT CONSTRUCTION MANAGER APPOINTED TO MANAGE THE PROJECT FOR SPRINT.
- 1.8 ON-SITE SUPERVISION: THE CONTRACTOR SHALL SUPERVISE AND DIRECT THE WORK AND SHALL BE RESPONSIBLE FOR CONSTRUCTION MEANS, METHODS, TECHNIQUES, SEQUENCES, AND PROCEDURES IN ACCORDANCE WITH THE CONTRACT DOCUMENTS. THE CONTRACTOR SHALL EMPLOY A COMPETENT SUPERINTENDENT WHO SHALL BE IN ATTENDANCE AT THE SITE AT ALL TIMES DURING PERFORMANCE OF THE WORK.
- 1.9 DRAWINGS, SPECIFICATIONS AND DETAILS REQUIRED AT JOBSITE: THE CONSTRUCTION CONTRACTOR SHALL MAINTAIN A FULL SET OF THE CONSTRUCTION DRAWINGS, STANDARD CONSTRUCTION DETAILS FOR WIRELESS SITES AND THE STANDARD CONSTRUCTION SPECIFICATIONS FOR WIRELESS SITES AT THE JOBSITE FROM MOBILIZATION THROUGH CONSTRUCTION COMPLETION.
 - A. THE JOBSITE DRAWINGS, SPECIFICATIONS AND DETAILS SHALL BE CLEARLY MARKED DAILY IN RED PENCIL WITH ANY CHANGES IN CONSTRUCTION OVER WHAT IS DEPICTED IN THE DOCUMENTS. AT CONSTRUCTION COMPLETION, THIS JOBSITE MARKUP SET SHALL BE DELIVERED TO THE COMPANY OR COMPANY'S DESIGNATED REPRESENTATIVE TO BE FORWARDED TO THE COMPANY'S A&E VENDOR FOR PRODUCTION OF "AS-BUILT" DRAWINGS.
 - B. DETAILS ARE INTENDED TO SHOW DESIGN INTENT. MODIFICATIONS MAY BE REQUIRED TO SUIT JOB DIMENSIONS OR CONDITIONS, AND SUCH MODIFICATIONS SHALL BE INCLUDED AS PART OF THE WORK. CONTRACTOR SHALL NOTIFY SPRINT CONSTRUCTION MANAGER OF ANY VARIATIONS PRIOR TO PROCEEDING WITH THE WORK.
 - C. DIMENSIONS SHOWN ARE TO FINISH SURFACES UNLESS NOTED OTHERWISE. SPACING BETWEEN EQUIPMENT IS THE REQUIRED CLEARANCE. SHOULD THERE BE ANY QUESTIONS REGARDING THE CONTRACT DOCUMENTS, EXISTING CONDITIONS AND/OR DESIGN INTENT, THE CONTRACTOR SHALL BE RESPONSIBLE FOR OBTAINING A CLARIFICATION FROM THE SPRINT CONSTRUCTION MANAGER PRIOR TO PROCEEDING WITH THE WORK.
- 1.10 USE OF JOB SITE: THE CONTRACTOR SHALL CONFINE ALL CONSTRUCTION AND RELATED OPERATIONS INCLUDING STAGING AND STORAGE OF MATERIALS AND EQUIPMENT, PARKING, TEMPORARY FACILITIES, AND WASTE STORAGE TO THE LEASE PARCEL UNLESS OTHERWISE PERMITTED BY THE CONTRACT DOCUMENTS.
- 1.11 UTILITIES SERVICES: WHERE NECESSARY TO CUT EXISTING PIPES, ELECTRICAL WIRES, CONDUITS, CABLES, ETC., OF UTILITY SERVICES, OR OF FIRE PROTECTION OR COMMUNICATIONS SYSTEMS, THEY SHALL BE CUT AND CAPPED AT SUITABLE PLACES OR WHERE SHOWN. ALL SUCH ACTIONS SHALL BE COORDINATED WITH THE UTILITY COMPANY INVOLVED:
- 1.12 PERMITS / FEES: WHEN REQUIRED THAT A PERMIT OR CONNECTION FEE BE PAID TO A PUBLIC UTILITY PROVIDER FOR NEW SERVICE TO THE CONSTRUCTION PROJECT, PAYMENT OF SUCH FEE SHALL BE THE RESPONSIBILITY OF THE CONTRACTOR.
- 1.13 CONTRACTOR SHALL TAKE ALL MEASURES AND PROVIDE ALL MATERIAL NECESSARY FOR PROTECTING EXISTING EQUIPMENT AND PROPERTY.
- 1.14 METHODS OF PROCEDURE (MOPS) FOR CONSTRUCTION: CONTRACTOR SHALL PERFORM WORK AS DESCRIBED IN THE FOLLOWING INSTALLATION AND COMMISSIONING MOPS.

NOTE: IN SHORT-FORM SPECIFICATIONS ON THE DRAWINGS, A/E TO INSERT LIST OF APPLICABLE MOPS INCLUDING EN-2012-001, EN-2013-002, EL-0568, AND TS-0193
- 1.15 USE OF ELECTRONIC PROJECT MANAGEMENT SYSTEMS:

PART 2 – PRODUCTS (NOT USED)

PART 3 – EXECUTION

- 3.1 TEMPORARY UTILITIES AND FACILITIES: THE CONTRACTOR SHALL BE RESPONSIBLE FOR ALL TEMPORARY UTILITIES AND FACILITIES NECESSARY EXCEPT AS OTHERWISE INDICATED IN THE CONSTRUCTION DOCUMENTS. TEMPORARY UTILITIES AND FACILITIES INCLUDE POTABLE WATER, HEAT, HVAC, ELECTRICITY, SANITARY FACILITIES, WASTE DISPOSAL FACILITIES, AND TELEPHONE/COMMUNICATION SERVICES. PROVIDE TEMPORARY UTILITIES AND FACILITIES IN ACCORDANCE WITH OSHA AND THE AUTHORITY HAVING JURISDICTION. CONTRACTOR MAY UTILIZE THE COMPANY ELECTRICAL SERVICE IN THE COMPLETION OF THE WORK WHEN IT BECOMES AVAILABLE. USE OF THE LESSORS OR SITE OWNER'S UTILITIES OR FACILITIES IS EXPRESSLY FORBIDDEN EXCEPT AS OTHERWISE ALLOWED IN THE CONTRACT DOCUMENTS.
- 3.2 ACCESS TO WORK: THE CONTRACTOR SHALL PROVIDE ACCESS TO THE JOB SITE FOR AUTHORIZED COMPANY PERSONNEL AND AUTHORIZED REPRESENTATIVES OF THE ARCHITECT/ENGINEER DURING ALL PHASES OF THE WORK.
- 3.3 TESTING: REQUIREMENTS FOR TESTING BY THIS CONTRACTOR SHALL BE AS INDICATED HERewith, ON THE CONSTRUCTION DRAWINGS, AND IN THE INDIVIDUAL SECTIONS OF THESE SPECIFICATIONS. SHOULD COMPANY CHOOSE TO ENGAGE ANY THIRD-PARTY TO CONDUCT ADDITIONAL TESTING, THE CONTRACTOR SHALL COOPERATE WITH AND PROVIDE A WORK AREA FOR COMPANY'S TEST AGENCY.
- 3.4 DIMENSIONS: VERIFY DIMENSIONS INDICATED ON DRAWINGS WITH FIELD DIMENSIONS BEFORE FABRICATION OR ORDERING OF MATERIALS. DO NOT SCALE DRAWINGS.

3.5 EXISTING CONDITIONS: NOTIFY THE SPRINT CONSTRUCTION MANAGER OF EXISTING CONDITIONS DIFFERING FROM THOSE INDICATED ON THE DRAWINGS. DO NOT REMOVE OR ALTER STRUCTURAL COMPONENTS WITHOUT PRIOR WRITTEN APPROVAL FROM THE ARCHITECT AND ENGINEER.

SECTION 01 200 – COMPANY FURNISHED MATERIAL AND EQUIPMENT

PART 1 – GENERAL

- 1.1 THE WORK: THESE STANDARD CONSTRUCTION SPECIFICATIONS IN CONJUNCTION WITH THE OTHER CONTRACT DOCUMENTS AND THE CONSTRUCTION DRAWINGS DESCRIBE THE WORK TO BE PERFORMED BY THE CONTRACTOR.
- 1.2 RELATED DOCUMENTS:
 - A. THE REQUIREMENTS OF THIS SECTION APPLY TO ALL SECTIONS IN THIS SPECIFICATION.
 - B. SPRINT "STANDARD CONSTRUCTION DETAILS FOR WIRELESS SITES" ARE INCLUDED IN AND MADE A PART OF THESE SPECIFICATIONS HERewith.

PART 2 – PRODUCTS (NOT USED)

PART 3 – EXECUTION

- 3.1 RECEIPT OF MATERIAL AND EQUIPMENT:
 - A. A COMPANY FURNISHED MATERIAL AND EQUIPMENT IS IDENTIFIED ON THE RF DATA SHEET IN THE CONSTRUCTION DOCUMENTS.
 - B. THE CONTRACTOR IS RESPONSIBLE FOR SPRINT PROVIDED MATERIAL AND EQUIPMENT AND UPON RECEIPT SHALL:
 - 1. ACCEPT DELIVERIES AS SHIPPED AND TAKE RECEIPT.
 - 2. VERIFY COMPLETENESS AND CONDITION OF ALL DELIVERIES.
 - 3. TAKE RESPONSIBILITY FOR EQUIPMENT AND PROVIDE INSURANCE PROTECTION AS REQUIRED IN AGREEMENT.
 - 4. RECORD ANY DEFECTS OR DAMAGES AND WITHIN TWENTY-FOUR HOURS AFTER RECEIPT, REPORT TO SPRINT OR ITS DESIGNATED PROJECT REPRESENTATIVE OF SUCH.
 - 5. PROVIDE SECURE AND NECESSARY WEATHER PROTECTED WAREHOUSING.
 - 6. COORDINATE SAFE AND SECURE TRANSPORTATION OF MATERIAL AND EQUIPMENT, DELIVERING AND OFF-LOADING FROM CONTRACTOR'S WAREHOUSE TO SITE.
- 3.2 DELIVERABLES:
 - A. COMPLETE SHIPPING AND RECEIPT DOCUMENTATION IN ACCORDANCE WITH COMPANY PRACTICE.
 - B. IF APPLICABLE, COMPLETE LOST/STOLEN/DAMAGED DOCUMENTATION REPORT AS NECESSARY IN ACCORDANCE WITH COMPANY PRACTICE, AND AS DIRECTED BY COMPANY.
 - C. UPLOAD DOCUMENTATION INTO SPRINT SITE MANAGEMENT SYSTEM (SMS) AND/OR PROVIDE HARD COPY DOCUMENTATION AS REQUESTED.

SECTION 01 300 – CELL SITE CONSTRUCTION CO.

PART 1 – GENERAL

- 1.1 THE WORK: THESE STANDARD CONSTRUCTION SPECIFICATIONS IN CONJUNCTION WITH THE OTHER CONTRACT DOCUMENTS AND THE CONSTRUCTION DRAWINGS DESCRIBE THE WORK TO BE PERFORMED BY THE CONTRACTOR.
- 1.2 RELATED DOCUMENTS:
 - A. THE REQUIREMENTS OF THIS SECTION APPLY TO ALL SECTIONS IN THIS SPECIFICATION.
 - B. SPRINT "STANDARD CONSTRUCTION DETAILS FOR WIRELESS SITES" ARE INCLUDED IN AND MADE A PART OF THESE SPECIFICATIONS HERewith.
- 1.3 NOTICE TO PROCEED
 - A. NO WORK SHALL COMMENCE PRIOR TO COMPANY'S WRITTEN NOTICE TO PROCEED AND THE ISSUANCE OF THE WORK ORDER.
 - B. UPON RECEIVING NOTICE TO PROCEED, CONTRACTOR SHALL FULLY PERFORM ALL WORK NECESSARY TO PROVIDE SPRINT WITH AN OPERATIONAL WIRELESS FACILITY.

PART 2 – PRODUCTS (NOT USED)

PART 3 – EXECUTION

- 3.1 FUNCTIONAL REQUIREMENTS:
 - A. THE ACTIVITIES DESCRIBED IN THIS PARAGRAPH REPRESENT MINIMUM ACTIONS AND PROCESSES REQUIRED TO SUCCESSFULLY COMPLETE THE WORK. THE ACTIVITIES DESCRIBED ARE NOT EXHAUSTIVE, AND CONTRACTOR SHALL TAKE ANY AND ALL ACTIONS AS NECESSARY TO SUCCESSFULLY COMPLETE THE CONSTRUCTION OF A FULLY FUNCTIONING WIRELESS FACILITY AT THE SITE IN ACCORDANCE WITH COMPANY PROCESSES.
 - B. SUBMIT SPECIFIC DOCUMENTATION AS INDICATED HEREIN, AND OBTAIN REQUIRED APPROVALS WHILE THE WORK IS BEING PERFORMED.
 - C. MANAGE AND CONDUCT ALL FIELD CONSTRUCTION SERVICE RELATED ACTIVITIES
 - D. PROVIDE CONSTRUCTION ACTIVITIES TO THE EXTENT REQUIRED BY THE CONTRACT DOCUMENTS, INCLUDING BUT NOT LIMITED TO THE FOLLOWING:

PLANS PREPARED FOR:



1 INTERNATIONAL BLVD, SUITE 800
MAHWAH, NJ 07495
TEL: (800) 357-7641

PROJECT MANAGER:



SBA COMMUNICATIONS CORP.
134 FLANDERS ROAD, SUITE 125
WESTBOROUGH, MA 01581
TEL: (508) 251-0720

PLANS PREPARED BY:



FROM ZERO TO INFINIGY
the solutions are endless

1033 Watervliet Shaker Rd | Albany, NY 12205
Phone: 518-690-0790 | Fax: 518-690-0793
www.infinigy.com
JOB NUMBER 526-104

ENGINEERING LICENSE:

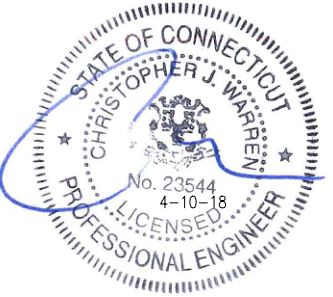

CHECKED BY:

APPROVED BY:

REVISIONS:	DESCRIPTION	DATE	BY	REV.
ISSUED FOR CONSTRUCTION		04/10/18	RWF	0

SITE NUMBER:

CT33XC575

SITE ADDRESS:

31 CHESTNUT HILL ROAD
COLCHESTER, CT 06415

SHEET DESCRIPTION:

OUTLINE SPECIFICATIONS

SHEET NUMBER:

SP-1

CONTINUE FROM SP-1

1. PERFORM ANY REQUIRED SITE ENVIRONMENTAL MITIGATION.
 2. PREPARE GROUND SITES; PROVIDE DE-GRUBBING; AND ROUGH AND FINAL GRADING, AND COMPOUND SURFACE TREATMENTS.
 3. MANAGE AND CONDUCT ALL ACTIVITIES FOR INSTALLATION OF UTILITIES INCLUDING ELECTRICAL AND TELCO BACKHAUL.
 4. INSTALL UNDERGROUND FACILITIES INCLUDING UNDERGROUND POWER AND COMMUNICATIONS CONDUITS, AND UNDERGROUND GROUNDING SYSTEM.
 5. INSTALL ABOVE GROUND GROUNDING SYSTEMS.
 6. PROVIDE NEW HVAC INSTALLATIONS AND MODIFICATIONS.
 7. INSTALL "H-FRAMES", CABINETS AND SHELTERS AS INDICATED.
 8. INSTALL ROADS, ACCESS WAYS, CURBS AND DRAINS AS INDICATED.
 9. ACCOMPLISH REQUIRED MODIFICATION OF EXISTING FACILITIES.
 10. PROVIDE ANTENNA SUPPORT STRUCTURE FOUNDATIONS.
 11. PROVIDE SLABS AND EQUIPMENT PLATFORMS.
 12. INSTALL COMPOUND FENCING, SIGHT SHIELDING, LANDSCAPING AND ACCESS BARRIERS.
 13. PERFORM INSPECTION AND MATERIAL TESTING AS REQUIRED HEREINAFTER.
 14. CONDUCT SITE RESISTANCE TO EARTH TESTING AS REQUIRED HEREINAFTER
 15. INSTALL FIXED GENERATOR SETS AND OTHER STANDBY POWER SOLUTIONS.
 16. INSTALL TOWERS, ANTENNA SUPPORT STRUCTURES AND PLATFORMS ON EXISTING TOWERS AS REQUIRED.
 17. INSTALL CELL SITE RADIOS, MICROWAVE, GPS, COAXIAL MAINLINE, ANTENNAS, CROSS BAND COUPLERS, TOWER TOP AMPLIFIERS, LOW NOISE AMPLIFIERS AND RELATED EQUIPMENT.
 18. PERFORM, DOCUMENT, AND CLOSE OUT ANY CONSTRUCTION CONTROL DOCUMENTS THAT MAY BE REQUIRED BY GOVERNMENT AGENCIES AND LANDLORDS.
 19. PERFORM ANTENNA AND COAX SWEEP TESTING AND MAKE ANY AND ALL NECESSARY CORRECTIONS.
 20. REMAIN ON SITE MOBILIZED THROUGHOUT HAND-OFF AND INTEGRATION TO ASSIST AS NEEDED UNTIL SITE IS DEEMED SUBSTANTIALLY COMPLETE AND PLACED "ON AIR."
- 3.2 GENERAL REQUIREMENTS FOR CIVIL CONSTRUCTION:
- A. CONTRACTOR SHALL KEEP THE SITE FREE FROM ACCUMULATING WASTE MATERIAL, DEBRIS, AND TRASH. AT THE COMPLETION OF THE WORK, CONTRACTOR SHALL REMOVE FROM THE SITE ALL REMAINING RUBBISH, IMPLEMENTS, TEMPORARY FACILITIES, AND SURPLUS MATERIALS.
 - B. EQUIPMENT ROOMS SHALL AT ALL TIMES BE MAINTAINED "BROOM CLEAN" AND CLEAR OF DEBRIS.
 - C. CONTRACTOR SHALL TAKE ALL REASONABLE PRECAUTIONS TO DISCOVER AND LOCATE ANY HAZARDOUS CONDITION.
 1. IN THE EVENT CONTRACTOR ENCOUNTERS ANY HAZARDOUS CONDITION WHICH HAS NOT BEEN ABATED OR OTHERWISE MITIGATED, CONTRACTOR AND ALL OTHER PERSONS SHALL IMMEDIATELY STOP WORK IN THE AFFECTED AREA AND NOTIFY COMPANY IN WRITING. THE WORK IN THE AFFECTED AREA SHALL NOT BE RESUMED EXCEPT BY WRITTEN NOTIFICATION BY COMPANY.
 2. CONTRACTOR AGREES TO USE CARE WHILE ON THE SITE AND SHALL NOT TAKE ANY ACTION THAT WILL OR MAY RESULT IN OR CAUSE THE HAZARDOUS CONDITION TO BE FURTHER RELEASED IN THE ENVIRONMENT, OR TO FURTHER EXPOSE INDIVIDUALS TO THE HAZARD.
 - D. CONTRACTOR'S ACTIVITIES SHALL BE RESTRICTED TO THE PROJECT LIMITS. SHOULD AREAS OUTSIDE THE PROJECT LIMITS BE AFFECTED BY CONTRACTOR'S ACTIVITIES, CONTRACTOR SHALL IMMEDIATELY RETURN THEM TO ORIGINAL CONDITION
 - E. CONDUCT TESTING AS REQUIRED HEREIN.
- 3.3 DELIVERABLES:
- A. CONTRACTOR SHALL REVIEW, APPROVE, AND SUBMIT TO SPRINT SHOP DRAWINGS, PRODUCT DATA, SAMPLES, AND SIMILAR SUBMITTALS AS REQUIRED HEREINAFTER
 - B. PROVIDE DOCUMENTATION INCLUDING, BUT NOT LIMITED TO, THE FOLLOWING. DOCUMENTATION SHALL BE FORWARDED IN ORIGINAL FORMAT AND/OR UPLOADED INTO SMS.
 1. ALL CORRESPONDENCE AND PRELIMINARY CONSTRUCTION REPORTS.
 2. PROJECT PROGRESS REPORTS.
 3. CIVIL CONSTRUCTION START DATE (POPULATE FIELD IN SMS AND/OR FORWARD NOTIFICATION).
 4. ELECTRICAL SERVICE COMPLETION DATE (POPULATE FIELD IN SMS AND/OR FORWARD NOTIFICATION).

5. LINES AND ANTENNA INSTALL DATE (POPULATE FIELD IN SMS AND/OR FORWARD NOTIFICATION).
6. POWER INSTALL DATE (POPULATE FIELD IN SMS AND/OR FORWARD NOTIFICATION).
7. TELCO READY DATE (POPULATE FIELD IN SMS AND/OR FORWARD NOTIFICATION).
8. PPC (OR SHELTER) INSTALL DATE (POPULATE FIELD IN SMS AND/OR FORWARD NOTIFICATION).
9. TOWER CONSTRUCTION START DATE (POPULATE FIELD IN SMS AND/OR FORWARD NOTIFICATION).
10. TOWER CONSTRUCTION COMPLETE DATE (POPULATE FIELD IN SMS AND/OR FORWARD NOTIFICATION).
11. BTS AND RADIO EQUIPMENT DELIVERED AT SITE DATE (POPULATE FIELD IN SMS AND/OR FORWARD NOTIFICATION).
12. NETWORK OPERATIONS HANDOFF CHECKLIST (HOC WALK) COMPLETE (UPLOAD FORM IN SMS)
13. CIVIL CONSTRUCTION COMPLETE DATE (POPULATE FIELD IN SMS AND/OR FORWARD NOTIFICATION).
14. SITE CONSTRUCTION PROGRESS PHOTOS UNLOADED INTO SMS.

SECTION 01 400 - SUBMITTALS & TESTS

PART 1 - GENERAL

- 1.1 THE WORK: THESE STANDARD CONSTRUCTION SPECIFICATIONS IN CONJUNCTION WITH THE OTHER CONTRACT DOCUMENTS AND THE CONSTRUCTION DRAWINGS DESCRIBE THE WORK TO BE PERFORMED BY THE CONTRACTOR.
- 1.2 RELATED DOCUMENTS:
 - A. THE REQUIREMENTS OF THIS SECTION APPLY TO ALL SECTIONS IN THIS SPECIFICATION.
 - B. SPRINT "STANDARD CONSTRUCTION DETAILS FOR WIRELESS SITES" ARE INCLUDED IN AND MADE A PART OF THESE SPECIFICATIONS HERewith.
- 1.3 SUBMITTALS:
 - A. THE WORK IN ALL ASPECTS SHALL COMPLY WITH THE CONSTRUCTION DRAWINGS AND THESE SPECIFICATIONS.
 - B. SUBMIT THE FOLLOWING TO COMPANY REPRESENTATIVE FOR APPROVAL.
 1. CONCRETE MIX-DESIGNS FOR TOWER FOUNDATIONS, ANCHORS PIERS, AND CONCRETE PAVING.
 2. CONCRETE BREAK TESTS AS SPECIFIED HEREIN.
 3. SPECIAL FINISHES FOR INTERIOR SPACES, IF ANY.
 4. ALL EQUIPMENT AND MATERIALS SO IDENTIFIED ON THE CONSTRUCTION DRAWINGS.
 5. CHEMICAL GROUNDING DESIGN
 - D. ALTERNATES: AT THE COMPANY'S REQUEST, ANY ALTERNATIVES TO THE MATERIALS OR METHODS SPECIFIED SHALL BE SUBMITTED TO SPRINT'S CONSTRUCTION MANAGER FOR APPROVAL PRIOR TO BEING SHIPPED TO SITE. SPRINT WILL REVIEW AND APPROVE ONLY THOSE REQUESTS MADE IN WRITING. NO VERBAL APPROVALS WILL BE CONSIDERED. SUBMITTAL FOR APPROVAL SHALL INCLUDE A STATEMENT OF COST REDUCTION PROPOSED FOR USE OF ALTERNATE PRODUCT.
- 1.4 TESTS AND INSPECTIONS:
 - A. THE CONTRACTOR SHALL BE RESPONSIBLE FOR ALL CONSTRUCTION TESTS, INSPECTIONS AND PROJECT DOCUMENTATION.
 - B. CONTRACTOR SHALL ACCOMPLISH TESTING INCLUDING BUT NOT LIMITED TO THE FOLLOWING:
 1. COAX SWEEPS AND FIBER TESTS PER TS-0200 REV 4 ANTENNA LINE ACCEPTANCE STANDARDS.
 2. AGL, AZIMUTH AND DOWNTILT USING ELECTRONIC COMMERCIAL MADE-FOR-THE-PURPOSE ANTENNA ALIGNMENT TOOL.
 3. CONTRACTOR SHALL BE RESPONSIBLE FOR ANY AND ALL CORRECTIONS TO ANY WORK IDENTIFIED AS UNACCEPTABLE IN SITE INSPECTION ACTIVITIES AND/OR AS A RESULT OF TESTING.
 - C. REQUIRED CLOSEOUT DOCUMENTATION INCLUDES, BUT IS NOT LIMITED TO THE FOLLOWING:
 1. AZIMUTH, DOWNTILT, AGL - UPLOAD REPORT FROM ANTENNA ALIGNMENT TOOL TO SITERRA TASK 465. INSTALLED AZIMUTH, DOWNTILT, AND AGL MUST CONFORM TO THE RF DATA SHEETS. SWEEP AND FIBER TESTS
 2. SCANABLE BARCODE PHOTOGRAPHS OF TOWER TOP AND INACCESSIBLE SERIALIZED EQUIPMENT
 3. ALL AVAILABLE JURISDICTIONAL INFORMATION
 4. PDF SCAN OF REDLINES PRODUCED IN FIELD

5. ELECTRONIC AS-BUILT DRAWINGS IN AUTOCAD AND PDF FORMATS. ANY FIELD CHANGE MUST BE REFLECTED BY MODIFYING THE PLANS, ELEVATIONS, AND DETAILS IN THE DRAWING SETS. GENERAL NOTES INDICATING MODIFICATIONS WILL NOT BE ACCEPTED. CHANGES SHALL BE HIGHLIGHTED AS "CLOUDS" IDENTIFIED AS THE "AS-BUILT" CONDITION.
 6. LIEN WAIVERS
 7. FINAL PAYMENT APPLICATION
 8. REQUIRED FINAL CONSTRUCTION PHOTOS
 9. CONSTRUCTION AND COMMISSIONING CHECKLIST COMPLETE WITH NO DEFICIENT ITEMS
 10. ALL POST NTP TASKS INCLUDING DOCUMENT UPLOADS COMPLETED IN SITERRA (SPRINTS DOCUMENT REPOSITORY OF RECORD).
- 1.5 COMMISSIONING: PERFORM ALL COMMISSIONING AS REQUIRED BY APPLICABLE MOPs
- 1.6 INTEGRATION: PERFORM ALL INTEGRATION ACTIVITIES AS REQUIRED BY APPLICABLE MOPs

PART 2 - PRODUCTS (NOT USED)

PART 3 - EXECUTION

- 3.1 REQUIREMENTS FOR TESTING:
- A. THIRD PARTY TESTING AGENCY:
 1. WHEN THE USE OF A THIRD PARTY INDEPENDENT TESTING AGENCY IS REQUIRED, THE AGENCY THAT IS SELECTED MUST PERFORM SUCH WORK ON A REGULAR BASIS IN THE STATE WHERE THE PROJECT IS LOCATED AND HAVE A THOROUGH UNDERSTANDING OF LOCAL AVAILABLE MATERIALS, INCLUDING THE SOIL, ROCK, AND GROUNDWATER CONDITIONS.
 2. THE THIRD PARTY TESTING AGENCY IS TO BE FAMILIAR WITH THE APPLICABLE REQUIREMENTS FOR THE TESTS TO BE DONE, EQUIPMENT TO BE USED, AND ASSOCIATED HEALTH AND SAFETY ISSUES.
 3. EXPERIENCE IN SOILS, CONCRETE, MASONRY, AGGREGATE, AND ASPHALT TESTING USING ASTM, AASJTO, AND OTHER METHODS IS NEEDED.
 4. EXPERIENCE IN SOILS, CONCRETE, MASONRY, AGGREGATE, AND ASPHALT TESTING USING ASTM, AASJTO, AND OTHER METHODS IS NEEDED.
- 3.2 REQUIRED TESTS:
- A. CONTRACTOR SHALL ACCOMPLISH TESTING INCLUDING BUT NOT LIMITED TO THE FOLLOWING:
 1. CONCRETE CYLINDER BREAK TESTS FOR THE TOWER AND ANCHOR FOUNDATIONS AS SPECIFIED IN SECTION: PORTLAND CEMENT CONCRETE PAVING.
 2. ASPHALT ROADWAY COMPACTED THICKNESS, SURFACE SMOOTHNESS, AND COMPACTED DENSITY TESTING AS SPECIFIED IN SECTION: HOT MIX ASPHALT PAVING.
 3. FIELD QUALITY CONTROL TESTING AS SPECIFIED IN SECTION: PORTLAND CEMENT CONCRETE PAVING.
 4. TESTING REQUIRED UNDER SECTION: AGGREGATE BASE FOR ACCESS ROADS, PADS AND ANCHOR LOCATIONS
 5. STRUCTURAL BACKFILL COMPACTION TESTS FOR THE TOWER FOUNDATION.
 6. SITE RESISTANCE TO EARTH TESTING PER EXHIBIT: CELL SITE GROUNDING SYSTEM DESIGN.
 7. ANTENNA AND COAX SWEEP TESTS PER EXHIBIT: ANTENNA TRANSMISSION LINE ACCEPTANCE STANDARDS.
 8. GROUNDING AT ANTENNA MASTS FOR GPS AND ANTENNAS
 9. ALL OTHER TESTS REQUIRED BY COMPANY OR JURISDICTION.

3.3 REQUIRED INSPECTIONS

- A. SCHEDULE INSPECTIONS WITH COMPANY REPRESENTATIVE.
- B. CONDUCT INSPECTIONS INCLUDING BUT NOT LIMITED TO THE FOLLOWING:
 1. GROUNDING SYSTEM INSTALLATION PRIOR TO EARTH CONCEALMENT DOCUMENTED WITH DIGITAL PHOTOGRAPHS BY CONTRACTOR, APPROVED BY A&E OR SPRINT REPRESENTATIVE.
 2. FORMING FOR CONCRETE AND REBAR PLACEMENT PRIOR TO POUR DOCUMENTED WITH DIGITAL PHOTOGRAPHS BY CONTRACTOR, APPROVED BY A&E OR SPRINT REPRESENTATIVE.
 3. COMPACTION OF BACKFILL MATERIALS; AGGREGATE BASE FOR ROADS, PADS, AND ANCHORS; ASPHALT PAVING; AND SHAFT BACKFILL FOR CONCRETE AND WOOD POLES, BY INDEPENDENT THIRD PARTY AGENCY.
 4. PRE- AND POST-CONSTRUCTION ROOFTOP AND STRUCTURAL INSPECTIONS ON EXISTING FACILITIES.
 5. TOWER ERECTION SECTION STACKING AND PLATFORM ATTACHMENT DOCUMENTED BY DIGITAL PHOTOGRAPHS BY THIRD PARTY AGENCY.
 6. ANTENNA AZIMUTH , DOWN TILT AND PER SUNLIGHT TOOL SUNSIGHT INSTRUMENTS - ANTENNALIGN ALIGNMENT TOOL (AAT)

PLANS PREPARED FOR:



1 INTERNATIONAL BLVD, SUITE 800
MAHWAH, NJ 07495
TEL: (800) 357-7641

PROJECT MANAGER:



SBA COMMUNICATIONS CORP.
134 FLANDERS ROAD, SUITE 125
WESTBOROUGH, MA 01581
TEL: (508) 251-0720

PLANS PREPARED BY:



FROM ZERO TO INFINIGY
the solutions are endless
1033 Watervliet Shaker Rd | Albany, NY 12205
Phone: 518-690-0790 | Fax: 518-690-0793
www.infinigy.com
JOB NUMBER 526-104

ENGINEERING LICENSE:



CHECKED BY:

APPROVED BY:

REVISIONS:	DESCRIPTION	DATE	BY	REV.
ISSUED FOR CONSTRUCTION		04/10/18	RWF	0

SITE NUMBER:

CT33XC575

SITE ADDRESS:

31 CHESTNUT HILL ROAD
COLCHESTER, CT 06415

SHEET DESCRIPTION:

OUTLINE SPECIFICATIONS

SHEET NUMBER:

SP-2

CONTINUE FROM SP-2

- 7. VERIFICATION DOCUMENTED WITH THE ANTENNA CHECKLIST REPORT, BY A&E, SITE DEVELOPMENT REP, OR RF REP.
- 8. FINAL INSPECTION CHECKLIST AND HANDOFF WALK (HOC.). SIGNED FORM SHOWING ACCEPTANCE BY FIELD OPS IS TO BE UPLOADED INTO SMS.
- 9. COAX SWEEP AND FIBER TESTING DOCUMENTS SUBMITTED VIA SMS FOR RF APPROVAL.
- 10. SCAN-ABLE BARCODE PHOTOGRAPHS OF TOWER TOP AND INACCESSIBLE SERIALIZED EQUIPMENT
- 11. ALL AVAILABLE JURISDICTIONAL INFORMATION
- 12. PDF SCAN OF REDLINES PRODUCED IN FIELD
- C. THE CONTRACTOR SHALL BE RESPONSIBLE FOR ANY AND ALL CORRECTIONS TO ANY WORK IDENTIFIED AS UNACCEPTABLE IN SITE INSPECTION ACTIVITIES AND/OR AS A RESULT OF TESTING.
- D. CONSTRUCTION INSPECTIONS AND CORRECTIVE MEASURES SHALL BE DOCUMENTED BY THE CONTRACTOR WITH WRITTEN REPORTS AND PHOTOGRAPHS. PHOTOGRAPHS MUST BE DIGITAL AND OF SUFFICIENT QUALITY TO CLEARLY SHOW THE SITE CONSTRUCTION. PHOTOGRAPHS MUST CLEARLY IDENTIFY THE PHOTOGRAPHED ITEM AND BE LABELED WITH THE SITE CASCADE NUMBER, SITE NAME, DESCRIPTION, AND DATE.
- 3.4 DELIVERABLES: TEST AND INSPECTION REPORTS AND CLOSEOUT DOCUMENTATION SHALL BE UPLOADED TO THE SMS AND/OR FORWARDED TO SPRINT FOR INCLUSION INTO THE PERMANENT SITE FILES.
 - A. THE FOLLOWING TEST AND INSPECTION REPORTS SHALL BE PROVIDED AS APPLICABLE.
 - 1. CONCRETE MIX AND CYLINDER BREAK REPORTS.
 - 2. STRUCTURAL BACKFILL COMPACTION REPORTS.
 - 3. SITE RESISTANCE TO EARTH TEST.
 - 4. ANTENNA AZIMUTH AND DOWN TILT VERIFICATION
 - 5. TOWER ERECTION INSPECTIONS AND MEASUREMENTS DOCUMENTING TOWER INSTALLED PER SUPPLIER'S REQUIREMENTS AND THE APPLICABLE SECTIONS HEREIN.
 - 6. COAX CABLE SWEEP TESTS PER COMPANY'S "ANTENNA LINE ACCEPTANCE STANDARDS".
 - B. REQUIRED CLOSEOUT DOCUMENTATION INCLUDES THE FOLLOWING:
 - 1. TEST WELLS AND TRENCHES: PHOTOGRAPHS OF ALL TEST WELLS; PHOTOGRAPHS SHOWING ALL OPEN EXCAVATIONS AND TRENCHING PRIOR TO BACKFILLING SHOWING A TAPE MEASURE VISIBLE IN THE EXCAVATIONS INDICATING DEPTH.
 - 2. CONDUITS, CONDUCTORS AND GROUNDING: PHOTOGRAPHS SHOWING TYPICAL INSTALLATION OF CONDUCTORS AND CONNECTORS; PHOTOGRAPHS SHOWING TYPICAL BEND RADIUS OF INSTALLED GROUND WIRES AND GROUND ROD SPACING;
 - 3. CONCRETE FORMS AND REINFORCING: CONCRETE FORMING AT TOWER AND EQUIPMENT/SHELTER PAD/FOUNDATIONS - PHOTOGRAPHS SHOWING ALL REINFORCING STEEL, UTILITY AND CONDUIT STUB OUTS; PHOTOGRAPHS SHOWING CONCRETE POUR OF SHELTER SLAB/FOUNDATION, TOWER FOUNDATION AND GUY ANCHORS WITH VIBRATOR IN USE; PHOTOGRAPHS SHOWING EACH ANCHOR ON GUYED TOWERS, BEFORE CONCRETE POUR.
 - 4. TOWER, ANTENNAS AND MAINLINE: INSPECTION AND PHOTOGRAPHS OF SECTION STACKING; INSPECTION AND PHOTOGRAPHS OF PLATFORM COMPONENT ATTACHMENT POINTS; PHOTOGRAPHS OF TOWER TOP GROUNDING; PHOTOS OF TOWER COAX LINE COLOR CODING AT THE TOP AND AT GROUND LEVEL; INSPECTION AND PHOTOGRAPHS OF OPERATIONAL OF TOWER LIGHTING, AND PLACEMENT OF FAA REGISTRATION SIGN; PHOTOGRAPHS SHOWING ADDITIONAL GROUNDING POINTS FOR TOWERS GREATER THAN 200 FEET.; PHOTOS OF ANTENNA GROUND BAR, EQUIPMENT GROUND BAR, AND MASTER GROUND BAR; PHOTOS OF GPS ANTENNA(S); PHOTOS OF EACH SECTOR OF ANTENNAS; ONE PHOTOGRAPH LOOKING AT THE SECTOR AND ONE FROM BEHIND SHOWING THE PROJECTED COVERAGE AREA; PHOTOS OF COAX WEATHERPROOFING - TOP AND BOTTOM; PHOTOS OF COAX GROUNDING--TOP AND BOTTOM; PHOTOS OF ANTENNA AND MAST GROUNDING; PHOTOS OF COAX CABLE ENTRY INTO SHELTER; PHOTOS OF PLATFORM MECHANICAL CONNECTIONS TO TOWER/MONOPOLE.
 - 5. ROOF TOPS: PRE-CONSTRUCTION AND POST-CONSTRUCTION VISUAL INSPECTION AND PHOTOGRAPHS OF THE ROOF AND INTERIOR TO DETERMINE AND DOCUMENT CONDITIONS; ROOF TOP CONSTRUCTION INSPECTIONS AS REQUIRED BY THE JURISDICTION; PHOTOGRAPHS OF CABLE TRAY AND/OR ICE BRIDGE; PHOTOGRAPHS OF DOGHOUSE/CABLE EXIT FROM ROOF;
 - 6. SITE LAYOUT - PHOTOGRAPHS OF THE OVERALL COMPOUND, INCLUDING EQUIPMENT PLATFORM FROM ALL FOUR CORNERS.
 - 7. FINISHED UTILITIES: CLOSE-UP PHOTOGRAPHS OF THE PPC BREAKER PANEL; CLOSE-UP PHOTOGRAPH OF THE INSIDE OF THE TELCO PANEL AND NIU; CLOSE-UP PHOTOGRAPH OF THE POWER METER AND DISCONNECT; PHOTOS OF POWER AND TELCO ENTRANCE TO COMPANY ENCLOSURE; PHOTOGRAPHS AT METER BOX AND/OR FACILITY DISTRIBUTION PANEL.
 - 8. REQUIRED MATERIALS CERTIFICATIONS: CONCRETE MIX DESIGNS; MILL CERTIFICATION FOR ALL REINFORCING AND STRUCTURAL STEEL; AND ASPHALT PAVING MIX DESIGN.
 - 9. ANY AND ALL SUBMITTALS BY THE JURISDICTION OR COMPANY.

SECTION 01 400 - SUBMITTALS & TESTS

PART 1 - GENERAL

- 1.1 THE WORK: THESE STANDARD CONSTRUCTION SPECIFICATIONS IN CONJUNCTION WITH THE OTHER CONTRACT DOCUMENTS AND THE CONSTRUCTION DRAWINGS DESCRIBE THE WORK TO BE PERFORMED BY THE CONTRACTOR.
- 1.2 RELATED DOCUMENTS:
 - A. THE REQUIREMENTS OF THIS SECTION APPLY TO ALL SECTIONS IN THIS SPECIFICATION.
 - B. SPRINT "STANDARD CONSTRUCTION DETAILS FOR WIRELESS SITES" ARE INCLUDED IN AND MADE A PART OF THESE SPECIFICATIONS HERewith.

PART 2 - PRODUCTS (NOT USED)

PART 3 - EXECUTION

- 3.1 WEEKLY REPORTS:
 - A. CONTRACTOR SHALL PROVIDE SPRINT WITH WEEKLY REPORTS SHOWING PROJECT STATUS. THIS STATUS REPORT FORMAT WILL BE PROVIDED TO THE CONTRACTOR BY SPRINT. THE REPORT WILL CONTAIN SITE ID NUMBER, THE MILESTONES FOR EACH SITE, INCLUDING THE BASELINE DATE, ESTIMATED COMPLETION DATE AND ACTUAL COMPLETION DATE.
 - B. REPORT INFORMATION WILL BE TRANSMITTED TO SPRINT VIA ELECTRONIC MEANS AS REQUIRED. THIS INFORMATION WILL PROVIDE A BASIS FOR PROGRESS MONITORING AND PAYMENT.
- 3.2 PROJECT CONFERENCE CALLS:
 - A. SPRINT MAY HOLD WEEKLY PROJECT CONFERENCE CALLS. CONTRACTOR WILL BE REQUIRED TO COMMUNICATE SITE STATUS, MILESTONE COMPLETIONS AND UPCOMING MILESTONE PROJECTIONS, AND ANSWER ANY OTHER SITE STATUS QUESTIONS AS NECESSARY.
- 3.3 PROJECT TRACKING IN SMS:
 - A. CONTRACTOR SHALL PROVIDE SCHEDULE UPDATES AND PROJECTIONS IN THE SMS SYSTEM ON A WEEKLY BASIS.
- 3.4 ADDITIONAL REPORTING:
 - A. ADDITIONAL OR ALTERNATE REPORTING REQUIREMENTS MAY BE ADDED TO THE REPORT AS DETERMINED TO BE REASONABLY NECESSARY BY COMPANY.
- 3.5 PROJECT PHOTOGRAPHS:
 - A. FILE DIGITAL PHOTOGRAPHS OF COMPLETED SITE IN JPEG FORMAT IN THE SMS PHOTO LIBRARY FOR THE RESPECTIVE SITE. PHOTOGRAPHS SHALL BE CLEARLY LABELED WITH SITE NUMBER, NAME AND DESCRIPTION, AND SHALL INCLUDE AT A MINIMUM THE FOLLOWING AS APPLICABLE:
 - 1. SHELTER AND TOWER OVERVIEW.
 - 2. TOWER FOUNDATION(S) - FORMS AND STEEL BEFORE POUR (EACH ANCHOR ON GUYED TOWERS).
 - 3. TOWER FOUNDATION(S) POUR WITH VIBRATOR IN USE (EACH ANCHOR ON GUYED TOWERS).
 - 4. TOWER STEEL AS BEING INSTALLED INTO HOLE (SHOW ANCHOR STEEL ON GUYED TOWERS).
 - 5. PHOTOS OF TOWER SECTION STACKING.
 - 6. CONCRETE TESTING / SAMPLES.
 - 7. PLACING OF ANCHOR BOLTS IN TOWER FOUNDATION.
 - 8. BUILDING/WATER TANK FROM ROAD FOR TENANT IMPROVEMENTS OR COMMENTS.
 - 9. SHELTER FOUNDATION--FORMS AND STEEL BEFORE POURING.
 - 10. SHELTER FOUNDATION POUR WITH VIBRATOR IN USE.
 - 11. COAX CABLE ENTRY INTO SHELTER.
 - 12. PLATFORM MECHANICAL CONNECTIONS TO TOWER/MONOPOLE.
 - 13. ROOFTOP PRE AND POST CONSTRUCTION PHOTOS TO INCLUDE PENETRATIONS AND INTERIOR CEILING.
 - 14. PHOTOS OF TOWER TOP COAX LINE COLOR CODING AND COLOR CODING AT GROUND LEVEL.
 - 15. PHOTOS OF ALL APPROPRIATE COMPANY OR REGULATORY SIGNAGE.
 - 16. PHOTOS OF EQUIPMENT BOLT DOWN INSIDE SHELTER.
 - 17. POWER AND TELCO ENTRANCE TO COMPANY ENCLOSURE AND POWER AND TELCO SUPPLY LOCATIONS INCLUDING METER/DISCONNECT.
 - 18. ELECTRICAL TRENCH(S) WITH ELECTRICAL / CONDUIT BEFORE BACKFILL.
 - 19. ELECTRICAL TRENCH(S) WITH FOIL-BACKED TAPE BEFORE FURTHER BACKFILL.
 - 20. TELCO TRENCH WITH TELEPHONE / CONDUIT BEFORE BACKFILL.
 - 21. TELCO TRENCH WITH FOIL-BACKED TAPE BEFORE FURTHER BACKFILL.
 - 22. SHELTER GROUND-RING TRENCH WITH GROUND-WIRE BEFORE BACKFILL (SHOW ALL CAD WELDS AND BEND RADII).
 - 23. TOWER GROUND-RING TRENCH WITH GROUND-WIRE BEFORE BACKFILL (SHOW ALL CAD WELDS AND BEND RADII).

- 24. FENCE GROUND-RING TRENCH WITH GROUND-WIRE BEFORE BACKFILL (SHOW ALL CAD WELDS AND BEND RADII).
- 25. ALL BTS GROUND CONNECTIONS.
- 26. ALL GROUND TEST WELLS.
- 27. ANTENNA GROUND BAR AND EQUIPMENT GROUND BAR.
- 28. ADDITIONAL GROUNDING POINTS ON TOWERS ABOVE 200'.
- 29. HVAC UNITS INCLUDING CONDENSERS ON SPLIT SYSTEMS.
- 30. GPS ANTENNAS.
- 31. CABLE TRAY AND/OR WAVEGUIDE BRIDGE.
- 32. DOGHOUSE/CABLE EXIT FROM ROOF.
- 33. EACH SECTOR OF ANTENNAS; ONE PHOTOGRAPH LOOKING AT THE SECTOR AND ONE FROM BEHIND SHOWING THE PROJECTED COVERAGE AREA.
- 34. MASTER BUS BAR.
- 35. TELCO BOARD AND NIU.
- 36. ELECTRICAL DISTRIBUTION WALL.
- 37. CABLE ENTRY WITH SURGE SUPPRESSION.
- 38. ENTRANCE TO EQUIPMENT ROOM.
- 39. COAX WEATHERPROOFING--TOP AND BOTTOM OF TOWER.
- 40. COAX GROUNDING -TOP AND BOTTOM OF TOWER.
- 41. ANTENNA AND MAST GROUNDING.
- 42. LANDSCAPING - WHERE APPLICABLE.

3.6 FINAL PROJECT ACCEPTANCE: COMPLETE ALL REQUIRED REPORTING TASKS PER CONTRACT, CONTRACT DOCUMENTS OR THE SPRINT INTEGRATED CONSTRUCTION STANDARDS FOR WIRELESS SITES AND UPLOAD INTO SITERRA.

PLANS PREPARED FOR:



1 INTERNATIONAL BLVD, SUITE 800
MAHWAH, NJ 07495
TEL: (800) 357-7641

PROJECT MANAGER:



SBA COMMUNICATIONS CORP.
134 FLANDERS ROAD, SUITE 125
WESTBOROUGH, MA 01581
TEL: (508) 251-0720

PLANS PREPARED BY:



FROM ZERO TO INFINIGY
the solutions are endless
1033 Watervliet Shaker Rd | Albany, NY 12205
Phone: 518-690-0790 | Fax: 518-690-0793
www.infinigy.com
JOB NUMBER 526-104

ENGINEERING LICENSE:

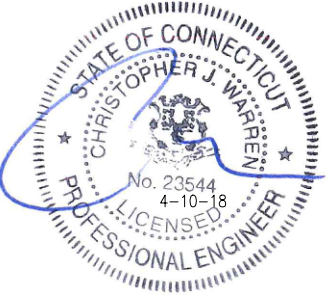

CHECKED BY:

APPROVED BY:

REVISIONS:

DESCRIPTION	DATE	BY	REV.
ISSUED FOR CONSTRUCTION	04/10/18	RWF	0

SITE NUMBER:

CT33XC575

SITE ADDRESS:

31 CHESTNUT HILL ROAD
COLCHESTER, CT 06415

SHEET DESCRIPTION:

OUTLINE SPECIFICATIONS

SHEET NUMBER:

SP-3

NOTE:
SEE DETAIL 2 ON A-3
FOR ANTENNA LAYOUT

NOTE:
FOR DETAILS OF MOUNT AUGMENT REFER TO
MOUNT AUGMENT CD'S DONE BY OTHERS

SPECIAL CONSTRUCTION NOTE:
GENERAL CONTRACTOR SHALL FURNISH AND INSTALL ALL ANTENNA MOUNT STRUCTURAL AUGMENTS
(STRUCTURAL MODIFICATIONS) AT THE SPRINT RAD/VERTICAL EQUIPMENT SPACE PER RECOMMENDATIONS
FROM SBA-PROVIDED ANTENNA MOUNT STRUCTURAL ANALYSIS AND ANY SUPPLEMENTAL CONSTRUCTION
DRAWINGS (PROVIDED BY OTHERS)

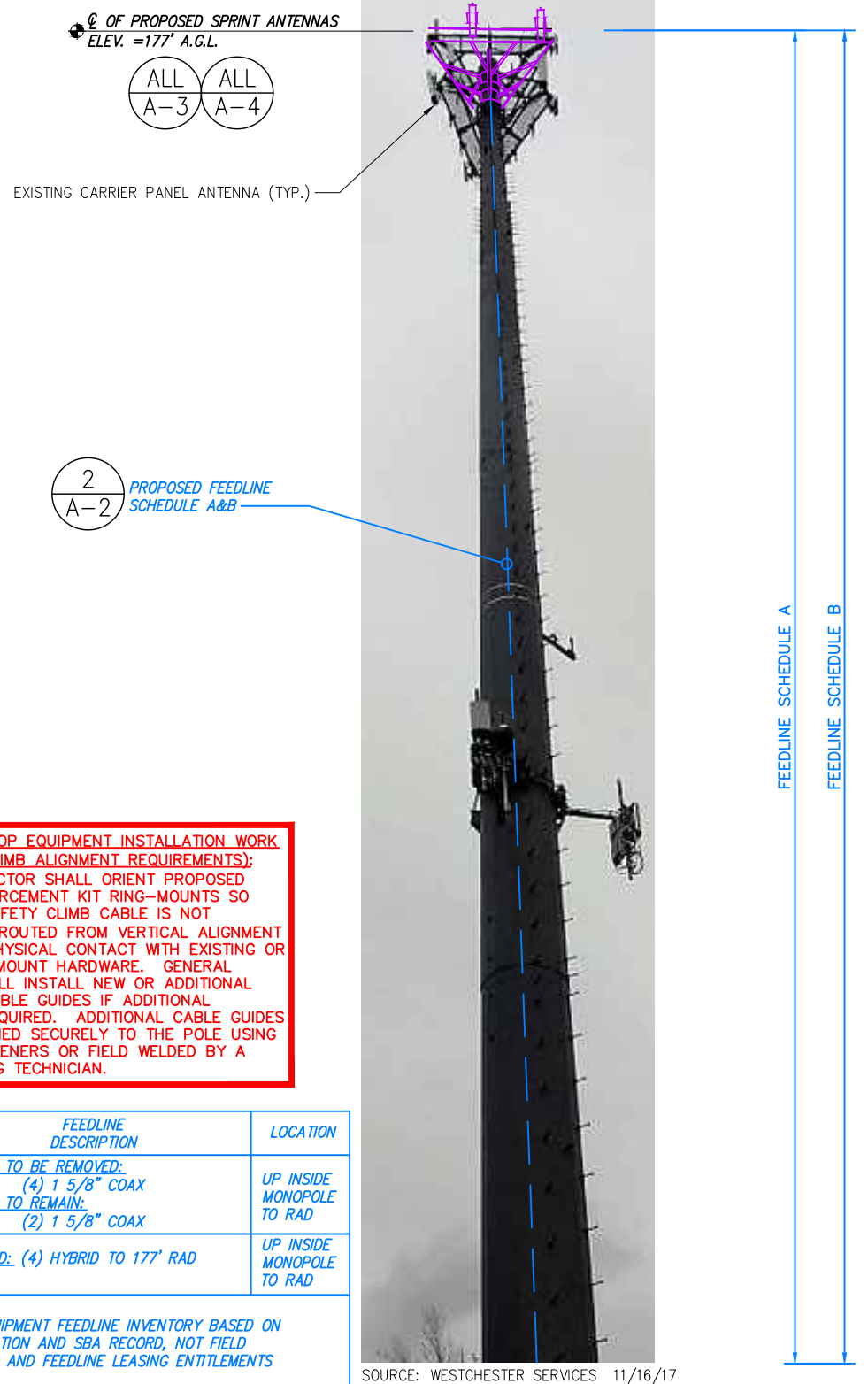
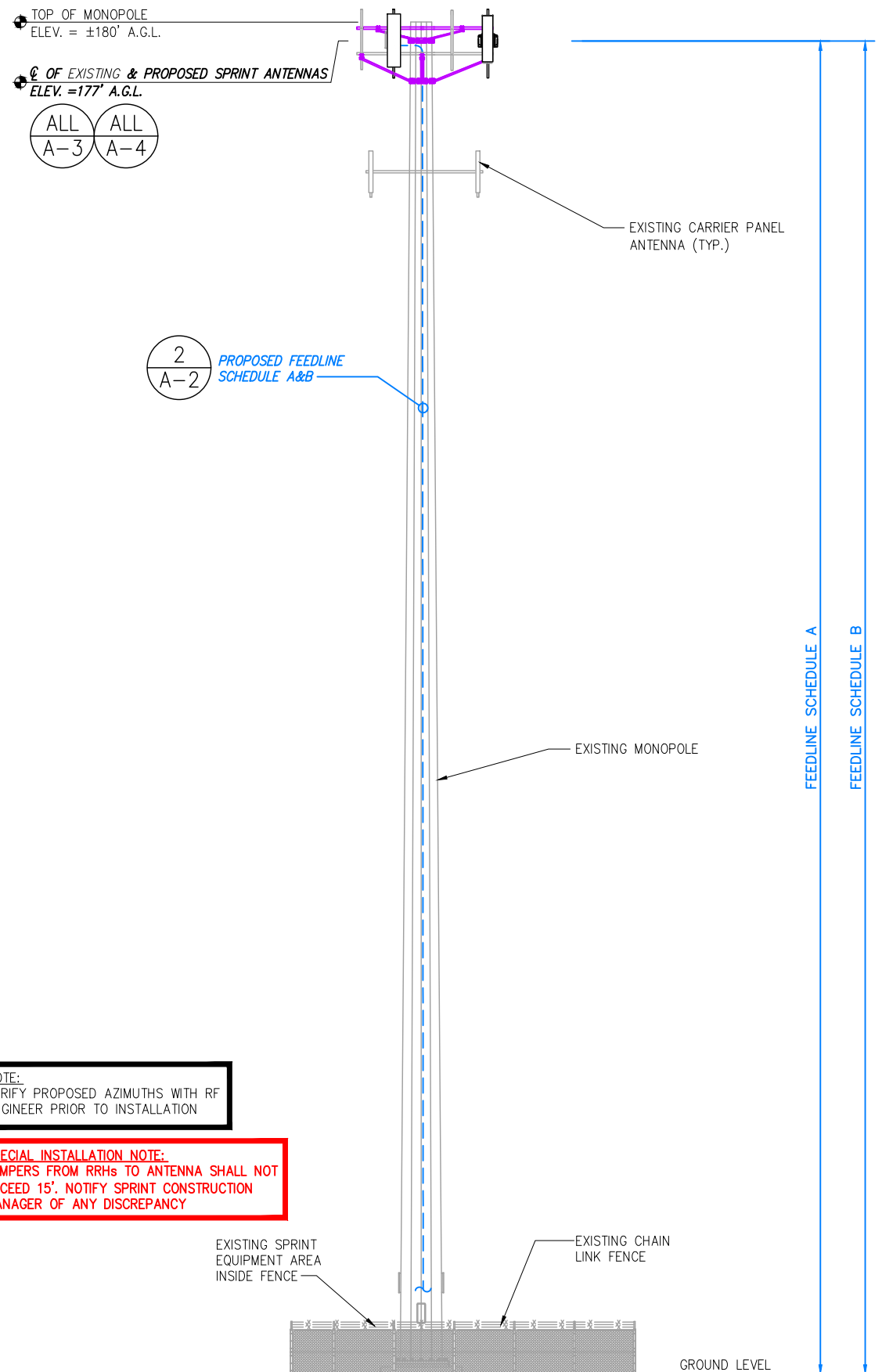

NOTE:
VERIFY PROPOSED AZIMUTHS WITH RF
ENGINEER PRIOR TO INSTALLATION

SPECIAL INSTALLATION NOTE:
JUMPERS FROM RRHs TO ANTENNA SHALL NOT
EXCEED 15'. NOTIFY SPRINT CONSTRUCTION
MANAGER OF ANY DISCREPANCY

SPECIAL TOWER TOP EQUIPMENT INSTALLATION WORK
NOTE (SAFETY-CLIMB ALIGNMENT REQUIREMENTS):
GENERAL CONTRACTOR SHALL ORIENT PROPOSED
PLATFORM REINFORCEMENT KIT RING-MOUNTS SO
THAT EXISTING SAFETY CLIMB CABLE IS NOT
OBSTRUCTED/RE-ROUTED FROM VERTICAL ALIGNMENT
AND IS NOT IN PHYSICAL CONTACT WITH EXISTING OR
PROPOSED RING-MOUNT HARDWARE. GENERAL
CONTRACTOR SHALL INSTALL NEW OR ADDITIONAL
SAFETY-CLIMB CABLE GUIDES IF ADDITIONAL
CLEARANCE IS REQUIRED. ADDITIONAL CABLE GUIDES
SHALL BE ATTACHED SECURELY TO THE POLE USING
MECHANICAL FASTENERS OR FIELD WELDED BY A
CERTIFIED WELDING TECHNICIAN.

FEEDLINE SCHEDULE	FEEDLINE DESCRIPTION	LOCATION
A	EXISTING TO BE REMOVED: (4) 1 5/8" COAX EXISTING TO REMAIN: (2) 1 5/8" COAX	UP INSIDE MONOPOLE TO RAD
B	PROPOSED: (4) HYBRID TO 177' RAD	UP INSIDE MONOPOLE TO RAD

NOTE:
EXISTING SPRINT EQUIPMENT FEEDLINE INVENTORY BASED ON
COLOCATION APPLICATION AND SBA RECORD, NOT FIELD
OBSERVATIONS. RFDS AND FEEDLINE LEASING ENTITLEMENTS
MAY DIFFER.

SOURCE: WESTCHESTER SERVICES 11/16/17

PLANS PREPARED FOR:

1 INTERNATIONAL BLVD, SUITE 800
MAHWAH, NJ 07495
TEL: (800) 357-7641

PROJECT MANAGER:

SBA COMMUNICATIONS CORP.
134 FLANDERS ROAD, SUITE 125
WESTBOROUGH, MA 01581
TEL: (508) 251-0720

PLANS PREPARED BY:

FROM ZERO TO INFINIGY
the solutions are endless
1033 Watervliet Shaker Rd | Albany, NY 12205
Phone: 518-690-0790 | Fax: 518-690-0793
www.infinigy.com
JOB NUMBER 526-104

ENGINEERING LICENSE:

CHECKED BY:

APPROVED BY:

REVISIONS:	DESCRIPTION	DATE	BY	REV.
ISSUED FOR CONSTRUCTION		04/10/18	RWF	0

SITE NUMBER:
CT33XC575

SITE ADDRESS:
31 CHESTNUT HILL ROAD
COLCHESTER, CT 06415

SHEET DESCRIPTION:
TOWER ELEVATION

SHEET NUMBER:
A-2

SPECIAL CONSTRUCTION NOTE:
GENERAL CONTRACTOR SHALL FURNISH AND INSTALL ALL ANTENNA MOUNT STRUCTURAL AUGMENTS (STRUCTURAL MODIFICATIONS) AT THE SPRINT RAD/VERTICAL EQUIPMENT SPACE PER RECOMMENDATIONS FROM SBA-PROVIDED ANTENNA MOUNT STRUCTURAL ANALYSIS AND ANY SUPPLEMENTAL CONSTRUCTION DRAWINGS (PROVIDED BY OTHERS)

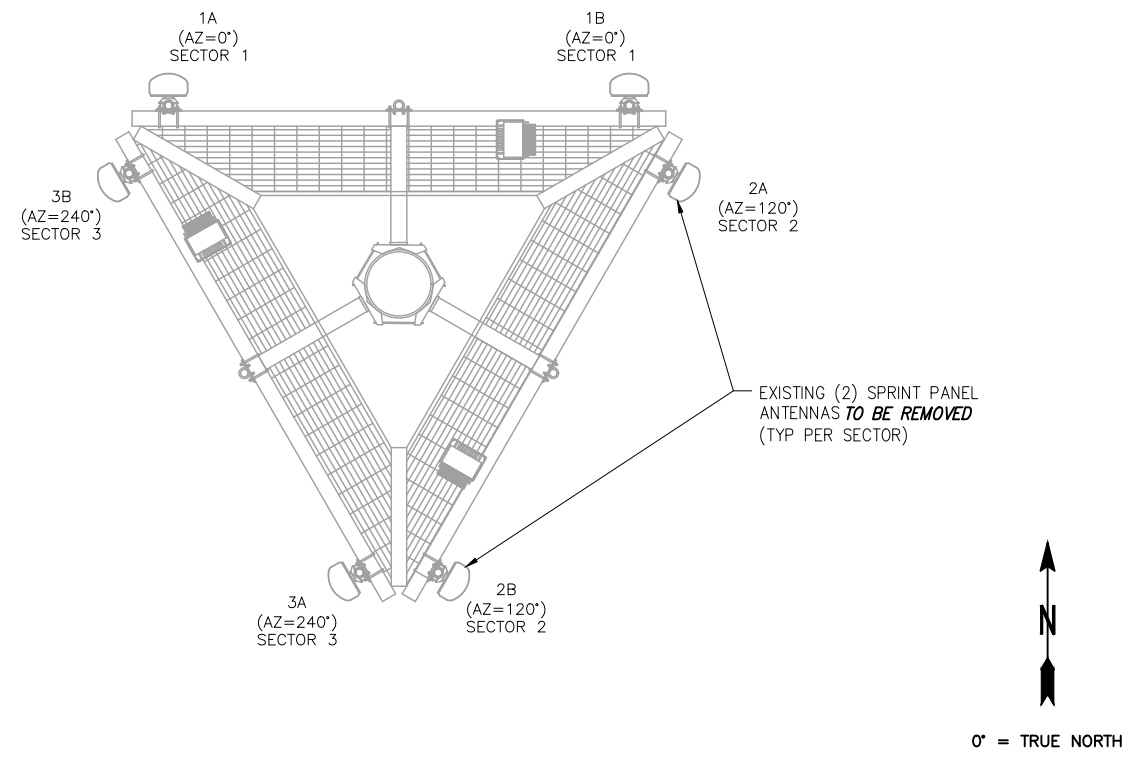

EXISTING ANTENNA & RRH LAYOUT

NO SCALE 1

SPECIAL INSTALLATION NOTE:
JUMPERS FROM RRHs TO ANTENNA SHALL NOT EXCEED 15'. NOTIFY SPRINT CONSTRUCTION MANAGER OF ANY DISCREPANCY

NOTE:
VERIFY PROPOSED AZIMUTHS WITH RF ENGINEER PRIOR TO INSTALLATION

NOTE:
FOR DETAILS OF MOUNT AUGMENT REFER TO MOUNT AUGMENT CD'S DONE BY OTHERS

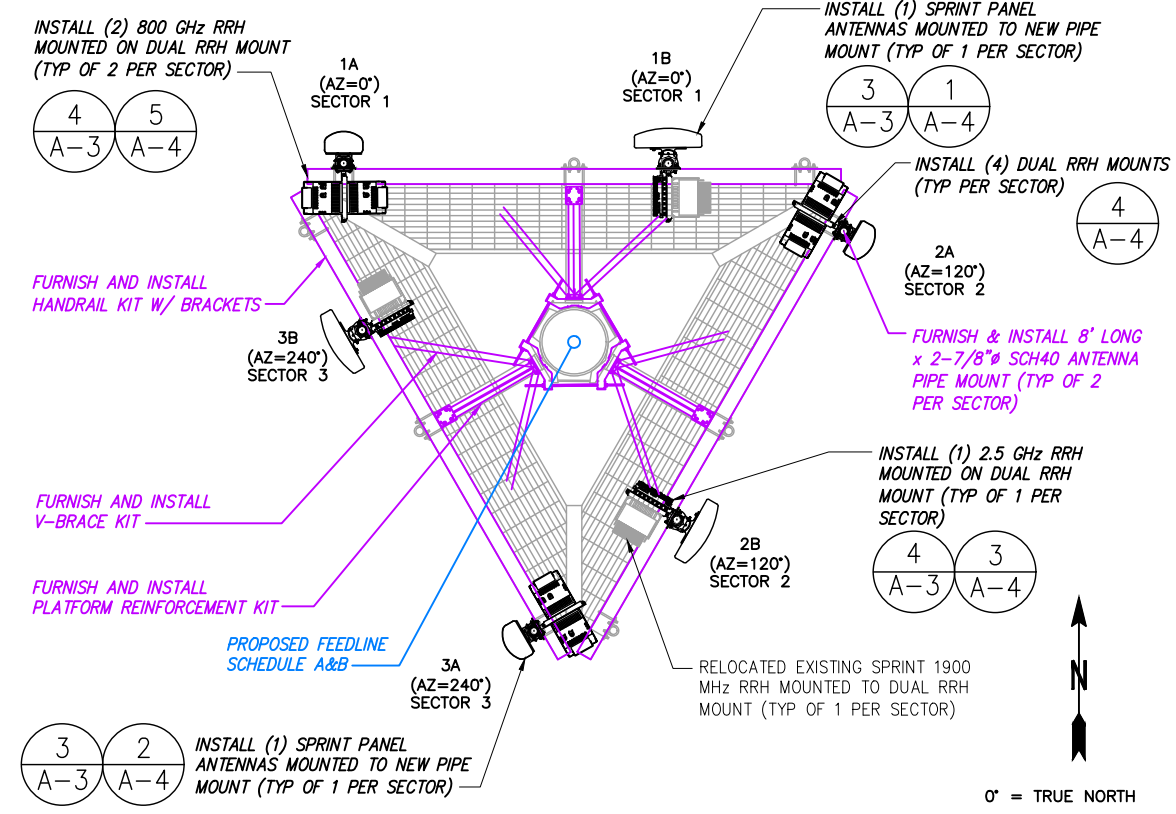

FINAL ANTENNA LAYOUT

NO SCALE 2

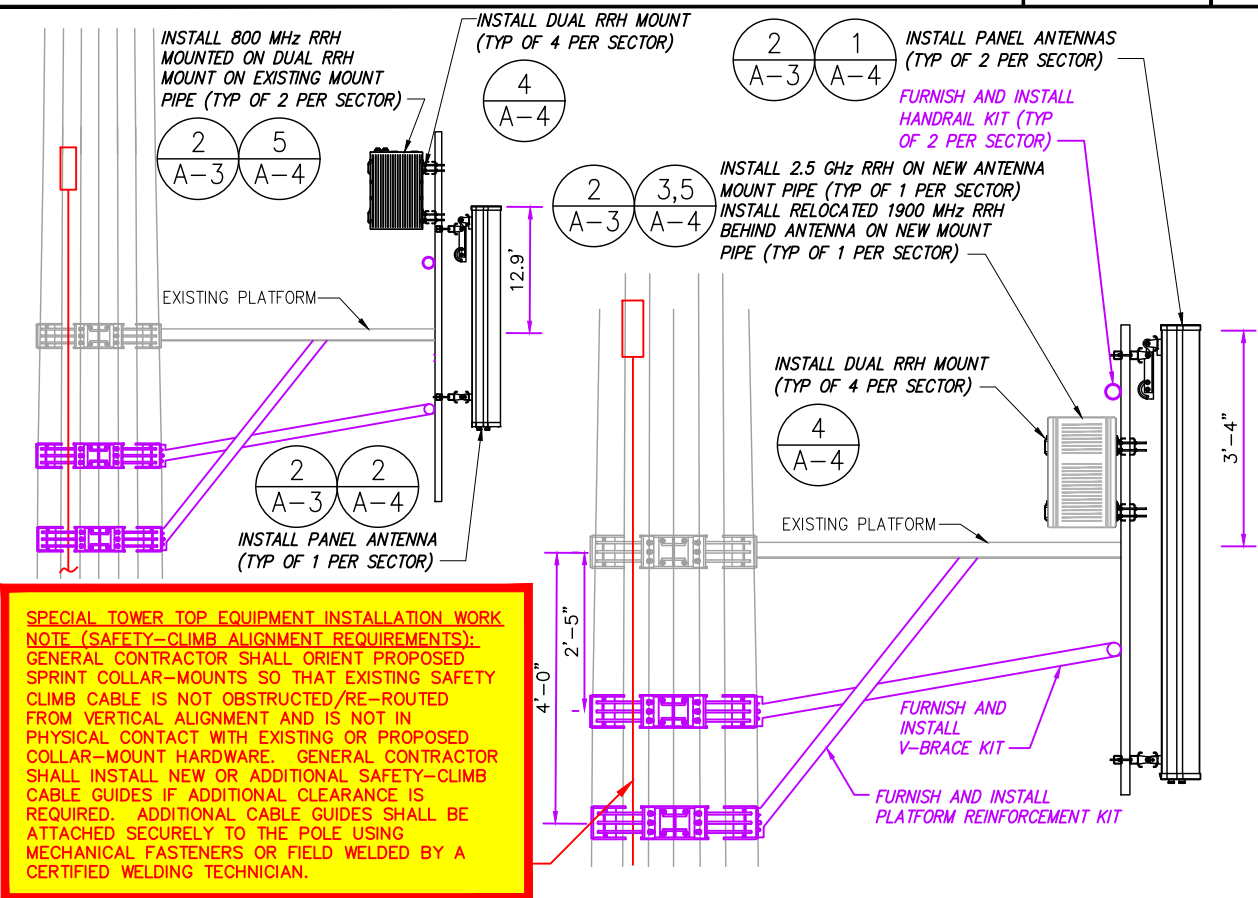

SPECIAL TOWER TOP EQUIPMENT INSTALLATION WORK NOTE (SAFETY-CLIMB ALIGNMENT REQUIREMENTS):
GENERAL CONTRACTOR SHALL ORIENT PROPOSED SPRINT COLLAR-MOUNTS SO THAT EXISTING SAFETY CLIMB CABLE IS NOT OBSTRUCTED/RE-ROUTED FROM VERTICAL ALIGNMENT AND IS NOT IN PHYSICAL CONTACT WITH EXISTING OR PROPOSED COLLAR-MOUNT HARDWARE. GENERAL CONTRACTOR SHALL INSTALL NEW OR ADDITIONAL SAFETY-CLIMB CABLE GUIDES IF ADDITIONAL CLEARANCE IS REQUIRED. ADDITIONAL CABLE GUIDES SHALL BE ATTACHED SECURELY TO THE POLE USING MECHANICAL FASTENERS OR FIELD WELDED BY A CERTIFIED WELDING TECHNICIAN.

TYPICAL MOUNTING DETAILS

NO SCALE 3

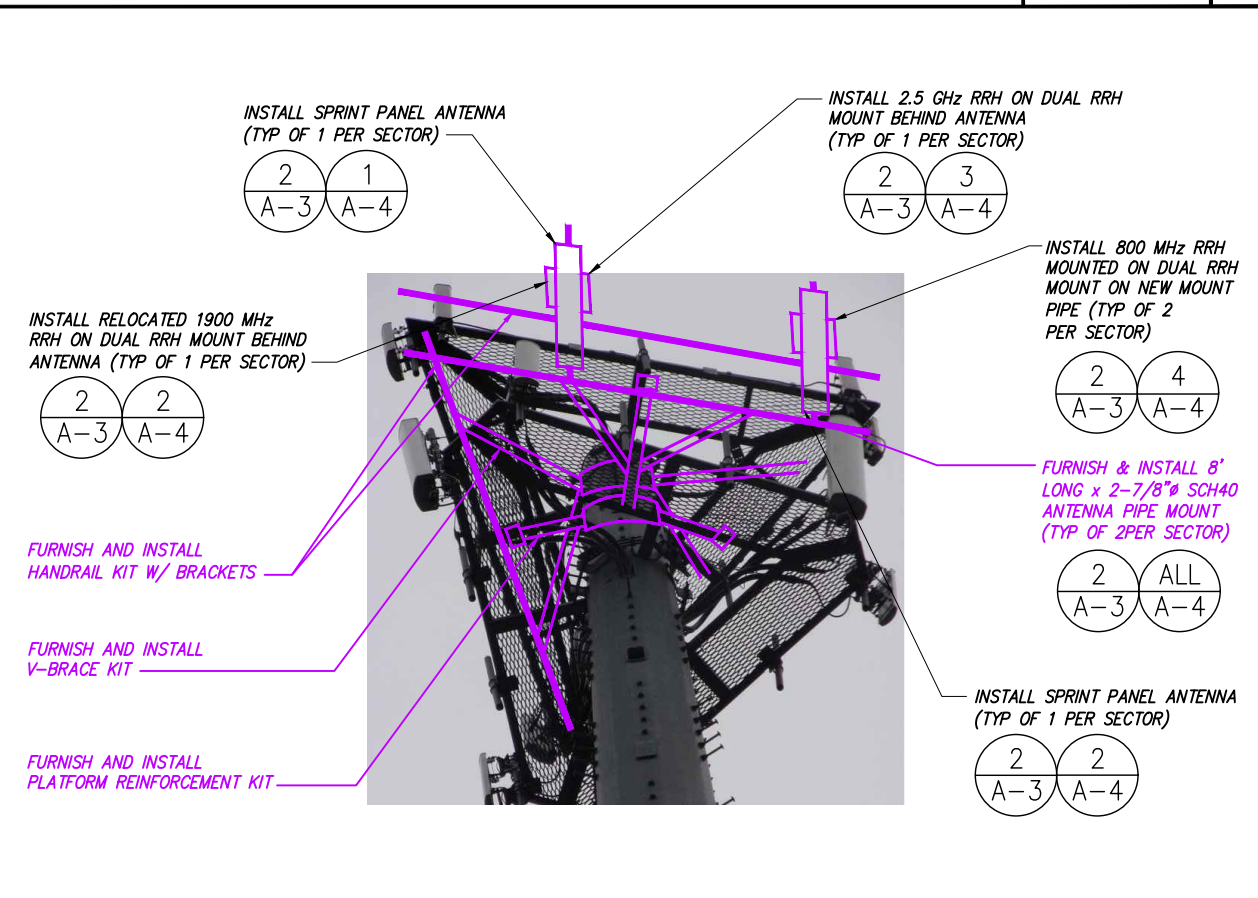

ANTENNA & RRH MOUNT PHOTO DETAIL

NO SCALE 4

PLANS PREPARED FOR:

1 INTERNATIONAL BLVD, SUITE 800
MAHWAH, NJ 07495
TEL: (800) 357-7641

PROJECT MANAGER:

SBA COMMUNICATIONS CORP.
134 FLANDERS ROAD, SUITE 125
WESTBOROUGH, MA 01581
TEL: (508) 251-0720

PLANS PREPARED BY:

FROM ZERO TO INFINIGY
the solutions are endless

1033 Watervliet Shaker Rd | Albany, NY 12205
Phone: 518-690-0790 | Fax: 518-690-0793
www.infinigy.com
JOB NUMBER 526-104

ENGINEERING LICENSE:

STATE OF CONNECTICUT
CHRISTOPHER J. WARREN
No. 23544
4-10-18
LICENSED PROFESSIONAL ENGINEER

CHECKED BY:

APPROVED BY:

REVISIONS:

DESCRIPTION	DATE	BY	REV.
ISSUED FOR CONSTRUCTION	04/10/18	RWF	0

SITE NUMBER:
CT33XC575

SITE ADDRESS:
31 CHESTNUT HILL ROAD
COLCHESTER, CT 06415

SHEET DESCRIPTION:
ANTENNA LAYOUT & MOUNTING DETAILS

SHEET NUMBER:
A-3

PLANS PREPARED FOR:
Sprint
 1 INTERNATIONAL BLVD, SUITE 800
 MAHWAH, NJ 07495
 TEL: (800) 357-7641

PROJECT MANAGER:
SBA
 SBA COMMUNICATIONS CORP.
 134 FLANDERS ROAD, SUITE 125
 WESTBOROUGH, MA 01581
 TEL: (508) 251-0720

PLANS PREPARED BY:
INFINIGY
 FROM ZERO TO INFINIGY
 the solutions are endless
 1033 Watervliet Shaker Rd | Albany, NY 12205
 Phone: 518-690-0790 | Fax: 518-690-0793
 www.infinigy.com
 JOB NUMBER 526-104

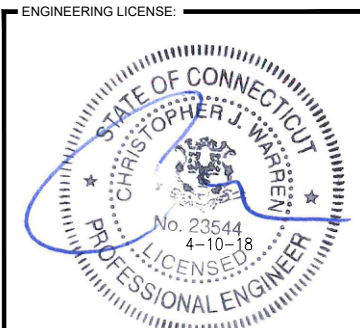

CHECKED BY:

APPROVED BY:

REVISIONS:	DESCRIPTION	DATE	BY	REV.
ISSUED FOR CONSTRUCTION		04/10/18	RWF	0

SITE NUMBER:
CT33XC575

SITE ADDRESS:
 31 CHESTNUT HILL ROAD
 COLCHESTER, CT 06415

SHEET DESCRIPTION:
EQUIPMENT & MOUNTING DETAILS

SHEET NUMBER:
A-4

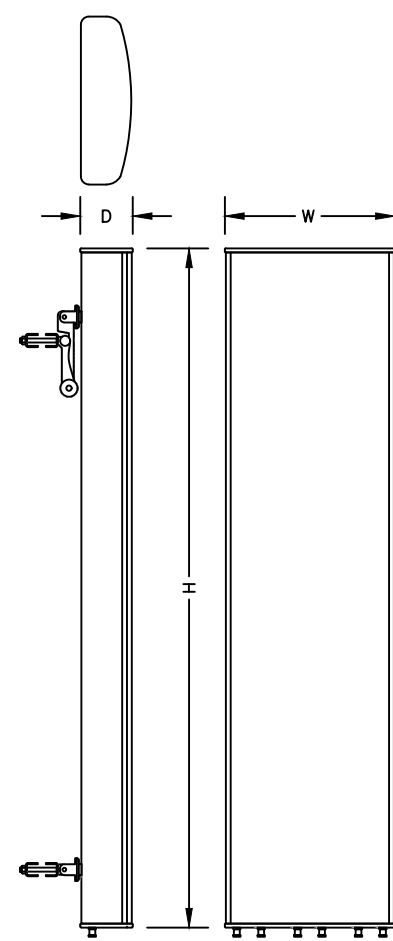

ANTENNA SPECIFICATIONS	
MANUF.	COMMSCOPE
MODEL #	NNVV-65B-R4
HEIGHT	72"
WIDTH	19.6"
DEPTH	7.8"
WEIGHT	84.7± LBS.

ANTENNA DETAIL

NO SCALE

1

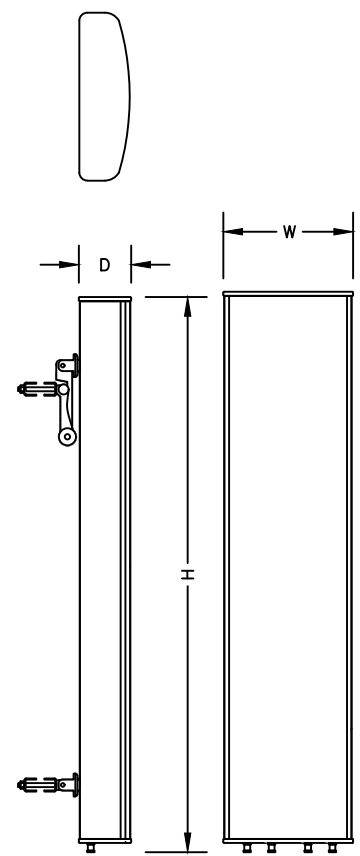

ANTENNA SPECIFICATIONS	
MANUF.	RFS
MODEL #	APXVTM14-ALU-I20
HEIGHT	56.3"
WIDTH	12.6"
DEPTH	6.3"
WEIGHT	56.2± LBS.

ANTENNA DETAIL

NO SCALE

2

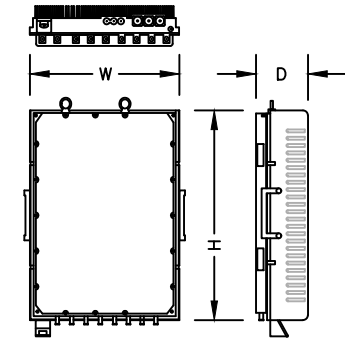

2.5 GHZ RRH SPECIFICATIONS	
MANUF.	NOKIA (ALU)
MODEL #	TD-RRH8X20-25
HEIGHT	26.1"
WIDTH	18.6"
DEPTH	6.7"
WEIGHT	70± LBS

2.5 RRH

NO SCALE

3

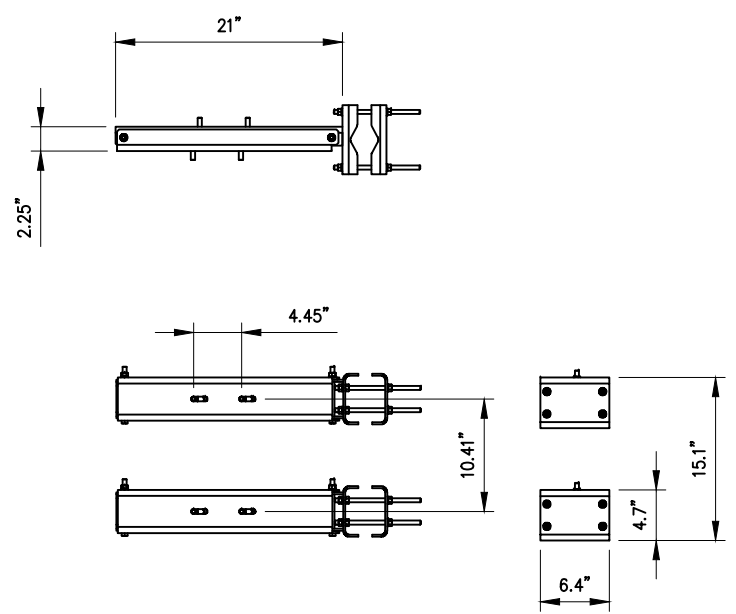

DUAL RRH MOUNT DETAIL

NO SCALE

4

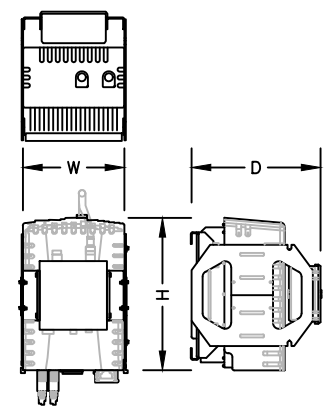

800 MHZ RRH SPECIFICATIONS	
MANUF.	NOKIA (ALU)
MODEL #	800MHZ 2X50W
HEIGHT	19.7"
WIDTH	13"
DEPTH	10.8"
WEIGHT	53± LBS

800 MHz RRH

NO SCALE

5

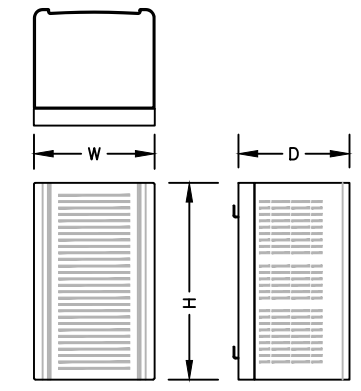

1900 MHZ RRH SPECIFICATIONS	
MANUF.	NOKIA (ALU)
MODEL #	1900 4X45 65MHZ
HEIGHT	25"
WIDTH	11.1"
DEPTH	11.4"
WEIGHT	60± LBS

1900 MHz RRH (EXISTING TO BE RELOCATED)

NO SCALE

6

RFS HYBRIFLEX RISER CABLE SCHEDULE

Fiber Only (Existing DC Power)	Hybrid cable MN: HB058-M12-050F 12x multi-mode fiber pairs, Top: Outdoor protected connectors, Bottom: LC Connectors, 5/8 cable, 50 ft	50 ft
	MN: HB058-M12-075F	75 ft
	MN: HB058-M12-100F	100 ft
	MN: HB058-M12-125F	125 ft
	MN: HB058-M12-150F	150 ft
	MN: HB058-M12-175F	175 ft
	MN: HB058-M12-200F	200 ft
8 AWG Power	Hybrid cable MN: HB114-08U3M12-050F 3x 8 AWG power pairs, 12x multi-mode fiber pairs, Outdoor rated connectors & LC Connectors, 1 1/4 cable, 50 ft	50 ft
	MN: HB114-08U3M12-075F	75 ft
	MN: HB114-08U3M12-100F	100 ft
	MN: HB114-08U3M12-125F	125 ft
	MN: HB114-08U3M12-150F	150 ft
	MN: HB114-08U3M12-175F	175 ft
	MN: HB114-08U3M12-200F	200 ft
6 AWG Power	Hybrid cable MN: HB114-13U3M12-225F 3x 6 AWG power pair, 12x multi-mode fiber pairs, Outdoor rated connectors & LC Connectors, 1 1/4 cable, 225 ft	225 ft
	MN: HB114-13U3M12-250F	250 ft
	MN: HB114-13U3M12-275F	275 ft
	MN: HB114-13U3M12-300F	300 ft
4 AWG Power	Hybrid cable MN: HB114-21U3M12-325F 3x 4 AWG power pair, 12x multi-mode fiber pairs, Outdoor rated connectors & LC Connectors, 1 1/4 cable, 325 ft	325 ft
	MN: HB114-21U3M12-350F	350 ft
	MN: HB114-21U3M12-375F	375 ft

RFS HYBRIFLEX JUMPER CABLE SCHEDULE

Fiber Only	Hybrid Jumper cable MN: HBF012-M3-5F1 5 ft, 3x multi-mode fiber pairs, Outdoor & LC connectors, 1/2 cable	5 ft
	MN: HBF012-M3-10F1	10 ft
	MN: HBF012-M3-15F1	15 ft
	MN: HBF012-M3-20F1	20 ft
	MN: HBF012-M3-25F1	25 ft
	MN: HBF012-M3-30F1	30 ft
8 AWG Power	Hybrid Jumper cable MN: HBF058-08U1M3-5F1 5 ft, 1x 8 AWG power pair, 3x multi-mode fiber pairs, Outdoor & LC Connectors, 5/8 cable	5 ft
	MN: HBF058-08U1M3-10F1	10 ft
	MN: HBF058-08U1M3-15F1	15 ft
	MN: HBF058-08U1M3-20F1	20 ft
	MN: HBF058-08U1M3-25F1	25 ft
	MN: HBF058-08U1M3-30F1	30 ft
6 AWG Power	Hybrid Jumper cable MN: HBF058-13U1M3-5F1 5 ft, 1x 6 AWG power pair, 3x multi-mode fiber pairs, Outdoor & LC Connectors, 5/8 cable	5 ft
	MN: HBF058-13U1M3-10F1	10 ft
	MN: HBF058-13U1M3-15F1	15 ft
	MN: HBF058-13U1M3-20F1	20 ft
	MN: HBF058-13U1M3-25F1	25 ft
	MN: HBF058-13U1M3-30F1	30 ft
4 AWG Power	Hybrid Jumper cable MN: HBF078-21U1M3-5F1 5 ft, 1x 4 AWG power pair, 3x multi-mode fiber pairs, Outdoor & LC Connectors, 7/8 cable	5 ft
	MN: HBF078-21U1M3-10F1	10 ft
	MN: HBF078-21U1M3-15F1	15 ft
	MN: HBF078-21U1M3-20F1	20 ft
	MN: HBF078-21U1M3-25F1	25 ft
	MN: HBF078-21U1M3-30F1	30 ft

NOTE:
SPRINT CM TO CONFIRM HYBRID OR FIBER RISER CABLE
AND HYBRID OR FIBER JUMPER CABLE MODEL NUMBERS IF
HYBRID CABLES ARE REQUIRED BEFORE PREPARING BOM.

- * PROPOSED CABLE LENGTH WAS DETERMINED USING THE SUM OF THE RAD CENTER OF ANTENNAS, AND DISTANCE FROM EXISTING EQUIPMENT AREA TO TOWER BASE WITH AN ADDITIONAL 20' BUFFER. LENGTH TO BE VERIFIED IN FIELD PRIOR TO ORDERING MATERIALS.
- * SPRINT CM TO CONFIRM HYBRID RISER CABLE AND HYBRID JUMPER CABLE MODEL NUMBERS BEFORE PREPARING BOM.

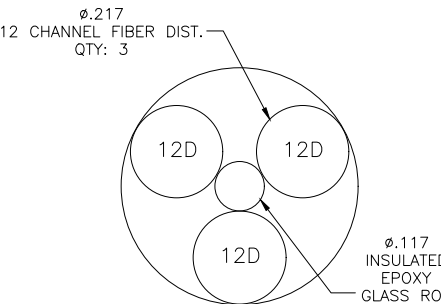
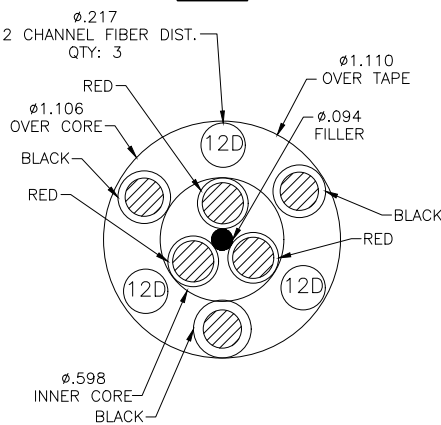
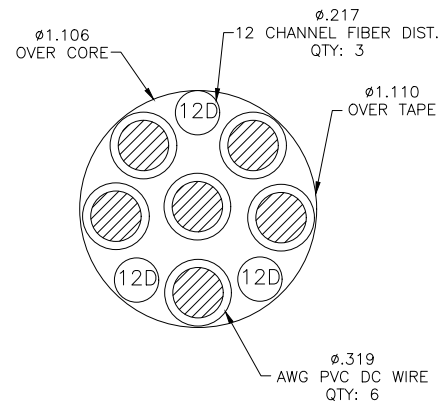

PLANS PREPARED FOR:
Sprint
1 INTERNATIONAL BLVD, SUITE 800
MAHWAH, NJ 07495
TEL: (800) 357-7641

PROJECT MANAGER:
SBA
SBA COMMUNICATIONS CORP.
134 FLANDERS ROAD, SUITE 125
WESTBOROUGH, MA 01581
TEL: (508) 251-0720

PLANS PREPARED BY:
INFINIGY
FROM ZERO TO INFINIGY
the solutions are endless
1033 Watervliet Shaker Rd | Albany, NY 12205
Phone: 518-690-0790 | Fax: 518-690-0793
www.infinigy.com
JOB NUMBER 526-104

ENGINEERING LICENSE:

STATE OF CONNECTICUT
CHRISTOPHER J. WARREN
No. 23544
4-10-18
LICENSED PROFESSIONAL ENGINEER

CHECKED BY:

APPROVED BY:

REVISIONS:	DESCRIPTION	DATE	BY	REV.
ISSUED FOR CONSTRUCTION		04/10/18	RWF	0

SITE NUMBER:
CT33XC575

SITE ADDRESS:
31 CHESTNUT HILL ROAD
COLCHESTER, CT 06415

SHEET DESCRIPTION:
DETAILS

SHEET NUMBER:
A-5

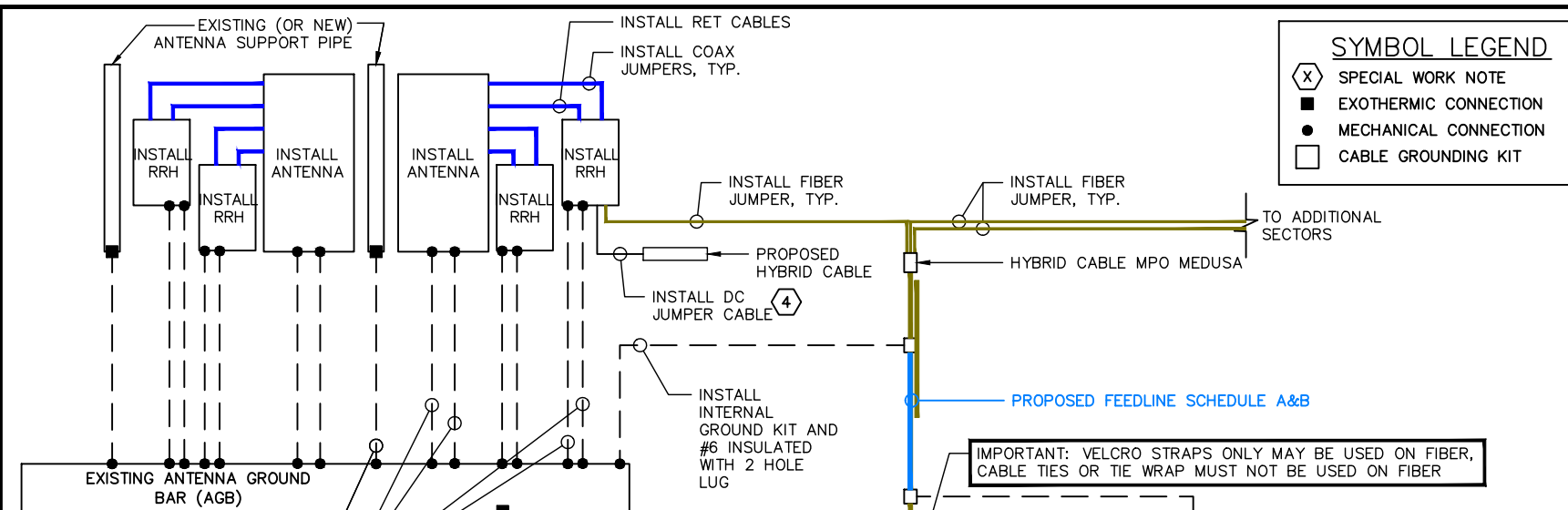

SYMBOL LEGEND

(X)	SPECIAL WORK NOTE
■	EXOTHERMIC CONNECTION
●	MECHANICAL CONNECTION
□	CABLE GROUNDING KIT

- ELECTRICAL NOTES**
- 1) ALL ELECTRICAL WORK SHALL CONFORM TO THE REQUIREMENTS OF THE NATIONAL ELECTRICAL CODE (NEC) AS WELL AS APPLICABLE STATE AND LOCAL CODES.
 - 2) THE ELECTRICAL CONTRACTOR SHALL COORDINATE ALL CONDUIT ROUTING WITH LOCAL UTILITY COMPANIES AND SPRINT CONSTRUCTION MANAGER.
 - 3) ALL CONDUITS ROUTED BELOW GRADE SHALL TRANSITION TO RIGID GALVANIZED ELBOWS WITH RIGID GALVANIZED STEEL CONDUIT ABOVE GRADE.
 - 4) ALL METAL CONDUITS SHALL BE PROVIDED WITH GROUNDING BUSHINGS.
 - 5) GENERAL CONTRACTOR SHALL PROVIDE ALL DIRECT BURIED CONDUITS WITH PLASTIC WARNING TAPE IDENTIFYING CONTENTS. TAPE COLORS SHALL BE ORANGE FOR TELEPHONE AND RED FOR ELECTRIC.
 - 6) ALL ELECTRICAL ITEMS SHALL BE U.L. APPROVED OR LISTED AND PROCURED PER SPECIFICATION REQUIREMENTS.
 - 7) THE ELECTRICAL WORK INCLUDES ALL LABOR AND MATERIALS DESCRIBED BY DRAWINGS AND SPECIFICATIONS INCLUDING INCIDENTAL WORK TO PROVIDE COMPLETE OPERATING AND APPROVED ELECTRICAL SYSTEM.
 - 8) GENERAL CONTRACTOR SHALL PAY FEES FOR PERMITS, AND IS RESPONSIBLE FOR OBTAINING SAID PERMITS AND COORDINATION OF INSPECTIONS.
 - 9) ELECTRICAL AND TELCO WIRING OUTSIDE A BUILDING AND EXPOSED TO WEATHER SHALL BE IN WATER TIGHT GALVANIZED RIGID STEEL CONDUITS OR SCHEDULE 80 PVC (AS PERMITTED BY CODE) AND WHERE REQUIRED IN LIQUID TIGHT FLEXIBLE METAL OR NONMETALLIC CONDUITS.
 - 10) BURIED CONDUIT SHALL BE SCHEDULE 40 PVC.
 - 11) ELECTRICAL WIRING SHALL BE COPPER WITH TYPE XHHW, THWN, OR THIN INSULATION.
 - 12) RUN ELECTRICAL CONDUIT OR CABLE BETWEEN ELECTRICAL UTILITY DEMARCATION POINT AND PROJECT OWNER CELL SITE PPC AS INDICATED ON THIS DRAWING. PROVIDE FULL LENGTH PULL ROPE. COORDINATE INSTALLATION WITH UTILITY COMPANY.
 - 13) RUN TELCO CONDUIT OR CABLE BETWEEN TELEPHONE UTILITY DEMARCATION POINT AND PROJECT OWNER CELL SITE TELCO CABINET AND BTS CABINET AS INDICATED ON THIS DRAWING PROVIDE FULL LENGTH PULL ROPE IN INSTALLED TELCO CONDUIT. PROVIDE GREENLEE CONDUIT MEASURING TAPE AT EACH END.
 - 14) FIBER OPTIC CIRCUITS SHALL BE IN ACCORDANCE WITH NEC ARTICLE 770—OPTICAL FIBER CABLES AND RACEWAYS.
 - 15) COMMUNICATIONS CIRCUITS SHALL BE IN ACCORDANCE WITH NEC ARTICLE 800—COMMUNICATIONS SYSTEMS.

- SPECIAL WORK NOTE:**
1. G.C. TO FURNISH AND INSTALL ALL COMPONENTS TO UPGRADE EXISTING ELECTRICAL SERVICE, CONDUIT, CONDUCTOR, PPC AND MCB IN ACCORDANCE WITH SPRINT CONSTRUCTION STANDARDS NV 2.5 ADDENDUM "ENGINEERING NOTICE 2013-002 (POWER UPGRADES) REV." (OR CURRENT VERSION)
 2. G.C. TO FURNISH AND INSTALL UPGRADE THE EXISTING MMBTS BREAKER, CONDUCTOR, AND CONDUIT TO A MINIMUM NEC RATING.
 3. FOR NEW OR REPAIRED GROUNDING EQUIPMENT, REFER TO SPRINT GROUNDING STANDARDS AND FOLLOWING (SUPPLEMENTS):
-ANTI-THEFT UPDATE TO SPRINT GROUNDING DATED 08-24-12 (OR CURRENT VERSION)
-SPRINT ENGINEERING LETTER EL-0504 DATED 04-20-12 (OR CURRENT VERSION)
 4. USE SPARE DC CABLES COILED UP AT TOWER TOP NV ARRAY TO POWER UP 2.5 RRH. INSIDE EXISTING FIBER DISTRIBUTION BOX, TIE SPARE DC CONDUCTORS INTO EXISTING DC BREAKER PANEL PER APPROVED DC WIRING CONNECTIVITY OPTION (BASED ON NV HYBRIFLEX CABLE LENGTH). CONSULT WITH SPRINT CM TO DETERMINE APPROPRIATE DC CONNECTIVITY OPTION, PLUMBING DIAGRAM AND DC BREAKER SIZE.

- PROTECTIVE GROUNDING SYSTEMS GENERAL NOTES:**
1. GROUNDING SHALL BE IN ACCORDANCE WITH NEC ARTICLE 250—GROUNDING AND BONDING.
 2. GROUNDING SHALL BE IN ACCORDANCE WITH SPRINT SSEO DOCUMENTS 3.018.02.004 "BONDING, GROUNDING AND TRANSIENT PROTECTION FOR CELL SITES" AND 3.018.10.002 "SITE RESISTANCE TO EARTH TESTING".
 3. PROVIDE GROUND CONNECTIONS FOR ALL METALLIC STRUCTURES, ENCLOSURES, RACEWAYS AND OTHER CONDUCTIVE ITEMS ASSOCIATED WITH THE INSTALLATION OF CARRIER'S EQUIPMENT.
 4. GROUND CONNECTIONS: CLEAN SURFACES THOROUGHLY BEFORE APPLYING GROUND LUGS OR CLAMPS. IF SURFACE IS COATED, REMOVE THE COATING, APPLY A NON-CORROSIVE APPROVED COMPOUND TO CLEAN SURFACE AND INSTALL LUGS OR CLAMPS. WHERE GALVANIZING IS REMOVED FROM METAL, IT SHALL BE PAINTED OR TOUCHED UP WITH "GALVANOX" OR EQUAL.
 5. ALL GROUNDING WIRES SHALL PROVIDE A STRAIGHT, DOWNWARD PATH TO GROUND WITH GRADUAL BENDS AS REQUIRED. GROUND WIRES SHALL NOT BE LOOPED OR SHARPLY BENT.
 6. ALL CLAMPS AND SUPPORTS USED TO SUPPORT THE GROUNDING SYSTEM CONDUCTORS AND PVC CONDUITS SHALL BE PVC TYPE (NON CONDUCTIVE). DO NOT USE METAL BRACKETS OR SUPPORTS WHICH WOULD FORM A COMPLETE RING AROUND ANY GROUNDING CONDUCTOR.
 7. ALL GROUND WIRES SHALL BE #2 SOLID TINNED BCW UNLESS NOTED OTHERWISE.
 8. PROVIDE DEDICATED #2 AWG COPPER GROUND WIRE FROM EACH ANTENNA MOUNTING PIPE TO ASSOCIATED CIGBE.
 9. GROUND ANTENNA BASES, FRAMES, CABLE RACKS, AND OTHER METALLIC COMPONENTS WITH #2 INSULATED TINNED STRANDED COPPER GROUNDING CONDUCTORS AND CONNECT TO INSULATED SURFACE MOUNTED GROUND BARS. CONNECTION DETAILS SHALL FOLLOW MANUFACTURER'S SPECIFICATIONS FOR GROUNDING.
 10. EACH EQUIPMENT CABINET SHALL BE CONNECTED TO THE MASTER ISOLATION GROUND BAR (MGB) WITH #2 SOLID TINNED BCW EQUIPMENT CABINETS WILL HAVE (2) CONNECTIONS.
 11. GROUND HYBRIFLEX SHIELD AT TOP, BOTTOM AND AT TRANSITION TO HYBRIFLEX JUMPER CABLES AT EQUIPMENT CABINET ENTRANCE USING MANUFACTURER'S GUIDELINES. WHEN HYBRIFLEX CABLE EXCEEDS 200', GROUND AT INTERVALS NOT EXCEEDING 100'.
 12. THE CONTRACTOR SHALL VERIFY THAT THE EXISTING GROUND BARS HAVE ENOUGH SPACE/HOLES FOR ADDITIONAL TWO HOLE LUGS.
 13. EXOTHERMIC WELDING IS RECOMMENDED FOR GROUNDING CONNECTION WHERE PRACTICAL OTHERWISE. THE CONNECTION SHALL BE MADE USING COMPRESSION TYPE-2 HOLES, LONG BARREL LUGS OR DOUBLE CRIMP "C" CLAMP. THE COPPER CABLES SHALL BE COATED WITH AN ANTI-OXIDANT (THOMAS BETTS KOPR-SHILD) BEFORE MAKING THE CRIMP CONNECTIONS THE CONTRACTOR SHALL FOLLOW MANUFACTURER'S RECOMMENDED TORQUES ON THE BOLT ASSEMBLY TO SECURE CONNECTIONS.
 14. AT ALL TERMINATIONS AT EQUIPMENT ENCLOSURES, PANEL AND FRAMES OF EQUIPMENT AND WHERE EXPOSED FOR GROUNDING, CONDUCTOR TERMINATION SHALL BE PERFORMED UTILIZING TWO HOLE BOLTED TONGUE COMPRESSION TYPE LUGS WITH STAINLESS STEEL SELF-TAPPING SCREWS.
 15. THE MASTER GROUND BAR (MGB) SHALL BE MADE OF BARE 1/4"x2" COPPER (FOR OUTDOOR APPLICATIONS IT SHALL BE TINNED COPPER) AND LARGE ENOUGH TO ACCOMMODATE THE REQUIRED NUMBER OF GROUND CONNECTIONS. THE HARDWARE SECURING THE MGB SHALL ELECTRICAL INSULATE THE MGB FROM ANY STRUCTURE TO WHICH IT IS FASTENED.
 16. ALL BOLTS, WASHERS, AND NUTS USED ON GROUNDING CONNECTIONS SHALL BE STAINLESS STEEL.
 17. ALL GROUNDING CONNECTIONS SHALL BE COATED WITH A COPPER SHIELD ANTI-CORROSIVE AGENT SUCH AS T&B KOPR SHIELD. VERIFY PRODUCT WITH SPRINT CONSTRUCTION MANAGER.
 18. FOR NEW OR REPAIRED GROUNDING EQUIPMENT. REFER TO SPRINT GROUNDING STANDARDS AND FOLLOWING (SUPPLEMENTS):
-ANTI-THEFT UPDATE TO SPRINT GROUNDING DATED 08-24-12 (OR CURRENT VERSION)
-SPRINT ENGINEERING LETTER EL-0504 DATED 04-20-12 (OR CURRENT VERSION)

TYPICAL POWER AND GROUNDING ONE LINE DIAGRAMS
SCALE: N.T.S.

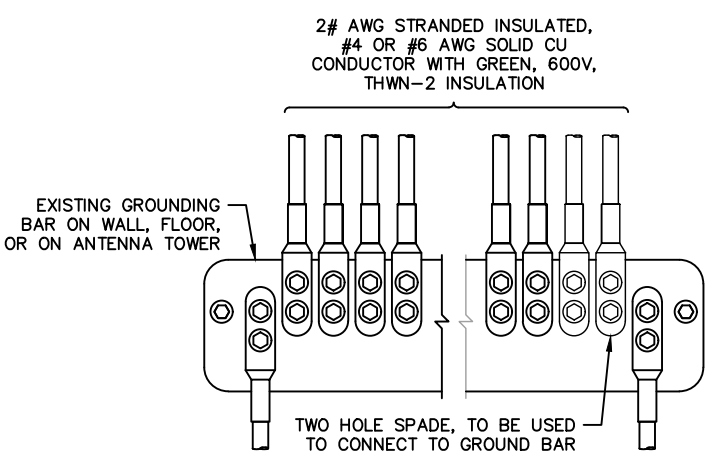
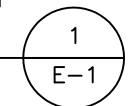

1. APPLY NO-OX TO LUG AND BAR CONTACT SURFACE. DO NOT COAT INLINE LUG.
 2. IF STOLEN GROUND BARS ARE ENCOUNTERED, CONTACT SPRINT CM FOR REPLACEMENT THREADED ROD KIT.
- INSTALLATION OF GROUNDING CONDUCTOR TO GROUNDING BAR**
SCALE: N.T.S.

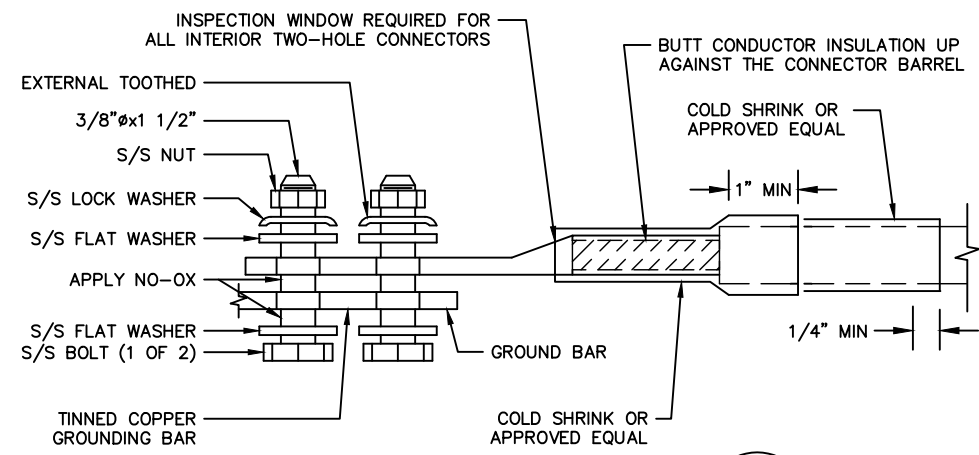
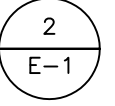

TWO HOLE LUG
SCALE: N.T.S.

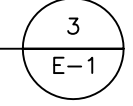

PLANS PREPARED FOR:

Sprint

1 INTERNATIONAL BLVD, SUITE 800
MAHWAH, NJ 07495
TEL: (800) 357-7641

PROJECT MANAGER:

SBA

SBA COMMUNICATIONS CORP.
134 FLANDERS ROAD, SUITE 125
WESTBOROUGH, MA 01581
TEL: (508) 251-0720

PLANS PREPARED BY:

INFINIGY

FROM ZERO TO INFINIGY
the solutions are endless

1033 Watervliet Shaker Rd | Albany, NY 12205
Phone: 518-690-0790 | Fax: 518-690-0793
www.infinigy.com
JOB NUMBER 526-104

ENGINEERING LICENSE:

STATE OF CONNECTICUT
CHRISTOPHER J. WARREN
No. 23544
4-10-18
PROFESSIONAL ENGINEER

CHECKED BY:

APPROVED BY:

REVISIONS:

DESCRIPTION	DATE	BY	REV.
ISSUED FOR CONSTRUCTION	04/10/18	RWF	0

SITE NUMBER:

CT33XC575

SITE ADDRESS:

31 CHESTNUT HILL ROAD
COLCHESTER, CT 06415

SHEET DESCRIPTION:

ELECTRICAL & GROUNDING DETAILS

SHEET NUMBER:

E-1



RF Design Sheet

Site Identification	
Cascade	CT33XC575
SMS Schedule ID	12323292
SMS Schedule Name	DO Macro Upgrade
PID	
RRU OEM	ALU
Switch OEM	Alcatel Lucent
RFDS Issue Date	2017-08-15 00:00:00.0
RFDS Revision Date	2017-10-20 10:13:40.0
RFDS Revision	3

Filter Analysis Complete	YES
RFDS - Issue Date	08/15/2017
Design Status	Complete
Project Description	DO Macro Upgrade - Add 800MHz (3G + 4G) and 2500 MHz

Contact Information	
Engineer Email	Bill.M.Hastings@sprint.com
Sprint Badged RF Engineer	Bill Hastings
RF Engineer Email	Bill.M.Hastings@sprint.com
RF Engineer Phone	978-590-9700
RF Manager	Jonathan Hull
RF Manager Email	Jonathan.B.Hull@sprint.com
RF Manager Phone	617-233-2920

Carrier Count	
2500 LTE	3
1900 LTE	1
1900 EVDO	
1900 Voice	1
800 LTE	1
800 Voice	1

Location Details	
Latitude	41.66445
Longitude	-71.84833
Market	Northern Connecticut
Region	Northeast
City	Sterling
State	CT
Zip Code	CT/06377
County	Windham

2500MHz	3
1900MHz	3
800MHz	3

Band: 2500	Alpha	Beta	Gamma	Delta	Epsilon	Zeta
Radio Model						
Model Number	TD-RRH8x20-25	TD-RRH8x20-25	TD-RRH8x20-25	N/A	N/A	N/A
Weight (lbs)	76.2	76.2	76.2	N/A	N/A	N/A
Dimensions	26 x 18.6 x 6.7	26 x 18.6 x 6.7	26 x 18.6 x 6.7	N/A	N/A	N/A
Manufacturer	ALU	ALU	ALU	N/A	N/A	N/A
Number of RRUs needed	1	1	1	0	0	0

Trunk Cable 1						
Model Number	Hybriflex	N/A	N/A	N/A	N/A	N/A
Weight (lbs)	1	N/A	N/A	N/A	N/A	N/A
Dimensions (in.)	1.54	N/A	N/A	N/A	N/A	N/A
Manufacturer	ALU	N/A	N/A	N/A	N/A	N/A

Band: 800	Alpha	Beta	Gamma	Delta	Epsilon	Zeta
Radio Model						
Model Number	RRH-2x50-800	RRH-2x50-800	RRH-2x50-800	N/A	N/A	N/A
Weight (lbs)	69.1	69.1	69.1	N/A	N/A	N/A
Dimensions	16 x 13 x 10	16 x 13 x 10	16 x 13 x 10	N/A	N/A	N/A
Manufacturer	ALU	ALU	ALU	N/A	N/A	N/A
Number of RRUs needed	2	2	2	0	0	0

Band: 2500	Alpha	Beta	Gamma	Delta	Epsilon	Zeta
Antenna1						
Model Number	APXVTM14-ALU-I20	APXVTM14-ALU-I20	APXVTM14-ALU-I20			
Weight (lbs)	56.2	56.2	56.2	N/A	N/A	N/A
Dimensions	56.3 x 12.6 x 6.3	56.3 x 12.6 x 6.3	56.3 x 12.6 x 6.3	N/A	N/A	N/A
Manufacturer	RFS	RFS	RFS	N/A	N/A	N/A
Ant1 Top Jumper Make/Mode/Qty	2.5 Jumper 8	2.5 Jumper 8	2.5 Jumper 8	N/A 0	N/A 0	N/A 0
Ant 1 RF requested Diameter	1/2"	1/2"	1/2"	N/A	N/A	N/A
Ant 1 RF requested Top Jumper Length(ft)	8	8	8	N/A	N/A	N/A
Antenna 1 Azimuth	0	120	240	N/A	N/A	N/A
Antenna 1 Mechanical DT	N/A	N/A	N/A	N/A	N/A	N/A
Antenna 1 Center Line (ft)	169.9803204	169.9803204	169.9803204	N/A	N/A	N/A
Antenna 1 Electrical DT	2	2	2	N/A	N/A	N/A
Antenna 1 Electrical DT 2	N/A	N/A	N/A	N/A	N/A	N/A
Antenna 1 Electrical DT 3	N/A	N/A	N/A	N/A	N/A	N/A
Antenna 1 Twist	N/A	N/A	N/A	N/A	N/A	N/A

Band: 2500	Alpha	Beta	Gamma	Delta	Epsilon	Zeta
Antenna1						
Model Number	APXVTM14-ALU-I20	APXVTM14-ALU-I20	APXVTM14-ALU-I20			
Weight (lbs)	56.2	56.2	56.2	N/A	N/A	N/A
Dimensions	56.3 x 12.6 x 6.3	56.3 x 12.6 x 6.3	56.3 x 12.6 x 6.3	N/A	N/A	N/A
Manufacturer	RFS	RFS	RFS	N/A	N/A	N/A
Ant1 Top Jumper Make/Mode/Qty	2.5 Jumper 8	2.5 Jumper 8	2.5 Jumper 8	N/A 0	N/A 0	N/A 0
Ant 1 RF requested Diameter	1/2"	1/2"	1/2"	N/A	N/A	N/A
Ant 1 RF requested Top Jumper Length(ft)	8	8	8	N/A	N/A	N/A
Antenna 1 Azimuth	0	120	240	N/A	N/A	N/A
Antenna 1 Mechanical DT	N/A	N/A	N/A	N/A	N/A	N/A
Antenna 1 Center Line (ft)	176.9685096	176.9685096	176.9685096	N/A	N/A	N/A
Antenna 1 Electrical DT	2	2	2	N/A	N/A	N/A
Antenna 1 Electrical DT 2	N/A	N/A	N/A	N/A	N/A	N/A
Antenna 1 Electrical DT 3	N/A	N/A	N/A	N/A	N/A	N/A
Antenna 1 Twist	N/A	N/A	N/A	N/A	N/A	N/A

Band: 1900	Alpha	Beta	Gamma	Delta	Epsilon	Zeta
Antenna1						
Model Number	NNVY-65B-R4	NNVY-65B-R4	NNVY-65B-R4			
Weight (lbs)	84.7	84.7	84.7	N/A	N/A	N/A
Dimensions	72 x 19.6 x 7.8	72 x 19.6 x 7.8	72 x 19.6 x 7.8	N/A	N/A	N/A
Manufacturer	CommScope	CommScope	CommScope	N/A	N/A	N/A
Ant1 Top Jumper Make/Mode/Qty	800/1900 Jumper 4	800/1900 Jumper 4	800/1900 Jumper 4	N/A 0	N/A 0	N/A 0
Ant 1 RF requested Diameter	1/2"	1/2"	1/2"	N/A	N/A	N/A
Ant 1 RF requested Top Jumper Length(ft)	8	8	8	N/A	N/A	N/A
Antenna 1 Azimuth	0	120	240	N/A	N/A	N/A
Antenna 1 Mechanical DT	N/A	N/A	N/A	N/A	N/A	N/A
Antenna 1 Center Line (ft)	176.9685096	176.9685096	176.9685096	N/A	N/A	N/A
Antenna 1 Electrical DT	3	3	3	N/A	N/A	N/A
Antenna 1 Electrical DT 2	N/A	N/A	N/A	N/A	N/A	N/A
Antenna 1 Electrical DT 3	N/A	N/A	N/A	N/A	N/A	N/A
Antenna 1 Twist	N/A	N/A	N/A	N/A	N/A	N/A

PLANS PREPARED FOR:
Sprint
 1 INTERNATIONAL BLVD, SUITE 800
 MAHWAH, NJ 07495
 TEL: (800) 357-7641

PROJECT MANAGER:
SBA
 SBA COMMUNICATIONS CORP.
 134 FLANDERS ROAD, SUITE 125
 WESTBOROUGH, MA 01581
 TEL: (508) 251-0720

PLANS PREPARED BY:
INFINIGY
 FROM ZERO TO INFINIGY
 the solutions are endless
 1033 Watervliet Shaker Rd | Albany, NY 12205
 Phone: 518-690-0790 | Fax: 518-690-0793
 www.infinigy.com
 JOB NUMBER 526-104

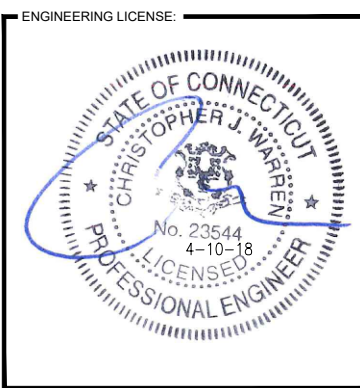

CHECKED BY:

APPROVED BY:

REVISIONS:	DESCRIPTION	DATE	BY	REV.
ISSUED FOR CONSTRUCTION		04/10/18	RWF	0

SITE NUMBER:
CT33XC575

SITE ADDRESS:
 31 CHESTNUT HILL ROAD
 COLCHESTER, CT 06415

SHEET DESCRIPTION:
RF DATA SHEET

SHEET NUMBER:
RF-1

ALU 211 APXVTM14-ALU-I20 & NNVV-65B-R4 wo Filters

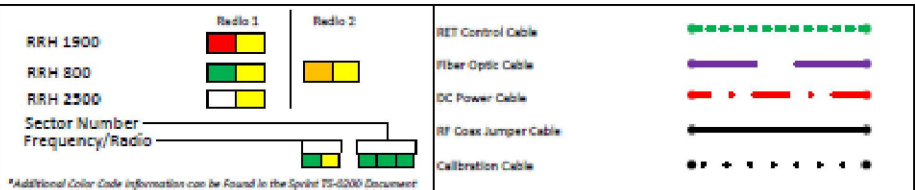
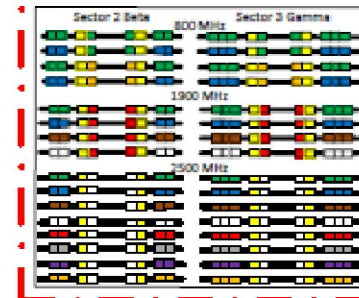
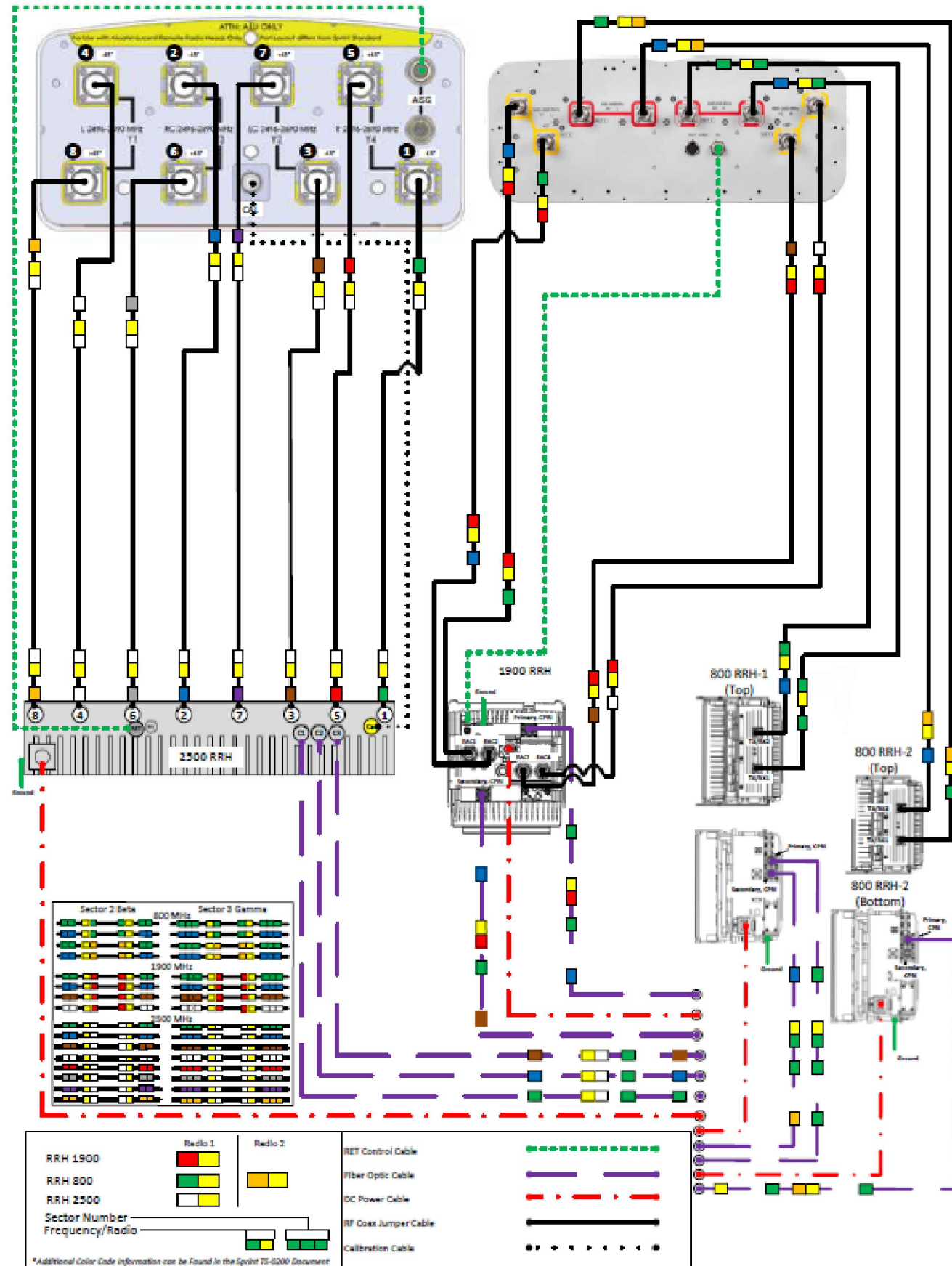

Not to Scale

PLUMBING DIAGRAM

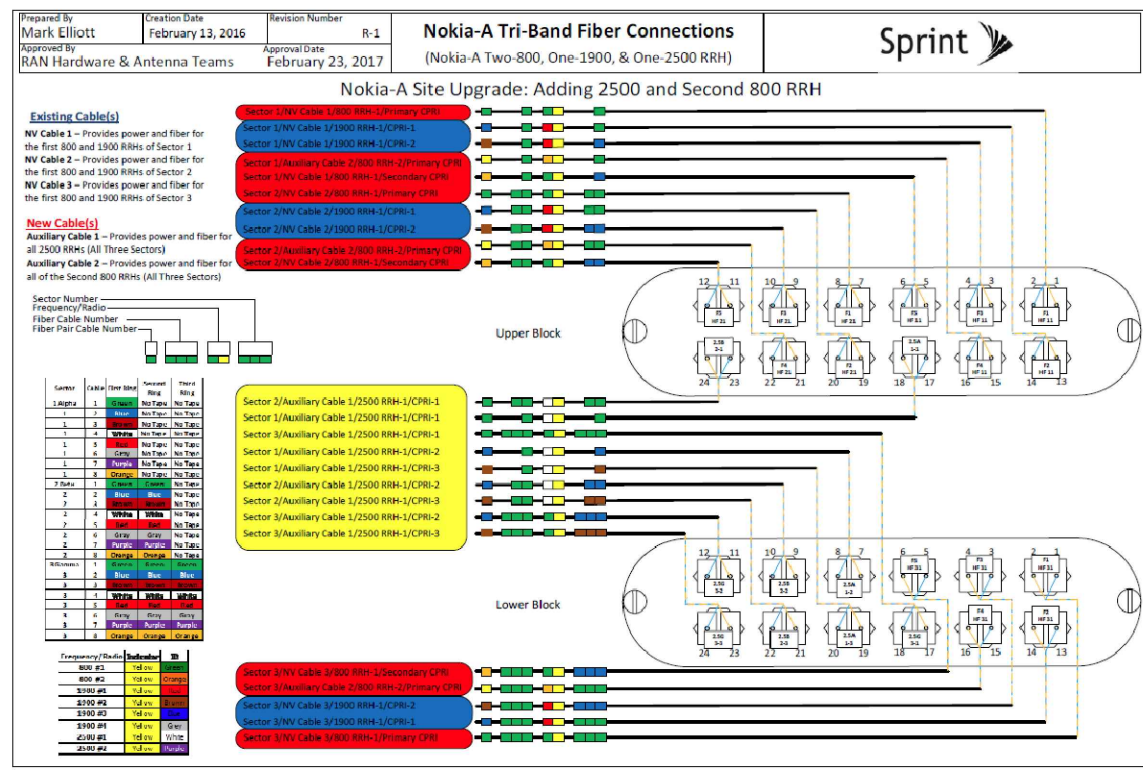

Prepared By: Mark Elliott, Approved By: RAN Hardware & Antenna Teams, Creation Date: February 13, 2016, Revision Number: R-1, Approval Date: February 23, 2017, Title: Nokia-A Tri-Band Fiber Connections (Nokia-A Two-800, One-1900, & One-2500 RRH)

PLANS PREPARED FOR:
Sprint
 1 INTERNATIONAL BLVD, SUITE 800
 MAHWAH, NJ 07495
 TEL: (800) 357-7641

PROJECT MANAGER:
SBA
 SBA COMMUNICATIONS CORP.
 134 FLANDERS ROAD, SUITE 125
 WESTBOROUGH, MA 01581
 TEL: (508) 251-0720

PLANS PREPARED BY:
INFINIGY
 FROM ZERO TO INFINIGY
 the solutions are endless
 1033 Watervliet Shaker Rd | Albany, NY 12205
 Phone: 518-690-0790 | Fax: 518-690-0793
 www.infinigy.com
 JOB NUMBER 526-104

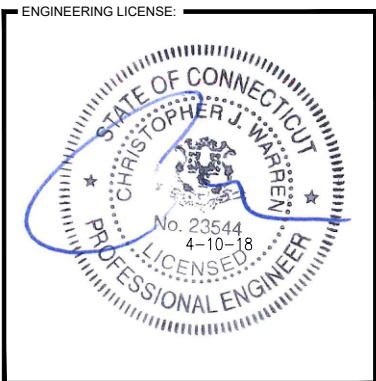

CHECKED BY:

APPROVED BY:

REVISIONS:	DESCRIPTION	DATE	BY	REV.
ISSUED FOR CONSTRUCTION		04/10/18	RWF	0

SITE NUMBER:
CT33XC575

SITE ADDRESS:
 31 CHESTNUT HILL ROAD
 COLCHESTER, CT 06415

SHEET DESCRIPTION:
PLUMBING DIAGRAM

SHEET NUMBER:
RF-2

CT33XC575

DO MACRO EQUIPMENT DEPLOYMENT

MOUNT AUGMENTATION @ 180'

MONOPOLE TOWER

COLCHESTER, CT
NEW LONDON COUNTY



REVISIONS:			
0	04/16/18	ISSUE FOR CONSTRUCTION	JAD

CHECKED BY: DWG

THE INFORMATION CONTAINED IN THIS SET OF DOCUMENTS IS PROPRIETARY BY NATURE. ANY USE OR DISCLOSURE OTHER THAN THAT WHICH RELATES TO THE CLIENT NAMES IS STRICTLY PROHIBITED.

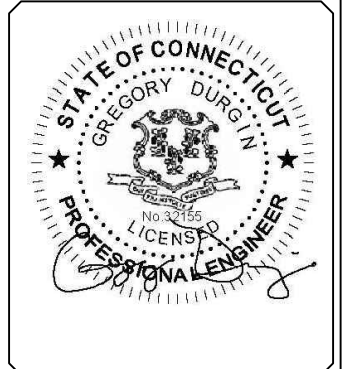

SITE INFORMATION:
MOUNT AUGMENTATION

CT33XC575

COLCHESTER, CT

LATITUDE: 41.571327
LONGITUDE: -72.302322

SHEET TITLE:

TITLE SHEET

SHEET NUMBER:

S1

SITE INFORMATION

STRUCTURE TYPE: MONOPOLE
MOUNT TYPE: PLATFORM
LATITUDE: 41.571327 (NAD 83)
LONGITUDE: -72.302322 (NAD 83)
CITY, STATE: COLCHESTER, CT
COUNTY: NEW LONDON
SBA SITE: CT02220-S Colchester 2 CT
COORDINATES ARE FOR NAVIGATIONAL PURPOSES ONLY, NOT TO 1A ACCURACY.

DO NOT SCALE DRAWINGS

CONTRACTOR SHALL VERIFY ALL PLANS, EXISTING DIMENSIONS, CONDITIONS ON THE JOB SITE & SHALL IMMEDIATELY NOTIFY THE ENGINEER IN WRITING OF ANY DISCREPANCIES BEFORE PROCEEDING WITH THE WORK OR BE RESPONSIBLE FOR THE LABOR & MATERIALS FOR THE DISCREPANCIES.

CODE COMPLIANCE

ALL WORK SHALL BE PERFORMED AND MATERIALS INSTALLED IN ACCORDANCE WITH THE CURRENT EDITIONS OF THE FOLLOWING CODES AS ADOPTED BY THE LOCAL GOVERNING AUTHORITIES.

BUILDING CODE AND DESIGN STANDARD: 2012 IBC / TIA-222-G / 2016 CT

RIGGING PLAN REQUIRED

THIS SET OF PLANS DOES "NOT" CONSTITUTE A RIGGING PLAN.

A PROPER RIGGING PLAN SHALL BE PERFORMED BY A LICENSED PROFESSIONAL ENGINEER PRIOR TO PROCEEDING ON ANY AUGMENTATIONS SHOWN HEREIN.

GENERAL DESIGN NOTES

- THIS PLAN HAS BEEN DESIGNED UTILIZING THE CORRESPONDING MOUNT STRUCTURAL ANALYSIS.
- THESE PLANS HAVE BEEN DESIGNED IN ACCORDANCE WITH THE GOVERNING PROVISIONS OF TIA/EIA-222, ASCE 7, AWS, ACI, AND AISC. MATERIALS AND SERVICES PROVIDED BY THE CONTRACTOR SHALL CONFORM TO THE ABOVE-MENTIONED CODES AND THE CONTRACT SPECIFICATIONS.
- ALL STRUCTURE INFORMATION OBTAINED IN THE FORM OF FROM INFORMATION PROVIDED BY THE CLIENT. CONTRACTOR SHALL OBTAIN AND BECOME FAMILIAR WITH THE REFERENCED DOCUMENTS. CONTRACTOR SHALL ISSUE A REQUEST FOR INFORMATION (RFI) IN THE EVENT ANY DISCREPANCIES ARE DISCOVERED BETWEEN THESE DOCUMENTS AND THE AS-BUILT CONDITIONS IN THE FIELD IN A SITE VISIT THAT SHALL BE PERFORMED PRIOR TO STARTING FABRICATION OR CONSTRUCTION.
- ALL MATERIALS UTILIZED FOR THIS PROJECT MUST BE NEW AND FREE OF ANY DEFECTS.
- ALL PRODUCT OR MATERIAL SUBSTITUTIONS PROPOSED BY THE CONTRACTOR SHALL BE APPROVED IN WRITING BY THE ENGINEER. CONTRACTOR SHALL PROVIDE DOCUMENTATION TO ENGINEER SUITABLE TO DETERMINE IF SUBSTITUTE IS ACCEPTABLE FOR USE AND MEETS THE ORIGINAL DESIGN CRITERIA. DIFFERENCES FROM THE ORIGINAL DESIGN, INCLUDING MAINTENANCE, REPAIR AND REPLACEMENT, SHALL BE NOTED. ESTIMATES OF COSTS/CREDITS ASSOCIATED WITH THE SUBSTITUTION (INCLUDING RE-DESIGN COSTS AND COSTS TO SUB-CONTRACTORS) SHALL BE PROVIDED TO THE ENGINEER. CONTRACTOR SHALL PROVIDE ADDITIONAL DOCUMENTATION AND/OR SPECIFICATIONS TO THE ENGINEER AS REQUESTED.
- PROVIDE STRUCTURAL STEEL SHOP DRAWING(S) TO THE ENGINEER OF RECORD FOR APPROVAL PRIOR TO FABRICATION (ONLY IF SPECIFICALLY REQUESTED BY ENGINEER).
- UNLESS NOTED OTHERWISE, ALL NEW MEMBERS AND REINFORCING SHALL MAINTAIN THE EXISTING MEMBER WORK LINES AND NOT INTRODUCE ECCENTRICITIES INTO THE STRUCTURE.
- ANY CONTRACTOR-CAUSED DAMAGE TO PROPERTY OF THE LAND OWNER, PROPERTY OF THE STRUCTURE OWNER, PROPERTY OF THE CUSTOMER, SITE FENCING OR GATES, ANY AND ALL UTILITY AND/OR SERVICE LINES, SHOWN OR NOT SHOWN ON THE PLANS, SHALL BE REPAIRED OR REPLACED AT THE SOLE COST OF THE CONTRACTOR AND SHALL BE ACCOMPLISHED BY THE CONTRACTOR OR SUBCONTRACTOR AS APPROVED BY THE ENGINEER OF RECORD AND LAND OWNER. DAMAGE TO EQUIPMENT OR PROPERTY OF ANY KIND BELONGING TO OTHER COMPANIES (BESIDES THE INDICATED CUSTOMER) SHALL BE ADDRESSED BY THE CONTRACTOR WITH THE COMPANIES THAT OWN THE DAMAGED ITEMS.

SHEET INDEX

SHEET	DESCRIPTION
S-1	TITLE SHEET
S-2	NOTES AND SPECIFICATIONS
S-3	AUGMENTATIONS, SECTIONS & DETAILS

MOUNT AUGMENTATION CONFIGURATION

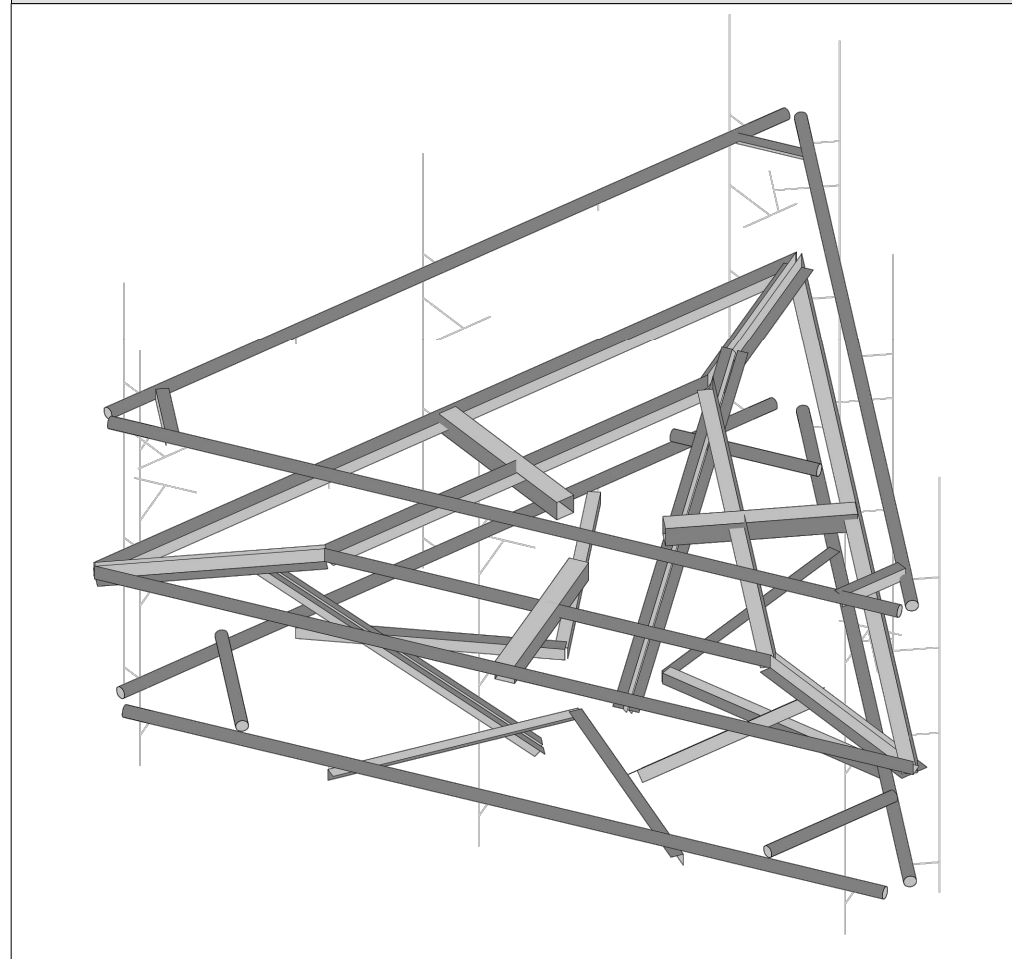

AUGMENTATION SCOPE

AUGMENT ALL SECTORS OF CARRIER'S EXISTING MOUNT INSTALLATION AS REQUIRED (UNLESS NOTED OTHERWISE)

CONTRACTOR NOTES

1. PRIOR TO BEGINNING CONSTRUCTION, ALL CONTRACTORS AND SUBCONTRACTORS MUST ACKNOWLEDGE IN WRITING TO TOWER OWNER THAT THEY HAVE OBTAINED, UNDERSTAND, AND WILL FOLLOW STRUCTURE OWNER STANDARDS OF PRACTICE, CONSTRUCTION GUIDELINES, ALL SITE AND STRUCTURE/TOWER SAFETY PROCEDURES, ALL PRODUCT LIMITATIONS AND INSTALLATION PROCEDURES USED ON SITE, AND PROPOSED AUGMENTATIONS DESCRIBED. RECEIPT OF ACKNOWLEDGEMENT MUST OCCUR PRIOR TO BEGINNING CONSTRUCTION OR CLIMBING. IT IS THE RESPONSIBILITY OF THE GENERAL CONTRACTOR TO PROVIDE THIS DOCUMENTATION FOR STRUCTURE OWNER ON COMPANY LETTERHEAD AND THE RESPONSIBILITY OF THE GENERAL CONTRACTOR TO OBTAIN THIS DOCUMENTATION FROM ANY SUBCONTRACTORS (ON SUBCONTRACTOR LETTERHEAD) AND DELIVER IT TO THE STRUCTURE OWNER.
2. IF THE CONTRACTOR DISCOVERS ANY EXISTING CONDITIONS THAT ARE NOT REPRESENTED ON THESE DRAWINGS, OR ANY CONDITIONS THAT WOULD INTERFERE WITH THE INSTALLATION OF THE AUGMENTATIONS, THE ENGINEER OF RECORD SHALL BE CONTACTED IMMEDIATELY TO EVALUATE THE SIGNIFICANCE OF THE DEVIATION.
3. THE CONTRACTOR SHALL SOLICIT AND HIRE THE SERVICES OF A QUALIFIED AUGMENTATION INSPECTOR PRIOR TO BEGINNING CONSTRUCTION. THE AUGMENTATION INSPECTOR MAY BE AN EMPLOYEE OF THE CONTRACTOR'S FIRM, HOWEVER THE INSPECTOR'S ONLY DUTIES SHALL BE INSPECTION, TESTING, AND REPORT CREATION AS REQUIRED ON THE "AUGMENTATION INSPECTION NOTES" SHEET.
4. THE CONTRACTOR SHALL NOTIFY THE TOWER OWNER OF THE PLANNED CONSTRUCTION & INSPECTION SCHEDULE, AS WELL AS ANY CHANGES TO THE SCHEDULE, WITHIN TWO BUSINESS DAYS OF THE COMPLETION OF THE SCHEDULE OR SCHEDULE REVISION BOTH PRIOR TO BEGINNING CONSTRUCTION AND DURING CONSTRUCTION AS THE SCHEDULE CHANGES. THE STRUCTURE OWNER WHEN THE WORK HAS BEEN COMPLETED WITHIN 2 BUSINESS DAYS OF THE COMPLETION OF THE WORK AND ASSOCIATED AUGMENTATION INSPECTIONS & TESTING (WHEN APPLICABLE).
5. IT IS ASSUMED THAT ANY STRUCTURAL AUGMENTATION WORK SPECIFIED ON THESE PLANS WILL BE ACCOMPLISHED BY KNOWLEDGEABLE WORKMEN WITH TOWER CONSTRUCTION EXPERIENCE. THIS INCLUDES PROVIDING THE NECESSARY CERTIFICATIONS TO THE STRUCTURE OWNER AND ENGINEER INCLUDING BUT NOT LIMITED TO TOWER CLIMBER AND RESCUE CLIMBER CERTIFICATIONS, ET CETERA.
6. THESE DRAWINGS DO NOT INDICATE THE METHOD OF CONSTRUCTION. THE CONTRACTOR SHALL SUPERVISE AND DIRECT THE WORK AND SHALL BE SOLELY RESPONSIBLE FOR ALL CONSTRUCTION METHODS, MEANS, TECHNIQUES, SEQUENCES AND PROCEDURES.
7. CONTRACTOR SHALL WORK WITHIN THE LIMITS OF THE STRUCTURE OWNER'S PROPERTY OR LEASE AREA AND APPROVED EASEMENTS. IT IS THE RESPONSIBILITY OF THE CONTRACTOR TO VERIFY WORK IS WITHIN THESE BOUNDARIES. CONTRACTOR SHALL EMPLOY A SURVEYOR AS REQUIRED. ANY WORK OUTSIDE THESE BOUNDARIES SHALL BE APPROVED IN WRITING BY THE LAND OWNER PRIOR TO MOBILIZATION. CONSTRUCTION STAKING AND BOUNDARY MARKING IS THE RESPONSIBILITY OF THE CONTRACTOR.

STRUCTURAL ERECTION AND BRACING REQUIREMENTS

1. THE STRUCTURAL DRAWINGS ILLUSTRATE THE COMPLETED STRUCTURE WITH ALL ELEMENTS IN THEIR FINAL POSITIONS, PROPERLY SUPPORTED AND BRACED.
2. THE CONTRACTOR SHALL PROVIDE SHORING AND BRACING AS REQUIRED DURING CONSTRUCTION TO ENSURE STABILITY. DESIGN AND SEQUENCING OF CONSTRUCTION SHORING AND BRACING IS OUTSIDE THE SCOPE OF THIS WORK.
3. THE CONTRACTOR IS RESPONSIBLE FOR THE DESIGN AND EXECUTION OF ALL MISCELLANEOUS SHORING, BRACING, TEMPORARY SUPPORTS, GUYING, ETC. NECESSARY TO PROVIDE A COMPLETE AND STABLE STRUCTURE AS SHOWN ON THESE DRAWINGS.

BOLTS

1. ALL CONNECTIONS OF STRUCTURAL STEEL MEMBERS SHALL BE MADE USING SPECIFIED GALVANIZED HIGH STRENGTH ASTM A325 OR A490 BOLTS WITH THREADS EXCLUDED FROM SHEAR PLANE.
2. FASTENERS SHALL BE INSTALLED IN PROPERLY ALIGNED HOLES, WITH BOLT HEADS FACING DOWN WHERE APPLICABLE.
3. ALL BOLTS AT EVERY CONNECTION SHALL BE INSTALLED SNUG-TIGHT UNTIL THE SECTION IS FULLY COMPACTED AND ALL PLIES ARE JOINED, AND THEN TIGHTENED FURTHER BY AISC - "TURN OF THE NUT" METHOD. TIGHTENING SHALL PROGRESS SYSTEMATICALLY.
4. BOLT LENGTHS UP TO AND INCLUDING 4 DIAMETERS SHALL BE TENSIONED 1/3 TURN BEYOND SNUG-TIGHT. BOLT LENGTHS OVER 4 DIAMETERS SHALL BE 1 1/2 TURNS BEYOND SNUG-TIGHT.
5. ALL BOLTED CONNECTIONS SHALL USE LOCK WASHERS.

STRUCTURAL STEEL

1. STRUCTURAL STEEL SHALL BE DETAILED, FABRICATED, AND ERECTED IN ACCORDANCE WITH THE CURRENT EDITION OF THE AISC STEEL CONSTRUCTION MANUAL AND SECTION 4 OF THE TIA CODE.
2. PRE-QUALIFIED STRUCTURAL STEEL SHALL CONFORM TO THE FOLLOWING MINIMUM GRADES UNLESS OTHERWISE NOTED:
 - CHANNELS & ANGLES ASTM A36, (Fy = 36 KSI)
 - PLATES ASTM A36, (Fy = 36 KSI)
 - PIPES ASTM A53 GR.B, (Fy = 35 KSI)
 - HSS ROUND ASTM A500 GR.B, (Fy = 42 KSI)
 - HSS RECTANGULAR ASTM A500 GR.B, (Fy = 46 KSI)
 - STRUCTURAL BOLTS ASTM A325
 - U-BOLTS ASTM A307 GR.A
 - NUTS FOR BOLTS ASTM A563 (THREADING TO MATCH BOLT)
 - WASHERS FOR BOLTS ASTM F436
 - SEE TABLE 5-1 OF THE TIA CODE FOR ADDITIONAL SHAPES AND STANDARDS THAT ARE NOT LISTED ABOVE.
3. NON PRE-QUALIFIED STRUCTURAL STEEL SHALL CONFORM TO THE FOLLOWING STANDARDS PER THE TIA CODE:
 - THE CARBON EQUIVALENT OF STEEL SHALL NOT EXCEED 0.65 PER SECTION 5.4.2 OF THE TIA CODE
 - ELONGATION OF STEEL SHALL NOT BE LESS THAN 18%
 - TEST REPORTS SHALL BE IN ACCORDANCE WITH ASTM A6 OR A568
 - TOLERANCES SHALL BE IN ACCORDANCE WITH ASTM A6
4. FIELD CUT EDGES, EXCEPT DRILLED HOLES, SHALL BE GROUND SMOOTH AND COLD GALVANIZED.
5. ALL WELDING WORK SHALL CONFORM TO THE AWS D1.1 STRUCTURAL WELDING CODE. ALL WELDING SHALL BE PERFORMED BY CERTIFIED WELDERS ONLY. WELDING ELECTRODES SHALL BE E70XX.
6. ALL DETAILING, FABRICATION AND ERECTION OF STRUCTURAL STEEL SHALL CONFORM TO AISC SPECS AND CODES, LATEST EDITION.
7. UPON REQUEST, THE CONTRACTOR SHALL SUBMIT DETAILED, ENGINEERED, COORDINATED AND CHECKED SHOP DRAWINGS FOR ALL STRUCTURAL STEEL TO THE ENGINEER OF RECORD TO REVIEW FOR COMPLIANCE WITH DESIGN INTENT PRIOR TO THE START OF FABRICATION AND/OR ERECTION.
8. TORCH-CUTTING OF ANY KIND SHALL NOT BE PERMITTED.
9. ALL BOLT HOLES SHALL BE STANDARD SIZE BOLT HOLES PER AISC 360, UNLESS OTHERWISE NOTED. ALL HOLES SHALL BE SHOP DRILLED OR SUB-PUNCHED AND REAMED. BURNING OF HOLES IS NOT PERMITTED. WHERE SLOTTED OR OVERSIZE HOLES ARE SPECIFIED ON THE DRAWINGS, EXTRA-THICK ASTM F436 PLATE WASHERS SHALL BE USED (3/16" MINIMUM THICKNESS) WITH A DIAMETER SUITABLE TO COVER THE EXTENTS OF THE SLOT OR HOLE. BOLTS SHALL BE HEAVY-HEX WHERE AVAILABLE IN THE SIZE AND GRADE SPECIFIED, OTHERWISE BOLTS SHALL BE HEX HEAD CAP SCREWS.
10. ALL STEEL HARDWARE, INCLUDING ADHESIVE OR EMBEDDED ANCHOR BOLTS AND THEIR ACCESSORIES, SHALL BE HOT-DIP GALVANIZED IN ACCORDANCE WITH ASTM A153 (EXCEPT BOLTS SMALLER THAN 1/2" SHALL CONFORM TO FE/ZN 3 AT PER ASTM F1941 WHERE HOT-DIP GALVANIZED BOLTS ARE NOT AVAILABLE). ALL STEEL MEMBERS, INCLUDING WELDMENTS, SHALL BE HOT-DIP GALVANIZED IN ACCORDANCE WITH ASTM A123. REPAIR DAMAGE TO GALVANIZED COATINGS USING ASTM A780 PROCEDURES WITH A ZINC RICH PAINT (SUCH AS ZINC GALVILITE) FOR GALVANIZING DAMAGED BY HANDLING, TRANSPORTING, CUTTING, WELDING, OR BOLTING. DO NOT HEAT SURFACES TO WHICH REPAIR PAINT HAS BEEN APPLIED. CALL OUT HOLES REQUIRED FOR HOT-DIP GALVANIZING ON SHOP DRAWINGS.
11. MEMBERS SHALL BE SHOP-FABRICATED AND WELDED TO THE EXTENT PRACTICABLE IN ORDER TO REDUCE FIELD INSTALLATION COSTS.

CONSTRUCTION INSPECTION CHECKLIST

CONSTRUCTION AND/OR INSTALLATION INSPECTIONS REQUIRED FOR REPORT? (CHECK=YES, BLANK=NO)	INSPECTION REPORT ITEM
√	CONSTRUCTION INSPECTIONS
	THIRD-PARTY CERTIFIED WELD INSPECTION (INCLUDING IBC SPECIAL INSPECTIONS)
√	GALVANIZING REPAIR MATERIAL PREPARATION, INSPECTION, & PAINT APPLICATION
√	PRIME CONTRACTOR'S AS-BUILT DOCUMENTS (SIGNED & DATED)
√	FABRICATION INSPECTION
√	MATERIAL TEST REPORT(S) / MILL CERTIFICATE(S)
√	PACKING SLIPS FOR STRUCTURAL MATERIALS

NOMINAL HOLE DIMENSIONS

BOLT Ø	STANDARD HOLE Ø
1/2"Ø	9/16"Ø
5/8"Ø	11/16"Ø
3/4"Ø	13/16"Ø
7/8"Ø	15/16"Ø
1"Ø	1 1/8"Ø



REVISIONS:

NO.	DATE	DESCRIPTION	BY
0	04/16/18	ISSUE FOR CONSTRUCTION	JAD

CHECKED BY: DWG

THE INFORMATION CONTAINED IN THIS SET OF DOCUMENTS IS PROPRIETARY BY NATURE. ANY USE OR DISCLOSURE OTHER THAN THAT WHICH RELATES TO THE CLIENT NAMES IS STRICTLY PROHIBITED.

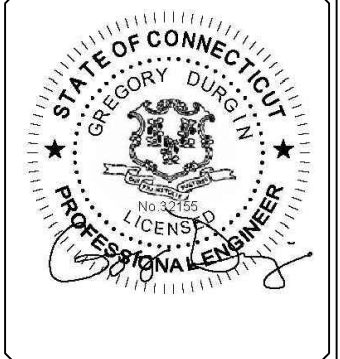

SITE INFORMATION:
MOUNT AUGMENTATION
 CT33XC575
 COLCHESTER, CT
 LATITUDE: 41.571327
 LONGITUDE: -72.302322

SHEET TITLE:
NOTES AND SPECIFICATIONS

SHEET NUMBER:
S2

NEW MOUNT AUGMENTATIONS

- 1 PLATFORM REINFORCEMENT KIT
SITEPRO1 PART# PRK-1245L. ATTACH PRK COLLAR TO MONOPOLE SHAFT ~4.0' BELOW EXISTING STANDOFF CENTERLINE AND DOUBLE ANGLE KICKER BRACKET TO BACK-TO-BACK ANGLES AT PLATFORM CORNERS AS SHOWN PER MANUF. SPECS. [(1) KIT TOTAL]
- 2 HANDRAIL KIT COMPONENTS
SITEPRO1 PART# HRK12-U OR HRK14-U. ATTACH TO MOUNT PIPES ~3.0' ABOVE EXISTING STANDOFF CENTERLINE. VERIFY MOUNT FACE WIDTH IN FIELD PRIOR TO ORDERING. [(1) KIT TOTAL]
- 3 HANDRAIL KIT COMPONENTS - V-BRACE KIT
SITEPRO1 PART# PRK-SFS-H-L. ATTACH COLLAR MOUNT TO MONOPOLE SHAFT ~2.5' BELOW EXISTING STANDOFF CENTERLINE. NOTE: IF THE PRK-SFS-H-L KIT IS NOT AVAILABLE, PROVIDE (6) TOTAL L2½x2½x¼x 8' LONG REPLACEMENT ANGLES, FIELD-CUT AND DRILL TO SUIT. [(1) KIT TOTAL]
- 4 HANDRAIL KIT COMPONENTS - BOTTOM FACE RAIL
• PIPE2.0STD X 14.0' HORIZ. RAIL, [(3) TOTAL]. ATTACH SFS-H-L KIT ANGLES TO NEW HORIZ. RAIL.
• PIPE2.0STD X 4' LONG CORNER BRACE, [(3) TOTAL]. ATTACH TO NEW HORIZ. RAIL W/ (6) SITEPRO1 PART# PUCK BRACKETS.
• PIPE2.0STD X 8.0' MOUNT PIPES, [(12) TOTAL] W/ SITEPRO1 SCX-x-k, [(12) TOTAL] CROSS-OVER PLATES. ATTACH ALL MOUNT PIPES TO EXISTING AND NEW HORIZ. RAILS.
• 1/2"Ø OR 5/8"Ø U-BOLTS, (24) TOTAL. ATTACH ALL MOUNT PIPES TO EXISTING BOTTOM RAIL W/ (2) U-BOLTS.
- 5 PANEL ANTENNAS TO BE INSTALLED IN POSITIONS 1 AND 3 (AS CLOSE TO THE CENTER OF FACE NEAR EXISTING STANDOFF AS POSSIBLE. RRH UNITS TO BE INSTALLED ON DUAL SWIVEL BRACKETS BEHIND PANEL ANTENNAS IN POSITIONS 1 AND 3.

AUGMENTATIONS SHALL BE COMPLETED PRIOR TO THE INSTALLATION OF ANY NEW EQUIPMENT.

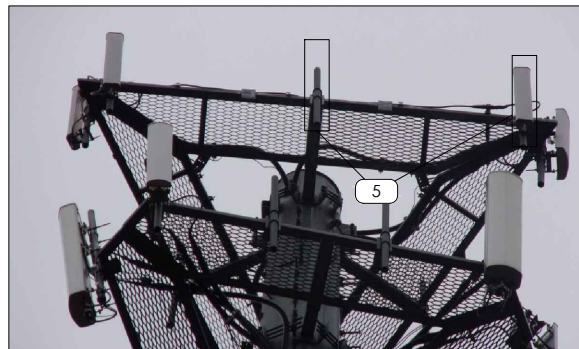

PLATFORM @ 180' AUGMENTATION

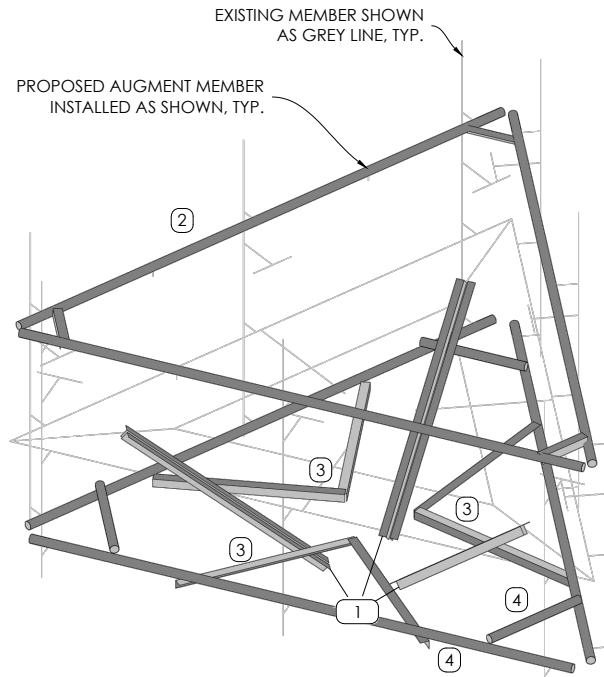

MOUNT AUGMENTATION ISOLATION
SCALE: N.T.S.

CONSTRUCTION NOTES

1. SCOPE OF WORK MUST BE COMPLETED AT WIND SPEEDS < 20 MPH.
2. ALL DIMENSIONS ARE APPROXIMATE. CONTRACTOR SHOULD FIELD-VERIFY ALL DIMENSIONS BEFORE FABRICATION OF STEEL AND COMMENCEMENT OF WORK. FIELD CUT MEMBERS AS REQUIRED.
3. CONTRACTOR TO COORDINATE THE TEMPORARY REMOVAL/RELOCATION/REPLACEMENT OF ELEMENTS (E.G. COAX, CLIPS, TMAs, ETC.) CONNECTED TO, OR IN THE DIRECT PATH, OF NEW AUGMENTATION MEMBERS.

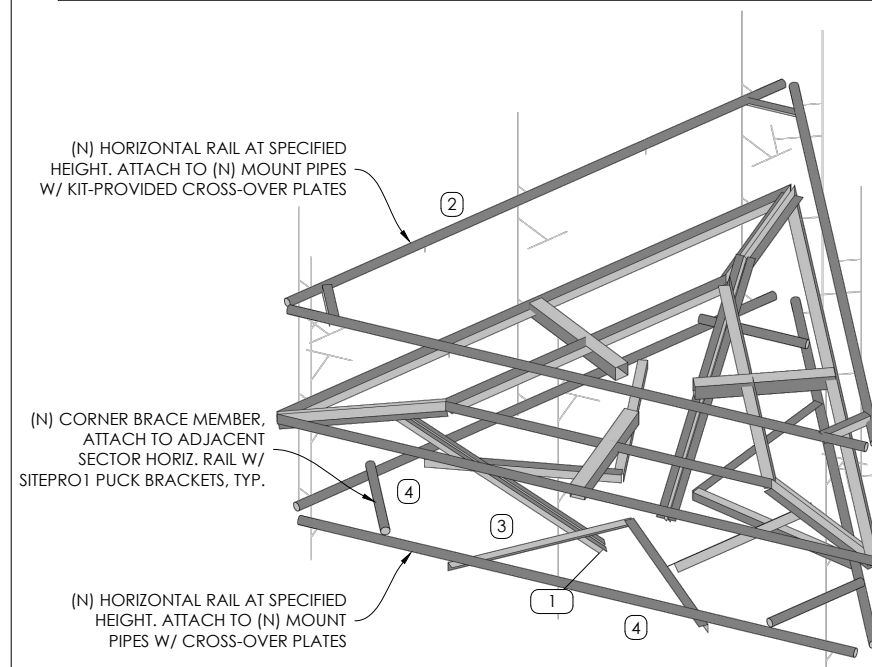

AUGMENTED MOUNT ISOMETRIC
SCALE: N.T.S.

INSTALLATION NOTES

1. AUGMENT MEMBER(S) MAY NEED TO BE FIELD-CUT TO LENGTH TO ACCOMMODATE THIS INSTALLATION. CONTRACTOR TO CUT AND DRILL TO SUIT AS REQUIRED AND APPLY (2) COATS OF COLD-GALV. COMPOUND TO CUT MEMBER ENDS.
2. CONTRACTOR TO CHECK ALL EXISTING MEMBER CONNECTION BOLTS, PARTICULARLY STANDOFF TO TOWER BOLTS, FOR PROPER INSTALLATION AND TIGHTNESS.
3. COORDINATE PLACEMENT OF NEW AUGMENT MEMBERS WITH EXISTING TOWER AND CLIMBING FACILITY ELEMENTS (E.G. STEP PEGS, COAX PORTS, ETC.)
4. REFER TO CONSTRUCTION DRAWINGS (BY OTHERS) AND MOUNT STRUCTURAL ANALYSIS FOR APPROVED INSTALLATION LOCATIONS AND QUANTITIES OF APPURTENANCES.

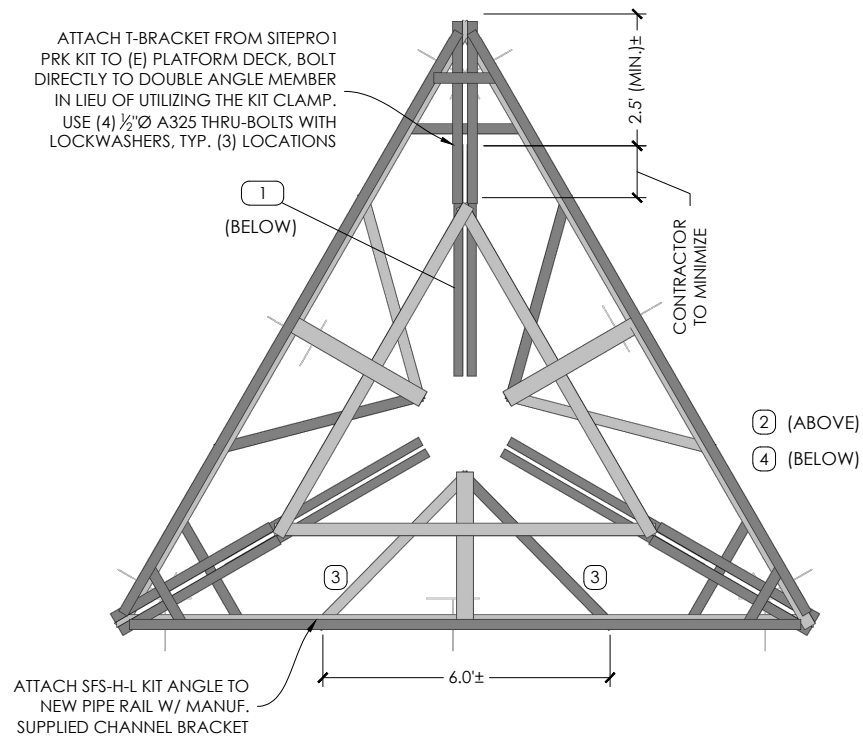

AUGMENTED MOUNT PLAN
SCALE: N.T.S.

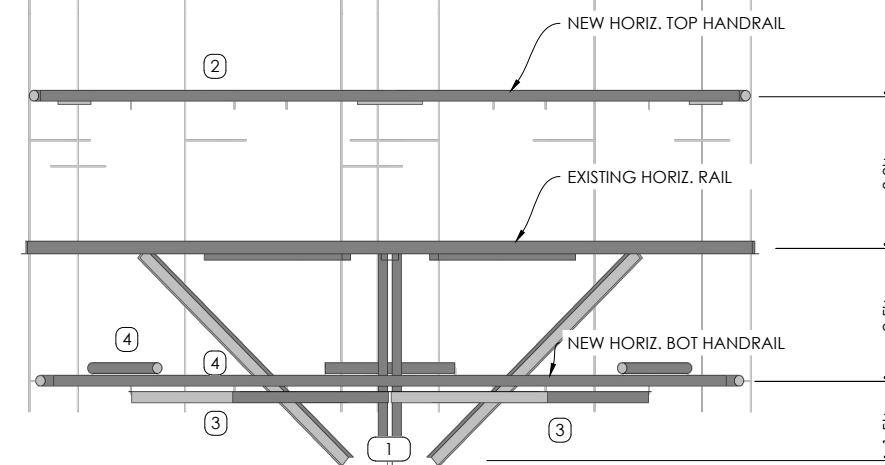

AUGMENTED MOUNT FRONT ELEVATION
SCALE: N.T.S.



134 FLANDERS RD., SUITE 125
WESTBOROUGH, MA 01581
P: 508.251.0720



REVISIONS:			
NO.	DATE	DESCRIPTION	BY
0	04/16/18	ISSUE FOR CONSTRUCTION	JAD

CHECKED BY: DWG

THE INFORMATION CONTAINED IN THIS SET OF DOCUMENTS IS PROPRIETARY BY NATURE. ANY USE OR DISCLOSURE OTHER THAN THAT WHICH RELATES TO THE CLIENT NAMES IS STRICTLY PROHIBITED.

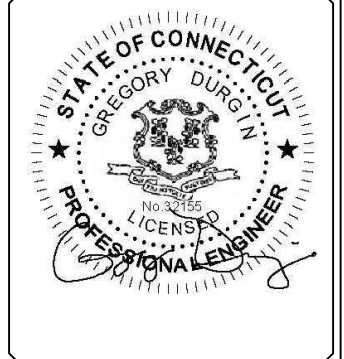

SITE INFORMATION:
MOUNT AUGMENTATION
CT33XC575
COLCHESTER, CT
LATITUDE: 41.571327
LONGITUDE: -72.302322

SHEET TITLE:
AUGMENTATIONS,
SECTIONS &
DETAILS

SHEET NUMBER:
S3