

280 Trumbull Street  
Hartford, CT 06103-3597  
Main (860) 275-8200  
Fax (860) 275-8299  
kbaldwin@rc.com  
Direct (860) 275-8345

Also admitted in Massachusetts

June 19, 2014

Melanie A. Bachman  
Acting Executive Director  
Connecticut Siting Council  
10 Franklin Square  
New Britain, CT 06051

Re: **Notice of Exempt Modification – Facility Modification  
1119 Summit Road, Cheshire, Connecticut**

Dear Ms. Bachman:

Cellco Partnership d/b/a Verizon Wireless (“Cellco”) currently maintains twelve (12) wireless telecommunications antennas at the top of the existing 167-foot tower at 1119 Summit Road in Cheshire, Connecticut (the “Property”). The tower is owned by Crown Castle. Cellco’s use of the tower was approved by the Council in 2001 (Docket No. 199). Cellco now intends to modify its facility by adding three (3) model BXA-171063-8CF, 2100 MHz antennas, for a total of fifteen (15) antennas, all at the same level on the tower. Cellco also intends to install three (3) remote radio heads (“RRHs”) behind its new 2100 MHz antennas and one (1) HYBRIFLEX™ antenna cable attached to the outside of the monopole. Included in Attachment 1 are specifications for Cellco’s new antennas, RRHs and HYBRIFLEX™ cable.

Please accept this letter as notification pursuant to R.C.S.A. § 16-50j-73, for construction that constitutes an exempt modification pursuant to R.C.S.A. § 16-50j-72(b)(2). In accordance with R.C.S.A. § 16-50j-73, a copy of this letter is being sent to Michael A. Milone, Town Manager of the Town of Cheshire. A copy of this letter is also being sent to Thomas and Joanne M. DiDomizio, the owners of the Property.

The planned modifications to the facility fall squarely within those activities explicitly provided for in R.C.S.A. § 16-50j-72(b)(2).



*Law Offices*

BOSTON

HARTFORD

NEW YORK

PROVIDENCE

STAMFORD

ALBANY

LOS ANGELES

NEW LONDON

SARASOTA

*www.rc.com*

12979394-v1

# ROBINSON & COLE<sup>LLP</sup>

Melanie A. Bachman  
June 19, 2014  
Page 2

1. The proposed modifications will not result in an increase in the height of the existing tower. Cellco's new antennas and RRHs will be installed at the top of the existing 167-foot tower.

2. The proposed modifications will not involve any change to ground-mounted equipment and, therefore, will not require the extension of the site boundary.

3. The proposed modifications will not increase noise levels at the facility by six decibels or more, or to levels that exceed state and local criteria.

4. The operation of the replacement antennas will not increase radio frequency (RF) emissions at the facility to a level at or above the Federal Communications Commission (FCC) safety standard. A cumulative General Power Density table for Cellco's modified facility is included in Attachment 2.

5. The proposed modifications will not cause a change or alteration in the physical or environmental characteristics of the site.

6. The tower and its foundation can support Cellco's proposed modifications. (See Structural Analysis Report included in Attachment 3).

For the foregoing reasons, Cellco respectfully submits that the proposed modifications to the above-referenced telecommunications facility constitutes an exempt modification under R.C.S.A. § 16-50j-72(b)(2).

Sincerely,

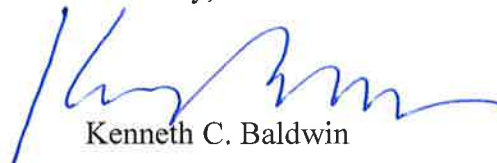

Kenneth C. Baldwin

Enclosures

Copy to:

Michael A. Milone, Cheshire Town Manager  
Thomas and Joanne M. DiDomizio  
Sandy M. Carter



# **ATTACHMENT 1**

## BXA-171063-8CF-EDIN-X

X-Pol | FET Panel | 63° | 17.4 dBi

Replace "X" with desired electrical downtilt.

Antenna is also available with NE connector(s). Replace "EDIN" with "NE" in the model number when ordering.

Electrical Characteristics		1710-2170 MHz			
Frequency bands	1710-1880 MHz	1850-1990 MHz	1920-2170 MHz		
Polarization	±45°	±45°	±45°		
Horizontal beamwidth	68°	65°	60°		
Vertical beamwidth	7°	7°	7°		
Gain	14.5 dBd / 16.6 dBi	14.9 dBd / 17.0 dBi	15.3 dBd / 17.4 dBi		
Electrical downtilt (X)	0, 2, 4, 6, 8				
Impedance	50Ω				
VSWR	≤1.5:1				
First upper sidelobe	< -17 dB				
Front-to-back ratio	> 30 dB				
In-band isolation	> 25 dB				
IM3 (20W carrier)	< -150 dBc				
Input power	300 W				
Lightning protection	Direct Ground				
Connector(s)	2 Ports / EDIN or NE / Female / Center (Back)				
Operating temperature	-40° to +60° C / -40° to +140° F				
Mechanical Characteristics					
Dimensions Length x Width x Depth	1225 x 154 x 105 mm	48.2 x 6.1 x 4.1 in			
Depth with t-brackets	133 mm	5.2 in			
Weight without mounting brackets	4.2 kg	9.2 lbs			
Survival wind speed	296 km/hr	184 mph			
Wind area	Front: 0.19 m <sup>2</sup> Side: 0.14 m <sup>2</sup>	Front: 2.0 ft <sup>2</sup> Side: 1.5 ft <sup>2</sup>			
Wind load @ 161 km/hr (100 mph)	Front: 281 N Side: 223 N	Front: 63 lbf Side: 50 lbf			
Mounting Options		Part Number	Fits Pipe Diameter	Weight	
2-Point Mounting Bracket Kit		26799997	50-102 mm 2.0-4.0 in	2.3 kg	5 lbs
2-Point Mounting & Downtilt Bracket Kit		26799999	50-102 mm 2.0-4.0 in	3.6 kg	8 lbs
Concealment Configurations		For concealment configurations, order BXA-171063-8CF-EDIN-X-FP			



**BXA-171063-8CF-EDIN-X**

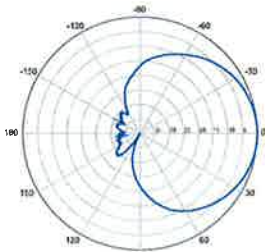

Horizontal | 1710-1880 MHz  
**BXA-171063-8CF-EDIN-0**

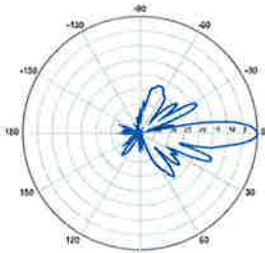

0° | Vertical | 1710-1880 MHz

**BXA-171063-8CF-EDIN-X**

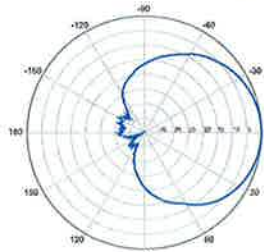

Horizontal | 1850-1990 MHz  
**BXA-171063-8CF-EDIN-0**

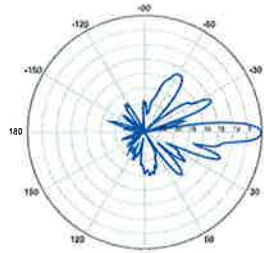

0° | Vertical | 1850-1990 MHz

**BXA-171063-8CF-EDIN-X**

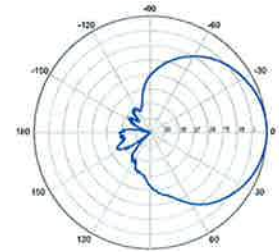

Horizontal | 1920-2170 MHz  
**BXA-171063-8CF-EDIN-0**

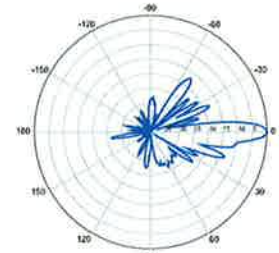

0° | Vertical | 1920-2170 MHz

Quoted performance parameters are provided to offer typical or range values only and may vary as a result of normal manufacturing and operational conditions. Extreme operational conditions and/or stress on structural supports is beyond our control. Such conditions may result in damage to this product. Improvements to product may be made without notice.

## BXA-171063-8CF-EDIN-X

X-Pol | FET Panel | 63° | 17.4 dBi

**BXA-171063-8CF-EDIN-2**

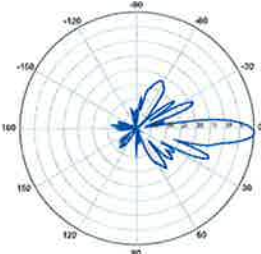

2° | Vertical | 1710-1880 MHz

**BXA-171063-8CF-EDIN-4**

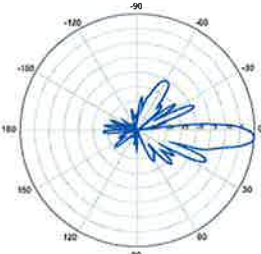

4° | Vertical | 1710-1880 MHz

**BXA-171063-8CF-EDIN-6**

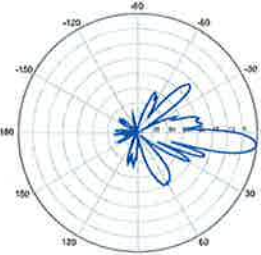

6° | Vertical | 1710-1880 MHz

**BXA-171063-8CF-EDIN-8**

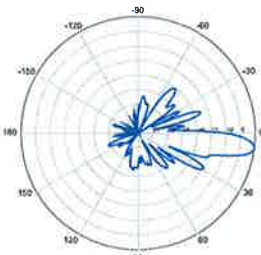

8° | Vertical | 1710-1880 MHz

**BXA-171063-8CF-EDIN-2**

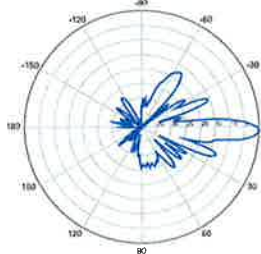

2° | Vertical | 1850-1990 MHz

**BXA-171063-8CF-EDIN-4**

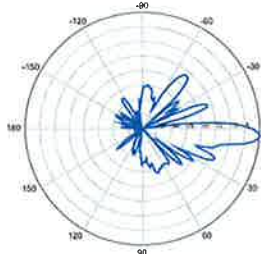

4° | Vertical | 1850-1990 MHz

**BXA-171063-8CF-EDIN-6**

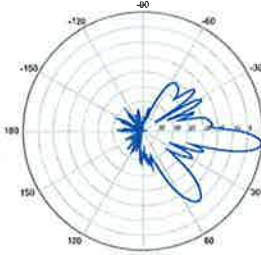

6° | Vertical | 1850-1990 MHz

**BXA-171063-8CF-EDIN-8**

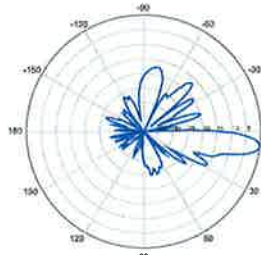

8° | Vertical | 1850-1990 MHz

**BXA-171063-8CF-EDIN-2**

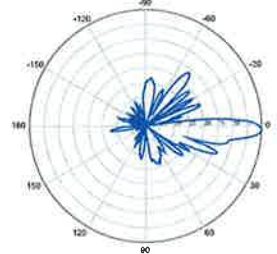

2° | Vertical | 1920-2170 MHz

**BXA-171063-8CF-EDIN-4**

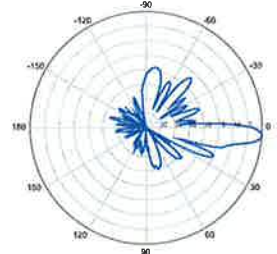

4° | Vertical | 1920-2170 MHz

**BXA-171063-8CF-EDIN-6**

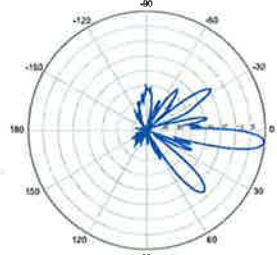

6° | Vertical | 1920-2170 MHz

**BXA-171063-8CF-EDIN-8**

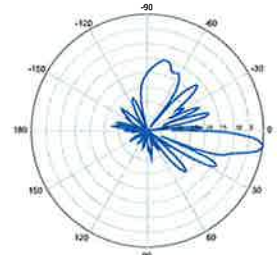

8° | Vertical | 1920-2170 MHz

Quoted performance parameters are provided to offer typical or range values only and may vary as a result of normal manufacturing and operational conditions. Extreme operational conditions and/or stress on structural supports is beyond our control. Such conditions may result in damage to this product. Improvements to product may be made without notice.

## Alcatel-Lucent RRH2x40-AWS

### REMOTE RADIO HEAD

The Alcatel-Lucent RRH2x40-AWS is a high-power, small form-factor Remote Radio Head (RRH) operating in the AWS frequency band (1700/2100MHz - 3GPP Band 4). The Alcatel-Lucent RRH2x40-AWS is designed with an eco-efficient approach, providing operators with the means to achieve high quality and capacity coverage with minimum site requirements.



A distributed eNodeB expands deployment options by using two components, a Base Band Unit (BBU) containing the digital assets and a separate RRH containing the radio-frequency (RF) elements. This modular design optimizes available space and allows the main components of an eNodeB to be installed separately, within the same site or several kilometres apart.

The Alcatel-Lucent RRH2x40-AWS is linked to the BBU by an optical-fiber connection carrying downlink and uplink digital radio signals along with operations, administration and maintenance (OA&M) information. The Alcatel-Lucent RRH2x40-AWS has two transmit RF paths, 40 W RF output power per transmit path, and is designed to manage up to four-way receive diversity. The device is ideally suited to support macro coverage, with multiple-input multiple-output (MIMO) 2x2 operation in up to 20 MHz of bandwidth.

The Alcatel-Lucent RRH2x40-AWS is designed to make available all the benefits of a distributed eNodeB, with excellent RF characteristics, with low

capital expenditures (CAPEX) and low operating expenditures (OPEX). The limited space available in some sites may prevent the installation of traditional single-cabinet BTS equipment or require costly cranes to be employed, leaving coverage holes. However, many of these sites can host an Alcatel-Lucent RRH2x40-AWS installation, providing more flexible site selection and improved network quality along with greatly reduced installation time and costs.

#### Fast, low-cost installation and deployment

The Alcatel-Lucent RRH2x40-AWS is a zero-footprint solution and operates noise-free, simplifying negotiations with site property owners and minimizing environmental impacts. Installation can easily be done by a single person because the Alcatel-Lucent RRH2x40-AWS is compact and weighs less than 20 kg (44 lb), eliminating the need for a crane to hoist the BTS cabinet to the rooftop. A site can be in operation in less than one day — a fraction of the time required for a traditional BTS.

## Excellent RF performance

Because of its small size and weight, the Alcatel-Lucent RRH2x40-AWS can be installed close to the antenna. Operators can therefore locate the Alcatel-Lucent RRH2x40-AWS where RF engineering is deemed ideal, minimizing trade-offs between available sites and RF optimum sites. The RF feeder cost and installation costs are reduced or eliminated, and there is no need for a Tower Mounted Amplifier (TMA) because losses introduced by the RF feeder are greatly reduced. The Alcatel-Lucent RRH2x40-AWS provides more RF power while at the same time consuming less electricity.

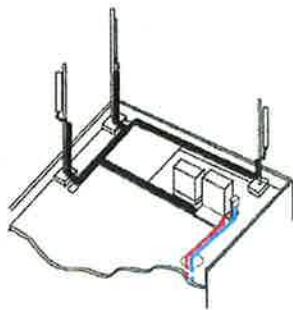

Macro

## Features

- Zero-footprint deployment
- Easy installation, with a lightweight unit can be carried and set up by one person
- Optimized RF power, with flexible site selection and elimination of a TMA
- Convection-cooled (fanless)
- Noise-free
- Best-in-class power efficiency, with significantly reduced energy consumption

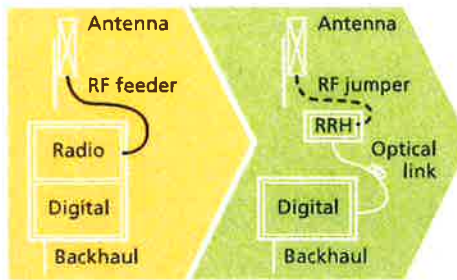

RRH for space-constrained cell sites

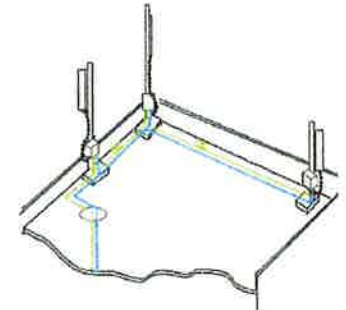

Distributed

## Benefits

- Leverages existing real estate with lower site costs
- Reduces installation costs, with fewer installation materials and simplified logistics
- Decreases power costs and minimizes environmental impacts, with the potential for eco-sustainable power options
- Improves RF performance and adds flexibility to network planning

## Technical specifications

### Physical dimensions

- Height: 620 mm (24.4 in.)
- Width: 270 mm (10.63 in.)
- Depth: 170 mm (6.7 in.)
- Weight (without mounting kit): less than 20 kg (44 lb)

### Power

- Power supply: -48VDC

### Operating environment

- Outdoor temperature range:
  - With solar load: -40°C to +50°C (-40°F to +122°F)
  - Without solar load: -40°C to +55°C (-40°F to +131°F)

- Passive convection cooling (no fans)
- Enclosure protection
  - IP65 (International Protection rating)

### RF characteristics

- Frequency band: 1700/2100 MHz (AWS); 3GPP Band 4
- Bandwidth: up to 20 MHz
- RF output power at antenna port: 40 W nominal RF power for each Tx port
- Rx diversity: 2-way or 4-way with optional Rx Diversity module
- Noise figure: below 2.0 dB typical
- Antenna Line Device features
  - TMA and Remote electrical tilt (RET) support via AISG v2.0

### Optical characteristics

#### Type/number of fibers

- Single-mode variant
  - One Single Mode Single Fiber per RRH2x, carrying UL and DL using CWDM
  - Single mode dual fiber (SM/DF)
- Multi-mode variant
  - Two Multi-mode fibers per RRH2x: one carrying UL, the other carrying DL

### Optical fiber length

- Up to 500 m (0.31 mi), using MM fiber
- Up to 20 km (12.43 mi), using SM fiber

### Digital Ports and Alarms

- Two optical ports to support daisy-chaining
- Six external alarms

[www.alcatel-lucent.com](http://www.alcatel-lucent.com) Alcatel, Lucent, Alcatel-Lucent and the Alcatel-Lucent logo are trademarks of Alcatel-Lucent. All other trademarks are the property of their respective owners. The information presented is subject to change without notice. Alcatel-Lucent assumes no responsibility for inaccuracies contained herein. Copyright © 2010 Alcatel-Lucent. All rights reserved. CPG2809100912 (09)



**HYBRIFLEX™ RRH Hybrid Feeder Cabling Solution, 1-5/8", Single-Mode Fiber**

**Product Description**

RFS' HYBRIFLEX Remote Radio Head (RRH) hybrid feeder cabling solution combines optical fiber and DC power for RRHs in a single lightweight aluminum corrugated cable, making it the world's most innovative solution for RRH deployments.

It was developed to reduce installation complexity and costs at Cellular sites, HYBRIFLEX allows mobile operators deploying an RRH architecture to standardize the RRH installation process and eliminate the need for and cost of cable grounding. HYBRIFLEX combines optical fiber (multi-mode or single-mode) and power in a single corrugated cable. It eliminates the need for junction boxes and can connect multiple RRHs with a single feeder. Standard RFS CELLFLEX® accessories can be used with HYBRIFLEX cable. Both pre-connectorized and on-site options are available.

**Features/Benefits**

- Aluminum corrugated armor with outstanding bending characteristics - minimizes installation time and enables mechanical protection and shielding
- Same accessories as 1 5/8" coaxial cable
- Outer conductor grounding - Eliminates typical grounding requirements and saves on installation costs
- Lightweight solution and compact design - Decreases tower loading
- Robust cabling - Eliminates need for expensive cable trays and ducts
- Installation of tight bundled fiber optic cable pairs directly to the RRH - Reduces CAPEX and wind load by eliminating need for interconnection
- Optical fiber and power cables housed in single corrugated cable - Saves CAPEX by standardizing RRH cable installation and reducing installation requirements
- Outdoor polyethylene jacket - Ensures long-lasting cable protection



Figure 1: HYBRIFLEX Series

**Technical Specifications**

Outer Conductor Armor	Corrugated Aluminum	[mm (in)]	46.5 (1.83)
Jacket	Polyethylene, PE	[mm (in)]	50.3 (1.98)
UV-Protection	Individual and External Jacket		Yes
<b>Size (Power)</b>			
Weight, Approximate		[kg/m (lb/ft)]	1.9 (1.30)
Minimum Bending Radius, Single Bending		[mm (in)]	200 (8)
Minimum Bending Radius, Repeated Bending		[mm (in)]	500 (20)
Recommended/Maximum Clamp Spacing		[m (ft)]	1.0 / 1.2 (3.25 / 4.0)
<b>Electrical Properties</b>			
DC-Resistance Outer Conductor Armor		[Ω/km (Ω/1000ft)]	0.68 (0.205)
DC-Resistance Power Cable, 8 4mm² (8AWG)		[Ω/km (Ω/1000ft)]	2.1 (0.307)
<b>Size (Optical)</b>			
Version			Single-mode OM3
Quantity, Fiber Count			16 (8 pairs)
Core/Clad		[μm]	50/125
Primary Coating (Acrylate)		[μm]	245
Buffer Diameter, Nominal		[μm]	900
Secondary Protection, Jacket, Nominal		[mm (in)]	2.0 (0.08)
Minimum Bending Radius		[mm (in)]	104 (4.1)
Insertion Loss @ wavelength 850nm		dB/km	3.0
Insertion Loss @ wavelength 1310nm		dB/km	1.0
Standards (Meets or exceeds)			UL94-V0, UL1566 RoHS Compliant
<b>Size (Alarm)</b>			
Size (Power)		[mm (AWG)]	8.4 (8)
Quantity, Wire Count (Power)			16 (8 pairs)
Size (Alarm)		[mm (AWG)]	0.8 (18)
Quantity, Wire Count (Alarm)			4 (2 pairs)
Type			UV protected
Strands			19
Primary Jacket Diameter, Nominal		[mm (in)]	6.8 (0.27)
Standards (Meets or exceeds)			NFPA 130, ICEA S-95-658 UL Type XHHW-2, UL 44 UL-LS Limited Smoke, UL VW-1 IEEE-383 (1974), IEEE1202/FT4 RoHS Compliant
<b>Environmental</b>			
Installation Temperature		[°C (°F)]	-40 to +65 (-40 to 149)
Operation Temperature		[°C (°F)]	-40 to +65 (-40 to 149)

\* This data is provisional and subject to change

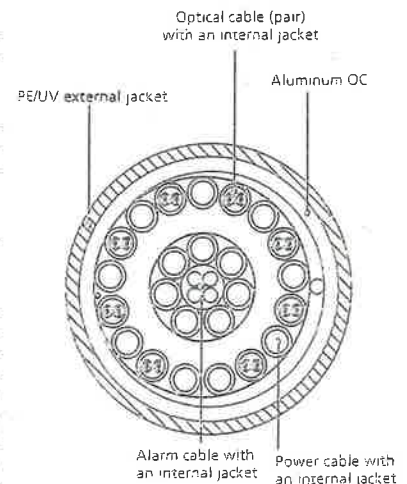

Figure 3: Construction Detail

All information contained in the present datasheet is subject to confirmation at time of ordering



# **ATTACHMENT 2**

Site Name: Cheshire 2 Tower Height: 167Ft		General		Power		Density							
CARRIER	# OF CHAN.	WATTS ERP	HEIGHT	CALC. POWER DENS	FREQ.	MAX. PERMISS. EXP.	FRACTION MPE	Total					
*T-Mobile GSM	8	170	139	0.0253	1945	1.0000	2.53%						
*T-Mobile UMTS	2	711	139	0.0265	2100	1.0000	2.65%						
*MetroPCS CDMA	3	727	118	0.0563	2135	1.0000	5.63%						
*MetroPCS LTE	1	1200	118	0.0310	2130	1.0000	3.10%						
*Sprint CDMA/LTE	4	693	147	0.0461	1900	1.0000	4.61%						
*Sprint CDMA/LTE	1	390	147	0.0065	850	0.5667	1.15%						
*Sprint CDMA/LTE	2	390	147	0.0130	2500	1.0000	1.30%						
*AT&T UMTS	2	565	160	0.0159	880	0.5867	2.71%						
*AT&T UMTS	2	875	160	0.0246	1900	1.0000	2.46%						
*AT&T GSM	1	283	160	0.0040	880	0.5867	0.68%						
*AT&T GSM	4	525	160	0.0295	1900	1.0000	2.95%						
*AT&T LTE	1	1375	160	0.0193	734	0.4893	3.95%						
*Nextel	12	100	128	0.0263	851	0.5673	4.64%						
<b>Verizon</b>	<b>7</b>	<b>272</b>	<b>167</b>	<b>0.0245</b>	<b>1970</b>	<b>1.0000</b>	<b>2.45%</b>						
<b>Verizon</b>	<b>9</b>	<b>376</b>	<b>167</b>	<b>0.0436</b>	<b>869</b>	<b>0.5793</b>	<b>7.53%</b>						
<b>Verizon</b>	<b>1</b>	<b>730</b>	<b>167</b>	<b>0.0094</b>	<b>2145</b>	<b>1.0000</b>	<b>0.94%</b>						
<b>Verizon</b>	<b>1</b>	<b>786</b>	<b>167</b>	<b>0.0101</b>	<b>698</b>	<b>0.4653</b>	<b>2.18%</b>						<b>51.45%</b>
* Source: Siting Council													

# **ATTACHMENT 3**



PAUL J. FORD AND COMPANY  
STRUCTURAL ENGINEERS  
250 East Broad Street • Suite 600 • Columbus, Ohio 43215-3708

Date: April 11, 2014

Charles McGuirt  
Crown Castle  
3530 Toringdon Way Suite 300  
Charlotte, NC 28277

Paul J Ford and Company  
250 E. Broad Street, Suite 600  
Columbus, OH 43215  
614.221.6679  
jwoolley@pjfweb.com

Subject: Structural Analysis Report

**Carrier Designation:** Verizon Wireless Co-Locate  
Carrier Site Number: N/A  
Carrier Site Name: Cheshire 2

**Crown Castle Designation:** Crown Castle BU Number: 801367  
Crown Castle Site Name: CT NHV-2075 CAC 801367  
Crown Castle JDE Job Number: 280749  
Crown Castle Work Order Number: 740267  
Crown Castle Application Number: 237061 Rev. 0

**Engineering Firm Designation:** Paul J Ford and Company Project Number: 37513-0349 R1

**Site Data:** 1121 Summit Road, Cheshire, New Haven County, CT  
Latitude 41° 32' 11.2", Longitude -72° 57' 26.3"  
167 Foot - Monopole Tower

Dear Charles McGuirt,

Paul J Ford and Company is pleased to submit this "Structural Analysis Report" to determine the structural integrity of the above mentioned tower. This analysis has been performed in accordance with the Crown Castle Structural 'Statement of Work' and the terms of Crown Castle Purchase Order Number 634994, in accordance with application 237061, revision 0.

The purpose of the analysis is to determine acceptability of the tower stress level. Based on our analysis we have determined the tower stress level for the structure and foundation, under the following load case, to be:

LC7: Existing + Reserved + Proposed Equipment



**Sufficient Capacity**

Note: See Table I and Table II for the proposed and existing/reserved loading, respectively.

The structural analysis was performed for this tower in accordance with the requirements of TIA/EIA-222-F Structural Standards for Steel Antenna Towers and Antenna Supporting Structures and 2005 CT state building code using a fastest mile wind speed of 85 mph with no ice, 37.6 mph with 0.75 inch ice thickness and 50 mph under service loads.

We at Paul J Ford and Company appreciate the opportunity of providing our continuing professional services to you and Crown Castle. If you have any questions or need further assistance on this or any other projects please give us a call.

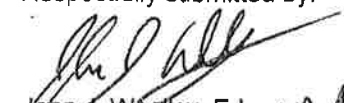
Respectfully submitted by:

  
John J. Woolley, E.I.  
Structural Designer 



  
APR 14 2014

## TABLE OF CONTENTS

- 1) INTRODUCTION**
- 2) ANALYSIS CRITERIA**
  - Table 1 - Proposed Antenna and Cable Information
  - Table 2 – Existing and Reserved Antenna and Cable Information
- 3) ANALYSIS PROCEDURE**
  - Table 3 - Documents Provided
  - 3.1) Analysis Method
  - 3.2) Assumptions
- 4) ANALYSIS RESULTS**
  - Table 4 – Section Capacity (Summary)
  - Table 5 - Tower Component Stresses vs. Capacity
- 5) APPENDIX A**
  - TNX Tower Output
- 6) APPENDIX B**
  - Base Level Drawing
- 7) APPENDIX C**
  - Additional Calculations

**1) INTRODUCTION**

This tower is a 167 ft Monopole tower designed by SUMMIT in June of 2001. The tower was originally designed for a wind speed of 85 mph per TIA/EIA-222-F.

**2) ANALYSIS CRITERIA**

The structural analysis was performed for this tower in accordance with the requirements of TIA/EIA-222-F Structural Standards for Steel Antenna Towers and Antenna Supporting Structures and 2005 CT state building code using a fastest mile wind speed of 85 mph with no ice, 37.6 mph with 0.75 inch ice thickness and 50 mph under service loads.

**Table 1 - Proposed Antenna and Cable Information**

Mounting Level (ft)	Center Line Elevation (ft)	Number of Antennas	Antenna Manufacturer	Antenna Model	Number of Feed Lines	Feed Line Size (in)	Note
167.0	168.0	3	alcatel lucent	RRH2X40-AWS	1	1-5/8	-
		3	antel	BXA-171063-8CF-EDIN-X w/ Mount Pipe			
		1	rfs celwave	DB-T1-6Z-8AB-0Z			

**Table 2 - Existing and Reserved Antenna and Cable Information**

Mounting Level (ft)	Center Line Elevation (ft)	Number of Antennas	Antenna Manufacturer	Antenna Model	Number of Feed Lines	Feed Line Size (in)	Note	
167.0	172.0	1	decibel	DB222-A	-	-	3	
	171.0	1	gps	GPS_A				
	168.0	168.0	3	antel	BXA-171063/8CFx2 w/ Mount Pipe	1 18	1/2 1-5/8	1
			3	antel	BXA-70063-6CF-EDIN-2 w/ Mount Pipe			
			6	antel	LPA-80063-6CF-EDIN w/ Mount Pipe			
	167.0	1	tower mounts	Platform Mount [LP 712-1]				
158.0	160.0	3	andrew	SBNH-1D6565C w/ Mount Pipe	1 2 12	3/8 3/4 1-5/8	1	
		6	powerwave technologies	7770.00 w/ Mount Pipe				
		6	powerwave technologies	LGP13519				
		6	powerwave technologies	LGP21401				
		1	raycap	DC6-48-60-18-8F				
	158.0	1	tower mounts	Platform Mount [LP 712-1]				
	158.0	6	ericsson	RRUS-11				
150.0	151.0	3	alcatel lucent	PCS 1900MHz 4x45W-65MHz	-	-	1	
	150.0	3	alcatel lucent	TME-800MHZ RRH				
		1	tower mounts	Pipe Mount [PM 601-3]				
148.0	148.0	1	tower mounts	Platform Mount [LP 712-1]	3	1/2	1	
		9	rfc celwave	ACU-A20-N				
	147.0	3	alcatel lucent	800 EXTERNAL NOTCH FILTER				
		3	rfc celwave	APXVSP18-C-A20 w/ Mount Pipe				
		3	alcatel lucent	TD-RRH8x20-25				
		3	rfc celwave	APXVTM14-C-120 w/ Mount Pipe				
138.0	139.0	3	ericsson	KRY 112 134/1	18	1-5/8	1	
		3	ericsson	KRY 112 89/5				
		6	remec	S20057A-1				
		3	rfc celwave	APX16DWV-16DWV-S-E-A20 w/ Mount Pipe				
		3	rfc celwave	APX16PV-16PVL-E w/ Mount Pipe				
	138.0	1	tower mounts	Platform Mount [LP 712-1]				
128.0	128.0	12	decibel	DB846G90A-XY w/ Mount Pipe	12	1-1/4	3	
		1	tower mounts	Platform Mount [LP 712-1]				
120.0	120.0	1	tower mounts	Pipe Mount [PM 601-3]	6	1-5/8	1	
	119.0	3	rfc celwave	APXV18-206517S-C w/ Mount Pipe				

- Notes:  
 1) Existing Equipment  
 2) Reserved Equipment  
 3) Equipment To Be Removed

### 3) ANALYSIS PROCEDURE

**Table 3 - Documents Provided**

Document	Remarks	Reference	Source
Original Tower Drawings	Summit, Job #: 14620, dated 6/12/2001	799210	CCISITES
Foundation Drawings	PJF Job #: 29201-0692, dated 6/6/2001	842573	CCISITES
Geotechnical Report	CHA Project #: 8961.07.08, dated 5/15/2001	445076	CCISITES
4-POST-MODIFICATION INSPECTION	TEP, 131001.801367, 5/20/2013	3847627	CCISITES

#### 3.1) Analysis Method

tnxTower (version 6.1.4.1), a commercially available analysis software package, was used to create a three-dimensional model of the tower and calculate member stresses for various loading cases. Selected output from the analysis is included in Appendix A.

#### 3.2) Assumptions

- 1) Tower and structures were built in accordance with the manufacturer's specifications.
- 2) The tower and structures have been maintained in accordance with the manufacturer's specification.
- 3) The configuration of antennas, transmission cables, mounts and other appurtenances are as specified in Tables 1 and 2 and the referenced drawings.
- 4) Monopole has been reinforced in conformance with the referenced modification drawings.
- 5) This analysis analyzes both foundation options in the manufacturer's drawings as it is not clear which was installed.

This analysis may be affected if any assumptions are not valid or have been made in error. Paul J Ford and Company should be notified to determine the effect on the structural integrity of the tower.



4) ANALYSIS RESULTS

Table 4 - Section Capacity (Summary)

Section No.	Elevation (ft)	Component Type	Size	Critical Element	P (K)	SF*P_allow (K)	% Capacity	Pass / Fail
L1	167 - 118.25	Pole	TP35.36x24x0.25	1	-12.13	1405.09	84.3	Pass
L2	118.25 - 90.5	Pole	TP41.3282x33.8114x0.3125	2	-19.42	2114.96	98.6	Pass
L3	90.5 - 77.75	Pole	TP44.3x41.3282x0.3819	3	-21.28	2347.81	96.6	Pass
L4	77.75 - 63.5	Pole	TP46.9913x42.2543x0.375	4	-27.44	2884.51	95.2	Pass
L5	63.5 - 51.5	Pole	TP49.7851x46.9913x0.4599	5	-31.30	3276.31	91.8	Pass
L6	51.5 - 45	Pole	TP51.2985x49.7851x0.4572	6	-33.46	3358.00	93.5	Pass
L7	45 - 0	Pole	TP61.04x51.2985x0.4375	7	-49.27	4374.92	91.5	Pass
							Summary	
						Pole (L2)	98.6	Pass
						<b>RATING =</b>	<b>98.6</b>	<b>Pass</b>

Table 5 - Tower Component Stresses vs. Capacity

Notes	Component	Elevation (ft)	% Capacity	Pass / Fail
1	Anchor Rods	0	87.9	Pass
1	Base Plate	0	75.3	Pass
1, 3	Base Foundation Structural Steel	0	61.0	Pass
1, 3	Base Foundation Soil Interaction	0	85.0	Pass
1, 2	Base Foundation Structural Steel	0	94.5	Pass
1, 2, 4	Base Foundation Soil Interaction	0	85.5	Pass

<b>Structure Rating (max from all components) =</b>	<b>98.6%</b>
---	--------------

Notes:

- 1) See additional documentation in "Appendix C – Additional Calculations" for calculations supporting the % capacity consumed.
- 2) Caisson foundation
- 3) Spread footing foundation
- 4) Foundation Analysis Notes: According to the procedures prescribed and agreed to by the Crown Castle Engineering Foundation Committee, held in January 2010, the existing caisson foundation was analyzed using the methodology in the software 'PLS-Caisson' (Version 8.10, or newer, by Power Line Systems, Inc.). Per the methods in PLS-Caisson, the soil reactions of cohesive soils are calculated using 8CD independent of the depth of the soil layer. The depth of soil to be ignored at the top of the caisson is the greater of the geotechnical report's recommendation, the frost depth of the site or half of the caisson diameter.

**APPENDIX A**  
**TNXTOWER OUTPUT**

## Tower Input Data

There is a pole section.

This tower is designed using the TIA/EIA-222-F standard.

The following design criteria apply:

- 1) Tower is located in New Haven County, Connecticut.
- 2) Basic wind speed of 85.00 mph.
- 3) Nominal ice thickness of 0.7500 in.
- 4) Ice thickness is considered to increase with height.
- 5) Ice density of 56.00 pcf.
- 6) A wind speed of 37.60 mph is used in combination with ice.
- 7) Temperature drop of 50.00 °F.
- 8) Deflections calculated using a wind speed of 50.00 mph.
- 9) A non-linear (P-delta) analysis was used.
- 10) Pressures are calculated at each section.
- 11) Stress ratio used in pole design is 1.333.
- 12) Local bending stresses due to climbing loads, feed line supports, and appurtenance mounts are not considered.

## Options

- |  |  |   |
|--|--|---|
| <ul style="list-style-type: none"> <li>Consider Moments - Legs</li> <li>Consider Moments - Horizontals</li> <li>Consider Moments - Diagonals</li> <li>Use Moment Magnification</li> <li>√ Use Code Stress Ratios</li> <li>√ Use Code Safety Factors - Guys</li> <li>√ Escalate Ice</li> <li>Always Use Max Kz</li> <li>Use Special Wind Profile</li> <li>Include Bolts In Member Capacity</li> <li>Leg Bolts Are At Top Of Section</li> <li>Secondary Horizontal Braces Leg</li> <li>Use Diamond Inner Bracing (4 Sided)</li> <li>Add IBC .6D+W Combination</li> </ul> | <ul style="list-style-type: none"> <li>Distribute Leg Loads As Uniform</li> <li>Assume Legs Pinned</li> <li>√ Assume Rigid Index Plate</li> <li>√ Use Clear Spans For Wind Area</li> <li>Use Clear Spans For KL/r</li> <li>Retension Guys To Initial Tension</li> <li>√ Bypass Mast Stability Checks</li> <li>√ Use Azimuth Dish Coefficients</li> <li>√ Project Wind Area of Appurt.</li> <li>Autocalc Torque Arm Areas</li> <li>SR Members Have Cut Ends</li> <li>Sort Capacity Reports By Component</li> <li>Triangulate Diamond Inner Bracing</li> <li>Use TIA-222-G Tension Splice</li> <li>Capacity Exemption</li> </ul> | <ul style="list-style-type: none"> <li>Treat Feedline Bundles As Cylinder</li> <li>Use ASCE 10 X-Brace Ly Rules</li> <li>Calculate Redundant Bracing Forces</li> <li>Ignore Redundant Members in FEA</li> <li>SR Leg Bolts Resist Compression</li> <li>All Leg Panels Have Same Allowable</li> <li>Offset Girt At Foundation</li> <li>√ Consider Feedline Torque</li> <li>Include Angle Block Shear Check</li> <li style="padding-left: 20px;">Poles</li> <li>√ Include Shear-Torsion Interaction</li> <li>Always Use Sub-Critical Flow</li> <li>Use Top Mounted Sockets</li> </ul> |
|--|--|---|

## Tapered Pole Section Geometry

Section	Elevation ft	Section Length ft	Splice Length ft	Number of Sides	Top Diameter in	Bottom Diameter in	Wall Thickness in	Bend Radius in	Pole Grade
L1	167.0000- 118.2500	48.7500	4.50	18	24.0000	35.3600	0.2500	1.0000	A607-65 (65 ksi)
L2	118.2500- 90.5000	32.2500	0.00	18	33.8114	41.3282	0.3125	1.2500	A607-65 (65 ksi)
L3	90.5000- 77.7500	12.7500	5.50	18	41.3282	44.3000	0.3819	1.5276	Reinf 56.80 ksi (57 ksi)
L4	77.7500- 63.5000	19.7500	0.00	18	42.2542	46.9913	0.3750	1.5000	A607-65 (65 ksi)
L5	63.5000- 51.5000	12.0000	0.00	18	46.9913	49.7851	0.4599	1.8397	Reinf 56.89 ksi (57 ksi)
L6	51.5000- 45.0000	6.5000	0.00	18	49.7851	51.2985	0.4572	1.8287	Reinf 56.91 ksi (57 ksi)
L7	45.0000- 0.0000	45.0000		18	51.2985	61.0400	0.4375	1.7500	A607-65 (65 ksi)

### Tapered Pole Properties

Section	Tip Dia. in	Area in <sup>2</sup>	I in <sup>4</sup>	r in	C in	I/C in <sup>3</sup>	J in <sup>4</sup>	I/Q in <sup>2</sup>	w in	w/t
L1	24.3702	18.8456	1342.9976	8.4313	12.1920	110.1540	2687.7623	9.4246	3.7840	15.136
	35.9055	27.8598	4338.8723	12.4641	17.9629	241.5466	8683.4538	13.9325	5.7834	23.133
L2	35.3980	33.2267	4710.6979	11.8921	17.1762	274.2576	9427.5943	16.6165	5.4008	17.283
	41.9658	40.6825	8646.6072	14.5606	20.9947	411.8463	17304.5919	20.3451	6.7238	21.516
L3	41.9658	49.6331	10513.2981	14.5359	20.9947	500.7586	21040.4298	24.8213	6.6016	17.286
	44.9834	53.2354	12972.5293	15.5909	22.5044	576.4441	25962.1282	26.6227	7.1247	18.656
L4	44.2456	49.8468	11045.1680	14.8671	21.4652	514.5626	22104.8696	24.9281	6.7767	18.071
	47.7162	55.4851	15233.1262	16.5488	23.8716	638.1281	30486.2966	27.7478	7.6105	20.295
L5	47.7162	67.9273	18581.1945	16.5186	23.8716	778.3814	37186.8386	33.9701	7.4610	16.222
	50.5532	72.0058	22133.1353	17.5104	25.2909	875.1439	44295.3940	36.0098	7.9527	17.291
L6	50.5532	71.5793	22004.4775	17.5114	25.2909	870.0568	44037.9092	35.7964	7.9575	17.406
	52.0898	73.7753	24092.4674	18.0487	26.0596	924.5133	48216.6363	36.8946	8.2239	17.988
L7	52.0898	70.6268	23082.1546	18.0556	26.0596	885.7440	46194.6813	35.3201	8.2585	18.877
	61.9816	84.1541	39047.5735	21.5139	31.0083	1259.2612	78146.5267	42.0851	9.9730	22.796

Tower Elevation	Gusset Area (per face)	Gusset Thickness	Gusset Grade	Adjust. Factor A <sub>r</sub>	Adjust. Factor A <sub>r</sub>	Weight Mult.	Double Angle Stitch Bolt Spacing Diagonals	Double Angle Stitch Bolt Spacing Horizontals
ft	ft <sup>2</sup>	in					in	in
L1 167.0000-118.2500				1	1	1		
L2 118.2500-90.5000				1	1	1		
L3 90.5000-77.7500				1	1	1		
L4 77.7500-63.5000				1	1	1		
L5 63.5000-51.5000				1	1	1		
L6 51.5000-45.0000				1	1	1		
L7 45.0000-0.0000				1	1	1		

### Feed Line/Linear Appurtenances - Entered As Area

Description	Face or Leg	Allow Shield	Component Type	Placement	Total Number		C <sub>A</sub> A <sub>A</sub>	Weight
				ft			ft <sup>2</sup> /ft	plf
HJ7-50A(1-5/8")	C	No	Inside Pole	167.0000 - 0.0000	6	No Ice	0.0000	1.04
						1/2" Ice	0.0000	1.04
						1" Ice	0.0000	1.04
						2" Ice	0.0000	1.04
						4" Ice	0.0000	1.04
LDF7-50A(1-5/8")	C	No	Inside Pole	167.0000 - 0.0000	6	No Ice	0.0000	0.82
						1/2" Ice	0.0000	0.82
						1" Ice	0.0000	0.82
						2" Ice	0.0000	0.82

Description	Face or Leg	Allow Shield	Component Type	Placement ft	Total Number	C <sub>A</sub> A <sub>A</sub>		Weight
						ft <sup>2</sup> /ft	plf	
LDF4-50A(1/2")	C	No	Inside Pole	167.0000 - 0.0000	1	4" Ice	0.0000	0.82
						No Ice	0.0000	0.15
						1/2" Ice	0.0000	0.15
						1" Ice	0.0000	0.15
						2" Ice	0.0000	0.15
LDF5-50A(7/8")	C	No	Inside Pole	167.0000 - 0.0000	1	4" Ice	0.0000	0.15
						No Ice	0.0000	0.33
						1/2" Ice	0.0000	0.33
						1" Ice	0.0000	0.33
						2" Ice	0.0000	0.33
561(1-5/8")	C	No	CaAa (Out Of Face)	167.0000 - 138.0000	1	4" Ice	0.0000	0.33
						No Ice	0.1625	1.35
						1/2" Ice	0.2625	2.65
						1" Ice	0.3625	4.56
						2" Ice	0.5625	10.21
561(1-5/8")	C	No	CaAa (Out Of Face)	167.0000 - 0.0000	6	4" Ice	0.9625	28.84
						No Ice	0.0000	1.35
						1/2" Ice	0.0000	2.65
						1" Ice	0.0000	4.56
						2" Ice	0.0000	10.21
561(1-5/8")	C	No	CaAa (Out Of Face)	138.0000 - 0.0000	1	4" Ice	0.0000	28.84
						No Ice	0.0000	1.35
						1/2" Ice	0.0000	2.65
						1" Ice	0.0000	4.56
						2" Ice	0.0000	10.21
***								
LDF7-50A(1-5/8")	C	No	Inside Pole	158.0000 - 0.0000	12	4" Ice	0.0000	0.82
						No Ice	0.0000	0.82
						1/2" Ice	0.0000	0.82
						1" Ice	0.0000	0.82
						2" Ice	0.0000	0.82
FB-L98B-002-75000(3/8")	C	No	Inside Pole	158.0000 - 0.0000	1	4" Ice	0.0000	0.82
						No Ice	0.0000	0.06
						1/2" Ice	0.0000	0.06
						1" Ice	0.0000	0.06
						2" Ice	0.0000	0.06
WR-VG86ST-BRD(3/4)	C	No	Inside Pole	158.0000 - 0.0000	2	4" Ice	0.0000	0.06
						No Ice	0.0000	0.59
						1/2" Ice	0.0000	0.59
						1" Ice	0.0000	0.59
						2" Ice	0.0000	0.59
***								
LDF7-50A(1-5/8")	C	No	Inside Pole	148.0000 - 0.0000	6	4" Ice	0.0000	0.82
						No Ice	0.0000	0.82
						1/2" Ice	0.0000	0.82
						1" Ice	0.0000	0.82
						2" Ice	0.0000	0.82
***								
FLC 158-50J(1-5/8")	C	No	Inside Pole	138.0000 - 0.0000	14	4" Ice	0.0000	0.92
						No Ice	0.0000	0.92
						1/2" Ice	0.0000	0.92
						1" Ice	0.0000	0.92
						2" Ice	0.0000	0.92
FLC 158-50J(1-5/8")	C	No	CaAa (Out Of Face)	138.0000 - 0.0000	2	4" Ice	0.0000	0.92
						No Ice	0.0000	0.92
						1/2" Ice	0.0000	2.46
						1" Ice	0.0000	4.60
						2" Ice	0.0000	10.73
FLC 158-50J(1-5/8")	C	No	CaAa (Out Of Face)	138.0000 - 0.0000	2	4" Ice	0.0000	30.31
						No Ice	0.2015	0.92
						1/2" Ice	0.3015	2.46
						1" Ice	0.4015	4.60
						2" Ice	0.6015	10.73
LDF6-50A(1-1/4")	C	No	Inside Pole	128.0000 - 0.0000	12	4" Ice	1.0015	30.31
						No Ice	0.0000	0.66
						1/2" Ice	0.0000	0.66
						1" Ice	0.0000	0.66
						2" Ice	0.0000	0.66
4" Ice	0.0000	0.66						

Description	Face or Leg	Allow Shield	Component Type	Placement ft	Total Number	C <sub>A</sub> A <sub>A</sub>		Weight plf
						In Face ft <sup>2</sup>	Out Face ft <sup>2</sup>	
LCF158-50JL(1-5/8")	C	No	CaAa (Out Of Face)	120.0000 - 0.0000	6	No Ice	0.0000	0.52
						1/2" Ice	0.0000	2.03
						1" Ice	0.0000	4.16
						2" Ice	0.0000	10.24
						4" Ice	0.0000	29.74
*****								
Aero MP3-04	C	No	CaAa (Out Of Face)	65.0000 - 43.0000	1	No Ice	0.2690	0.00
						1/2" Ice	0.3801	0.00
						1" Ice	0.4913	0.00
						2" Ice	0.7135	0.00
						4" Ice	1.1579	0.00
Aero MP3-03	C	No	CaAa (Out Of Face)	91.5000 - 81.5000	1	No Ice	0.2625	0.00
						1/2" Ice	0.3736	0.00
						1" Ice	0.4847	0.00
						2" Ice	0.7069	0.00
						4" Ice	1.1514	0.00
***								
HYBRIFLEX RRH 1-SECTOR(1/2")	C	No	CaAa (Out Of Face)	148.0000 - 0.0000	3	No Ice	0.0000	0.15
						1/2" Ice	0.0000	0.83
						1" Ice	0.0000	2.13
						2" Ice	0.0000	6.55
						4" Ice	0.0000	22.73

### Feed Line/Linear Appurtenances Section Areas

Tower Section	Tower Elevation ft	Face	A <sub>R</sub> ft <sup>2</sup>	A <sub>F</sub> ft <sup>2</sup>	C <sub>A</sub> A <sub>A</sub>		Weight K
					In Face ft <sup>2</sup>	Out Face ft <sup>2</sup>	
L1	167.0000-118.2500	A	0.000	0.000	0.000	0.000	0.00
		B	0.000	0.000	0.000	0.000	0.00
		C	0.000	0.000	0.000	12.672	2.04
L2	118.2500-90.5000	A	0.000	0.000	0.000	0.000	0.00
		B	0.000	0.000	0.000	0.000	0.00
		C	0.000	0.000	0.000	11.446	1.81
L3	90.5000-77.7500	A	0.000	0.000	0.000	0.000	0.00
		B	0.000	0.000	0.000	0.000	0.00
		C	0.000	0.000	0.000	7.501	0.83
L4	77.7500-63.5000	A	0.000	0.000	0.000	0.000	0.00
		B	0.000	0.000	0.000	0.000	0.00
		C	0.000	0.000	0.000	6.146	0.93
L5	63.5000-51.5000	A	0.000	0.000	0.000	0.000	0.00
		B	0.000	0.000	0.000	0.000	0.00
		C	0.000	0.000	0.000	8.064	0.78
L6	51.5000-45.0000	A	0.000	0.000	0.000	0.000	0.00
		B	0.000	0.000	0.000	0.000	0.00
		C	0.000	0.000	0.000	4.368	0.42
L7	45.0000-0.0000	A	0.000	0.000	0.000	0.000	0.00
		B	0.000	0.000	0.000	0.000	0.00
		C	0.000	0.000	0.000	18.673	2.93

### Feed Line/Linear Appurtenances Section Areas - With Ice

Tower Section	Tower Elevation ft	Face or Leg	Ice Thickness in	A <sub>R</sub> ft <sup>2</sup>	A <sub>F</sub> ft <sup>2</sup>	C <sub>A</sub> A <sub>A</sub>		Weight K
						In Face ft <sup>2</sup>	Out Face ft <sup>2</sup>	
L1	167.0000-118.2500	A	0.893	0.000	0.000	0.000	0.000	0.00
		B		0.000	0.000	0.000	0.000	0.00
		C		0.000	0.000	0.000	24.906	3.43
L2	118.2500-90.5000	A	0.861	0.000	0.000	0.000	0.000	0.00
		B		0.000	0.000	0.000	0.000	0.00
		C		0.000	0.000	0.000	21.557	3.38
L3	90.5000-77.7500	A	0.839	0.000	0.000	0.000	0.000	0.00
		B		0.000	0.000	0.000	0.000	0.00

Tower Section	Tower Elevation ft	Face or Leg	Ice Thickness in	A <sub>R</sub> ft <sup>2</sup>	A <sub>F</sub> ft <sup>2</sup>	C <sub>A</sub> A <sub>A</sub> In Face ft <sup>2</sup>	C <sub>A</sub> A <sub>A</sub> Out Face ft <sup>2</sup>	Weight K
L4	77.7500-63.5000	C		0.000	0.000	0.000	13.458	1.50
		A	0.822	0.000	0.000	0.000	0.000	0.00
		B		0.000	0.000	0.000	0.000	0.00
L5	63.5000-51.5000	C		0.000	0.000	0.000	11.208	1.68
		A	0.802	0.000	0.000	0.000	0.000	0.00
		B		0.000	0.000	0.000	0.000	0.00
L6	51.5000-45.0000	C		0.000	0.000	0.000	14.049	1.38
		A	0.785	0.000	0.000	0.000	0.000	0.00
		B		0.000	0.000	0.000	0.000	0.00
L7	45.0000-0.0000	C		0.000	0.000	0.000	7.543	0.74
		A	0.750	0.000	0.000	0.000	0.000	0.00
		B		0.000	0.000	0.000	0.000	0.00
		C		0.000	0.000	0.000	32.506	4.99

### Feed Line Center of Pressure

Section	Elevation ft	CP <sub>x</sub> in	CP <sub>z</sub> in	CP <sub>x</sub> Ice in	CP <sub>z</sub> Ice in
L1	167.0000-118.2500	-0.3186	0.1639	-0.5437	0.3139
L2	118.2500-90.5000	-0.4751	0.2743	-0.7827	0.4519
L3	90.5000-77.7500	-0.6539	0.3775	-1.0239	0.5911
L4	77.7500-63.5000	-0.5039	0.2910	-0.8221	0.4746
L5	63.5000-51.5000	-0.7483	0.4320	-1.1492	0.6635
L6	51.5000-45.0000	-0.7529	0.4347	-1.1537	0.6661
L7	45.0000-0.0000	-0.4940	0.2852	-0.7928	0.4577

### Discrete Tower Loads

Description	Face or Leg	Offset Type	Offsets: Horz Lateral Vert ft ft ft	Azimuth Adjustmen t °	Placement ft	C <sub>A</sub> A <sub>A</sub> Front ft <sup>2</sup>	C <sub>A</sub> A <sub>A</sub> Side ft <sup>2</sup>	Weight K	
Lightning Rod 5/8x4'	C	From Face	0.0000	0.0000	167.0000	No Ice	0.2500	0.2500	0.03
			0.00			1/2"	0.6635	0.6635	0.03
			2.00			Ice	0.9732	0.9732	0.04
						1" Ice	1.4936	1.4936	0.06
						2" Ice	2.6833	2.6833	0.14
						4" Ice			
(2) LPA-80063-6CF-EDIN w/ Mount Pipe	A	From Leg	4.0000	0.0000	167.0000	No Ice	10.7445	10.7001	0.05
			0.00			1/2"	11.4117	11.9672	0.15
			1.00			Ice	12.0450	12.9479	0.25
						1" Ice	13.3414	14.9632	0.48
						2" Ice	16.0541	19.2085	1.10
						4" Ice			
(2) LPA-80063-6CF-EDIN w/ Mount Pipe	B	From Leg	4.0000	0.0000	167.0000	No Ice	10.7445	10.7001	0.05
			0.00			1/2"	11.4117	11.9672	0.15
			1.00			Ice	12.0450	12.9479	0.25
						1" Ice	13.3414	14.9632	0.48
						2" Ice	16.0541	19.2085	1.10
						4" Ice			
(2) LPA-80063-6CF-EDIN w/ Mount Pipe	C	From Leg	4.0000	0.0000	167.0000	No Ice	10.7445	10.7001	0.05
			0.00			1/2"	11.4117	11.9672	0.15
			1.00			Ice	12.0450	12.9479	0.25
						1" Ice	13.3414	14.9632	0.48
						2" Ice	16.0541	19.2085	1.10
						4" Ice			

Description	Face or Leg	Offset Type	Offsets: Horz Lateral Vert ft ft ft	Azimuth Adjustment °	Placement ft	CAAA Front ft <sup>2</sup>	CAAA Side ft <sup>2</sup>	Weight K	
GPS_A	A	From Leg	4.0000 0.00 4.00	0.0000	167.0000	4" Ice			
						No Ice	0.2975	0.2975	0.00
						1/2"	0.3739	0.3739	0.00
						Ice	0.4589	0.4589	0.01
						1" Ice	0.6549	0.6549	0.02
BXA-171063/8CFx2 w/ Mount Pipe	A	From Leg	4.0000 0.00 1.00	0.0000	167.0000	2" Ice	1.1506	1.1506	0.08
						4" Ice			
						No Ice	3.1396	3.5101	0.03
						1/2"	3.5152	4.1303	0.06
						Ice	3.9152	4.7565	0.10
BXA-171063/8CFx2 w/ Mount Pipe	B	From Leg	4.0000 0.00 1.00	0.0000	167.0000	1" Ice	4.8036	6.0591	0.20
						2" Ice	6.7148	9.0948	0.49
						4" Ice			
						No Ice	3.1396	3.5101	0.03
						1/2"	3.5152	4.1303	0.06
BXA-171063/8CFx2 w/ Mount Pipe	C	From Leg	4.0000 0.00 1.00	0.0000	167.0000	Ice	3.9152	4.7565	0.10
						1" Ice	4.8036	6.0591	0.20
						2" Ice	6.7148	9.0948	0.49
						4" Ice			
						No Ice	3.1396	3.5101	0.03
BXA-70063-6CF-EDIN-2 w/ Mount Pipe	A	From Leg	4.0000 0.00 1.00	0.0000	167.0000	1/2"	8.6091	6.9529	0.10
						Ice	9.2158	7.8191	0.17
						1" Ice	10.4591	9.6015	0.34
						2" Ice	13.0655	13.3662	0.80
						4" Ice			
BXA-70063-6CF-EDIN-2 w/ Mount Pipe	B	From Leg	4.0000 0.00 1.00	0.0000	167.0000	No Ice	7.9686	5.8008	0.04
						1/2"	8.6091	6.9529	0.10
						Ice	9.2158	7.8191	0.17
						1" Ice	10.4591	9.6015	0.34
						2" Ice	13.0655	13.3662	0.80
BXA-70063-6CF-EDIN-2 w/ Mount Pipe	C	From Leg	4.0000 0.00 1.00	0.0000	167.0000	4" Ice			
						No Ice	7.9686	5.8008	0.04
						1/2"	8.6091	6.9529	0.10
						Ice	9.2158	7.8191	0.17
						1" Ice	10.4591	9.6015	0.34
Platform Mount [LP 712-1]	C	None		0.0000	167.0000	2" Ice	13.0655	13.3662	0.80
						4" Ice			
						No Ice	24.5300	24.5300	1.34
						1/2"	29.9400	29.9400	1.65
						Ice	35.3500	35.3500	1.96
*** (2) 7770.00 w/ Mount Pipe	A	From Leg	4.0000 0.00 2.00	0.0000	158.0000	1" Ice	8.1643	7.1553	0.29
						2" Ice	10.3599	10.4117	0.66
						4" Ice			
						No Ice	6.1194	4.2543	0.06
						1/2"	6.6258	5.0137	0.10
(2) 7770.00 w/ Mount Pipe	B	From Leg	4.0000 0.00 2.00	0.0000	158.0000	Ice	7.1283	5.7109	0.16
						1" Ice	8.1643	7.1553	0.29
						2" Ice	10.3599	10.4117	0.66
						4" Ice			
						No Ice	6.1194	4.2543	0.06
(2) 7770.00 w/ Mount Pipe	C	From Leg	4.0000 0.00 2.00	0.0000	158.0000	1/2"	6.6258	5.0137	0.10
						Ice	7.1283	5.7109	0.16
						1" Ice	8.1643	7.1553	0.29



Description	Face or Leg	Offset Type	Offsets:		Azimuth Adjustment	Placement	C <sub>A</sub> A <sub>A</sub> Front	C <sub>A</sub> A <sub>A</sub> Side	Weight
			Horz	Lateral					
							ft <sup>2</sup>	ft <sup>2</sup>	K
(2) LGP13519	A	From Leg	4.0000	0.0000	158.0000	1" Ice	8.1643	7.1553	0.29
						2" Ice	10.3599	10.4117	0.66
						4" Ice			
						No Ice	0.3379	0.2074	0.01
						1/2" Ice	0.4220	0.2804	0.01
						Ice	0.5147	0.3621	0.01
						1" Ice	0.7260	0.5513	0.02
(2) LGP13519	B	From Leg	4.0000	0.0000	158.0000	2" Ice	1.2523	1.0335	0.07
						4" Ice			
						No Ice	0.3379	0.2074	0.01
						1/2" Ice	0.4220	0.2804	0.01
						Ice	0.5147	0.3621	0.01
						1" Ice	0.7260	0.5513	0.02
						2" Ice	1.2523	1.0335	0.07
(2) LGP13519	C	From Leg	4.0000	0.0000	158.0000	4" Ice			
						No Ice	0.3379	0.2074	0.01
						1/2" Ice	0.4220	0.2804	0.01
						Ice	0.5147	0.3621	0.01
						1" Ice	0.7260	0.5513	0.02
						2" Ice	1.2523	1.0335	0.07
						4" Ice			
(2) LGP21401	A	From Leg	4.0000	0.0000	158.0000	No Ice	1.2880	0.2326	0.01
						1/2" Ice	1.4453	0.3134	0.02
						Ice	1.6112	0.4028	0.03
						1" Ice	1.9690	0.6076	0.05
						2" Ice	2.7882	1.1210	0.14
						4" Ice			
						No Ice	1.2880	0.2326	0.01
(2) LGP21401	B	From Leg	4.0000	0.0000	158.0000	1/2" Ice	1.4453	0.3134	0.02
						Ice	1.6112	0.4028	0.03
						1" Ice	1.9690	0.6076	0.05
						2" Ice	2.7882	1.1210	0.14
						4" Ice			
						No Ice	1.2880	0.2326	0.01
						1/2" Ice	1.4453	0.3134	0.02
(2) LGP21401	C	From Leg	4.0000	0.0000	158.0000	Ice	1.6112	0.4028	0.03
						1" Ice	1.9690	0.6076	0.05
						2" Ice	2.7882	1.1210	0.14
						4" Ice			
						No Ice	1.2880	0.2326	0.01
						1/2" Ice	1.4453	0.3134	0.02
						Ice	1.6112	0.4028	0.03
SBNH-1D6565C w/ Mount Pipe	A	From Leg	4.0000	0.0000	158.0000	1" Ice	14.2911	14.8689	0.51
						2" Ice	17.4280	19.6184	1.15
						4" Ice			
						No Ice	11.5561	9.7151	0.10
						1/2" Ice	12.2227	11.1857	0.19
						Ice	12.8929	12.5942	0.28
						1" Ice	14.2911	14.8689	0.51
SBNH-1D6565C w/ Mount Pipe	B	From Leg	4.0000	0.0000	158.0000	2" Ice	17.4280	19.6184	1.15
						4" Ice			
						No Ice	11.5561	9.7151	0.10
						1/2" Ice	12.2227	11.1857	0.19
						Ice	12.8929	12.5942	0.28
						1" Ice	14.2911	14.8689	0.51
						2" Ice	17.4280	19.6184	1.15
SBNH-1D6565C w/ Mount Pipe	C	From Leg	4.0000	0.0000	158.0000	4" Ice			
						No Ice	11.5561	9.7151	0.10
						1/2" Ice	12.2227	11.1857	0.19
						Ice	12.8929	12.5942	0.28
						1" Ice	14.2911	14.8689	0.51
						2" Ice	17.4280	19.6184	1.15
						4" Ice			
(2) RRUS-11	A	From Leg	4.0000	0.0000	156.0000	No Ice	3.2486	1.3726	0.05
						1/2" Ice	3.4905	1.5510	0.07
						Ice	3.7411	1.7380	0.09
						1" Ice	4.2682	2.1381	0.15
						2" Ice	5.4260	3.0418	0.31
						4" Ice			
						No Ice	3.2486	1.3726	0.05
(2) RRUS-11	B	From Leg	4.0000	0.0000	156.0000	1/2" Ice	3.4905	1.5510	0.07
						No Ice	3.2486	1.3726	0.05

Description	Face or Leg	Offset Type	Offsets: Horz Lateral Vert ft ft ft	Azimuth Adjustment °	Placement ft	CAAA Front ft <sup>2</sup>	CAAA Side ft <sup>2</sup>	Weight K
			2.00			Ice 3.7411	1.7380	0.09
						1" Ice 4.2682	2.1381	0.15
						2" Ice 5.4260	3.0418	0.31
						4" Ice		
(2) RRUS-11	C	From Leg	4.0000 0.00 2.00	0.0000	156.0000	No Ice 3.2486	1.3726	0.05
						1/2" 3.4905	1.5510	0.07
						Ice 3.7411	1.7380	0.09
						1" Ice 4.2682	2.1381	0.15
						2" Ice 5.4260	3.0418	0.31
						4" Ice		
DC6-48-60-18-8F	A	From Leg	4.0000 0.00 2.00	0.0000	158.0000	No Ice 2.5667	2.5667	0.02
						1/2" 2.7978	2.7978	0.04
						Ice 3.0377	3.0377	0.07
						1" Ice 3.5432	3.5432	0.13
						2" Ice 4.6580	4.6580	0.30
						4" Ice		
Platform Mount [LP 712-1]	C	None		0.0000	158.0000	No Ice 24.5300	24.5300	1.34
						1/2" 29.9400	29.9400	1.65
						Ice 35.3500	35.3500	1.96
						1" Ice 46.1700	46.1700	2.58
						2" Ice 67.8100	67.8100	3.82
						4" Ice		
6' x 2" Mount Pipe	A	From Leg	4.0000 0.00 1.00	0.0000	158.0000	No Ice 1.4250	1.4250	0.02
						1/2" 1.9250	1.9250	0.03
						Ice 2.2939	2.2939	0.05
						1" Ice 3.0596	3.0596	0.09
						2" Ice 4.7022	4.7022	0.23
						4" Ice		
6' x 2" Mount Pipe	B	From Leg	4.0000 0.00 1.00	0.0000	158.0000	No Ice 1.4250	1.4250	0.02
						1/2" 1.9250	1.9250	0.03
						Ice 2.2939	2.2939	0.05
						1" Ice 3.0596	3.0596	0.09
						2" Ice 4.7022	4.7022	0.23
						4" Ice		
6' x 2" Mount Pipe	C	From Leg	4.0000 0.00 1.00	0.0000	158.0000	No Ice 1.4250	1.4250	0.02
						1/2" 1.9250	1.9250	0.03
						Ice 2.2939	2.2939	0.05
						1" Ice 3.0596	3.0596	0.09
						2" Ice 4.7022	4.7022	0.23
						4" Ice		
****								
Platform Mount [LP 712-1]	C	None		0.0000	148.0000	No Ice 24.5300	24.5300	1.34
						1/2" 29.9400	29.9400	1.65
						Ice 35.3500	35.3500	1.96
						1" Ice 46.1700	46.1700	2.58
						2" Ice 67.8100	67.8100	3.82
						4" Ice		
****								
APX16PV-16PVL-E w/ Mount Pipe	A	From Leg	4.0000 0.00 1.00	0.0000	138.0000	No Ice 6.9361	3.2893	0.06
						1/2" 7.4389	3.9953	0.11
						Ice 7.9415	4.6615	0.16
						1" Ice 8.9779	6.0439	0.28
						2" Ice 11.1750	9.0230	0.65
						4" Ice		
APX16PV-16PVL-E w/ Mount Pipe	B	From Leg	4.0000 0.00 1.00	0.0000	138.0000	No Ice 6.9361	3.2893	0.06
						1/2" 7.4389	3.9953	0.11
						Ice 7.9415	4.6615	0.16
						1" Ice 8.9779	6.0439	0.28
						2" Ice 11.1750	9.0230	0.65
						4" Ice		
APX16PV-16PVL-E w/ Mount Pipe	C	From Leg	4.0000 0.00 1.00	0.0000	138.0000	No Ice 6.9361	3.2893	0.06
						1/2" 7.4389	3.9953	0.11
						Ice 7.9415	4.6615	0.16
						1" Ice 8.9779	6.0439	0.28
						2" Ice 11.1750	9.0230	0.65
						4" Ice		

Description	Face or Leg	Offset Type	Offsets:		Azimuth Adjustment	Placement	C <sub>AA</sub> Front	C <sub>AA</sub> Side	Weight	
			Horz	Lateral Vert						
			ft	ft	°	ft	ft <sup>2</sup>	ft <sup>2</sup>	K	
APX16DWV-16DWV-S-E-A20 w/ Mount Pipe	A	From Leg	4.0000	0.00	0.0000	138.0000	4" Ice	7.4657	3.4938	0.06
							No Ice	7.9944	4.2631	0.11
							1/2" Ice	8.5176	4.9598	0.16
							1" Ice	9.5949	6.4031	0.30
							2" Ice	11.8728	9.4897	0.68
APX16DWV-16DWV-S-E-A20 w/ Mount Pipe	B	From Leg	4.0000	0.00	0.0000	138.0000	4" Ice	7.4657	3.4938	0.06
							No Ice	7.9944	4.2631	0.11
							1/2" Ice	8.5176	4.9598	0.16
							1" Ice	9.5949	6.4031	0.30
							2" Ice	11.8728	9.4897	0.68
APX16DWV-16DWV-S-E-A20 w/ Mount Pipe	C	From Leg	4.0000	0.00	0.0000	138.0000	4" Ice	7.4657	3.4938	0.06
							No Ice	7.9944	4.2631	0.11
							1/2" Ice	8.5176	4.9598	0.16
							1" Ice	9.5949	6.4031	0.30
							2" Ice	11.8728	9.4897	0.68
KRY 112 134/1	A	From Leg	4.0000	0.00	0.0000	138.0000	4" Ice	1.0082	0.4869	0.01
							No Ice	1.1488	0.6009	0.02
							1/2" Ice	1.2980	0.7236	0.03
							1" Ice	1.6223	0.9950	0.05
							2" Ice	2.3747	1.6413	0.13
KRY 112 134/1	B	From Leg	4.0000	0.00	0.0000	138.0000	4" Ice	1.0082	0.4869	0.01
							No Ice	1.1488	0.6009	0.02
							1/2" Ice	1.2980	0.7236	0.03
							1" Ice	1.6223	0.9950	0.05
							2" Ice	2.3747	1.6413	0.13
KRY 112 134/1	C	From Leg	4.0000	0.00	0.0000	138.0000	4" Ice	1.0082	0.4869	0.01
							No Ice	1.1488	0.6009	0.02
							1/2" Ice	1.2980	0.7236	0.03
							1" Ice	1.6223	0.9950	0.05
							2" Ice	2.3747	1.6413	0.13
KRY 112 89/5	A	From Leg	4.0000	0.00	0.0000	138.0000	4" Ice	0.6417	0.4278	0.02
							No Ice	0.7562	0.5293	0.02
							1/2" Ice	0.8793	0.6395	0.03
							1" Ice	1.1515	0.8858	0.05
							2" Ice	1.7997	1.4821	0.11
KRY 112 89/5	B	From Leg	4.0000	0.00	0.0000	138.0000	4" Ice	0.6417	0.4278	0.02
							No Ice	0.7562	0.5293	0.02
							1/2" Ice	0.8793	0.6395	0.03
							1" Ice	1.1515	0.8858	0.05
							2" Ice	1.7997	1.4821	0.11
KRY 112 89/5	C	From Leg	4.0000	0.00	0.0000	138.0000	4" Ice	0.6417	0.4278	0.02
							No Ice	0.7562	0.5293	0.02
							1/2" Ice	0.8793	0.6395	0.03
							1" Ice	1.1515	0.8858	0.05
							2" Ice	1.7997	1.4821	0.11
(2) S20057A-1	A	From Leg	4.0000	0.00	0.0000	138.0000	4" Ice	0.8286	0.3942	0.01
							No Ice	0.9610	0.5048	0.01
							1/2" Ice	1.1019	0.6242	0.02
							1" Ice	1.4098	0.8887	0.04
							2" Ice	2.1292	1.5216	0.11
(2) S20057A-1	B	From Leg	4.0000	0.00	0.0000	138.0000	4" Ice	0.8286	0.3942	0.01
							No Ice	0.9610	0.5048	0.01
							1/2" Ice	1.1019	0.6242	0.02
							1" Ice	1.4098	0.8887	0.04
							2" Ice	2.1292	1.5216	0.11

Description	Face or Leg	Offset Type	Offsets: Horz Lateral Vert ft ft ft	Azimuth Adjustment	Placement ft	C <sub>A</sub> A <sub>A</sub> Front ft <sup>2</sup>	C <sub>A</sub> A <sub>A</sub> Side ft <sup>2</sup>	Weight K	
(2) S20057A-1	C	From Leg	4.0000 0.00 1.00	0.0000	138.0000	2" Ice	2.1292	1.5216	0.11
						4" Ice			
						No Ice	0.8286	0.3942	0.01
						1/2"	0.9610	0.5048	0.01
						Ice	1.1019	0.6242	0.02
						1" Ice	1.4098	0.8887	0.04
Platform Mount [LP 712-1]	C	None		0.0000	138.0000	2" Ice	2.1292	1.5216	0.11
						4" Ice			
						No Ice	24.5300	24.5300	1.34
						1/2"	29.9400	29.9400	1.65
						Ice	35.3500	35.3500	1.96
						1" Ice	46.1700	46.1700	2.58
6' x 2" Mount Pipe	A	From Leg	4.0000 0.00 1.00	0.0000	138.0000	2" Ice	67.8100	67.8100	3.82
						4" Ice			
						No Ice	1.4250	1.4250	0.02
						1/2"	1.9250	1.9250	0.03
						Ice	2.2939	2.2939	0.05
						1" Ice	3.0596	3.0596	0.09
6' x 2" Mount Pipe	B	From Leg	4.0000 0.00 1.00	0.0000	138.0000	2" Ice	4.7022	4.7022	0.23
						4" Ice			
						No Ice	1.4250	1.4250	0.02
						1/2"	1.9250	1.9250	0.03
						Ice	2.2939	2.2939	0.05
						1" Ice	3.0596	3.0596	0.09
6' x 2" Mount Pipe	C	From Leg	4.0000 0.00 1.00	0.0000	138.0000	2" Ice	4.7022	4.7022	0.23
						4" Ice			
						No Ice	1.4250	1.4250	0.02
						1/2"	1.9250	1.9250	0.03
						Ice	2.2939	2.2939	0.05
						1" Ice	3.0596	3.0596	0.09
APXV18-206517S-C w/ Mount Pipe	A	From Leg	1.0000 0.00 -1.00	30.0000	120.0000	2" Ice	9.9193	12.2774	0.68
						4" Ice			
						No Ice	5.4042	4.7000	0.05
						1/2"	5.9597	5.8600	0.10
						Ice	6.4808	6.7338	0.15
						1" Ice	7.5467	8.5150	0.28
APXV18-206517S-C w/ Mount Pipe	B	From Leg	1.0000 0.00 -1.00	30.0000	120.0000	2" Ice	9.9193	12.2774	0.68
						4" Ice			
						No Ice	5.4042	4.7000	0.05
						1/2"	5.9597	5.8600	0.10
						Ice	6.4808	6.7338	0.15
						1" Ice	7.5467	8.5150	0.28
APXV18-206517S-C w/ Mount Pipe	C	From Leg	1.0000 0.00 -1.00	30.0000	120.0000	2" Ice	9.9193	12.2774	0.68
						4" Ice			
						No Ice	5.4042	4.7000	0.05
						1/2"	5.9597	5.8600	0.10
						Ice	6.4808	6.7338	0.15
						1" Ice	7.5467	8.5150	0.28
Pipe Mount [PM 601-3]	C	None		0.0000	120.0000	2" Ice	13.1100	13.1100	0.53
						4" Ice			
						No Ice	4.3900	4.3900	0.20
						1/2"	5.4800	5.4800	0.24
						Ice	6.5700	6.5700	0.28
						1" Ice	8.7500	8.7500	0.36
Side Arm Mount [SO 102-3]	C	None		0.0000	156.0000	2" Ice	6.8400	6.8400	0.32
						4" Ice			
						No Ice	3.0000	3.0000	0.08
						1/2"	3.4800	3.4800	0.11
						Ice	3.9600	3.9600	0.14
						1" Ice	4.9200	4.9200	0.20

Description	Face or Leg	Offset Type	Offsets: Horz Lateral Vert ft ft ft	Azimuth Adjustment t °	Placement ft	C <sub>A</sub> A <sub>A</sub> Front ft <sup>2</sup>	C <sub>A</sub> A <sub>A</sub> Side ft <sup>2</sup>	Weight K	
****									
800 EXTERNAL NOTCH FILTER	A	From Leg	4.0000 0.00 -1.00	0.0000	148.0000	No Ice 0.7701 1/2" 0.8898 Ice 1.0181 1" Ice 1.3007 2" Ice 1.9696 4" Ice 1.3372	0.3747 0.4647 0.5634 0.7868 1.3372	0.01 0.02 0.02 0.04 0.11	
(3) ACU-A20-N	A	From Leg	4.0000 0.00 0.00	0.0000	148.0000	No Ice 0.0778 1/2" 0.1210 Ice 0.1728 1" Ice 0.3025 2" Ice 0.6654 4" Ice 0.8015	0.1361 0.1890 0.2506 0.3997 0.8015	0.00 0.00 0.00 0.01 0.04	
APXVSP18-C-A20 w/ Mount Pipe	A	From Leg	4.0000 0.00 -1.00	30.0000	148.0000	No Ice 8.4975 1/2" 9.1490 Ice 9.7672 1" Ice 11.0311 2" Ice 13.6786 4" Ice 14.8507	6.9458 8.1266 9.0212 10.8440 14.8507	0.08 0.15 0.23 0.41 0.91	
800 EXTERNAL NOTCH FILTER	B	From Leg	4.0000 0.00 -1.00	0.0000	148.0000	No Ice 0.7701 1/2" 0.8898 Ice 1.0181 1" Ice 1.3007 2" Ice 1.9696 4" Ice 1.3372	0.3747 0.4647 0.5634 0.7868 1.3372	0.01 0.02 0.02 0.04 0.11	
(3) ACU-A20-N	B	From Leg	4.0000 0.00 0.00	0.0000	148.0000	No Ice 0.0778 1/2" 0.1210 Ice 0.1728 1" Ice 0.3025 2" Ice 0.6654 4" Ice 0.8015	0.1361 0.1890 0.2506 0.3997 0.8015	0.00 0.00 0.00 0.01 0.04	
APXVSP18-C-A20 w/ Mount Pipe	B	From Leg	4.0000 0.00 -1.00	70.0000	148.0000	No Ice 8.4975 1/2" 9.1490 Ice 9.7672 1" Ice 11.0311 2" Ice 13.6786 4" Ice 14.8507	6.9458 8.1266 9.0212 10.8440 14.8507	0.08 0.15 0.23 0.41 0.91	
800 EXTERNAL NOTCH FILTER	C	From Leg	4.0000 0.00 -1.00	0.0000	148.0000	No Ice 0.7701 1/2" 0.8898 Ice 1.0181 1" Ice 1.3007 2" Ice 1.9696 4" Ice 1.3372	0.3747 0.4647 0.5634 0.7868 1.3372	0.01 0.02 0.02 0.04 0.11	
(3) ACU-A20-N	C	From Leg	4.0000 0.00 0.00	0.0000	148.0000	No Ice 0.0778 1/2" 0.1210 Ice 0.1728 1" Ice 0.3025 2" Ice 0.6654 4" Ice 0.8015	0.1361 0.1890 0.2506 0.3997 0.8015	0.00 0.00 0.00 0.01 0.04	
APXVSP18-C-A20 w/ Mount Pipe	C	From Leg	4.0000 0.00 -1.00	30.0000	148.0000	No Ice 8.4975 1/2" 9.1490 Ice 9.7672 1" Ice 11.0311 2" Ice 13.6786 4" Ice 14.8507	6.9458 8.1266 9.0212 10.8440 14.8507	0.08 0.15 0.23 0.41 0.91	
6' x 2" Mount Pipe	A	From Leg	4.0000 0.00 0.00	0.0000	148.0000	No Ice 1.4250 1/2" 1.9250 Ice 2.2939 1" Ice 3.0596 2" Ice 4.7022 4" Ice 4.7022	1.4250 1.9250 2.2939 3.0596 4.7022	0.02 0.03 0.05 0.09 0.23	
6' x 2" Mount Pipe	B	From Leg	4.0000 0.00 0.00	0.0000	148.0000	No Ice 1.4250 1/2" 1.9250 Ice 2.2939 1" Ice 3.0596	1.4250 1.9250 2.2939 3.0596	0.02 0.03 0.05 0.09	

Description	Face or Leg	Offset Type	Offsets: Horz Lateral Vert ft ft ft	Azimuth Adjustment	Placement ft	C <sub>A</sub> A <sub>A</sub> Front ft <sup>2</sup>	C <sub>A</sub> A <sub>A</sub> Side ft <sup>2</sup>	Weight K		
6' x 2" Mount Pipe	C	From Leg	4.0000 0.00 0.00	0.0000	148.0000	2" Ice	4.7022	4.7022	0.23	
						4" Ice				
						No Ice	1.4250	1.4250	0.02	
						1/2" Ice	1.9250	1.9250	0.03	
						Ice	2.2939	2.2939	0.05	
						1" Ice	3.0596	3.0596	0.09	
***** Pipe Mount [PM 601-3]	C	None		0.0000	150.0000	2" Ice	4.7022	4.7022	0.23	
						4" Ice				
						No Ice	4.3900	4.3900	0.20	
						1/2" Ice	5.4800	5.4800	0.24	
						Ice	6.5700	6.5700	0.28	
						1" Ice	8.7500	8.7500	0.36	
PCS 1900MHz 4x45W-65MHz	A	From Leg	4.0000 0.00 -1.00	30.0000	150.0000	2" Ice	13.1100	13.1100	0.53	
						4" Ice				
						No Ice	2.7087	2.6111	0.06	
						1/2" Ice	2.9477	2.8475	0.08	
						Ice	3.1953	3.0925	0.11	
						1" Ice	3.7164	3.6084	0.17	
TME-800MHz RRH	A	From Leg	4.0000 0.00 0.00	30.0000	150.0000	2" Ice	4.8623	4.7439	0.35	
						4" Ice				
						No Ice	2.4899	2.0685	0.05	
						1/2" Ice	2.7061	2.2705	0.07	
						Ice	2.9310	2.4812	0.10	
						1" Ice	3.4068	2.9284	0.16	
PCS 1900MHz 4x45W-65MHz	B	From Leg	4.0000 0.00 -1.00	70.0000	150.0000	2" Ice	4.4620	3.9265	0.32	
						4" Ice				
						No Ice	2.7087	2.6111	0.06	
						1/2" Ice	2.9477	2.8475	0.08	
						Ice	3.1953	3.0925	0.11	
						1" Ice	3.7164	3.6084	0.17	
TME-800MHz RRH	B	From Leg	4.0000 0.00 0.00	70.0000	150.0000	2" Ice	4.8623	4.7439	0.35	
						4" Ice				
						No Ice	2.4899	2.0685	0.05	
						1/2" Ice	2.7061	2.2705	0.07	
						Ice	2.9310	2.4812	0.10	
						1" Ice	3.4068	2.9284	0.16	
PCS 1900MHz 4x45W-65MHz	C	From Leg	4.0000 0.00 -1.00	30.0000	150.0000	2" Ice	4.4620	3.9265	0.32	
						4" Ice				
						No Ice	2.7087	2.6111	0.06	
						1/2" Ice	2.9477	2.8475	0.08	
						Ice	3.1953	3.0925	0.11	
						1" Ice	3.7164	3.6084	0.17	
TME-800MHz RRH	C	From Leg	4.0000 0.00 0.00	30.0000	150.0000	2" Ice	4.8623	4.7439	0.35	
						4" Ice				
						No Ice	2.4899	2.0685	0.05	
						1/2" Ice	2.7061	2.2705	0.07	
						Ice	2.9310	2.4812	0.10	
						1" Ice	3.4068	2.9284	0.16	
*** TD-RRH8x20-25	A	From Leg	4.0000 0.00 -1.00	0.0000	148.0000	2" Ice	4.4620	3.9265	0.32	
						4" Ice				
						No Ice	4.7198	1.7027	0.07	
						1/2" Ice	5.0138	1.9196	0.10	
						Ice	5.3165	2.1453	0.13	
						1" Ice	5.9478	2.6224	0.20	
APXVTM14-C-120 w/ Mount Pipe	A	From Leg	4.0000 0.00 -1.00	0.0000	148.0000	2" Ice	7.3141	3.6805	0.40	
						4" Ice				
						No Ice	7.1342	4.9591	0.08	
						1/2" Ice	7.6618	5.7544	0.13	
						Ice	8.1830	6.4723	0.19	
						1" Ice	9.2563	8.0099	0.34	
TD-RRH8x20-25	B	From Leg	4.0000	0.0000	148.0000	2" Ice	11.5262	11.4120	0.75	
						4" Ice				
						No Ice	4.7198	1.7027	0.07	

Description	Face or Leg	Offset Type	Offsets:		Azimuth Adjustment	Placement	C <sub>A</sub> A <sub>A</sub> Front	C <sub>A</sub> A <sub>A</sub> Side	Weight
			Horz	Vert					
			ft	ft	°	ft	ft <sup>2</sup>	ft <sup>2</sup>	K
				0.00		1/2"	5.0138	1.9196	0.10
				-1.00		Ice	5.3165	2.1453	0.13
						1" Ice	5.9478	2.6224	0.20
						2" Ice	7.3141	3.6805	0.40
						4" Ice			
APXVTM14-C-120 w/ Mount Pipe	B	From Leg	4.0000	0.0000	148.0000	No Ice	7.1342	4.9591	0.08
			0.00			1/2"	7.6618	5.7544	0.13
			-1.00			Ice	8.1830	6.4723	0.19
						1" Ice	9.2563	8.0099	0.34
						2" Ice	11.5262	11.4120	0.75
						4" Ice			
TD-RRH8x20-25	C	From Leg	4.0000	0.0000	148.0000	No Ice	4.7198	1.7027	0.07
			0.00			1/2"	5.0138	1.9196	0.10
			-1.00			Ice	5.3165	2.1453	0.13
						1" Ice	5.9478	2.6224	0.20
						2" Ice	7.3141	3.6805	0.40
						4" Ice			
APXVTM14-C-120 w/ Mount Pipe	C	From Leg	4.0000	0.0000	148.0000	No Ice	7.1342	4.9591	0.08
			0.00			1/2"	7.6618	5.7544	0.13
			-1.00			Ice	8.1830	6.4723	0.19
						1" Ice	9.2563	8.0099	0.34
						2" Ice	11.5262	11.4120	0.75
						4" Ice			
***									
RRH2X40-AWS	A	From Leg	4.0000	0.0000	167.0000	No Ice	2.9764	1.5960	0.04
			0.00			1/2"	3.2363	1.8239	0.06
			1.00			Ice	3.5048	2.0605	0.08
						1" Ice	4.0678	2.5596	0.14
						2" Ice	5.2975	3.6614	0.29
						4" Ice			
BXA-171063-8CF-EDIN-X w/ Mount Pipe	A	From Leg	4.0000	0.0000	167.0000	No Ice	3.1574	3.3303	0.03
			0.00			1/2"	3.5312	3.9423	0.06
			1.00			Ice	3.9415	4.5633	0.10
						1" Ice	4.8273	5.8553	0.19
						2" Ice	6.7342	8.8407	0.48
						4" Ice			
DB-T1-6Z-8AB-OZ	A	From Leg	4.0000	0.0000	167.0000	No Ice	5.6000	2.3333	0.04
			0.00			1/2"	5.9154	2.5580	0.08
			1.00			Ice	6.2395	2.7914	0.12
						1" Ice	6.9136	3.2840	0.21
						2" Ice	8.3654	4.3728	0.45
						4" Ice			
RRH2X40-AWS	B	From Leg	4.0000	0.0000	167.0000	No Ice	2.9764	1.5960	0.04
			0.00			1/2"	3.2363	1.8239	0.06
			1.00			Ice	3.5048	2.0605	0.08
						1" Ice	4.0678	2.5596	0.14
						2" Ice	5.2975	3.6614	0.29
						4" Ice			
BXA-171063-8CF-EDIN-X w/ Mount Pipe	B	From Leg	4.0000	0.0000	167.0000	No Ice	3.1574	3.3303	0.03
			0.00			1/2"	3.5312	3.9423	0.06
			1.00			Ice	3.9415	4.5633	0.10
						1" Ice	4.8273	5.8553	0.19
						2" Ice	6.7342	8.8407	0.48
						4" Ice			
RRH2X40-AWS	C	From Leg	4.0000	0.0000	167.0000	No Ice	2.9764	1.5960	0.04
			0.00			1/2"	3.2363	1.8239	0.06
			1.00			Ice	3.5048	2.0605	0.08
						1" Ice	4.0678	2.5596	0.14
						2" Ice	5.2975	3.6614	0.29
						4" Ice			
BXA-171063-8CF-EDIN-X w/ Mount Pipe	C	From Leg	4.0000	0.0000	167.0000	No Ice	3.1574	3.3303	0.03
			0.00			1/2"	3.5312	3.9423	0.06
			1.00			Ice	3.9415	4.5633	0.10
						1" Ice	4.8273	5.8553	0.19
						2" Ice	6.7342	8.8407	0.48
						4" Ice			

Description	Face or Leg	Offset Type	Offsets: Horz Lateral Vert ft ft ft	Azimuth Adjustment	Placement ft	C <sub>A</sub> A <sub>A</sub> Front ft <sup>2</sup>	C <sub>A</sub> A <sub>A</sub> Side ft <sup>2</sup>	Weight K
4" Ice								

**Tower Forces - No Ice - Wind Normal To Face**

Section Elevation ft	Add Weight K	Self Weight K	F a c e	e	C <sub>F</sub>	R <sub>R</sub>	D <sub>F</sub>	D <sub>R</sub>	A <sub>E</sub> ft <sup>2</sup>	F K	w plf	Ctrl. Face
L1 167.0000-118.2500	2.04	3.87	A	1	0.65	1	1	1	120.575	4.31	88.35	C
			B	1	0.65	1	1	1	120.575			
			C	1	0.65	1	1	1	120.575			
L2 118.2500-90.5000	1.81	4.06	A	1	0.65	1	1	1	88.093	2.98	107.43	C
			B	1	0.65	1	1	1	88.093			
			C	1	0.65	1	1	1	88.093			
L3 90.5000-77.7500	0.83	2.23	A	1	0.65	1	1	1	45.490	1.51	118.71	C
			B	1	0.65	1	1	1	45.490			
			C	1	0.65	1	1	1	45.490			
L4 77.7500-63.5000	0.93	3.54	A	1	0.65	1	1	1	53.773	1.60	112.00	C
			B	1	0.65	1	1	1	53.773			
			C	1	0.65	1	1	1	53.773			
L5 63.5000-51.5000	0.78	2.86	A	1	0.65	1	1	1	48.388	1.45	120.60	C
			B	1	0.65	1	1	1	48.388			
			C	1	0.65	1	1	1	48.388			
L6 51.5000-45.0000	0.42	1.61	A	1	0.65	1	1	1	27.377	0.77	118.79	C
			B	1	0.65	1	1	1	27.377			
			C	1	0.65	1	1	1	27.377			
L7 45.0000-0.0000	2.93	11.85	A	1	0.65	1	1	1	210.635	4.87	108.33	C
			B	1	0.65	1	1	1	210.635			
			C	1	0.65	1	1	1	210.635			
Sum Weight:	9.74	30.02						OTM	1385.64 kip-ft	17.49		

**Tower Forces - No Ice - Wind 60 To Face**

Section Elevation ft	Add Weight K	Self Weight K	F a c e	e	C <sub>F</sub>	R <sub>R</sub>	D <sub>F</sub>	D <sub>R</sub>	A <sub>E</sub> ft <sup>2</sup>	F K	w plf	Ctrl. Face
L1 167.0000-118.2500	2.04	3.87	A	1	0.65	1	1	1	120.575	4.31	88.35	C
			B	1	0.65	1	1	1	120.575			
			C	1	0.65	1	1	1	120.575			
L2 118.2500-90.5000	1.81	4.06	A	1	0.65	1	1	1	88.093	2.98	107.43	C
			B	1	0.65	1	1	1	88.093			
			C	1	0.65	1	1	1	88.093			
L3 90.5000-77.7500	0.83	2.23	A	1	0.65	1	1	1	45.490	1.51	118.71	C
			B	1	0.65	1	1	1	45.490			
			C	1	0.65	1	1	1	45.490			
L4 77.7500-63.5000	0.93	3.54	A	1	0.65	1	1	1	53.773	1.60	112.00	C
			B	1	0.65	1	1	1	53.773			
			C	1	0.65	1	1	1	53.773			
L5 63.5000-51.5000	0.78	2.86	A	1	0.65	1	1	1	48.388	1.45	120.60	C
			B	1	0.65	1	1	1	48.388			
			C	1	0.65	1	1	1	48.388			
L6 51.5000-45.0000	0.42	1.61	A	1	0.65	1	1	1	27.377	0.77	118.79	C
			B	1	0.65	1	1	1	27.377			



Section Elevation ft	Add Weight K	Self Weight K	Face	e	C <sub>F</sub>	R <sub>R</sub>	D <sub>F</sub>	D <sub>R</sub>	A <sub>E</sub> ft <sup>2</sup>	F K	w plf	Ctrl. Face
L7 45.0000-0.0000	2.93	11.85	C	1	0.65	1	1	1	27.377	4.87	108.33	C
			A	1	0.65	1	1	1	210.635			
			B	1	0.65	1	1	1	210.635			
			C	1	0.65	1	1	1	210.635			
Sum Weight:	9.74	30.02						OTM	1385.64 kip-ft	17.49		

**Tower Forces - No Ice - Wind 90 To Face**

Section Elevation ft	Add Weight K	Self Weight K	Face	e	C <sub>F</sub>	R <sub>R</sub>	D <sub>F</sub>	D <sub>R</sub>	A <sub>E</sub> ft <sup>2</sup>	F K	w plf	Ctrl. Face
L1 167.0000-118.2500	2.04	3.87	A	1	0.65	1	1	1	120.575	4.31	88.35	C
			B	1	0.65	1	1	1	120.575			
			C	1	0.65	1	1	1	120.575			
L2 118.2500-90.5000	1.81	4.06	A	1	0.65	1	1	1	88.093	2.98	107.43	C
			B	1	0.65	1	1	1	88.093			
			C	1	0.65	1	1	1	88.093			
L3 90.5000-77.7500	0.83	2.23	A	1	0.65	1	1	1	45.490	1.51	118.71	C
			B	1	0.65	1	1	1	45.490			
			C	1	0.65	1	1	1	45.490			
L4 77.7500-63.5000	0.93	3.54	A	1	0.65	1	1	1	53.773	1.60	112.00	C
			B	1	0.65	1	1	1	53.773			
			C	1	0.65	1	1	1	53.773			
L5 63.5000-51.5000	0.78	2.86	A	1	0.65	1	1	1	48.388	1.45	120.60	C
			B	1	0.65	1	1	1	48.388			
			C	1	0.65	1	1	1	48.388			
L6 51.5000-45.0000	0.42	1.61	A	1	0.65	1	1	1	27.377	0.77	118.79	C
			B	1	0.65	1	1	1	27.377			
			C	1	0.65	1	1	1	27.377			
L7 45.0000-0.0000	2.93	11.85	A	1	0.65	1	1	1	210.635	4.87	108.33	C
			B	1	0.65	1	1	1	210.635			
			C	1	0.65	1	1	1	210.635			
Sum Weight:	9.74	30.02						OTM	1385.64 kip-ft			

**Tower Forces - With Ice - Wind Normal To Face**

Section Elevation ft	Add Weight K	Self Weight K	Face	e	C <sub>F</sub>	R <sub>R</sub>	D <sub>F</sub>	D <sub>R</sub>	A <sub>E</sub> ft <sup>2</sup>	F K	w plf	Ctrl. Face
L1 167.0000-118.2500	3.43	5.52	A	1	0.65	1	1	1	127.831	1.00	20.51	C
			B	1	0.65	1	1	1	127.831			
			C	1	0.65	1	1	1	127.831			
L2 118.2500-90.5000	3.38	5.20	A	1	0.65	1	1	1	92.223	0.69	24.94	C
			B	1	0.65	1	1	1	92.223			
			C	1	0.65	1	1	1	92.223			
L3 90.5000-77.7500	1.50	2.81	A	1	0.65	1	1	1	47.273	0.35	27.69	C
			B	1	0.65	1	1	1	47.273			
			C	1	0.65	1	1	1	47.273			
L4 77.7500-63.5000	1.68	4.21	A	1	0.65	1	1	1	55.766	0.36	25.31	C
			B	1	0.65	1	1	1	55.766			
			C	1	0.65	1	1	1	55.766			
L5 63.5000-51.5000	1.38	3.44	A	1	0.65	1	1	1	49.991	0.33	27.79	C
			B	1	0.65	1	1	1	49.991			
			C	1	0.65	1	1	1	49.991			
L6 51.5000-45.0000	0.74	1.93	A	1	0.65	1	1	1	28.227	0.18	27.15	C
			B	1	0.65	1	1	1	28.227			

Section Elevation ft	Add Weight K	Self Weight K	Face	e	C <sub>F</sub>	R <sub>R</sub>	D <sub>F</sub>	D <sub>R</sub>	A <sub>E</sub> ft <sup>2</sup>	F K	w plf	Ctrl. Face
L7 45.0000-0.0000	4.99	14.22	C	1	0.65	1	1	1	28.227	1.06	23.58	C
			A	1	0.65	1	1	1	216.260			
			B	1	0.65	1	1	1	216.260			
			C	1	0.65	1	1	1	216.260			
Sum Weight:	17.09	37.33						OTM	319.26 kip-ft	3.98		

**Tower Forces - With Ice - Wind 60 To Face**

Section Elevation ft	Add Weight K	Self Weight K	Face	e	C <sub>F</sub>	R <sub>R</sub>	D <sub>F</sub>	D <sub>R</sub>	A <sub>E</sub> ft <sup>2</sup>	F K	w plf	Ctrl. Face
L1 167.0000-118.2500	3.43	5.52	A	1	0.65	1	1	1	127.831	1.00	20.51	C
			B	1	0.65	1	1	1	127.831			
			C	1	0.65	1	1	1	127.831			
L2 118.2500-90.5000	3.38	5.20	A	1	0.65	1	1	1	92.223	0.69	24.94	C
			B	1	0.65	1	1	1	92.223			
			C	1	0.65	1	1	1	92.223			
L3 90.5000-77.7500	1.50	2.81	A	1	0.65	1	1	1	47.273	0.35	27.69	C
			B	1	0.65	1	1	1	47.273			
			C	1	0.65	1	1	1	47.273			
L4 77.7500-63.5000	1.68	4.21	A	1	0.65	1	1	1	55.766	0.36	25.31	C
			B	1	0.65	1	1	1	55.766			
			C	1	0.65	1	1	1	55.766			
L5 63.5000-51.5000	1.38	3.44	A	1	0.65	1	1	1	49.991	0.33	27.79	C
			B	1	0.65	1	1	1	49.991			
			C	1	0.65	1	1	1	49.991			
L6 51.5000-45.0000	0.74	1.93	A	1	0.65	1	1	1	28.227	0.18	27.15	C
			B	1	0.65	1	1	1	28.227			
			C	1	0.65	1	1	1	28.227			
L7 45.0000-0.0000	4.99	14.22	A	1	0.65	1	1	1	216.260	1.06	23.58	C
			B	1	0.65	1	1	1	216.260			
			C	1	0.65	1	1	1	216.260			
Sum Weight:	17.09	37.33						OTM	319.26 kip-ft			

**Tower Forces - With Ice - Wind 90 To Face**

Section Elevation ft	Add Weight K	Self Weight K	Face	e	C <sub>F</sub>	R <sub>R</sub>	D <sub>F</sub>	D <sub>R</sub>	A <sub>E</sub> ft <sup>2</sup>	F K	w plf	Ctrl. Face
L1 167.0000-118.2500	3.43	5.52	A	1	0.65	1	1	1	127.831	1.00	20.51	C
			B	1	0.65	1	1	1	127.831			
			C	1	0.65	1	1	1	127.831			
L2 118.2500-90.5000	3.38	5.20	A	1	0.65	1	1	1	92.223	0.69	24.94	C
			B	1	0.65	1	1	1	92.223			
			C	1	0.65	1	1	1	92.223			
L3 90.5000-77.7500	1.50	2.81	A	1	0.65	1	1	1	47.273	0.35	27.69	C
			B	1	0.65	1	1	1	47.273			
			C	1	0.65	1	1	1	47.273			
L4 77.7500-63.5000	1.68	4.21	A	1	0.65	1	1	1	55.766	0.36	25.31	C
			B	1	0.65	1	1	1	55.766			
			C	1	0.65	1	1	1	55.766			
L5 63.5000-51.5000	1.38	3.44	A	1	0.65	1	1	1	49.991	0.33	27.79	C
			B	1	0.65	1	1	1	49.991			
			C	1	0.65	1	1	1	49.991			
L6 51.5000-45.0000	0.74	1.93	A	1	0.65	1	1	1	28.227	0.18	27.15	C
			B	1	0.65	1	1	1	28.227			
			C	1	0.65	1	1	1	28.227			

Section Elevation ft	Add Weight K	Self Weight K	Face	e	C <sub>F</sub>	R <sub>R</sub>	D <sub>F</sub>	D <sub>R</sub>	A <sub>E</sub> ft <sup>2</sup>	F K	w plf	Ctrl. Face
L7 45.0000-0.0000	4.99	14.22	C	1	0.65	1	1	1	28.227	1.06	23.58	C
			A	1	0.65	1	1	1	216.260			
			B	1	0.65	1	1	1	216.260			
			C	1	0.65	1	1	1	216.260			
Sum Weight:	17.09	37.33						OTM	319.26 kip-ft	3.98		

**Tower Forces - Service - Wind Normal To Face**

Section Elevation ft	Add Weight K	Self Weight K	Face	e	C <sub>F</sub>	R <sub>R</sub>	D <sub>F</sub>	D <sub>R</sub>	A <sub>E</sub> ft <sup>2</sup>	F K	w plf	Ctrl. Face
L1 167.0000-118.2500	2.04	3.87	A	1	0.65	1	1	1	120.575	1.49	30.57	C
			B	1	0.65	1	1	1	120.575			
			C	1	0.65	1	1	1	120.575			
L2 118.2500-90.5000	1.81	4.06	A	1	0.65	1	1	1	88.093	1.03	37.17	C
			B	1	0.65	1	1	1	88.093			
			C	1	0.65	1	1	1	88.093			
L3 90.5000-77.7500	0.83	2.23	A	1	0.65	1	1	1	45.490	0.52	41.07	C
			B	1	0.65	1	1	1	45.490			
			C	1	0.65	1	1	1	45.490			
L4 77.7500-63.5000	0.93	3.54	A	1	0.65	1	1	1	53.773	0.55	38.76	C
			B	1	0.65	1	1	1	53.773			
			C	1	0.65	1	1	1	53.773			
L5 63.5000-51.5000	0.78	2.86	A	1	0.65	1	1	1	48.388	0.50	41.73	C
			B	1	0.65	1	1	1	48.388			
			C	1	0.65	1	1	1	48.388			
L6 51.5000-45.0000	0.42	1.61	A	1	0.65	1	1	1	27.377	0.27	41.10	C
			B	1	0.65	1	1	1	27.377			
			C	1	0.65	1	1	1	27.377			
L7 45.0000-0.0000	2.93	11.85	A	1	0.65	1	1	1	210.635	1.69	37.49	C
			B	1	0.65	1	1	1	210.635			
			C	1	0.65	1	1	1	210.635			
Sum Weight:	9.74	30.02						OTM	479.46 kip-ft	6.05		

**Tower Forces - Service - Wind 60 To Face**

Section Elevation ft	Add Weight K	Self Weight K	Face	e	C <sub>F</sub>	R <sub>R</sub>	D <sub>F</sub>	D <sub>R</sub>	A <sub>E</sub> ft <sup>2</sup>	F K	w plf	Ctrl. Face
L1 167.0000-118.2500	2.04	3.87	A	1	0.65	1	1	1	120.575	1.49	30.57	C
			B	1	0.65	1	1	1	120.575			
			C	1	0.65	1	1	1	120.575			
L2 118.2500-90.5000	1.81	4.06	A	1	0.65	1	1	1	88.093	1.03	37.17	C
			B	1	0.65	1	1	1	88.093			
			C	1	0.65	1	1	1	88.093			
L3 90.5000-77.7500	0.83	2.23	A	1	0.65	1	1	1	45.490	0.52	41.07	C
			B	1	0.65	1	1	1	45.490			
			C	1	0.65	1	1	1	45.490			
L4 77.7500-63.5000	0.93	3.54	A	1	0.65	1	1	1	53.773	0.55	38.76	C
			B	1	0.65	1	1	1	53.773			
			C	1	0.65	1	1	1	53.773			
L5 63.5000-51.5000	0.78	2.86	A	1	0.65	1	1	1	48.388	0.50	41.73	C
			B	1	0.65	1	1	1	48.388			
			C	1	0.65	1	1	1	48.388			
L6 51.5000-45.0000	0.42	1.61	A	1	0.65	1	1	1	27.377	0.27	41.10	C
			B	1	0.65	1	1	1	27.377			

Section Elevation ft	Add Weight K	Self Weight K	Face	e	C <sub>F</sub>	R <sub>R</sub>	D <sub>F</sub>	D <sub>R</sub>	A <sub>E</sub> ft <sup>2</sup>	F K	w plf	Ctrl. Face
L7 45.0000-0.0000	2.93	11.85	C	1	0.65	1	1	1	27.377	1.69	37.49	C
			A	1	0.65	1	1	1	210.635			
			B	1	0.65	1	1	1	210.635			
			C	1	0.65	1	1	1	210.635			
Sum Weight:	9.74	30.02						OTM	479.46 kip-ft	6.05		

### Tower Forces - Service - Wind 90 To Face

Section Elevation ft	Add Weight K	Self Weight K	Face	e	C <sub>F</sub>	R <sub>R</sub>	D <sub>F</sub>	D <sub>R</sub>	A <sub>E</sub> ft <sup>2</sup>	F K	w plf	Ctrl. Face
L1 167.0000-118.2500	2.04	3.87	A	1	0.65	1	1	1	120.575	1.49	30.57	C
			B	1	0.65	1	1	1	120.575			
			C	1	0.65	1	1	1	120.575			
L2 118.2500-90.5000	1.81	4.06	A	1	0.65	1	1	1	88.093	1.03	37.17	C
			B	1	0.65	1	1	1	88.093			
			C	1	0.65	1	1	1	88.093			
L3 90.5000-77.7500	0.83	2.23	A	1	0.65	1	1	1	45.490	0.52	41.07	C
			B	1	0.65	1	1	1	45.490			
			C	1	0.65	1	1	1	45.490			
L4 77.7500-63.5000	0.93	3.54	A	1	0.65	1	1	1	53.773	0.55	38.76	C
			B	1	0.65	1	1	1	53.773			
			C	1	0.65	1	1	1	53.773			
L5 63.5000-51.5000	0.78	2.86	A	1	0.65	1	1	1	48.388	0.50	41.73	C
			B	1	0.65	1	1	1	48.388			
			C	1	0.65	1	1	1	48.388			
L6 51.5000-45.0000	0.42	1.61	A	1	0.65	1	1	1	27.377	0.27	41.10	C
			B	1	0.65	1	1	1	27.377			
			C	1	0.65	1	1	1	27.377			
L7 45.0000-0.0000	2.93	11.85	A	1	0.65	1	1	1	210.635	1.69	37.49	C
			B	1	0.65	1	1	1	210.635			
			C	1	0.65	1	1	1	210.635			
Sum Weight:	9.74	30.02						OTM	479.46 kip-ft			

### Load Combinations

Comb. No.	Description
1	Dead Only
2	Dead+Wind 0 deg - No Ice
3	Dead+Wind 30 deg - No Ice
4	Dead+Wind 60 deg - No Ice
5	Dead+Wind 90 deg - No Ice
6	Dead+Wind 120 deg - No Ice
7	Dead+Wind 150 deg - No Ice
8	Dead+Wind 180 deg - No Ice
9	Dead+Wind 210 deg - No Ice
10	Dead+Wind 240 deg - No Ice
11	Dead+Wind 270 deg - No Ice
12	Dead+Wind 300 deg - No Ice
13	Dead+Wind 330 deg - No Ice
14	Dead+Ice+Temp
15	Dead+Wind 0 deg+Ice+Temp
16	Dead+Wind 30 deg+Ice+Temp
17	Dead+Wind 60 deg+Ice+Temp
18	Dead+Wind 90 deg+Ice+Temp
19	Dead+Wind 120 deg+Ice+Temp

Comb. No.	Description
20	Dead+Wind 150 deg+Ice+Temp
21	Dead+Wind 180 deg+Ice+Temp
22	Dead+Wind 210 deg+Ice+Temp
23	Dead+Wind 240 deg+Ice+Temp
24	Dead+Wind 270 deg+Ice+Temp
25	Dead+Wind 300 deg+Ice+Temp
26	Dead+Wind 330 deg+Ice+Temp
27	Dead+Wind 0 deg - Service
28	Dead+Wind 30 deg - Service
29	Dead+Wind 60 deg - Service
30	Dead+Wind 90 deg - Service
31	Dead+Wind 120 deg - Service
32	Dead+Wind 150 deg - Service
33	Dead+Wind 180 deg - Service
34	Dead+Wind 210 deg - Service
35	Dead+Wind 240 deg - Service
36	Dead+Wind 270 deg - Service
37	Dead+Wind 300 deg - Service
38	Dead+Wind 330 deg - Service

### Maximum Member Forces

Section No.	Elevation ft	Component Type	Condition	Gov. Load Comb.	Force K	Major Axis Moment kip-ft	Minor Axis Moment kip-ft
L1	167 - 118.25	Pole	Max Tension	1	0.00	0.00	0.00
			Max. Compression	14	-25.13	2.19	-0.32
			Max. Mx	11	-12.17	812.38	-1.67
			Max. My	8	-12.13	2.16	-820.54
			Max. Vy	11	-25.82	812.38	-1.67
			Max. Vx	8	26.03	2.16	-820.54
			Max. Torque	11			-1.29
L2	118.25 - 90.5	Pole	Max Tension	1	0.00	0.00	0.00
			Max. Compression	14	-35.47	5.44	-2.17
			Max. Mx	11	-19.45	1727.47	-4.08
			Max. My	8	-19.42	4.90	-1742.28
			Max. Vy	11	-30.19	1727.47	-4.08
			Max. Vx	8	30.41	4.90	-1742.28
			Max. Torque	11			-1.02
L3	90.5 - 77.75	Pole	Max Tension	1	0.00	0.00	0.00
			Max. Compression	14	-37.90	6.26	-2.64
			Max. Mx	11	-21.30	1949.44	-4.64
			Max. My	8	-21.28	5.55	-1965.73
			Max. Vy	11	-31.02	1949.44	-4.64
			Max. Vx	8	31.23	5.55	-1965.73
			Max. Torque	11			-0.95
L4	77.75 - 63.5	Pole	Max Tension	1	0.00	0.00	0.00
			Max. Compression	14	-45.92	8.61	-3.98
			Max. Mx	11	-27.46	2585.20	-6.18
			Max. My	8	-27.44	7.33	-2605.51
			Max. Vy	11	-33.21	2585.20	-6.18
			Max. Vx	8	33.43	7.33	-2605.51
			Max. Torque	11			-0.90
L5	63.5 - 51.5	Pole	Max Tension	1	0.00	0.00	0.00
			Max. Compression	14	-50.73	10.07	-4.82
			Max. Mx	11	-31.32	2991.95	-7.13
			Max. My	8	-31.30	8.44	-3014.69
			Max. Vy	11	-34.55	2991.95	-7.13
			Max. Vx	8	34.77	8.44	-3014.69
			Max. Torque	11			-0.86
L6	51.5 - 45	Pole	Max Tension	1	0.00	0.00	0.00
			Max. Compression	14	-53.40	10.88	-5.29
			Max. Mx	11	-33.47	3218.93	-7.65
			Max. My	8	-33.46	9.04	-3242.97
			Max. Vy	11	-35.25	3218.93	-7.65
			Max. Vx	8	35.46	9.04	-3242.97
			Max. Torque	11			

Section No.	Elevation ft	Component Type	Condition	Gov. Load Comb.	Force K	Major Axis Moment kip-ft	Minor Axis Moment kip-ft
L7	45 - 0	Pole	Max. Torque	11			-0.81
			Max Tension	1	0.00	0.00	0.00
			Max. Compression	14	-72.61	16.59	-8.58
			Max. Mx	11	-49.27	4892.91	-11.29
			Max. My	8	-49.27	13.33	-4925.76
			Max. Vy	11	-39.14	4892.91	-11.29
			Max. Vx	8	39.35	13.33	-4925.76
			Max. Torque	4			0.81

### Maximum Reactions

Location	Condition	Gov. Load Comb.	Vertical K	Horizontal, X K	Horizontal, Z K
Pole	Max. Vert	22	72.61	4.67	-8.11
	Max. H <sub>x</sub>	11	49.30	39.10	-0.06
	Max. H <sub>z</sub>	2	49.30	-0.06	39.31
	Max. M <sub>x</sub>	2	4921.56	-0.06	39.31
	Max. M <sub>z</sub>	5	4884.62	-39.10	0.06
	Max. Torsion	4	0.81	-33.90	19.71
	Min. Vert	1	49.30	0.00	0.00
	Min. H <sub>x</sub>	5	49.30	-39.10	0.06
	Min. H <sub>z</sub>	8	49.30	0.06	-39.31
	Min. M <sub>x</sub>	8	-4925.76	0.06	-39.31
	Min. M <sub>z</sub>	11	-4892.91	39.10	-0.06
	Min. Torsion	10	-0.80	33.90	-19.71

### Tower Mast Reaction Summary

Load Combination	Vertical K	Shear <sub>x</sub> K	Shear <sub>z</sub> K	Overtuning Moment, M <sub>x</sub> kip-ft	Overtuning Moment, M <sub>z</sub> kip-ft	Torque kip-ft
Dead Only	49.30	0.00	0.00	2.05	4.03	0.00
Dead+Wind 0 deg - No Ice	49.30	0.06	-39.31	-4921.56	-5.02	-0.47
Dead+Wind 30 deg - No Ice	49.30	19.60	-34.07	-4266.52	-2448.11	-0.74
Dead+Wind 60 deg - No Ice	49.30	33.90	-19.71	-2467.72	-4234.19	-0.81
Dead+Wind 90 deg - No Ice	49.30	39.10	-0.06	-7.06	-4884.62	-0.66
Dead+Wind 120 deg - No Ice	49.30	33.84	19.60	2456.08	-4225.06	-0.33
Dead+Wind 150 deg - No Ice	49.30	19.50	34.01	4261.61	-2432.24	0.08
Dead+Wind 180 deg - No Ice	49.30	-0.06	39.31	4925.76	13.33	0.46
Dead+Wind 210 deg - No Ice	49.30	-19.60	34.07	4270.71	2456.40	0.73
Dead+Wind 240 deg - No Ice	49.30	-33.90	19.71	2471.93	4242.47	0.80
Dead+Wind 270 deg - No Ice	49.30	-39.10	0.06	11.29	4892.91	0.67
Dead+Wind 300 deg - No Ice	49.30	-33.84	-19.60	-2451.85	4233.36	0.35
Dead+Wind 330 deg - No Ice	49.30	-19.50	-34.01	-4257.39	2440.56	-0.07
Dead+Ice+Temp	72.61	-0.00	0.00	8.58	16.59	0.00
Dead+Wind 0 deg+Ice+Temp	72.61	0.01	-9.36	-1212.99	15.49	-0.23
Dead+Wind 30 deg+Ice+Temp	72.61	4.67	-8.11	-1049.93	-591.71	-0.27
Dead+Wind 60 deg+Ice+Temp	72.61	8.07	-4.69	-603.23	-1035.90	-0.23
Dead+Wind 90 deg+Ice+Temp	72.61	9.32	-0.01	7.43	-1198.04	-0.13
Dead+Wind 120 deg+Ice+Temp	72.61	8.07	4.67	618.41	-1034.69	0.00
Dead+Wind 150 deg+Ice+Temp	72.61	4.65	8.10	1066.00	-589.62	0.13
Dead+Wind 180 deg+Ice+Temp	72.61	-0.01	9.36	1230.27	17.91	0.23
Dead+Wind 210 deg+Ice+Temp	72.61	-4.67	8.11	1067.20	625.11	0.27

Load Combination	Vertical K	Shear <sub>x</sub> K	Shear <sub>z</sub> K	Overturning Moment, M <sub>x</sub> kip-ft	Overturning Moment, M <sub>z</sub> kip-ft	Torque kip-ft
deg+Ice+Temp						
Dead+Wind 240	72.61	-8.07	4.69	620.50	1069.29	0.23
deg+Ice+Temp						
Dead+Wind 270	72.61	-9.32	0.01	9.85	1231.43	0.13
deg+Ice+Temp						
Dead+Wind 300	72.61	-8.07	-4.67	-601.13	1068.08	-0.00
deg+Ice+Temp						
Dead+Wind 330	72.61	-4.65	-8.10	-1048.72	623.02	-0.13
deg+Ice+Temp						
Dead+Wind 0 deg - Service	49.30	0.02	-13.60	-1704.51	0.98	-0.16
Dead+Wind 30 deg - Service	49.30	6.78	-11.79	-1477.46	-845.82	-0.26
Dead+Wind 60 deg - Service	49.30	11.73	-6.82	-853.96	-1464.88	-0.28
Dead+Wind 90 deg - Service	49.30	13.53	-0.02	-1.07	-1690.30	-0.23
Dead+Wind 120 deg - Service	49.30	11.71	6.78	852.67	-1461.70	-0.12
Dead+Wind 150 deg - Service	49.30	6.75	11.77	1478.50	-840.31	0.02
Dead+Wind 180 deg - Service	49.30	-0.02	13.60	1708.72	7.34	0.16
Dead+Wind 210 deg - Service	49.30	-6.78	11.79	1481.67	854.15	0.26
Dead+Wind 240 deg - Service	49.30	-11.73	6.82	858.17	1473.20	0.28
Dead+Wind 270 deg - Service	49.30	-13.53	0.02	5.29	1698.63	0.23
Dead+Wind 300 deg - Service	49.30	-11.71	-6.78	-848.45	1470.03	0.12
Dead+Wind 330 deg - Service	49.30	-6.75	-11.77	-1474.28	848.64	-0.02

### Solution Summary

Load Comb.	Sum of Applied Forces			Sum of Reactions			% Error
	PX K	PY K	PZ K	PX K	PY K	PZ K	
1	0.00	-49.30	0.00	0.00	49.30	0.00	0.000%
2	0.06	-49.30	-39.31	-0.06	49.30	39.31	0.000%
3	19.60	-49.30	-34.07	-19.60	49.30	34.07	0.000%
4	33.90	-49.30	-19.71	-33.90	49.30	19.71	0.000%
5	39.10	-49.30	-0.06	-39.10	49.30	0.06	0.000%
6	33.84	-49.30	19.60	-33.84	49.30	-19.60	0.000%
7	19.50	-49.30	34.01	-19.50	49.30	-34.01	0.000%
8	-0.06	-49.30	39.31	0.06	49.30	-39.31	0.000%
9	-19.60	-49.30	34.07	19.60	49.30	-34.07	0.000%
10	-33.90	-49.30	19.71	33.90	49.30	-19.71	0.000%
11	-39.10	-49.30	0.06	39.10	49.30	-0.06	0.000%
12	-33.84	-49.30	-19.60	33.84	49.30	19.60	0.000%
13	-19.50	-49.30	-34.01	19.50	49.30	34.01	0.000%
14	0.00	-72.61	0.00	0.00	72.61	-0.00	0.000%
15	0.01	-72.61	-9.36	-0.01	72.61	9.36	0.000%
16	4.67	-72.61	-8.11	-4.67	72.61	8.11	0.000%
17	8.07	-72.61	-4.69	-8.07	72.61	4.69	0.000%
18	9.32	-72.61	-0.01	-9.32	72.61	0.01	0.000%
19	8.07	-72.61	4.67	-8.07	72.61	-4.67	0.000%
20	4.65	-72.61	8.10	-4.65	72.61	-8.10	0.000%
21	-0.01	-72.61	9.36	0.01	72.61	-9.36	0.000%
22	-4.67	-72.61	8.11	4.67	72.61	-8.11	0.000%
23	-8.07	-72.61	4.69	8.07	72.61	-4.69	0.000%
24	-9.32	-72.61	0.01	9.32	72.61	-0.01	0.000%
25	-8.07	-72.61	-4.67	8.07	72.61	4.67	0.000%
26	-4.65	-72.61	-8.10	4.65	72.61	8.10	0.000%
27	0.02	-49.30	-13.60	-0.02	49.30	13.60	0.000%
28	6.78	-49.30	-11.79	-6.78	49.30	11.79	0.000%
29	11.73	-49.30	-6.82	-11.73	49.30	6.82	0.000%
30	13.53	-49.30	-0.02	-13.53	49.30	0.02	0.000%
31	11.71	-49.30	6.78	-11.71	49.30	-6.78	0.000%

Load Comb.	Sum of Applied Forces			Sum of Reactions			% Error
	PX K	PY K	PZ K	PX K	PY K	PZ K	
32	6.75	-49.30	11.77	-6.75	49.30	-11.77	0.000%
33	-0.02	-49.30	13.60	0.02	49.30	-13.60	0.000%
34	-6.78	-49.30	11.79	6.78	49.30	-11.79	0.000%
35	-11.73	-49.30	6.82	11.73	49.30	-6.82	0.000%
36	-13.53	-49.30	0.02	13.53	49.30	-0.02	0.000%
37	-11.71	-49.30	-6.78	11.71	49.30	6.78	0.000%
38	-6.75	-49.30	-11.77	6.75	49.30	11.77	0.000%

### Non-Linear Convergence Results

Load Combination	Converged?	Number of Cycles	Displacement Tolerance	Force Tolerance
1	Yes	4	0.00000001	0.00000001
2	Yes	4	0.00000001	0.00056230
3	Yes	6	0.00000001	0.0005509
4	Yes	6	0.00000001	0.0005604
5	Yes	4	0.00000001	0.00096555
6	Yes	6	0.00000001	0.0005486
7	Yes	6	0.00000001	0.0005541
8	Yes	4	0.00000001	0.00070790
9	Yes	6	0.00000001	0.0005605
10	Yes	6	0.00000001	0.0005511
11	Yes	4	0.00000001	0.00068671
12	Yes	6	0.00000001	0.0005573
13	Yes	6	0.00000001	0.0005516
14	Yes	4	0.00000001	0.00014458
15	Yes	5	0.00000001	0.00073370
16	Yes	5	0.00000001	0.00084362
17	Yes	5	0.00000001	0.00084274
18	Yes	5	0.00000001	0.00072346
19	Yes	5	0.00000001	0.00084825
20	Yes	5	0.00000001	0.00085129
21	Yes	5	0.00000001	0.00074171
22	Yes	5	0.00000001	0.00087471
23	Yes	5	0.00000001	0.00087121
24	Yes	5	0.00000001	0.00074210
25	Yes	5	0.00000001	0.00086119
26	Yes	5	0.00000001	0.00086237
27	Yes	4	0.00000001	0.00031549
28	Yes	5	0.00000001	0.00013574
29	Yes	5	0.00000001	0.00013961
30	Yes	4	0.00000001	0.00033610
31	Yes	5	0.00000001	0.00013446
32	Yes	5	0.00000001	0.00013721
33	Yes	4	0.00000001	0.00031991
34	Yes	5	0.00000001	0.00014130
35	Yes	5	0.00000001	0.00013661
36	Yes	4	0.00000001	0.00032879
37	Yes	5	0.00000001	0.00013867
38	Yes	5	0.00000001	0.00013670

### Maximum Tower Deflections - Service Wind

Section No.	Elevation ft	Horz. Deflection in	Gov. Load Comb.	Tilt	Twist
L1	167 - 118.25	42.158	34	2.3365	0.0035
L2	122.75 - 90.5	22.110	34	1.8349	0.0010
L3	90.5 - 77.75	11.521	34	1.2559	0.0005
L4	83.25 - 63.5	9.705	34	1.1370	0.0004



Section No.	Elevation ft	Horz. Deflection in	Gov. Load Comb.	Tilt °	Twist °
L5	63.5 - 51.5	5.535	34	0.8454	0.0002
L6	51.5 - 45	3.817	34	0.6814	0.0002
L7	45 - 0	2.749	34	0.5941	0.0002

### Critical Deflections and Radius of Curvature - Service Wind

Elevation ft	Appurtenance	Gov. Load Comb.	Deflection in	Tilt °	Twist °	Radius of Curvature ft
167.0000	Lightning Rod 5/8x4'	34	42.158	2.3365	0.0035	26295
158.0000	(2) 7770.00 w/ Mount Pipe	34	37.823	2.2541	0.0029	14608
156.0000	(2) RRUS-11	34	36.867	2.2353	0.0028	11952
150.0000	Pipe Mount [PM 601-3]	34	34.024	2.1768	0.0024	7733
148.0000	Platform Mount [LP 712-1]	34	33.088	2.1564	0.0023	6919
138.0000	APX16PV-16PVL-E w/ Mount Pipe	34	28.526	2.0454	0.0017	4532
120.0000	APXV18-206517S-C w/ Mount Pipe	34	21.044	1.7901	0.0010	2976

### Maximum Tower Deflections - Design Wind

Section No.	Elevation ft	Horz. Deflection in	Gov. Load Comb.	Tilt °	Twist °
L1	167 - 118.25	121.202	8	6.7240	0.0099
L2	122.75 - 90.5	63.607	8	5.2797	0.0030
L3	90.5 - 77.75	33.161	8	3.6150	0.0013
L4	83.25 - 63.5	27.935	8	3.2732	0.0011
L5	63.5 - 51.5	15.936	9	2.4342	0.0007
L6	51.5 - 45	10.417	9	1.9622	0.0005
L7	45 - 0	7.918	9	1.7110	0.0004

### Critical Deflections and Radius of Curvature - Design Wind

Elevation ft	Appurtenance	Gov. Load Comb.	Deflection in	Tilt °	Twist °	Radius of Curvature ft
167.0000	Lightning Rod 5/8x4'	8	121.202	6.7240	0.0100	9349
158.0000	(2) 7770.00 w/ Mount Pipe	8	108.751	6.4866	0.0083	5193
156.0000	(2) RRUS-11	8	106.003	6.4324	0.0079	4248
150.0000	Pipe Mount [PM 601-3]	8	97.837	6.2637	0.0068	2747
148.0000	Platform Mount [LP 712-1]	8	95.148	6.2050	0.0065	2457
138.0000	APX16PV-16PVL-E w/ Mount Pipe	8	82.043	5.8854	0.0049	1607
120.0000	APXV18-206517S-C w/ Mount Pipe	8	60.542	5.1508	0.0028	1051

### Compression Checks

### Pole Design Data

Section No.	Elevation ft	Size	L ft	L <sub>u</sub> ft	Kl/r	F <sub>a</sub> ksi	A in <sup>2</sup>	Actual P K	Allow. P <sub>a</sub> K	Ratio P P <sub>a</sub>
L1	167 - 118.25 (1)	TP35.36x24x0.25	48.7500	0.0000	0.0	39.000	27.0277	-12.13	1054.08	0.012
L2	118.25 - 90.5 (2)	TP41.3282x33.8114x0.312 5	32.2500	0.0000	0.0	39.000	40.6825	-19.42	1586.62	0.012
L3	90.5 - 77.75 (3)	TP44.3x41.3282x0.3819	12.7500	0.0000	0.0	34.080	51.6814	-21.28	1761.30	0.012
L4	77.75 - 63.5 (4)	TP46.9913x42.2543x0.375	19.7500	0.0000	0.0	39.000	55.4851	-27.44	2163.92	0.013
L5	63.5 - 51.5 (5)	TP49.7851x46.9913x0.459 9	12.0000	0.0000	0.0	34.134	72.0058	-31.30	2457.85	0.013
L6	51.5 - 45 (6)	TP51.2985x49.7851x0.457 2	6.5000	0.0000	0.0	34.146	73.7753	-33.46	2519.13	0.013
L7	45 - 0 (7)	TP61.04x51.2985x0.4375	45.0000	0.0000	0.0	39.000	84.1541	-49.27	3282.01	0.015

### Pole Bending Design Data

Section No.	Elevation ft	Size	Actual M <sub>x</sub> kip-ft	Actual f <sub>bx</sub> ksi	Allow. F <sub>bx</sub> ksi	Ratio f <sub>bx</sub> F <sub>bx</sub>	Actual M <sub>y</sub> kip-ft	Actual f <sub>by</sub> ksi	Allow. F <sub>by</sub> ksi	Ratio f <sub>by</sub> F <sub>by</sub>
L1	167 - 118.25 (1)	TP35.36x24x0.25	820.55	43.323	39.000	1.111	0.00	0.000	39.000	0.000
L2	118.25 - 90.5 (2)	TP41.3282x33.8114x0.31 25	1742.2 8	50.765	39.000	1.302	0.00	0.000	39.000	0.000
L3	90.5 - 77.75 (3)	TP44.3x41.3282x0.3819	1965.7 3	43.430	34.080	1.274	0.00	0.000	34.080	0.000
L4	77.75 - 63.5 (4)	TP46.9913x42.2543x0.37 5	2605.6 0	48.998	39.000	1.256	0.00	0.000	39.000	0.000
L5	63.5 - 51.5 (5)	TP49.7851x46.9913x0.45 99	3014.9 3	41.341	34.134	1.211	0.00	0.000	34.134	0.000
L6	51.5 - 45 (6)	TP51.2985x49.7851x0.45 72	3243.3 0	42.097	34.146	1.233	0.00	0.000	34.146	0.000
L7	45 - 0 (7)	TP61.04x51.2985x0.4375	4926.7 5	46.949	39.000	1.204	0.00	0.000	39.000	0.000

### Pole Shear Design Data

Section No.	Elevation ft	Size	Actual V K	Actual f <sub>v</sub> ksi	Allow. F <sub>v</sub> ksi	Ratio f <sub>v</sub> F <sub>v</sub>	Actual T kip-ft	Actual f <sub>vt</sub> ksi	Allow. F <sub>vt</sub> ksi	Ratio f <sub>vt</sub> F <sub>vt</sub>
L1	167 - 118.25 (1)	TP35.36x24x0.25	26.03	0.963	26.000	0.074	0.16	0.004	26.000	0.000
L2	118.25 - 90.5 (2)	TP41.3282x33.8114x0.31 25	30.41	0.747	26.000	0.057	0.03	0.000	26.000	0.000
L3	90.5 - 77.75 (3)	TP44.3x41.3282x0.3819	31.23	0.604	22.720	0.053	0.02	0.000	22.720	0.000
L4	77.75 - 63.5 (4)	TP46.9913x42.2543x0.37 5	33.42	0.602	26.000	0.046	0.53	0.005	26.000	0.000
L5	63.5 - 51.5 (5)	TP49.7851x46.9913x0.45 99	34.77	0.483	22.756	0.042	0.59	0.004	22.756	0.000
L6	51.5 - 45 (6)	TP51.2985x49.7851x0.45 72	35.46	0.481	22.764	0.042	0.61	0.004	22.764	0.000
L7	45 - 0 (7)	TP61.04x51.2985x0.4375	39.35	0.468	26.000	0.036	0.73	0.003	26.000	0.000

### Pole Interaction Design Data

Section No.	Elevation ft	Ratio	Ratio	Ratio	Ratio	Ratio	Comb. Stress Ratio	Allow. Stress Ratio	Criteria
		$\frac{P}{P_n}$	$\frac{f_{bx}}{F_{bx}}$	$\frac{f_{by}}{F_{by}}$	$\frac{f_v}{F_v}$	$\frac{f_{vt}}{F_{vt}}$			
L1	167 - 118.25 (1)	0.012	1.111	0.000	0.074	0.000	1.124	1.333	H1-3+VT ✓
L2	118.25 - 90.5 (2)	0.012	1.302	0.000	0.057	0.000	1.315	1.333	H1-3+VT ✓
L3	90.5 - 77.75 (3)	0.012	1.274	0.000	0.053	0.000	1.287	1.333	H1-3+VT ✓
L4	77.75 - 63.5 (4)	0.013	1.256	0.000	0.046	0.000	1.270	1.333	H1-3+VT ✓
L5	63.5 - 51.5 (5)	0.013	1.211	0.000	0.042	0.000	1.224	1.333	H1-3+VT ✓
L6	51.5 - 45 (6)	0.013	1.233	0.000	0.042	0.000	1.247	1.333	H1-3+VT ✓
L7	45 - 0 (7)	0.015	1.204	0.000	0.036	0.000	1.219	1.333	H1-3+VT ✓

### Section Capacity Table

Section No.	Elevation ft	Component Type	Size	Critical Element	P K	SF*P <sub>allow</sub> K	% Capacity	Pass Fail
L1	167 - 118.25	Pole	TP35.36x24x0.25	1	-12.13	1405.09	84.3	Pass
L2	118.25 - 90.5	Pole	TP41.3282x33.8114x0.3125	2	-19.42	2114.96	98.6	Pass
L3	90.5 - 77.75	Pole	TP44.3x41.3282x0.3819	3	-21.28	2347.81	96.6	Pass
L4	77.75 - 63.5	Pole	TP46.9913x42.2543x0.375	4	-27.44	2884.51	95.2	Pass
L5	63.5 - 51.5	Pole	TP49.7851x46.9913x0.4599	5	-31.30	3276.31	91.8	Pass
L6	51.5 - 45	Pole	TP51.2985x49.7851x0.4572	6	-33.46	3358.00	93.5	Pass
L7	45 - 0	Pole	TP61.04x51.2985x0.4375	7	-49.27	4374.92	91.5	Pass
Summary								
Pole (L2)							98.6	Pass
<b>RATING =</b>							<b>98.6</b>	<b>Pass</b>

**APPENDIX B**  
**BASE LEVEL DRAWING**

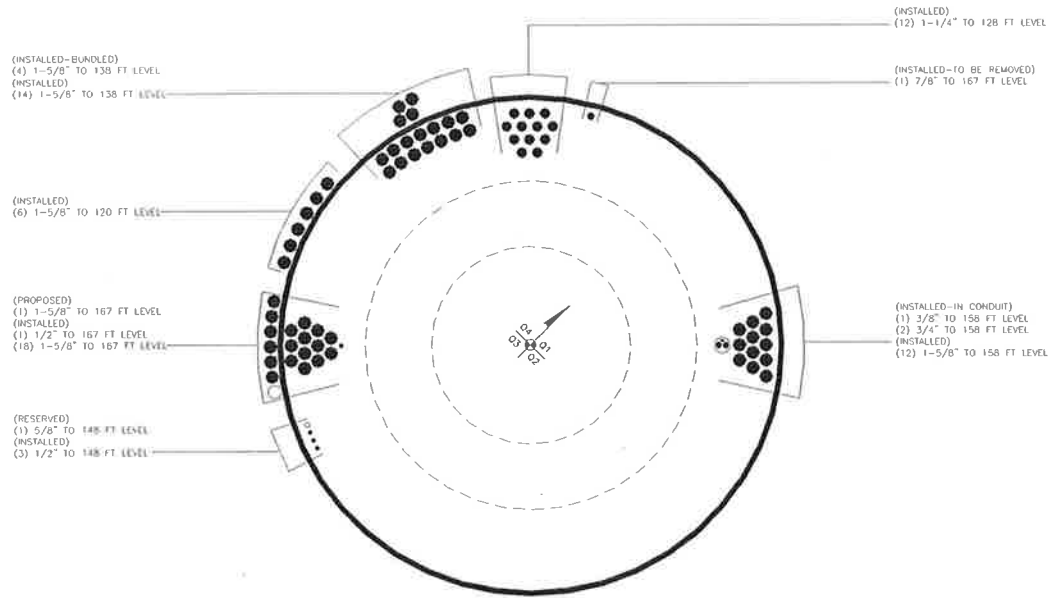

**APPENDIX C**  
**ADDITIONAL CALCULATIONS**

---

Program Version 6.1.4.1 - 12/17/2013 File:G:/TOWER/375\_Crown\_Castle/2013/37513-0349 BU 801367/37513-0349 R1 WO 740267 BU  
801367 - 7806/37513-0349 Reinforced.eri

Section	1	2	3	4	5	6	7
Length (ft)	48.7500	32.2500	12.7500	19.7500	12.0000	6.5000	45.0000
Number of Sides	18	18	18	18	18	18	18
Thickness (in)	0.2500	0.3125	0.3819	0.3750	0.4599	0.4572	0.4375
Socket Length (ft)	4.5000		5.5000				
Top Dia (in)	24.0000	33.8114	41.3282	42.2542	46.9913	48.7851	51.2985
Bot Dia (in)	35.3600	41.3282	44.3000	46.9913	48.7851	51.2985	61.0400
Grade		A607-65		Reinf 56.80 ksi	A607-65	Reinf 56.89 ksi	A607-65
Weight (K)	3.9	4.1	2.2	3.5	2.9	1.6	11.9

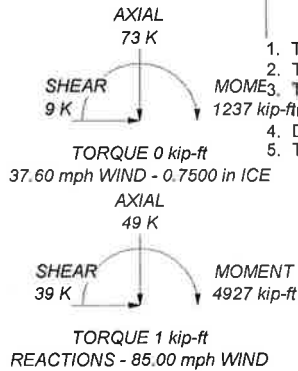
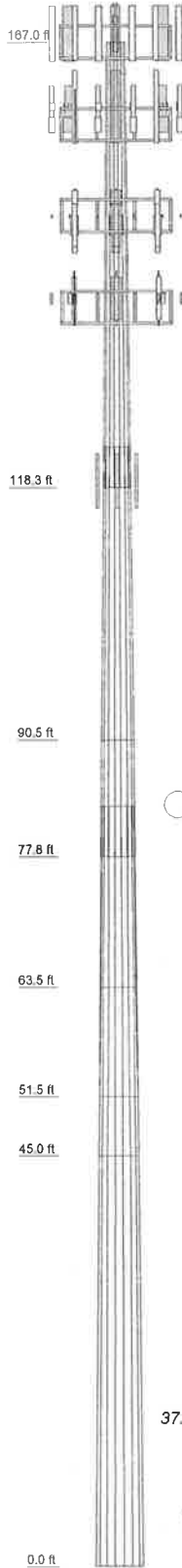

### DESIGNED APPURTENANCE LOADING

TYPE	ELEVATION	TYPE	ELEVATION
Lightning Rod 5/8x4'	167	TME-800MHZ RRH	150
(2) LPA-80063-6CF-EDIN w/ Mount Pipe	167	PCS 1900MHz 4x45W-65MHz	150
(2) LPA-80063-6CF-EDIN w/ Mount Pipe	167	TME-800MHZ RRH	150
(2) LPA-80063-6CF-EDIN w/ Mount Pipe	167	PCS 1900MHz 4x45W-65MHz	150
(2) LPA-80063-6CF-EDIN w/ Mount Pipe	167	TME-800MHZ RRH	150
GPS_A	167	800 EXTERNAL NOTCH FILTER	148
BXA-171063/8CFx2 w/ Mount Pipe	167	(3) ACU-A20-N	148
BXA-171063/8CFx2 w/ Mount Pipe	167	APXVSP18-C-A20 w/ Mount Pipe	148
BXA-171063/8CFx2 w/ Mount Pipe	167	800 EXTERNAL NOTCH FILTER	148
BXA-171063/8CFx2 w/ Mount Pipe	167	(3) ACU-A20-N	148
BXA-70063-6CF-EDIN-2 w/ Mount Pipe	167	APXVSP18-C-A20 w/ Mount Pipe	148
BXA-70063-6CF-EDIN-2 w/ Mount Pipe	167	800 EXTERNAL NOTCH FILTER	148
BXA-70063-6CF-EDIN-2 w/ Mount Pipe	167	(3) ACU-A20-N	148
BXA-70063-6CF-EDIN-2 w/ Mount Pipe	167	APXVSP18-C-A20 w/ Mount Pipe	148
BXA-70063-6CF-EDIN-2 w/ Mount Pipe	167	6' x 2" Mount Pipe	148
Platform Mount [LP 712-1]	167	6' x 2" Mount Pipe	148
RRH2X40-AWS	167	6' x 2" Mount Pipe	148
BXA-171063-8CF-EDIN-X w/ Mount Pipe	167	TD-RRH8x20-25	148
DB-T1-6Z-8AB-0Z	167	APXVTM14-C-120 w/ Mount Pipe	148
RRH2X40-AWS	167	TD-RRH8x20-25	148
BXA-171063-8CF-EDIN-X w/ Mount Pipe	167	APXVTM14-C-120 w/ Mount Pipe	148
RRH2X40-AWS	167	TD-RRH8x20-25	148
BXA-171063-8CF-EDIN-X w/ Mount Pipe	167	APXVTM14-C-120 w/ Mount Pipe	148
RRH2X40-AWS	167	Platform Mount [LP 712-1]	148
BXA-171063-8CF-EDIN-X w/ Mount Pipe	167	APX18DWWV-16DWWV-S-E-A20 w/ Mount Pipe	138
(2) LGP21401	158	(2) S20057A-1	138
(2) LGP21401	158	Platform Mount [LP 712-1]	138
SBNH-1D6565C w/ Mount Pipe	158	KRY 112 134/1	138
SBNH-1D6565C w/ Mount Pipe	158	KRY 112 134/1	138
SBNH-1D6565C w/ Mount Pipe	158	KRY 112 89/5	138
DC6-48-60-18-BF	158	KRY 112 89/5	138
Platform Mount [LP 712-1]	158	KRY 112 89/5	138
6' x 2" Mount Pipe	158	(2) S20057A-1	138
6' x 2" Mount Pipe	158	(2) S20057A-1	138
6' x 2" Mount Pipe	158	6' x 2" Mount Pipe	138
(2) 7770.00 w/ Mount Pipe	158	6' x 2" Mount Pipe	138
(2) 7770.00 w/ Mount Pipe	158	6' x 2" Mount Pipe	138
(2) 7770.00 w/ Mount Pipe	158	APX16DWWV-16DWWV-S-E-A20 w/ Mount Pipe	138
(2) LGP13519	158	APX16DWWV-16DWWV-S-E-A20 w/ Mount Pipe	138
(2) LGP13519	158	APX16DWWV-16DWWV-S-E-A20 w/ Mount Pipe	138
(2) LGP13519	158	KRY 112 134/1	138
(2) LGP21401	158	APX16PV-16PVL-E w/ Mount Pipe	138
Side Arm Mount [SO 102-3]	156	APX16PV-16PVL-E w/ Mount Pipe	138
(2) RRU8-11	156	APX16PV-16PVL-E w/ Mount Pipe	138
(2) RRU8-11	156	Pipe Mount [PM 601-3]	120
(2) RRU8-11	156	APXV18-206517S-C w/ Mount Pipe	120
Pipe Mount [PM 601-3]	150	APXV18-206517S-C w/ Mount Pipe	120
PCS 1900MHz 4x45W-65MHz	150	APXV18-206517S-C w/ Mount Pipe	120

### MATERIAL STRENGTH

GRADE	Fy	Fu	GRADE	Fy	Fu
A607-65	65 ksi	80 ksi	Reinf 56.89 ksi	57 ksi	72 ksi
Reinf 56.80 ksi	57 ksi	71 ksi	Reinf 56.91 ksi	57 ksi	72 ksi

### TOWER DESIGN NOTES

1. Tower is located in New Haven County, Connecticut.
2. Tower designed for a 85.00 mph basic wind in accordance with the TIA/EIA-222-F Standard.
3. Tower is also designed for a 37.60 mph basic wind with 0.75 in ice. Ice is considered to increase in thickness with height.
4. Deflections are based upon a 50.00 mph wind.
5. TOWER RATING: 98.6%

<p><b>Paul J Ford and Company</b> 250 E. Broad Street, Suite 600 Columbus, OH 43215 Phone: 614.221.6679 FAX: 614.448.4105</p>	Job: <b>Ex. 167-ft Monopole / Cheshire, CT</b>		
	Project: <b>BU# 801367 / PJF# 37512-1657</b>		
	Client: Crown Castle	Drawn by: John J Woolley	App'd:
	Code: TIA/EIA-222-F	Date: 04/14/14	Scale: NTS
	Path:	Dwg No. E-1	

## Square, Stiffened / Unstiffened Base Plate, Any Rod Material - Rev. F /G

**Assumptions:** 1) Rod groups at corners. Total # rods divisible by 4. Maximum total # of rods = 48 (12 per Corner).  
 2) Rod Spacing = Straight Center-to-Center distance between any (2) adjacent rods (same corner)  
 3) Clear space between bottom of leveling nut and top of concrete **not exceeding** (1)\*(Rod Diameter)

### Site Data

BU#:	
Site Name:	
App #:	

### Anchor Rod Data

Qty:	20	
Diam:	2.25	in
Rod Material:	A615-J	
Yield, Fy:	75	ksi
Strength, Fu:	100	ksi
Bolt Circle:	68	in
Anchor Spacing:	6	in

### Plate Data

W=Side:	67	in
Thick:	3	in
Grade:	55	ksi
Clip Distance:	14	in

### Stiffener Data (Welding at both sides)

Configuration:	Unstiffened
Weld Type:	**
Groove Depth:	in **
Groove Angle:	degrees
Fillet H. Weld:	<-- Disregard
Fillet V. Weld:	in
Width:	in
Height:	in
Thick:	in
Notch:	in
Grade:	ksi
Weld str.:	ksi

### Pole Data

Diam:	61.04	in
Thick:	0.4375	in
Grade:	65	ksi
# of Sides:	18	"0" IF Round

### Stress Increase Factor

ASD ASIF:	1.333
-----------	-------

\*\* Note: for complete joint penetration groove welds the groove depth must be exactly 1/2 the stiffener thickness for calculation purposes

### Base Reactions

TIA Revision:	F	
Unfactored Moment, M:	4927	ft-kips
Unfactored Axial, P:	49	kips
Unfactored Shear, V:	39	kips

### Anchor Rod Results

TIA F --> Maximum Rod Tension	171.4 Kips
Allowable Tension:	195.0 Kips
Anchor Rod Stress Ratio:	87.9%

### Base Plate Results

Base Plate Stress:	41.4 ksi
Allowable PL Bending Stress:	55.0 ksi
Base Plate Stress Ratio:	75.3%

### Flexural Check

### PL Ref. Data

Yield Line (in):	33.71
Max PL Length:	33.71

N/A - Unstiffened

### Stiffener Results

Horizontal Weld :	N/A
Vertical Weld:	N/A
Plate Flex+Shear, fb/Fb+(fv/Fv)^2:	N/A
Plate Tension+Shear, ft/Ft+(fv/Fv)^2:	N/A
Plate Comp. (AISC Bracket):	N/A

### Pole Results

Pole Punching Shear Check:	N/A
----------------------------	-----

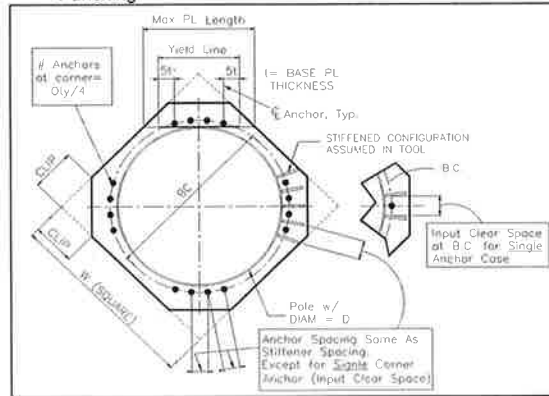



Foundation Loads:

Pole weight or tower leg compression = 49 (kips)  
 Horizontal load at top of pier = 39 (kips)  
 Overturning moment at top of pier = 4927 (ft-kips)

Design criteria:

Safety factor against overturning = 1.5

Soil Properties:

Soil density = 100 (pcf)  
 Allowable soil bearing = 8 (ksf)  
 Depth to water table = 99 (ft)

Dimensions:

Pier shape (round or square) R ("R" or "S")  
 Pier width = 8 (ft)  
 Pier height above grade = 0.5 (ft)  
 depth to bottom of footing = 7 (ft)  
 Footing thickness = 4 (ft)  
 Footing width = 26 (ft)  
 Footing length = 26 (ft)

Concrete:

Concrete strength = 3 (ksi)  
 Rebar strength = 60 (ksi)  
 ultimate load factor = 1.3

Reinforcing Steel:

Pad  
 minimum cover over rebar = 3 inches  
 size of pad rebar = #10 bar  
 quantity of pad rebar = 35 (ea direction)

Reinforcing Steel:

Pier  
 size of vert rebar in pier = #11 bar  
 vertical rebar quantity = 40  
 size of pier ties = #4 bar  
 minimum cover over rebar = 3 inches  
 Total volume of concrete = #### cu yd

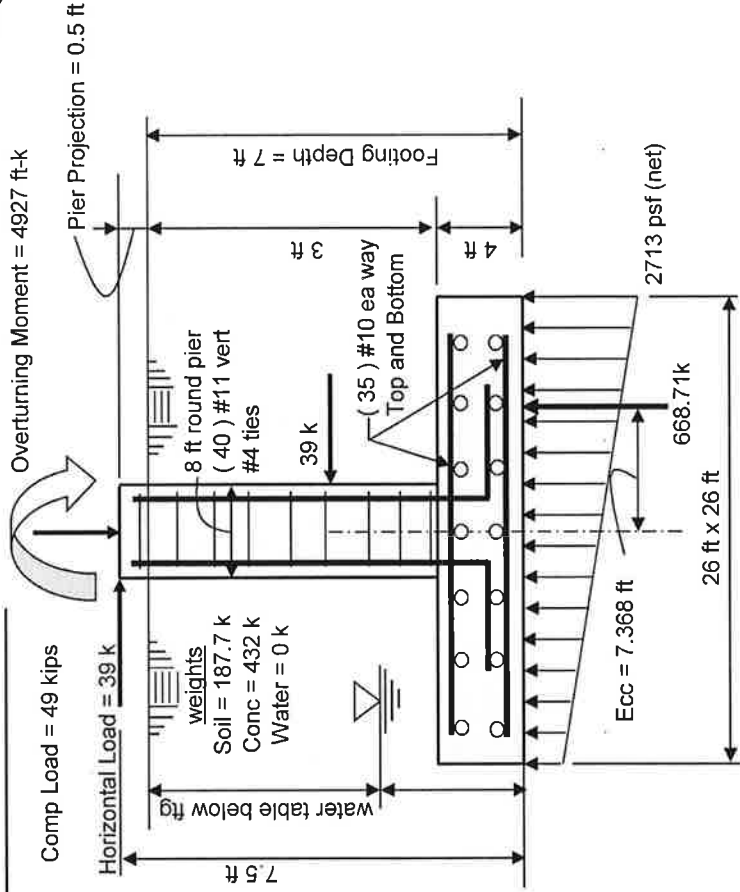

Summary of analysis results	
Maximum Net Soil Bearing = 2.713 ksf	Ult Bending Shear Capacity = 110 psi
Allowable Net Soil Bearing = 8 ksf	Ult Bending Shear Stress = 32 psi
<b>Soil Bearing Stress Ratio = 0.34 Okay</b>	<b>Bending Shear Stress Ratio = 0.29 Okay</b>
Ftg Overturning Resistance = 8693 ft-kips	Pad Bending Moment Capacity = 8291 ft-k
Overturning Moment = 4927 ft-kips	Pad Bending Moment = 2196 ft-k
Required Overturning Safety Factor = 1.5	<b>Bending Moment Stress Ratio = 0.26 OK</b>
Overturning Safety Factor = 1.764	<b>Ratio = 0.85 Okay</b>

```

          oooooo          o
          oo   oo          oo
oo   o   oo   oo   oo   oo   oo   oo   o ooooooooooooo   o   ooooo
oo   o   oo   oo   oo   oo   oo   oo   oo   oo   oo   oo   oo   oo
oo   oo   oo   oo   oo   oo   oo   oo   oo   oo   oo   oo   oo   oo
oooooo   oo   oo   oo   oo   oo   oo   oo   oo   oo   oo   oo   oo
          oo   ooooooo   oo   oo   oo   oo   oo   oo   oo   oo   oo
o   oo   oo   oo   oo   oo   oo   oo   oo   oo   oo   oo   oo   oo
oooooo   oo   ooooooo   oooooo   ooo   oooooo o   oo   oo   oo   oo   oo (TM)

```

```

=====
                        spColumn v4.80 (TM)
Computer program for the Strength Design of Reinforced Concrete Sections
Copyright © 1988-2011, STRUCTUREPOINT, LLC.
All rights reserved
=====

```

Licensee stated above acknowledges that STRUCTUREPOINT (SP) is not and cannot be responsible for either the accuracy or adequacy of the material supplied as input for processing by the spColumn computer program. Furthermore, STRUCTUREPOINT neither makes any warranty expressed nor implied with respect to the correctness of the output prepared by the spColumn program. Although STRUCTUREPOINT has endeavored to produce spColumn error free the program is not and cannot be certified infallible. The final and only responsibility for analysis, design and engineering documents is the licensee's. Accordingly, STRUCTUREPOINT disclaims all responsibility in contract, negligence or other tort for any analysis, design or engineering documents prepared in connection with the use of the spColumn program.

## General Information:

```

=====
File Name: g:\tower\375_crown_castle\2013\37513-0349 bu 801367\37513-0349 r1 wo 74...\37513-0349.col
Project:
Column:                               Engineer:
Code:   ACI 318-02                     Units: English

Run Option: Investigation               Slenderness: Not considered
Run Axis:   X-axis                      Column Type: Architectural

```

## Material Properties:

```

=====
f'c   = 3 ksi                          fy   = 60 ksi
Ec    = 3122.02 ksi                     Es   = 29000 ksi
Ultimate strain = 0.003 in/in
Beta1 = 0.85

```

## Section:

```

=====
Circular:   Diameter = 96 in

Gross section area, Ag = 7238.23 in^2
Ix = 4.16922e+006 in^4                Iy = 4.16922e+006 in^4
rx = 24 in                             ry = 24 in
Xo = 0 in                               Yo = 0 in

```

## Reinforcement:

```

=====
Bar Set: ASTM A615
Size Diam (in) Area (in^2)   Size Diam (in) Area (in^2)   Size Diam (in) Area (in^2)
-----
# 3      0.38      0.11   # 4      0.50      0.20   # 5      0.63      0.31
# 6      0.75      0.44   # 7      0.88      0.60   # 8      1.00      0.79
# 9      1.13      1.00   # 10     1.27      1.27   # 11     1.41      1.56
# 14     1.69      2.25   # 18     2.26      4.00

```

Confinement: Tied; #4 ties with #10 bars, #4 with larger bars.  
 $\phi(a) = 0.8$ ,  $\phi(b) = 0.9$ ,  $\phi(c) = 0.65$

Layout: Circular  
 Pattern: All Sides Equal (Cover to transverse reinforcement)  
 Total steel area:  $A_s = 62.40 \text{ in}^2$  at  $\rho = 0.86\%$  (Note:  $\rho < 1.0\%$ )  
 Minimum clear spacing = 5.46 in

40 #11 Cover = 3 in

## Factored Loads and Moments with Corresponding Capacities:

```

=====
No.      Pu      Mux      PhiMnx  PhiMn/Mu  NA depth  Dt depth  eps_t  Phi
      kip      k-ft      k-ft
-----
1      49.00    6582.55  10794.51  1.640    19.54    91.79    0.01109  0.900

```

\*\*\* End of output \*\*\*



**DRILLED PIER SOIL AND STEEL ANALYSIS - TIA/EIA-222-F**

**Unfactored Base Reactions from RISA**

	Comp. (+)	Tension (-)	
Moment, M =	4927.0		k-ft
Shear, V =	39.0		kips
Axial Load, P =	49.0		kips
OTM =	4946.5	0.0	k-ft @ Ground

**Safety Factors / Load Factors /  $\Phi$  Factors**

Tower Type =	Monopole DP
ACI Code =	ACI 318-02
Seismic Design Category =	D
Reference Standard =	TIA/EIA-222-F
Use 1.3 Load Factor?	Yes
Load Factor =	1.30

**Drilled Pier Parameters**

Diameter =	8	ft
Height Above Grade =	0.5	ft
Depth Below Grade =	23	ft
fc' =	3	ksi
ec =	0.003	in/in
Mat Ftdn. Cap Width =		ft
Mat Ftdn. Cap Length =		ft
Depth Below Grade =		ft

	Safety Factor	$\Phi$ Factor
Soil Lateral Resistance =	2.00	0.75
Skin Friction =	2.00	0.75
End Bearing =	2.00	0.75
Concrete Wt. Resist Uplift =	1.25	

**Load Combinations Checked per TIA/EIA-222-F**

- Ult. Skin Friction/2.00 + Ult. End Bearing/2.00 + Effective Soil Wt. - Buoyant Conc. Wt.  $\geq$  Comp.
- Ult. Skin Friction/2.00 + Buoyant Conc. Wt./1.25  $\geq$  Uplift
- Ult. Skin Friction/1.50 + Buoyant Conc. Wt./1.50  $\geq$  Uplift

**Steel Parameters**

Number of Bars =	24
Rebar Size =	#11
Rebar Fy =	60
Rebar MOE =	29000
Tie Size =	#5
Side Clear Cover to Ties =	4

**Soil Parameters**

Water Table Depth =	99.00	ft
Depth to Ignore Soil =	4.00	ft
Depth to Full Cohesion =	0	ft
Full Cohesion Starts at?	Ground	

Above Full Cohesion Lateral Resistance = 4(Cohesion)(Dia)(H)  
Below Full Cohesion Lateral Resistance = 8(Cohesion)(Dia)(H)

**Direct Embed Pole Shaft Parameters**

Dia @ Grade =		in
Dia @ Depth Below Grade =		in
Number of Sides =		
Thickness =		in
Fy =		ksi
Backfill Condition =		

**Maximum Capacity Ratios**

Maximum Soil Ratio =	100.0%
Maximum Steel Ratio =	100.0%

**Define Soil Layers**

Note: Cohesion = Undrained Shear Strength = Unconfined Compressive Strength / 2

Layer	Thickness ft	Unit Weight pcf	Cohesion psf	Friction Angle degrees	Soil Type	Ultimate End Bearing psf	Comp. Ult. Skin Friction psf	Tension Ult. Skin Friction psf	Depth ft
1	13.5	135	0	35	Sand				13.5
2	15.5	150	0	35	Sand	80000			29
3									
4									
5									
6									
7									
8									
9									
10									
11									
12									

**Soil Results: Overturning**

Depth to COR =	16.85	ft, from Grade
Bending Moment, M =	5603.62	k-ft, from COR
Resisting Moment, Ma =	6554.47	k-ft, from COR
<b>MOMENT RATIO =</b>	<b>85.5%</b>	<b>OK</b>

Shear, V =	39.00	kips
Resisting Shear, Va =	45.62	kips
<b>SHEAR RATIO =</b>	<b>85.5%</b>	<b>OK</b>

**Soil Results: Uplift**

Uplift, T =	0.00	kips
Allowable Uplift Cap., Ta =	141.75	kips
<b>UPLIFT RATIO =</b>	<b>0.0%</b>	<b>OK</b>

**Soil Results: Compression**

Compression, C =	49.00	kips
Allowable Comp. Cap., Ca =	1996.67	kips
<b>COMPRESSION RATIO =</b>	<b>2.5%</b>	<b>OK</b>

**Steel Results (ACI 318-02):**

Minimum Steel Area =	24.13	sq in
Actual Steel Area =	37.44	sq in
Allowable Min Axial, Pa =	-1555.20	kips, Where Ma = 0 k-ft
Allowable Max Axial, Pa =	8243.37	kips, Where Ma = 0 k-ft

Axial Load, P =	88.58	kips @ 4.75 ft Below Grade
Moment, M =	5125.64	k-ft @ 4.75 ft Below Grade
Allowable Moment, Ma =	5425.30	k-ft
<b>MOMENT RATIO =</b>	<b>94.5%</b>	<b>OK</b>

## Moment Capacity of Drilled Concrete Shaft (Caisson) for TIA Rev F or G

**Note:** Shaft assumed to have ties, not spiral, transverse reinforcing

<b>Site Data</b>		
BU#: 801367		
Site Name: CT NHV-2075 CAC 801367		
App #:		

Enter Load Factors Below:		
For M (WL)	1.3	<---- Enter Factor
For P (DL)	1.3	<---- Enter Factor

<b>Pier Properties</b>		
<b>Concrete:</b>		
Pier Diameter =	8.0	ft
Concrete Area =	7238.2	in <sup>2</sup>
<b>Reinforcement:</b>		
Clear Cover to Tie =	4.00	in
Horiz. Tie Bar Size =	5	
Vert. Cage Diameter =	7.11	ft
Vert. Cage Diameter =	85.34	in
Vertical Bar Size =	11	
Bar Diameter =	1.41	in
Bar Area =	1.56	in <sup>2</sup>
Number of Bars =	24	
As Total =	37.44	in <sup>2</sup>
A s/ Aconc, Rho:	0.0052	0.52%

<b>Maximum Shaft Superimposed Forces</b>		
TIA Revision:	F	
Max. Service Shaft M:	5125.64	ft-kips (* Note)
Max. Service Shaft P:	88.58	kips
Max Axial Force Type:	Comp.	

(\* Note: Max Shaft Superimposed Moment does not necessarily equal to the shaft top reaction moment

<b>Shaft Factored Loads</b>	
Load Factor	
1.30	Mu: 6663.332 ft-kips
1.30	Pu: 115.154 kips

<b>Material Properties</b>		
Concrete Comp. strength, fc =	3000	psi
Reinforcement yield strength, Fy =	60	ksi
Reinforcing Modulus of Elasticity, E =	29000	ksi
Reinforcement yield strain =	0.00207	
Limiting compressive strain =	0.003	
<b>ACI 318 Code</b>		
Select Analysis ACI Code =	2002	
<b>Seismic Properties</b>		
Seismic Design Category =	D	
Seismic Risk =	High	

Solve (Run)	← Press Upon Completing All Input
----------------	-----------------------------------

ACI 10.5, ACI 21.10.4, and IBC 1810.  
Min As for Flexural, Tension Controlled, Shafts:  
 $(3) * (\text{sqrt}(f_c) / F_y) = 0.0027$   
 $200 / F_y = 0.0033$

### Results:

Governing Orientation Case: 2

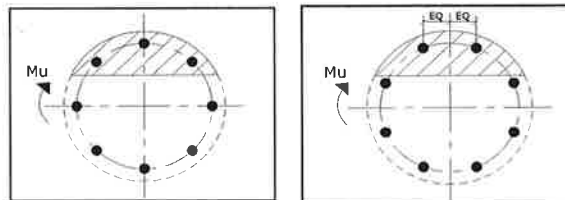

Case 1                      Case 2  
 Dist. From Edge to Neutral Axis: **15.07** in  
 Extreme Steel Strain, et: **0.0150**  
**et > 0.0050, Tension Controlled**  
 Reduction Factor, phi: **0.900**

<b>Minimum Rho Check:</b>		
Actual Req'd Min. Rho:	0.33%	Flexural
Provided Rho:	0.52%	OK

<b>Ref. Shaft Max Axial Capacities, phi Max(Pn or Tn):</b>		
Max Pu = (phi=0.65) Pn,		
Pn per ACI 318 (10-2)	10716.37	kips
at Mu=(phi=0.65) Mn =	7467.49	ft-kips
Max Tu, (phi=0.9) Tn =	2021.76	kips
at Mu=phi=(0.90) Mn =	0.00	ft-kips

**Output Note:** Negative Pu=Tension  
 For Axial Compression, phi Pn = Pu: **115.15** kips  
 Drilled Shaft Moment Capacity, phi Mn: **7052.88** ft-kips  
 Drilled Shaft Superimposed Mu: **6663.33** ft-kips

<b>(Mu/phi Mn, Drilled Shaft Flexure CSR):</b>	<b>94.5%</b>
--	--------------