

# PROJECT NARRATIVE

October 25, 2021

Melanie A. Bachman  
Executive Director  
Connecticut Siting Council  
10 Franklin Square  
New Britain, CT 06051

Re: Request of DISH Wireless LLC for an Order to Approve the Shared Use of an Existing Tower  
4 Hoffman Road Canton, CT 06019  
Latitude: 41°51'19.0" / Longitude: -72°53'33.00"

Dear Ms. Bachman:

Pursuant to Connecticut General Statutes ("C.G.S.") §16-50aa, as amended, DISH Wireless LLC ("DISH") hereby requests an order from the Connecticut Siting Council ("Council") to approve the shared use by DISH of an existing telecommunication tower at 4 Hoffman Road in Canton (the "Property"). The existing 150-foot monopole tower is owned by American Tower Corporation ("ATC"). The underlying property is owned by James H. & Katherine E. Hart. DISH requests that the Council find that the proposed shared use of the ATC tower satisfies the criteria of C.G.S. §16-50aa and issue an order approving the proposed shared use. A copy of this filing is being sent to Robert Bessel, First Selectman for the Town of Canton, Jerry Waters, Town of Canton Building Official and James H. & Katherine E. Hart as the property owner.

## Background

The existing ATC facility consists of a 150-foot monopole tower located within an existing leased area. Spok Holdings, Inc currently maintains antennas at the 163-foot, 155-foot and 10-foot levels. The Town of Canton maintains antennas at the 161-foot level and 123-foot level. AT&T Mobility currently maintains antennas at the 150-foot level. T-Mobile currently maintains antennas at the 140-foot level. Verizon Wireless currently maintains antennas at the 118-foot level. Equipment associated with these antennas are located at various positions within the tower and compound.

DISH is licensed by the Federal Communications Commission ("FCC") to provide wireless services throughout the State of Connecticut. DISH and Crown Castle have agreed to the proposed shared use of the 4 Hoffman Road tower pursuant to mutually acceptable terms and conditions. Likewise, DISH and ATC have agreed to the proposed installation of equipment cabinets on the ground on the south side of the tower within the existing compound. ATC has authorized DISH to apply for all necessary permits and approvals that may be required to share the existing tower. (See attached Letter of Authorization)

DISH proposes to install three (3) antennas, (1) Tower platform mount, (6) Remote radio units at the 108-foot level along with, (1) over voltage protection device (OVP) and (1) Hybrid cable. DISH will install an equipment cabinet on a 5'x7' equipment platform. DISH's Construction Drawings provide project specifications for all proposed site improvement locations.

The construction drawings also include specifications for DISH's proposed antenna and groundwork.

C.G.S. § 16-50aa(c)(1) provides that, upon written request for approval of a proposed shared use, "if the Council finds that the proposed shared use of the facility is technically, legally, environmentally and economically feasible and meets public safety concerns, the council shall issue an order approving such a shared use." DISH respectfully submits that the shared use of the tower satisfies these criteria.

**A. Technical Feasibility.** The existing ATC tower is structurally capable of supporting DISH's proposed improvements. The proposed shared use of this tower is, therefore, technically feasible. A Feasibility Structural Analysis Report ("Structural Report") prepared for this project confirms that this tower can support DISH's proposed loading. A copy of the Structural Report has been included in this application.

**B. Legal Feasibility.** Under C.G.S. § 16-50aa, the Council has been authorized to issue order approving the shared use of an existing tower such as the ATC tower. This authority complements the Council's prior-existing authority under C.G.S. § 16-50p to issue orders approving the construction of new towers that are subject to the Council's jurisdiction. In addition, § 16-50x(a) directs the Council to "give such consideration to the other state laws and municipal regulations as it shall deem appropriate" in ruling on requests for the shared use of existing tower facilities. Under the statutory authority vested in the Council, an order by the Council approving the requested shared use would permit the Applicant to obtain a building permit for the proposed installations.

**C. Environmental Feasibility.** The proposed shared use of the ATC tower would have a minimal environmental effect for the following reasons:

1. The proposed installation will have no visual impact on the area of the tower. DISH's equipment cabinet would be installed within the existing facility compound. DISH's shared use of this tower therefore will not cause any significant change or alteration in the physical or environmental characteristics of the existing site.
2. Operation of DISH's antennas at this site would not exceed the RF emissions standard adopted by the Federal Communications Commission ("FCC"). Included in the EME report of this filing are the approximation tables that demonstrate that DISH's proposed facility will operate well within the FCC RF emissions safety standards.
3. Under ordinary operating conditions, the proposed installation would not require the use of any water or sanitary facilities and would not generate air emissions or discharges to water bodies or sanitary facilities. After construction is complete the proposed installations would not generate any increased traffic to the ATC facility other than periodic maintenance. The proposed shared use of the ATC tower, would, therefore, have a minimal environmental effect, and is environmentally feasible.

---

D. **Economic Feasibility.** As previously mentioned, DISH has entered into an agreement with ATC for the shared use of the existing facility subject to mutually agreeable terms. The proposed tower sharing is, therefore, economically feasible.

E. **Public Safety Concerns.** As discussed above, the tower is structurally capable of supporting DISH's full array of three (3) antennas, (1) Tower platform mount, (6) Remote radio units, (1) over voltage protection device (OVP) and (1) Hybrid cable and all related equipment. DISH is not aware of any public safety concerns relative to the proposed sharing of the existing ATC tower

### **Conclusion**

For the reasons discussed above, the proposed shared use of the existing ATC tower at 4 Hoffman Road satisfies the criteria stated in C.G.S. §16-50aa and advances the Council's goal of preventing the unnecessary proliferation of towers in Connecticut. The Applicant, therefore, respectfully requests that the Council issue an order approving the proposed shared use.

Sincerely,

*David Hoogasian*

**David Hoogasian**  
*Project Manager*

# LETTER OF AUTHORIZATION



**AMERICAN TOWER®**  
CORPORATION

**LETTER OF AUTHORIZATION**  
**LICENSEE: DISH WIRELESS L.L.C.**

I, Margaret Robinson, Senior Counsel for American Tower\*, owner/operator of the tower facility located at the address identified above (the "Tower Facility"), do hereby authorize DISH WIRELESS L.L.C., its successors and assigns, and/or its agent, (collectively, the "Licensee") to act as American Tower's non-exclusive agent for the sole purpose of filing and consummating any land-use or building permit application(s) as may be required by the applicable permitting authorities for Licensee's telecommunications' installation.

We understand that this application may be denied, modified or approved with conditions. The above authorization is limited to the acceptance by Licensee only of conditions related to Licensee's installation and any such conditions of approval or modifications will be Licensee's sole responsibility.

\*American Tower includes all affiliates and subsidiaries of American Tower Corporation.

Project #	ATC Site #	ATC Site Name	ATC Site Address
13688133	208450	Enfield	1A Ecology Drive, Enfield CT
13700322	209115	Ridgefield 2	320 Old Stagecoach Road, Ridgefield, CT
13688136	209185	Burlington 2	87 Monce Road, Burlington CT
13700320	209271	Brookfield 2	100 Pocono Road, Brookfield CT
13693702	243036	WEST HAVEN & RT 162 CT	668 Jones Hill Road, West Haven CT
13693677	280501	ROXBURY CT	377 Southbury Road, Roxbury CT
13685406	281416	WILLINGTON CT	196 Tolland Turnpike, Willington CT
13709418	281862	BRIDGEWATER CT	111 SECOND HILL RD, Bridgewater CT
13693659	283418	NORTH HAVEN CT	50 Devine Street, North Haven CT
13694329	283419	PINE ORCHARD BRANFORD CT	123 Pine Orchard Road, Branford CT
13694332	283422	SHORT BEACH BRANFORD CT	171 Short Beach Road, Branford CT
13698427	283423	NAUGATUCK CT	880 Andrew Mountain Road, Naugatuck CT
13685464	283563	MANSFIELD CT	343 Daleville Road, Willington CT
13692735	284983	OLD LYME CT	61-1 Buttonball Road, Old Lyme CT
13693120	284984	PAWCATUCK CT	166 Pawcatuck Ave, Pawcatuck CT
13693144	284988	GUILFORD CT	Moose Hill Road, Guilford CT
13694582	302465	Colchester CT 6	355 Route 85, Colchester CT
13683501	302468	Petro Lock	99 Meadow St, Hartford CT
13685427	302469	Bridgeport CT 2	1069 Connecticut Avenue, Bridgeport CT
13683503	302472	Andover-bunker Hill Road	104 Bunker Hill Road, Andover CT
13683507	302473	E H F R - Prestige Park	310 Prestige Park Road, East Hartford CT



**AMERICAN TOWER®**  
CORPORATION

Project #	ATC Site #	ATC Site Name	ATC Site Address
13683510	302474	South Windsor	391 Niederwerfer Road, South Windsor CT
13683513	302483	Brln - Berlin	286 Beckley Road, Berlin CT
13692185	302488	Cntn - Canton	4 Hoffmann Road, Canton CT
13692173	302495	Tolland CT	56 Ruops Road, Tolland CT
13694579	302496	Clch - Colchester	Chestnut Hill Road, Colchester CT
13701212	302501	Plymouth CT 3	297 North Street, Plymouth CT
13685414	302515	SMFR - North	5 High Ridge Park Road, Stamford CT
13702496	302516	Mlfd - Milford	438 Bridgeport Ave, Milford CT
13688395	302518	Newtown CT 3	25 Meridian Ridge Drive, Newton CT
13692174	302529	Vernon CT 6	777 Talcotville Road, Vernon Rockville CT
13693124	311014	NORWICH CT	202 N Wawecus Hill Rd, Norwich CT
13702522	311305	GLFD-GUILFORD REBUILD CT	10 Tanner Marsh Road, Guilford CT
13693127	370623	MONTVILLE CT	139 Sharp Hill Road, Uncasville CT
13681964	370625	Old Saybrook	77 Springbrook Road, Old Saybrook CT
13702535	383660	North Madison Volunteer FD	864 Opening Hill Road, Madison CT
13702538	411180	Good Hill CT	481 GOOD HILL ROAD, Woodbury CT
13693709	411182	Nepaug CT	20 Antolini Road, New Hartford CT
13693131	411183	WATERFORD CT	53 Dayton Rd., Waterford CT
13693135	411184	SALEM CT SQA	399 West Road, Salem CT
13692177	411186	West Granby, CT CT	207 West Granby Road, Granby CT
13692178	411187	Hartford North 2 CT	811 Blue Hills Avenue, Bloomfield CT
13693705	411188	Southbury CT	111 Upper Fishrock Road, Southbury CT
13692179	411256	CANTON CT	14 CANTON SPRINGS ROAD, Canton CT
13681988	411257	Middle Haddam Road-CROWN CT	191 Middle Haddam Rd, Portland CT
13692180	411258	Farmington North 2 CT	199 Town Farm Road, Farmington CT
13692182	411259	CT Collinsville CAC 802816 CT	650 Albany Turnpike, Collinsville CT
13692184	416862	SUFFIELD SW CT CT	106 South Grand St., West Suffield CT
13694578	6260	NORTH STONINGTON CT	118C Wintechog Hill Rd., off of Rt. 2, North Stonington CT
13681397	88013	Killingworth	131 Little City Road, Killingworth CT

Signature:

Print Name: Margaret Robinson  
Senior Counsel  
American Tower\*



**AMERICAN TOWER®**  
CORPORATION

**LETTER OF AUTHORIZATION  
LICENSEE: DISH WIRELESS L.L.C.**

**NOTARY BLOCK**

Commonwealth of MASSACHUSETTS  
County of Middlesex

This instrument was acknowledged before me by Margaret Robinson, Senior Counsel for American Tower\*, personally known to me (or proved to me on the basis of satisfactory evidence) to be the person whose name is subscribed to the within instrument and acknowledged to me that he executed the same.

WITNESS my hand and official seal, this 10<sup>th</sup> day of September 2021.

**NOTARY SEAL**

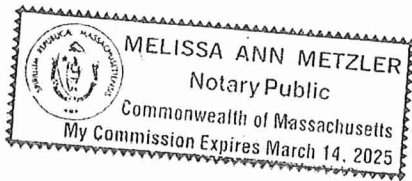

Notary Public   
My Commission Expires: March 14, 2025



# ENGINEERING DRAWINGS



DISH Wireless L.L.C. SITE ID:

**BOBDL00152B**

DISH Wireless L.L.C. SITE ADDRESS:

**4 HOFFMANN ROAD  
CANTON, CT 06019**

SCOPE OF WORK	
THIS IS NOT AN ALL INCLUSIVE LIST. CONTRACTOR SHALL UTILIZE SPECIFIED EQUIPMENT PART OR ENGINEER APPROVED EQUIVALENT. CONTRACTOR SHALL VERIFY ALL NEEDED EQUIPMENT TO PROVIDE A FUNCTIONAL SITE. THE PROJECT GENERALLY CONSISTS OF THE FOLLOWING:	
<b>TOWER SCOPE OF WORK:</b>	
<ul style="list-style-type: none"> <li>• INSTALL (3) PROPOSED PANEL ANTENNAS (1 PER SECTOR)</li> <li>• INSTALL (1) PROPOSED TOWER PLATFORM MOUNT</li> <li>• INSTALL PROPOSED JUMPERS</li> <li>• INSTALL (6) PROPOSED RRU's (2 PER SECTOR)</li> <li>• INSTALL (1) PROPOSED OVER VOLTAGE PROTECTION DEVICE (OVP)</li> <li>• INSTALL (1) PROPOSED HYBRID CABLE</li> </ul>	
<b>GROUND SCOPE OF WORK:</b>	
<ul style="list-style-type: none"> <li>• INSTALL (1) PROPOSED METAL PLATFORM</li> <li>• INSTALL (1) PROPOSED ICE BRIDGE</li> <li>• INSTALL (1) PROPOSED PPC CABINET</li> <li>• INSTALL (1) PROPOSED EQUIPMENT CABINET</li> <li>• INSTALL (1) PROPOSED POWER CONDUIT</li> <li>• INSTALL (1) PROPOSED TELCO CONDUIT</li> <li>• INSTALL (1) PROPOSED TELCO-FIBER BOX</li> <li>• INSTALL (1) PROPOSED GPS UNIT</li> <li>• INSTALL (1) PROPOSED SAFETY SWITCH (IF REQUIRED)</li> <li>• INSTALL (1) PROPOSED FIBER NID (IF REQUIRED)</li> <li>• INSTALL (1) PROPOSED METER SOCKET</li> </ul>	

SITE INFORMATION	PROJECT DIRECTORY
PROPERTY OWNER: ADDRESS:	APPLICANT:
HART JAMES H & KATHERINE E 90 PARK ROAD BARKHAMSTEAD, CT 06063	DISH Wireless L.L.C. 5701 SOUTH SANTA FE DRIVE LITTLETON, CO 80120
TOWER TYPE:	TOWER OWNER:
MONOPOLE	AMERICAN TOWER CORPORATION 10 PRESIDENTIAL WAY WOBURN, MA 01801 (781) 926-4500
TOWER CO SITE ID:	SITE DESIGNER:
302488	B+T GROUP 1717 S. BOULDER AVE, SUITE 300 TULSA, OK 74119 (918) 587-4630
TOWER APP NUMBER:	SITE ACQUISITION:
13692185	KENNETH BRADBURY II KENNETH.BRADBURY @AMERICANTOWER.COM
COUNTY:	CONSTRUCTION MANAGER:
HARTFORD	JAVIER SOTO JAVIER.SOTO@DISH.COM
LATITUDE (NAD 83):	RF ENGINEER:
41° 51' 19.0" N 41.855278 N	BOSENER CHARLES BOSENER.CHARLES @DISH.COM
LONGITUDE (NAD 83):	
72° 53' 33.0" W 72.8925 W	
ZONING JURISDICTION:	
HARTFORD COUNTY	
ZONING DISTRICT:	
R-3	
PARCEL NUMBER:	
19/243/0309	
OCCUPANCY GROUP:	
U	
CONSTRUCTION TYPE:	
II-B	
POWER COMPANY:	
T.B.D.	
TELEPHONE COMPANY:	
CROWN CASTLE	



5701 SOUTH SANTA FE DRIVE  
LITTLETON, CO 80120



**B&T ENGINEERING, INC.**  
PEC.0001564  
Expires 2/10/22

IT IS A VIOLATION OF LAW FOR ANY PERSON, UNLESS THEY ARE ACTING UNDER THE DIRECTION OF A LICENSED PROFESSIONAL ENGINEER, TO ALTER THIS DOCUMENT.

DRAWN BY:	CHECKED BY:	APPROVED BY:
CD	CD	RCM
RFDS REV #:	0	

**CONSTRUCTION DOCUMENTS**

SUBMITTALS		
REV	DATE	DESCRIPTION
A	7/26/21	ISSUED FOR REVIEW
D	8/2/21	ISSUED FOR CONSTRUCTION

A&E PROJECT NUMBER  
**153478.001.01**

DISH Wireless L.L.C.  
PROJECT INFORMATION  
**BOBDL00152B  
4 HOFFMANN ROAD  
CANTON, CT 06019**

SHEET TITLE  
**TITLE SHEET**

SHEET NUMBER  
**T-1**

**SITE PHOTO**



UNDERGROUND SERVICE ALERT CBYD 811  
UTILITY NOTIFICATION CENTER OF CONNECTICUT  
(800) 922-4455  
WWW.CBYD.COM  
CALL 2 WORKING DAYS UTILITY NOTIFICATION PRIOR TO CONSTRUCTION

**GENERAL NOTES**

THE FACILITY IS UNMANNED AND NOT FOR HUMAN HABITATION. A TECHNICIAN WILL VISIT THE SITE AS REQUIRED FOR ROUTINE MAINTENANCE. THE PROJECT WILL NOT RESULT IN ANY SIGNIFICANT DISTURBANCE OR EFFECT ON DRAINAGE, NO SANITARY SEWER SERVICE, POTABLE WATER, OR TRASH DISPOSAL IS REQUIRED AND NO COMMERCIAL SIGNAGE IS PROPOSED.

11"x17" PLOT WILL BE HALF SCALE UNLESS OTHERWISE NOTED

CONTRACTOR SHALL VERIFY ALL PLANS, EXISTING DIMENSIONS, AND CONDITIONS ON THE JOB SITE, AND SHALL IMMEDIATELY NOTIFY THE ENGINEER IN WRITING OF ANY DISCREPANCIES BEFORE PROCEEDING WITH THE WORK.

**DIRECTIONS**

DIRECTIONS FROM BRADLEY INTERNATIONAL AIRPORT:  
CONTINUE TO BRADLEY INTERNATIONAL AIRPORT CON HEAD NORTH TOWARD BRADLEY INTERNATIONAL AIRPORT SLIGHT LEFT ONTO BRADLEY INTERNATIONAL AIRPORT SLIGHT LEFT TAKE CT-20 W, CASE ST AND CT-179 S TO N MOUNTAIN RD IN CANTON CONTINUE ONTO BRADLEY INTERNATIONAL AIRPORT CON TAKE THE CT-20 W EXIT TOWARD E GRANBY/GRANBY CONTINUE ONTO CT-20 W SLIGHT LEFT ONTO CT-20 W/W GRANBY RD CONTINUE TO FOLLOW CT-20 W TURN LEFT ONTO CT-219 S TURN LEFT ONTO CASE ST SLIGHT LEFT ONTO CT-179 S CONTINUE ON N MOUNTAIN RD. DRIVE TO E HILL RD TURN LEFT ONTO N MOUNTAIN RD TURN RIGHT ONTO E HILL RD. ARRIVE AT BOBDL00152B.

**VICINITY MAP**



**CONNECTICUT CODE COMPLIANCE**

ALL WORK SHALL BE PERFORMED AND MATERIALS INSTALLED IN ACCORDANCE WITH THE CURRENT EDITIONS OF THE FOLLOWING CODES AS ADOPTED BY THE LOCAL GOVERNING AUTHORITIES. NOTHING IN THESE PLANS IS TO BE CONSTRUED TO PERMIT WORK NOT CONFORMING TO THESE CODES:

CODE TYPE	CODE
BUILDING	2018 CT STATE BUILDING CODE/2015 IBC W/ CT AMENDMENTS
MECHANICAL	2018 CT STATE BUILDING CODE/2015 IMC W/ CT AMENDMENTS
ELECTRICAL	2018 CT STATE BUILDING CODE/2017 NEC W/ CT AMENDMENTS

**SHEET INDEX**

SHEET NO.	SHEET TITLE
T-1	TITLE SHEET
A-1	OVERALL AND ENLARGED SITE PLAN
A-2	ELEVATION, ANTENNA LAYOUT AND SCHEDULE
A-3	EQUIPMENT PLATFORM AND H-FRAME DETAILS
A-4	EQUIPMENT DETAILS
A-5	EQUIPMENT DETAILS
A-6	EQUIPMENT DETAILS
E-1	ELECTRICAL/FIBER ROUTE PLAN AND NOTES
E-2	ELECTRICAL DETAILS
E-3	ELECTRICAL ONE-LINE, FAULT CALCS & PANEL SCHEDULE
G-1	GROUNDING PLANS AND NOTES
G-2	GROUNDING DETAILS
G-3	GROUNDING DETAILS
RF-1	RF CABLE COLOR CODE
GN-1	LEGEND AND ABBREVIATIONS
GN-2	GENERAL NOTES
GN-3	GENERAL NOTES
GN-4	GENERAL NOTES

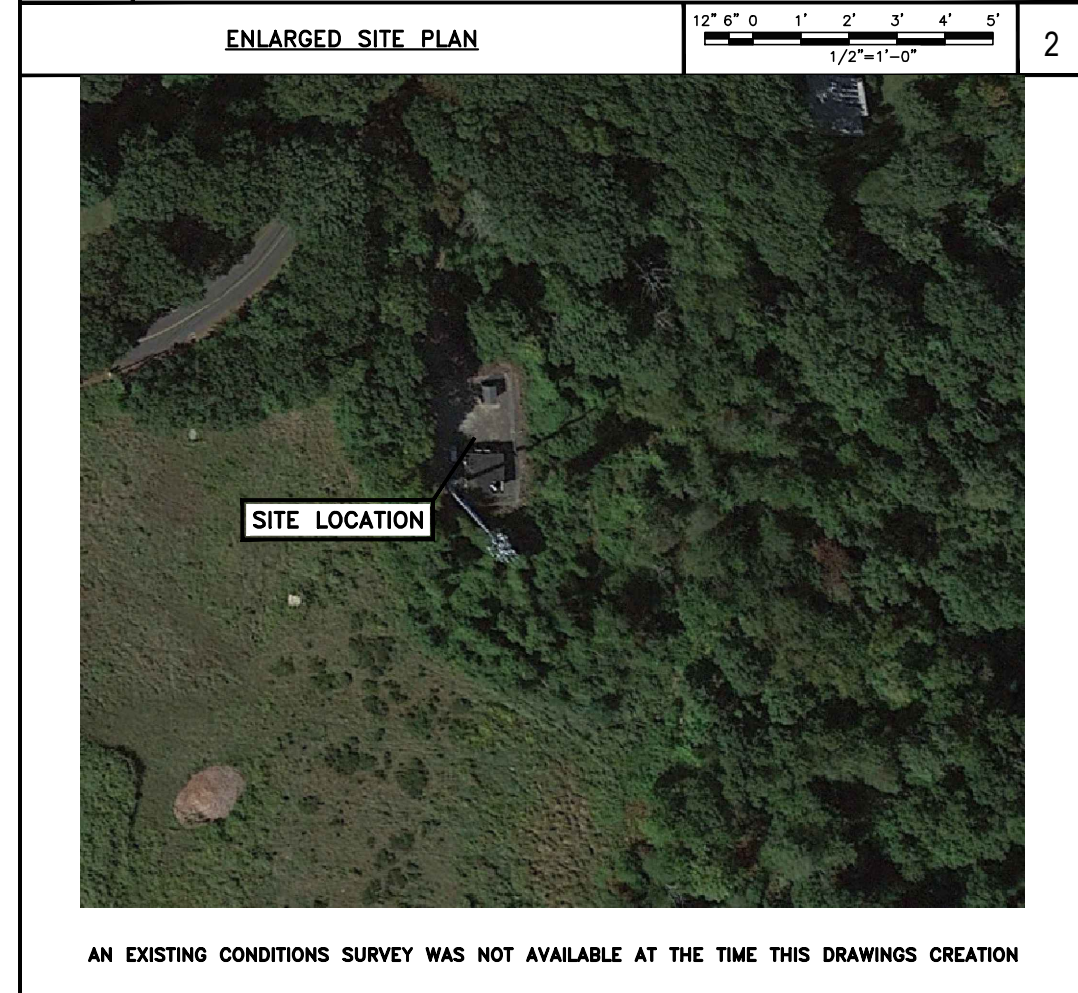
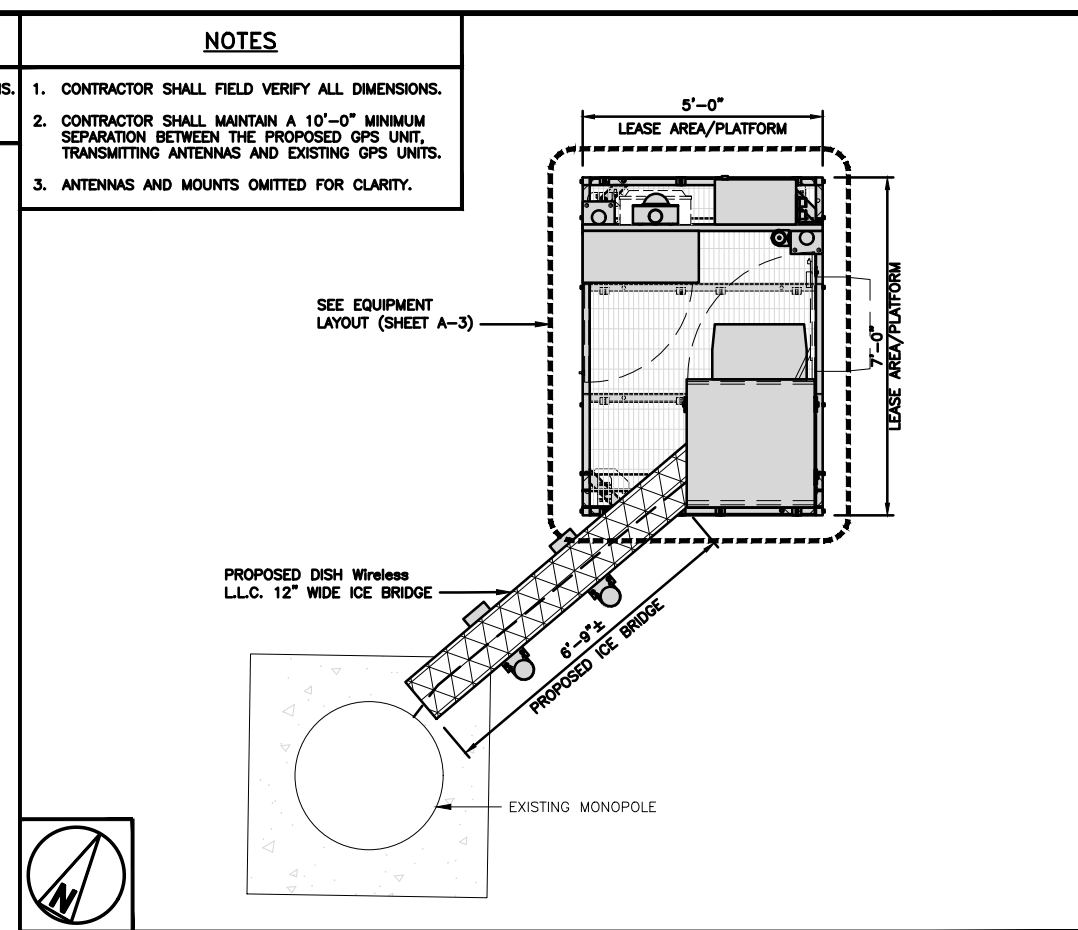
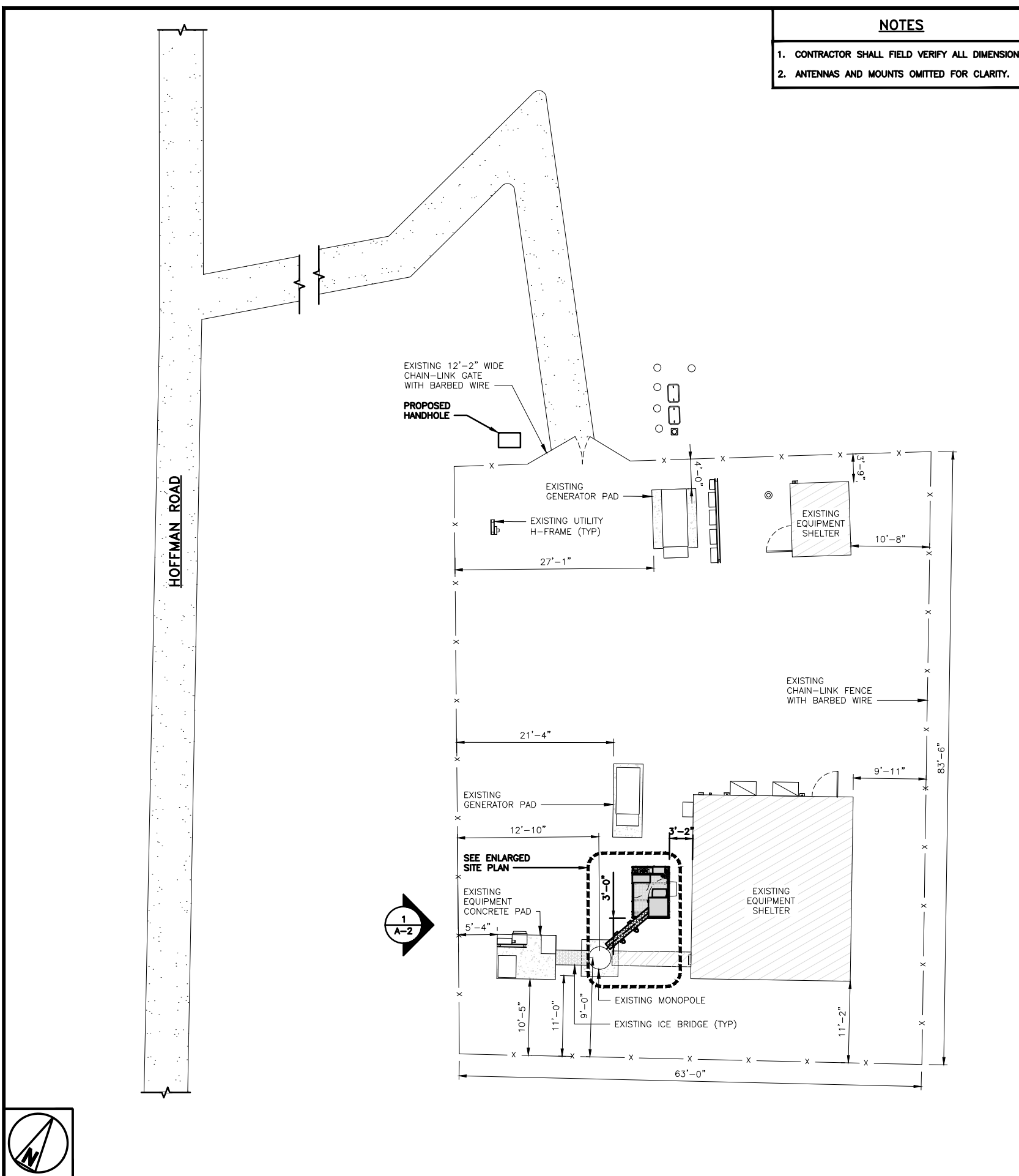

**dish wireless.**

5701 SOUTH SANTA FE DRIVE  
LITTLETON, CO 80120

**AMERICAN TOWER**  
10 PRESIDENTIAL WAY  
WOBURN, MA 01801

**B+T GRP**  
1717 S. BOULDER  
SUITE 300  
TULSA, OK 74119  
PH: (918) 587-4630  
www.btgrp.com

**PROFESSIONAL ENGINEER**  
No. 23924  
LICENSED  
8/2/21

**B&T ENGINEERING, INC.**  
PEC.0001564  
Expires 2/10/22

IT IS A VIOLATION OF LAW FOR ANY PERSON, UNLESS THEY ARE ACTING UNDER THE DIRECTION OF A LICENSED PROFESSIONAL ENGINEER, TO ALTER THIS DOCUMENT.

DRAWN BY: CD    CHECKED BY: CD    APPROVED BY: RCM

RFDS REV #: 0

**CONSTRUCTION DOCUMENTS**

SUBMITTALS		
REV	DATE	DESCRIPTION
A	7/26/21	ISSUED FOR REVIEW
0	8/2/21	ISSUED FOR CONSTRUCTION

A&E PROJECT NUMBER  
153478.001.01

DISH Wireless L.L.C.  
PROJECT INFORMATION

BOBDL00152B  
4 HOFFMANN ROAD  
CANTON, CT 06019

SHEET TITLE  
OVERALL AND ENLARGED  
SITE PLAN

SHEET NUMBER  
**A-1**

**NOTES**

1. CONTRACTOR SHALL FIELD VERIFY ALL DIMENSIONS.
2. ANTENNA AND MW DISH SPECIFICATIONS REFER TO ANTENNA SCHEDULE AND TO FINAL CONSTRUCTION RFDS FOR ALL RF DETAILS
3. EXISTING EQUIPMENT AND FENCE OMITTED FOR CLARITY.

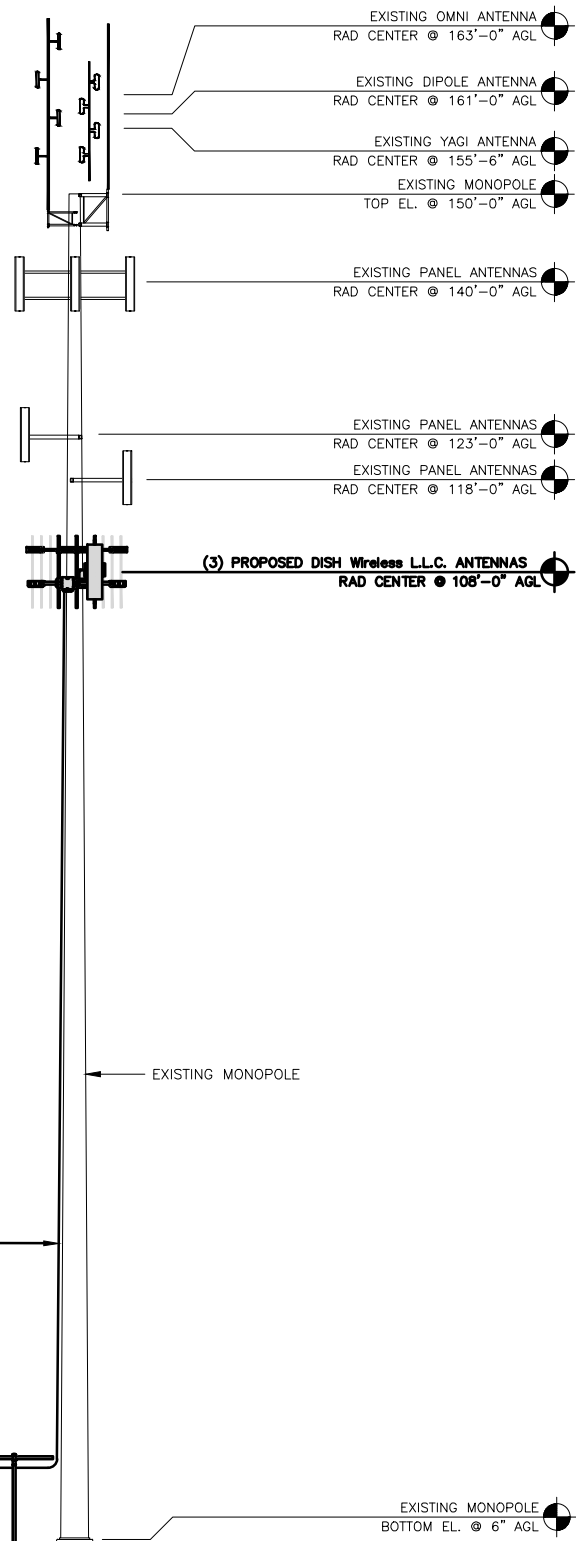

(1) PROPOSED DISH Wireless L.L.C. HYBRID CABLE ROUTED OUTSIDE POLE

PROPOSED DISH Wireless L.L.C. ICE BRIDGE

PROPOSED DISH Wireless L.L.C. GPS UNIT

PROPOSED DISH Wireless L.L.C. EQUIPMENT ON PROPOSED STEEL PLATFORM

**PROPOSED WEST ELEVATION**

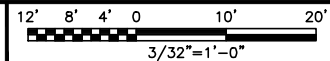

1

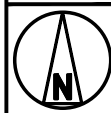
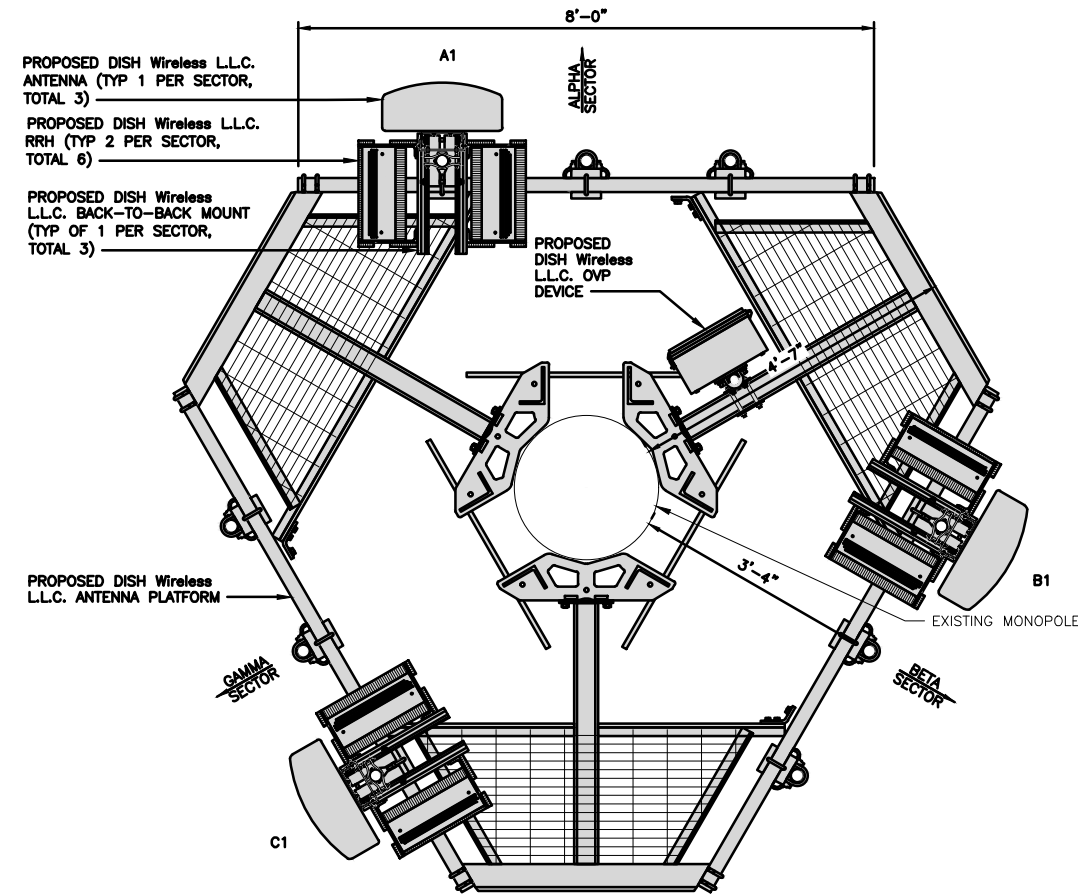

**ANTENNA LAYOUT**

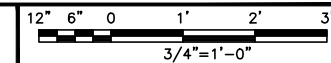

2

SECTOR	POSITION	ANTENNA					TRANSMISSION CABLE	
		EXISTING OR PROPOSED	MANUFACTURER - MODEL NUMBER	TECHNOLOGY	SIZE (HxW)	AZIMUTH	RAD CENTER	FEED LINE TYPE AND LENGTH
ALPHA	A1	PROPOSED	JMA WIRELESS-MX08FR0665-21	5G	72.0" x 20.0"	0°	108'-0"	(1) HIGH-CAPACITY HYBRID CABLE (140' LONG)
BETA	B1	PROPOSED	JMA WIRELESS-MX08FR0665-21	5G	72.0" x 20.0"	120°	108'-0"	
GAMMA	C1	PROPOSED	JMA WIRELESS-MX08FR0665-21	5G	72.0" x 20.0"	240°	108'-0"	

SECTOR	POSITION	RRH		NOTES
		MANUFACTURER - MODEL NUMBER	TECHNOLOGY	
ALPHA	A1	FUJITSU - TA08025-B605	5G	1. CONTRACTOR TO REFER TO FINAL CONSTRUCTION RFDS FOR ALL RF DETAILS. 2. ANTENNA AND RRH MODELS MAY CHANGE DUE TO EQUIPMENT AVAILABILITY. ALL EQUIPMENT CHANGES MUST BE APPROVED AND REMAIN IN COMPLIANCE WITH THE PROPOSED DESIGN AND STRUCTURAL ANALYSES.
	A1	FUJITSU - TA08025-B604	5G	
BETA	B1	FUJITSU - TA08025-B605	5G	
	B1	FUJITSU - TA08025-B604	5G	
GAMMA	C1	FUJITSU - TA08025-B605	5G	
	C1	FUJITSU - TA08025-B604	5G	

OVP		
EXISTING OR PROPOSED	MANUFACTURER - MODEL NUMBER	SIZE (HxWxD)
PROPOSED	RAYCAP-RDIDC-9181-PF-48	16"x14"x8"

**ANTENNA SCHEDULE**

NO SCALE

3



5701 SOUTH SANTA FE DRIVE  
LITTLETON, CO 80120



**B&T ENGINEERING, INC.**  
PEC.0001564  
Expires 2/10/22

IT IS A VIOLATION OF LAW FOR ANY PERSON, UNLESS THEY ARE ACTING UNDER THE DIRECTION OF A LICENSED PROFESSIONAL ENGINEER, TO ALTER THIS DOCUMENT.

DRAWN BY:	CHECKED BY:	APPROVED BY:
CD	CD	RCM

RFDS REV #: 0

**CONSTRUCTION DOCUMENTS**

SUBMITTALS		
REV	DATE	DESCRIPTION
A	7/28/21	ISSUED FOR REVIEW
0	8/2/21	ISSUED FOR CONSTRUCTION

A&E PROJECT NUMBER  
153478.001.01

DISH Wireless L.L.C. PROJECT INFORMATION  
BOBDL00152B  
4 HOFFMANN ROAD  
CANTON, CT 06019

SHEET TITLE  
ELEVATION, ANTENNA LAYOUT AND SCHEDULE

SHEET NUMBER

**A-2**



5701 SOUTH SANTA FE DRIVE  
LITTLETON, CO 80120



B&T ENGINEERING, INC.  
PEC.0001564  
Expires 2/10/22

IT IS A VIOLATION OF LAW FOR ANY PERSON, UNLESS THEY ARE ACTING UNDER THE DIRECTION OF A LICENSED PROFESSIONAL ENGINEER, TO ALTER THIS DOCUMENT.

DRAWN BY: CD CHECKED BY: CD APPROVED BY: RCM

RFDS REV #: 0

**CONSTRUCTION DOCUMENTS**

SUBMITTALS		
REV	DATE	DESCRIPTION
A	7/26/21	ISSUED FOR REVIEW
0	8/2/21	ISSUED FOR CONSTRUCTION

A&E PROJECT NUMBER  
153478.001.01

DISH Wireless L.L.C.  
PROJECT INFORMATION

BOBDL00152B  
4 HOFFMANN ROAD  
CANTON, CT 06019

SHEET TITLE  
EQUIPMENT PLATFORM AND  
H-FRAME DETAILS

SHEET NUMBER

**A-3**

**NOTES**

1. CONTRACTOR TO BURY PLATFORM FEET WITH A MINIMUM OF 2" OF FILL PER EXISTING SITE SURFACE
2. WEED BARRIER FABRIC TO BE ADDED AT DISCRETION OF DISH Wireless L.L.C. CONSTRUCTION MANAGER AT TIME OF CONSTRUCTION. ONE SHEET 8'x8' INSTALLED UNDER ALL FOUR FEET OF THE PLATFORM (4 MIL BLACK PLASTIC)
3. EQUIPMENT CABINET OMITTED FOR CLARITY

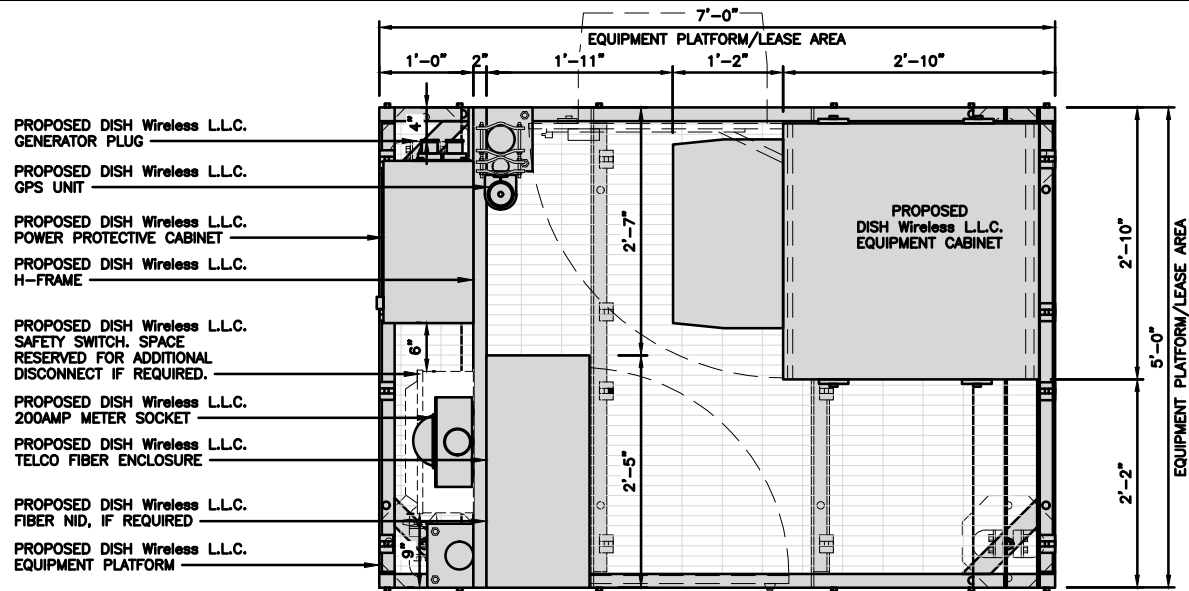

PLATFORM EQUIPMENT PLAN

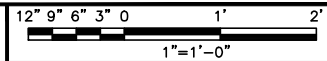

1

<b>COMMSCOPE MTC4045LP 5X7 PLATFORM</b>	
DIMENSIONS (HxWxD)	16"x84"x60"
TOTAL WEIGHT	423 LBS

NOTE:  
GC TO PROVIDE EXTENDED  
THREAD FOR PLATFORM IF  
REQUIRED HEIGHT EXCEEDS 17"

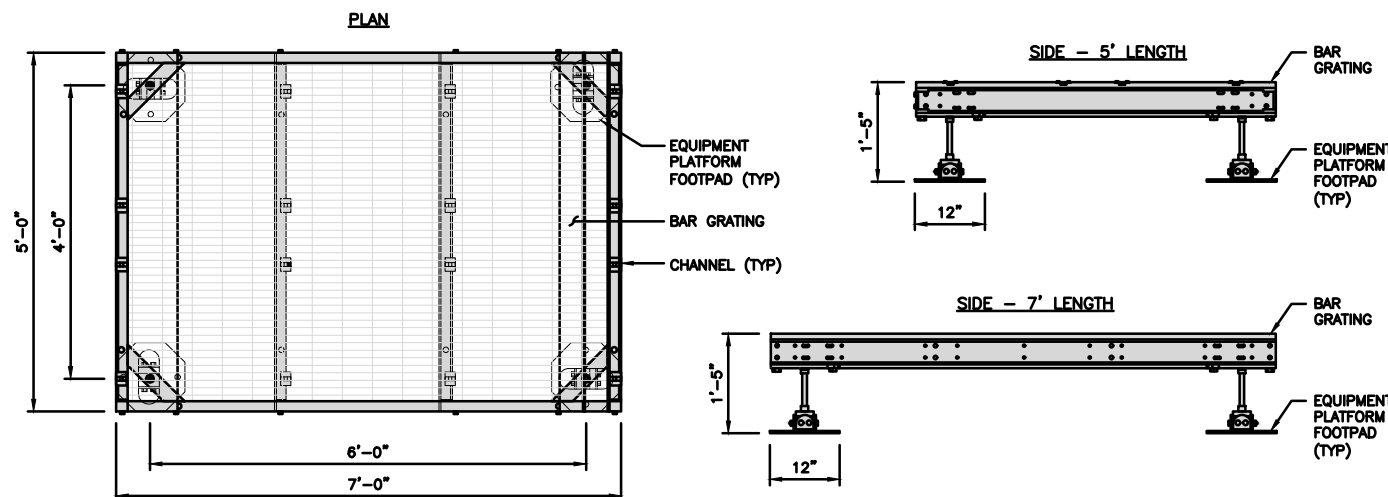

PLATFORM DETAIL

NO SCALE 2

<b>COMMSCOPE MTC4045HFLD H-FRAME</b>	
UNISTRUT/SUPPORT RAILS QTY	5
WEIGHT	59.74 lbs

NOTE:  
OR DISH Wireless L.L.C.  
APPROVED EQUIVALENT

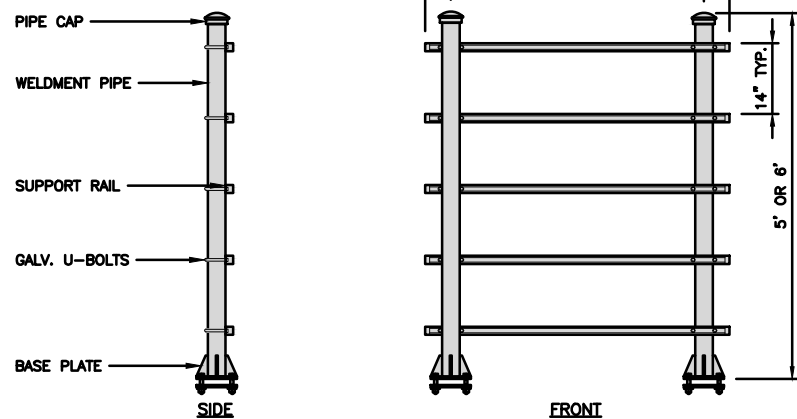

H-FRAME DETAIL

NO SCALE 3

NOT USED

NO SCALE 4

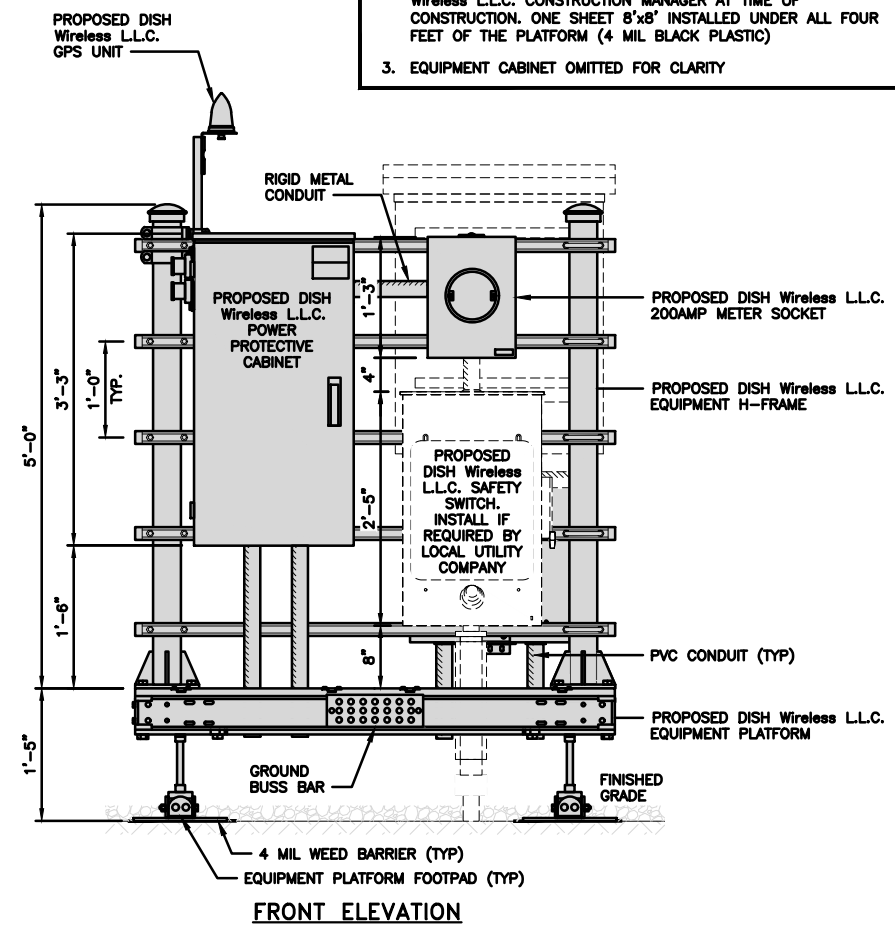

FRONT ELEVATION

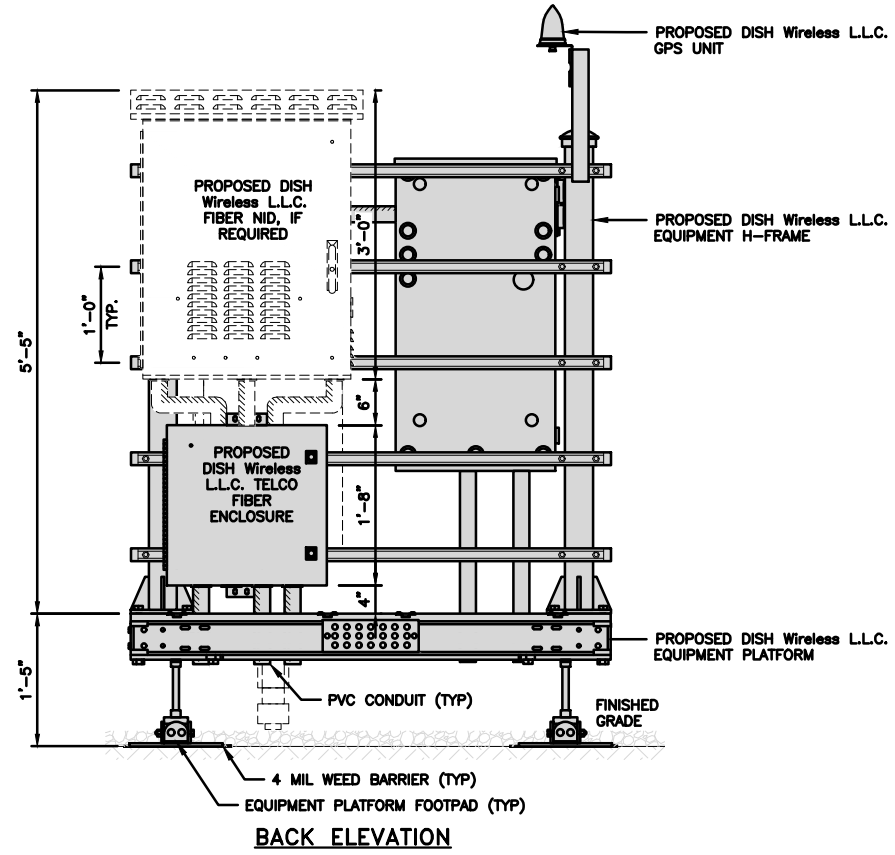

BACK ELEVATION

H-FRAME EQUIPMENT ELEVATION

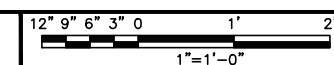

5

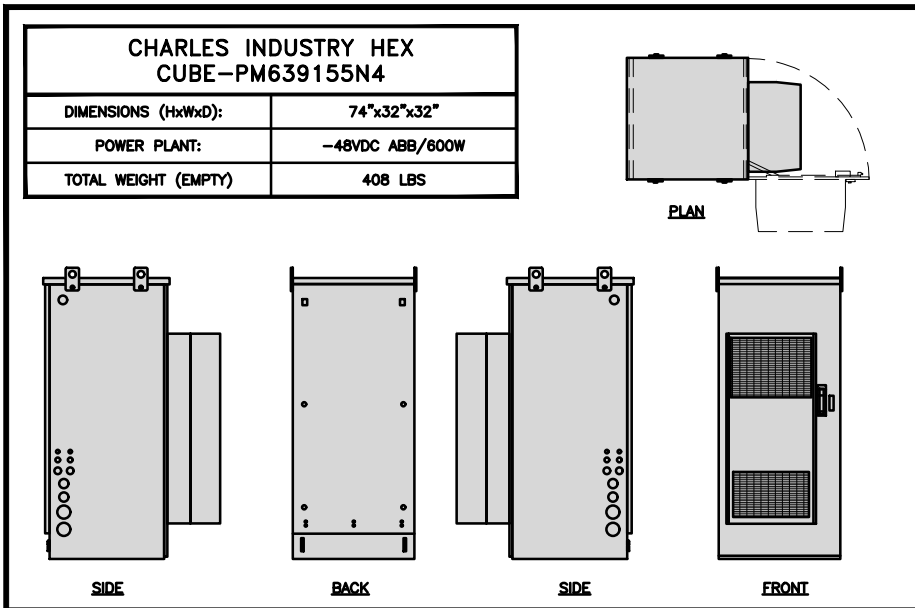

CABINET DETAIL NO SCALE 1

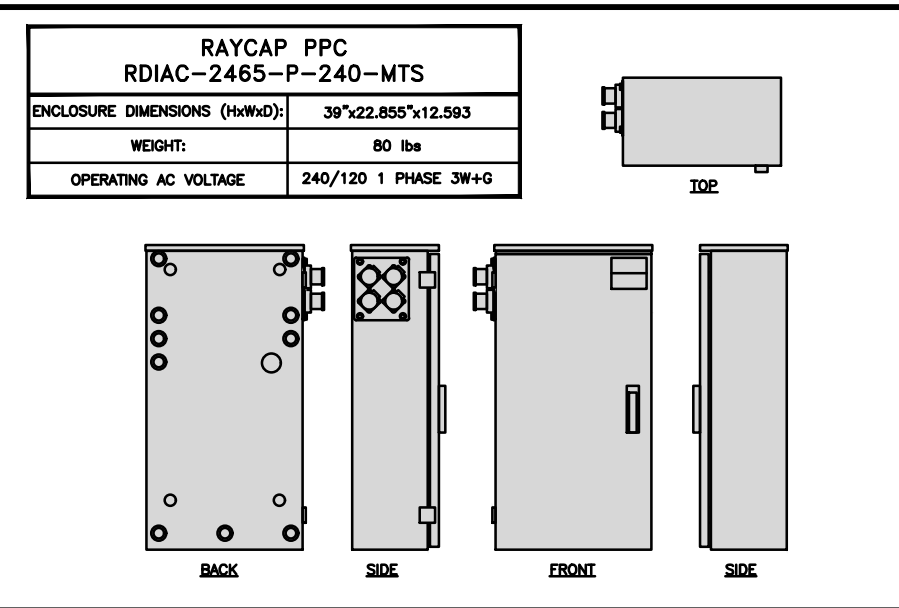

POWER PROTECTION CABINET (PPC) DETAIL NO SCALE 2

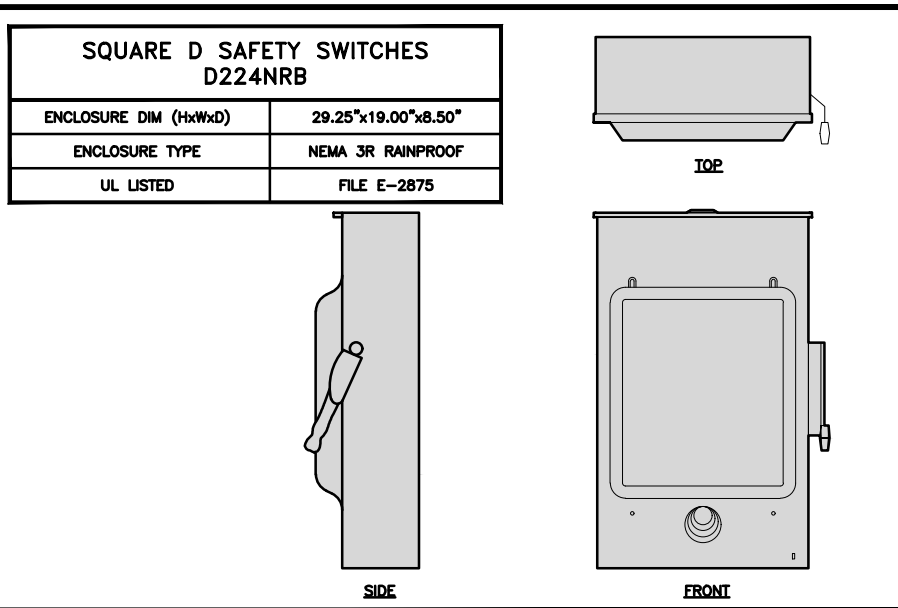

SAFETY SWITCH DETAIL NO SCALE 3

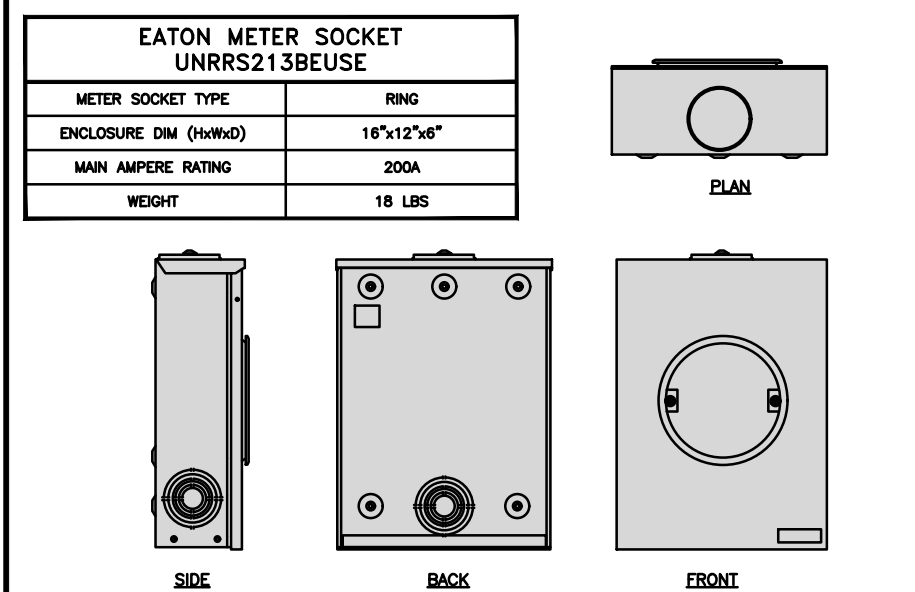

METER SOCKET DETAIL NO SCALE 4

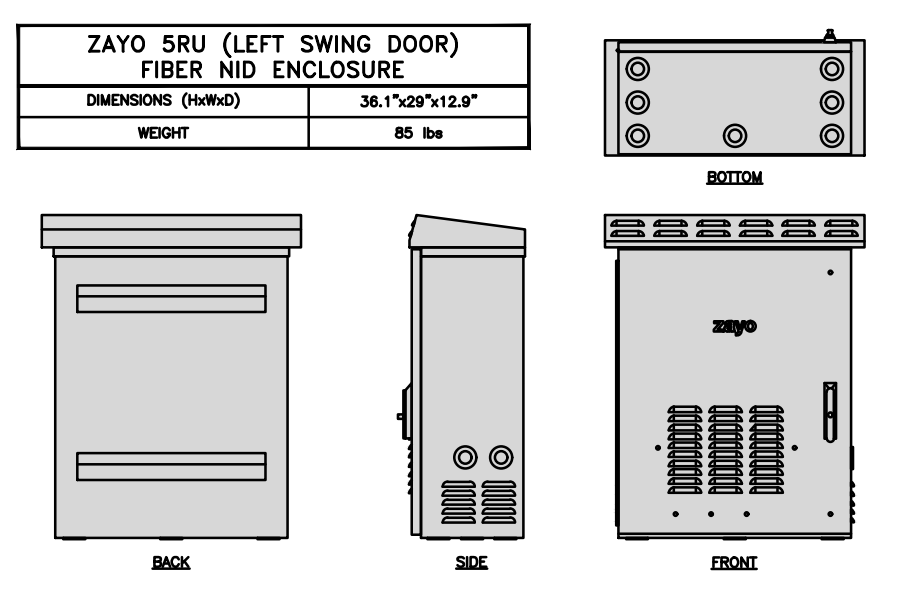

FIBER NID ENCLOSURE DETAIL NO SCALE 5

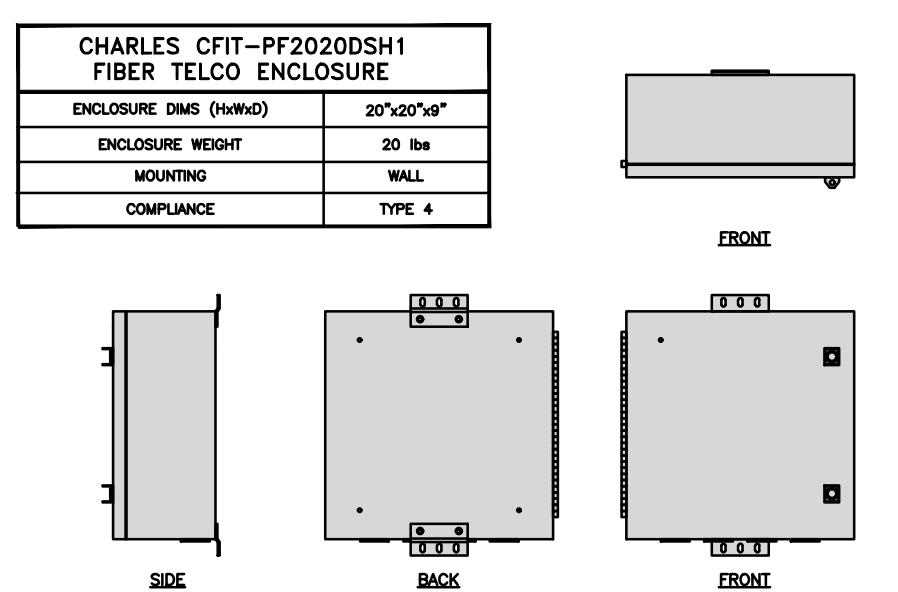

FIBER TELCO ENCLOSURE DETAIL NO SCALE 6

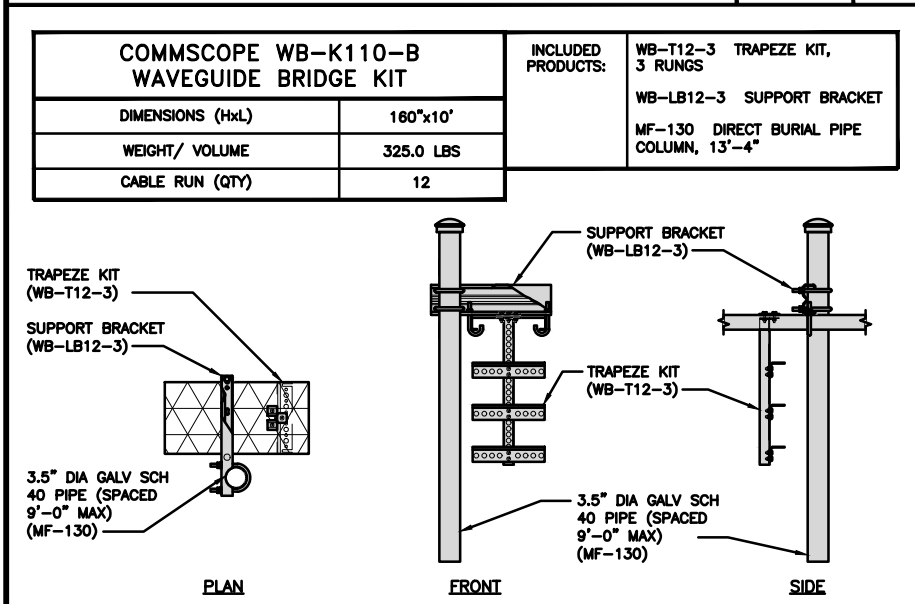

ICE BRIDGE DETAIL NO SCALE 7

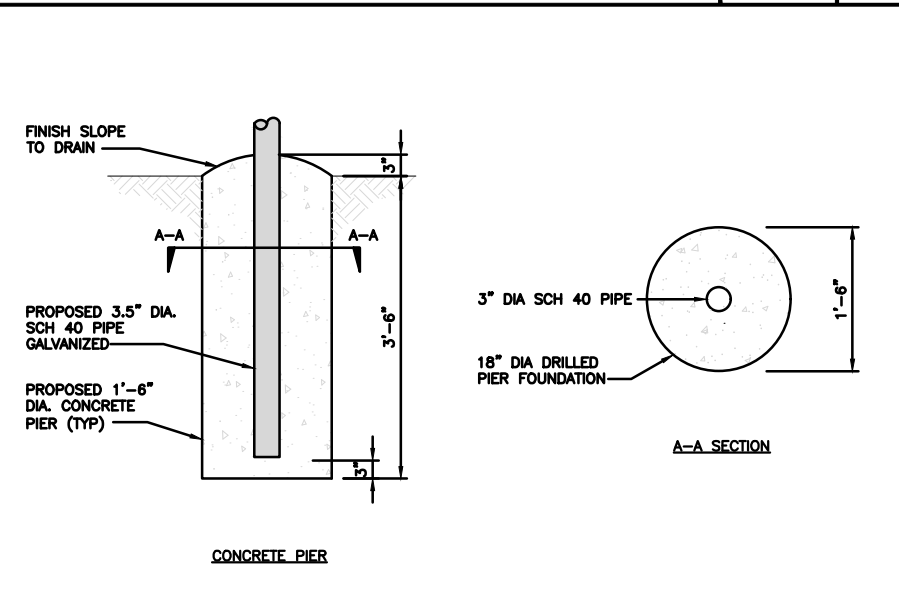

TYPICAL ICE BRIDGE CONCRETE PIER DETAIL NO SCALE 8

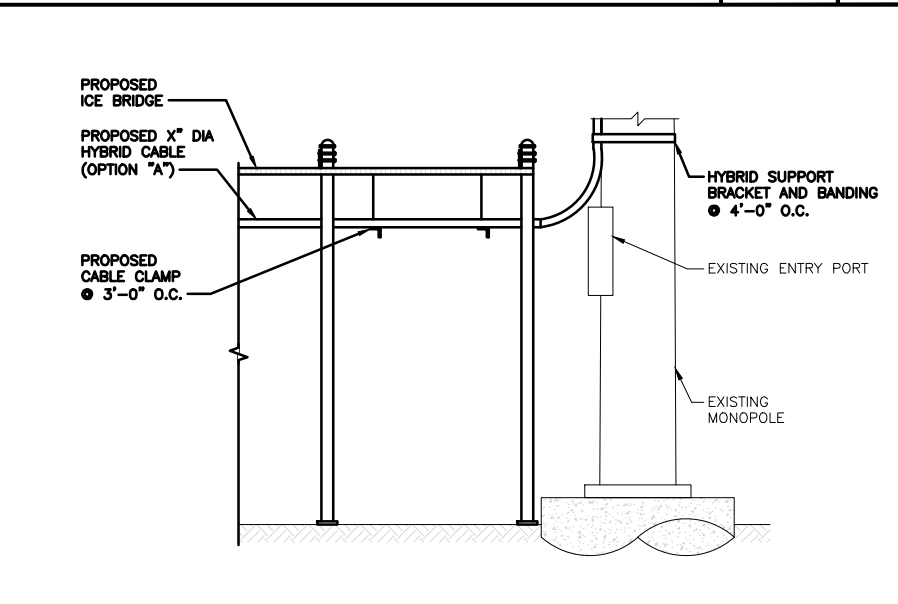

HYBRID CABLE RUN NO SCALE 9

5701 SOUTH SANTA FE DRIVE  
LITTLETON, CO 80120

10 PRESIDENTIAL WAY  
WOBURN, MA 01801

1717 S. BOULDER  
SUITE 300  
TULSA, OK 74119  
PH: (918) 587-4630  
www.btgrp.com

**B&T ENGINEERING, INC.**  
PEC.0001564  
Expires 2/10/22

IT IS A VIOLATION OF LAW FOR ANY PERSON, UNLESS THEY ARE ACTING UNDER THE DIRECTION OF A LICENSED PROFESSIONAL ENGINEER, TO ALTER THIS DOCUMENT.

DRAWN BY:	CHECKED BY:	APPROVED BY:
CD	CD	RCM
RFDS REV #:		0

**CONSTRUCTION DOCUMENTS**

SUBMITTALS		
REV	DATE	DESCRIPTION
A	7/26/21	ISSUED FOR REVIEW
0	8/2/21	ISSUED FOR CONSTRUCTION

A&E PROJECT NUMBER  
153478.001.01

DISH Wireless L.L.C.  
PROJECT INFORMATION

BOBDL00152B  
4 HOFFMANN ROAD  
CANTON, CT 06019

SHEET TITLE  
EQUIPMENT DETAILS

SHEET NUMBER  
**A-4**

PCTEL GPSGL-TMG-SPI-40NCB	
DIMENSIONS (DIAxH) MM/INCH	81x184mm 3.2"x7.25"
WEIGHT W/ACCESSORIES	075 lbs
CONNECTOR	N-FEMALE
FREQUENCY RANGE	1590 ± 30MHz

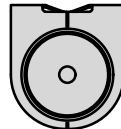

TOP

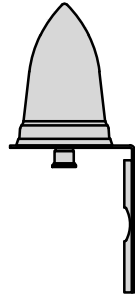

BACK

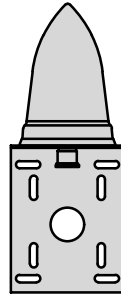

SIDE

GPS DETAIL

NO SCALE

1

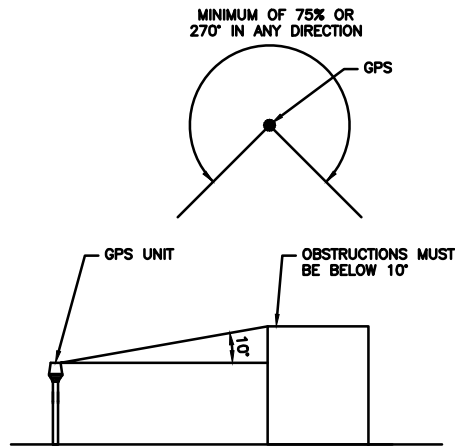

GPS MINIMUM SKY VIEW REQUIREMENTS

NO SCALE

2

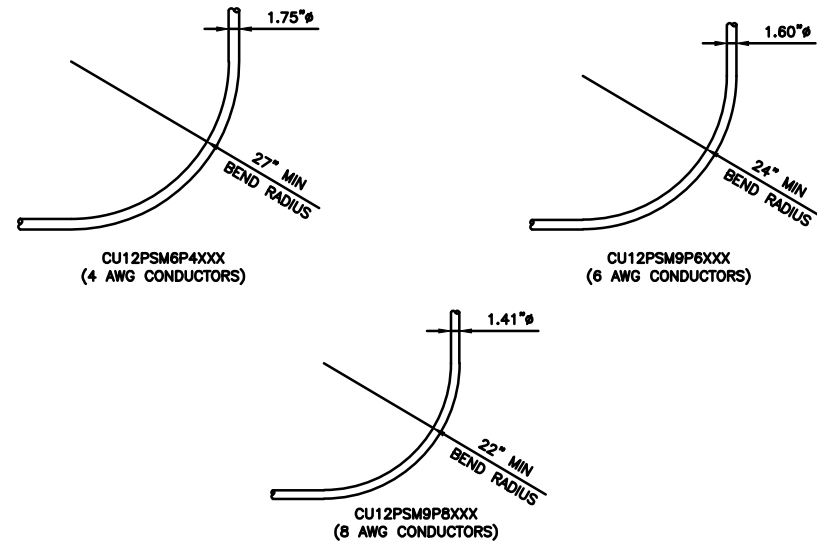

CABLES UNLIMITED HYBRID CABLE  
MINIMUM BEND RADIUS

NO SCALE

3

NOT USED

NO SCALE

4

NOT USED

NO SCALE

5

NOT USED

NO SCALE

6

NOT USED

NO SCALE

7

NOT USED

NO SCALE

8

NOT USED

NO SCALE

9



5701 SOUTH SANTA FE DRIVE  
LITTLETON, CO 80120



B&T ENGINEERING, INC.  
PEC.0001564  
Expires 2/10/22

IT IS A VIOLATION OF LAW FOR ANY PERSON,  
UNLESS THEY ARE ACTING UNDER THE DIRECTION  
OF A LICENSED PROFESSIONAL ENGINEER,  
TO ALTER THIS DOCUMENT.

DRAWN BY:	CHECKED BY:	APPROVED BY:
CD	CD	RCM

RFDS REV #: 0

CONSTRUCTION DOCUMENTS

SUBMITTALS		
REV	DATE	DESCRIPTION
A	7/28/21	ISSUED FOR REVIEW
0	8/2/21	ISSUED FOR CONSTRUCTION

A&E PROJECT NUMBER  
153478.001.01

DISH Wireless L.L.C.  
PROJECT INFORMATION  
BOBDL00152B  
4 HOFFMANN ROAD  
CANTON, CT 06019

SHEET TITLE  
EQUIPMENT DETAILS

SHEET NUMBER  
A-5

FUJITSU TRIPLE BAND TA08025-B605	
DIMENSIONS (HxWxD)	14.9"x15.7"x9"
WEIGHT	74.95 lbs
CONNECTOR TYPE	4.3-10 RF CONNECTOR
POWER SUPPLY	DC -58~-36V

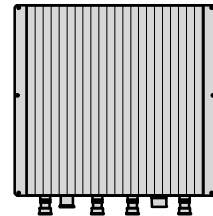
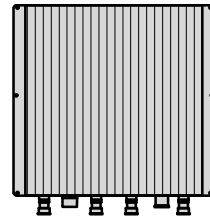
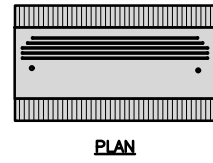

RRH DETAIL

NO SCALE

1

FUJITSU DUAL BAND TA08025-B604	
DIMENSIONS (HxWxD)	14.9"x15.7"x7.8"
WEIGHT	63.9 lbs
CONNECTOR TYPE	4.3-10 RF CONNECTOR
POWER SUPPLY	DC -58~-36V

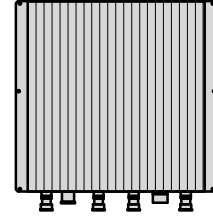
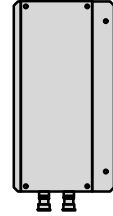
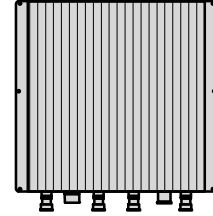
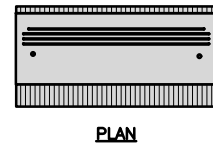

RRH DETAIL

NO SCALE

2

SABRE DOUBLE Z-BRACKET C10123155	
DIMENSIONS (HxWxD) (1 BRACKET)	5"x20"x1-13/16"
WEIGHT (FULL ASSEMBLY)	35.79 lbs
PACKAGE QUANTITY	4

#	DESCRIPTION
1	PLATE, CHANNEL BRACKET
2	RRH Z BRACKET, 3/16"
3	THREADED ROD ASSEMBLY 1/2"x12"

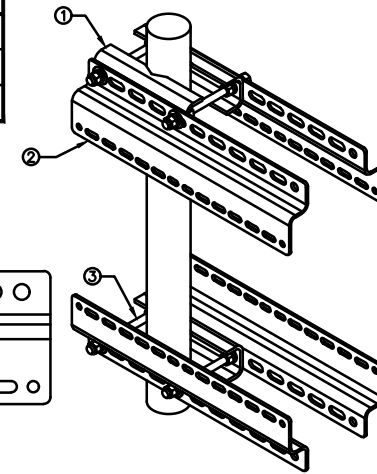
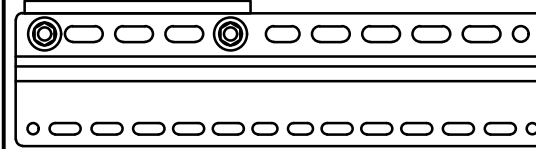

NOTE:  
OR DISH Wireless L.L.C.  
APPROVED EQUIVALENT

RRH MOUNT DETAIL

NO SCALE

3

JMA MX08FRO665-21	
DIMENSIONS (HxWxD)	72"x20.0"x8.0"
RF PORTS, CONNECTOR TYPE	8 x 4.3-10 FEMALE
WEIGHT	64.5 lbs
WEIGHT WITH BRACKETS	82.5 lbs

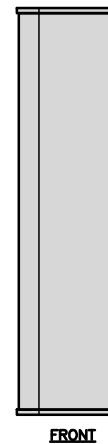
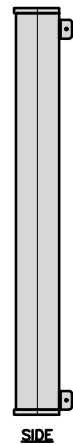
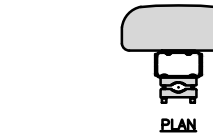

ANTENNA DETAIL

NO SCALE

4

JMA ANTENNA MOUNT BRACKET #91900318	
TOTAL WEIGHT (WITH BRACKETS)	18 lbs (8.18 Kg)
POLE DIAMETER RANGE	2.5" TO 4.5"

NOTE:  
KIT #91900318: TOP AND BOTTOM BRACKETS  
FOR 4-, 6-, AND 8-FOOT ANTENNAS  
ANTENNA BRACKET NOT PART OF KIT

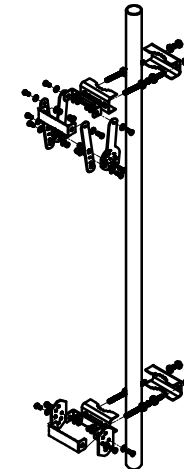

NOTE:  
OR DISH Wireless L.L.C.  
APPROVED EQUIVALENT

ANTENNA BRACKET DETAIL

NO SCALE

6

RAYCAP RDIC-9181-PF-48 DC SURGE PROTECTION (OVP)	
DIMENSIONS (HxWxD)	18.98"x14.39"x8.15"
WEIGHT	21.82 LBS

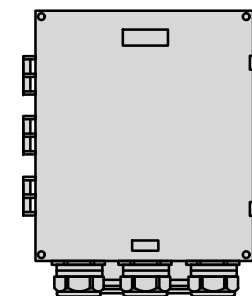
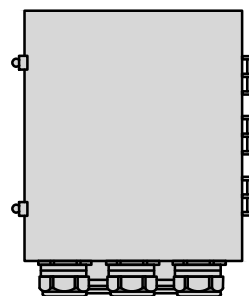
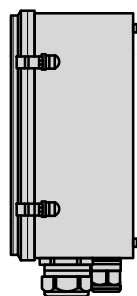
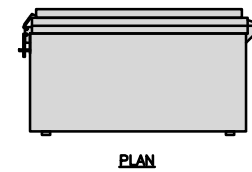

SURGE SUPPRESSION DETAIL (OVP)

NO SCALE

7

COMMSCOPE XP-2040 CROSSOVER PLATE	
DIMENSIONS (HxW)	10"x12"
WEIGHT	11 lbs

NOTE:  
OR DISH Wireless L.L.C.  
APPROVED EQUIVALENT

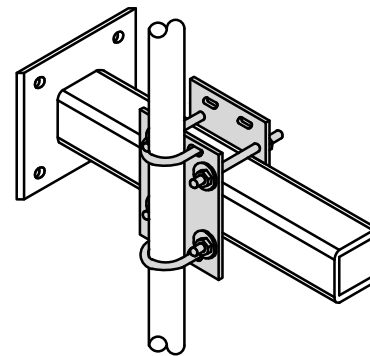
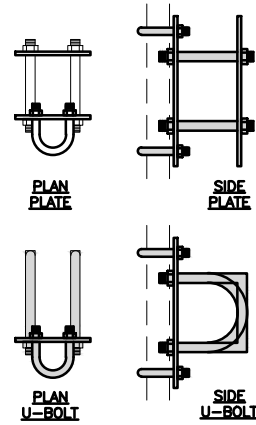

RRH/OVP MOUNT DETAIL

NO SCALE

8

COMMSCOPE MC-PK8-DSH	
FACE WIDTH	96"
WEIGHT	1373.08 lbs
NOTE: 15" TO 38" O.D.	

NOTE:  
OR DISH Wireless L.L.C.  
APPROVED EQUIVALENT

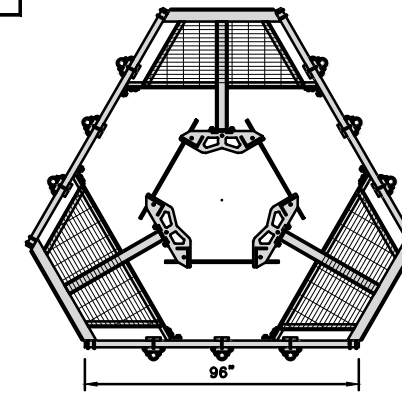
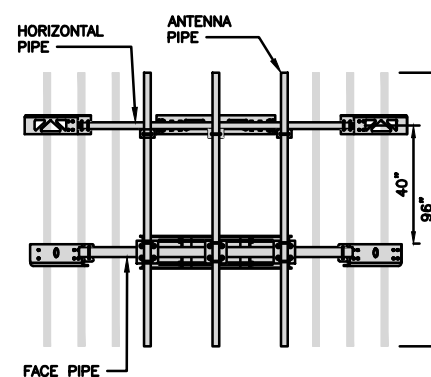

ANTENNA PLATFORM DETAIL

NO SCALE

9



5701 SOUTH SANTA FE DRIVE  
LITTLETON, CO 80120



B&T ENGINEERING, INC.  
PEC.0001564  
Expires 2/10/22

IT IS A VIOLATION OF LAW FOR ANY PERSON,  
UNLESS THEY ARE ACTING UNDER THE DIRECTION  
OF A LICENSED PROFESSIONAL ENGINEER,  
TO ALTER THIS DOCUMENT.

DRAWN BY:	CHECKED BY:	APPROVED BY:
CD	CD	RCM

RFDS REV #: 0

CONSTRUCTION DOCUMENTS

SUBMITTALS		
REV	DATE	DESCRIPTION
A	7/26/21	ISSUED FOR REVIEW
0	8/2/21	ISSUED FOR CONSTRUCTION

A&E PROJECT NUMBER  
153478.001.01

DISH Wireless L.L.C.  
PROJECT INFORMATION  
BOBDL00152B  
4 HOFFMANN ROAD  
CANTON, CT 06019

SHEET TITLE  
EQUIPMENT DETAILS

SHEET NUMBER

A-6



**NOTES**

1. CONTRACTOR SHALL FIELD VERIFY ALL PROPOSED UNDERGROUND UTILITY CONDUIT ROUTE.
2. ANTENNAS AND MOUNTS OMITTED FOR CLARITY.

DC POWER WIRING SHALL BE COLOR CODED AT EACH END FOR IDENTIFYING +24V AND -48V CONDUCTORS. RED MARKINGS SHALL IDENTIFY +24V AND BLUE MARKINGS SHALL IDENTIFY -48V.

1. CONTRACTOR SHALL INSPECT THE EXISTING CONDITIONS PRIOR TO SUBMITTING A BID. ANY QUESTIONS ARISING DURING THE BID PERIOD IN REGARDS TO THE CONTRACTOR'S FUNCTIONS, THE SCOPE OF WORK, OR ANY OTHER ISSUE RELATED TO THIS PROJECT SHALL BE BROUGHT UP DURING THE BID PERIOD WITH THE PROJECT MANAGER FOR CLARIFICATION, NOT AFTER THE CONTRACT HAS BEEN AWARDED.
2. ALL ELECTRICAL WORK SHALL BE DONE IN ACCORDANCE WITH CURRENT NATIONAL ELECTRICAL CODES AND ALL STATE AND LOCAL CODES, LAWS, AND ORDINANCES. PROVIDE ALL COMPONENTS AND WIRING SIZES AS REQUIRED TO MEET NEC STANDARDS.
3. LOCATION OF EQUIPMENT, CONDUIT AND DEVICES SHOWN ON THE DRAWINGS ARE APPROXIMATE AND SHALL BE COORDINATED WITH FIELD CONDITIONS PRIOR TO CONSTRUCTION.
4. CONDUIT ROUGH-IN SHALL BE COORDINATED WITH THE MECHANICAL EQUIPMENT TO AVOID LOCATION CONFLICTS. VERIFY WITH THE MECHANICAL EQUIPMENT CONTRACTOR AND COMPLY AS REQUIRED.
5. CONTRACTOR SHALL PROVIDE ALL BREAKERS, CONDUITS AND CIRCUITS AS REQUIRED FOR A COMPLETE SYSTEM.
6. CONTRACTOR SHALL PROVIDE PULL BOXES AND JUNCTION BOXES AS REQUIRED BY THE NEC ARTICLE 314.
7. CONTRACTOR SHALL PROVIDE ALL STRAIN RELIEF AND CABLE SUPPORTS FOR ALL CABLE ASSEMBLIES. INSTALLATION SHALL BE IN ACCORDANCE WITH MANUFACTURER'S SPECIFICATIONS AND RECOMMENDATIONS.
8. ALL DISCONNECTS AND CONTROLLING DEVICES SHALL BE PROVIDED WITH ENGRAVED PHENOLIC NAMEPLATES INDICATING EQUIPMENT CONTROLLED, BRANCH CIRCUITS INSTALLED ON, AND PANEL FIELD LOCATIONS FED FROM.
9. INSTALL AN EQUIPMENT GROUNDING CONDUCTOR IN ALL CONDUITS PER THE SPECIFICATIONS AND NEC 250. THE EQUIPMENT GROUNDING CONDUCTORS SHALL BE BONDED AT ALL JUNCTION BOXES, PULL BOXES, AND ALL DISCONNECT SWITCHES, AND EQUIPMENT CABINETS.
10. ALL NEW MATERIAL SHALL HAVE A U.L. LABEL.
11. PANEL SCHEDULE LOADING AND CIRCUIT ARRANGEMENTS REFLECT POST-CONSTRUCTION EQUIPMENT.
12. CONTRACTOR SHALL BE RESPONSIBLE FOR AS-BUILT PANEL SCHEDULE AND SITE DRAWINGS.
13. ALL TRENCHES IN COMPOUND TO BE HAND DUG
14. AN EXISTING CONDITIONS SURVEY WAS NOT AVAILABLE AT THE TIME THIS DRAWING'S CREATION

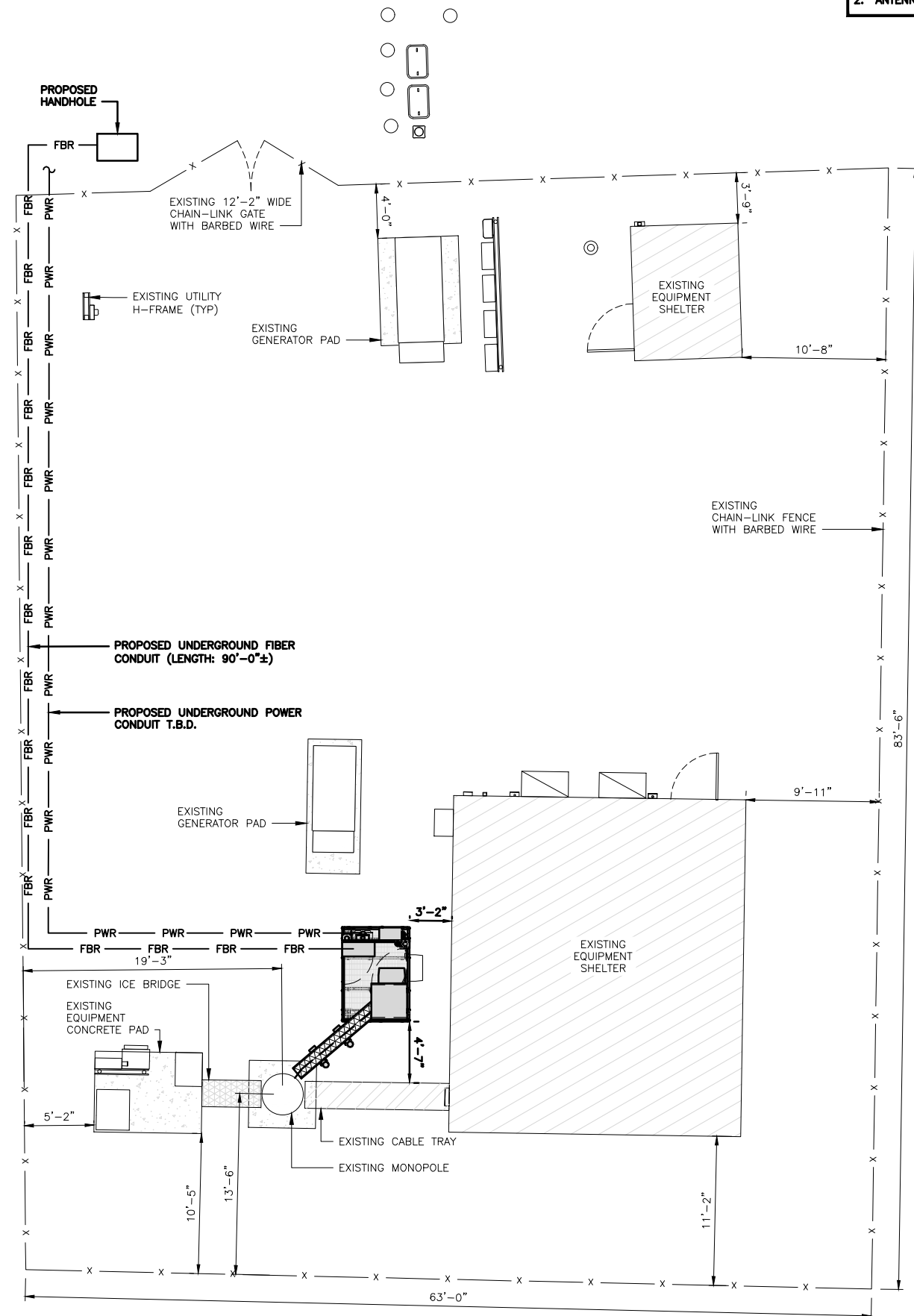

**UTILITY ROUTE PLAN**

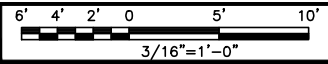

1



AN EXISTING CONDITIONS SURVEY WAS NOT AVAILABLE AT THE TIME THIS DRAWINGS CREATION

**AERIAL PLAN**

NO SCALE 2



5701 SOUTH SANTA FE DRIVE  
LITTLETON, CO 80120



**B&T ENGINEERING, INC.**  
PEC.0001564  
Expires 2/10/22

IT IS A VIOLATION OF LAW FOR ANY PERSON, UNLESS THEY ARE ACTING UNDER THE DIRECTION OF A LICENSED PROFESSIONAL ENGINEER, TO ALTER THIS DOCUMENT.

DRAWN BY:	CHECKED BY:	APPROVED BY:
CD	CD	RCM

RFDS REV #: 0

**CONSTRUCTION DOCUMENTS**

SUBMITTALS		
REV	DATE	DESCRIPTION
A	7/28/21	ISSUED FOR REVIEW
0	8/2/21	ISSUED FOR CONSTRUCTION

A&E PROJECT NUMBER  
153478.001.01

DISH Wireless L.L.C.  
PROJECT INFORMATION

BOBDL00152B  
4 HOFFMANN ROAD  
CANTON, CT 06019

SHEET TITLE  
**ELECTRICAL/FIBER ROUTE  
PLAN AND NOTES**

SHEET NUMBER  
**E-1**

CARLON EXPANSION FITTINGS				
COUPLING END PART#	MALE TERMINAL ADAPTER END PART#	SIZE	STD CTN QTY.	TRAVEL LENGTH
E945D	E945DX	1/2"	20	4"
E945E	E945EX	3/4"	15	4"
E945F	E945FX	1"	10	4"
E945G	E945GX	1 1/4"	5	4"
E945H	E945HX	1 1/2"	5	4"
E945J	E945JX	2"	15	8"
E945K	E945KX	2 1/2"	10	8"
E945L	E945LX	3"	10	8"
E945M	E945MX	3 1/2"	5	8"
E945N	E945NX	4"	5	8"
E945P	E945PX	5"	1	8"
E945R	E945RX	6"	1	8"

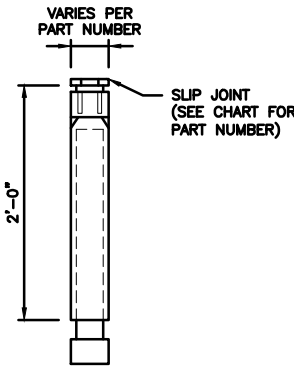

NOTE: CONTRACTOR TO INSTALL EXPANSION FITTING SLIP JOINT AT METER CENTER CONDUIT TERMINATION, AS PER LOCAL UTILITY POLICY, ORDINANCE AND/OR SPECIFIED REQUIREMENT.

**TRENCHING NOTES**

- CONTRACTOR SHALL RESTORE THE TRENCH TO ITS ORIGINAL CONDITIONS BY EITHER SEEDING OR SODDING GRASS AREAS, OR REPLACING ASPHALT OR CONCRETE AREAS TO ITS ORIGINAL CROSS SECTION.
- TRENCHING SAFETY; INCLUDING, BUT NOT LIMITED TO SOIL CLASSIFICATION, SLOPING, AND SHORING, SHALL BE GOVERNED BY THE CURRENT OSHA TRENCHING AND EXCAVATION SAFETY STANDARDS.
- ALL CONDUITS SHALL BE INSTALLED IN COMPLIANCE WITH THE CURRENT NATIONAL ELECTRIC CODE (NEC) OR AS REQUIRED BY THE LOCAL JURISDICTION, WHICHEVER IS THE MOST STRINGENT.

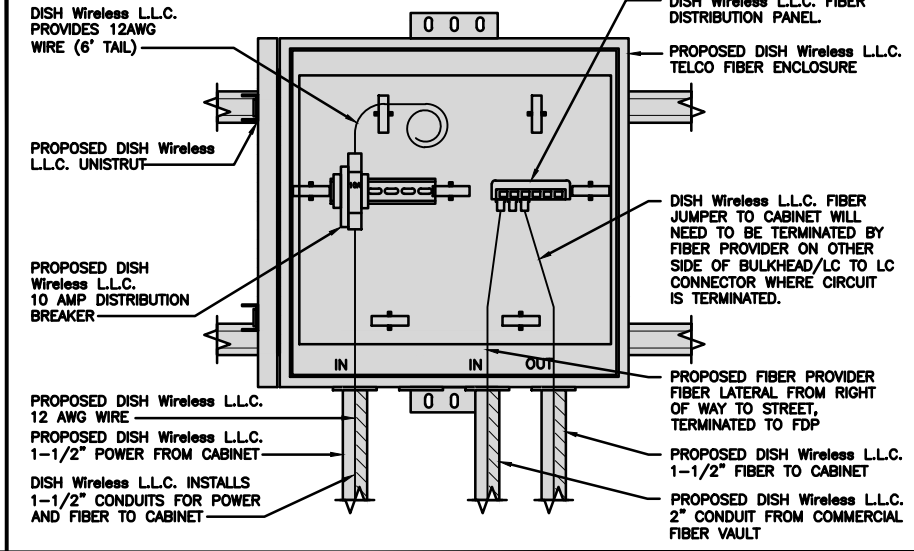
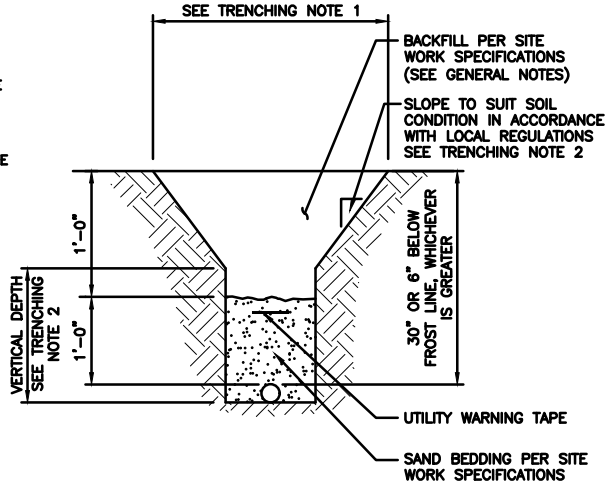

EXPANSION JOINT DETAIL

NO SCALE 1

TYPICAL UNDERGROUND TRENCH DETAIL

NO SCALE 2

DARK TELCO BOX – INTERIOR WIRING LAYOUT

NO SCALE 3

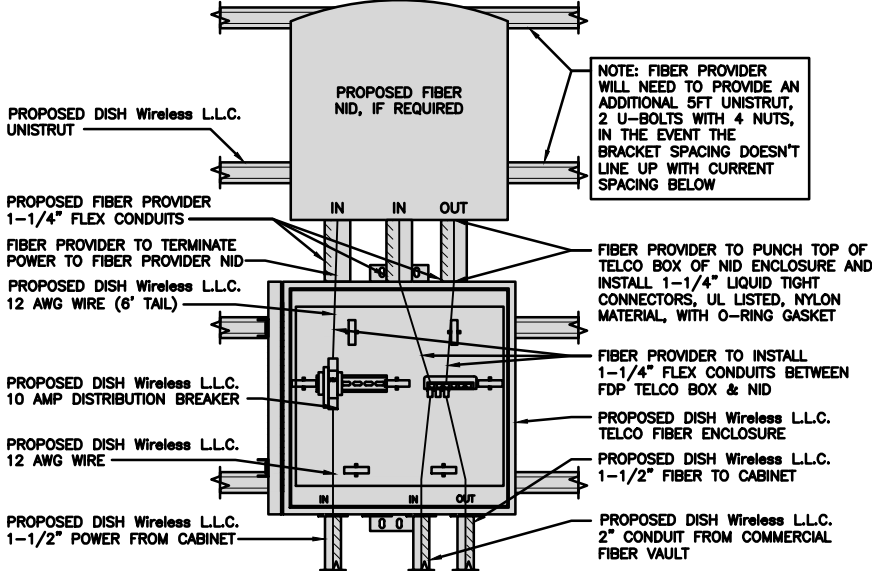

LIT TELCO BOX – INTERIOR WIRING LAYOUT (OPTIONAL)

NO SCALE 4

NOT USED

NO SCALE 5

NOT USED

NO SCALE 6

NOT USED

NO SCALE 8

NOT USED

NO SCALE 9



5701 SOUTH SANTA FE DRIVE  
LITTLETON, CO 80120



B&T ENGINEERING, INC.  
PEC.0001564  
Expires 2/10/22

IT IS A VIOLATION OF LAW FOR ANY PERSON, UNLESS THEY ARE ACTING UNDER THE DIRECTION OF A LICENSED PROFESSIONAL ENGINEER, TO ALTER THIS DOCUMENT.

DRAWN BY:	CHECKED BY:	APPROVED BY:
CD	CD	RCM
RFDS REV #:	0	

**CONSTRUCTION DOCUMENTS**

SUBMITTALS		
REV	DATE	DESCRIPTION
A	7/26/21	ISSUED FOR REVIEW
0	8/2/21	ISSUED FOR CONSTRUCTION

A&E PROJECT NUMBER  
153478.001.01

DISH Wireless L.L.C.  
PROJECT INFORMATION  
BOBDL00152B  
4 HOFFMANN ROAD  
CANTON, CT 06019

SHEET TITLE  
ELECTRICAL  
DETAILS

SHEET NUMBER  
**E-2**

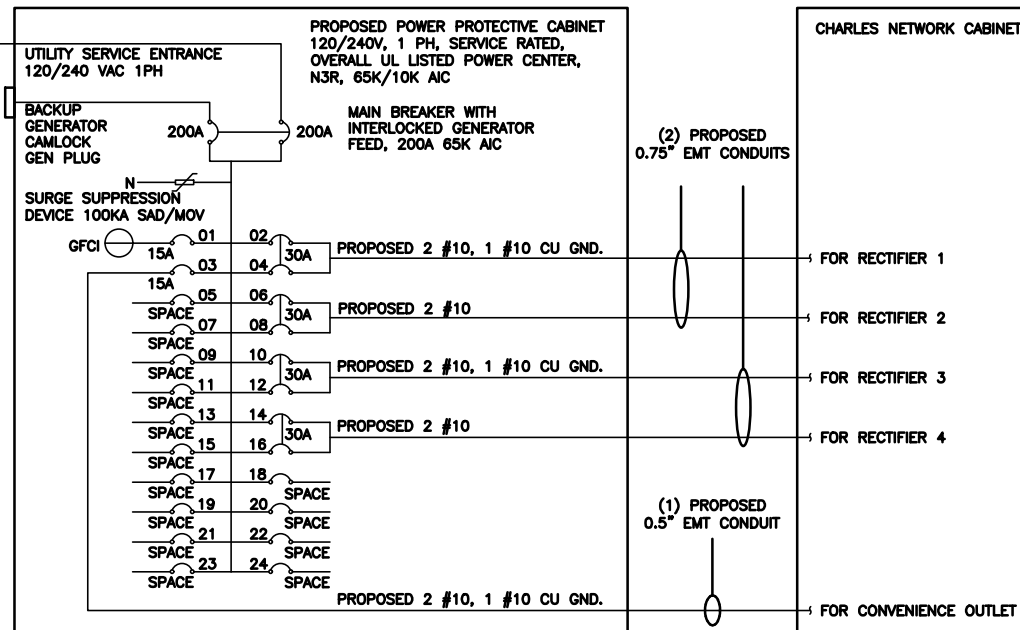
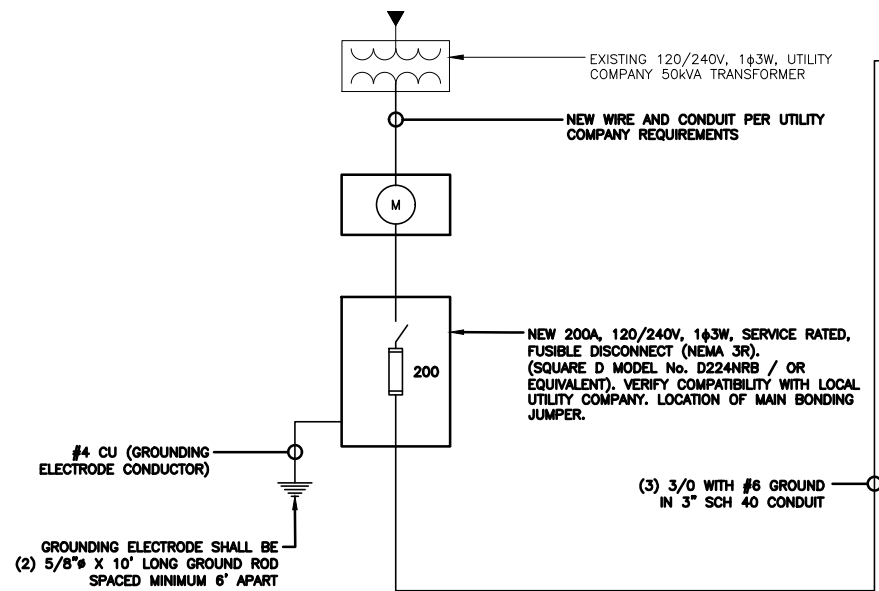

**NOTE:** BRANCH CIRCUIT WIRING SUPPLYING RECTIFIERS ARE TO BE RATED UL1015, 105°C, 600V, AND PVC INSULATED, IN THE SIZES SHOWN IN THE ONE-LINE DIAGRAM. CONTRACTOR MAY SUBSTITUTE UL1015 WIRE FOR THWN-2 FOR CONVENIENCE OUTLET BRANCH CIRCUIT.

**BREAKERS REQUIRED:**  
 (4) 30A, 2P BREAKER - SQUARE D P/N:Q0230  
 (1) 15A, 1P BREAKER - SQUARE D P/N:Q0115

**NOTES**

THE (2) CONDUITS WITH (4) CURRENT CARRYING CONDUCTORS EACH, SHALL APPLY THE ADJUSTMENT FACTOR OF 80% PER 2014/17 NEC TABLE 310.15(B)(3)(g) OR 2020 NEC TABLE 310.15(C)(1) FOR UL1015 WIRE.

#12 FOR 15A-20A/1P BREAKER: 0.8 x 30A = 24.0A  
 #10 FOR 25A-30A/2P BREAKER: 0.8 x 40A = 32.0A  
 #8 FOR 35A-40A/2P BREAKER: 0.8 x 55A = 44.0A  
 #6 FOR 45A-60A/2P BREAKER: 0.8 x 75A = 60.0A

CONDUIT SIZING: AT 40% FILL PER NEC CHAPTER 9, TABLE 4, ARTICLE 358.  
 0.5" CONDUIT - 0.122 SQ. IN AREA  
 0.75" CONDUIT - 0.213 SQ. IN AREA  
 2.0" CONDUIT - 1.316 SQ. IN AREA  
 3.0" CONDUIT - 2.907 SQ. IN AREA

CABINET CONVENIENCE OUTLET CONDUCTORS (1 CONDUIT): USING THWN-2, CU.  
 #10 - 0.0211 SQ. IN X 2 = 0.0422 SQ. IN  
 #10 - 0.0211 SQ. IN X 1 = 0.0211 SQ. IN <GROUND  
**TOTAL = 0.0633 SQ. IN**

0.5" EMT CONDUIT IS ADEQUATE TO HANDLE THE TOTAL OF (3) WIRES, INCLUDING GROUND WIRE, AS INDICATED ABOVE.

RECTIFIER CONDUCTORS (2 CONDUITS): USING UL1015, CU.  
 #10 - 0.0266 SQ. IN X 4 = 0.1064 SQ. IN  
 #10 - 0.0082 SQ. IN X 1 = 0.0082 SQ. IN <BARE GROUND  
**TOTAL = 0.1146 SQ. IN**

0.75" EMT CONDUIT IS ADEQUATE TO HANDLE THE TOTAL OF (5) WIRES, INCLUDING GROUND WIRE, AS INDICATED ABOVE.

PPC FEED CONDUCTORS (1 CONDUIT): USING THWN, CU.  
 3/0 - 0.2679 SQ. IN X 3 = 0.8037 SQ. IN  
 #6 - 0.0507 SQ. IN X 1 = 0.0507 SQ. IN <GROUND  
**TOTAL = 0.8544 SQ. IN**

3.0" SCH 40 PVC CONDUIT IS ADEQUATE TO HANDLE THE TOTAL OF (4) WIRES, INCLUDING GROUND WIRE, AS INDICATED ABOVE.

PPC ONE-LINE DIAGRAM

NO SCALE 1

PROPOSED CHARLES PANEL SCHEDULE										
LOAD SERVED	VOLT AMPS (WATTS)		TRIP	CKT #	PHASE	CKT #	TRIP	VOLT AMPS (WATTS)		LOAD SERVED
	L1	L2						L1	L2	
PPC GFCI OUTLET	180	180	15A	1	A	2	30A	2880	2880	ABB/GE INFINITY RECTIFIER 1
CHARLES GFCI OUTLET	180	180	15A	3	B	4	30A	2880	2880	ABB/GE INFINITY RECTIFIER 1
-SPACE-				5	A	6	30A	2880	2880	ABB/GE INFINITY RECTIFIER 2
-SPACE-				7	B	8	30A	2880	2880	ABB/GE INFINITY RECTIFIER 2
-SPACE-				9	A	10	30A	2880	2880	ABB/GE INFINITY RECTIFIER 3
-SPACE-				11	B	12	30A	2880	2880	ABB/GE INFINITY RECTIFIER 3
-SPACE-				13	A	14	30A	2880	2880	ABB/GE INFINITY RECTIFIER 4
-SPACE-				15	B	16	30A	2880	2880	ABB/GE INFINITY RECTIFIER 4
-SPACE-				17	A	18				-SPACE-
-SPACE-				19	B	20				-SPACE-
-SPACE-				21	A	22				-SPACE-
-SPACE-				23	B	24				-SPACE-
VOLTAGE AMPS		180	180					11520	11520	
200A MCB, 1ϕ, 24 SPACE, 120/240V				L1	L2					
MB RATING: 65,000 AIC				11700	11700					
				98	98					
				98						
				123						

PANEL SCHEDULE

NO SCALE 2

NOT USED

NO SCALE 3



5701 SOUTH SANTA FE DRIVE  
LITTLETON, CO 80120



B&T ENGINEERING, INC.  
PEC.0001564  
Expires 2/10/22

IT IS A VIOLATION OF LAW FOR ANY PERSON, UNLESS THEY ARE ACTING UNDER THE DIRECTION OF A LICENSED PROFESSIONAL ENGINEER, TO ALTER THIS DOCUMENT.

DRAWN BY:	CHECKED BY:	APPROVED BY:
CD	CD	RCM

RFDS REV #: 0

**CONSTRUCTION DOCUMENTS**

SUBMITTALS		
REV	DATE	DESCRIPTION
A	7/28/21	ISSUED FOR REVIEW
0	8/2/21	ISSUED FOR CONSTRUCTION

A&E PROJECT NUMBER  
153478.001.01

DISH Wireless L.L.C.  
PROJECT INFORMATION  
BOBDL00152B  
4 HOFFMANN ROAD  
CANTON, CT 06019

SHEET TITLE  
ELECTRICAL ONE-LINE, FAULT  
CALCS & PANEL SCHEDULE

SHEET NUMBER  
**E-3**

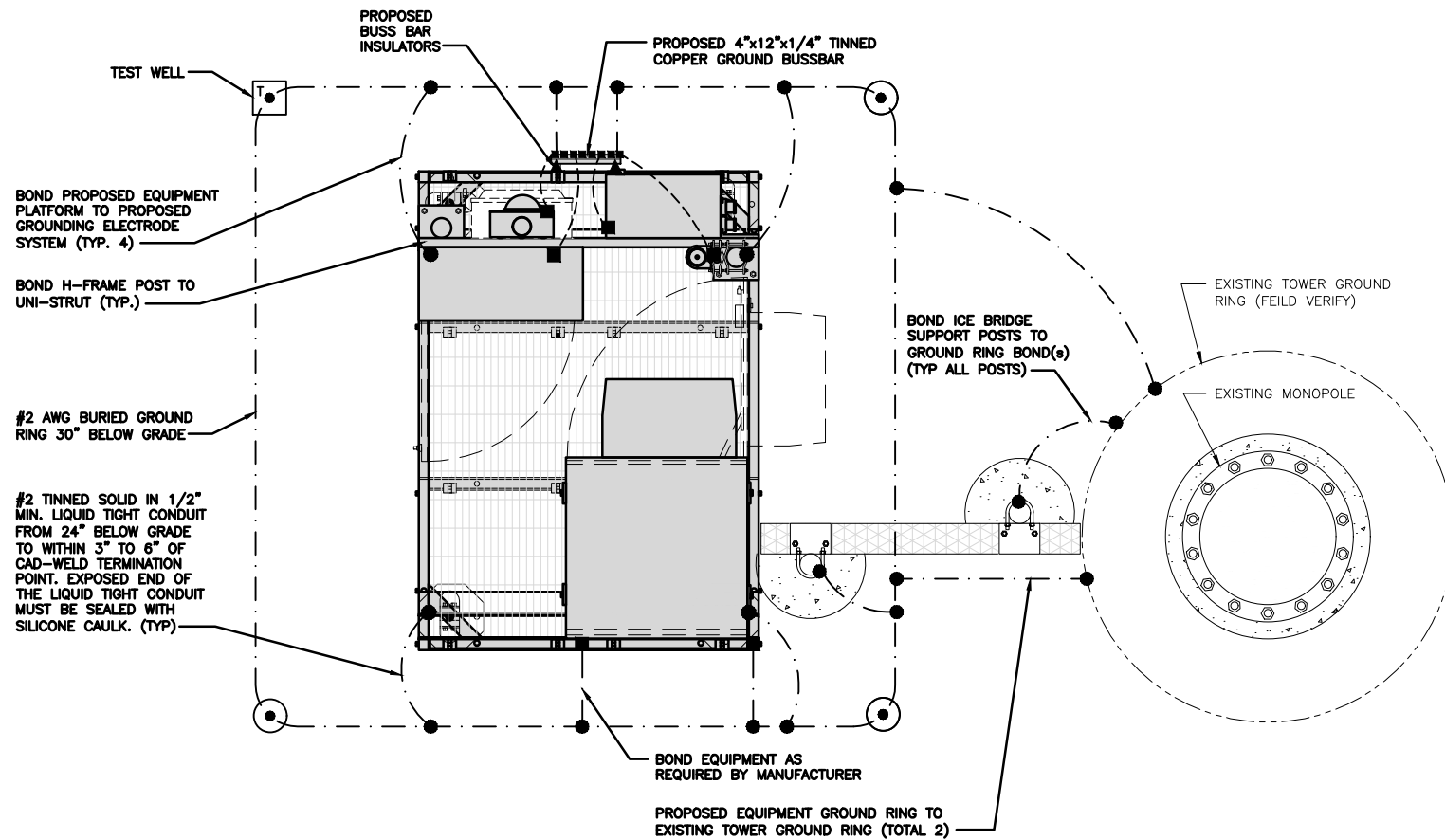

TYPICAL EQUIPMENT GROUNDING PLAN

NO SCALE 1

NOTES

1. ANTENNAS AND OVP SHOWN ARE GENERIC AND NOT REFERENCING TO A SPECIFIC MANUFACTURER. THIS LAYOUT IS FOR REFERENCE ONLY

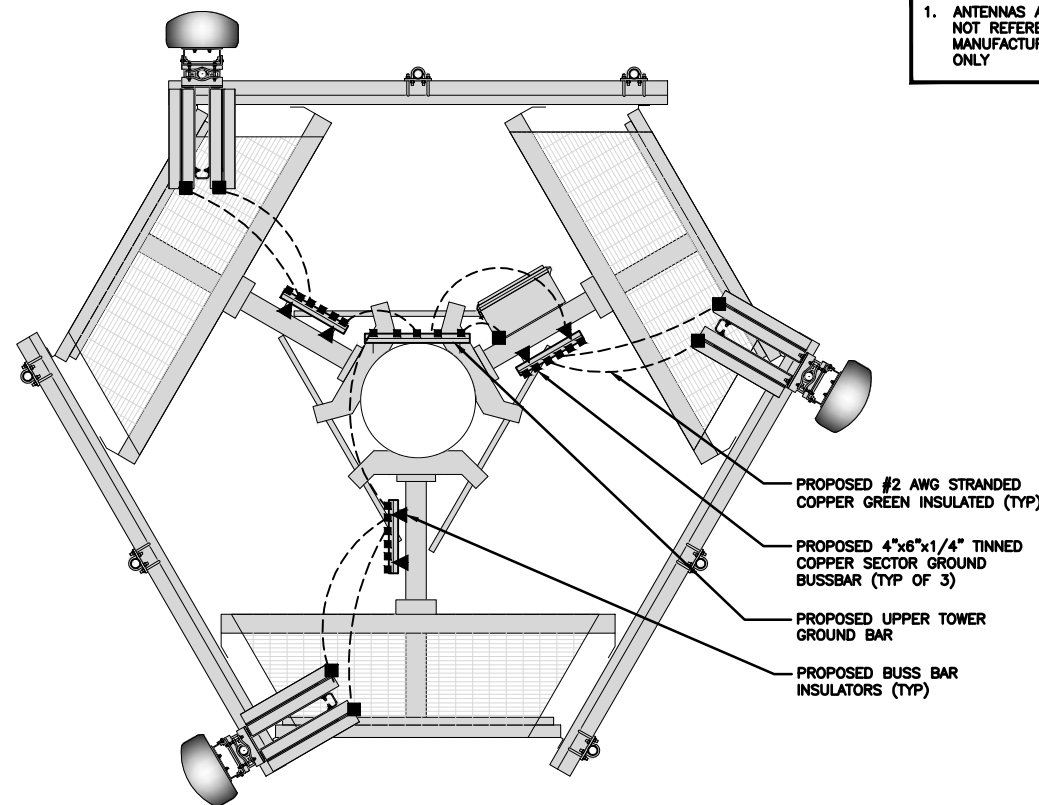

TYPICAL ANTENNA GROUNDING PLAN

NO SCALE 2

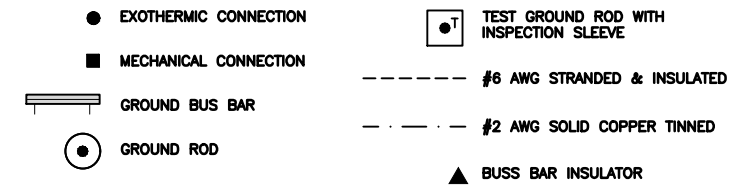

GROUNDING LEGEND

1. GROUNDING IS SHOWN DIAGRAMMATICALLY ONLY.
2. CONTRACTOR SHALL GROUND ALL EQUIPMENT AS A COMPLETE SYSTEM. GROUNDING SHALL BE IN COMPLIANCE WITH NEC SECTION 250 AND DISH Wireless L.L.C. GROUNDING AND BONDING REQUIREMENTS AND MANUFACTURER'S SPECIFICATIONS.
3. ALL GROUND CONDUCTORS SHALL BE COPPER; NO ALUMINUM CONDUCTORS SHALL BE USED.

GROUNDING KEY NOTES

- (A) **EXTERIOR GROUND RING:** #2 AWG SOLID COPPER, BURIED AT A DEPTH OF AT LEAST 30 INCHES BELOW GRADE, OR 6 INCHES BELOW THE FROST LINE AND APPROXIMATELY 24 INCHES FROM THE EXTERIOR WALL OR FOOTING.
- (B) **TOWER GROUND RING:** THE GROUND RING SYSTEM SHALL BE INSTALLED AROUND AN ANTENNA TOWER'S LEGS, AND/OR GUY ANCHORS. WHERE SEPARATE SYSTEMS HAVE BEEN PROVIDED FOR THE TOWER AND THE BUILDING, AT LEAST TWO BONDS SHALL BE MADE BETWEEN THE TOWER RING GROUND SYSTEM AND THE BUILDING RING GROUND SYSTEM USING MINIMUM #2 AWG SOLID COPPER CONDUCTORS.
- (C) **INTERIOR GROUND RING:** #2 AWG STRANDED GREEN INSULATED COPPER CONDUCTOR EXTENDED AROUND THE PERIMETER OF THE EQUIPMENT AREA. ALL NON-TELECOMMUNICATIONS RELATED METALLIC OBJECTS FOUND WITHIN A SITE SHALL BE GROUNDED TO THE INTERIOR GROUND RING WITH #6 AWG STRANDED GREEN INSULATED CONDUCTOR.
- (D) **BOND TO INTERIOR GROUND RING:** #2 AWG SOLID TINNED COPPER WIRE PRIMARY BONDS SHALL BE PROVIDED AT LEAST AT FOUR POINTS ON THE INTERIOR GROUND RING, LOCATED AT THE CORNERS OF THE BUILDING.
- (E) **GROUND ROD:** UL LISTED COPPER CLAD STEEL MINIMUM 1/2" DIAMETER BY EIGHT FEET LONG. GROUND RODS SHALL BE INSTALLED WITH INSPECTION SLEEVES. GROUND RODS SHALL BE DRIVEN TO THE DEPTH OF GROUND RING CONDUCTOR.
- (F) **CELL REFERENCE GROUND BAR:** POINT OF GROUND REFERENCE FOR ALL COMMUNICATIONS EQUIPMENT FRAMES. ALL BONDS ARE MADE WITH #2 AWG UNLESS NOTED OTHERWISE STRANDED GREEN INSULATED COPPER CONDUCTORS. BOND TO GROUND RING WITH (2) #2 SOLID TINNED COPPER CONDUCTORS.
- (G) **HATCH PLATE GROUND BAR:** BOND TO THE INTERIOR GROUND RING WITH TWO #2 AWG STRANDED GREEN INSULATED COPPER CONDUCTORS. WHEN A HATCH-PLATE AND A CELL REFERENCE GROUND BAR ARE BOTH PRESENT, THE CRGB MUST BE CONNECTED TO THE HATCH-PLATE AND TO THE INTERIOR GROUND RING USING (2) TWO #2 AWG STRANDED GREEN INSULATED COPPER CONDUCTORS EACH.
- (H) **EXTERIOR CABLE ENTRY PORT GROUND BARS:** LOCATED AT THE ENTRANCE TO THE CELL SITE BUILDING. BOND TO GROUND RING WITH A #2 AWG SOLID TINNED COPPER CONDUCTORS WITH AN EXOTHERMIC WELD AND INSPECTION SLEEVE.
- (I) **TELCO GROUND BAR:** BOND TO BOTH CELL REFERENCE GROUND BAR OR EXTERIOR GROUND RING.
- (J) **FRAME BONDING:** THE BONDING POINT FOR TELECOM EQUIPMENT FRAMES SHALL BE THE GROUND BUS THAT IS NOT ISOLATED FROM THE EQUIPMENTS METAL FRAMEWORK.
- (K) **INTERIOR UNIT BONDS:** METAL FRAMES, CABINETS AND INDIVIDUAL METALLIC UNITS LOCATED WITH THE AREA OF THE INTERIOR GROUND RING REQUIRE A #6 AWG STRANDED GREEN INSULATED COPPER BOND TO THE INTERIOR GROUND RING.
- (L) **FENCE AND GATE GROUNDING:** METAL FENCES WITHIN 7 FEET OF THE EXTERIOR GROUND RING OR OBJECTS BONDED TO THE EXTERIOR GROUND RING SHALL BE BONDED TO THE GROUND RING WITH A #2 AWG SOLID TINNED COPPER CONDUCTOR AT AN INTERVAL NOT EXCEEDING 25 FEET. BONDS SHALL BE MADE AT EACH GATE POST AND ACROSS GATE OPENINGS.
- (M) **EXTERIOR UNIT BONDS:** METALLIC OBJECTS, EXTERNAL TO OR MOUNTED TO THE BUILDING, SHALL BE BONDED TO THE EXTERIOR GROUND RING. USING #2 TINNED SOLID COPPER WIRE
- (N) **ICE BRIDGE SUPPORTS:** EACH ICE BRIDGE LEG SHALL BE BONDED TO THE GROUND RING WITH #2 AWG BARE TINNED COPPER CONDUCTOR. PROVIDE EXOTHERMIC WELDS AT BOTH THE ICE BRIDGE LEG AND BURIED GROUND RING.
- (O) **DURING ALL DC POWER SYSTEM CHANGES INCLUDING DC SYSTEM CHANGE OUTS, RECTIFIER REPLACEMENTS OR ADDITIONS, BREAKER DISTRIBUTION CHANGES, BATTERY ADDITIONS, BATTERY REPLACEMENTS AND INSTALLATIONS OR CHANGES TO DC CONVERTER SYSTEMS IT SHALL BE REQUIRED THAT SERVICE CONTRACTORS VERIFY ALL DC POWER SYSTEMS ARE EQUIPPED WITH A MASTER DC SYSTEM RETURN GROUND CONDUCTOR FROM THE DC POWER SYSTEM COMMON RETURN BUS DIRECTLY CONNECTED TO THE CELL SITE REFERENCE GROUND BAR**
- (P) **TOWER TOP COLLECTOR BUSS BAR IS TO BE MECHANICALLY BONDED TO PROPOSED ANTENNA MOUNT COLLAR. REFER TO DISH Wireless L.L.C. GROUNDING NOTES.**

GROUNDING KEY NOTES

NO SCALE 3



5701 SOUTH SANTA FE DRIVE  
LITTLETON, CO 80120



B&T ENGINEERING, INC.  
PEC.0001564  
Expires 2/10/22

IT IS A VIOLATION OF LAW FOR ANY PERSON, UNLESS THEY ARE ACTING UNDER THE DIRECTION OF A LICENSED PROFESSIONAL ENGINEER, TO ALTER THIS DOCUMENT.

DRAWN BY:	CHECKED BY:	APPROVED BY:
CD	CD	RCM

RFDS REV #: 0

CONSTRUCTION DOCUMENTS

SUBMITTALS		
REV	DATE	DESCRIPTION
A	7/26/21	ISSUED FOR REVIEW
D	8/2/21	ISSUED FOR CONSTRUCTION

A&E PROJECT NUMBER  
153478.001.01

DISH Wireless L.L.C.  
PROJECT INFORMATION

BOBDL00152B  
4 HOFFMANN ROAD  
CANTON, CT 06019

SHEET TITLE  
GROUNDING PLANS  
AND NOTES

SHEET NUMBER  
**G-1**

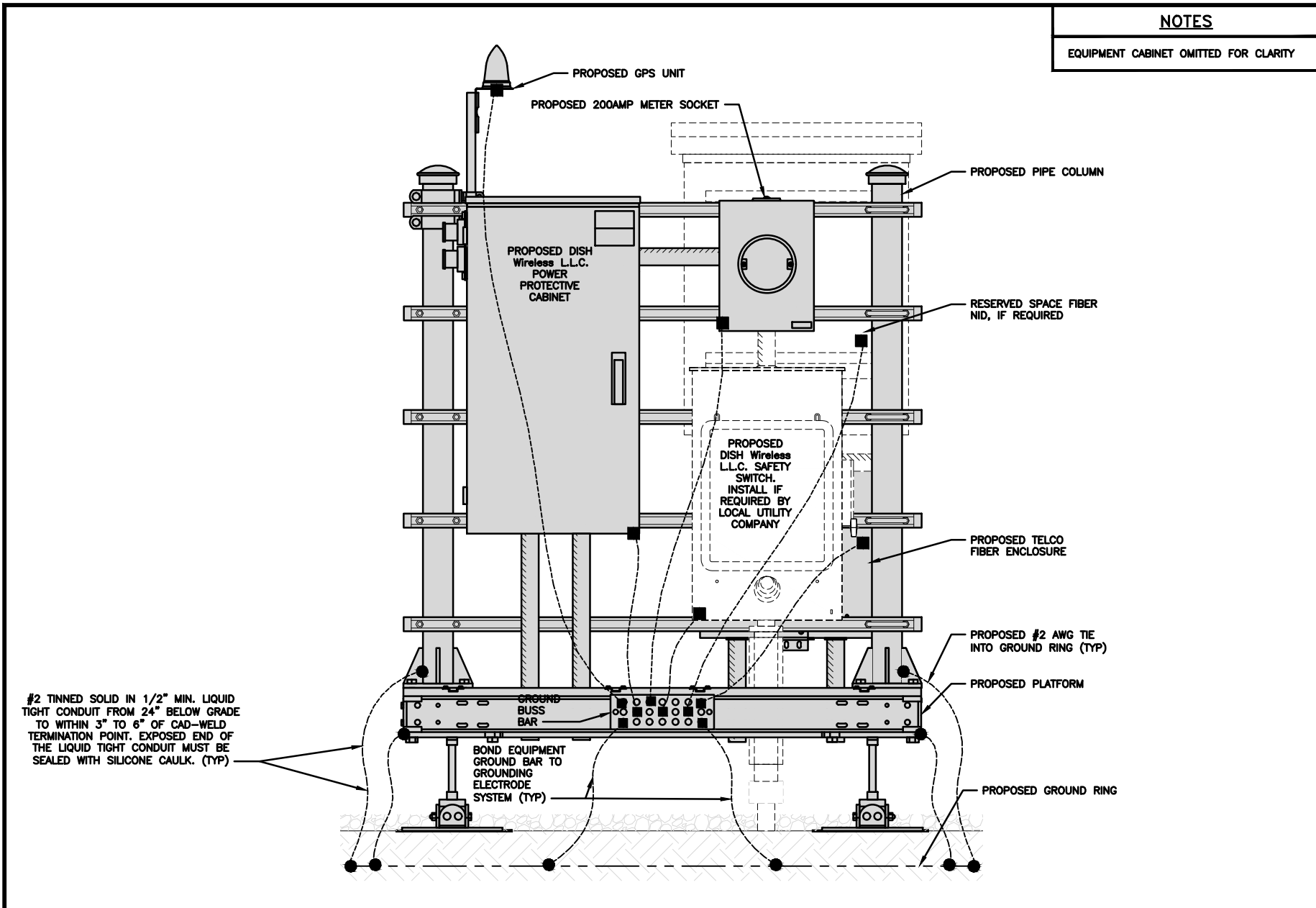

**NOTES**  
EQUIPMENT CABINET OMITTED FOR CLARITY

**H-FRAME GROUNDING DETAIL** NO SCALE 1

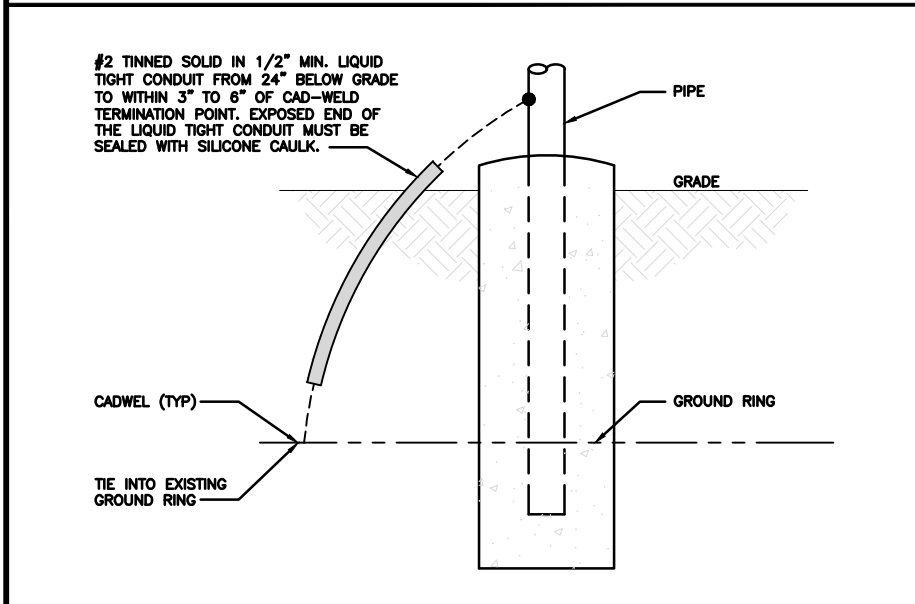

**TRANSITIONING GROUND DETAIL** NO SCALE 4

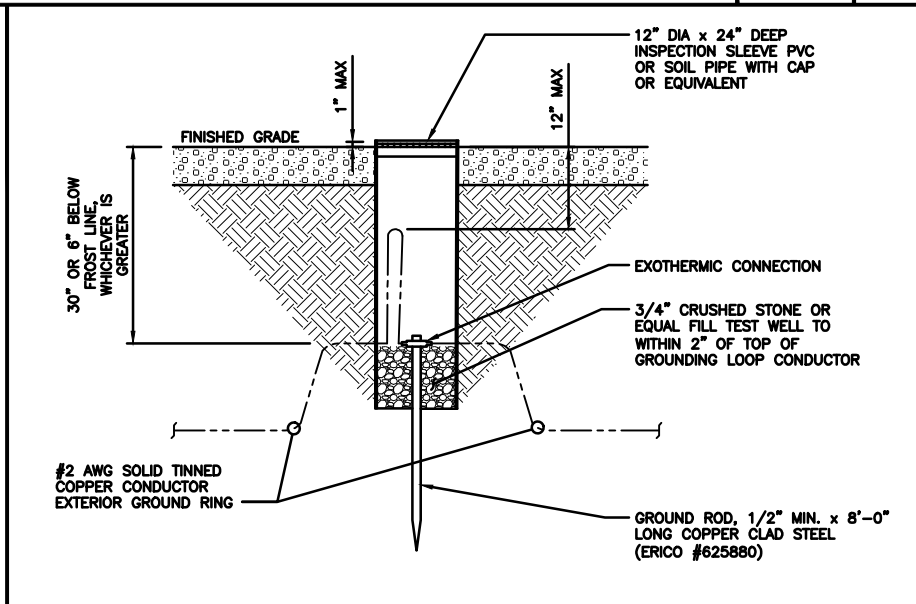

**TYPICAL TEST GROUND ROD WITH INSPECTION SLEEVE** NO SCALE 5

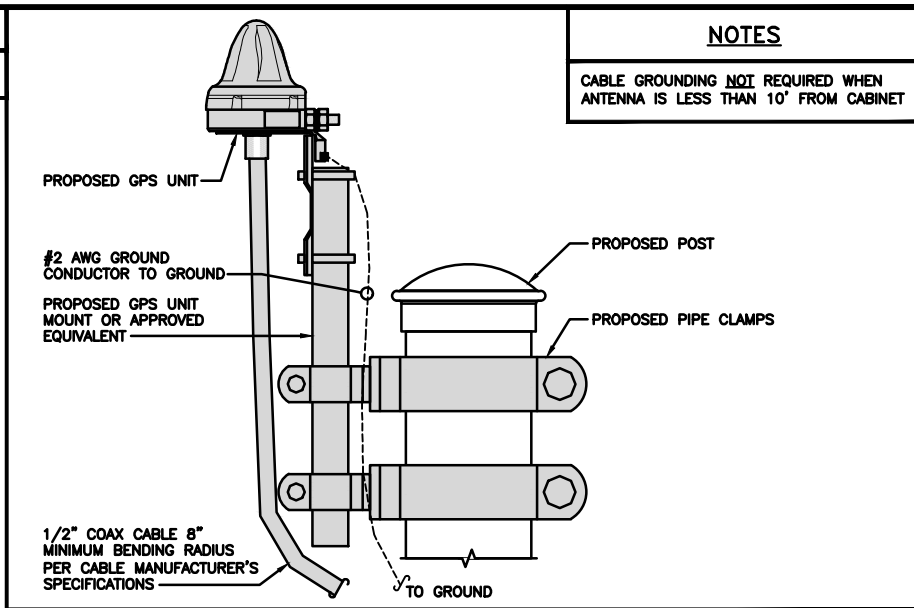

**NOTES**  
CABLE GROUNDING NOT REQUIRED WHEN ANTENNA IS LESS THAN 10' FROM CABINET

**TYPICAL GPS UNIT GROUNDING** NO SCALE 2

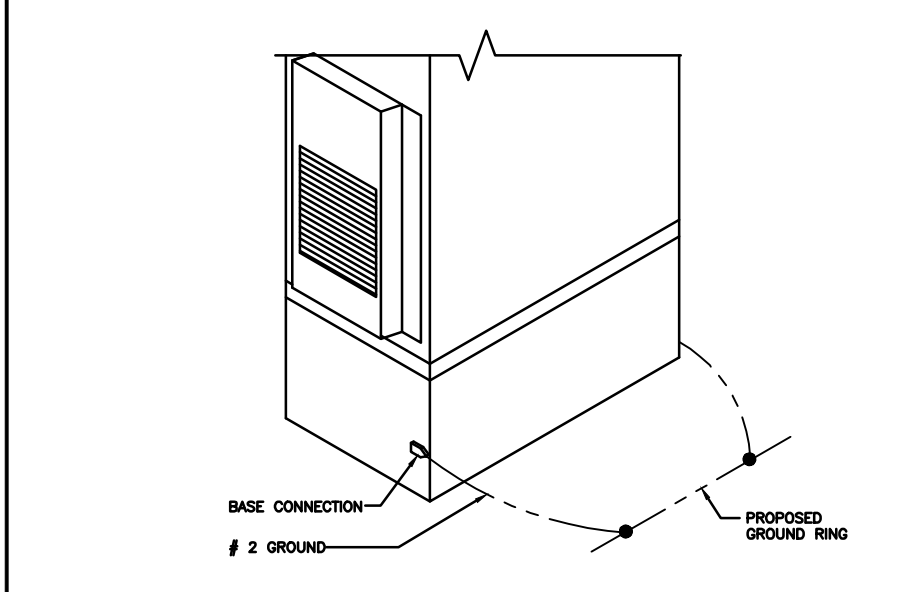

**OUTDOOR CABINET GROUNDING** NO SCALE 3

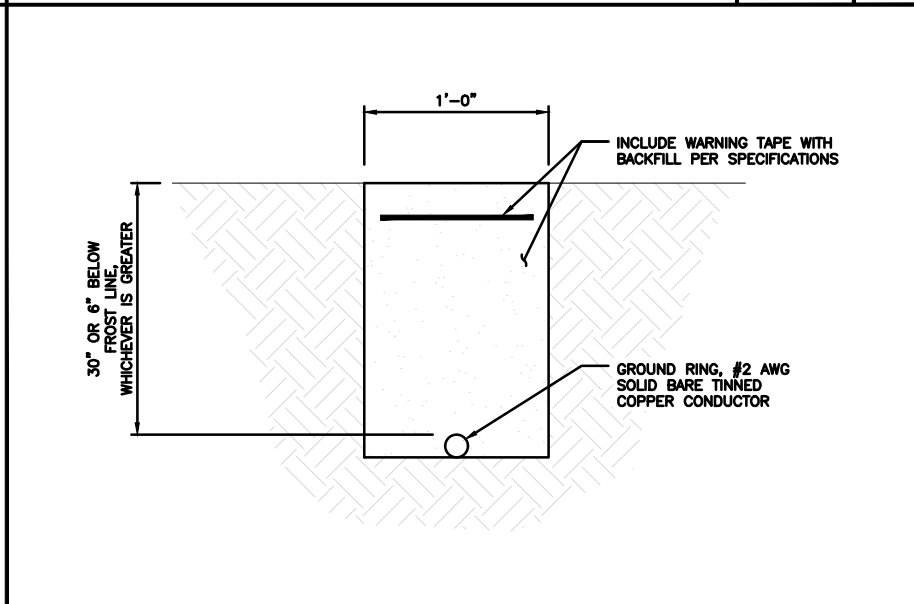

**TYPICAL GROUND RING TRENCH** NO SCALE 6

**dish wireless.**  
5701 SOUTH SANTA FE DRIVE  
LITTLETON, CO 80120

**AMERICAN TOWER**  
10 PRESIDENTIAL WAY  
WOBURN, MA 01801

**B+T GRP**  
1717 S. BOULDER  
SUITE 300  
TULSA, OK 74119  
PH: (918) 587-4630  
www.btgrp.com

*(Professional Engineer Seal)*  
No. 23824  
LICENSED PROFESSIONAL ENGINEER  
8/2/21

**B&T ENGINEERING, INC.**  
PEC.0001564  
Expires 2/10/22

IT IS A VIOLATION OF LAW FOR ANY PERSON, UNLESS THEY ARE ACTING UNDER THE DIRECTION OF A LICENSED PROFESSIONAL ENGINEER, TO ALTER THIS DOCUMENT.

DRAWN BY: CD    CHECKED BY: CD    APPROVED BY: RCM

RFDS REV #: 0

**CONSTRUCTION DOCUMENTS**

SUBMITTALS		
REV	DATE	DESCRIPTION
A	7/28/21	ISSUED FOR REVIEW
0	8/2/21	ISSUED FOR CONSTRUCTION

A&E PROJECT NUMBER  
153478.001.01

DISH Wireless L.L.C.  
PROJECT INFORMATION  
BOBDL00152B  
4 HOFFMANN ROAD  
CANTON, CT 06019

SHEET TITLE  
GROUNDING DETAILS

SHEET NUMBER  
**G-2**

1. EXOTHERMIC WELD (2) TWO, #2 AWG BARE TINNED SOLID COPPER CONDUCTORS TO GROUND BAR. ROUTE CONDUCTORS TO BURIED GROUND RING AND PROVIDE PARALLEL EXOTHERMIC WELD.
2. ALL EXTERIOR GROUNDING HARDWARE SHALL BE STAINLESS STEEL 3/8" DIAMETER OR LARGER. ALL HARDWARE 18-8 STAINLESS STEEL INCLUDING LOCK WASHERS, COAT ALL SURFACES WITH AN ANTI-OXIDANT COMPOUND BEFORE MATING.
3. FOR GROUND BOND TO STEEL ONLY: COAT ALL SURFACES WITH AN ANTI-OXIDANT COMPOUND BEFORE MATING.
4. DO NOT INSTALL CABLE GROUNDING KIT AT A BEND AND ALWAYS DIRECT GROUND CONDUCTOR DOWN TO GROUNDING BUS.
5. NUT & WASHER SHALL BE PLACED ON THE FRONT SIDE OF THE GROUND BAR AND BOLTED ON THE BACK SIDE.
6. ALL GROUNDING PARTS AND EQUIPMENT TO BE SUPPLIED AND INSTALLED BY CONTRACTOR.
7. THE CONTRACTOR SHALL BE RESPONSIBLE FOR INSTALLING ADDITIONAL GROUND BAR AS REQUIRED.
8. ENSURE THE WIRE INSULATION TERMINATION IS WITHIN 1/8" OF THE BARREL (NO SHINERS).

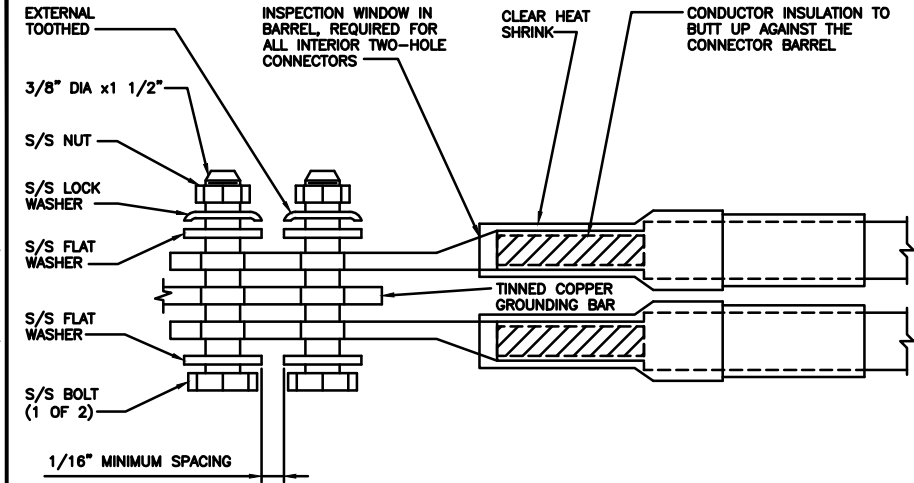
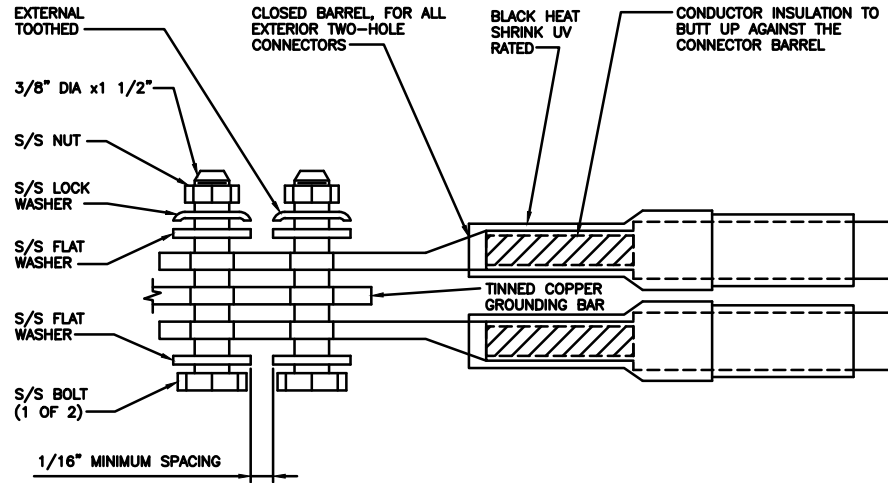

TYPICAL GROUNDING NOTES

NO SCALE 1

TYPICAL EXTERIOR TWO HOLE LUG

NO SCALE 2

TYPICAL INTERIOR TWO HOLE LUG

NO SCALE 3

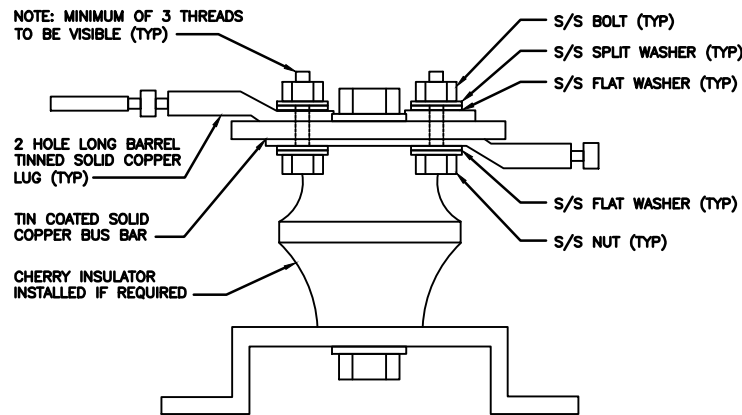

LUG DETAIL

NO SCALE 4

NOT USED

NO SCALE 5

NOT USED

NO SCALE 6

NOT USED

NO SCALE 7

NOT USED

NO SCALE 8

NOT USED

NO SCALE 9



5701 SOUTH SANTA FE DRIVE  
LITTLETON, CO 80120



B&T ENGINEERING, INC.  
PEC.0001564  
Expires 2/10/22

IT IS A VIOLATION OF LAW FOR ANY PERSON, UNLESS THEY ARE ACTING UNDER THE DIRECTION OF A LICENSED PROFESSIONAL ENGINEER, TO ALTER THIS DOCUMENT.

DRAWN BY:	CHECKED BY:	APPROVED BY:
CD	CD	RCM

RFDS REV #: 0

CONSTRUCTION DOCUMENTS

SUBMITTALS		
REV	DATE	DESCRIPTION
A	7/28/21	ISSUED FOR REVIEW
D	8/2/21	ISSUED FOR CONSTRUCTION

A&E PROJECT NUMBER  
153478.001.01

DISH Wireless L.L.C.  
PROJECT INFORMATION

BOBDL00152B  
4 HOFFMANN ROAD  
CANTON, CT 06019

SHEET TITLE  
GROUNDING DETAILS

SHEET NUMBER  
**G-3**

**RF JUMPER COLOR CODING**

3/4" TAPE WIDTHS WITH 3/4" SPACING

LOW-BAND RRH -  
(600MHz N71 BASEBAND) +  
(850MHz N26 BAND) +  
(700MHz N29 BAND) - OPTIONAL PER MARKET

ADD FREQUENCY COLOR TO SECTOR BAND  
(CBRS WILL USE YELLOW BANDS)

ALPHA RRH				BETA RRH				GAMMA RRH			
PORT 1 + SLANT	PORT 2 - SLANT	PORT 3 + SLANT	PORT 4 - SLANT	PORT 1 + SLANT	PORT 2 - SLANT	PORT 3 + SLANT	PORT 4 - SLANT	PORT 1 + SLANT	PORT 2 - SLANT	PORT 3 + SLANT	PORT 4 - SLANT
RED	RED	RED	RED	BLUE	BLUE	BLUE	BLUE	GREEN	GREEN	GREEN	GREEN
ORANGE	ORANGE	RED	RED	ORANGE	ORANGE	BLUE	BLUE	ORANGE	ORANGE	GREEN	GREEN
	WHITE (-) PORT	ORANGE	ORANGE		WHITE (-) PORT	ORANGE	ORANGE		WHITE (-) PORT	ORANGE	ORANGE
			WHITE (-) PORT				WHITE (-) PORT				WHITE (-) PORT

MID-BAND RRH -  
(AWS BANDS N66+N70)

ADD FREQUENCY COLOR TO SECTOR BAND  
(CBRS WILL USE YELLOW BANDS)

RED	RED	RED	RED	BLUE	BLUE	BLUE	BLUE	GREEN	GREEN	GREEN	GREEN
PURPLE	PURPLE	RED	RED	PURPLE	PURPLE	BLUE	BLUE	PURPLE	PURPLE	GREEN	GREEN
	WHITE (-) PORT	PURPLE	PURPLE		WHITE (-) PORT	PURPLE	PURPLE		WHITE (-) PORT	PURPLE	PURPLE
			WHITE (-) PORT				WHITE (-) PORT				WHITE (-) PORT

**HYBRID/DISCREET CABLES**

INCLUDE SECTOR BANDS BEING SUPPORTED  
ALONG WITH FREQUENCY BANDS

EXAMPLE 1 - HYBRID, OR DISCREET, SUPPORTS  
ALL SECTORS, BOTH LOW-BANDS AND MID-BANDS

EXAMPLE 2 - HYBRID, OR DISCREET, SUPPORTS  
CBRS ONLY, ALL SECTORS

EXAMPLE 1	EXAMPLE 2	EXAMPLE 3
RED	RED	RED
BLUE	BLUE	
GREEN	GREEN	ORANGE
ORANGE	YELLOW	PURPLE
PURPLE		

**FIBER JUMPERS TO RRHs**

LOW-BAND RRH FIBER CABLES HAVE SECTOR  
STRIPE ONLY

LOW BAND RRH	HIGH BAND RRH	LOW BAND RRH	HIGH BAND RRH	LOW BAND RRH	HIGH BAND RRH
RED	RED	BLUE	BLUE	GREEN	GREEN
	PURPLE		PURPLE		PURPLE

**POWER CABLES TO RRHs**

LOW-BAND RRH POWER CABLES HAVE SECTOR  
STRIPE ONLY

LOW BAND RRH	HIGH BAND RRH	LOW BAND RRH	HIGH BAND RRH	LOW BAND RRH	HIGH BAND RRH
RED	RED	BLUE	BLUE	GREEN	GREEN
	PURPLE		PURPLE		PURPLE

**RET MOTORS AT ANTENNAS**

ANTENNA 1 LOW BAND/ "IN"	ANTENNA 1 HIGH BAND/ "IN"	ANTENNA 1 LOW BAND/ "IN"	ANTENNA 1 HIGH BAND/ "IN"	ANTENNA 1 LOW BAND/ "IN"	ANTENNA 1 HIGH BAND/ "IN"
RED	RED	BLUE	BLUE	GREEN	GREEN
	PURPLE		PURPLE		PURPLE

**MICROWAVE RADIO LINKS**

LINKS WILL HAVE A 1.5-2 INCH WHITE WRAP WITH  
THE AZIMUTH COLOR OVERLAPPING IN THE MIDDLE.  
ADD ADDITIONAL SECTOR COLOR BANDS FOR EACH  
ADDITIONAL MW RADIO.

MICROWAVE CABLES WILL REQUIRE P-TOUCH  
LABELS INSIDE THE CABINET TO IDENTIFY THE  
LOCAL AND REMOTE SITE ID'S

FORWARD AZIMUTH OF 0-120 DEGREES		FORWARD AZIMUTH OF 120-240 DEGREES		FORWARD AZIMUTH OF 240-360 DEGREES	
PRIMARY	SECONDARY	PRIMARY	SECONDARY	PRIMARY	SECONDARY
WHITE	WHITE	WHITE	WHITE	WHITE	WHITE
RED	RED	BLUE	BLUE	GREEN	GREEN
WHITE	WHITE	WHITE	WHITE	WHITE	WHITE
	RED		BLUE		GREEN
	WHITE		WHITE		WHITE
	WHITE		WHITE		WHITE

**RF CABLE COLOR CODES**

NO SCALE

1

LOW BANDS (N71+N26)  
OPTIONAL - (N29)



AWS  
(N66+N70+H-BLOCK)



CBRS TECH  
(3 GHz)



NEGATIVE SLANT PORT  
ON ANT/RRH



ALPHA SECTOR



BETA SECTOR

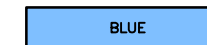

GAMMA SECTOR



COLOR IDENTIFIER

NO SCALE

2

NOT USED

NO SCALE

3

NOT USED

NO SCALE

4



5701 SOUTH SANTA FE DRIVE  
LITTLETON, CO 80120



B&T ENGINEERING, INC.  
PEC.0001564  
Expires 2/10/22

IT IS A VIOLATION OF LAW FOR ANY PERSON,  
UNLESS THEY ARE ACTING UNDER THE DIRECTION  
OF A LICENSED PROFESSIONAL ENGINEER,  
TO ALTER THIS DOCUMENT.

DRAWN BY:	CHECKED BY:	APPROVED BY:
CD	CD	RCM

RFDS REV #: 0

**CONSTRUCTION DOCUMENTS**

SUBMITTALS		
REV	DATE	DESCRIPTION
A	7/26/21	ISSUED FOR REVIEW
D	8/2/21	ISSUED FOR CONSTRUCTION

A&E PROJECT NUMBER  
153478.001.01

DISH Wireless L.L.C.  
PROJECT INFORMATION

BOBDL00152B  
4 HOFFMANN ROAD  
CANTON, CT 06019

SHEET TITLE  
RF  
CABLE COLOR CODES

SHEET NUMBER

RF-1

EXOTHERMIC CONNECTION  
 MECHANICAL CONNECTION  
 BUSS BAR INSULATOR  
 CHEMICAL ELECTROLYTIC GROUNDING SYSTEM  
 TEST CHEMICAL ELECTROLYTIC GROUNDING SYSTEM  
 EXOTHERMIC WITH INSPECTION SLEEVE  
 GROUNDING BAR  
 GROUND ROD  
 TEST GROUND ROD WITH INSPECTION SLEEVE

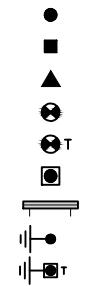

SINGLE POLE SWITCH  
 DUPLEX RECEPTACLE  
 DUPLEX GFCI RECEPTACLE  
 FLUORESCENT LIGHTING FIXTURE (2) TWO LAMPS 48-T8

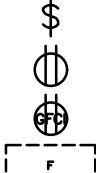

SMOKE DETECTION (DC)  
 EMERGENCY LIGHTING (DC)  
 SECURITY LIGHT W/PHOTOCELL LITHONIA ALXW LED-1-25A400/51K-SR4-120-PE-DBBTD

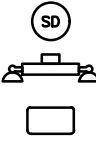

CHAIN LINK FENCE  
 WOOD/WROUGHT IRON FENCE  
 WALL STRUCTURE  
 LEASE AREA  
 PROPERTY LINE (PL)

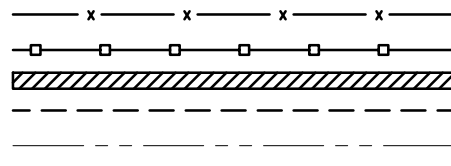

SETBACKS  
 ICE BRIDGE  
 CABLE TRAY  
 WATER LINE  
 UNDERGROUND POWER  
 UNDERGROUND TELCO

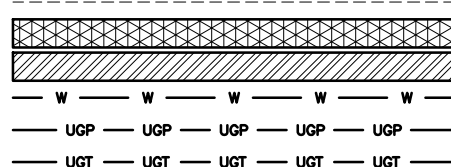

OVERHEAD POWER  
 OVERHEAD TELCO  
 UNDERGROUND TELCO/POWER  
 ABOVE GROUND POWER  
 ABOVE GROUND TELCO

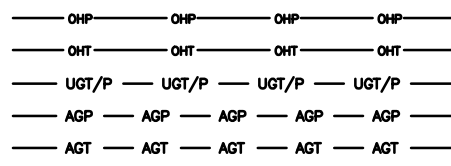

ABOVE GROUND TELCO/POWER  
 WORKPOINT

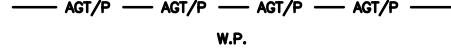

SECTION REFERENCE

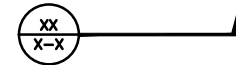

DETAIL REFERENCE



AB	ANCHOR BOLT	IN	INCH
ABV	ABOVE	INT	INTERIOR
AC	ALTERNATING CURRENT	LB(S)	POUND(S)
ADDL	ADDITIONAL	LF	LINEAR FEET
AFF	ABOVE FINISHED FLOOR	LTE	LONG TERM EVOLUTION
AFG	ABOVE FINISHED GRADE	MAS	MASONRY
AGL	ABOVE GROUND LEVEL	MAX	MAXIMUM
AIC	AMPERAGE INTERRUPTION CAPACITY	MB	MACHINE BOLT
ALUM	ALUMINUM	MECH	MECHANICAL
ALT	ALTERNATE	MFR	MANUFACTURER
ANT	ANTENNA	MGB	MASTER GROUND BAR
APPROX	APPROXIMATE	MIN	MINIMUM
ARCH	ARCHITECTURAL	MISC	MISCELLANEOUS
ATS	AUTOMATIC TRANSFER SWITCH	MTL	METAL
AWG	AMERICAN WIRE GAUGE	MTS	MANUAL TRANSFER SWITCH
BATT	BATTERY	MW	MICROWAVE
BLDG	BUILDING	NEC	NATIONAL ELECTRIC CODE
BLK	BLOCK	NM	NEWTON METERS
BLKG	BLOCKING	NO.	NUMBER
BM	BEAM	#	NUMBER
BTC	BARE TINNED COPPER CONDUCTOR	NTS	NOT TO SCALE
BOF	BOTTOM OF FOOTING	OC	ON-CENTER
CAB	CABINET	OSHA	OCCUPATIONAL SAFETY AND HEALTH ADMINISTRATION
CANT	CANTILEVERED	OPNG	OPENING
CHG	CHARGING	P/C	PRECAST CONCRETE
CLG	CEILING	PCS	PERSONAL COMMUNICATION SERVICES
CLR	CLEAR	PCU	PRIMARY CONTROL UNIT
COL	COLUMN	PRC	PRIMARY RADIO CABINET
COMM	COMMON	PP	POLARIZING PRESERVING
CONC	CONCRETE	PSF	POUNDS PER SQUARE FOOT
CONSTR	CONSTRUCTION	PSI	POUNDS PER SQUARE INCH
DBL	DOUBLE	PT	PRESSURE TREATED
DC	DIRECT CURRENT	PWR	POWER CABINET
DEPT	DEPARTMENT	QTY	QUANTITY
DF	DOUGLAS FIR	RAD	RADIUS
DIA	DIAMETER	RECT	RECTIFIER
DIAG	DIAGONAL	REF	REFERENCE
DIM	DIMENSION	REINF	REINFORCEMENT
DWG	DRAWING	REQ'D	REQUIRED
DWL	DOWEL	RET	REMOTE ELECTRIC TILT
EA	EACH	RF	RADIO FREQUENCY
EC	ELECTRICAL CONDUCTOR	RMC	RIGID METALLIC CONDUIT
EL	ELEVATION	RRH	REMOTE RADIO HEAD
ELEC	ELECTRICAL	RRU	REMOTE RADIO UNIT
EMT	ELECTRICAL METALLIC TUBING	RWY	RACEWAY
ENG	ENGINEER	SCH	SCHEDULE
EQ	EQUAL	SHT	SHEET
EXP	EXPANSION	SIAD	SMART INTEGRATED ACCESS DEVICE
EXT	EXTERIOR	SIM	SIMILAR
EW	EACH WAY	SPEC	SPECIFICATION
FAB	FABRICATION	SQ	SQUARE
FF	FINISH FLOOR	SS	STAINLESS STEEL
FG	FINISH GRADE	STD	STANDARD
FIF	FACILITY INTERFACE FRAME	STL	STEEL
FIN	FINISH(ED)	TEMP	TEMPORARY
FLR	FLOOR	THK	THICKNESS
FDN	FOUNDATION	TMA	TOWER MOUNTED AMPLIFIER
FOC	FACE OF CONCRETE	TN	TOE NAIL
FOM	FACE OF MASONRY	TOA	TOP OF ANTENNA
FOS	FACE OF STUD	TOC	TOP OF CURB
FOW	FACE OF WALL	TOF	TOP OF FOUNDATION
FS	FINISH SURFACE	TOP	TOP OF PLATE (PARAPET)
FT	FOOT	TOS	TOP OF STEEL
FTG	FOOTING	TOW	TOP OF WALL
GA	GAUGE	TVSS	TRANSIENT VOLTAGE SURGE SUPPRESSION
GEN	GENERATOR	TYP	TYPICAL
GFCI	GROUND FAULT CIRCUIT INTERRUPTER	UG	UNDERGROUND
GLB	GLUE LAMINATED BEAM	UL	UNDERWRITERS LABORATORY
GLV	GALVANIZED	UNO	UNLESS NOTED OTHERWISE
GPS	GLOBAL POSITIONING SYSTEM	UMTS	UNIVERSAL MOBILE TELECOMMUNICATIONS SYSTEM
GND	GROUND	UPS	UNINTERRUPTIBLE POWER SYSTEM (DC POWER PLANT)
GSM	GLOBAL SYSTEM FOR MOBILE	VIF	VERIFIED IN FIELD
HDG	HOT DIPPED GALVANIZED	W	WIDE
HDR	HEADER	W/	WITH
HGR	HANGER	WD	WOOD
HVAC	HEAT/VENTILATION/AIR CONDITIONING	WP	WEATHERPROOF
HT	HEIGHT	WT	WEIGHT
IGR	INTERIOR GROUND RING		

**LEGEND**

**ABBREVIATIONS**



5701 SOUTH SANTA FE DRIVE  
 LITTLETON, CO 80120



**B&T ENGINEERING, INC.**  
 PEC.0001564  
 Expires 2/10/22

IT IS A VIOLATION OF LAW FOR ANY PERSON, UNLESS THEY ARE ACTING UNDER THE DIRECTION OF A LICENSED PROFESSIONAL ENGINEER, TO ALTER THIS DOCUMENT.

DRAWN BY:	CHECKED BY:	APPROVED BY:
CD	CD	RCM

RFDS REV #: 0

**CONSTRUCTION DOCUMENTS**

SUBMITTALS		
REV	DATE	DESCRIPTION
A	7/26/21	ISSUED FOR REVIEW
0	8/2/21	ISSUED FOR CONSTRUCTION

A&E PROJECT NUMBER  
 153478.001.01

DISH Wireless L.L.C.  
 PROJECT INFORMATION  
 BOBDL00152B  
 4 HOFFMANN ROAD  
 CANTON, CT 06019

SHEET TITLE  
 LEGEND AND ABBREVIATIONS

SHEET NUMBER  
**GN-1**



**SITE ACTIVITY REQUIREMENTS:**

1. NOTICE TO PROCEED – NO WORK SHALL COMMENCE PRIOR TO CONTRACTOR RECEIVING A WRITTEN NOTICE TO PROCEED (NTP) AND THE ISSUANCE OF A PURCHASE ORDER. PRIOR TO ACCESSING/ENTERING THE SITE YOU MUST CONTACT THE DISH Wireless L.L.C. AND TOWER OWNER NOC & THE DISH Wireless L.L.C. AND TOWER OWNER CONSTRUCTION MANAGER.
2. "LOOK UP" – DISH Wireless L.L.C. AND TOWER OWNER SAFETY CLIMB REQUIREMENT:  
THE INTEGRITY OF THE SAFETY CLIMB AND ALL COMPONENTS OF THE CLIMBING FACILITY SHALL BE CONSIDERED DURING ALL STAGES OF DESIGN, INSTALLATION, AND INSPECTION. TOWER MODIFICATION, MOUNT REINFORCEMENTS, AND/OR EQUIPMENT INSTALLATIONS SHALL NOT COMPROMISE THE INTEGRITY OR FUNCTIONAL USE OF THE SAFETY CLIMB OR ANY COMPONENTS OF THE CLIMBING FACILITY ON THE STRUCTURE. THIS SHALL INCLUDE, BUT NOT BE LIMITED TO: PINCHING OF THE WIRE ROPE, BENDING OF THE WIRE ROPE FROM ITS SUPPORTS, DIRECT CONTACT OR CLOSE PROXIMITY TO THE WIRE ROPE WHICH MAY CAUSE FRICTIONAL WEAR, IMPACT TO THE ANCHORAGE POINTS IN ANY WAY, OR TO IMPEDE/BLOCK ITS INTENDED USE. ANY COMPROMISED SAFETY CLIMB, INCLUDING EXISTING CONDITIONS MUST BE TAGGED OUT AND REPORTED TO YOUR DISH Wireless L.L.C. AND DISH Wireless L.L.C. AND TOWER OWNER POC OR CALL THE NOC TO GENERATE A SAFETY CLIMB MAINTENANCE AND CONTRACTOR NOTICE TICKET.
3. PRIOR TO THE START OF CONSTRUCTION, ALL REQUIRED JURISDICTIONAL PERMITS SHALL BE OBTAINED. THIS INCLUDES, BUT IS NOT LIMITED TO, BUILDING, ELECTRICAL, MECHANICAL, FIRE, FLOOD ZONE, ENVIRONMENTAL, AND ZONING. AFTER ONSITE ACTIVITIES AND CONSTRUCTION ARE COMPLETED, ALL REQUIRED PERMITS SHALL BE SATISFIED AND CLOSED OUT ACCORDING TO LOCAL JURISDICTIONAL REQUIREMENTS.
4. ALL CONSTRUCTION MEANS AND METHODS; INCLUDING BUT NOT LIMITED TO, ERECTION PLANS, RIGGING PLANS, CLIMBING PLANS, AND RESCUE PLANS SHALL BE THE RESPONSIBILITY OF THE GENERAL CONTRACTOR RESPONSIBLE FOR THE EXECUTION OF THE WORK CONTAINED HEREIN, AND SHALL MEET ANSI/ASSE A10.48 (LATEST EDITION); FEDERAL, STATE, AND LOCAL REGULATIONS; AND ANY APPLICABLE INDUSTRY CONSENSUS STANDARDS RELATED TO THE CONSTRUCTION ACTIVITIES BEING PERFORMED. ALL RIGGING PLANS SHALL ADHERE TO ANSI/ASSE A10.48 (LATEST EDITION) AND DISH Wireless L.L.C. AND TOWER OWNER STANDARDS, INCLUDING THE REQUIRED INVOLVEMENT OF A QUALIFIED ENGINEER FOR CLASS IV CONSTRUCTION, TO CERTIFY THE SUPPORTING STRUCTURE(S) IN ACCORDANCE WITH ANSI/TIA-322 (LATEST EDITION).
5. ALL SITE WORK TO COMPLY WITH DISH Wireless L.L.C. AND TOWER OWNER INSTALLATION STANDARDS FOR CONSTRUCTION ACTIVITIES ON DISH Wireless L.L.C. AND TOWER OWNER TOWER SITE AND LATEST VERSION OF ANSI/TIA-1019-A-2012 "STANDARD FOR INSTALLATION, ALTERATION, AND MAINTENANCE OF ANTENNA SUPPORTING STRUCTURES AND ANTENNAS."
6. IF THE SPECIFIED EQUIPMENT CAN NOT BE INSTALLED AS SHOWN ON THESE DRAWINGS, THE CONTRACTOR SHALL PROPOSE AN ALTERNATIVE INSTALLATION FOR APPROVAL BY DISH Wireless L.L.C. AND TOWER OWNER PRIOR TO PROCEEDING WITH ANY SUCH CHANGE OF INSTALLATION.
7. ALL MATERIALS FURNISHED AND INSTALLED SHALL BE IN STRICT ACCORDANCE WITH ALL APPLICABLE CODES, REGULATIONS AND ORDINANCES. CONTRACTOR SHALL ISSUE ALL APPROPRIATE NOTICES AND COMPLY WITH ALL LAWS, ORDINANCES, RULES, REGULATIONS AND LAWFUL ORDERS OF ANY PUBLIC AUTHORITY REGARDING THE PERFORMANCE OF THE WORK. ALL WORK CARRIED OUT SHALL COMPLY WITH ALL APPLICABLE MUNICIPAL AND UTILITY COMPANY SPECIFICATIONS AND LOCAL JURISDICTIONAL CODES, ORDINANCES AND APPLICABLE REGULATIONS.
8. THE CONTRACTOR SHALL INSTALL ALL EQUIPMENT AND MATERIALS IN ACCORDANCE WITH MANUFACTURER'S RECOMMENDATIONS UNLESS SPECIFICALLY STATED OTHERWISE.
9. THE CONTRACTOR SHALL CONTACT UTILITY LOCATING SERVICES INCLUDING PRIVATE LOCATES SERVICES PRIOR TO THE START OF CONSTRUCTION.
10. ALL EXISTING ACTIVE SEWER, WATER, GAS, ELECTRIC AND OTHER UTILITIES WHERE ENCOUNTERED IN THE WORK, SHALL BE PROTECTED AT ALL TIMES AND WHERE REQUIRED FOR THE PROPER EXECUTION OF THE WORK, SHALL BE RELOCATED AS DIRECTED BY CONTRACTOR. EXTREME CAUTION SHOULD BE USED BY THE CONTRACTOR WHEN EXCAVATING OR DRILLING PIERS AROUND OR NEAR UTILITIES. CONTRACTOR SHALL PROVIDE SAFETY TRAINING FOR THE WORKING CREW. THIS WILL INCLUDE BUT NOT BE LIMITED TO A) FALL PROTECTION B) CONFINED SPACE C) ELECTRICAL SAFETY D) TRENCHING AND EXCAVATION E) CONSTRUCTION SAFETY PROCEDURES.
11. ALL SITE WORK SHALL BE AS INDICATED ON THE STAMPED CONSTRUCTION DRAWINGS AND DISH PROJECT SPECIFICATIONS, LATEST APPROVED REVISION.
12. CONTRACTOR SHALL KEEP THE SITE FREE FROM ACCUMULATING WASTE MATERIAL, DEBRIS, AND TRASH AT THE COMPLETION OF THE WORK. IF NECESSARY, RUBBISH, STUMPS, DEBRIS, STICKS, STONES AND OTHER REFUSE SHALL BE REMOVED FROM THE SITE AND DISPOSED OF LEGALLY.
13. ALL EXISTING INACTIVE SEWER, WATER, GAS, ELECTRIC AND OTHER UTILITIES, WHICH INTERFERE WITH THE EXECUTION OF THE WORK, SHALL BE REMOVED AND/OR CAPPED, PLUGGED OR OTHERWISE DISCONTINUED AT POINTS WHICH WILL NOT INTERFERE WITH THE EXECUTION OF THE WORK, SUBJECT TO THE APPROVAL OF DISH Wireless L.L.C. AND TOWER OWNER, AND/OR LOCAL UTILITIES.
14. THE CONTRACTOR SHALL PROVIDE SITE SIGNAGE IN ACCORDANCE WITH THE TECHNICAL SPECIFICATION FOR SITE SIGNAGE REQUIRED BY LOCAL JURISDICTION AND SIGNAGE REQUIRED ON INDIVIDUAL PIECES OF EQUIPMENT, ROOMS, AND SHELTERS.
15. THE SITE SHALL BE GRADED TO CAUSE SURFACE WATER TO FLOW AWAY FROM THE CARRIER'S EQUIPMENT AND TOWER AREAS.
16. THE SUB GRADE SHALL BE COMPACTED AND BROUGHT TO A SMOOTH UNIFORM GRADE PRIOR TO FINISHED SURFACE APPLICATION.
17. THE AREAS OF THE OWNERS PROPERTY DISTURBED BY THE WORK AND NOT COVERED BY THE TOWER, EQUIPMENT OR DRIVEWAY, SHALL BE GRADED TO A UNIFORM SLOPE, AND STABILIZED TO PREVENT EROSION AS SPECIFIED ON THE CONSTRUCTION DRAWINGS AND/OR PROJECT SPECIFICATIONS.
18. CONTRACTOR SHALL MINIMIZE DISTURBANCE TO EXISTING SITE DURING CONSTRUCTION. EROSION CONTROL MEASURES, IF REQUIRED DURING CONSTRUCTION, SHALL BE IN CONFORMANCE WITH THE LOCAL GUIDELINES FOR EROSION AND SEDIMENT CONTROL.
19. THE CONTRACTOR SHALL PROTECT EXISTING IMPROVEMENTS, PAVEMENTS, CURBS, LANDSCAPING AND STRUCTURES. ANY DAMAGED PART SHALL BE REPAIRED AT CONTRACTOR'S EXPENSE TO THE SATISFACTION OF OWNER.
20. CONTRACTOR SHALL LEGALLY AND PROPERLY DISPOSE OF ALL SCRAP MATERIALS SUCH AS COAXIAL CABLES AND OTHER ITEMS REMOVED FROM THE EXISTING FACILITY. ANTENNAS AND RADIOS REMOVED SHALL BE RETURNED TO THE OWNER'S DESIGNATED LOCATION.
21. CONTRACTOR SHALL LEAVE PREMISES IN CLEAN CONDITION. TRASH AND DEBRIS SHOULD BE REMOVED FROM SITE ON A DAILY BASIS.
22. NO FILL OR EMBANKMENT MATERIAL SHALL BE PLACED ON FROZEN GROUND. FROZEN MATERIALS, SNOW OR ICE SHALL NOT BE PLACED IN ANY FILL OR EMBANKMENT.

**GENERAL NOTES:**

1. FOR THE PURPOSE OF CONSTRUCTION DRAWING, THE FOLLOWING DEFINITIONS SHALL APPLY:  
CONTRACTOR: GENERAL CONTRACTOR RESPONSIBLE FOR CONSTRUCTION  
CARRIER: DISH Wireless L.L.C.  
TOWER OWNER: TOWER OWNER
2. THESE DRAWINGS HAVE BEEN PREPARED USING STANDARDS OF PROFESSIONAL CARE AND COMPLETENESS NORMALLY EXERCISED UNDER SIMILAR CIRCUMSTANCES BY REPUTABLE ENGINEERS IN THIS OR SIMILAR LOCALITIES. IT IS ASSUMED THAT THE WORK DEPICTED WILL BE PERFORMED BY AN EXPERIENCED CONTRACTOR AND/OR WORKPEOPLE WHO HAVE A WORKING KNOWLEDGE OF THE APPLICABLE CODE STANDARDS AND REQUIREMENTS AND OF INDUSTRY ACCEPTED STANDARD GOOD PRACTICE. AS NOT EVERY CONDITION OR ELEMENT IS (OR CAN BE) EXPLICITLY SHOWN ON THESE DRAWINGS, THE CONTRACTOR SHALL USE INDUSTRY ACCEPTED STANDARD GOOD PRACTICE FOR MISCELLANEOUS WORK NOT EXPLICITLY SHOWN.
3. THESE DRAWINGS REPRESENT THE FINISHED STRUCTURE. THEY DO NOT INDICATE THE MEANS OR METHODS OF CONSTRUCTION. THE CONTRACTOR SHALL BE SOLELY RESPONSIBLE FOR THE CONSTRUCTION MEANS, METHODS, TECHNIQUES, SEQUENCES, AND PROCEDURES. THE CONTRACTOR SHALL PROVIDE ALL MEASURES NECESSARY FOR PROTECTION OF LIFE AND PROPERTY DURING CONSTRUCTION. SUCH MEASURES SHALL INCLUDE, BUT NOT BE LIMITED TO, BRACING, FORMWORK, SHORING, ETC. SITE VISITS BY THE ENGINEER OR HIS REPRESENTATIVE WILL NOT INCLUDE INSPECTION OF THESE ITEMS AND IS FOR STRUCTURAL OBSERVATION OF THE FINISHED STRUCTURE ONLY.
4. NOTES AND DETAILS IN THE CONSTRUCTION DRAWINGS SHALL TAKE PRECEDENCE OVER GENERAL NOTES AND TYPICAL DETAILS. WHERE NO DETAILS ARE SHOWN, CONSTRUCTION SHALL CONFORM TO SIMILAR WORK ON THE PROJECT, AND/OR AS PROVIDED FOR IN THE CONTRACT DOCUMENTS. WHERE DISCREPANCIES OCCUR BETWEEN PLANS, DETAILS, GENERAL NOTES, AND SPECIFICATIONS, THE GREATER, MORE STRICT REQUIREMENTS, SHALL GOVERN. IF FURTHER CLARIFICATION IS REQUIRED CONTACT THE ENGINEER OF RECORD.
5. SUBSTANTIAL EFFORT HAS BEEN MADE TO PROVIDE ACCURATE DIMENSIONS AND MEASUREMENTS ON THE DRAWINGS TO ASSIST IN THE FABRICATION AND/OR PLACEMENT OF CONSTRUCTION ELEMENTS BUT IT IS THE SOLE RESPONSIBILITY OF THE CONTRACTOR TO FIELD VERIFY THE DIMENSIONS, MEASUREMENTS, AND/OR CLEARANCES SHOWN IN THE CONSTRUCTION DRAWINGS PRIOR TO FABRICATION OR CUTTING OF ANY NEW OR EXISTING CONSTRUCTION ELEMENTS. IF IT IS DETERMINED THAT THERE ARE DISCREPANCIES AND/OR CONFLICTS WITH THE CONSTRUCTION DRAWINGS THE ENGINEER OF RECORD IS TO BE NOTIFIED AS SOON AS POSSIBLE.
6. PRIOR TO THE SUBMISSION OF BIDS, THE BIDDING CONTRACTOR SHALL VISIT THE CELL SITE TO FAMILIARIZE WITH THE EXISTING CONDITIONS AND TO CONFIRM THAT THE WORK CAN BE ACCOMPLISHED AS SHOWN ON THE CONSTRUCTION DRAWINGS. ANY DISCREPANCY FOUND SHALL BE BROUGHT TO THE ATTENTION OF CARRIER POC AND TOWER OWNER.
7. ALL MATERIALS FURNISHED AND INSTALLED SHALL BE IN STRICT ACCORDANCE WITH ALL APPLICABLE CODES, REGULATIONS AND ORDINANCES. CONTRACTOR SHALL ISSUE ALL APPROPRIATE NOTICES AND COMPLY WITH ALL LAWS, ORDINANCES, RULES, REGULATIONS AND LAWFUL ORDERS OF ANY PUBLIC AUTHORITY REGARDING THE PERFORMANCE OF THE WORK. ALL WORK CARRIED OUT SHALL COMPLY WITH ALL APPLICABLE MUNICIPAL AND UTILITY COMPANY SPECIFICATIONS AND LOCAL JURISDICTIONAL CODES, ORDINANCES AND APPLICABLE REGULATIONS.
8. UNLESS NOTED OTHERWISE, THE WORK SHALL INCLUDE FURNISHING MATERIALS, EQUIPMENT, APPURTENANCES AND LABOR NECESSARY TO COMPLETE ALL INSTALLATIONS AS INDICATED ON THE DRAWINGS.
9. THE CONTRACTOR SHALL INSTALL ALL EQUIPMENT AND MATERIALS IN ACCORDANCE WITH MANUFACTURER'S RECOMMENDATIONS UNLESS SPECIFICALLY STATED OTHERWISE.
10. IF THE SPECIFIED EQUIPMENT CAN NOT BE INSTALLED AS SHOWN ON THESE DRAWINGS, THE CONTRACTOR SHALL PROPOSE AN ALTERNATIVE INSTALLATION FOR APPROVAL BY THE CARRIER AND TOWER OWNER PRIOR TO PROCEEDING WITH ANY SUCH CHANGE OF INSTALLATION.
11. CONTRACTOR IS TO PERFORM A SITE INVESTIGATION, BEFORE SUBMITTING BIDS, TO DETERMINE THE BEST ROUTING OF ALL CONDUITS FOR POWER, AND TELCO AND FOR GROUNDING CABLES AS SHOWN IN THE POWER, TELCO, AND GROUNDING PLAN DRAWINGS.
12. THE CONTRACTOR SHALL PROTECT EXISTING IMPROVEMENTS, PAVEMENTS, CURBS, LANDSCAPING AND STRUCTURES. ANY DAMAGED PART SHALL BE REPAIRED AT CONTRACTOR'S EXPENSE TO THE SATISFACTION OF DISH Wireless L.L.C. AND TOWER OWNER
13. CONTRACTOR SHALL LEGALLY AND PROPERLY DISPOSE OF ALL SCRAP MATERIALS SUCH AS COAXIAL CABLES AND OTHER ITEMS REMOVED FROM THE EXISTING FACILITY. ANTENNAS REMOVED SHALL BE RETURNED TO THE OWNER'S DESIGNATED LOCATION.
14. CONTRACTOR SHALL LEAVE PREMISES IN CLEAN CONDITION. TRASH AND DEBRIS SHOULD BE REMOVED FROM SITE ON A DAILY BASIS.



5701 SOUTH SANTA FE DRIVE  
LITTLETON, CO 80120



**B&T ENGINEERING, INC.**  
PEC.0001564  
Expires 2/10/22

IT IS A VIOLATION OF LAW FOR ANY PERSON, UNLESS THEY ARE ACTING UNDER THE DIRECTION OF A LICENSED PROFESSIONAL ENGINEER, TO ALTER THIS DOCUMENT.

DRAWN BY:	CHECKED BY:	APPROVED BY:
CD	CD	RCM

RFDS REV #: 0

**CONSTRUCTION DOCUMENTS**

SUBMITTALS		
REV	DATE	DESCRIPTION
A	7/26/21	ISSUED FOR REVIEW
0	8/2/21	ISSUED FOR CONSTRUCTION

A&E PROJECT NUMBER  
153478.001.01

DISH Wireless L.L.C.  
PROJECT INFORMATION  
  
BOBDL00152B  
4 HOFFMANN ROAD  
CANTON, CT 06019

SHEET TITLE  
GENERAL NOTES

SHEET NUMBER  
**GN-2**

**CONCRETE, FOUNDATIONS, AND REINFORCING STEEL:**

1. ALL CONCRETE WORK SHALL BE IN ACCORDANCE WITH THE ACI 301, ACI 318, ACI 336, ASTM A184, ASTM A185 AND THE DESIGN AND CONSTRUCTION SPECIFICATION FOR CAST-IN-PLACE CONCRETE.
2. UNLESS NOTED OTHERWISE, SOIL BEARING PRESSURE USED FOR DESIGN OF SLABS AND FOUNDATIONS IS ASSUMED TO BE 1000 psf.
3. ALL CONCRETE SHALL HAVE A MINIMUM COMPRESSIVE STRENGTH (f'c) OF 3000 psi AT 28 DAYS, UNLESS NOTED OTHERWISE. NO MORE THAN 90 MINUTES SHALL ELAPSE FROM BATCH TIME TO TIME OF PLACEMENT UNLESS APPROVED BY THE ENGINEER OF RECORD. TEMPERATURE OF CONCRETE SHALL NOT EXCEED 90°F AT TIME OF PLACEMENT.
4. CONCRETE EXPOSED TO FREEZE-THAW CYCLES SHALL CONTAIN AIR ENTRAINING ADMIXTURES. AMOUNT OF AIR ENTRAINMENT TO BE BASED ON SIZE OF AGGREGATE AND F3 CLASS EXPOSURE (VERY SEVERE). CEMENT USED TO BE TYPE II PORTLAND CEMENT WITH A MAXIMUM WATER-TO-CEMENT RATIO (W/C) OF 0.45.
5. ALL STEEL REINFORCING SHALL CONFORM TO ASTM A615. ALL WELDED WIRE FABRIC (WWF) SHALL CONFORM TO ASTM A185. ALL SPLICES SHALL BE CLASS "B" TENSION SPLICES, UNLESS NOTED OTHERWISE. ALL HOOKS SHALL BE STANDARD 90 DEGREE HOOKS, UNLESS NOTED OTHERWISE. YIELD STRENGTH (Fy) OF STANDARD DEFORMED BARS ARE AS FOLLOWS:
  - #4 BARS AND SMALLER 40 ksi
  - #5 BARS AND LARGER 60 ksi
6. THE FOLLOWING MINIMUM CONCRETE COVER SHALL BE PROVIDED FOR REINFORCING STEEL UNLESS SHOWN OTHERWISE ON DRAWINGS:
  - CONCRETE CAST AGAINST AND PERMANENTLY EXPOSED TO EARTH 3"
  - CONCRETE EXPOSED TO EARTH OR WEATHER:
    - #6 BARS AND LARGER 2"
    - #5 BARS AND SMALLER 1-1/2"
  - CONCRETE NOT EXPOSED TO EARTH OR WEATHER:
    - SLAB AND WALLS 3/4"
    - BEAMS AND COLUMNS 1-1/2"
7. A TOOLED EDGE OR A 3/4" CHAMFER SHALL BE PROVIDED AT ALL EXPOSED EDGES OF CONCRETE, UNLESS NOTED OTHERWISE, IN ACCORDANCE WITH ACI 301 SECTION 4.2.4.

**ELECTRICAL INSTALLATION NOTES:**

1. ALL ELECTRICAL WORK SHALL BE PERFORMED IN ACCORDANCE WITH THE PROJECT SPECIFICATIONS, NEC AND ALL APPLICABLE FEDERAL, STATE, AND LOCAL CODES/ORDINANCES.
2. CONDUIT ROUTINGS ARE SCHEMATIC. CONTRACTOR SHALL INSTALL CONDUITS SO THAT ACCESS TO EQUIPMENT IS NOT BLOCKED AND TRIP HAZARDS ARE ELIMINATED.
3. WIRING, RACEWAY AND SUPPORT METHODS AND MATERIALS SHALL COMPLY WITH THE REQUIREMENTS OF THE NEC.
4. ALL CIRCUITS SHALL BE SEGREGATED AND MAINTAIN MINIMUM CABLE SEPARATION AS REQUIRED BY THE NEC.
- 4.1. ALL EQUIPMENT SHALL BEAR THE UNDERWRITERS LABORATORIES LABEL OF APPROVAL, AND SHALL CONFORM TO REQUIREMENT OF THE NATIONAL ELECTRICAL CODE.
- 4.2. ALL OVERCURRENT DEVICES SHALL HAVE AN INTERRUPTING CURRENT RATING THAT SHALL BE GREATER THAN THE SHORT CIRCUIT CURRENT TO WHICH THEY ARE SUBJECTED, 22,000 AIC MINIMUM. VERIFY AVAILABLE SHORT CIRCUIT CURRENT DOES NOT EXCEED THE RATING OF ELECTRICAL EQUIPMENT IN ACCORDANCE WITH ARTICLE 110.24 NEC OR THE MOST CURRENT ADOPTED CODE PRE THE GOVERNING JURISDICTION.
5. EACH END OF EVERY POWER PHASE CONDUCTOR, GROUNDING CONDUCTOR, AND TELCO CONDUCTOR OR CABLE SHALL BE LABELED WITH COLOR-CODED INSULATION OR ELECTRICAL TAPE (3M BRAND, 1/2" PLASTIC ELECTRICAL TAPE WITH UV PROTECTION, OR EQUAL). THE IDENTIFICATION METHOD SHALL CONFORM WITH NEC AND OSHA.
6. ALL ELECTRICAL COMPONENTS SHALL BE CLEARLY LABELED WITH LAMICOID TAGS SHOWING THEIR RATED VOLTAGE, PHASE CONFIGURATION, WIRE CONFIGURATION, POWER OR AMPACITY RATING AND BRANCH CIRCUIT ID NUMBERS (i.e. PANEL BOARD AND CIRCUIT ID'S).
7. PANEL BOARDS (ID NUMBERS) SHALL BE CLEARLY LABELED WITH PLASTIC LABELS.
8. TIE WRAPS ARE NOT ALLOWED.
9. ALL POWER AND EQUIPMENT GROUND WIRING IN TUBING OR CONDUIT SHALL BE SINGLE COPPER CONDUCTOR (#14 OR LARGER) WITH TYPE THHW, THWN, THWN-2, XHHW, XHHW-2, THW, THW-2, RHW, OR RHW-2 INSULATION UNLESS OTHERWISE SPECIFIED.
10. SUPPLEMENTAL EQUIPMENT GROUND WIRING LOCATED INDOORS SHALL BE SINGLE COPPER CONDUCTOR (#6 OR LARGER) WITH TYPE THHW, THWN, THWN-2, XHHW, XHHW-2, THW, THW-2, RHW, OR RHW-2 INSULATION UNLESS OTHERWISE SPECIFIED.
11. POWER AND CONTROL WIRING IN FLEXIBLE CORD SHALL BE MULTI-CONDUCTOR, TYPE SOOW CORD (#14 OR LARGER) UNLESS OTHERWISE SPECIFIED.
12. POWER AND CONTROL WIRING FOR USE IN CABLE TRAY SHALL BE MULTI-CONDUCTOR, TYPE TC CABLE (#14 OR LARGER), WITH TYPE THHW, THWN, THWN-2, XHHW, XHHW-2, THW, THW-2, RHW, OR RHW-2 INSULATION UNLESS OTHERWISE SPECIFIED.
13. ALL POWER AND GROUNDING CONNECTIONS SHALL BE CRIMP-STYLE, COMPRESSION WIRE LUGS AND WIRE NUTS BY THOMAS AND BETTS (OR EQUAL). LUGS AND WIRE NUTS SHALL BE RATED FOR OPERATION NOT LESS THAN 75° C (90° C IF AVAILABLE).
14. RACEWAY AND CABLE TRAY SHALL BE LISTED OR LABELED FOR ELECTRICAL USE IN ACCORDANCE WITH NEMA, UL, ANSI/IEEE AND NEC.
15. ELECTRICAL METALLIC TUBING (EMT), INTERMEDIATE METAL CONDUIT (IMC), OR RIGID METAL CONDUIT (RMC) SHALL BE USED FOR EXPOSED INDOOR LOCATIONS.

16. ELECTRICAL METALLIC TUBING (EMT) OR METAL-CLAD CABLE (MC) SHALL BE USED FOR CONCEALED INDOOR LOCATIONS.
17. SCHEDULE 40 PVC UNDERGROUND ON STRAIGHTS AND SCHEDULE 80 PVC FOR ALL ELBOWS/90s AND ALL APPROVED ABOVE GRADE PVC CONDUIT.
18. LIQUID-TIGHT FLEXIBLE METALLIC CONDUIT (LIQUID-TITE FLEX) SHALL BE USED INDOORS AND OUTDOORS, WHERE VIBRATION OCCURS OR FLEXIBILITY IS NEEDED.
19. CONDUIT AND TUBING FITTINGS SHALL BE THREADED OR COMPRESSION-TYPE AND APPROVED FOR THE LOCATION USED. SET SCREW FITTINGS ARE NOT ACCEPTABLE.
20. CABINETS, BOXES AND WIRE WAYS SHALL BE LABELED FOR ELECTRICAL USE IN ACCORDANCE WITH NEMA, UL, ANSI/IEEE AND THE NEC.
21. WIREWAYS SHALL BE METAL WITH AN ENAMEL FINISH AND INCLUDE A HINGED COVER, DESIGNED TO SWING OPEN DOWNWARDS (WIREMOLD SPECMATE WIREWAY).
22. SLOTTED WIRING DUCT SHALL BE PVC AND INCLUDE COVER (PANDUIT TYPE E OR EQUAL).
23. CONDUITS SHALL BE FASTENED SECURELY IN PLACE WITH APPROVED NON-PERFORATED STRAPS AND HANGERS. EXPLOSIVE DEVICES (i.e. POWDER-ACTUATED) FOR ATTACHING HANGERS TO STRUCTURE WILL NOT BE PERMITTED. CLOSELY FOLLOW THE LINES OF THE STRUCTURE, MAINTAIN CLOSE PROXIMITY TO THE STRUCTURE AND KEEP CONDUITS IN TIGHT ENVELOPES. CHANGES IN DIRECTION TO ROUTE AROUND OBSTACLES SHALL BE MADE WITH CONDUIT OUTLET BODIES. CONDUIT SHALL BE INSTALLED IN A NEAT AND WORKMANLIKE MANNER. PARALLEL AND PERPENDICULAR TO STRUCTURE WALL AND CEILING LINES. ALL CONDUIT SHALL BE FISHED TO CLEAR OBSTRUCTIONS. ENDS OF CONDUITS SHALL BE TEMPORARILY CAPPED FLUSH TO FINISH GRADE TO PREVENT CONCRETE, PLASTER OR DIRT FROM ENTERING. CONDUITS SHALL BE RIGIDLY CLAMPED TO BOXES BY GALVANIZED MALLEABLE IRON BUSHING ON INSIDE AND GALVANIZED MALLEABLE IRON LOCKNUT ON OUTSIDE AND INSIDE.
24. EQUIPMENT CABINETS, TERMINAL BOXES, JUNCTION BOXES AND PULL BOXES SHALL BE GALVANIZED OR EPOXY-COATED SHEET STEEL SHALL MEET OR EXCEED UL 50 AND BE RATED NEMA 1 (OR BETTER) FOR INTERIOR LOCATIONS AND NEMA 3 (OR BETTER) FOR EXTERIOR LOCATIONS.
25. METAL RECEPTACLE, SWITCH AND DEVICE BOXES SHALL BE GALVANIZED, EPOXY-COATED OR NON-CORRODING; SHALL MEET OR EXCEED UL 514A AND NEMA OS 1 AND BE RATED NEMA 1 (OR BETTER) FOR INTERIOR LOCATIONS AND WEATHER PROTECTED (WP OR BETTER) FOR EXTERIOR LOCATIONS.
26. NONMETALLIC RECEPTACLE, SWITCH AND DEVICE BOXES SHALL MEET OR EXCEED NEMA OS 2 (NEWEST REVISION) AND BE RATED NEMA 1 (OR BETTER) FOR INTERIOR LOCATIONS AND WEATHER PROTECTED (WP OR BETTER) FOR EXTERIOR LOCATIONS.
27. THE CONTRACTOR SHALL NOTIFY AND OBTAIN NECESSARY AUTHORIZATION FROM THE CARRIER AND/OR DISH Wireless L.L.C. AND TOWER OWNER BEFORE COMMENCING WORK ON THE AC POWER DISTRIBUTION PANELS.
28. THE CONTRACTOR SHALL PROVIDE NECESSARY TAGGING ON THE BREAKERS, CABLES AND DISTRIBUTION PANELS IN ACCORDANCE WITH THE APPLICABLE CODES AND STANDARDS TO SAFEGUARD LIFE AND PROPERTY.
29. INSTALL LAMICOID LABEL ON THE METER CENTER TO SHOW "DISH Wireless L.L.C.".
30. ALL EMPTY/SPARE CONDUITS THAT ARE INSTALLED ARE TO HAVE A METERED MULE TAPE PULL CORD INSTALLED.



5701 SOUTH SANTA FE DRIVE  
LITTLETON, CO 80120



**B&T ENGINEERING, INC.**  
PEC.0001564  
Expires 2/10/22

IT IS A VIOLATION OF LAW FOR ANY PERSON, UNLESS THEY ARE ACTING UNDER THE DIRECTION OF A LICENSED PROFESSIONAL ENGINEER, TO ALTER THIS DOCUMENT.

DRAWN BY:	CHECKED BY:	APPROVED BY:
CD	CD	RCM

RFDS REV #: 0

**CONSTRUCTION DOCUMENTS**

SUBMITTALS		
REV	DATE	DESCRIPTION
A	7/26/21	ISSUED FOR REVIEW
0	8/2/21	ISSUED FOR CONSTRUCTION

A&E PROJECT NUMBER  
153478.001.01

DISH Wireless L.L.C.  
PROJECT INFORMATION  
  
BOBDL00152B  
4 HOFFMANN ROAD  
CANTON, CT 06019

SHEET TITLE  
GENERAL NOTES

SHEET NUMBER  
**GN-3**

**GROUNDING NOTES:**

1. ALL GROUND ELECTRODE SYSTEMS (INCLUDING TELECOMMUNICATION, RADIO, LIGHTNING PROTECTION AND AC POWER GES'S) SHALL BE BONDED TOGETHER AT OR BELOW GRADE, BY TWO OR MORE COPPER BONDING CONDUCTORS IN ACCORDANCE WITH THE NEC.
2. THE CONTRACTOR SHALL PERFORM IEEE FALL-OF-POTENTIAL RESISTANCE TO EARTH TESTING (PER IEEE 1100 AND 81) FOR GROUND ELECTRODE SYSTEMS, THE CONTRACTOR SHALL FURNISH AND INSTALL SUPPLEMENTAL GROUND ELECTRODES AS NEEDED TO ACHIEVE A TEST RESULT OF 5 OHMS OR LESS.
3. THE CONTRACTOR IS RESPONSIBLE FOR PROPERLY SEQUENCING GROUNDING AND UNDERGROUND CONDUIT INSTALLATION AS TO PREVENT ANY LOSS OF CONTINUITY IN THE GROUNDING SYSTEM OR DAMAGE TO THE CONDUIT AND PROVIDE TESTING RESULTS.
4. METAL CONDUIT AND TRAY SHALL BE GROUNDED AND MADE ELECTRICALLY CONTINUOUS WITH LISTED BONDING FITTINGS OR BY BONDING ACROSS THE DISCONTINUITY WITH #6 COPPER WIRE UL APPROVED GROUNDING TYPE CONDUIT CLAMPS.
5. METAL RACEWAY SHALL NOT BE USED AS THE NEC REQUIRED EQUIPMENT GROUND CONDUCTOR. STRANDED COPPER CONDUCTORS WITH GREEN INSULATION, SIZED IN ACCORDANCE WITH THE NEC, SHALL BE FURNISHED AND INSTALLED WITH THE POWER CIRCUITS TO BTS EQUIPMENT.
6. EACH CABINET FRAME SHALL BE DIRECTLY CONNECTED TO THE MASTER GROUND BAR WITH GREEN INSULATED SUPPLEMENTAL EQUIPMENT GROUND WIRES, #6 STRANDED COPPER OR LARGER FOR INDOOR BTS; #2 BARE SOLID TINNED COPPER FOR OUTDOOR BTS.
7. CONNECTIONS TO THE GROUND BUS SHALL NOT BE DOUBLED UP OR STACKED BACK TO BACK CONNECTIONS ON OPPOSITE SIDE OF THE GROUND BUS ARE PERMITTED.
8. ALL EXTERIOR GROUND CONDUCTORS BETWEEN EQUIPMENT/GROUND BARS AND THE GROUND RING SHALL BE #2 SOLID TINNED COPPER UNLESS OTHERWISE INDICATED.
9. ALUMINUM CONDUCTOR OR COPPER CLAD STEEL CONDUCTOR SHALL NOT BE USED FOR GROUNDING CONNECTIONS.
10. USE OF 90° BENDS IN THE PROTECTION GROUNDING CONDUCTORS SHALL BE AVOIDED WHEN 45° BENDS CAN BE ADEQUATELY SUPPORTED.
11. EXOTHERMIC WELDS SHALL BE USED FOR ALL GROUNDING CONNECTIONS BELOW GRADE.
12. ALL GROUND CONNECTIONS ABOVE GRADE (INTERIOR AND EXTERIOR) SHALL BE FORMED USING HIGH PRESS CRIMPS.
13. COMPRESSION GROUND CONNECTIONS MAY BE REPLACED BY EXOTHERMIC WELD CONNECTIONS.
14. ICE BRIDGE BONDING CONDUCTORS SHALL BE EXOTHERMICALLY BONDED OR BOLTED TO THE BRIDGE AND THE TOWER GROUND BAR.
15. APPROVED ANTIOXIDANT COATINGS (i.e. CONDUCTIVE GEL OR PASTE) SHALL BE USED ON ALL COMPRESSION AND BOLTED GROUND CONNECTIONS.
16. ALL EXTERIOR GROUND CONNECTIONS SHALL BE COATED WITH A CORROSION RESISTANT MATERIAL.
17. MISCELLANEOUS ELECTRICAL AND NON-ELECTRICAL METAL BOXES, FRAMES AND SUPPORTS SHALL BE BONDED TO THE GROUND RING, IN ACCORDANCE WITH THE NEC.
18. BOND ALL METALLIC OBJECTS WITHIN 6 ft OF MAIN GROUND RING WITH (1) #2 BARE SOLID TINNED COPPER GROUND CONDUCTOR.
19. GROUND CONDUCTORS USED FOR THE FACILITY GROUNDING AND LIGHTNING PROTECTION SYSTEMS SHALL NOT BE ROUTED THROUGH METALLIC OBJECTS THAT FORM A RING AROUND THE CONDUCTOR, SUCH AS METALLIC CONDUITS, METAL SUPPORT CLIPS OR SLEEVES THROUGH WALLS OR FLOORS. WHEN IT IS REQUIRED TO BE HOUSED IN CONDUIT TO MEET CODE REQUIREMENTS OR LOCAL CONDITIONS, NON-METALLIC MATERIAL SUCH AS PVC CONDUIT SHALL BE USED. WHERE USE OF METAL CONDUIT IS UNAVOIDABLE (i.e., NONMETALLIC CONDUIT PROHIBITED BY LOCAL CODE) THE GROUND CONDUCTOR SHALL BE BONDED TO EACH END OF THE METAL CONDUIT.
20. ALL GROUNDS THAT TRANSITION FROM BELOW GRADE TO ABOVE GRADE MUST BE #2 BARE SOLID TINNED COPPER IN 3/4" NON-METALLIC, FLEXIBLE CONDUIT FROM 24" BELOW GRADE TO WITHIN 3" TO 6" OF CAD-WELD TERMINATION POINT. THE EXPOSED END OF THE CONDUIT MUST BE SEALED WITH SILICONE CAULK. (ADD TRANSITIONING GROUND STANDARD DETAIL AS WELL).
21. BUILDINGS WHERE THE MAIN GROUNDING CONDUCTORS ARE REQUIRED TO BE ROUTED TO GRADE, THE CONTRACTOR SHALL ROUTE TWO GROUNDING CONDUCTORS FROM THE ROOFTOP, TOWERS, AND WATER TOWERS GROUNDING RING, TO THE EXISTING GROUNDING SYSTEM, THE GROUNDING CONDUCTORS SHALL NOT BE SMALLER THAN 2/0 COPPER. ROOFTOP GROUNDING RING SHALL BE BONDED TO THE EXISTING GROUNDING SYSTEM, THE BUILDING STEEL COLUMNS, LIGHTNING PROTECTION SYSTEM, AND BUILDING MAIN WATER LINE (FERROUS OR NONFERROUS METAL PIPING ONLY). DO NOT ATTACH GROUNDING TO FIRE SPRINKLER SYSTEM PIPES.



5701 SOUTH SANTA FE DRIVE  
LITTLETON, CO 80120



**AMERICAN TOWER®**  
10 PRESIDENTIAL WAY  
WOBURN, MA 01801



**B+T GRP**  
1717 S. BOULDER  
SUITE 300  
TULSA, OK 74119  
PH: (918) 587-4630  
www.btgrp.com



**B&T ENGINEERING, INC.**  
PEC.0001564  
Expires 2/10/22

IT IS A VIOLATION OF LAW FOR ANY PERSON, UNLESS THEY ARE ACTING UNDER THE DIRECTION OF A LICENSED PROFESSIONAL ENGINEER, TO ALTER THIS DOCUMENT.

DRAWN BY:	CHECKED BY:	APPROVED BY:
CD	CD	RCM

RFDS REV #: 0

**CONSTRUCTION DOCUMENTS**

SUBMITTALS		
REV	DATE	DESCRIPTION
A	7/26/21	ISSUED FOR REVIEW
0	8/2/21	ISSUED FOR CONSTRUCTION

A&E PROJECT NUMBER  
153478.001.01

DISH Wireless L.L.C.  
PROJECT INFORMATION

BOBDL00152B  
4 HOFFMANN ROAD  
CANTON, CT 06019

SHEET TITLE  
GENERAL NOTES

SHEET NUMBER  
**GN-4**

ENGINEERING:  
STRUCTURAL ANALYSIS  
MOUNT ANALYSIS



**AMERICAN TOWER®**  
CORPORATION

This report was prepared for American Tower Corporation by



**TOWER  
ENGINEERING  
PROFESSIONALS**

---

## Structural Analysis Report

**Structure** : 150 ft Monopole  
**ATC Site Name** : Cntn - Canton, CT  
**ATC Asset Number** : 302488  
**Engineering Number** : 13692185\_C3\_03  
**Proposed Carrier** : DISH WIRELESS L.L.C.  
**Carrier Site Name** : BOBDL00152B  
**Carrier Site Number** : BOBDL00152B  
**Site Location** : 4 Hoffmann Road  
Canton, CT 06019-2122  
41.855300,-72.892500  
**County** : Hartford  
**Date** : July 8, 2021  
**Max Usage** : 96%  
**Result** : Pass

Prepared By:  
Colson Teal  
TEP

Reviewed By:



07/08/2021

**COA: PEC.0001553**



**Table of Contents**

Introduction ..... 1

Supporting Documents ..... 1

Analysis ..... 1

Conclusion..... 1

Existing and Reserved Equipment..... 2

Equipment to be Removed..... 2

Proposed Equipment ..... 2

Structure Usages ..... 3

Foundations ..... 3

Deflection, Twist, and Sway..... 3

Standard Conditions ..... 4

Calculations ..... Attached



## Introduction

The purpose of this report is to summarize results of a structural analysis performed on the 150 ft monopole to reflect the change in loading by DISH WIRELESS L.L.C..

## Supporting Documents

<b>Tower Drawings</b>	ITT Meyer, AT&T Spec. AT-8935 B, dated April 13, 1984
<b>Foundation Drawing</b>	Girard & Co. Drawing dated April 22, 1986 Mapping by ETS Job #201898, dated April 28, 2020
<b>Geotechnical Report</b>	GEOServices Project #21-07254, dated September 12, 2008
<b>Modifications</b>	ATC Project #51822034, dated March 14, 2013 ATC Project #OAA694941_C6_06, dated May 11, 2017 ATC Project #13201406_C6_05, dated July 8, 2020

## Analysis

The tower was analyzed using American Tower Corporation's tower analysis software. This program considers an elastic three-dimensional model and second-order effects per ANSI/TIA-222.

<b>Basic Wind Speed:</b>	115 mph (3-Second Gust)
<b>Basic Wind Speed w/ Ice:</b>	50 mph (3-Second Gust) w/ 1 1/2" radial ice concurrent
<b>Code:</b>	ANSI/TIA-222-H / 2015 IBC / 2018 Connecticut State Building Code
<b>Exposure Category:</b>	B
<b>Risk Category:</b>	II
<b>Topographic Factor Procedure:</b>	Method 1
<b>Topographic Category:</b>	1
<b>Crest Height (H):</b>	0 ft
<b>Spectral Response:</b>	$S_s = 0.18, S_1 = 0.05$
<b>Site Class:</b>	D - Stiff Soil

## Conclusion

Based on the analysis results, the structure meets the requirements per the applicable codes listed above. The tower and foundation can support the equipment as described in this report.

If you have any questions or require additional information, please contact American Tower via email at [Engineering@americantower.com](mailto:Engineering@americantower.com). Please include the American Tower site name, site number, and engineering number in the subject line for any questions.



**Existing and Reserved Equipment**

Elev. <sup>1</sup> (ft)	Qty	Equipment	Mount Type	Lines	Carrier
163.0	1	Generic 12' Omni	Platform with Handrails	(1) 1 5/8" Coax	SPOK HOLDINGS, INC.
161.0	1	Generic 12' Dipole		(1) 7/8" Coax	TOWN OF CANTON
155.5	1	Generic 6' Yagi		(1) 1/2" Coax	SPOK HOLDINGS, INC.
152.0	3	CCI HPA-65R-BUU-H8		(2) 0.39" (10mm) Fiber Trunk (4) 0.78" (19.7mm) 8 AWG 6 (12) 1 1/4" Coax (2) 3" conduit	AT&T MOBILITY
150.0	3	Ericsson RRUS 11 (Band 12)			
	3	Ericsson RRUS 32 B2			
	6	Powerwave Allgon 7770.00A			
	1	Raycap DC6-48-60-18-8F(32.8 lbs)			
	6	Powerwave Allgon TT19-08BP111-001			
	3	Andrew ABT-D MDF-ADBH			
140.0	6	Powerwave Allgon 7020.00 Dual Band RET	Platform with Handrails	(3) 1 5/8" Hybriflex	T-MOBILE
	3	RFS APX16DWV-16DWVS-E-A20			
	3	Ericsson Air6449 B41			
	3	RFS APXVAALL24 43-U-NA20			
	3	Ericsson Radio 4460 B25+B66			
123.0	3	Ericsson Radio 4480 B71+B85A	Stand-Off	(1) 7/8" Coax	TOWN OF CANTON
	1	Generic 75" x 16.8" Panel			
118.0	6	Commscope NHH-65B-R2B	Platform with Handrails	(2) 1 5/8" Hybriflex	VERIZON WIRELESS
	1	Raycap RCMDc-6627-PF-48			
	3	Samsung B5/B13 RRH-BR04C			
	3	Samsung B2/B66A RRH-BR049			
10.0	1	Channel Master Type 120	Flush	(1) 0.28" (7mm) RG-6	SPOK HOLDINGS, INC.

**Equipment to be Removed**

Elev. <sup>1</sup> (ft)	Qty	Equipment	Mount Type	Lines	Carrier
No loading was considered as removed as part of this analysis.					

**Proposed Equipment**

Elev. <sup>1</sup> (ft)	Qty	Equipment	Mount Type	Lines	Carrier
108.0	1	Commscope RDIDC-9181-PF-48	Platform with Handrails	(1) 1.60" (40.6mm) Hybrid	DISH WIRELESS L.L.C.
	3	Fujitsu TA08025-B604			
	3	Fujitsu TA08025-B605			
	3	JMA Wireless MX08FRO665-21			

<sup>1</sup> Contracted elevations are shown for appurtenances within contracted installation tolerances. Appurtenances outside of contract limits are shown at installed elevations.

Install proposed coax outside the pole shaft. Stacking coax is not allowed.





**Structure Usages**

Structural Component	Controlling Usage	Pass/Fail
Anchor Bolts	89%	Pass
Shaft	85%	Pass
Base Plate	58%	Pass
Reinforcement	96%	Pass
Flange	81%	Pass

**Foundations**

Reaction Component	Analysis Reactions	% of Usage
Moment (Kips-Ft)	2,568.0	51%
Axial (Kips)	49.5	13%
Shear (Kips)	22.8	20%

The structure base reactions resulting from this analysis were found to be acceptable through analysis based on geotechnical and foundation information, therefore no modification or reinforcement of the foundation will be required.

**Deflection and Sway\***

Antenna Elevation (ft)	Antenna	Carrier	Deflection (ft)	Sway (Rotation) (°)
108.0	Commscope RDIDC-9181-PF-48	DISH WIRELESS L.L.C.	1.400	1.390
	Fujitsu TA08025-B604			
	Fujitsu TA08025-B605			
	JMA Wireless MX08FRO665-21			
10.0	Channel Master Type 120	SPOK HOLDINGS, INC.	0.012	0.140

\*Deflection and Sway was evaluated considering a design wind speed of 60 mph (3-Second Gust) per ANSI/TIA-222-H



## **Standard Conditions**

All engineering services performed by A.T. Engineering Service, PLLC are prepared on the basis that the information used is current and correct. This information may consist of, but is not limited to the following:

- Information supplied by the client regarding antenna, mounts and feed line loading
- Information from drawings, design and analysis documents, and field notes in the possession of A.T. Engineering Service, PLLC

It is the responsibility of the client to ensure that the information provided to A.T. Engineering Service, PLLC and used in the performance of our engineering services is correct and complete.

All assets of American Tower Corporation, its affiliates and subsidiaries (collectively "American Tower") are inspected at regular intervals. Based upon these inspections and in the absence of information to the contrary, American Tower assumes that all structures were constructed in accordance with the drawings and specifications.

Unless explicitly agreed by both the client and A.T. Engineering Service, PLLC, all services will be performed in accordance with the current revision of ANSI/TIA-222.

All services are performed, results obtained, and recommendations made in accordance with generally accepted engineering principles and practices. A.T. Engineering Service, PLLC is not responsible for the conclusions, opinions and recommendations made by others based on the information supplied herein.

© 2007 - 2021 by ATC IP LLC. All rights reserved.

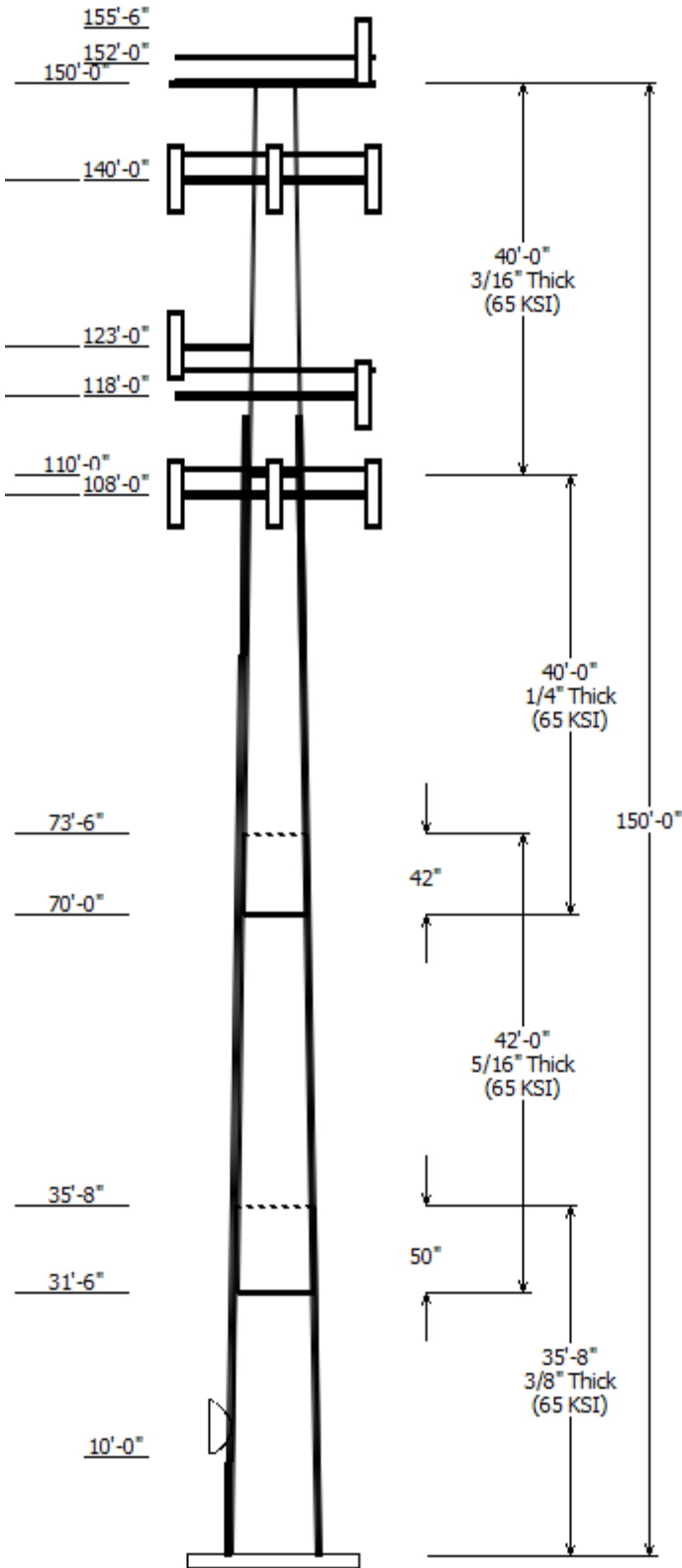

Job Information	
Client : DISH WIRELESS L.L.C.	
Pole : 302488	Code: ANSI/TIA-222-H
Location : Cntn - Canton, CT	
Description : 150 ft ITT Meyer Type B Monopole	Risk Category : II
Shape : 12 Sides	Exposure : B
Height : 150.00 (ft)	Topo Method : Method 1
Base Elev (ft): 0.00	Topographic Category : 1
Taper: 0.156707(in/ft)	

Sections Properties							
Shaft Section	Length (ft)	Diameter (in)		Thick (in)	Joint Type	Overlap Length (in)	Steel Grade (ksi)
		Across Flats Top	Across Flats Bottom				
1	35.666	31.79	37.38	0.375		0.000	12 Sides 65
2	42.000	26.48	33.06	0.313	Slip Joint	50.000	12 Sides 65
3	40.000	21.26	27.53	0.250	Slip Joint	42.000	12 Sides 65
4	40.001	14.99	21.26	0.188	Butt Joint	0.000	12 Sides 65

Discrete Appurtenance			
Attach Elev (ft)	Force Elev (ft)	Qty	Description
163.000	163.000	1	Generic 12' Omni
161.000	161.000	1	Generic 12' Dipole
155.500	155.500	1	Generic 6' Yagi
152.000	153.000	3	CCI HPA-65R-BUU-H8
150.000	150.000	3	Generic Round Stand-Off
150.000	150.000	1	Round Platform w/ Handrails
150.000	153.000	6	Powerwave Allgon 7770.00A
150.000	153.000	3	Ericsson RRUS 32 B2
150.000	153.000	3	Ericsson RRUS 11 (Band 12)
150.000	153.000	1	Raycap DC6-48-60-18-8F(32.8 lb
150.000	153.000	6	Powerwave Allgon TT19-
150.000	150.000	6	Powerwave Allgon 7020.00
150.000	150.000	3	Andrew ABT-DMDF-ADBH
140.000	140.000	1	Round Platform w/ Handrails
140.000	140.000	3	RFS APXVAALL24 43-U-NA20
140.000	140.000	3	RFS APX16DWV-16DWV5-E-A20
140.000	140.000	3	Ericsson Air6449 B41
140.000	140.000	3	Ericsson Radio 4480 B71+B85A
140.000	140.000	3	Ericsson Radio 4460 B25+B66
123.000	123.000	1	Stand-Off
123.000	123.000	1	Generic 75" x 16.8" Panel
118.000	118.000	1	Generic Round Platform with
118.000	118.000	6	Commscope NHH-65B-R2B
118.000	118.000	1	Raycap RCMD-6627-PF-48
118.000	118.000	3	Samsung B5/B13 RRH-BR04C
118.000	118.000	3	Samsung B2/B66A RRH-BR049
108.000	108.000	3	JMA Wireless MX08FRO665-21
108.000	108.000	3	Fujitsu TA08025-B605
108.000	108.000	3	Fujitsu TA08025-B604
108.000	108.000	1	Commscope RDIDC-9181-PF-48
108.000	108.000	1	Round Platform w/ Handrails
10.000	11.000	1	Channel Master Type 120

Linear Appurtenance			
From Elev (ft)	To Elev (ft)	Description	Exposed To Wind
84.920	120.5	Reinforcement	Yes
84.920	120.5	Reinforcement	Yes
84.920	120.5	Reinforcement	Yes
84.920	120.5	Reinforcement	Yes
84.920	120.5	Reinforcement	Yes

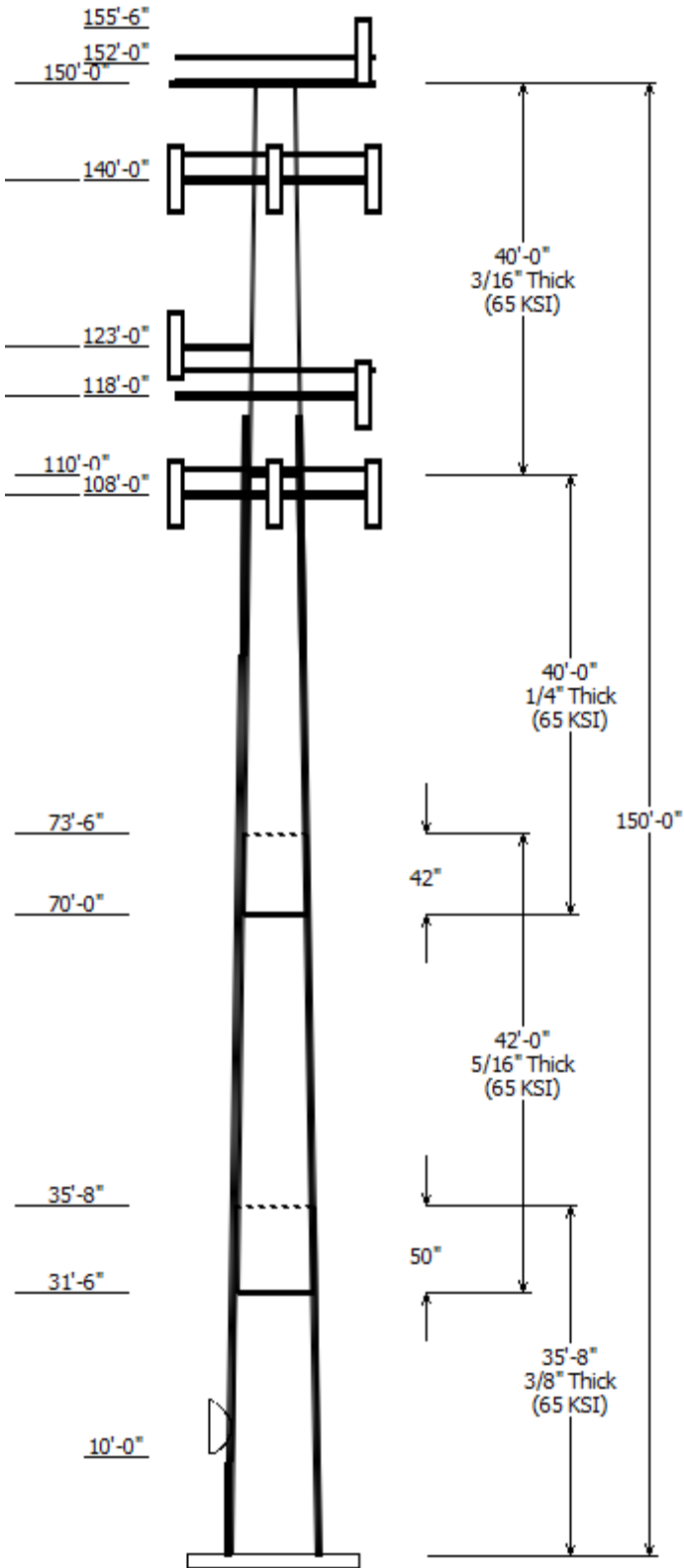

84.920	120.5	Reinforcement	Yes
0.000	123.0	7/8" Coax	No
0.000	140.0	1 5/8" Hybriflex	Yes
0.000	150.0	0.39" (10mm)	No
0.000	150.0	0.78" (19.7mm) 8	No
0.000	150.0	1 1/4" Coax	No
0.000	150.0	3" conduit	No
0.000	155.5	1/2" Coax	No
0.000	161.0	7/8" Coax	No
0.000	163.0	1 5/8" Coax	No
0.000	10.000	0.28" (7mm) RG-6	No
0.000	95.500	Reinforcement	Yes
0.000	95.500	Reinforcement	Yes
0.000	95.500	Reinforcement	Yes
0.000	95.500	Reinforcement	Yes
0.000	108.0	1.60" (40.6mm)	Yes
0.000	118.0	1 5/8" Hybriflex	No

Load Cases	
1.2D + 1.0W	115 mph with No Ice
0.9D + 1.0W	115 mph with No Ice (Reduced DL)
1.2D + 1.0Di + 1.0Wi	50 mph with 1.50 in Radial Ice
1.2D + 1.0Ev + 1.0Eh	Seismic
0.9D - 1.0Ev + 1.0Eh	Seismic (Reduced DL)
1.0D + 1.0W	Serviceability 60 mph

Reactions			
Load Case	Moment (kip-ft)	Shear (kip)	Axial (kip)
1.2D + 1.0W	2567.96	22.84	49.51
0.9D + 1.0W	2508.74	22.81	37.12
1.2D + 1.0Di + 1.0Wi	861.83	6.99	74.46
1.2D + 1.0Ev + 1.0Eh	210.92	1.62	49.43
0.9D - 1.0Ev + 1.0Eh	204.90	1.62	34.46
1.0D + 1.0W	617.09	5.56	41.31

Dish Deflections			
Load Case	Attach Elev (ft)	Deflection (in)	Rotation (deg)
1.0D + 1.0W	10.00	0.144	0.137

Load Case : 1.2D + 1.0W  
Max Ratio 85.03% at 115.9 ft

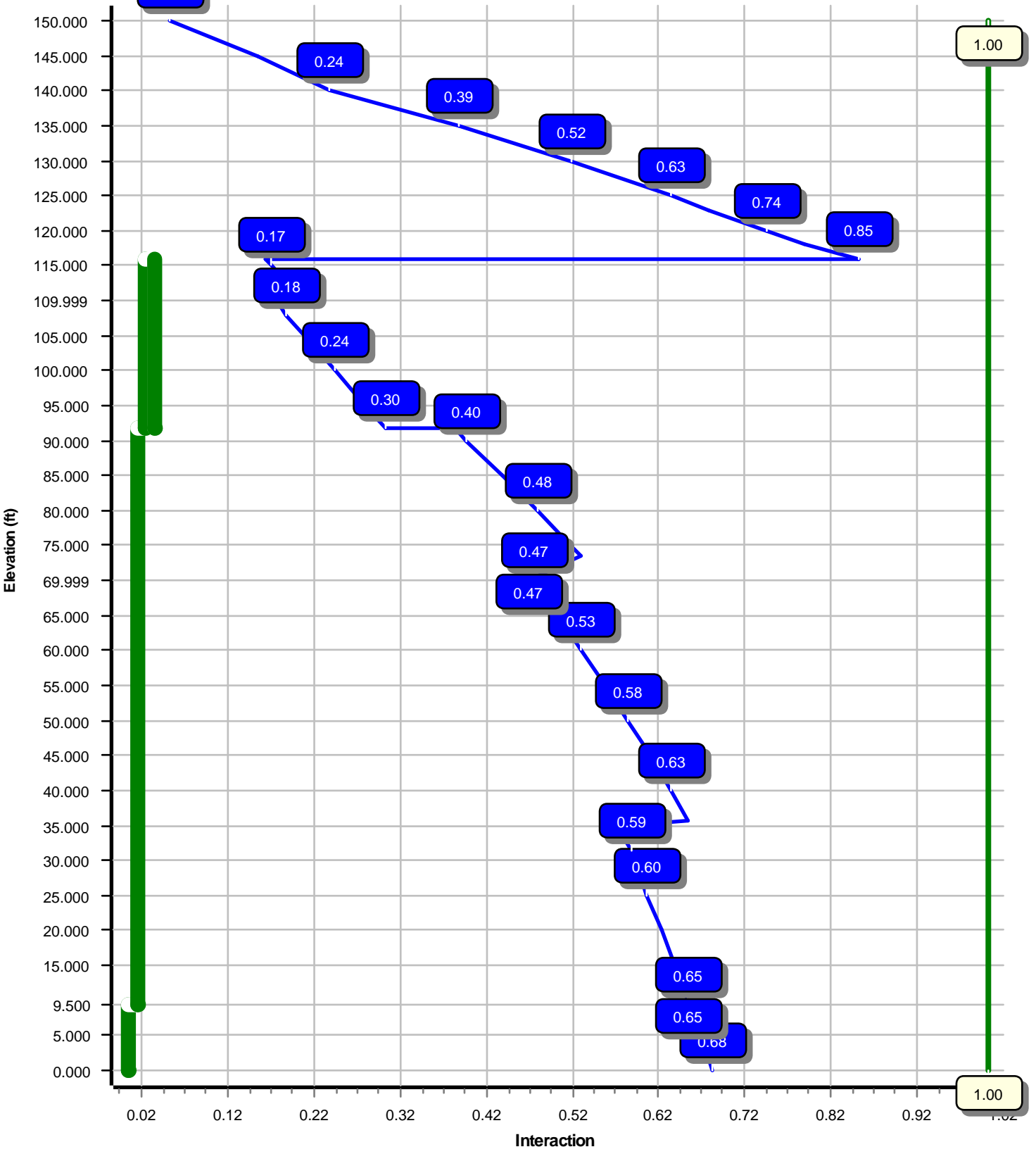

Site Number: 302488

Code: ANSI/TIA-222-H

© 2007 - 2021 by ATC IP LLC. All rights reserved.

Site Name: Cntr - Canton, CT

Engineering Number: 13692185\_C3\_03

7/8/2021 1:38:52 PM

Customer: DISH WIRELESS L.L.C.

Analysis Parameters

Location :	Hartford County, CT	Height (ft) :	150
Code :	ANSI/TIA-222-H	Base Diameter (in) :	37.38
Shape :	12 Sides	Top Diameter (in) :	15.00
Pole Type :	Taper	Taper (in/ft) :	0.157
Pole Manufacturer :	ITT Meyer	Rotation (deg) :	0.00
Kd (non-service) :	0.95	Ke :	0.97

Ice & Wind Parameters

Exposure Category:	B	Design Wind Speed Without Ice:	115 mph
Risk Category:	II	Design Wind Speed With Ice:	50 mph
Topographic Factor Procedure:	Method 1	Operational Wind Speed:	60 mph
Topographic Category:	1	Design Ice Thickness:	1.50 in
Crest Height:	0 ft	HMSL:	788.00 ft

Seismic Parameters

Analysis Method:	Equivalent Lateral Force Method		
Site Class:	D - Stiff Soil		
Period Based on Rayleigh Method (sec):	3.23		
$T_L$ (sec):	6	$p$ :	1.3
$S_s$ :	0.175	$S_1$ :	0.054
$F_a$ :	1.600	$F_v$ :	2.400
$S_{ds}$ :	0.187	$S_{d1}$ :	0.086
		$C_s$ :	0.030
		$C_s$ Max:	0.030
		$C_s$ Min:	0.030

Load Cases

1.2D + 1.0W	115 mph with No Ice
0.9D + 1.0W	115 mph with No Ice (Reduced DL)
1.2D + 1.0Di + 1.0Wi	50 mph with 1.50 in Radial Ice
1.2D + 1.0Ev + 1.0Eh	Seismic
0.9D - 1.0Ev + 1.0Eh	Seismic (Reduced DL)
1.0D + 1.0W	Serviceability 60 mph

Site Number: 302488

Code: ANSI/TIA-222-H

© 2007 - 2021 by ATC IP LLC. All rights reserved.

Site Name: Cntrn - Canton, CT

Engineering Number: 13692185\_C3\_03

7/8/2021 1:38:52 PM

Customer: DISH WIRELESS L.L.C.

**Shaft Section Properties**

Sect Info	Length (ft)	Thick (in)	Fy (ksi)	Joint Type	Slip Joint Len (in)	Weight (lb)	Bottom						Top						
							Dia (in)	Elev (ft)	Area (in <sup>2</sup> )	Ix (in <sup>4</sup> )	W/t Ratio	D/t Ratio	Dia (in)	Elev (ft)	Area (in <sup>2</sup> )	Ix (in <sup>4</sup> )	W/t Ratio	D/t Ratio	Taper (in/ft)
1-12	35.666	0.3750	65		0.00	5,013	37.38	0.00	44.68	7810.1	24.03	99.68	31.79	35.67	37.93	4778.8	20.04	84.78	0.156707
2-12	42.000	0.3125	65	Slip	50.00	4,237	33.06	31.50	32.96	4514.2	25.67	105.82	26.48	73.50	26.34	2303.2	20.03	84.76	0.156707
3-12	40.000	0.2500	65	Slip	42.00	2,646	27.53	70.00	21.96	2087.3	26.83	110.14	21.26	110.00	16.92	953.9	20.11	85.07	0.156707
4-12	40.001	0.1875	65	Butt	0.00	1,475	21.26	110.00	12.73	721.8	27.71	113.43	14.99	150.00	8.94	250.4	18.75	79.99	0.156707
Shaft Weight						13,372													

**Discrete Appurtenance Properties**

Attach Elev (ft)	Description	Qty	Ka	Vert Ecc (ft)	Weight (lb)	No Ice EPAa (sf)	Orientation Factor	Weight (lb)	Ice EPAa (sf)	Orientation Factor
163.00	Generic 12' Omni	1	1.00	0.000	40.00	3.600	1.00	130.82	7.898	1.00
161.00	Generic 12' Dipole	1	0.75	0.000	40.00	4.510	1.00	173.39	11.670	1.00
155.50	Generic 6' Yagi	1	0.75	0.000	25.00	8.950	1.00	279.55	32.814	1.00
152.00	CCI HPA-65R-BUU-H8	3	0.75	1.000	68.00	12.976	0.67	325.04	16.557	0.67
150.00	Andrew ABT-D MDF-ADB H	3	0.75	0.000	1.10	0.045	0.50	3.33	0.218	0.50
150.00	Powerwave Allgon 7020.00 Dual	6	0.75	0.000	2.20	0.339	0.50	12.42	0.748	0.50
150.00	Powerwave Allgon TT19-	6	0.75	3.000	16.00	0.553	0.50	36.20	1.064	0.50
150.00	Raycap DC6-48-60-18-8F(32.8	1	0.75	3.000	32.80	1.470	1.00	94.52	2.169	0.50
150.00	Ericsson RRUS 11 (Band 12)	3	0.75	3.000	50.00	2.566	0.50	118.19	3.614	0.50
150.00	Ericsson RRUS 32 B2	3	0.75	3.000	53.00	2.743	0.50	126.58	3.913	0.50
150.00	Generic Round Stand-Off	3	1.00	0.000	187.50	5.200	0.67	278.97	7.918	0.67
150.00	Powerwave Allgon 7770.00A	6	0.75	3.000	27.00	5.555	0.65	141.10	7.692	0.65
150.00	Round Platform w/ Handrails	1	1.00	0.000	2,000.00	27.200	1.00	3,296.26	51.653	1.00
140.00	Ericsson Radio 4460 B25+B66	3	0.75	0.000	109.00	2.564	0.50	196.80	3.611	0.50
140.00	Ericsson Radio 4480 B71+B85A	3	0.75	0.000	84.00	2.852	0.50	159.05	3.961	0.50
140.00	Ericsson Air6449 B41	3	0.75	0.000	104.00	5.682	0.63	239.38	7.259	0.63
140.00	RFS APX16DWV-16DWVS-E-A20	3	0.75	0.000	40.70	6.586	0.60	156.74	8.737	0.60
140.00	RFS APXVAALL24 43-U-NA20	3	0.75	0.000	122.80	20.243	0.63	509.72	23.927	0.63
140.00	Round Platform w/ Handrails	1	1.00	0.000	2,000.00	27.200	1.00	3,287.19	51.482	1.00
123.00	Stand-Off	1	1.00	0.000	100.00	3.000	0.67	147.85	4.538	0.67
123.00	Generic 75" x 16.8" Panel	1	1.00	0.000	31.20	11.264	1.00	258.11	14.097	1.00
118.00	Samsung B2/B66A RRH-BR049	3	0.75	0.000	84.40	1.875	0.50	146.76	2.757	0.50
118.00	Samsung B5/B13 RRH-BR04C	3	0.75	0.000	70.30	1.875	0.50	126.21	2.757	0.50
118.00	Raycap RCMDC-6627-PF-48	1	0.75	0.000	32.00	4.056	1.00	156.22	5.390	0.50
118.00	Commscope NHH-65B-R2B	6	0.75	0.000	43.70	8.079	0.67	214.12	10.802	0.67
118.00	Generic Round Platform with	1	1.00	0.000	2,500.00	27.200	1.00	4,083.18	51.093	1.00
108.00	Commscope RDIDC-9181-PF-48	1	0.75	0.000	21.90	1.867	1.00	77.00	2.739	0.50
108.00	Fujitsu TA08025-B604	3	0.75	0.000	63.90	1.962	0.50	120.37	2.853	0.50
108.00	Fujitsu TA08025-B605	3	0.75	0.000	75.00	1.962	0.50	135.66	2.853	0.50
108.00	JMA Wireless MX08FRO665-21	3	0.75	0.000	64.50	12.489	0.64	313.38	15.210	0.64
108.00	Round Platform w/ Handrails	1	1.00	0.000	2,000.00	27.200	1.00	3,254.72	50.870	1.00
10.00	Channel Master Type 120	1	1.00	1.000	126.00	20.190	1.00	282.80	22.485	1.00
Totals	Num Loadings:32	82			13,016.90			26,813.26		

**Linear Appurtenance Properties**

Load Case Azimuth (deg) : 45

Elev From (ft)	Elev To (ft)	Qty	Coax Dia (in)	Coax Wt (lb/ft)	Max Coax / Flat Row	Dist Between Rows (in)	Dist Between Cols (in)	Dist Azimuth (deg)	Dist Exposed From Face (in)	Dist Exposed To Wind Carrier
0.00	163.00	1	1 5/8"	0.82	N	0	0.00	0.00	0	N SPOK HOLDINGS,
0.00	161.00	1	7/8"	0.33	N	0	0.00	0.00	0	N TOWN OF CANTON
0.00	155.50	1	1/2"	0.15	N	0	0.00	0.00	0	N SPOK HOLDINGS,
0.00	150.00	2	0.39"	0.06	N	0	0.00	0.00	0	N AT&T MOBILITY

Site Number: 302488

Code: ANSI/TIA-222-H

© 2007 - 2021 by ATC IP LLC. All rights reserved.

Site Name: Cntn - Canton, CT

Engineering Number: 13692185\_C3\_03

7/8/2021 1:38:52 PM

Customer: DISH WIRELESS L.L.C.

0.00	150.00	4	0.78" (19.7mm) 8 AWG	0.78	0.59	N	0	0.00	0.00	0	0.00	N	AT&T MOBILITY
0.00	150.00	12	1 1/4" Coax	1.55	0.63	N	0	0.00	0.00	0	0.00	N	AT&T MOBILITY
0.00	150.00	2	3" conduit	3.50	7.58	N	0	0.00	0.00	0	0.00	N	AT&T MOBILITY
0.00	140.00	3	1 5/8" Hybriflex	1.98	1.30	N	3	1.00	1.00	225	1.00	Y	T-MOBILE
0.00	123.00	1	7/8" Coax	1.09	0.33	N	0	0.00	0.00	0	0.00	N	TOWN OF CANTON
84.92	120.50	1	Reinforcement	4.00	0.00	N	1	0.00	0.00	0	8.28	Y	
84.92	120.50	1	Reinforcement	4.00	0.00	N	1	0.00	0.00	120	8.28	Y	
84.92	120.50	1	Reinforcement	4.00	0.00	N	1	0.00	0.00	240	8.28	Y	
84.92	120.50	1	Reinforcement	2.49	6.30	N	1	0.00	0.00	0	2.90	Y	
84.92	120.50	1	Reinforcement	2.49	6.30	N	1	0.00	0.00	120	2.90	Y	
84.92	120.50	1	Reinforcement	2.49	6.30	N	1	0.00	0.00	240	2.90	Y	
0.00	118.00	2	1 5/8" Hybriflex	1.98	1.30	N	0	0.00	0.00	0	0.00	N	VERIZON WIRELESS
0.00	108.00	1	1.60" (40.6mm) Hybrid	1.60	2.34	N	1	1.00	1.00	0	1.00	Y	DISH WIRELESS
0.00	95.50	1	Reinforcement	4.00	4.68	N	1	0.00	0.00	0	0.00	Y	
0.00	95.50	1	Reinforcement	4.00	4.68	N	1	0.00	0.00	90	0.00	Y	
0.00	95.50	1	Reinforcement	4.00	4.68	N	1	0.00	0.00	180	0.00	Y	
0.00	95.50	1	Reinforcement	4.00	4.68	N	1	0.00	0.00	270	0.00	Y	
0.00	10.00	1	0.28" (7mm) RG-6	0.28	0.03	N	0	0.00	0.00	0	0.00	N	SPOK HOLDINGS,

### Additional Steel

Elev From (ft)	Elev To (ft)	Qty	Description	Fy (ksi)	Offset (in)	— Intermediate Connections —		Connectors	Continuation?	
						Description	Spacing (in)	Len (in)		
0.00	9.50	4	SOL #20 All Thread	80	2.19	6" Angle Bracket	40.0	3.31	5/8" A36 U-Bolt	No
9.50	91.67	4	SOL #20 All Thread	80	2.19	6" Angle Bracket	30.0	3.31	5/8" A36 U-Bolt	Yes
91.67	115.9	2	SOL #20 All Thread	80	8.25	6" T Bracket	30.0	3.31	5/8" A36 U-Bolt	No
91.67	115.9	1	SOL #20 All Thread	80	8.25	6" T Bracket	30.0	3.31	5/8" A36 U-Bolt	Yes



**Segment Properties** (Max Len : 5. ft)

Seg Top Elev (ft)	Description	Thick (in)	Flat Dia (in)	Area (in <sup>2</sup> )	Ix (in <sup>4</sup> )	W/t Ratio	D/t Ratio	F'y (ksi)	S (in <sup>3</sup> )	Z (in <sup>3</sup> )	Weight (lb)	Additional Reinforcing		
												Area (in <sup>2</sup> )	Ix (in <sup>4</sup> )	Weight (lb)
0.00		0.3750	37.380	44.684	7,810.1	24.03	99.68	78.5	403.6	0.0	0.0	19.64	4,816	0.0
5.00		0.3750	36.596	43.737	7,324.4	23.47	97.59	79.1	386.6	0.0	752.2	19.64	4,648	334.0
9.50	Reinf. Top Reinf	0.3750	35.891	42.886	6,904.9	22.97	95.71	79.7	371.7	0.0	663.2	19.64	4,498	300.6
10.00		0.3750	35.813	42.791	6,859.3	22.91	95.50	79.7	370.0	0.0	72.9	19.64	4,482	33.4
15.00		0.3750	35.029	41.845	6,414.3	22.35	93.41	80.3	353.7	0.0	720.0	19.64	4,319	334.0
20.00		0.3750	34.246	40.899	5,989.0	21.79	91.32	80.9	337.8	0.0	703.9	19.64	4,159	334.0
25.00		0.3750	33.462	39.953	5,582.9	21.23	89.23	81.6	322.3	0.0	687.8	19.64	4,003	334.0
30.00		0.3750	32.679	39.007	5,195.6	20.67	87.14	81.9	307.1	0.0	671.7	19.64	3,849	334.0
31.50	Bot - Section 2	0.3750	32.444	38.723	5,083.0	20.50	86.52	81.9	302.7	0.0	198.3	19.64	3,804	100.2
35.00		0.3750	31.895	38.061	4,826.6	20.11	85.05	81.9	292.3	0.0	846.7	19.64	3,818	233.8
35.67	Top - Section 1	0.3125	32.416	32.304	4,249.6	25.12	103.73	77.3	253.3	0.0	159.4	19.64	3,798	44.5
40.00		0.3125	31.737	31.621	3,985.5	24.53	101.56	78.0	242.6	0.0	471.4	19.64	3,668	289.5
45.00		0.3125	30.953	30.832	3,694.8	23.86	99.05	78.7	230.6	0.0	531.3	19.64	3,521	334.0
50.00		0.3125	30.170	30.044	3,418.5	23.19	96.54	79.4	218.9	0.0	517.9	19.64	3,377	334.0
55.00		0.3125	29.386	29.255	3,156.4	22.52	94.04	80.2	207.5	0.0	504.5	19.64	3,236	334.0
60.00		0.3125	28.603	28.467	2,908.0	21.85	91.53	80.9	196.4	0.0	491.0	19.64	3,098	334.0
65.00		0.3125	27.819	27.678	2,673.0	21.17	89.02	81.6	185.6	0.0	477.6	19.64	2,963	334.0
70.00	Bot - Section 3	0.3125	27.036	26.890	2,451.1	20.50	86.51	81.9	175.1	0.0	464.2	19.64	2,831	334.0
70.00		0.3125	27.035	26.890	2,451.0	20.50	86.51	81.9	175.1	0.0	0.1	19.64	2,915	0.0
73.50	Top - Section 2	0.2500	26.987	21.523	1,963.9	26.25	107.95	76.1	140.6	0.0	575.8	19.64	2,823	233.8
75.00		0.2500	26.752	21.334	1,912.6	25.99	107.01	76.4	138.1	0.0	109.4	19.64	2,784	100.2
80.00		0.2500	25.968	20.703	1,747.9	25.15	103.87	77.3	130.0	0.0	357.6	19.64	2,656	334.0
85.00		0.2500	25.185	20.073	1,593.0	24.31	100.74	78.2	122.2	0.0	346.9	19.64	2,531	334.0
90.00		0.2500	24.401	19.442	1,447.5	23.47	97.61	79.1	114.6	0.0	336.1	19.64	2,409	334.0
91.67	Reinf. Top Reinf	0.2500	24.140	19.232	1,401.0	23.19	96.56	79.4	112.1	0.0	109.7	19.64	2,370	111.3
95.00		0.2500	23.618	18.811	1,311.1	22.63	94.47	80.0	107.2	0.0	215.8	14.73	3,350	167.0
100.0		0.2500	22.834	18.180	1,183.6	21.79	91.34	80.9	100.1	0.0	314.7	14.73	3,228	250.5
105.0		0.2500	22.051	17.550	1,064.6	20.95	88.20	81.9	93.3	0.0	304.0	14.73	3,108	250.5
108.0		0.2500	21.581	17.171	997.2	20.45	86.32	81.9	89.3	0.0	177.2	14.73	3,037	150.3
110.0	Top - Section 3	0.2500	21.267	16.919	953.9	20.11	85.07	81.9	86.7	0.0	116.0	14.73	2,991	100.2
110.0	Bot - Section 4	0.1875	21.267	12.727	721.8	27.71	113.43	74.5	65.6	0.0		14.73	2,991	
110.0		0.1875	21.267	12.727	721.8	27.71	113.43	74.5	65.6	0.0	0.0	14.73	2,991	0.0
115.0		0.1875	20.484	12.254	644.3	26.59	109.25	75.7	60.8	0.0	212.5	14.73	2,876	250.5
115.9	Reinf. Top Reinf.	0.1875	20.337	12.165	630.4	26.38	108.46	75.9	59.9	0.0	38.9	14.73	2,854	47.0
118.0		0.1875	20.014	11.970	600.6	25.92	106.74	76.4	58.0	0.0	84.7			
120.0		0.1875	19.700	11.781	572.5	25.47	105.07	76.9	56.1	0.0	80.8			
123.0		0.1875	19.230	11.497	532.1	24.80	102.56	77.7	53.5	0.0	118.8			
125.0		0.1875	18.917	11.308	506.3	24.35	100.89	78.2	51.7	0.0	77.6			
130.0		0.1875	18.133	10.835	445.4	23.23	96.71	79.4	47.4	0.0	188.4			
135.0		0.1875	17.350	10.362	389.5	22.11	92.53	80.6	43.4	0.0	180.3			
140.0		0.1875	16.566	9.889	338.6	20.99	88.35	81.8	39.5	0.0	172.3			
145.0		0.1875	15.782	9.415	292.3	19.87	84.17	81.9	35.8	0.0	164.2			
150.0		0.1875	14.999	8.942	250.4	18.75	79.99	81.9	32.3	0.0	156.2			
											13,371.8			7,339.3

<b>Load Case: 1.2D + 1.0W</b>	<b>115 mph with No Ice</b>	<b>27 Iterations</b>
Gust Response Factor :1.10		
Dead Load Factor :1.20		
Wind Load Factor :1.00		

Applied Segment Forces Summary

Seg Elev (ft)	Description	Shaft Forces		Discrete Forces			Linear Forces		Sum of Forces				
		Wind FX (lb)	Dead Load (lb)	Wind FX (lb)	Torsion MY (lb-ft)	Moment MZ (lb-ft)	Dead Load (lb)	Wind FX (lb)	Dead Load (lb)	Wind FX (lb)	Dead Load (lb)	Torsion MY (lb-ft)	Moment MZ (lb)
0.00		182.4	0.0					0.0	0.0	182.4	0.0	0.0	0.0
5.00		343.3	902.6					0.0	727.3	343.3	1,629.9	0.0	0.0
9.50	Reinf. Top Reinf	178.6	795.9					0.0	654.6	178.6	1,450.4	0.0	0.0
10.00	Appurtenance(s)	192.4	87.5	486.0	0.0	486.0	151.2	0.0	72.7	678.3	311.4	0.0	0.0
15.00		345.5	864.0					0.0	727.1	345.5	1,591.1	0.0	0.0
20.00		337.8	844.7					0.0	727.1	337.8	1,571.8	0.0	0.0
25.00		330.1	825.4					0.0	727.1	330.1	1,552.5	0.0	0.0
30.00		211.6	806.0					0.0	727.1	211.6	1,533.2	0.0	0.0
31.50	Bot - Section 2	165.2	237.9					0.0	218.0	165.2	456.0	0.0	0.0
35.00		139.1	1,016.0					0.0	509.1	139.1	1,525.1	0.0	0.0
35.67	Top - Section 1	169.0	191.3					0.0	96.9	169.0	288.2	0.0	0.0
40.00		317.5	565.6					0.0	630.3	317.5	1,195.9	0.0	0.0
45.00		342.9	637.5					0.0	727.1	342.9	1,364.7	0.0	0.0
50.00		344.5	621.4					0.0	727.1	344.5	1,348.6	0.0	0.0
55.00		344.8	605.3					0.0	727.1	344.8	1,332.5	0.0	0.0
60.00		344.1	589.2					0.0	727.1	344.1	1,316.4	0.0	0.0
65.00		342.4	573.2					0.0	727.1	342.4	1,300.3	0.0	0.0
70.00	Bot - Section 3	170.7	557.0					0.0	727.0	170.7	1,284.0	0.0	0.0
70.00		120.8	0.1					0.0	0.1	120.8	0.2	0.0	0.0
73.50	Top - Section 2	172.4	691.0					0.0	508.9	172.4	1,199.9	0.0	0.0
75.00		222.2	131.3					0.0	218.2	222.2	349.5	0.0	0.0
80.00		407.5	429.1					0.0	727.1	407.5	1,156.3	0.0	0.0
85.00		482.5	416.3					0.3	729.0	482.8	1,145.2	0.0	0.0
90.00		328.5	403.4					20.6	840.5	349.1	1,243.9	0.0	0.0
91.67	Reinf. Top Reinf	249.5	131.6					7.2	280.2	256.7	411.8	0.0	0.0
95.00		417.6	258.9					14.8	493.6	432.4	752.5	0.0	0.0
100.00		501.4	377.6					23.2	639.3	524.6	1,016.9	0.0	0.0
105.00		399.2	364.7					24.2	628.0	423.4	992.8	0.0	0.0
108.00	Appurtenance(s)	247.0	212.7	1,771.5	0.0	0.0	3,158.5	14.9	376.8	2,033.4	3,748.0	0.0	0.0
110.00	Top - Section 3	98.3	139.2					10.1	245.5	108.4	384.7	0.0	0.0
110.00		242.5	0.0					0.0	0.1	242.5	0.1	0.0	0.0
115.00		287.3	255.0					25.8	614.0	313.1	869.0	0.0	0.0
115.94	Reinf. Top Reinf.	142.9	46.7					4.9	115.1	147.8	161.9	0.0	0.0
118.00	Appurtenance(s)	192.1	101.6	2,095.4	0.0	0.0	3,910.0	10.8	129.3	2,298.4	4,140.9	0.0	0.0
120.00		233.4	97.0					11.1	119.1	244.5	216.1	0.0	0.0
123.00	Appurtenance(s)	202.5	142.6	478.5	0.0	0.0	157.4	2.8	122.0	683.8	422.0	0.0	0.0
125.00		221.3	93.1					0.0	73.0	221.3	166.1	0.0	0.0
130.00		316.5	226.0					0.0	182.4	316.5	408.4	0.0	0.0
135.00		317.3	216.4					0.0	182.4	317.3	398.8	0.0	0.0
140.00	Appurtenance(s)	283.5	206.7	2,952.8	0.0	0.0	4,057.8	0.0	182.4	3,236.2	4,446.9	0.0	0.0
145.00		244.3	197.1					0.0	159.0	244.3	356.1	0.0	0.0
150.00	Appurtenance(s)	119.7	187.4	2,410.2	0.0	2,828.0	3,814.6	0.0	159.0	2,530.0	4,161.0	0.0	0.0
<b>Totals:</b>										<b>21,617.3</b>	<b>49,200.7</b>	<b>0.00</b>	<b>0.00</b>

Site Number: 302488

Code: ANSI/TIA-222-H

© 2007 - 2021 by ATC IP LLC. All rights reserved.

Site Name: Cntn - Canton, CT

Engineering Number: 13692185\_C3\_03

7/8/2021 1:38:57 PM

Customer: DISH WIRELESS L.L.C.

Load Case: 1.2D + 1.0W

115 mph with No Ice

27 Iterations

Gust Response Factor :1.10

Dead Load Factor :1.20

Wind Load Factor :1.00

Calculated Forces

Seg Elev (ft)	Pu FY (-) (kips)	Vu FX (-) (kips)	Tu MY (ft-kips)	Mu MZ (ft-kips)	Mu MX (ft-kips)	Resultant Moment (ft-kips)	phi Pn (kips)	phi Vn (kips)	phi Tn (ft-kips)	phi Mn (ft-kips)	Total Deflect (in)	Rotation (deg)	Ratio
0.00	-49.51	-22.84	0.00	-2,567.96	0.00	2,567.96	3,157.17	784.20	2,737.77	2,376.61	0.00	0.00	0.680
5.00	-47.78	-22.72	0.00	-2,453.76	0.00	2,453.76	3,114.35	767.59	2,623.10	2,294.24	0.15	-0.28	0.666
9.50	-46.27	-22.64	0.00	-2,351.53	0.00	2,351.53	3,074.93	752.65	2,521.99	2,220.65	0.54	-0.54	0.652
9.50	-46.27	-22.64	0.00	-2,351.53	0.00	2,351.53	3,074.93	752.65	2,521.99	2,220.65	0.54	-0.54	0.652
10.00	-45.91	-22.09	0.00	-2,339.72	0.00	2,339.72	3,070.50	750.99	2,510.88	2,212.50	0.60	-0.57	0.651
15.00	-44.21	-21.95	0.00	-2,229.27	0.00	2,229.27	3,025.61	734.38	2,401.12	2,131.45	1.35	-0.86	0.636
20.00	-42.54	-21.80	0.00	-2,119.53	0.00	2,119.53	2,979.67	717.78	2,293.80	2,051.12	2.40	-1.14	0.620
25.00	-40.88	-21.64	0.00	-2,010.55	0.00	2,010.55	2,932.70	701.17	2,188.95	1,971.58	3.75	-1.43	0.604
30.00	-39.29	-21.51	0.00	-1,902.36	0.00	1,902.36	2,875.19	684.57	2,086.54	1,886.63	5.41	-1.72	0.589
31.50	-38.78	-21.44	0.00	-1,870.10	0.00	1,870.10	2,854.28	679.59	2,056.31	1,859.13	5.96	-1.81	0.585
35.00	-37.21	-21.32	0.00	-1,795.06	0.00	1,795.06	2,805.45	667.97	1,986.59	1,795.70	7.37	-2.02	0.568
35.67	-36.88	-21.24	0.00	-1,780.86	0.00	1,780.86	2,248.06	566.94	1,717.06	1,468.69	7.65	-2.06	0.652
40.00	-35.59	-21.05	0.00	-1,688.81	0.00	1,688.81	2,218.58	554.94	1,645.20	1,418.47	9.64	-2.31	0.631
45.00	-34.14	-20.83	0.00	-1,583.57	0.00	1,583.57	2,183.59	541.10	1,564.21	1,360.95	12.22	-2.61	0.607
50.00	-32.70	-20.59	0.00	-1,479.43	0.00	1,479.43	2,147.56	527.27	1,485.26	1,303.92	15.11	-2.91	0.581
55.00	-31.28	-20.34	0.00	-1,376.48	0.00	1,376.48	2,110.50	513.43	1,408.35	1,247.44	18.32	-3.21	0.555
60.00	-29.88	-20.07	0.00	-1,274.79	0.00	1,274.79	2,072.39	499.59	1,333.49	1,191.55	21.84	-3.51	0.528
65.00	-28.51	-19.79	0.00	-1,174.44	0.00	1,174.44	2,033.25	485.76	1,260.68	1,136.31	25.67	-3.80	0.500
70.00	-27.19	-19.60	0.00	-1,075.51	0.00	1,075.51	1,982.07	471.92	1,189.91	1,075.81	29.79	-4.08	0.474
70.00	-27.17	-19.52	0.00	-1,075.50	0.00	1,075.50	1,982.06	471.92	1,189.90	1,075.80	29.79	-4.08	0.466
73.50	-25.94	-19.33	0.00	-1,007.19	0.00	1,007.19	1,473.95	377.74	952.78	802.30	32.85	-4.27	0.527
75.00	-25.54	-19.16	0.00	-978.19	0.00	978.19	1,466.26	374.41	936.10	791.03	34.21	-4.36	0.515
80.00	-24.33	-18.78	0.00	-882.39	0.00	882.39	1,439.98	363.34	881.58	753.66	38.92	-4.64	0.476
85.00	-23.15	-18.31	0.00	-788.49	0.00	788.49	1,412.66	352.27	828.70	716.62	43.92	-4.91	0.436
90.00	-21.89	-17.92	0.00	-696.94	0.00	696.94	1,384.29	341.20	777.45	679.95	49.19	-5.16	0.395
91.67	-21.46	-17.67	0.00	-667.08	0.00	667.08	1,374.61	337.51	760.74	667.81	51.01	-5.25	0.382
91.67	-21.46	-17.67	0.00	-667.08	0.00	667.08	1,374.61	337.51	760.74	667.81	51.01	-5.25	0.301
95.00	-20.70	-17.23	0.00	-608.18	0.00	608.18	1,354.89	330.13	727.84	643.69	54.72	-5.41	0.277
100.00	-19.69	-16.67	0.00	-522.03	0.00	522.03	1,324.45	319.07	679.87	607.91	60.48	-5.58	0.241
105.00	-18.72	-16.19	0.00	-438.70	0.00	438.70	1,292.96	308.00	633.53	572.64	66.40	-5.74	0.206
108.00	-15.17	-13.80	0.00	-390.14	0.00	390.14	1,265.69	301.35	606.51	548.34	70.02	-5.82	0.184
110.00	-14.80	-13.66	0.00	-362.54	0.00	362.54	1,247.09	296.93	588.83	532.25	72.47	-5.87	0.173
110.00	-14.80	-13.66	0.00	-362.54	0.00	362.54	853.22	223.36	444.16	366.32	72.47	-5.87	0.204
110.00	-14.81	-13.44	0.00	-362.53	0.00	362.53	853.22	223.36	444.16	366.32	72.47	-5.87	0.204
115.00	-13.96	-13.06	0.00	-295.33	0.00	295.33	834.98	215.05	411.76	345.04	78.68	-6.00	0.168
115.94	-13.80	-12.90	0.00	-283.09	0.00	283.09	831.44	213.50	405.83	341.07	79.86	-6.02	0.161
115.94	-13.80	-12.90	0.00	-283.09	0.00	283.09	831.44	213.50	405.83	341.07	79.86	-6.02	0.850
118.00	-9.90	-10.20	0.00	-256.49	0.00	256.49	823.53	210.07	392.92	332.36	82.47	-6.07	0.786
120.00	-9.67	-9.98	0.00	-236.08	0.00	236.08	815.69	206.75	380.59	323.94	85.05	-6.30	0.743
123.00	-9.28	-9.30	0.00	-206.13	0.00	206.13	803.62	201.77	362.48	311.38	89.11	-6.63	0.676
125.00	-9.09	-9.12	0.00	-187.53	0.00	187.53	795.36	198.45	350.65	303.06	91.93	-6.84	0.632
130.00	-8.66	-8.82	0.00	-141.95	0.00	141.95	774.00	190.15	321.94	282.46	99.33	-7.30	0.516
135.00	-8.25	-8.50	0.00	-97.87	0.00	97.87	751.59	181.85	294.45	262.19	107.17	-7.69	0.386

Site Number: 302488

Code: ANSI/TIA-222-H

© 2007 - 2021 by ATC IP LLC. All rights reserved.

Site Name: Cntn - Canton, CT

Engineering Number: 13692185\_C3\_03

7/8/2021 1:38:57 PM

Customer: DISH WIRELESS L.L.C.

Load Case: 1.2D + 1.0W

115 mph with No Ice

27 Iterations

Gust Response Factor :1.10

Dead Load Factor :1.20

Wind Load Factor :1.00

140.00	-4.27	-4.70	0.00	-55.39	0.00	55.39	728.15	173.54	268.18	242.29	115.36	-7.97	0.235
145.00	-3.94	-4.42	0.00	-31.88	0.00	31.88	694.01	165.24	243.15	219.76	123.78	-8.15	0.151
150.00	0.00	-3.81	0.00	-9.78	0.00	9.78	659.14	156.94	219.34	198.10	132.34	-8.25	0.050

<b>Load Case:</b> 0.9D + 1.0W	115 mph with No Ice (Reduced DL)	27 Iterations
Gust Response Factor :1.10		
Dead Load Factor :0.90		
Wind Load Factor :1.00		

Applied Segment Forces Summary

Seg Elev (ft)	Description	Shaft Forces		Discrete Forces			Linear Forces		Sum of Forces				
		Wind FX (lb)	Dead Load (lb)	Wind FX (lb)	Torsion MY (lb-ft)	Moment MZ (lb-ft)	Dead Load (lb)	Wind FX (lb)	Dead Load (lb)	Wind FX (lb)	Dead Load (lb)	Torsion MY (lb-ft)	Moment MZ (lb)
0.00		182.4	0.0					0.0	0.0	182.4	0.0	0.0	0.0
5.00		343.3	677.0					0.0	545.5	343.3	1,222.5	0.0	0.0
9.50	Reinf. Top Reinf	178.6	596.9					0.0	490.9	178.6	1,087.8	0.0	0.0
10.00	Appurtenance(s)	192.4	65.6	486.0	0.0	486.0	113.4	0.0	54.5	678.3	233.5	0.0	0.0
15.00		345.5	648.0					0.0	545.4	345.5	1,193.4	0.0	0.0
20.00		337.8	633.5					0.0	545.4	337.8	1,178.9	0.0	0.0
25.00		330.1	619.0					0.0	545.4	330.1	1,164.4	0.0	0.0
30.00		211.6	604.5					0.0	545.4	211.6	1,149.9	0.0	0.0
31.50	Bot - Section 2	165.2	178.5					0.0	163.5	165.2	342.0	0.0	0.0
35.00		139.1	762.0					0.0	381.8	139.1	1,143.8	0.0	0.0
35.67	Top - Section 1	169.0	143.5					0.0	72.6	169.0	216.1	0.0	0.0
40.00		317.5	424.2					0.0	472.7	317.5	896.9	0.0	0.0
45.00		342.9	478.2					0.0	545.4	342.9	1,023.5	0.0	0.0
50.00		344.5	466.1					0.0	545.4	344.5	1,011.4	0.0	0.0
55.00		344.8	454.0					0.0	545.4	344.8	999.4	0.0	0.0
60.00		344.1	441.9					0.0	545.4	344.1	987.3	0.0	0.0
65.00		342.4	429.9					0.0	545.4	342.4	975.2	0.0	0.0
70.00	Bot - Section 3	170.7	417.7					0.0	545.3	170.7	963.0	0.0	0.0
70.00		120.8	0.1					0.0	0.1	120.8	0.2	0.0	0.0
73.50	Top - Section 2	172.4	518.2					0.0	381.7	172.4	899.9	0.0	0.0
75.00		222.2	98.5					0.0	163.7	222.2	262.2	0.0	0.0
80.00		407.5	321.8					0.0	545.4	407.5	867.2	0.0	0.0
85.00		482.5	312.2					0.3	546.7	482.8	858.9	0.0	0.0
90.00		328.5	302.5					20.6	630.4	349.1	932.9	0.0	0.0
91.67	Reinf. Top Reinf	249.5	98.7					7.2	210.1	256.7	308.8	0.0	0.0
95.00		417.6	194.2					14.8	370.2	432.4	564.4	0.0	0.0
100.00		501.4	283.2					23.2	479.4	524.6	762.7	0.0	0.0
105.00		399.2	273.6					24.2	471.0	423.4	744.6	0.0	0.0
108.00	Appurtenance(s)	247.0	159.5	1,771.5	0.0	0.0	2,368.9	14.9	282.6	2,033.4	2,811.0	0.0	0.0
110.00	Top - Section 3	98.3	104.4					10.1	184.1	108.4	288.5	0.0	0.0
110.00		242.5	0.0					0.0	0.1	242.5	0.1	0.0	0.0
115.00		287.3	191.3					25.8	460.5	313.1	651.7	0.0	0.0
115.94	Reinf. Top Reinf.	142.9	35.1					4.9	86.3	147.8	121.4	0.0	0.0
118.00	Appurtenance(s)	192.1	76.2	2,095.4	0.0	0.0	2,932.5	10.8	97.0	2,298.4	3,105.6	0.0	0.0
120.00		233.4	72.7					11.1	89.3	244.5	162.1	0.0	0.0
123.00	Appurtenance(s)	202.5	106.9	478.5	0.0	0.0	118.1	2.8	91.5	683.8	316.5	0.0	0.0
125.00		221.3	69.8					0.0	54.7	221.3	124.6	0.0	0.0
130.00		316.5	169.5					0.0	136.8	316.5	306.3	0.0	0.0
135.00		317.3	162.3					0.0	136.8	317.3	299.1	0.0	0.0
140.00	Appurtenance(s)	283.5	155.0	2,952.8	0.0	0.0	3,043.3	0.0	136.8	3,236.2	3,335.2	0.0	0.0
145.00		244.3	147.8					0.0	119.3	244.3	267.0	0.0	0.0
150.00	Appurtenance(s)	119.7	140.6	2,410.2	0.0	2,828.0	2,860.9	0.0	119.3	2,530.0	3,120.7	0.0	0.0
<b>Totals:</b>										21,617.3	36,900.5	0.00	0.00

Site Number: 302488

Code: ANSI/TIA-222-H

© 2007 - 2021 by ATC IP LLC. All rights reserved.

Site Name: Cntrn - Canton, CT

Engineering Number:13692185\_C3\_03

7/8/2021 1:39:02 PM

Customer: DISH WIRELESS L.L.C.

Load Case: 0.9D + 1.0W

115 mph with No Ice (Reduced DL)

27 Iterations

Gust Response Factor :1.10  
 Dead Load Factor :0.90  
 Wind Load Factor :1.00

Calculated Forces

Seg Elev (ft)	Pu FY (-) (kips)	Vu FX (-) (kips)	Tu MY (ft-kips)	Mu MZ (ft-kips)	Mu MX (ft-kips)	Resultant Moment (ft-kips)	phi Pn (kips)	phi Vn (kips)	phi Tn (ft-kips)	phi Mn (ft-kips)	Total Deflect (in)	Rotation (deg)	Ratio
0.00	-37.12	-22.81	0.00	-2,508.74	0.00	2,508.74	3,157.17	784.20	2,737.77	2,376.61	0.00	0.00	0.662
5.00	-35.80	-22.63	0.00	-2,394.70	0.00	2,394.70	3,114.35	767.59	2,623.10	2,294.24	0.15	-0.28	0.647
9.50	-34.66	-22.52	0.00	-2,292.89	0.00	2,292.89	3,074.93	752.65	2,521.99	2,220.65	0.53	-0.53	0.634
9.50	-34.66	-22.52	0.00	-2,292.89	0.00	2,292.89	3,074.93	752.65	2,521.99	2,220.65	0.53	-0.53	0.634
10.00	-34.37	-21.94	0.00	-2,281.14	0.00	2,281.14	3,070.50	750.99	2,510.88	2,212.50	0.59	-0.56	0.632
15.00	-33.08	-21.74	0.00	-2,171.46	0.00	2,171.46	3,025.61	734.38	2,401.12	2,131.45	1.32	-0.83	0.617
20.00	-31.80	-21.54	0.00	-2,062.77	0.00	2,062.77	2,979.67	717.78	2,293.80	2,051.12	2.34	-1.12	0.602
25.00	-30.54	-21.33	0.00	-1,955.09	0.00	1,955.09	2,932.70	701.17	2,188.95	1,971.58	3.66	-1.40	0.585
30.00	-29.32	-21.18	0.00	-1,848.44	0.00	1,848.44	2,875.19	684.57	2,086.54	1,886.63	5.27	-1.68	0.571
31.50	-28.93	-21.08	0.00	-1,816.68	0.00	1,816.68	2,854.28	679.59	2,056.31	1,859.13	5.82	-1.77	0.567
35.00	-27.75	-20.96	0.00	-1,742.88	0.00	1,742.88	2,805.45	667.97	1,986.59	1,795.70	7.18	-1.96	0.549
35.67	-27.49	-20.85	0.00	-1,728.92	0.00	1,728.92	2,248.06	566.94	1,717.06	1,468.69	7.46	-2.00	0.631
40.00	-26.51	-20.63	0.00	-1,638.55	0.00	1,638.55	2,218.58	554.94	1,645.20	1,418.47	9.39	-2.24	0.610
45.00	-25.40	-20.37	0.00	-1,535.42	0.00	1,535.42	2,183.59	541.10	1,564.21	1,360.95	11.90	-2.54	0.586
50.00	-24.30	-20.10	0.00	-1,433.56	0.00	1,433.56	2,147.56	527.27	1,485.26	1,303.92	14.72	-2.83	0.561
55.00	-23.22	-19.82	0.00	-1,333.04	0.00	1,333.04	2,110.50	513.43	1,408.35	1,247.44	17.84	-3.12	0.536
60.00	-22.16	-19.53	0.00	-1,233.92	0.00	1,233.92	2,072.39	499.59	1,333.49	1,191.55	21.26	-3.41	0.509
65.00	-21.11	-19.23	0.00	-1,136.25	0.00	1,136.25	2,033.25	485.76	1,260.68	1,136.31	24.98	-3.69	0.482
70.00	-20.12	-19.05	0.00	-1,040.09	0.00	1,040.09	1,982.07	471.92	1,189.91	1,075.81	28.99	-3.96	0.456
70.00	-20.10	-18.96	0.00	-1,040.08	0.00	1,040.08	1,982.06	471.92	1,189.90	1,075.80	28.99	-3.96	0.449
73.50	-19.17	-18.77	0.00	-973.73	0.00	973.73	1,473.95	377.74	952.78	802.30	31.96	-4.15	0.507
75.00	-18.87	-18.59	0.00	-945.57	0.00	945.57	1,466.26	374.41	936.10	791.03	33.28	-4.23	0.496
80.00	-17.95	-18.20	0.00	-852.63	0.00	852.63	1,439.98	363.34	881.58	753.66	37.85	-4.50	0.458
85.00	-17.05	-17.72	0.00	-761.64	0.00	761.64	1,412.66	352.27	828.70	716.62	42.70	-4.76	0.419
90.00	-16.10	-17.34	0.00	-673.02	0.00	673.02	1,384.29	341.20	777.45	679.95	47.82	-5.01	0.380
91.67	-15.78	-17.09	0.00	-644.12	0.00	644.12	1,374.61	337.51	760.74	667.81	49.58	-5.09	0.367
91.67	-15.78	-17.09	0.00	-644.12	0.00	644.12	1,374.61	337.51	760.74	667.81	49.58	-5.09	0.289
95.00	-15.21	-16.65	0.00	-587.15	0.00	587.15	1,354.89	330.13	727.84	643.69	53.19	-5.25	0.265
100.00	-14.46	-16.10	0.00	-503.88	0.00	503.88	1,324.45	319.07	679.87	607.91	58.76	-5.41	0.231
105.00	-13.73	-15.63	0.00	-423.38	0.00	423.38	1,292.96	308.00	633.53	572.64	64.51	-5.56	0.197
108.00	-11.11	-13.35	0.00	-376.48	0.00	376.48	1,265.69	301.35	606.51	548.34	68.02	-5.64	0.176
110.00	-10.83	-13.22	0.00	-349.79	0.00	349.79	1,247.09	296.93	588.83	532.25	70.40	-5.69	0.166
110.00	-10.83	-13.22	0.00	-349.79	0.00	349.79	853.22	223.36	444.16	366.32	70.40	-5.69	0.195
110.00	-10.84	-12.99	0.00	-349.78	0.00	349.78	853.22	223.36	444.16	366.32	70.40	-5.69	0.195
115.00	-10.21	-12.62	0.00	-284.84	0.00	284.84	834.98	215.05	411.76	345.04	76.42	-5.82	0.160
115.94	-10.09	-12.47	0.00	-273.01	0.00	273.01	831.44	213.50	405.83	341.07	77.56	-5.84	0.154
115.94	-10.09	-12.47	0.00	-273.01	0.00	273.01	831.44	213.50	405.83	341.07	77.56	-5.84	0.816
118.00	-7.22	-9.88	0.00	-247.29	0.00	247.29	823.53	210.07	392.92	332.36	80.09	-5.88	0.755
120.00	-7.03	-9.66	0.00	-227.52	0.00	227.52	815.69	206.75	380.59	323.94	82.60	-6.11	0.713
123.00	-6.75	-8.97	0.00	-198.55	0.00	198.55	803.62	201.77	362.48	311.38	86.53	-6.42	0.648
125.00	-6.60	-8.78	0.00	-180.60	0.00	180.60	795.36	198.45	350.65	303.06	89.26	-6.63	0.606
130.00	-6.28	-8.47	0.00	-136.71	0.00	136.71	774.00	190.15	321.94	282.46	96.43	-7.07	0.494
135.00	-5.98	-8.15	0.00	-94.35	0.00	94.35	751.59	181.85	294.45	262.19	104.02	-7.44	0.370

Site Number: 302488

Code: ANSI/TIA-222-H

© 2007 - 2021 by ATC IP LLC. All rights reserved.

Site Name: Cntn - Canton, CT

Engineering Number: 13692185\_C3\_03

7/8/2021 1:39:02 PM

Customer: DISH WIRELESS L.L.C.

Load Case: 0.9D + 1.0W

115 mph with No Ice (Reduced DL)

27 Iterations

Gust Response Factor :1.10

Dead Load Factor :0.90

Wind Load Factor :1.00

140.00	-3.08	-4.52	0.00	-53.59	0.00	53.59	728.15	173.54	268.18	242.29	111.95	-7.71	0.226
145.00	-2.84	-4.25	0.00	-31.00	0.00	31.00	694.01	165.24	243.15	219.76	120.10	-7.89	0.146
150.00	0.00	-3.81	0.00	-9.78	0.00	9.78	659.14	156.94	219.34	198.10	128.40	-7.99	0.050

<b>Load Case:</b> 1.2D + 1.0Di + 1.0Wi	50 mph with 1.50 in Radial Ice	26 Iterations
Gust Response Factor :1.10	Ice Dead Load Factor :1.00	
Dead Load Factor :1.20		Ice Importance Factor :1.00
Wind Load Factor :1.00		

**Applied Segment Forces Summary**

Seg Elev (ft)	Description	Shaft Forces		Discrete Forces			Linear Forces		Sum of Forces				
		Wind FX (lb)	Dead Load (lb)	Wind FX (lb)	Torsion MY (lb-ft)	Moment MZ (lb-ft)	Dead Load (lb)	Wind FX (lb)	Dead Load (lb)	Wind FX (lb)	Dead Load (lb)	Torsion MY (lb-ft)	Moment MZ (lb)
0.00		46.2	0.0					0.0	0.0	46.2	0.0	0.0	0.0
5.00		87.2	1,185.9					0.0	844.5	87.2	2,030.5	0.0	0.0
9.50	Reinf. Top Reinf	45.6	1,075.1					0.0	772.4	45.6	1,847.5	0.0	0.0
10.00	Appurtenance(s)	49.3	119.4	102.3	0.0	102.3	278.5	0.0	86.2	151.6	484.1	0.0	0.0
15.00		88.8	1,184.7					0.0	865.8	88.8	2,050.5	0.0	0.0
20.00		87.1	1,169.6					0.0	870.8	87.1	2,040.4	0.0	0.0
25.00		85.4	1,151.5					0.0	874.8	85.4	2,026.3	0.0	0.0
30.00		54.9	1,131.6					0.0	878.0	54.9	2,009.6	0.0	0.0
31.50	Bot - Section 2	42.9	336.0					0.0	263.8	42.9	599.9	0.0	0.0
35.00		36.2	1,247.4					0.0	616.9	36.2	1,864.3	0.0	0.0
35.67	Top - Section 1	44.0	235.5					0.0	117.5	44.0	353.0	0.0	0.0
40.00		82.9	849.3					0.0	765.7	82.9	1,615.0	0.0	0.0
45.00		89.8	961.0					0.0	885.3	89.8	1,846.3	0.0	0.0
50.00		90.5	940.8					0.0	887.3	90.5	1,828.1	0.0	0.0
55.00		90.9	920.1					0.0	889.0	90.9	1,809.1	0.0	0.0
60.00		91.0	899.0					0.0	890.7	91.0	1,789.6	0.0	0.0
65.00		90.9	877.5					0.0	892.2	90.9	1,769.6	0.0	0.0
70.00	Bot - Section 3	45.4	855.6					0.0	893.4	45.4	1,749.0	0.0	0.0
70.00		32.2	0.2					0.0	0.1	32.2	0.3	0.0	0.0
73.50	Top - Section 2	45.9	901.0					9.7	626.2	55.6	1,527.1	0.0	0.0
75.00		59.4	220.9					3.7	268.7	63.1	489.7	0.0	0.0
80.00		90.9	720.8					20.8	896.1	111.7	1,617.0	0.0	0.0
85.00		90.0	701.5					31.1	902.6	121.1	1,604.2	0.0	0.0
90.00		59.6	682.1					141.7	1,233.4	201.3	1,915.5	0.0	0.0
91.67	Reinf. Top Reinf	44.3	223.9					49.2	411.7	93.4	635.6	0.0	0.0
95.00		73.1	440.3					101.1	757.5	174.2	1,197.9	0.0	0.0
100.00		86.7	642.5					116.1	948.4	202.8	1,590.9	0.0	0.0
105.00		68.5	622.5					114.2	929.1	182.7	1,551.7	0.0	0.0
108.00	Appurtenance(s)	42.3	364.9	526.7	0.0	0.0	4,995.4	70.1	558.3	639.1	5,918.7	0.0	0.0
110.00	Top - Section 3	16.8	239.5					47.3	361.8	64.1	601.3	0.0	0.0
110.00		41.5	0.1					0.0	0.1	41.5	0.2	0.0	0.0
115.00		49.2	498.2					120.4	905.9	169.7	1,404.0	0.0	0.0
115.94	Reinf. Top Reinf.	24.5	92.2					22.9	170.0	47.4	262.2	0.0	0.0
118.00	Appurtenance(s)	33.0	200.2	618.8	0.0	0.0	6,541.7	50.8	250.2	702.6	6,992.1	0.0	0.0
120.00		40.2	191.4					52.4	236.7	92.6	428.0	0.0	0.0
123.00	Appurtenance(s)	39.8	281.3	116.8	0.0	0.0	392.0	14.6	183.2	171.3	856.5	0.0	0.0
125.00		54.7	184.4					1.3	98.4	56.0	282.9	0.0	0.0
130.00		76.9	446.3					3.7	246.2	80.6	692.5	0.0	0.0
135.00		74.9	428.8					4.5	246.4	79.4	675.3	0.0	0.0
140.00	Appurtenance(s)	72.9	411.2	820.3	0.0	0.0	7,001.3	5.3	246.7	898.5	7,659.2	0.0	0.0
145.00		70.8	393.6					0.0	159.0	70.8	552.6	0.0	0.0
150.00	Appurtenance(s)	34.8	375.8	749.1	0.0	743.6	6,325.5	0.0	159.0	784.0	6,860.3	0.0	0.0
								Totals:		6,486.93	73,028.4	0.00	0.00





Site Number: 302488

Code: ANSI/TIA-222-H

© 2007 - 2021 by ATC IP LLC. All rights reserved.

Site Name: Cntn - Canton, CT

Engineering Number: 13692185\_C3\_03

7/8/2021 1:39:07 PM

Customer: DISH WIRELESS L.L.C.

Load Case: 1.2D + 1.0Di + 1.0Wi

50 mph with 1.50 in Radial Ice

26 Iterations

Gust Response Factor :1.10

Ice Dead Load Factor :1.00

Dead Load Factor :1.20

Ice Importance Factor :1.00

Wind Load Factor :1.00

140.00	-8.78	-1.77	0.00	-21.01	0.00	21.01	728.15	173.54	268.18	242.29	39.84	-2.78	0.099
145.00	-8.23	-1.68	0.00	-12.15	0.00	12.15	694.01	165.24	243.15	219.76	42.79	-2.85	0.067
150.00	0.00	-1.27	0.00	-3.74	0.00	3.74	659.14	156.94	219.34	198.10	45.80	-2.89	0.019

<b>Load Case: 1.0D + 1.0W</b>	<b>Serviceability 60 mph</b>	<b>25 Iterations</b>
Gust Response Factor :1.10		
Dead Load Factor :1.00		
Wind Load Factor :1.00		

Applied Segment Forces Summary

Seg Elev (ft)	Description	Shaft Forces		Discrete Forces			Linear Forces		Sum of Forces				
		Wind FX (lb)	Dead Load (lb)	Wind FX (lb)	Torsion MY (lb-ft)	Moment MZ (lb-ft)	Dead Load (lb)	Wind FX (lb)	Dead Load (lb)	Wind FX (lb)	Dead Load (lb)	Torsion MY (lb-ft)	Moment MZ (lb)
0.00		44.4	0.0					0.0	0.0	44.4	0.0	0.0	0.0
5.00		83.6	752.2					0.0	606.1	83.6	1,358.3	0.0	0.0
9.50	Reinf. Top Reinf	43.5	663.2					0.0	545.5	43.5	1,208.7	0.0	0.0
10.00	Appurtenance(s)	46.9	72.9	118.4	0.0	118.4	126.0	0.0	60.6	165.2	259.5	0.0	0.0
15.00		84.2	720.0					0.0	605.9	84.2	1,325.9	0.0	0.0
20.00		82.3	703.9					0.0	605.9	82.3	1,309.8	0.0	0.0
25.00		80.4	687.8					0.0	605.9	80.4	1,293.8	0.0	0.0
30.00		51.5	671.7					0.0	605.9	51.5	1,277.7	0.0	0.0
31.50	Bot - Section 2	40.2	198.3					0.0	181.7	40.2	380.0	0.0	0.0
35.00		33.9	846.7					0.0	424.2	33.9	1,270.9	0.0	0.0
35.67	Top - Section 1	41.2	159.4					0.0	80.7	41.2	240.2	0.0	0.0
40.00		77.3	471.4					0.0	525.2	77.3	996.6	0.0	0.0
45.00		83.5	531.3					0.0	605.9	83.5	1,137.2	0.0	0.0
50.00		83.9	517.9					0.0	605.9	83.9	1,123.8	0.0	0.0
55.00		84.0	504.5					0.0	605.9	84.0	1,110.4	0.0	0.0
60.00		83.8	491.0					0.0	605.9	83.8	1,097.0	0.0	0.0
65.00		83.4	477.6					0.0	605.9	83.4	1,083.6	0.0	0.0
70.00	Bot - Section 3	41.6	464.2					0.0	605.9	41.6	1,070.0	0.0	0.0
70.00		29.4	0.1					0.0	0.1	29.4	0.2	0.0	0.0
73.50	Top - Section 2	42.0	575.8					0.0	424.1	42.0	999.9	0.0	0.0
75.00		54.1	109.4					0.0	181.9	54.1	291.3	0.0	0.0
80.00		99.3	357.6					0.0	605.9	99.3	963.6	0.0	0.0
85.00		117.5	346.9					0.1	607.5	117.6	954.3	0.0	0.0
90.00		80.0	336.1					5.0	700.4	85.0	1,036.6	0.0	0.0
91.67	Reinf. Top Reinf	60.8	109.7					1.8	233.5	62.5	343.1	0.0	0.0
95.00		101.7	215.8					3.6	411.3	105.3	627.1	0.0	0.0
100.00		122.1	314.7					5.7	532.7	127.8	847.4	0.0	0.0
105.00		97.2	304.0					5.9	523.3	103.1	827.3	0.0	0.0
108.00	Appurtenance(s)	60.2	177.2	431.5	0.0	0.0	2,632.1	3.6	314.0	495.2	3,123.3	0.0	0.0
110.00	Top - Section 3	23.9	116.0					2.5	204.6	26.4	320.6	0.0	0.0
110.00		59.1	0.0					0.0	0.1	59.1	0.1	0.0	0.0
115.00		70.0	212.5					6.3	511.6	76.2	724.2	0.0	0.0
115.94	Reinf. Top Reinf.	34.8	38.9					1.2	95.9	36.0	134.9	0.0	0.0
118.00	Appurtenance(s)	46.8	84.7	510.4	0.0	0.0	3,258.3	2.6	107.7	559.8	3,450.7	0.0	0.0
120.00		56.9	80.8					2.7	99.3	59.6	180.1	0.0	0.0
123.00	Appurtenance(s)	49.3	118.8	116.6	0.0	0.0	131.2	0.7	101.6	166.5	351.7	0.0	0.0
125.00		53.9	77.6					0.0	60.8	53.9	138.4	0.0	0.0
130.00		77.1	188.4					0.0	152.0	77.1	340.4	0.0	0.0
135.00		77.3	180.3					0.0	152.0	77.3	332.3	0.0	0.0
140.00	Appurtenance(s)	69.0	172.3	719.2	0.0	0.0	3,381.5	0.0	152.0	788.2	3,705.8	0.0	0.0
145.00		59.5	164.2					0.0	132.5	59.5	296.7	0.0	0.0
150.00	Appurtenance(s)	29.2	156.2	587.0	0.0	688.8	3,178.8	0.0	132.5	616.2	3,467.5	0.0	0.0
<b>Totals:</b>										<b>5,265.07</b>	<b>41,000.6</b>	<b>0.00</b>	<b>0.00</b>



Site Number: 302488

Code: ANSI/TIA-222-H

© 2007 - 2021 by ATC IP LLC. All rights reserved.

Site Name: Cntn - Canton, CT

Engineering Number: 13692185\_C3\_03

7/8/2021 1:39:12 PM

Customer: DISH WIRELESS L.L.C.

Load Case: 1.0D + 1.0W

Serviceability 60 mph

25 Iterations

Gust Response Factor :1.10

Dead Load Factor :1.00

Wind Load Factor :1.00

140.00	-4.04	-1.12	0.00	-13.29	0.00	13.29	728.15	173.54	268.18	242.29	27.68	-1.91	0.060
145.00	-3.74	-1.06	0.00	-7.67	0.00	7.67	694.01	165.24	243.15	219.76	29.70	-1.95	0.040
150.00	0.00	-0.93	0.00	-2.38	0.00	2.38	659.14	156.94	219.34	198.10	31.76	-1.98	0.012

Equivalent Lateral Forces Method Analysis

Spectral Response Acceleration for Short Period ( $S_s$ ):	0.17
Spectral Response Acceleration at 1.0 Second Period ( $S_{d1}$ ):	0.05
Long-Period Transition Period ( $T_L$ ):	6
Importance Factor ( $I_E$ ):	1.00
Site Coefficient $F_a$ :	1.60
Site Coefficient $F_v$ :	2.40
Response Modification Coefficient (R):	1.50
Design Spectral Response Acceleration at Short Period ( $S_{ds}$ ):	0.19
Design Spectral Response Acceleration at 1.0 Second Period ( $S_{d1}$ ):	0.09
Seismic Response Coefficient ( $C_s$ ):	0.03
Upper Limit $C_s$	0.03
Lower Limit $C_s$	0.03
Period based on Rayleigh Method (sec):	3.23
Redundancy Factor ( $\rho$ ):	1.30
Seismic Force Distribution Exponent (k):	2.00
Total Unfactored Dead Load:	41.31 k
Seismic Base Shear (E):	1.61 k

Load Case 1.2D + 1.0Ev + 1.0Eh

Seismic

Segment	Height Above Base (ft)	Weight (lb)	$W_z$ (lb-ft)	$C_{vx}$	Horizontal Force (lb)	Vertical Force (lb)
41	147.50	289	6,280	0.017	28	357
40	142.50	297	6,025	0.017	27	367
39	137.50	324	6,131	0.017	27	401
38	132.50	332	5,834	0.016	26	411
37	127.50	340	5,533	0.015	25	421
36	124.00	138	2,128	0.006	9	171
35	121.50	220	3,254	0.009	14	273
34	119.00	180	2,550	0.007	11	223
33	116.97	192	2,633	0.007	12	238
32	115.47	135	1,798	0.005	8	167
31	112.50	724	9,165	0.025	41	896
30	110.00	0	1	0.000	0	0
29	109.00	321	3,808	0.011	17	397
28	106.50	491	5,572	0.015	25	608
27	102.50	827	8,692	0.024	39	1,024
26	97.50	847	8,056	0.022	36	1,049
25	93.33	627	5,462	0.015	24	776
24	90.83	343	2,831	0.008	13	425
23	87.50	1,037	7,936	0.022	35	1,283
22	82.50	954	6,495	0.018	29	1,181
21	77.50	964	5,787	0.016	26	1,192
20	74.25	291	1,606	0.004	7	360
19	71.75	1,000	5,148	0.014	23	1,237
18	70.00	0	1	0.000	0	0
17	67.50	1,070	4,875	0.013	22	1,324

16	62.50	1,084	4,233	0.012	19	1,341
15	57.50	1,097	3,627	0.010	16	1,357
14	52.50	1,110	3,061	0.008	14	1,374
13	47.50	1,124	2,536	0.007	11	1,391
12	42.50	1,137	2,054	0.006	9	1,407
11	37.83	997	1,426	0.004	6	1,233
10	35.33	240	300	0.001	1	297
9	33.25	1,271	1,405	0.004	6	1,573
8	30.75	380	359	0.001	2	470
7	27.50	1,278	966	0.003	4	1,581
6	22.50	1,294	655	0.002	3	1,601
5	17.50	1,310	401	0.001	2	1,621
4	12.50	1,326	207	0.001	1	1,641
3	9.75	133	13	0.000	0	165
2	7.25	1,209	64	0.000	0	1,496
1	2.50	1,358	8	0.000	0	1,681
Generic 12' Omni	150.00	40	900	0.002	4	49
Generic 12' Dipole	150.00	40	900	0.002	4	49
Generic 6' Yagi	150.00	25	563	0.002	3	31
CCI HPA-65R-BUU-H8	150.00	204	4,590	0.013	20	252
Andrew ABT-D MDF-ADBH	150.00	3	74	0.000	0	4
Powerwave Allgon 702	150.00	13	297	0.001	1	16
Powerwave Allgon TT1	150.00	96	2,160	0.006	10	119
Raycap DC6-48-60-18-	150.00	33	738	0.002	3	41
Ericsson RRUS 11 (Ba	150.00	150	3,375	0.009	15	186
Ericsson RRUS 32 B2	150.00	159	3,577	0.010	16	197
Generic Round Stand-	150.00	563	12,656	0.035	56	696
Powerwave Allgon 777	150.00	162	3,645	0.010	16	200
Round Platform w/ Ha	150.00	2,000	45,000	0.124	200	2,475
Ericsson Radio 4460	140.00	327	6,409	0.018	29	405
Ericsson Radio 4480	140.00	252	4,939	0.014	22	312
Ericsson Air6449 B41	140.00	312	6,115	0.017	27	386
RFS APX16DWV-16DWVS-	140.00	122	2,393	0.007	11	151
RFS APXVAALL24 43-U-	140.00	368	7,221	0.020	32	456
Round Platform w/ Ha	140.00	2,000	39,200	0.108	175	2,475
Stand-Off	123.00	100	1,513	0.004	7	124
Generic 75" x 16.8"	123.00	31	472	0.001	2	39
Samsung B2/B66A RRH-	118.00	253	3,526	0.010	16	313
Samsung B5/B13 RRH-B	118.00	211	2,937	0.008	13	261
Raycap RCMD-6627-PF	118.00	32	446	0.001	2	40
Commscope NHH-65B-R2	118.00	262	3,651	0.010	16	324
Generic Round Platfo	118.00	2,500	34,810	0.096	155	3,093
Commscope RDIDC-9181	108.00	22	255	0.001	1	27
Fujitsu TA08025-B604	108.00	192	2,236	0.006	10	237
Fujitsu TA08025-B605	108.00	225	2,624	0.007	12	278
JMA Wireless MX08FRO	108.00	193	2,257	0.006	10	239
Round Platform w/ Ha	108.00	2,000	23,328	0.064	104	2,475
Channel Master Type	10.00	126	13	0.000	0	156
		41,310	361,738	1.000	1,611	51,114

Load Case 0.9D - 1.0Ev + 1.0Eh

Seismic (Reduced DL)

Segment	Height Above Base (ft)	Weight (lb)	W <sub>z</sub> (lb-ft)	C <sub>vx</sub>	Horizontal Force (lb)	Vertical Force (lb)
41	147.50	289	6,280	0.017	28	249
40	142.50	297	6,025	0.017	27	256
39	137.50	324	6,131	0.017	27	280
38	132.50	332	5,834	0.016	26	287
37	127.50	340	5,533	0.015	25	294
36	124.00	138	2,128	0.006	9	119
35	121.50	220	3,254	0.009	14	190

Site Number: 302488

Code: ANSI/TIA-222-H

© 2007 - 2021 by ATC IP LLC. All rights reserved.

Site Name: Cntrn - Canton, CT

Engineering Number: 13692185\_C3\_03

7/8/2021 1:39:12 PM

Customer: DISH WIRELESS L.L.C.

34	119.00	180	2,550	0.007	11	155
33	116.97	192	2,633	0.007	12	166
32	115.47	135	1,798	0.005	8	116
31	112.50	724	9,165	0.025	41	625
30	110.00	0	1	0.000	0	0
29	109.00	321	3,808	0.011	17	277
28	106.50	491	5,572	0.015	25	424
27	102.50	827	8,692	0.024	39	714
26	97.50	847	8,056	0.022	36	731
25	93.33	627	5,462	0.015	24	541
24	90.83	343	2,831	0.008	13	296
23	87.50	1,037	7,936	0.022	35	894
22	82.50	954	6,495	0.018	29	823
21	77.50	964	5,787	0.016	26	831
20	74.25	291	1,606	0.004	7	251
19	71.75	1,000	5,148	0.014	23	863
18	70.00	0	1	0.000	0	0
17	67.50	1,070	4,875	0.013	22	923
16	62.50	1,084	4,233	0.012	19	935
15	57.50	1,097	3,627	0.010	16	946
14	52.50	1,110	3,061	0.008	14	958
13	47.50	1,124	2,536	0.007	11	969
12	42.50	1,137	2,054	0.006	9	981
11	37.83	997	1,426	0.004	6	860
10	35.33	240	300	0.001	1	207
9	33.25	1,271	1,405	0.004	6	1,096
8	30.75	380	359	0.001	2	328
7	27.50	1,278	966	0.003	4	1,102
6	22.50	1,294	655	0.002	3	1,116
5	17.50	1,310	401	0.001	2	1,130
4	12.50	1,326	207	0.001	1	1,144
3	9.75	133	13	0.000	0	115
2	7.25	1,209	64	0.000	0	1,043
1	2.50	1,358	8	0.000	0	1,172
Generic 12' Omni	150.00	40	900	0.002	4	35
Generic 12' Dipole	150.00	40	900	0.002	4	35
Generic 6' Yagi	150.00	25	563	0.002	3	22
CCI HPA-65R-BUU-H8	150.00	204	4,590	0.013	20	176
Andrew ABT-D MDF-ADBH	150.00	3	74	0.000	0	3
Powerwave Allgon 702	150.00	13	297	0.001	1	11
Powerwave Allgon TT1	150.00	96	2,160	0.006	10	83
Raycap DC6-48-60-18-	150.00	33	738	0.002	3	28
Ericsson RRUS 11 (Ba	150.00	150	3,375	0.009	15	129
Ericsson RRUS 32 B2	150.00	159	3,577	0.010	16	137
Generic Round Stand-	150.00	563	12,656	0.035	56	485
Powerwave Allgon 777	150.00	162	3,645	0.010	16	140
Round Platform w/ Ha	150.00	2,000	45,000	0.124	200	1,725
Ericsson Radio 4460	140.00	327	6,409	0.018	29	282
Ericsson Radio 4480	140.00	252	4,939	0.014	22	217
Ericsson Air6449 B41	140.00	312	6,115	0.017	27	269
RFS APX16DWV-16DWVS-	140.00	122	2,393	0.007	11	105
RFS APXVAALL24 43-U-	140.00	368	7,221	0.020	32	318
Round Platform w/ Ha	140.00	2,000	39,200	0.108	175	1,725
Stand-Off	123.00	100	1,513	0.004	7	86
Generic 75" x 16.8"	123.00	31	472	0.001	2	27
Samsung B2/B66A RRH-	118.00	253	3,526	0.010	16	218
Samsung B5/B13 RRH-B	118.00	211	2,937	0.008	13	182
Raycap RCMD C-6627-PF	118.00	32	446	0.001	2	28
Commscope NHH-65B-R2	118.00	262	3,651	0.010	16	226
Generic Round Platfo	118.00	2,500	34,810	0.096	155	2,157
Commscope RDIDC-9181	108.00	22	255	0.001	1	19
Fujitsu TA08025-B604	108.00	192	2,236	0.006	10	165
Fujitsu TA08025-B605	108.00	225	2,624	0.007	12	194
JMA Wireless MX08FRO	108.00	193	2,257	0.006	10	167



---

---

Site Number: 302488

Code: ANSI/TIA-222-H

© 2007 - 2021 by ATC IP LLC. All rights reserved.

Site Name: Cntrn - Canton, CT

Engineering Number: 13692185\_C3\_03

7/8/2021 1:39:12 PM

Customer: DISH WIRELESS L.L.C.

---

---

Round Platform w/ Ha	108.00	2,000	23,328	0.064	104	1,725
Channel Master Type	10.00	126	13	0.000	0	109
		41,310	361,738	1.000	1,611	35,636

Load Case 1.2D + 1.0Ev + 1.0Eh

Seismic

Calculated Forces

Seg Elev (ft)	Pu FY (-) (kips)	Vu FX (-) (kips)	Tu MY (ft-kips)	Mu MZ (ft-kips)	Mu MX (ft-kips)	Resultant Moment (ft-kips)	phi Pn (kips)	phi Vn (kips)	phi Tn (ft-kips)	phi Mn (ft-kips)	Total Deflect (in)	Rotation (deg)	Ratio
0.00	-49.43	-1.62	0.00	-210.92	0.00	210.92	3,157.17	784.20	2,737.77	2,376.61	0.00	0.00	0.066
5.00	-47.94	-1.64	0.00	-202.82	0.00	202.82	3,114.35	767.59	2,623.10	2,294.24	0.01	-0.02	0.065
9.50	-47.77	-1.65	0.00	-195.45	0.00	195.45	3,074.93	752.65	2,521.99	2,220.65	0.04	-0.04	0.064
9.50	-47.77	-1.65	0.00	-195.45	0.00	195.45	3,074.93	752.65	2,521.99	2,220.65	0.04	-0.04	0.064
10.00	-45.97	-1.66	0.00	-194.62	0.00	194.62	3,070.50	750.99	2,510.88	2,212.50	0.05	-0.05	0.063
15.00	-44.35	-1.67	0.00	-186.35	0.00	186.35	3,025.61	734.38	2,401.12	2,131.45	0.11	-0.07	0.062
20.00	-42.75	-1.68	0.00	-177.99	0.00	177.99	2,979.67	717.78	2,293.80	2,051.12	0.20	-0.10	0.061
25.00	-41.17	-1.69	0.00	-169.57	0.00	169.57	2,932.70	701.17	2,188.95	1,971.58	0.31	-0.12	0.060
30.00	-40.70	-1.70	0.00	-161.10	0.00	161.10	2,875.19	684.57	2,086.54	1,886.63	0.45	-0.14	0.058
31.50	-39.13	-1.70	0.00	-158.55	0.00	158.55	2,854.28	679.59	2,056.31	1,859.13	0.50	-0.15	0.058
35.00	-38.83	-1.71	0.00	-152.59	0.00	152.59	2,805.45	667.97	1,986.59	1,795.70	0.61	-0.17	0.057
35.67	-37.60	-1.70	0.00	-151.46	0.00	151.46	2,248.06	566.94	1,717.06	1,468.69	0.64	-0.17	0.065
40.00	-36.19	-1.71	0.00	-144.07	0.00	144.07	2,218.58	554.94	1,645.20	1,418.47	0.80	-0.19	0.063
45.00	-34.80	-1.70	0.00	-135.55	0.00	135.55	2,183.59	541.10	1,564.21	1,360.95	1.02	-0.22	0.061
50.00	-33.42	-1.70	0.00	-127.02	0.00	127.02	2,147.56	527.27	1,485.26	1,303.92	1.26	-0.25	0.058
55.00	-32.06	-1.69	0.00	-118.52	0.00	118.52	2,110.50	513.43	1,408.35	1,247.44	1.53	-0.27	0.056
60.00	-30.72	-1.68	0.00	-110.06	0.00	110.06	2,072.39	499.59	1,333.49	1,191.55	1.83	-0.30	0.054
65.00	-29.40	-1.66	0.00	-101.65	0.00	101.65	2,033.25	485.76	1,260.68	1,136.31	2.16	-0.32	0.051
70.00	-29.40	-1.67	0.00	-93.33	0.00	93.33	1,982.07	471.92	1,189.91	1,075.81	2.51	-0.35	0.049
70.00	-28.16	-1.64	0.00	-93.33	0.00	93.33	1,982.06	471.92	1,189.90	1,075.80	2.51	-0.35	0.048
73.50	-27.80	-1.64	0.00	-87.58	0.00	87.58	1,473.95	377.74	952.78	802.30	2.77	-0.36	0.055
75.00	-26.61	-1.62	0.00	-85.11	0.00	85.11	1,466.26	374.41	936.10	791.03	2.88	-0.37	0.053
80.00	-25.43	-1.59	0.00	-77.04	0.00	77.04	1,439.98	363.34	881.58	753.66	3.28	-0.39	0.050
85.00	-24.14	-1.55	0.00	-69.09	0.00	69.09	1,412.66	352.27	828.70	716.62	3.71	-0.42	0.046
90.00	-23.72	-1.54	0.00	-61.32	0.00	61.32	1,384.29	341.20	777.45	679.95	4.16	-0.44	0.042
91.67	-22.94	-1.52	0.00	-58.75	0.00	58.75	1,374.61	337.51	760.74	667.81	4.31	-0.45	0.041
91.67	-22.94	-1.52	0.00	-58.75	0.00	58.75	1,374.61	337.51	760.74	667.81	4.31	-0.45	0.035
95.00	-21.89	-1.48	0.00	-53.68	0.00	53.68	1,354.89	330.13	727.84	643.69	4.63	-0.46	0.033
100.00	-20.87	-1.44	0.00	-46.28	0.00	46.28	1,324.45	319.07	679.87	607.91	5.13	-0.48	0.029
105.00	-20.26	-1.41	0.00	-39.09	0.00	39.09	1,292.96	308.00	633.53	572.64	5.63	-0.49	0.026
108.00	-16.61	-1.23	0.00	-34.85	0.00	34.85	1,265.69	301.35	606.51	548.34	5.94	-0.50	0.023
110.00	-16.61	-1.23	0.00	-32.40	0.00	32.40	1,247.09	296.93	588.83	532.25	6.15	-0.50	0.022
110.00	-16.61	-1.23	0.00	-32.40	0.00	32.40	853.22	223.36	444.16	366.32	6.15	-0.50	0.026
110.00	-15.71	-1.18	0.00	-32.40	0.00	32.40	853.22	223.36	444.16	366.32	6.15	-0.50	0.026
115.00	-15.55	-1.17	0.00	-26.48	0.00	26.48	834.98	215.05	411.76	345.04	6.69	-0.51	0.023
115.94	-15.31	-1.16	0.00	-25.38	0.00	25.38	831.44	213.50	405.83	341.07	6.79	-0.52	0.022
115.94	-15.31	-1.16	0.00	-25.38	0.00	25.38	831.44	213.50	405.83	341.07	6.79	-0.52	0.093
118.00	-11.06	-0.91	0.00	-22.99	0.00	22.99	823.53	210.07	392.92	332.36	7.01	-0.52	0.083
120.00	-10.78	-0.90	0.00	-21.16	0.00	21.16	815.69	206.75	380.59	323.94	7.24	-0.54	0.079
123.00	-10.45	-0.88	0.00	-18.46	0.00	18.46	803.62	201.77	362.48	311.38	7.59	-0.57	0.072
125.00	-10.03	-0.86	0.00	-16.70	0.00	16.70	795.36	198.45	350.65	303.06	7.83	-0.59	0.068
130.00	-9.62	-0.84	0.00	-12.40	0.00	12.40	774.00	190.15	321.94	282.46	8.47	-0.63	0.056
135.00	-9.22	-0.81	0.00	-8.22	0.00	8.22	751.59	181.85	294.45	262.19	9.15	-0.66	0.044
140.00	-4.67	-0.43	0.00	-4.18	0.00	4.18	728.15	173.54	268.18	242.29	9.86	-0.69	0.024
145.00	-4.31	-0.40	0.00	-2.01	0.00	2.01	694.01	165.24	243.15	219.76	10.59	-0.70	0.015
150.00	0.00	-0.35	0.00	0.00	0.00	0.00	659.14	156.94	219.34	198.10	11.32	-0.70	0.000

---

---

Site Number: 302488

Code: ANSI/TIA-222-H

© 2007 - 2021 by ATC IP LLC. All rights reserved.

Site Name: Cntrn - Canton, CT

Engineering Number: 13692185\_C3\_03

7/8/2021 1:39:12 PM

Customer: DISH WIRELESS L.L.C.

---

---

Load Case 0.9D - 1.0Ev + 1.0Eh

Seismic (Reduced DL)

Calculated Forces

Seg Elev (ft)	Pu FY (-) (kips)	Vu FX (-) (kips)	Tu MY (ft-kips)	Mu MZ (ft-kips)	Mu MX (ft-kips)	Resultant Moment (ft-kips)	phi Pn (kips)	phi Vn (kips)	phi Tn (ft-kips)	phi Mn (ft-kips)	Total Deflect (in)	Rotation (deg)	Ratio
0.00	-34.46	-1.62	0.00	-204.90	0.00	204.90	3,157.17	784.20	2,737.77	2,376.61	0.00	0.00	0.061
5.00	-33.42	-1.63	0.00	-196.82	0.00	196.82	3,114.35	767.59	2,623.10	2,294.24	0.01	-0.02	0.060
9.50	-33.31	-1.64	0.00	-189.49	0.00	189.49	3,074.93	752.65	2,521.99	2,220.65	0.04	-0.04	0.059
9.50	-33.31	-1.64	0.00	-189.49	0.00	189.49	3,074.93	752.65	2,521.99	2,220.65	0.04	-0.04	0.059
10.00	-32.05	-1.64	0.00	-188.67	0.00	188.67	3,070.50	750.99	2,510.88	2,212.50	0.05	-0.05	0.059
15.00	-30.92	-1.65	0.00	-180.47	0.00	180.47	3,025.61	734.38	2,401.12	2,131.45	0.11	-0.07	0.058
20.00	-29.81	-1.66	0.00	-172.21	0.00	172.21	2,979.67	717.78	2,293.80	2,051.12	0.19	-0.09	0.056
25.00	-28.70	-1.66	0.00	-163.92	0.00	163.92	2,932.70	701.17	2,188.95	1,971.58	0.30	-0.12	0.055
30.00	-28.37	-1.67	0.00	-155.61	0.00	155.61	2,875.19	684.57	2,086.54	1,886.63	0.44	-0.14	0.054
31.50	-27.28	-1.67	0.00	-153.10	0.00	153.10	2,854.28	679.59	2,056.31	1,859.13	0.48	-0.15	0.053
35.00	-27.07	-1.67	0.00	-147.27	0.00	147.27	2,805.45	667.97	1,986.59	1,795.70	0.59	-0.16	0.052
35.67	-26.21	-1.67	0.00	-146.16	0.00	146.16	2,248.06	566.94	1,717.06	1,468.69	0.62	-0.17	0.060
40.00	-25.23	-1.66	0.00	-138.95	0.00	138.95	2,218.58	554.94	1,645.20	1,418.47	0.78	-0.19	0.058
45.00	-24.26	-1.66	0.00	-130.63	0.00	130.63	2,183.59	541.10	1,564.21	1,360.95	0.99	-0.21	0.056
50.00	-23.30	-1.65	0.00	-122.34	0.00	122.34	2,147.56	527.27	1,485.26	1,303.92	1.22	-0.24	0.054
55.00	-22.35	-1.64	0.00	-114.08	0.00	114.08	2,110.50	513.43	1,408.35	1,247.44	1.49	-0.26	0.051
60.00	-21.42	-1.63	0.00	-105.87	0.00	105.87	2,072.39	499.59	1,333.49	1,191.55	1.77	-0.29	0.049
65.00	-20.49	-1.61	0.00	-97.74	0.00	97.74	2,033.25	485.76	1,260.68	1,136.31	2.09	-0.31	0.047
70.00	-20.49	-1.61	0.00	-89.70	0.00	89.70	1,982.07	471.92	1,189.91	1,075.81	2.42	-0.33	0.045
70.00	-19.63	-1.59	0.00	-89.70	0.00	89.70	1,982.06	471.92	1,189.90	1,075.80	2.42	-0.33	0.044
73.50	-19.38	-1.58	0.00	-84.14	0.00	84.14	1,473.95	377.74	952.78	802.30	2.68	-0.35	0.050
75.00	-18.55	-1.56	0.00	-81.76	0.00	81.76	1,466.26	374.41	936.10	791.03	2.79	-0.36	0.049
80.00	-17.72	-1.53	0.00	-73.98	0.00	73.98	1,439.98	363.34	881.58	753.66	3.17	-0.38	0.045
85.00	-16.83	-1.50	0.00	-66.33	0.00	66.33	1,412.66	352.27	828.70	716.62	3.58	-0.40	0.042
90.00	-16.53	-1.48	0.00	-58.85	0.00	58.85	1,384.29	341.20	777.45	679.95	4.02	-0.43	0.038
91.67	-15.99	-1.46	0.00	-56.38	0.00	56.38	1,374.61	337.51	760.74	667.81	4.17	-0.43	0.037
91.67	-15.99	-1.46	0.00	-56.38	0.00	56.38	1,374.61	337.51	760.74	667.81	4.17	-0.43	0.031
95.00	-15.26	-1.42	0.00	-51.51	0.00	51.51	1,354.89	330.13	727.84	643.69	4.48	-0.45	0.029
100.00	-14.55	-1.38	0.00	-44.41	0.00	44.41	1,324.45	319.07	679.87	607.91	4.95	-0.46	0.026
105.00	-14.12	-1.35	0.00	-37.50	0.00	37.50	1,292.96	308.00	633.53	572.64	5.44	-0.47	0.023
108.00	-11.58	-1.18	0.00	-33.44	0.00	33.44	1,265.69	301.35	606.51	548.34	5.74	-0.48	0.020
110.00	-11.58	-1.18	0.00	-31.08	0.00	31.08	1,247.09	296.93	588.83	532.25	5.94	-0.49	0.019
110.00	-11.58	-1.18	0.00	-31.08	0.00	31.08	853.22	223.36	444.16	366.32	5.94	-0.49	0.023
110.00	-10.95	-1.14	0.00	-31.08	0.00	31.08	853.22	223.36	444.16	366.32	5.94	-0.49	0.022
115.00	-10.84	-1.13	0.00	-25.39	0.00	25.39	834.98	215.05	411.76	345.04	6.46	-0.50	0.019
115.94	-10.67	-1.12	0.00	-24.34	0.00	24.34	831.44	213.50	405.83	341.07	6.55	-0.50	0.019
115.94	-10.67	-1.12	0.00	-24.34	0.00	24.34	831.44	213.50	405.83	341.07	6.55	-0.50	0.084
118.00	-7.71	-0.88	0.00	-22.03	0.00	22.03	823.53	210.07	392.92	332.36	6.77	-0.50	0.076
120.00	-7.52	-0.87	0.00	-20.28	0.00	20.28	815.69	206.75	380.59	323.94	6.99	-0.52	0.072
123.00	-7.28	-0.85	0.00	-17.68	0.00	17.68	803.62	201.77	362.48	311.38	7.32	-0.55	0.066
125.00	-6.99	-0.82	0.00	-15.98	0.00	15.98	795.36	198.45	350.65	303.06	7.56	-0.57	0.062
130.00	-6.70	-0.80	0.00	-11.86	0.00	11.86	774.00	190.15	321.94	282.46	8.17	-0.61	0.051
135.00	-6.42	-0.77	0.00	-7.86	0.00	7.86	751.59	181.85	294.45	262.19	8.83	-0.64	0.039
140.00	-3.25	-0.42	0.00	-4.00	0.00	4.00	728.15	173.54	268.18	242.29	9.51	-0.66	0.021
145.00	-3.00	-0.38	0.00	-1.92	0.00	1.92	694.01	165.24	243.15	219.76	10.21	-0.67	0.013
150.00	0.00	-0.35	0.00	0.00	0.00	0.00	659.14	156.94	219.34	198.10	10.92	-0.68	0.000

Site Number: 302488

Code: ANSI/TIA-222-H

© 2007 - 2021 by ATC IP LLC. All rights reserved.

Site Name: Cntrn - Canton, CT

Engineering Number: 13692185\_C3\_03

7/8/2021 1:39:12 PM

Customer: DISH WIRELESS L.L.C.

## Analysis Summary

Load Case	Reactions						Max Usage	
	Shear FX (kips)	Shear FZ (kips)	Axial FY (kips)	Moment MX (ft-kips)	Moment MY (ft-kips)	Moment MZ (ft-kips)	Elev (ft)	Interaction Ratio
1.2D + 1.0W	22.84	0.00	49.51	0.00	0.00	2567.96	115.94	0.85
0.9D + 1.0W	22.81	0.00	37.12	0.00	0.00	2508.74	115.94	0.82
1.2D + 1.0Di + 1.0Wi	6.99	0.00	74.46	0.00	0.00	861.83	115.94	0.32
1.2D + 1.0Ev + 1.0Eh	1.62	0.00	49.43	0.00	0.00	210.92	115.94	0.09
0.9D - 1.0Ev + 1.0Eh	1.62	0.00	34.46	0.00	0.00	204.90	115.94	0.08
1.0D + 1.0W	5.56	0.00	41.31	0.00	0.00	617.09	115.94	0.21

Site Number: 302488

Code: ANSI/TIA-222-H

© 2007 - 2021 by ATC IP LLC. All rights reserved.

Site Name: Cntrn - Canton, CT

Engineering Number: 13692185\_C3\_03

7/8/2021 1:39:12 PM

Customer: DISH WIRELESS L.L.C.

Additional Steel Summary

			Intermediate Connectors				Max Member		
Elev From (ft)	Elev To (ft)	Member	VQ/I (lb/in)	Shear Applied (kips)	Shear phiVn (kips)	Ratio	Pu (kip)	phiPn (kip)	Ratio
0.00	9.50	(4) SOL-#20 All Thread Bar	208.5	8.3	16.8	0.496	269.0	313.6	0.858
9.50	91.67	(4) SOL-#20 All Thread Bar	356.8	10.7	16.8	0.637	263.5	330.5	0.797
91.67	115.94	(2) SOL-#20 All Thread Bar	390.9	11.7	16.8	0.698	178.5	330.5	0.540
91.67	115.94	(1) SOL-#20 All Thread Bar	390.9	11.7	16.8	0.698	178.5	330.5	0.540

			Upper Termination Connectors				Lower Termination Connectors					
Elev From (ft)	Elev To (ft)	Member	MQ/I (kips)	phiVn (kips)	Num Reqd	Num Actual	Ratio	MQ/I (kips)	phiVn (kips)	Num Reqd	Num Actual	Ratio
0.00	9.50	(4) SOL-#20 All Thread Bar	0.0	12.0	0	0	0.000	0.0	12.0	0	0	0.000
9.50	91.67	(4) SOL-#20 All Thread Bar	161.7	12.0	14	14	0.962	0.0	12.0	0	0	0.000
91.67	115.94	(2) SOL-#20 All Thread Bar	94.1	12.0	8	12	0.654	175.4	12.0	15	16	0.914
91.67	115.94	(1) SOL-#20 All Thread Bar	94.1	12.0	8	12	0.654	0.0	12.0	0	0	0.000



## Base Plate & Anchor Rod Analysis

Pole Dimensions		
Number of Sides	12	-
Diameter	37.38	in
Thickness	3/8	in
Orientation Offset		°

Base Reactions		
Moment, Mu	2,568.0	k-ft
Axial, Pu	49.5	k
Shear, Vu	22.8	k
Neutral Axis	50	°

Report Capacities		
Component	Capacity	Result
Base Plate	58%	Pass
Anchor Rods	89%	Pass
Dwyidag	69%	Pass

Base Plate		
Shape	Square	-
Width	44.5	in
Thickness	2 1/2	in
Grade	A572-60	
Yield Strength, Fy	60	ksi
Tensile Strength, Fu	75	ksi
Clip	0	in
Orientation Offset		°
Anchor Rod Detail	c	$\eta=0.55$
Clear Distance	N/A	in
Applied Moment, Mu	1260.4	k
Bending Stress, $\phi Mn$	2187.6	k

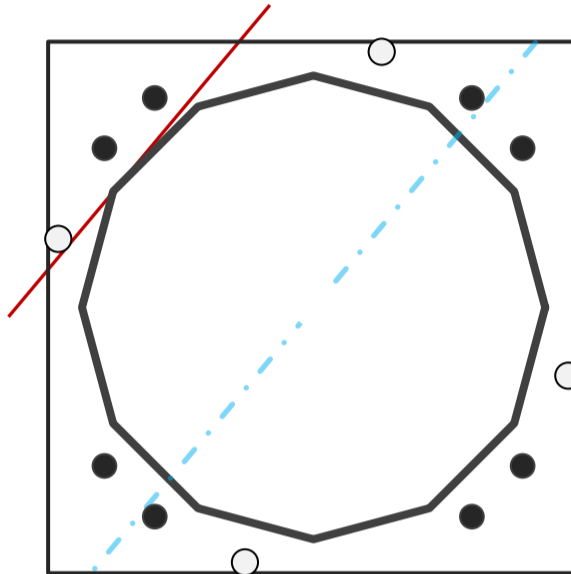

Dwyidag Reinforcement		
Quantity	4	-
Bar Size	#20	in
Diameter, $\phi$	2.5	in
Bracket Type	Angle	-
Circle	44.26	in
Orientation Offset	-15	°
Applied Force, Pu	253.7	k
Dwyidag Bar, $\phi Pn$	368.2	k

Original Anchor Rods		
Arrangement	Cluster	-
Quantity	8	-
Diameter, $\phi$	2 1/4	in
Bolt Circle	44	in
Grade	A615-75	
Yield Strength, Fy	75	ksi
Tensile Strength, Fu	100	ksi
Spacing	6.0	in
Orientation Offset		°
Applied Force, Pu	215.2	k
Anchor Rods, $\phi Pn$	243.6	k

# Calculations for Monopole Base Plate & Anchor Rod Analysis

## Reaction Distribution

Reaction	Shear Vu	Moment Mu	Factor
-	k	k-ft	-
Base Forces	22.8	1553.9	0.61
Anchor Rod Forces	22.8	1553.9	0.61
Additional Bolt (Grp1) Forces	0.0	0.0	0.00
Additional Bolt (Grp2) Forces	0.0	0.0	0.00
Dywidag Forces	0.0	1014.1	0.39
Stiffener Forces	0.0	0.0	0.00

## Geometric Properties

Section	Gross Area	Net Area	Individual Inertia	Threads per Inch	Moment of Inertia
-	in <sup>2</sup>	in <sup>2</sup>	in <sup>4</sup>	#	in <sup>4</sup>
Pole	43.0992	3.5916	0.1692		7379.37
Bolt	3.9761	3.2477	0.8393	4.5	6294.24
Bolt1	0.0000	0.0000	0.0000	0	0.00
Bolt2	0.0000	0.0000	0.0000	0	0.00
Dywidag	4.9087	4.9087	1.9175		4815.65
Stiffener	0.0000	0.0000	0.0000		0.00

### Base Plate

Shape	Square	-
Width, W	44.5	in
Thickness, t	2.5	in
Yield Strength, Fy	60	ksi
Tensile Strength, Fu	75	ksi
Base Plate Chord	24.145	in
Detail Type	c	-
Detail Factor	0.55	-
Clear Distance	N/A	-

### Anchor Rods

Anchor Rod Quantity, N	8	-
Rod Diameter, d	2.25	in
Bolt Circle, BC	44	in
Yield Strength, Fy	75	ksi
Tensile Strength, Fu	100	ksi
Applied Axial, Pu	215.2	k
Applied Shear, Vu	0.2	k
Compressive Capacity, $\phi P_n$	243.6	k
Tensile Capacity, $\phi R_n$	0.883	OK
Interaction Capacity	0.885	OK

### External Base Plate

Chord Length AA	25.428	in
Additional AA	0.500	in
Section Modulus, Z	40.512	in <sup>3</sup>
Applied Moment, Mu	1260.4	k-ft
Bending Capacity, $\phi M_n$	2187.6	k-ft
Capacity, $M_u/\phi M_n$	0.576	OK

Chord Length AB	24.104	in
Additional AB	0.500	in
Section Modulus, Z	38.444	in <sup>3</sup>
Applied Moment, Mu	979.0	k-ft
Bending Capacity, $\phi M_n$	2076.0	k-ft
Capacity, $M_u/\phi M_n$	0.472	OK

Bend Line Length	0.000	in
Additional Bend Line	0.000	in
Section Modulus, Z	0.000	in <sup>3</sup>
Applied Moment, Mu	0.0	k-ft
Bending Capacity, $\phi M_n$	0.0	k-ft
Capacity, $M_u/\phi M_n$		

### Internal Base Plate

Arc Length	0.000	in
Section Modulus, Z	0.000	in <sup>3</sup>
Moment Arm	0.000	in
Applied Moment, Mu	0.0	k-ft
Bending Capacity, $\phi M_n$	0.0	k-ft
Capacity, $M_u/\phi M_n$		

### Dywidag Reinforcement

Dywidag Quantity, N	4	-
Dywidag Diameter, d	2.5	in
Bolt Circle, BC	44.26	in
Yield Strength, Fy	80	ksi
Tensile Strength, Fu	100	ksi
Applied Axial, Pu	253.7	k
Compressive Capacity, $\phi P_n$	368.2	k
Capacity, $P_u/\phi P_n$	0.689	OK



# Flange Plate Analysis

Flange Plate	Plate Type	<b>Flange</b>	<b>@ 110 ft</b>
	Pole Diameter	21.27	in
	Pole Thickness	3/16	in
	Plate Diameter	28	in
	Plate Thickness	1	in
	Plate Fy	60	ksi
	Weld Length	1/4	in
	f <sub>s</sub> Resistance Applied	148.07	k-in
	78.59	k-in	

Code Rev.	<b>H</b>
Moment	362.5 k-ft
Axial	14.8 k

Date	7/8/2021
Engineer	Colson L Teal
Site #	302488
Carrier	DISH WIRELESS

Stiffeners	#	<b>12</b>	<b>Show</b>
	Thickness	1/4	in
	Length	3	in
	Height	6	in
	Chamfer	3/4	in
	Offset Angle	0	°
	Fy	36	ksi

Bolts	#	<b>12</b>	
	Bolt Circle (R)adial / (S)quare	25.75	in
		R	
	Diameter	1	in
	Hole Diameter	1 1/8	in
	Type	A490	
	Fy	130	ksi
	Fu	150	ksi
f <sub>s</sub> Resistance Applied	68.15	k	
	55.05	k	

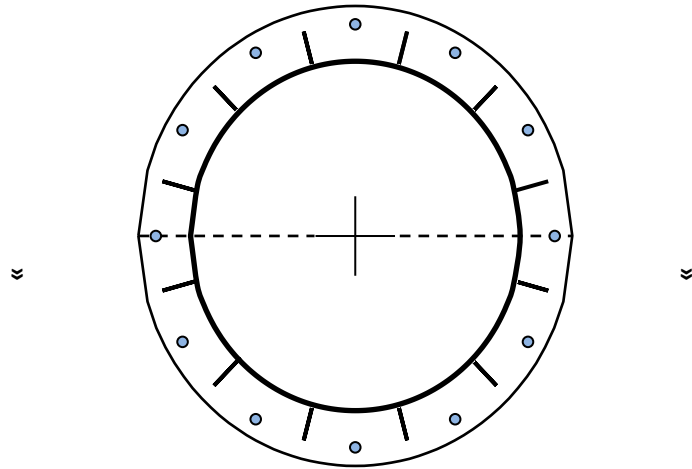

Reinforcement	#	<b>0</b>	
---------------	---	----------	--

**Plate Stress Ratio:**  
53% Pass

**Bolt Stress Ratio:**  
81% Pass

Extra Bolts	#	<b>0</b>	
-------------	---	----------	--

**Site Name:** Cntn - Canton, CT  
**Site Number:** 302488  
**Tower Type:** MP  
**Design Loads (Factored) - Analysis per TIA-222-H Standards**

## Monolithic Mat & Pier Foundation Analysis

Foundation Analysis Parameters		
Design / Analysis / Mapping:	Mapping	-
Compression/Leg:	49.5	k
Uplift/Leg:		k
Total Shear:	22.8	k
Moment:	2,568.0	k-ft
Tower + Appurtenance Weight:	49.5	k
Depth to Base of Foundation (l + t - h):	5.375	ft
Diameter of Pier (d):	4.958333	ft
Length of Pier (l):	4.125	ft
Height of Pier above Ground (h):	0.75	ft
Width of Pad (W):	26	ft
Length of Pad (L):	26	ft
Thickness of Pad (t):	2	ft
Tower Leg Center to Center:	0	ft
Number of Tower Legs:	1	-
Tower Center from Mat Center:	0	ft
Depth Below Ground Surface to Water Table:	3.5	ft
Unit Weight of Concrete:	150	pcf
Unit Weight of Soil Above Water Table:	115	pcf
Unit Weight of Water:	62.4	pcf
Unit Weight of Soil Below Water Table:	52.6	pcf
Friction Angle of Uplift:	15	°
Coefficient of Shear Friction:	0.35	-
Ultimate Compressive Bearing Pressure:	12,000	psf
Ultimate Passive Pressure on Pad Face:	0	psf
$f_{\text{Soil and Concrete Weight}}$ :	0.9	-
$f_{\text{Soil}}$ :	0.75	-

Overturning Moment Usage		
Design OTM:	2707.9	k-ft
OTM Resistance:	5309.6	k-ft
Design OTM / OTM Resistance:	51%	Pass

Soil Bearing Pressure Usage		
Net Bearing Pressure:	1140	psf
Factored Nominal Bearing Pressure:	9000	psf
Factored Nominal (Net) Bearing Pressure:	13%	Pass
Load Direction Controlling Design Bearing Pressure:	<i>Diagonal to Pad Edge</i>	

Sliding Factor of Safety		
Ultimate Friction Resistance:	151.1	k
Ultimate Passive Pressure Resistance:	0.0	k
Total Factored Sliding Resistance:	113.3	k
Sliding Design / Sliding Resistance:	20%	Pass

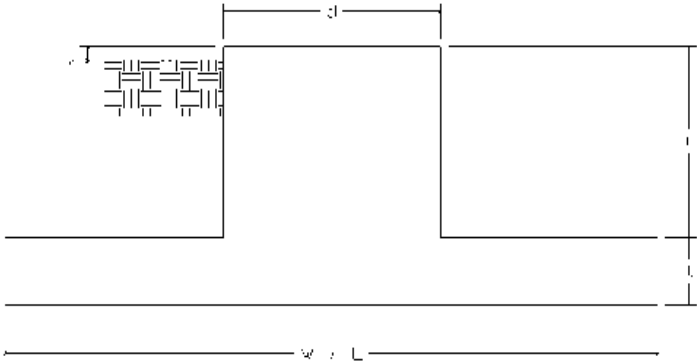

# INFINIGY

---

## MOUNT ANALYSIS REPORT

August 26, 2021

Dish Wireless Site Name	BOBDL00152B
Dish Wireless Site Number	BOBDL00152B
ATC Site Name	Cntn - Canton, CT
ATC Site Number	302488
Infinigy Job Number	1197-F0001-C
Client	ATC
Carrier	Dish Wireless
Site Location	4 Hoffmann Road Canton, CT 06019 Hartford County 41.855278 N NAD83 72.892500 W NAD83
Mount Type	8.0 ft Platform
Mount Elevation	108.0 ft AGL
Structural Usage Ratio	<b>42.9</b>
<b>Overall Result</b>	<b>Pass</b>

The enclosed mount structural analysis has been performed in accordance with the 2018 Connecticut State Building Code (2015 IBC) based on an ultimate 3-second gust wind speed of 120 mph. The evaluation criteria and applicable codes are presented in the next section of this report.

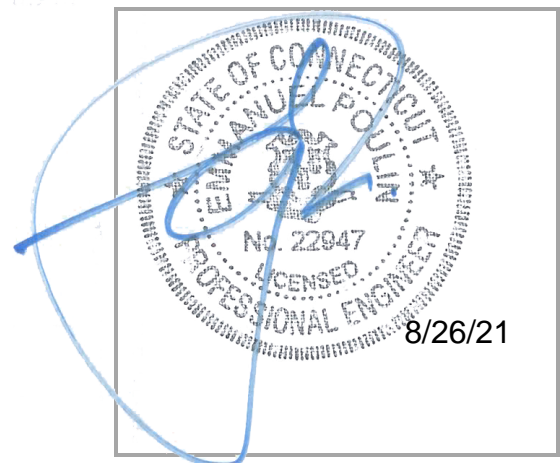

**CONTENTS**

1. Introduction
2. Design/Analysis Parameters
3. Proposed Loading Configuration
4. Supporting Documentation
5. Results
6. Recommendations
7. Assumptions
8. Liability Waiver and Limitations
9. Calculations

August 26, 2021

**1. INTRODUCTION**

Infinigy performed a structural analysis on the Dish Wireless proposed telecommunication equipment supporting Platform mounted to the existing structure located at the aforementioned address. All referenced supporting documents have been obtained from the client and are assumed to be accurate and applicable to this site. The mount was analyzed using Risa-3D version 17.0.4 analysis software.

**2. DESIGN/ANALYSIS PARAMETERS**

Wind Speed	120 mph (3-Second Gust)
Wind Speed w/ ice	50 mph (3-Second Gust) w/ 2.0" ice
Code / Standard	TIA-222-H
Adopted Code	2018 Connecticut State Building Code (2015 IBC)
Risk Category	II
Exposure Category	B
Topographic Category	1
Calculated Crest Height	0 ft.
Seismic Spectral Response	$S_s = 0.180 \text{ g} / S_1 = 0.064 \text{ g}$
Live Load Wind Speed	60 mph
Man Live Load at Mid/End Points	250 lbs
Man Live Load at Mount Pipes	500 lbs

**3. PROPOSED LOADING CONFIGURATION - 108.0 ft. AGL Platform**

Antenna Centerline (ft)	Qty.	Appurtenance Manufacturers	Appurtenance Models
108.0	3	JMA WIRELESS	MX08FRO665-21
	3	FUJITSU	TA08025-B605
	3	FUJITSU	TA08025-B604
	1	RAYCAP	RDIDC-9181-PF-48

**4. SUPPORTING DOCUMENTATION**

Proposed Loading	Dish Wireless Asset ID CT-ATC-T-302488 Rev 1, Site #BOBDL00152B, dated July 09, 2021
Mount Manufacturer Drawings	Commscope Document # MC-PK8-DSH, dated March 08, 2021
Structural Analysis Report	ATC, Asset #302488, dated July 08, 2021
Construction Drawings	B+T Group, A&E Project # 153478.001.01, Rev 0, dated August 02, 2021

**5. RESULTS**

<b>Components</b>	<b>Capacity</b>	<b>Pass/Fail</b>
Mount Pipes	17.2%	Pass
Horizontals	10.4%	Pass
Standoffs	33.3%	Pass
Handrails	20.5%	Pass
Connections	42.9%	Pass
<b>MOUNT RATING =</b>	<b>42.9 %</b>	<b>Pass</b>

Notes:

1. See additional documentation in Appendix for calculations supporting the capacity consumed and detailed mount connection calculations.

**6. RECOMMENDATIONS**

Infinigy recommends installing Dish Wireless’s proposed equipment loading configuration on the mount at 108.0 ft. The installation shall be performed in accordance with the construction documents issued for this site.

Pradin Suinyal Magar  
 Project Engineer II | **INFINIGY**

**7. ASSUMPTIONS**

The antenna mounting system was properly fabricated, installed and maintained in accordance with its original design and manufacturer's specifications.	
The configuration of antennas, mounts, and other appurtenances are as specified in the proposed loading configuration table.	
All member connections are assumed to have been designed to meet or exceed the load carrying capacity of the connected member unless otherwise specified in this report.	
The analysis will require revisions if the existing conditions in the field differ from those shown in the above-referenced documents or assumed in this analysis. No allowance was made for any damaged, missing, or rusted members.	
Steel grades have been assumed as follows, unless noted otherwise:	
Channel, Solid Round, Plate, Built-up Angle	ASTM A1011 36 KSI
Structural Angle	ASTM A529 Gr. 50
HSS (Rectangular)	ASTM A500-B GR 46
HSS (Circular)	ASTM A500-B GR 42
Pipe	ASTM A500 Gr C
Connection Bolts	ASTM A325
U-Bolts	ASTM A307
All bolted connections are pretensioned in accordance with Table 8.2 of the RCSC 2014 Standard	

**8. LIABILITY WAIVER AND LIMITATIONS**

Our structural calculations are completed assuming all information provided to Infinigy is accurate and applicable to this site. For the purposes of calculations, we assume an overall structure condition as erected and all members and connections to be free of corrosion and/or structural defects. The structure owner and/or contractor shall verify the structure's condition prior to installation of any proposed equipment. If actual conditions differ from those described in this report, Infinigy should be notified immediately to assess the impact on the results of this report.

Our evaluation is completed using industry standard methods and procedures. The structural results, conclusions and recommendations contained in this report are proprietary and should not be used by others as their own. Infinigy is not responsible for decisions made by others that are or are not based on the stated assumptions and conclusions in this report.

This report is an evaluation of the mount structure only and does not determine the adequacy of the supporting structure, other carrier mounts or cable mounting attachments. The analysis of these elements is outside the scope of this analysis, are assumed to be adequate for the purpose of this report and to have been installed per their manufacturer requirements. This document is not for construction purposes.

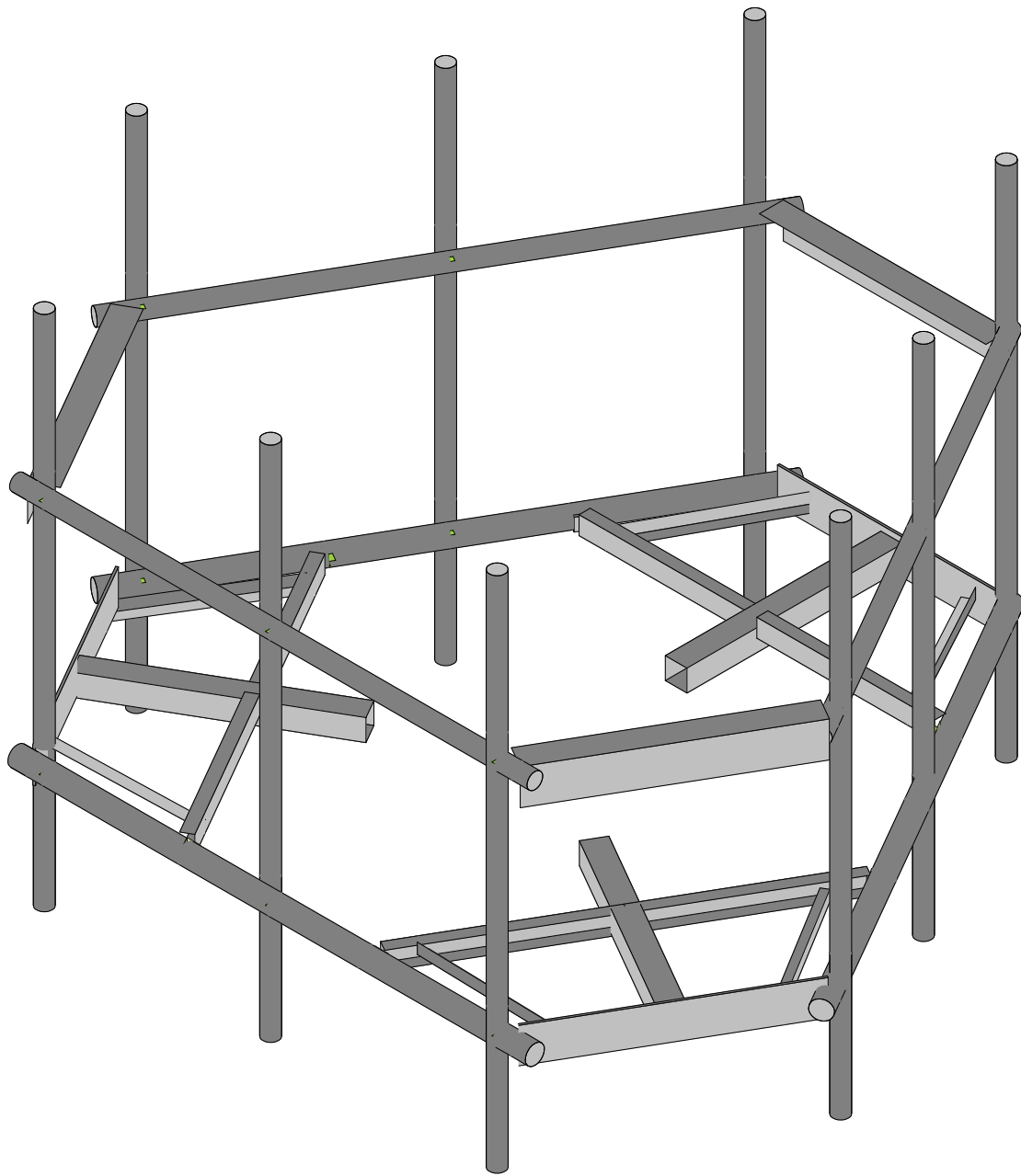
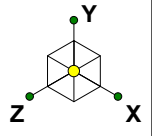

Infinigy Engineering, PLLC  
PSM  
1197-F0001-C

BOBDL00152B

Rendered  
Aug 26, 2021 at 5:27 PM  
BOBDL00152B\_loaded.r3d



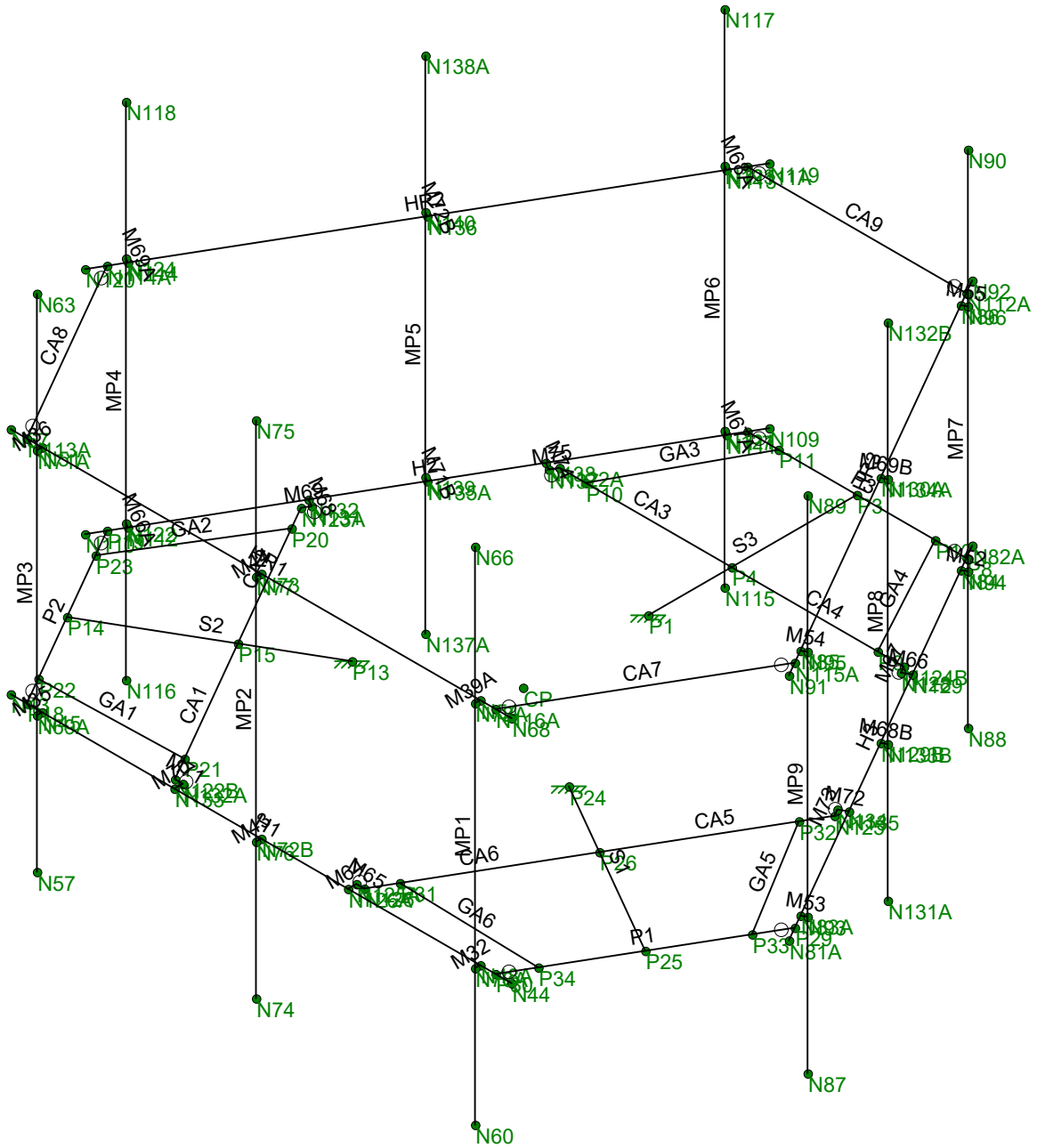
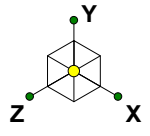

Infinigy Engineering, PLLC	BOBDL00152B	WireFrame
PSM		Aug 26, 2021 at 5:27 PM
1197-F0001-C		BOBDL00152B_loaded.r3d

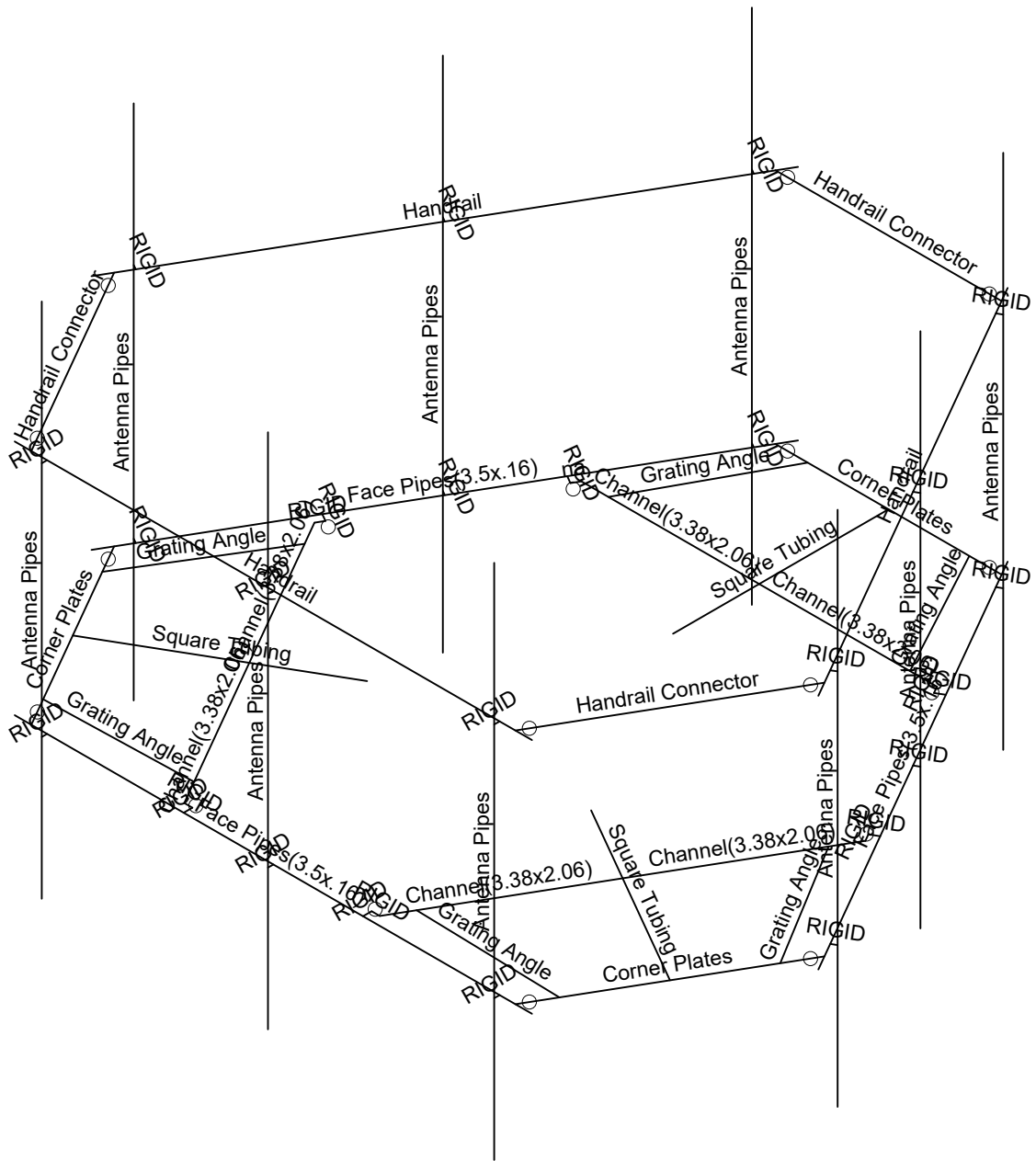
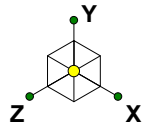

Infinigy Engineering, PLLC	BOBDL00152B	Section Sets
PSM		Aug 26, 2021 at 5:27 PM
1197-F0001-C		BOBDL00152B_loaded.r3d

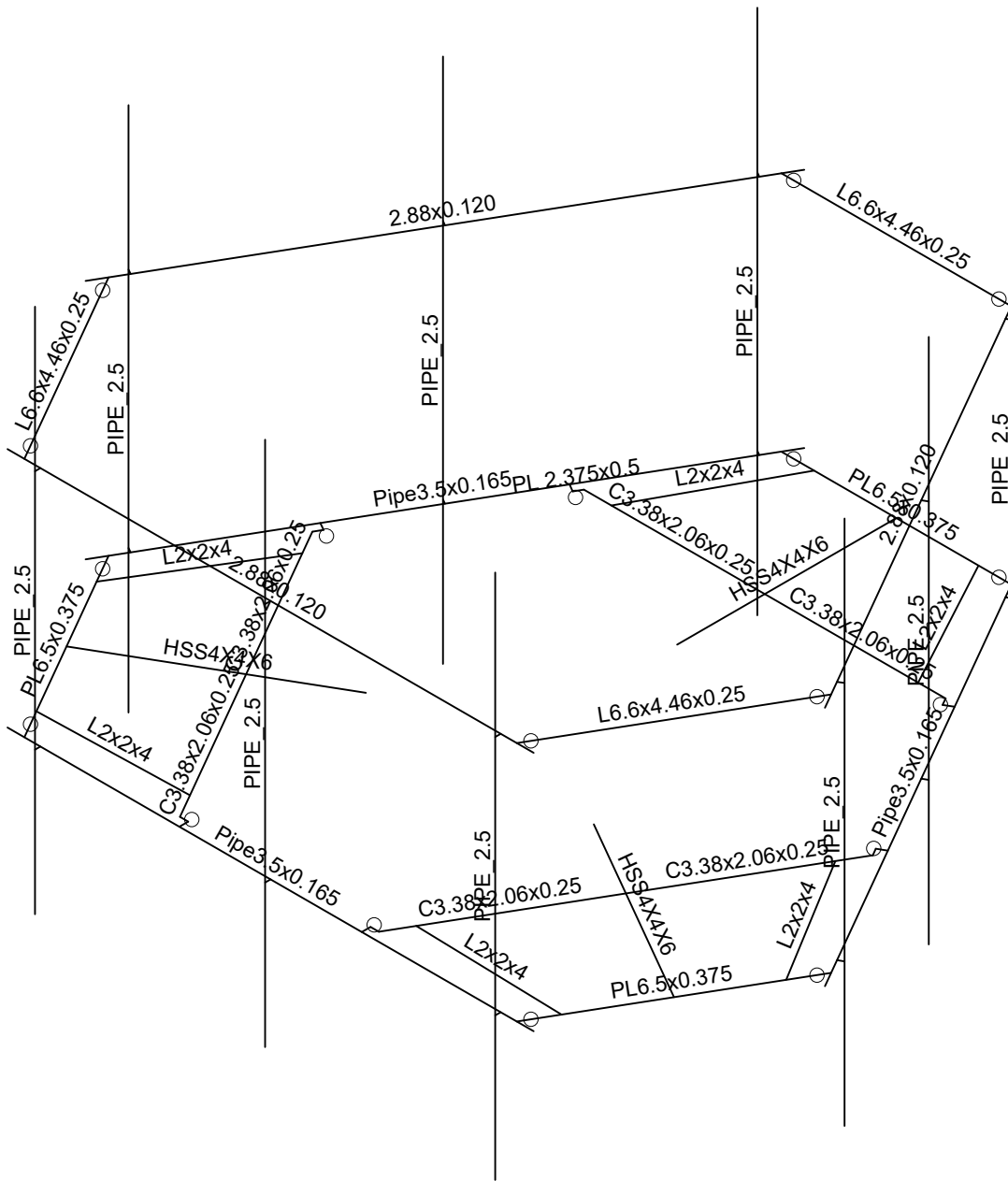
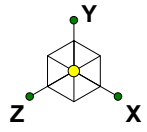

Infinigy Engineering, PLLC  
 PSM  
 1197-F0001-C

BOBDL00152B

Member Shapes  
 Aug 26, 2021 at 5:28 PM  
 BOBDL00152B\_loaded.r3d

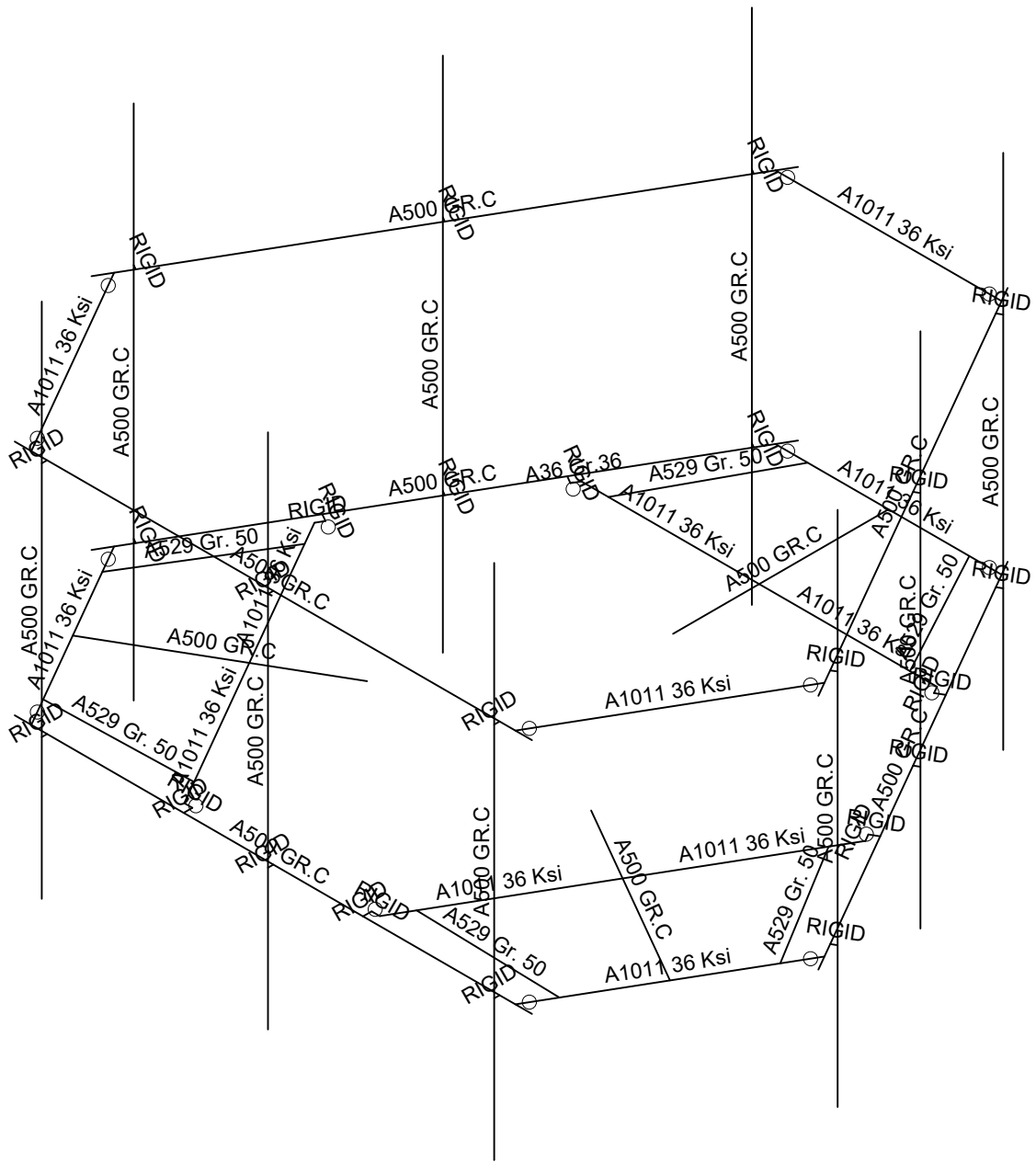
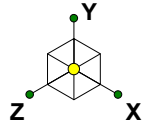

Infinigy Engineering, PLLC  
 PSM  
 1197-F0001-C

BOBDL00152B

Material Sets

Aug 26, 2021 at 5:28 PM

BOBDL00152B\_loaded.r3d

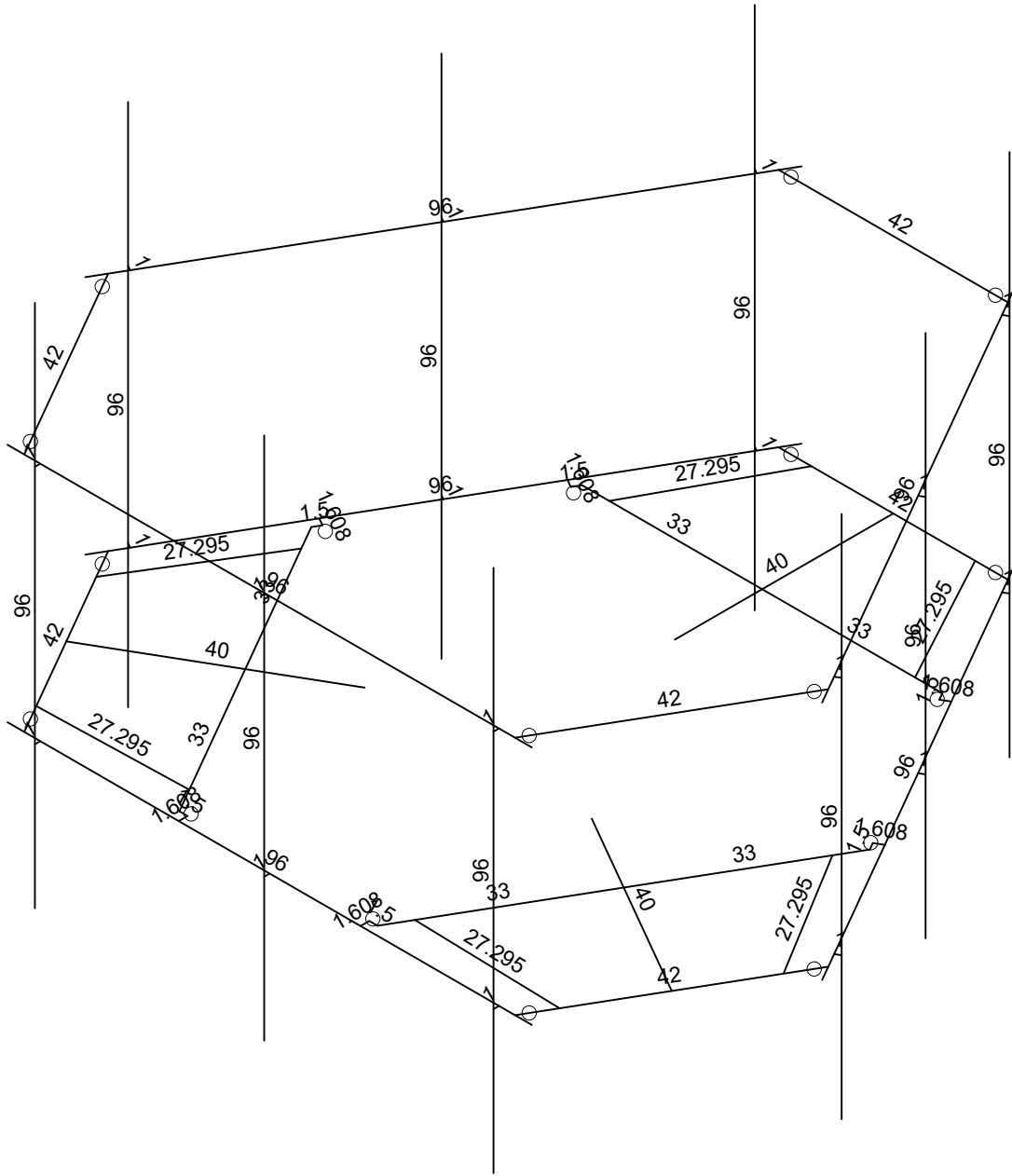
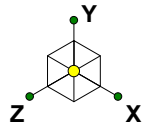

Member Length (in) Displayed

Infinigy Engineering, PLLC  
 PSM  
 1197-F0001-C

BOBDL00152B

Member Lengths

Aug 26, 2021 at 5:28 PM

BOBDL00152B\_loaded.r3d

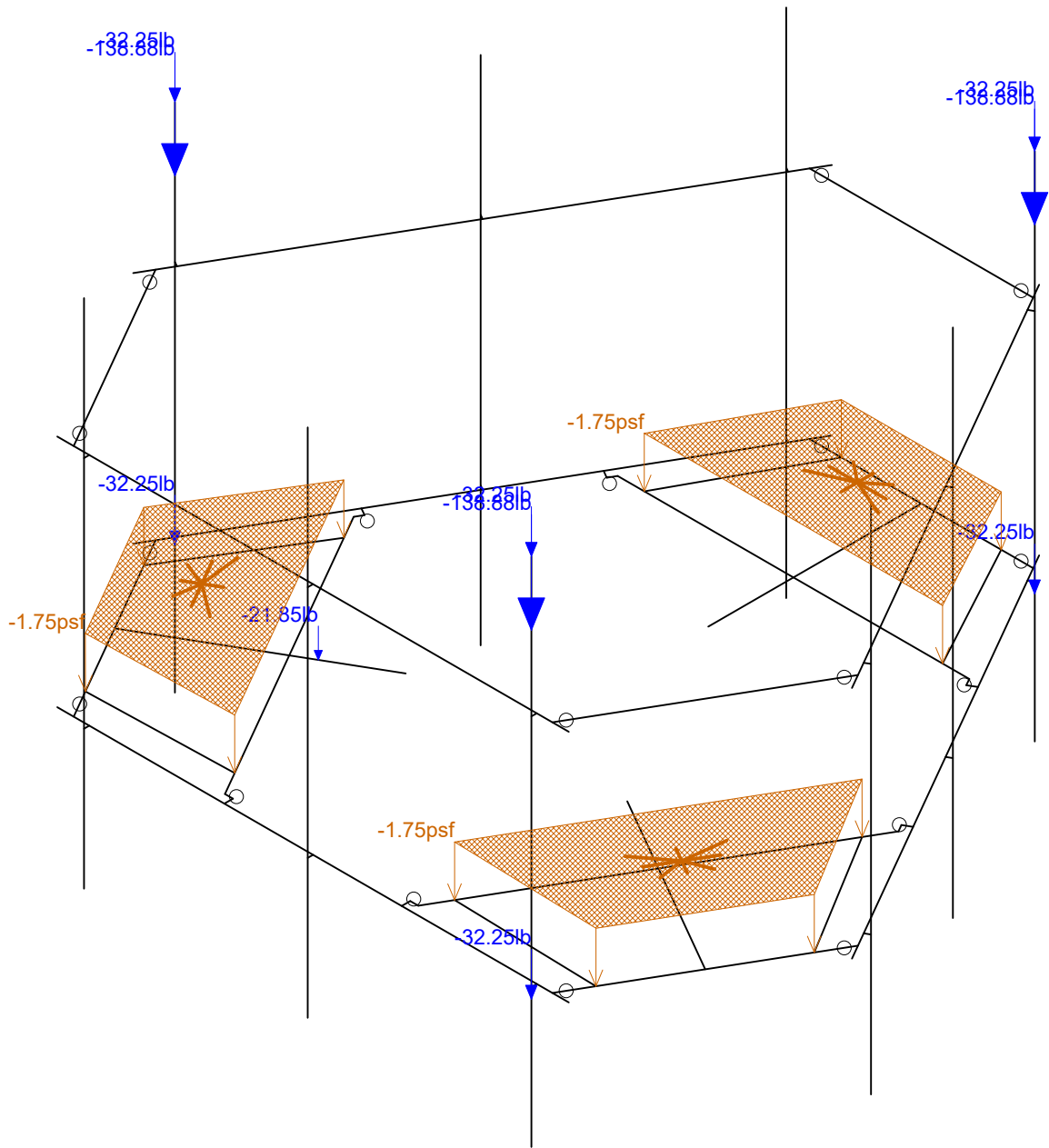
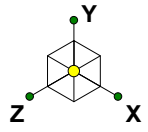

Loads: BLC 1, Self Weight

Infinigy Engineering, PLLC  
 PSM  
 1197-F0001-C

BOBDL00152B

Self Weight  
 Aug 26, 2021 at 5:28 PM  
 BOBDL00152B\_loaded.r3d

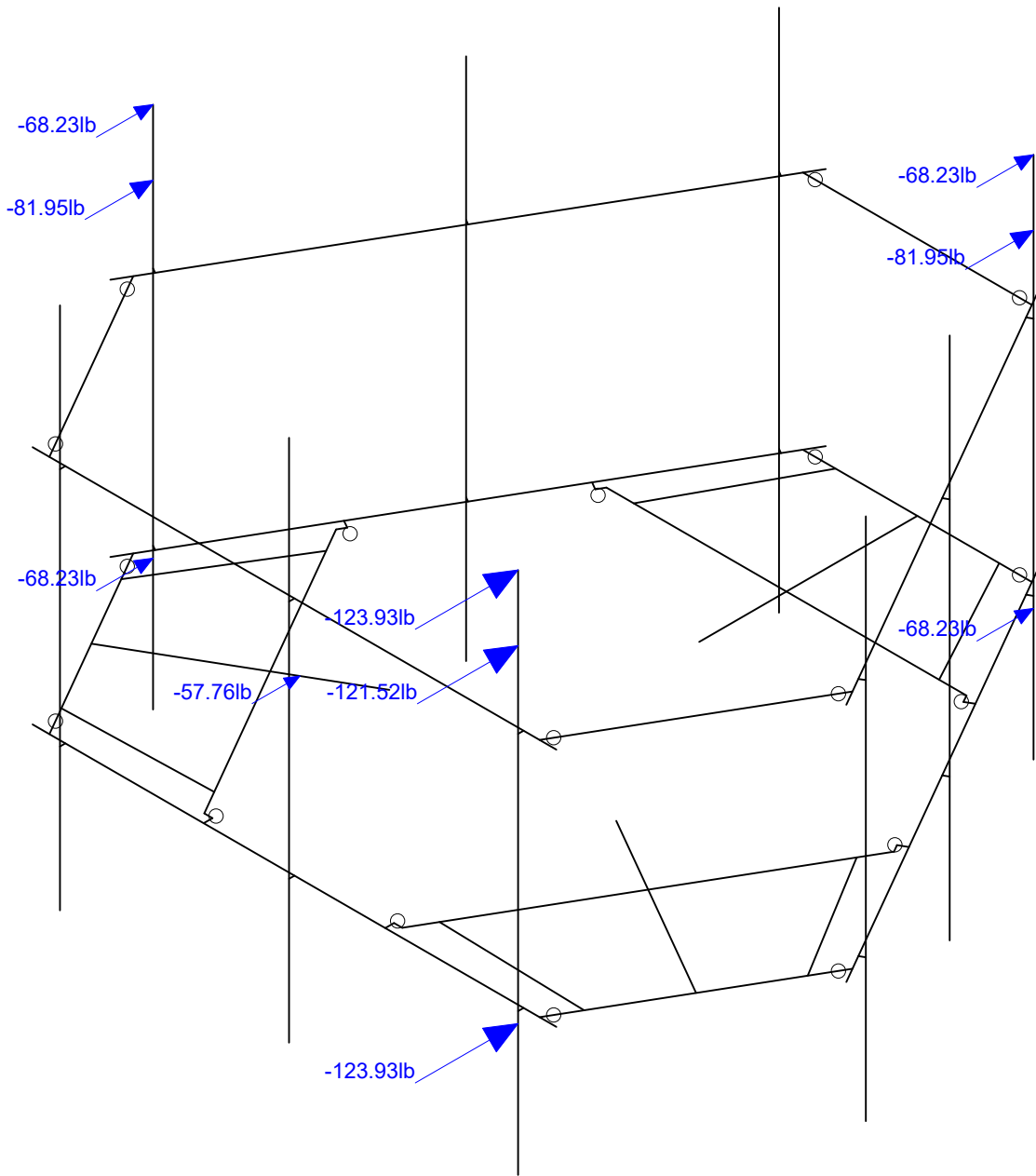
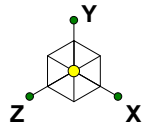

Loads: BLC 2, Wind Load AZI 0

Infinigy Engineering, PLLC  
 PSM  
 1197-F0001-C

BOBDL00152B

Wind Load AZI 000

Aug 26, 2021 at 5:29 PM

BOBDL00152B\_loaded.r3d

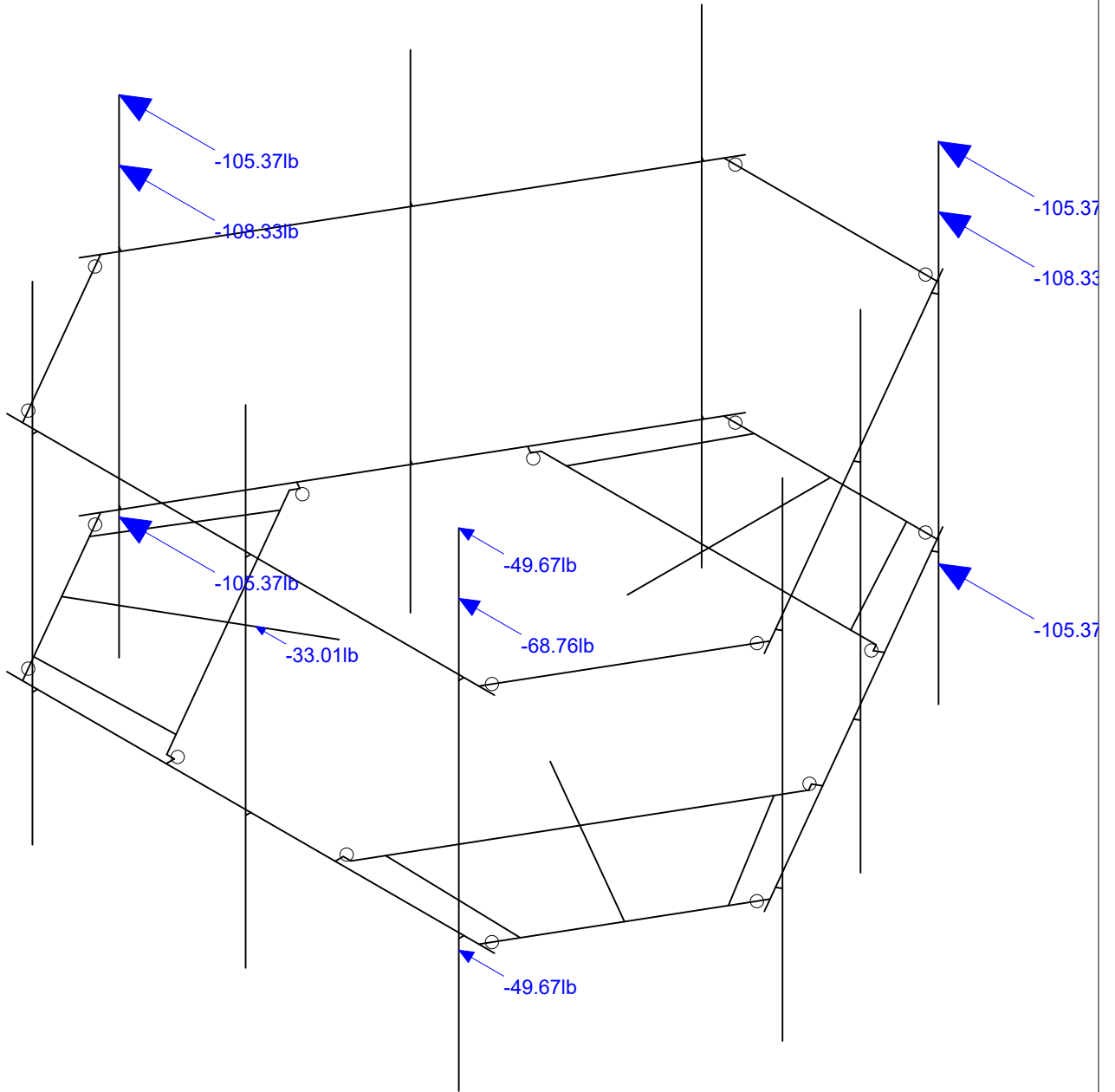
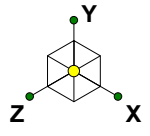

Loads: BLC 5, Wind Load AZI 90

Infinigy Engineering, PLLC  
PSM  
1197-F0001-C

BOBDL00152B

Wind Load AZI 090  
Aug 26, 2021 at 5:29 PM  
BOBDL00152B\_loaded.r3d



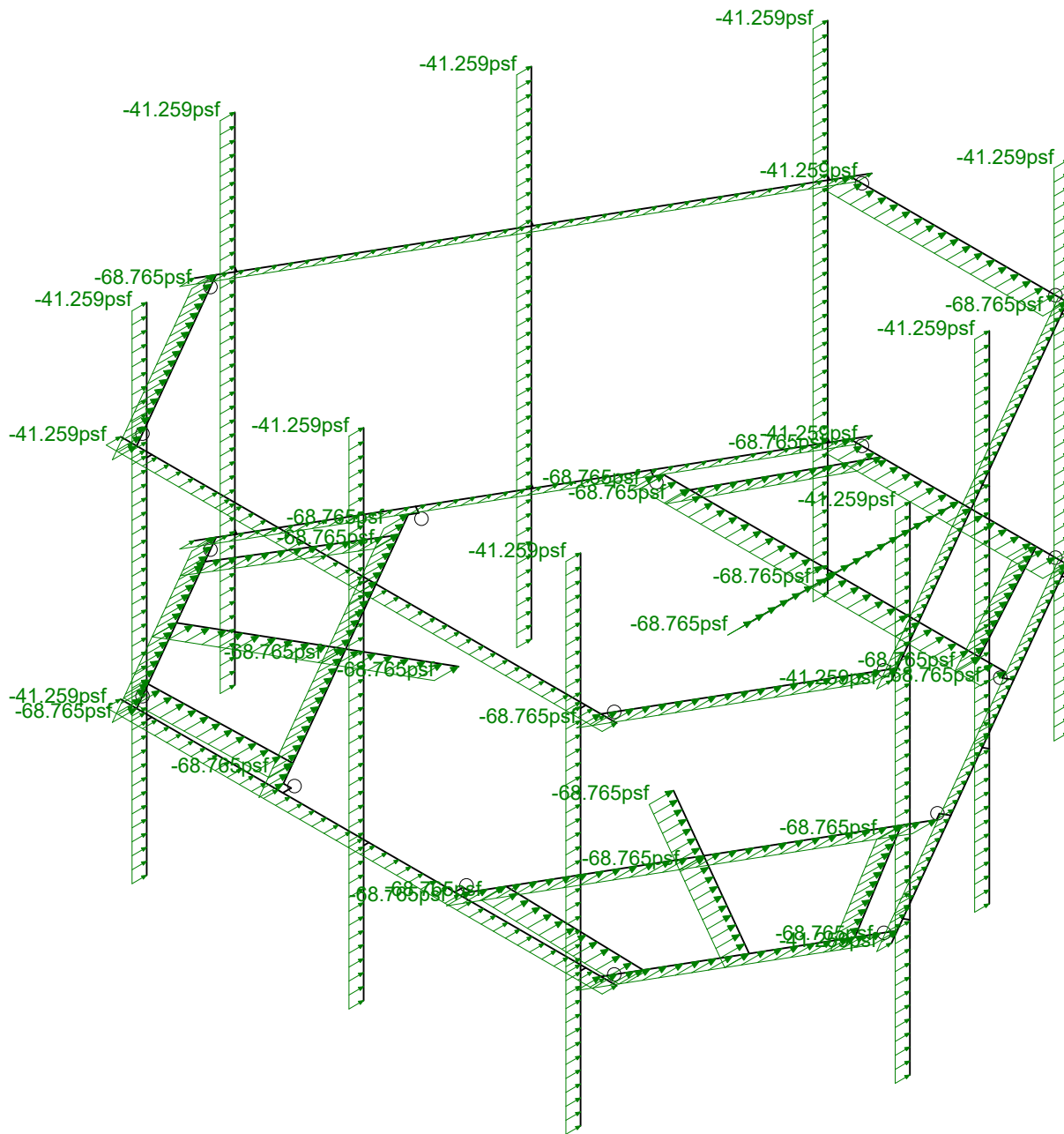
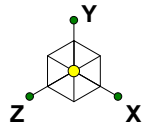

Loads: BLC 14, Distr. Wind Load Z

Infinigy Engineering, PLLC  
 PSM  
 1197-F0001-C

BOBDL00152B

Distr Wind Load AZI 000  
 Aug 26, 2021 at 5:29 PM  
 BOBDL00152B\_loaded.r3d

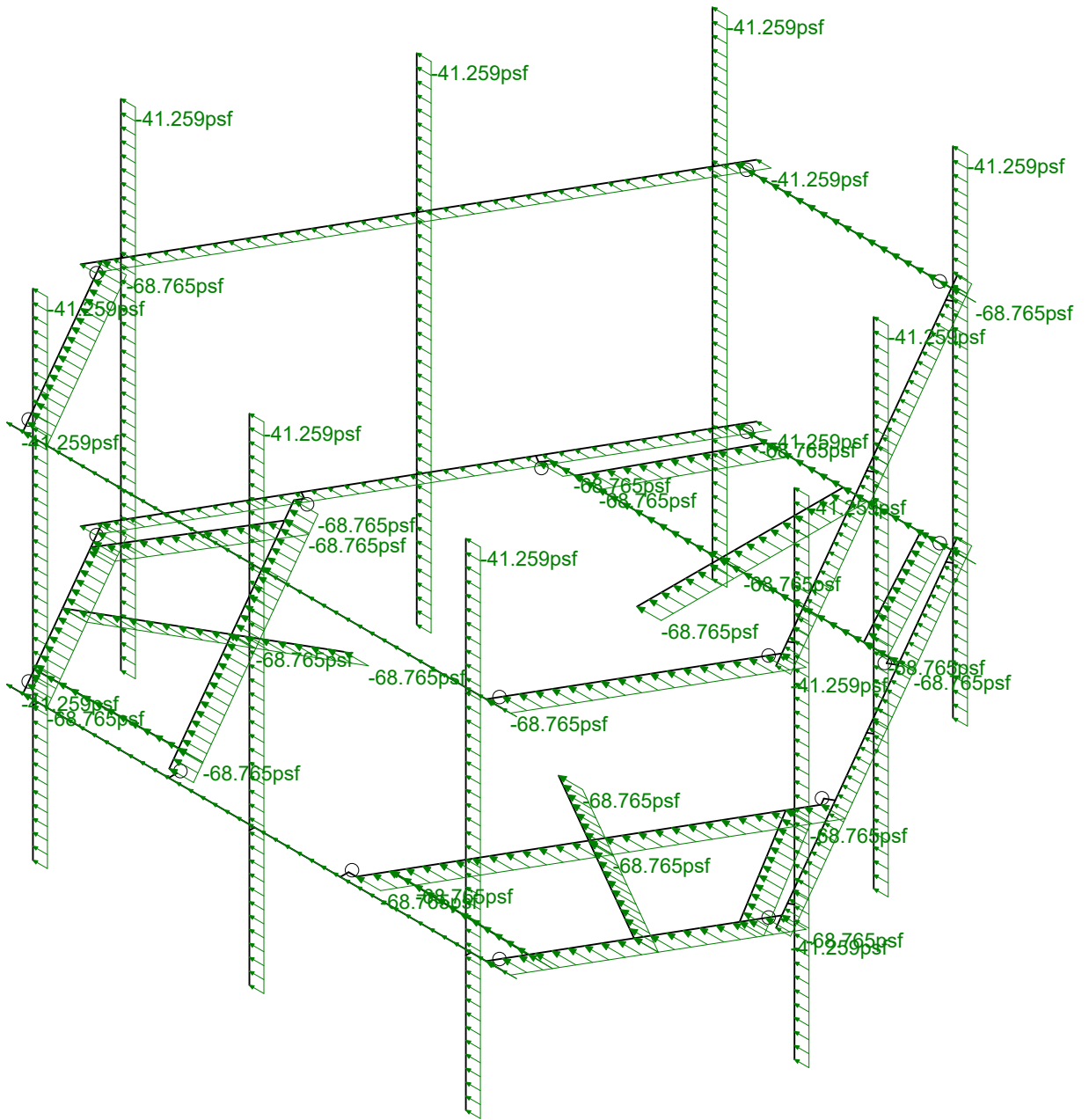
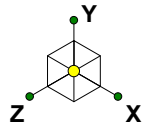

Loads: BLC 15, Distr. Wind Load X

Infinigy Engineering, PLLC  
PSM  
1197-F0001-C

BOBDL00152B

Distr Wind Load AZI 090  
Aug 26, 2021 at 5:29 PM  
BOBDL00152B\_loaded.r3d

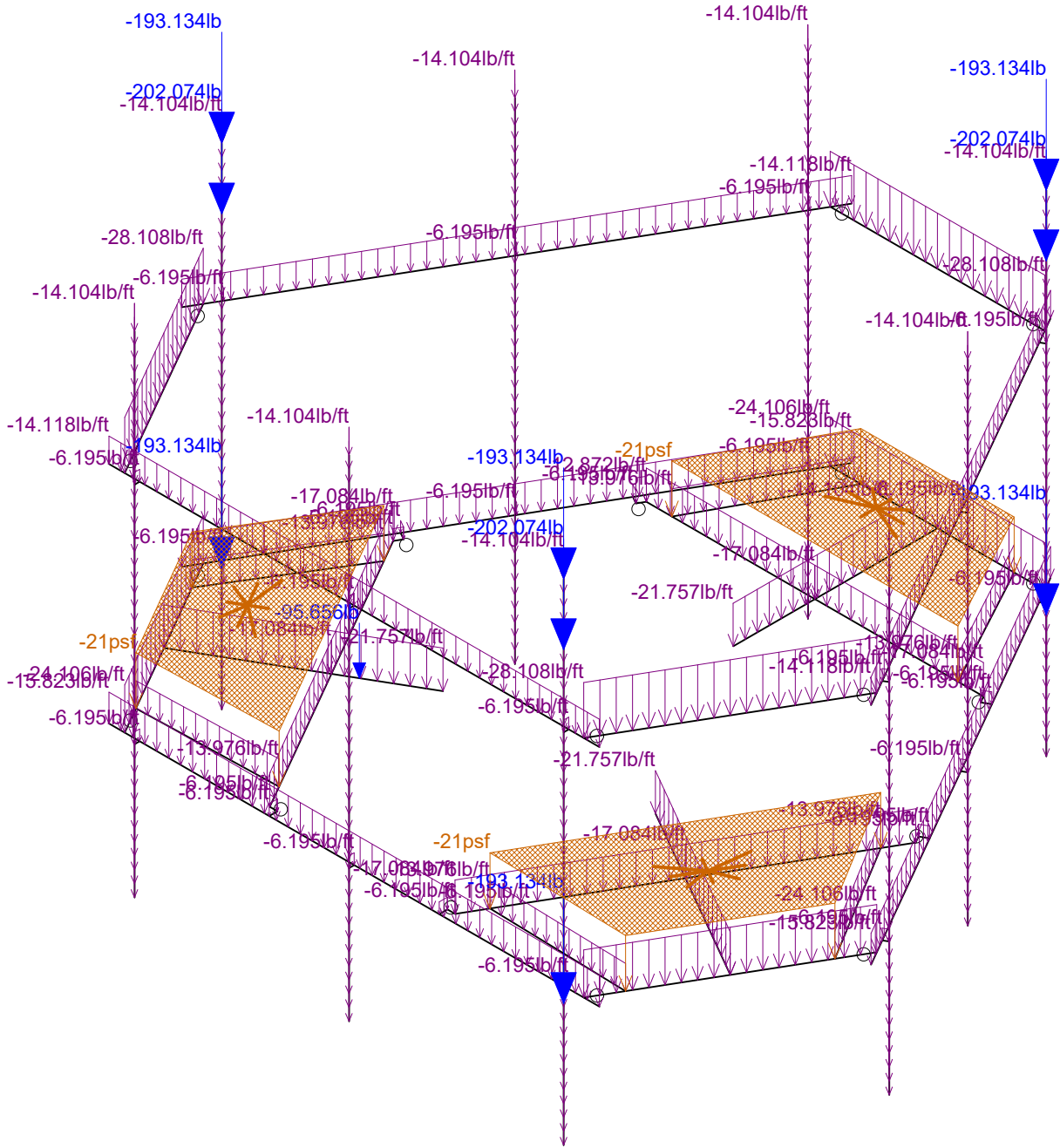
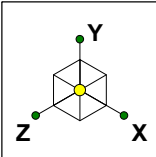

Loads: BLC 16, Ice Weight

Infinigy Engineering, PLLC
PSM
1197-F0001-C

BOBDL00152B

Ice Weight
Aug 26, 2021 at 5:30 PM
BOBDL00152B_loaded.r3d

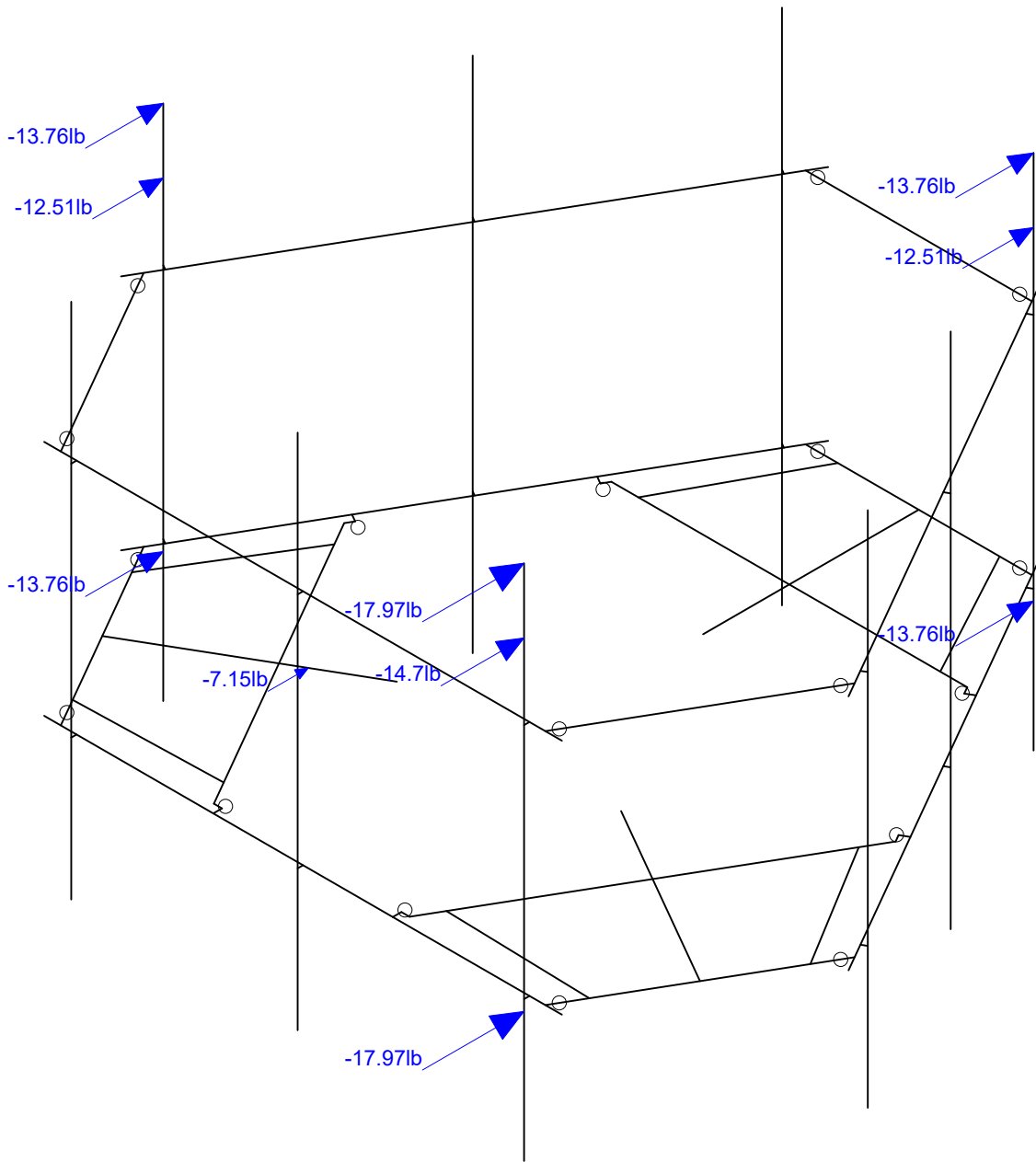
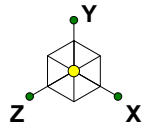

Loads: BLC 17, Ice Wind Load AZI 0

Infinigy Engineering, PLLC  
PSM  
1197-F0001-C

BOBDL00152B

Ice + Wind Load AZI 000  
Aug 26, 2021 at 5:30 PM  
BOBDL00152B\_loaded.r3d

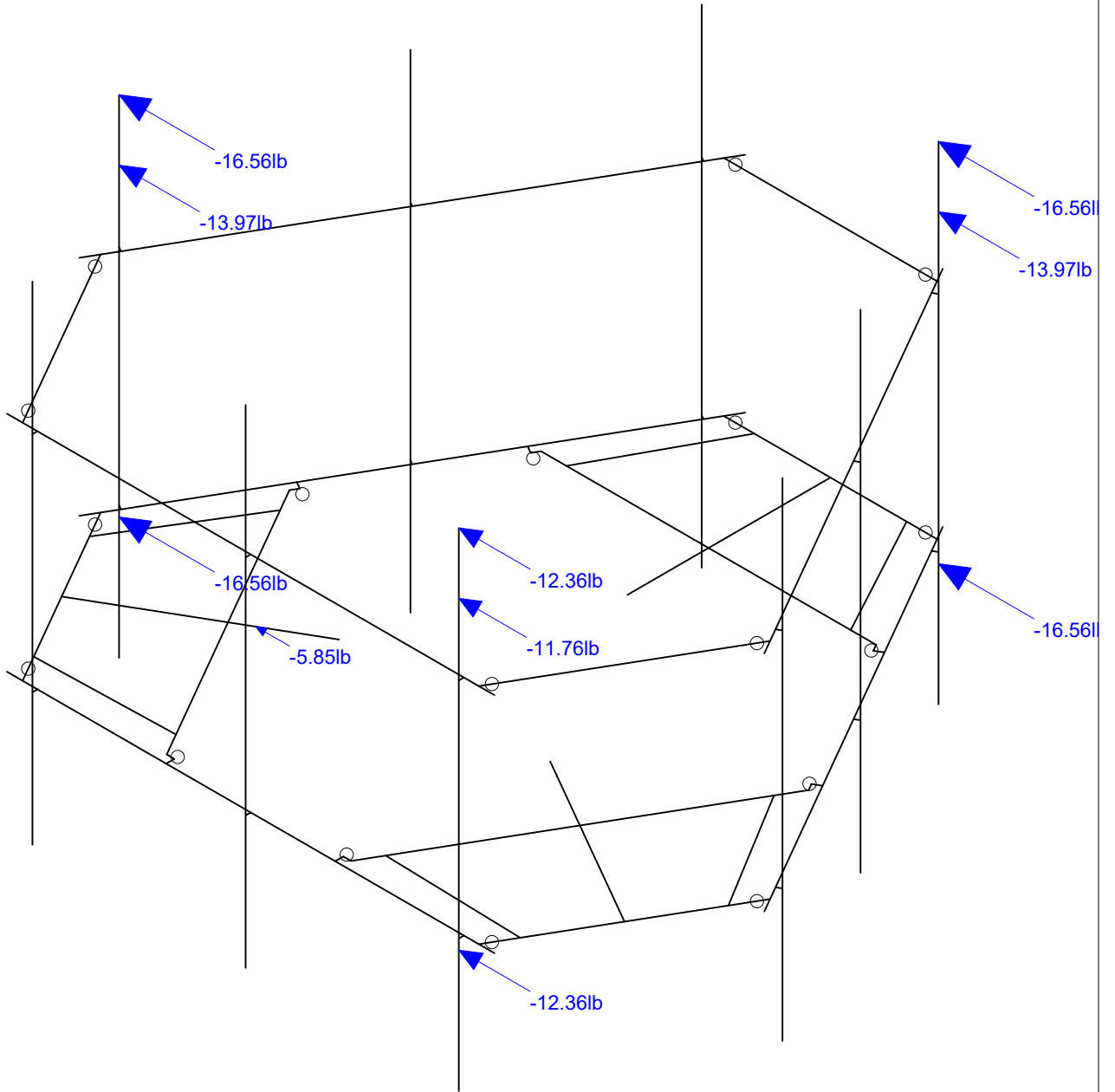
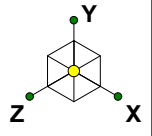

Loads: BLC 20, Ice Wind Load AZI 90

Infinigy Engineering, PLLC

PSM

1197-F0001-C

BOBDL00152B

Ice + Wind Load AZI 090

Aug 26, 2021 at 5:30 PM

BOBDL00152B\_loaded.r3d

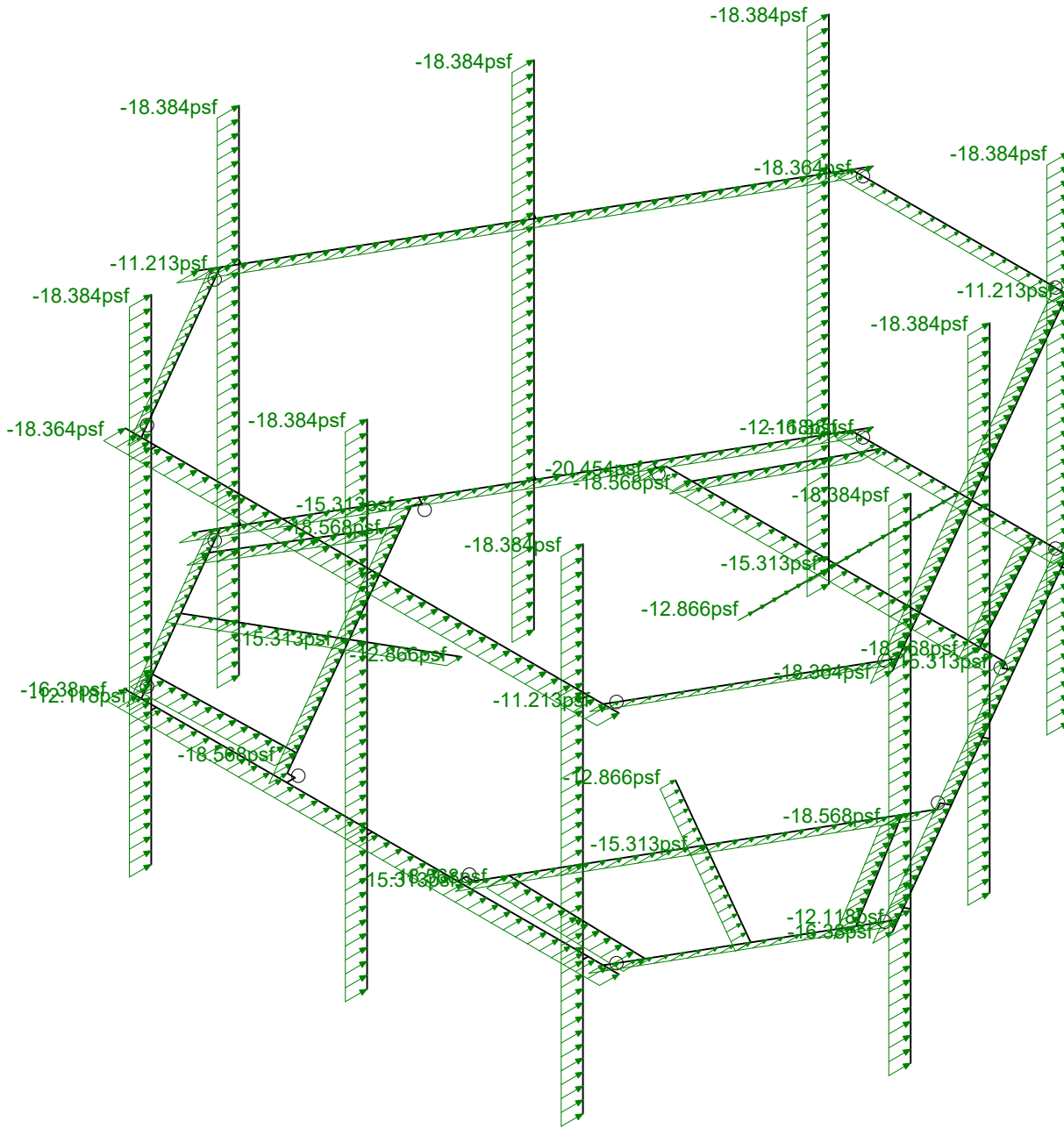
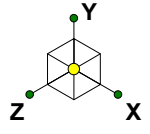

Loads: BLC 29, Distr. Ice Wind Load Z

Infinigy Engineering, PLLC  
PSM  
1197-F0001-C

BOBDL00152B

Distr Ice + Wind Load AZI 000  
Aug 26, 2021 at 5:30 PM  
BOBDL00152B\_loaded.r3d

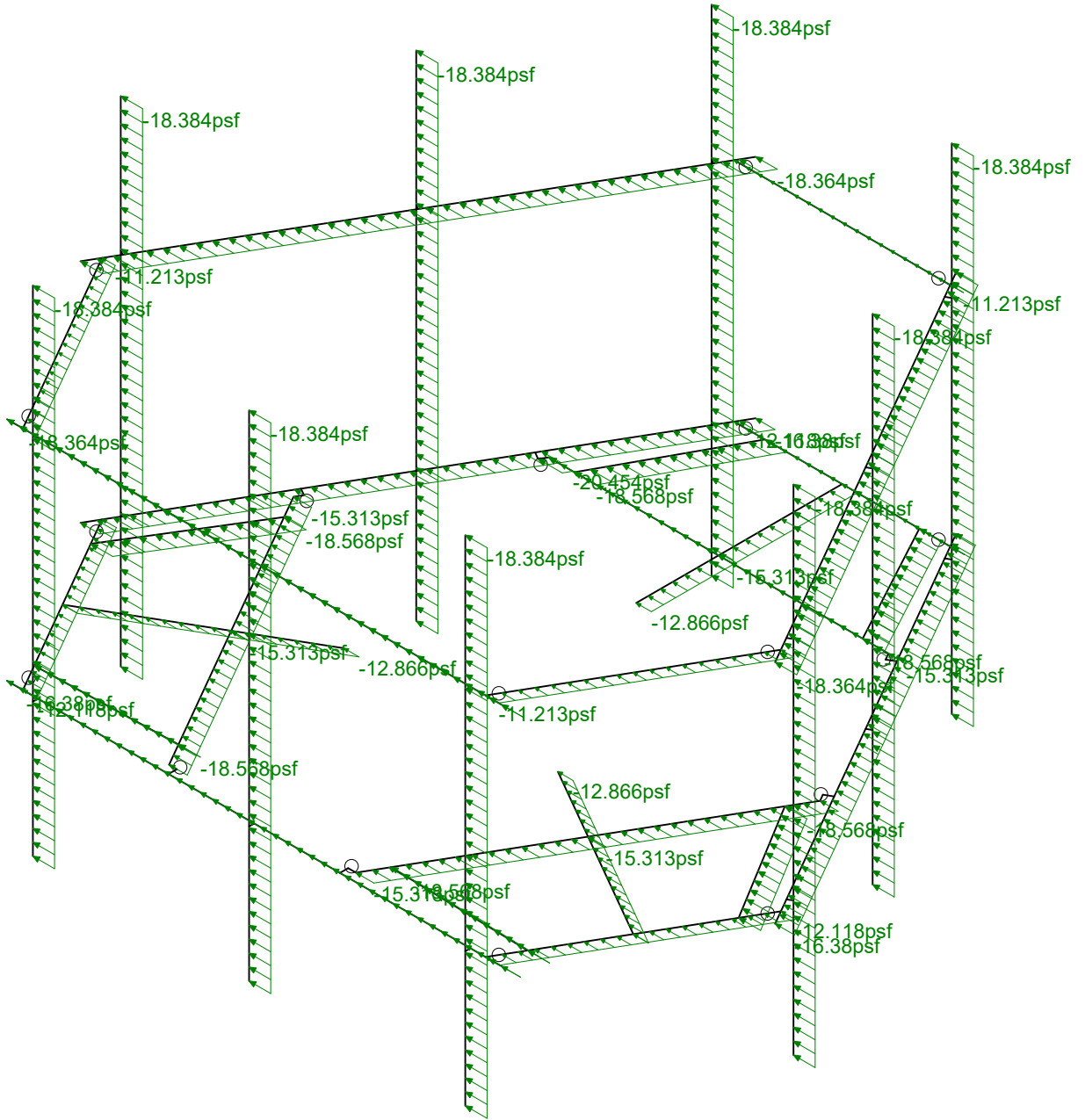
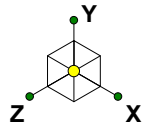

Loads: BLC 30, Distr. Ice Wind Load X

Infinigy Engineering, PLLC  
 PSM  
 1197-F0001-C

BOBDL00152B

Distr Ice + Wind Load AZI 090  
 Aug 26, 2021 at 5:31 PM  
 BOBDL00152B\_loaded.r3d

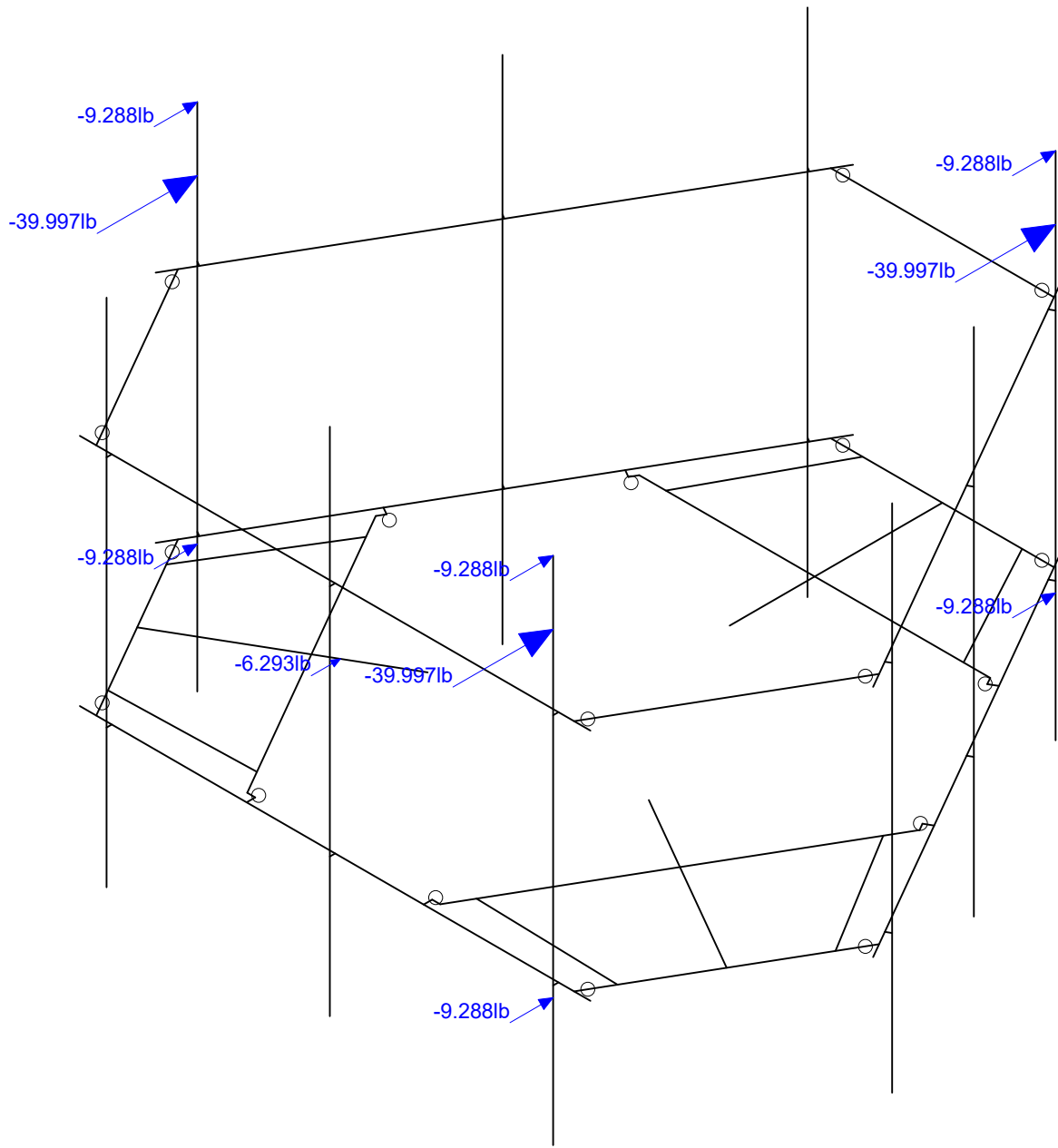
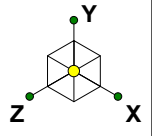

Loads: BLC 31, Seismic Load Z

Infinigy Engineering, PLLC	BOBDL00152B	Seismic Load AZI 000
PSM		Aug 26, 2021 at 5:31 PM
1197-F0001-C		BOBDL00152B_loaded.r3d



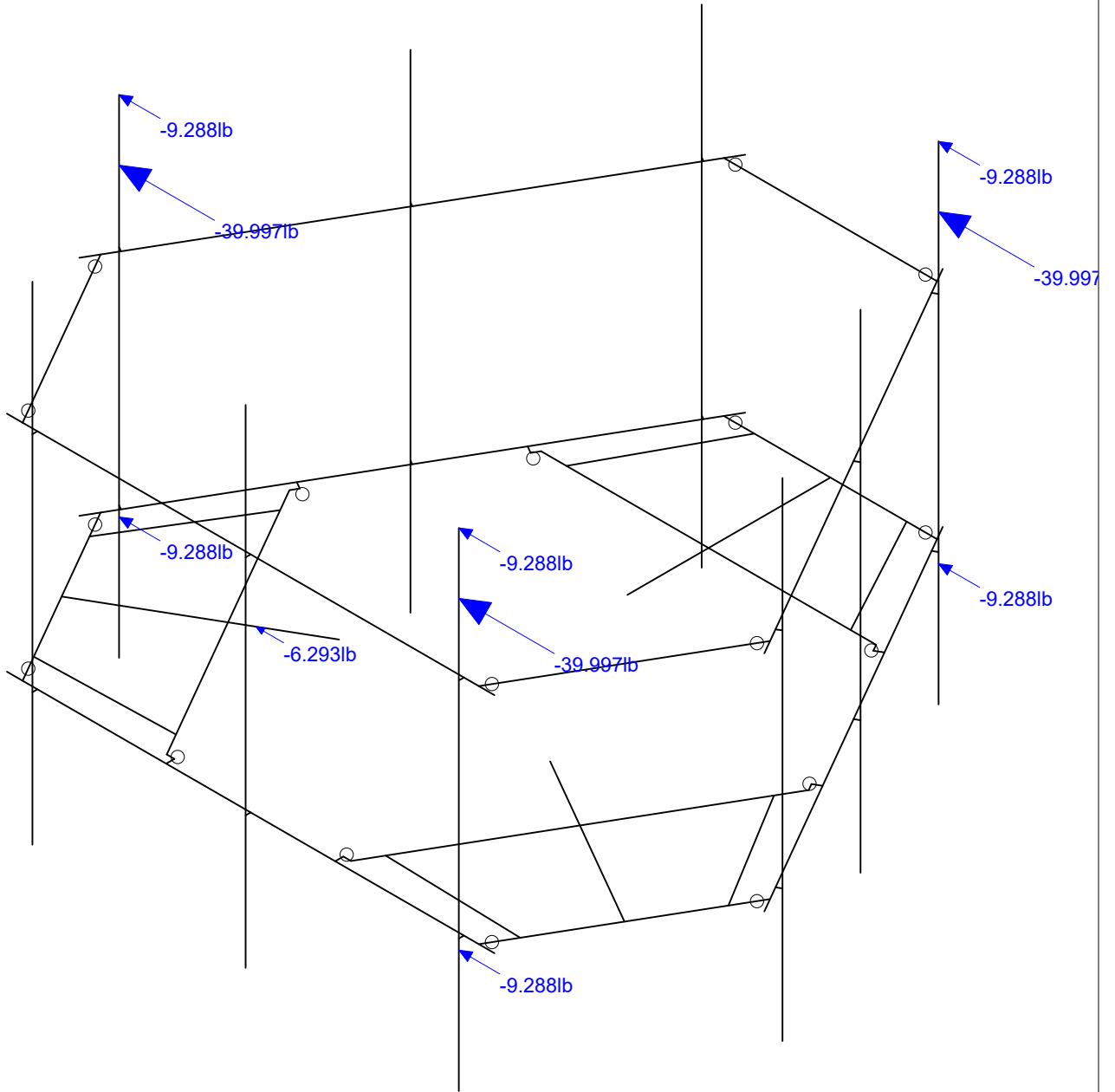
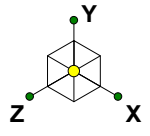

Loads: BLC 32, Seismic Load X

Infinigy Engineering, PLLC	BOBDL00152B	Seismic Load AZI 090
PSM		Aug 26, 2021 at 5:31 PM
1197-F0001-C		BOBDL00152B_loaded.r3d

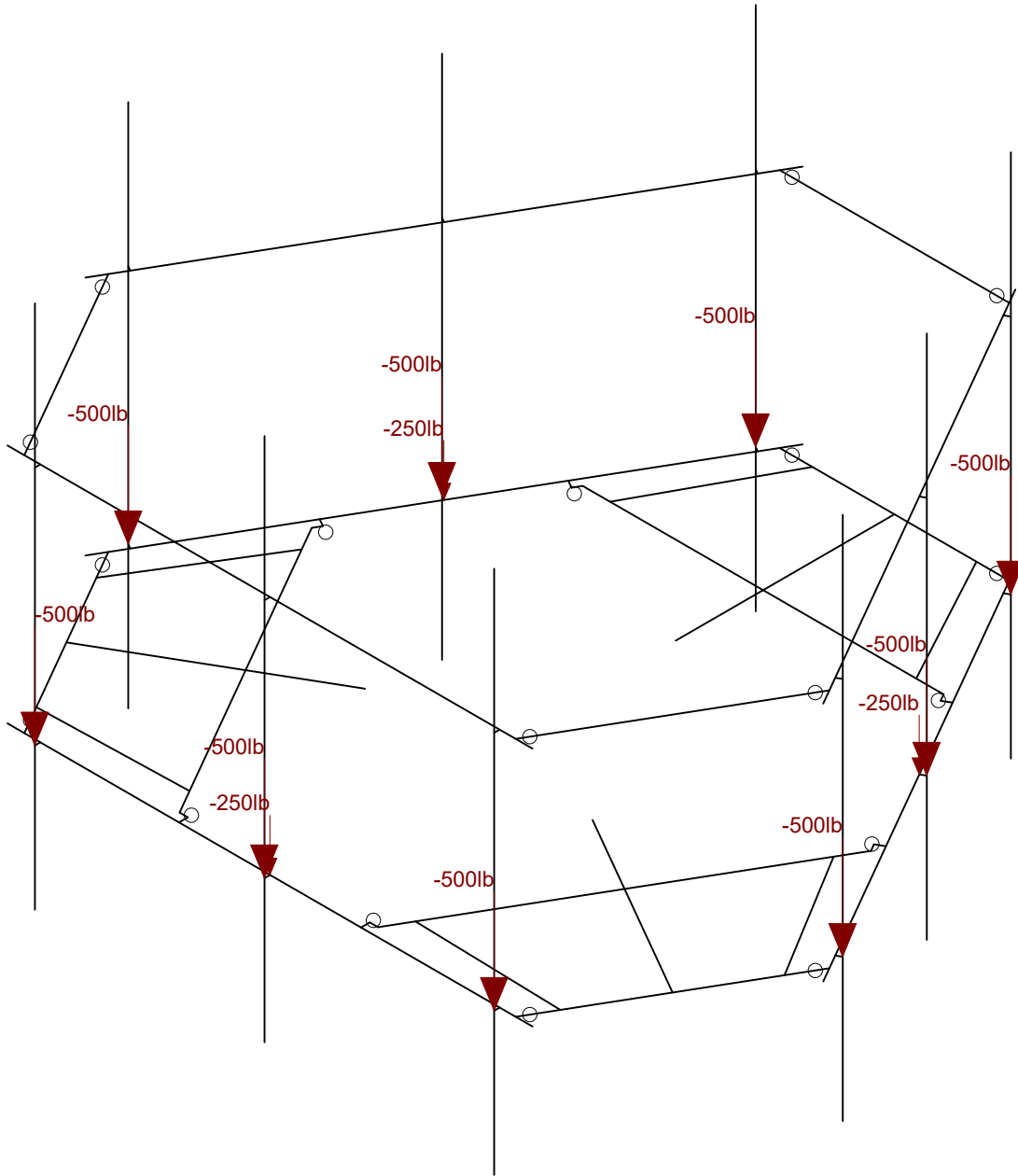
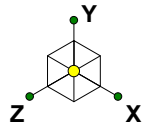

Loads: LL - Live Load

Infinigy Engineering, PLLC

PSM

1197-F0001-C

BOBDL00152B

Non-concurrent Live Loads

Aug 26, 2021 at 5:31 PM

BOBDL00152B\_loaded.r3d

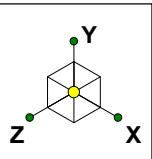

Code Check (LC 1)	
Black	No Calc
Red	> 1.0
Magenta	.90-1.0
Green	.75-.90
Cyan	.50-.75
Blue	0-.50

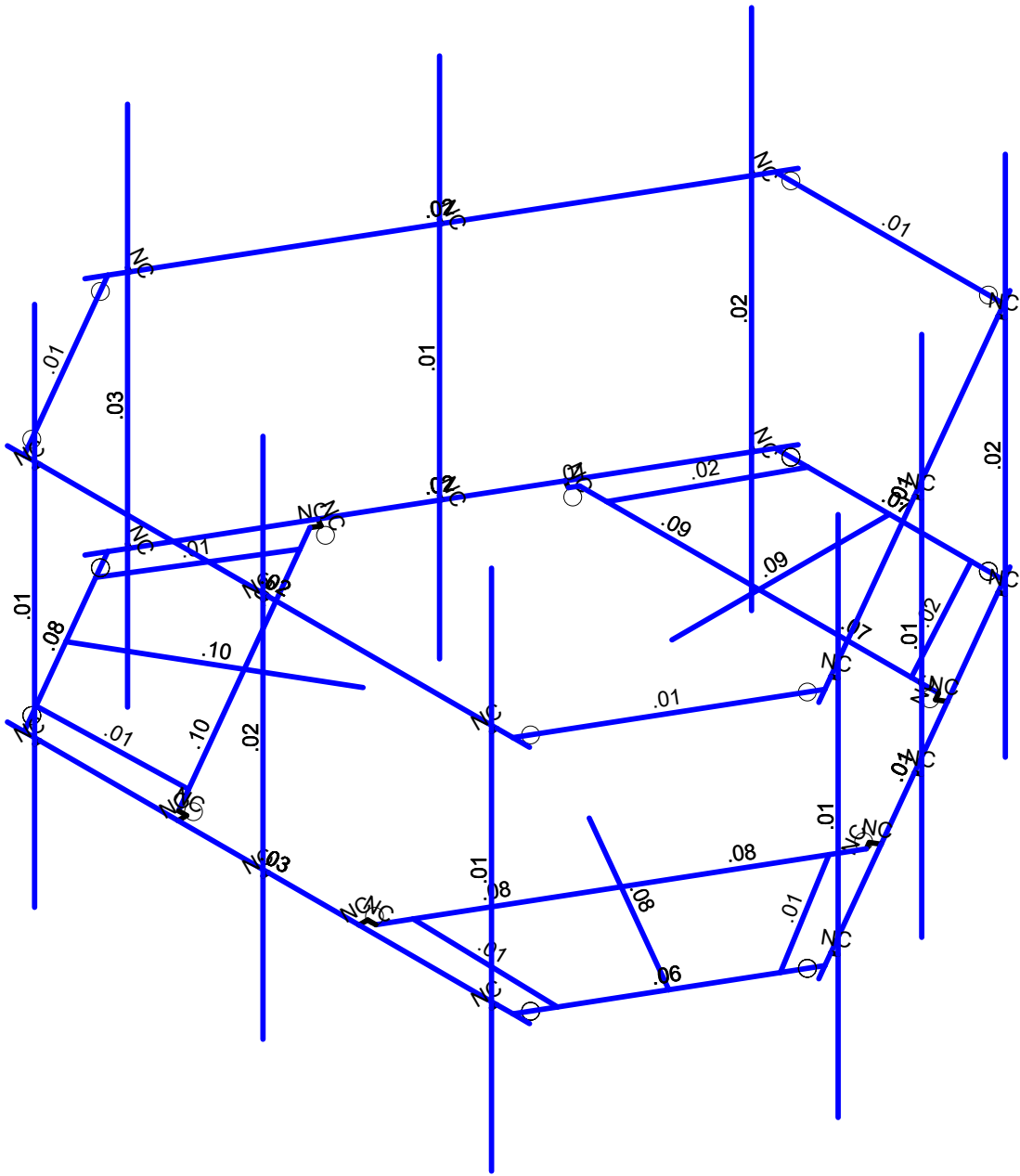

Member Code Checks Displayed  
Results for LC 1, 1.4DL

Infinigy Engineering, PLLC	BOBDL00152B	Bending Check
PSM		Aug 26, 2021 at 5:32 PM
1197-F0001-C		BOBDL00152B_loaded.r3d

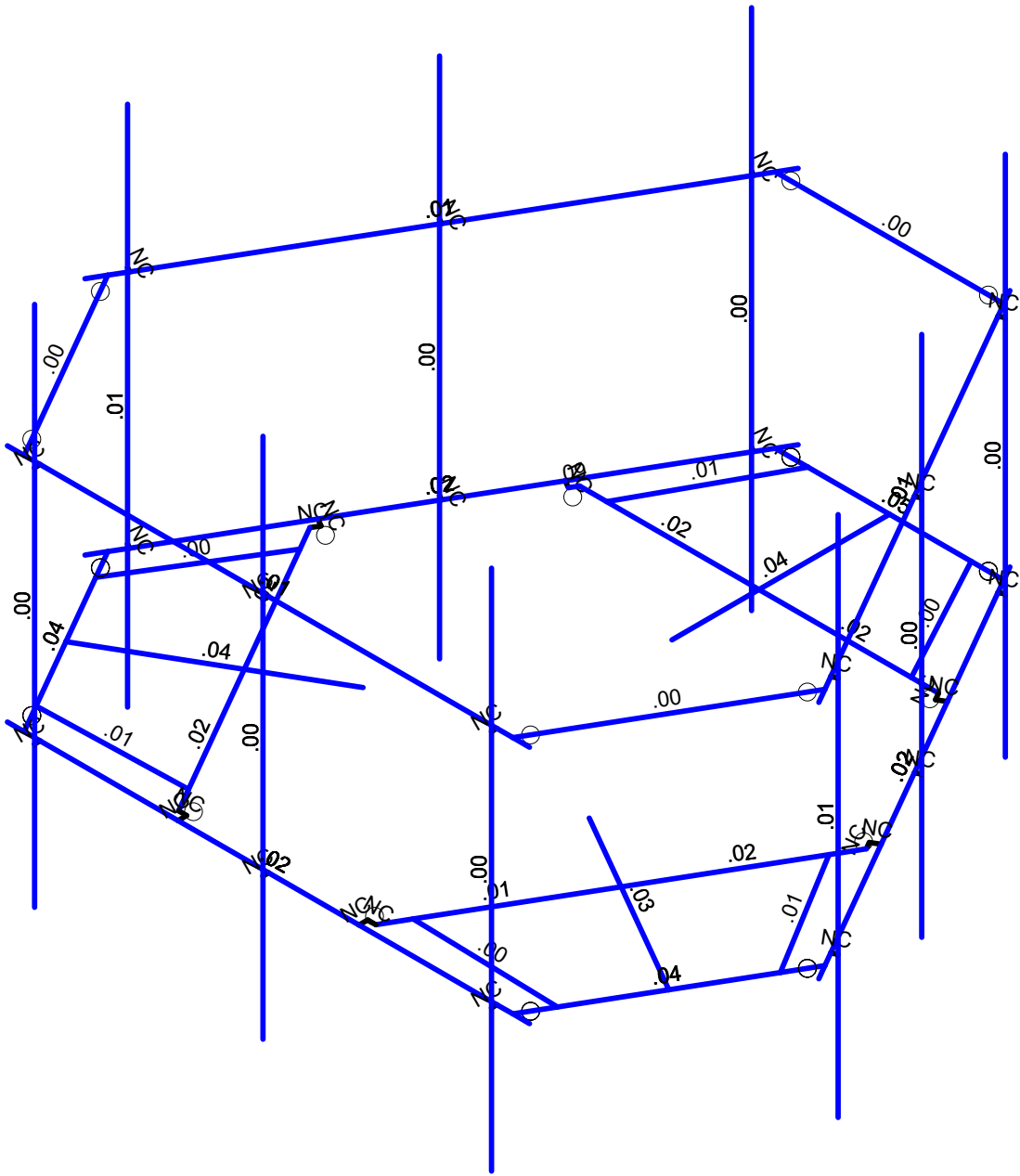
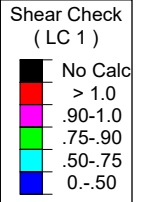
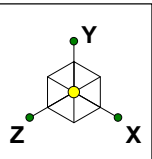

Member Shear Checks Displayed  
Results for LC 1, 1.4DL

Infinigy Engineering, PLLC  
PSM  
1197-F0001-C

BOBDL00152B

Shear Check

Aug 26, 2021 at 5:32 PM

BOBDL00152B\_loaded.r3d

## Program Inputs

PROJECT INFORMATION		
Client:	ATC	
Carrier:	Dish Wireless	
Engineer:	Pradin Suinyal Magar, M.S	

SITE INFORMATION		
Risk Category:	II	
Exposure Category:	B	
Topo Factor Procedure:	Method 1, Category 1	
Site Class:	D - Stiff Soil (Assumed)	
Ground Elevation:	788.41	ft *Rev H

MOUNT INFORMATION		
Mount Type:	Platform	
Num Sectors:	3	
Centerline AGL:	108.00	ft
Tower Height AGL:	150.00	ft

TOPOGRAPHIC DATA		
Topo Feature:	N/A	
Slope Distance:	N/A	ft
Crest Distance:	N/A	ft
Crest Height:	N/A	ft

FACTORS		
Directionality Fact. ( $K_d$ ):	0.950	
Ground Ele. Factor ( $K_e$ ):	0.972	*Rev H Only
Rooftop Speed-Up ( $K_s$ ):	1.000	*Rev H Only
Topographic Factor ( $K_{zt}$ ):	1.000	
Gust Effect Factor ( $G_h$ ):	1.000	

CODE STANDARDS		
Building Code:	2015 IBC	
TIA Standard:	TIA-222-H	
ASCE Standard:	ASCE 7-10	

WIND AND ICE DATA		
Ultimate Wind ( $V_{ult}$ ):	120	mph
Design Wind ( $V$ ):	N/A	mph
Ice Wind ( $V_{ice}$ ):	50	mph
Base Ice Thickness ( $t_i$ ):	2	in
Flat Pressure:	68.765	psf
Round Pressure:	41.259	psf
Ice Wind Pressure:	7.163	psf

SEISMIC DATA		
Short-Period Accel. ( $S_s$ ):	0.180	g
1-Second Accel. ( $S_1$ ):	0.064	g
Short-Period Design ( $S_{DS}$ ):	0.192	
1-Second Design ( $S_{D1}$ ):	0.102	
Short-Period Coeff. ( $F_a$ ):	1.600	
1-Second Coeff. ( $F_v$ ):	2.400	
Amplification Factor ( $A_s$ ):	3.000	
Response Mod. Coeff. ( $R$ ):	2.000	



Infinigy Load Calculator V2.1.7

**Program Inputs**

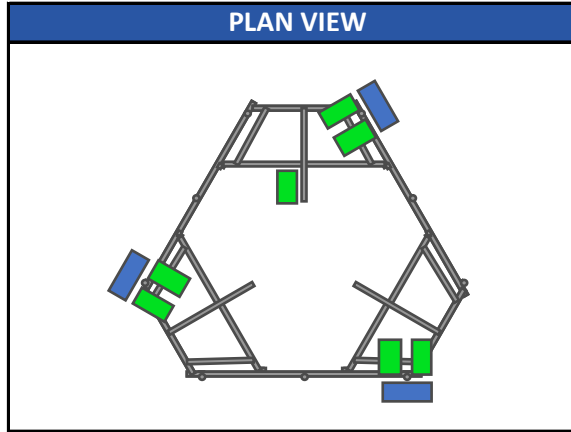
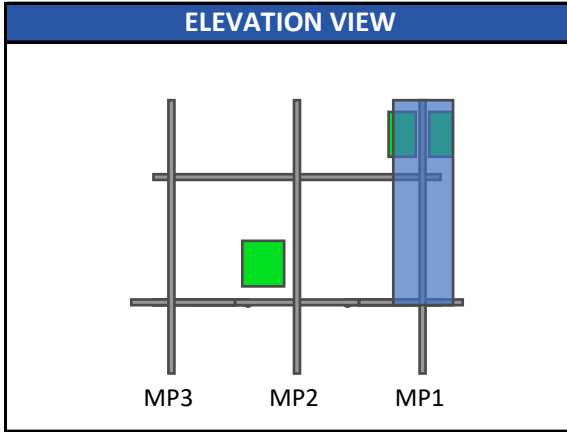

Infinigy Load Calculator V2.1.7

**APPURTENANCE INFORMATION**

Appurtenance Name	Elevation	Qty.	$K_a$	$q_z$ (psf)	$EPA_N$ (ft <sup>2</sup> )	$EPA_T$ (ft <sup>2</sup> )	Wind $F_z$ (lbs)	Wind $F_x$ (lbs)	Weight (lbs)	Seismic F (lbs)	Member ( $\alpha$ sector)
JMA WIRELESS MX08FRO665-21	108.0	3	0.90	34.38	8.01	3.21	247.86	99.33	64.50	18.58	MP1
FUJITSU TA08025-B605	108.0	3	0.90	34.38	1.96	1.19	60.76	36.80	74.95	21.59	MP1
FUJITSU TA08025-B604	108.0	3	0.90	34.38	1.96	1.03	60.76	31.96	63.93	18.41	MP1
RAYCAP RDIDC-9181-PF-48	108.0	1	0.90	34.38	1.87	1.07	57.76	33.01	21.85	6.29	S2

# ASCE 7 Hazards Report

**Address:**  
No Address at This Location

**Standard:** ASCE/SEI 7-10  
**Risk Category:** II  
**Soil Class:** D - Stiff Soil

**Elevation:** 788.41 ft (NAVD 88)  
**Latitude:** 41.855278  
**Longitude:** -72.8925

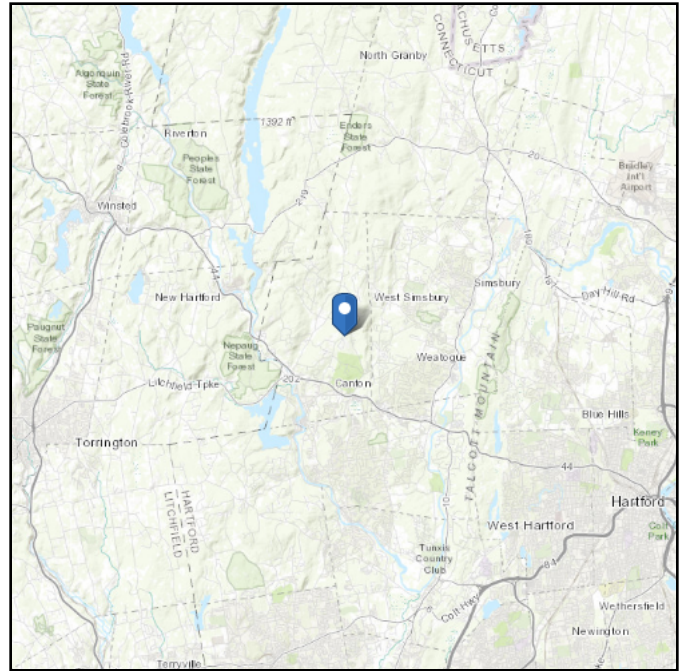

## Wind

### Results:

Wind Speed:	120 mph per Canton City Requirements in WSEL
10-year MRI	76 Vmph
25-year MRI	85 Vmph
50-year MRI	91 Vmph
100-year MRI	97 Vmph

**Data Source:** ASCE/SEI 7-10 Fig. 26.5-1A and Figs. CC-1–CC-4, and Section 26.5.2, incorporating errata of March 12, 2014

Value provided is 3-second gust wind speeds at 33 ft above ground for Exposure C Category, based on linear interpolation between contours. Wind speeds are interpolated in accordance with the 7-10 Standard. Wind speeds correspond to approximately a 7% probability of exceedance in 50 years (annual exceedance probability = 0.00143, MRI = 700 years).

Site is in a hurricane-prone region as defined in ASCE/SEI 7-10 Section 26.2. Glazed openings need not be protected against wind-borne debris.

**Site Soil Class:** D - Stiff Soil

**Results:**

$S_s$ :	0.180	$S_{DS}$ :	0.191
$S_1$ :	0.064	$S_{D1}$ :	0.103
$F_a$ :	1.6	$T_L$ :	6
$F_v$ :	2.4	PGA :	0.09
$S_{MS}$ :	0.287	PGA <sub>M</sub> :	0.143
$S_{M1}$ :	0.155	F <sub>PGA</sub> :	1.6
		$I_e$ :	1

**Seismic Design Category** B

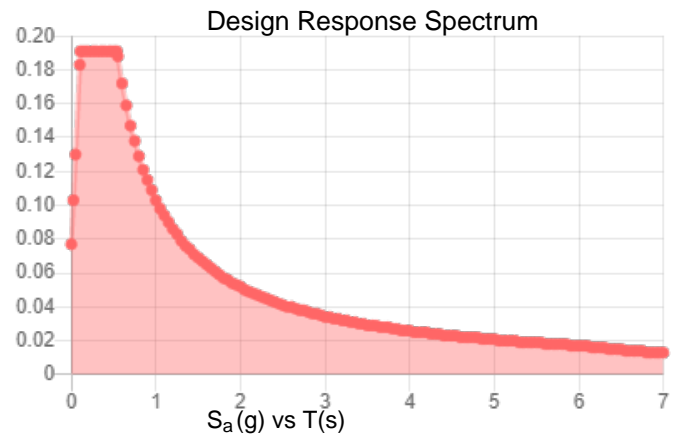
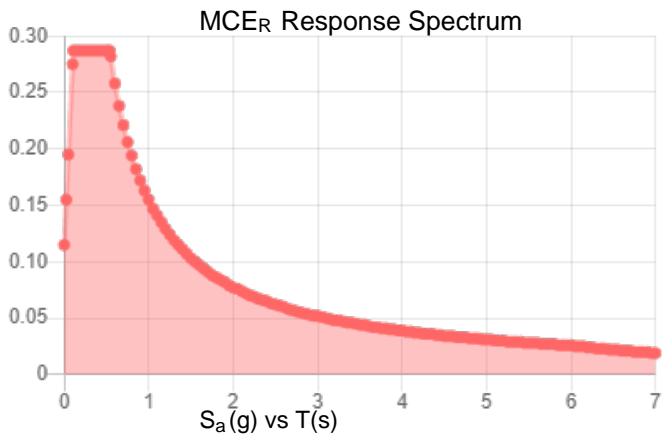

**Data Accessed:**

Thu Aug 26 2021

**Date Source:**

USGS Seismic Design Maps based on ASCE/SEI 7-10, incorporating Supplement 1 and errata of March 31, 2013, and ASCE/SEI 7-10 Table 1.5-2. Additional data for site-specific ground motion procedures in accordance with ASCE/SEI 7-10 Ch. 21 are available from USGS.



## Ice

---

**Results:**

Ice Thickness: 1.00 in.

Concurrent Temperature: 5 F

Gust Speed: 50 mph

**Data Source:** Standard ASCE/SEI 7-10, Figs. 10-2 through 10-8

**Date Accessed:** Thu Aug 26 2021

Ice thicknesses on structures in exposed locations at elevations higher than the surrounding terrain and in valleys and gorges may exceed the mapped values.

Values provided are equivalent radial ice thicknesses due to freezing rain with concurrent 3-second gust speeds, for a 50-year mean recurrence interval, and temperatures concurrent with ice thicknesses due to freezing rain. Thicknesses for ice accretions caused by other sources shall be obtained from local meteorological studies. Ice thicknesses in exposed locations at elevations higher than the surrounding terrain and in valleys and gorges may exceed the mapped values.

---

The ASCE 7 Hazard Tool is provided for your convenience, for informational purposes only, and is provided “as is” and without warranties of any kind. The location data included herein has been obtained from information developed, produced, and maintained by third party providers; or has been extrapolated from maps incorporated in the ASCE 7 standard. While ASCE has made every effort to use data obtained from reliable sources or methodologies, ASCE does not make any representations or warranties as to the accuracy, completeness, reliability, currency, or quality of any data provided herein. Any third-party links provided by this Tool should not be construed as an endorsement, affiliation, relationship, or sponsorship of such third-party content by or from ASCE.

ASCE does not intend, nor should anyone interpret, the results provided by this Tool to replace the sound judgment of a competent professional, having knowledge and experience in the appropriate field(s) of practice, nor to substitute for the standard of care required of such professionals in interpreting and applying the contents of this Tool or the ASCE 7 standard.

In using this Tool, you expressly assume all risks associated with your use. Under no circumstances shall ASCE or its officers, directors, employees, members, affiliates, or agents be liable to you or any other person for any direct, indirect, special, incidental, or consequential damages arising from or related to your use of, or reliance on, the Tool or any information obtained therein. To the fullest extent permitted by law, you agree to release and hold harmless ASCE from any and all liability of any nature arising out of or resulting from any use of data provided by the ASCE 7 Hazard Tool.

**Member Primary Data**

	Label	I Joint	J Joint	K Joint	Rotate(...)	Section/Shape	Type	Design List	Material	Design Rules
1	S3	P1	P3			Square Tubing	Beam	None	A500 GR.C	Typical
2	GA4	P9	P12		270	Grating Angle	Beam	None	A529 Gr. 50	Typical
3	GA3	P10	P11			Grating Angle	Beam	None	A529 Gr. 50	Typical
4	P3	P7	P8			Corner Plates	Beam	None	A1011 36 Ksi	Typical
5	S2	P13	P14			Square Tubing	Beam	None	A500 GR.C	Typical
6	GA2	P20	P23		270	Grating Angle	Beam	None	A529 Gr. 50	Typical
7	GA1	P21	P22			Grating Angle	Beam	None	A529 Gr. 50	Typical
8	P2	P18	P19			Corner Plates	Beam	None	A1011 36 Ksi	Typical
9	S1	P24	P25			Square Tubing	Beam	None	A500 GR.C	Typical
10	GA6	P31	P34		270	Grating Angle	Beam	None	A529 Gr. 50	Typical
11	GA5	P32	P33			Grating Angle	Beam	None	A529 Gr. 50	Typical
12	P1	P29	P30			Corner Plates	Beam	None	A1011 36 Ksi	Typical
13	H1	N43	N44			Face Pipes(3.5x.16)	Beam	None	A500 GR.C	Typical
14	MP1	N66	N60			Antenna Pipes	Beam	None	A500 GR.C	Typical
15	MP3	N63	N57			Antenna Pipes	Beam	None	A500 GR.C	Typical
16	HR1	N67	N68			Handrail	Beam	None	A500 GR.C	Typical
17	CA8	N114A	N113A		180	Handrail Connector	Beam	None	A1011 36 Ksi	Typical
18	CA9	N112A	N111A		180	Handrail Connector	Beam	None	A1011 36 Ksi	Typical
19	CA7	N116A	N115A		180	Handrail Connector	Beam	None	A1011 36 Ksi	Typical
20	M32	N48A	N70A			RIGID	None	None	RIGID	Typical
21	M35	N45	N69A			RIGID	None	None	RIGID	Typical
22	M36	N51	N71A			RIGID	None	None	RIGID	Typical
23	M39A	N54	N72A			RIGID	None	None	RIGID	Typical
24	CA3	P4	N122A			Channel(3.38x2.06)	Beam	None	A1011 36 Ksi	Typical
25	CA4	N124B	P4			Channel(3.38x2.06)	Beam	None	A1011 36 Ksi	Typical
26	CA1	P15	N122B			Channel(3.38x2.06)	Beam	None	A1011 36 Ksi	Typical
27	CA2	N123A	P15			Channel(3.38x2.06)	Beam	None	A1011 36 Ksi	Typical
28	CA5	P26	N125			Channel(3.38x2.06)	Beam	None	A1011 36 Ksi	Typical
29	CA6	N126	P26			Channel(3.38x2.06)	Beam	None	A1011 36 Ksi	Typical
30	M64	N126A	N125A			RIGID	None	None	RIGID	Typical
31	M65	N126	N125A			RIGID	None	None	RIGID	Typical
32	M66	N129	N128			RIGID	None	None	RIGID	Typical
33	M67	N124B	N128			RIGID	None	None	RIGID	Typical
34	M68	N132	N131			RIGID	None	None	RIGID	Typical
35	M69	N123A	N131			RIGID	None	None	RIGID	Typical
36	M70	N133	N132A			RIGID	None	None	RIGID	Typical
37	M71	N122B	N132A			RIGID	None	None	RIGID	Typical
38	M72	N135	N134			RIGID	None	None	RIGID	Typical
39	M73	N125	N134			RIGID	None	None	RIGID	Typical
40	M74	N138	N137			RIGID	None	None	RIGID	Typical
41	M75	N122A	N137			PL 2.375x0.5	None	None	A36 Gr.36	Typical



**Member Primary Data (Continued)**

	Label	I Joint	J Joint	K Joint	Rotate(...)	Section/Shape	Type	Design List	Material	Design Rules
42	MP2	N75	N74			Antenna Pipes	Beam	None	A500 GR.C	Typical
43	M43	N72B	N76			RIGID	None	None	RIGID	Typical
44	M44	N73	N77			RIGID	None	None	RIGID	Typical
45	H3	N81A	N82A			Face Pipes(3.5x.16)	Beam	None	A500 GR.C	Typical
46	MP7	N90	N88			Antenna Pipes	Beam	None	A500 GR.C	Typical
47	MP9	N89	N87			Antenna Pipes	Beam	None	A500 GR.C	Typical
48	HR3	N91	N92			Handrail	Beam	None	A500 GR.C	Typical
49	M52	N84	N94			RIGID	None	None	RIGID	Typical
50	M53	N83A	N93			RIGID	None	None	RIGID	Typical
51	M54	N85	N95			RIGID	None	None	RIGID	Typical
52	M55	N86	N96			RIGID	None	None	RIGID	Typical
53	H2	N109	N110			Face Pipes(3.5x.16)	Beam	None	A500 GR.C	Typical
54	MP4	N118	N116			Antenna Pipes	Beam	None	A500 GR.C	Typical
55	MP6	N117	N115			Antenna Pipes	Beam	None	A500 GR.C	Typical
56	HR2	N119	N120			Handrail	Beam	None	A500 GR.C	Typical
57	M66A	N112	N122			RIGID	None	None	RIGID	Typical
58	M67A	N111	N121			RIGID	None	None	RIGID	Typical
59	M68A	N113	N123			RIGID	None	None	RIGID	Typical
60	M69A	N114	N124			RIGID	None	None	RIGID	Typical
61	MP8	N132B	N131A			Antenna Pipes	Beam	None	A500 GR.C	Typical
62	M68B	N129B	N133B			RIGID	None	None	RIGID	Typical
63	M69B	N130A	N134A			RIGID	None	None	RIGID	Typical
64	MP5	N138A	N137A			Antenna Pipes	Beam	None	A500 GR.C	Typical
65	M71B	N135A	N139			RIGID	None	None	RIGID	Typical
66	M72B	N136	N140			RIGID	None	None	RIGID	Typical

**Hot Rolled Steel Design Parameters**

	Label	Shape	Lengt...	Lbby[in]	Lbzz[in]	Lcomp t...	Lcomp b...	L-tor...	Kyy	Kzz	Cb	Func...
1	S3	Square Tubing	40			Lbby						Late...
2	GA4	Grating Angle	27.295			Lbby						Late...
3	GA3	Grating Angle	27.295			Lbby						Late...
4	P3	Corner Plates	42			Lbby						Late...
5	S2	Square Tubing	40			Lbby						Late...
6	GA2	Grating Angle	27.295			Lbby						Late...
7	GA1	Grating Angle	27.295			Lbby						Late...
8	P2	Corner Plates	42			Lbby						Late...
9	S1	Square Tubing	40			Lbby						Late...
10	GA6	Grating Angle	27.295			Lbby						Late...
11	GA5	Grating Angle	27.295			Lbby						Late...
12	P1	Corner Plates	42			Lbby						Late...
13	H1	Face Pipes(3.5x.16)	96			Lbby						Late...

**Hot Rolled Steel Design Parameters (Continued)**

	Label	Shape	Lengt...	Lbby[in]	Lbzz[in]	Lcomp t...	Lcomp b...	L-tor...	Kyy	Kzz	Cb	Func...
14	MP1	Antenna Pipes	96			Lbyy						Late...
15	MP3	Antenna Pipes	96			Lbyy						Late...
16	HR1	Handrail	96			Lbyy						Late...
17	CA8	Handrail Connector	42			Lbyy						Late...
18	CA9	Handrail Connector	42			Lbyy						Late...
19	CA7	Handrail Connector	42			Lbyy						Late...
20	CA3	Channel(3.38x2.06)	33			Lbyy						Late...
21	CA4	Channel(3.38x2.06)	33			Lbyy						Late...
22	CA1	Channel(3.38x2.06)	33			Lbyy						Late...
23	CA2	Channel(3.38x2.06)	33			Lbyy						Late...
24	CA5	Channel(3.38x2.06)	33			Lbyy						Late...
25	CA6	Channel(3.38x2.06)	33			Lbyy						Late...
26	M75	PL 2.375x0.5	1.5			Lbyy						Late...
27	MP2	Antenna Pipes	96			Lbyy						Late...
28	H3	Face Pipes(3.5x.16)	96			Lbyy						Late...
29	MP7	Antenna Pipes	96			Lbyy						Late...
30	MP9	Antenna Pipes	96			Lbyy						Late...
31	HR3	Handrail	96			Lbyy						Late...
32	H2	Face Pipes(3.5x.16)	96			Lbyy						Late...
33	MP4	Antenna Pipes	96			Lbyy						Late...
34	MP6	Antenna Pipes	96			Lbyy						Late...
35	HR2	Handrail	96			Lbyy						Late...
36	MP8	Antenna Pipes	96			Lbyy						Late...
37	MP5	Antenna Pipes	96			Lbyy						Late...

**Member Advanced Data**

	Label	I Release	J Release	I Offset[in]	J Offset[in]	T/C Only	Physical Defl Ra..	Analysis ...	Inactive	Seismi...
1	S3						Yes			None
2	GA4						Yes			None
3	GA3						Yes			None
4	P3	BenPIN	BenPIN				Yes	Default		None
5	S2						Yes			None
6	GA2						Yes			None
7	GA1						Yes			None
8	P2	BenPIN	BenPIN				Yes	Default		None
9	S1						Yes	Default		None
10	GA6						Yes			None
11	GA5						Yes			None
12	P1	BenPIN	BenPIN				Yes	Default		None
13	H1						Yes			None
14	MP1						Yes	+y+3		None

**Member Advanced Data (Continued)**

	Label	I Release	J Release	I Offset[in]	J Offset[in]	T/C Only	Physical	Defl Ra..	Analysis ...	Inactive	Seismi...
15	MP3						Yes		+y+3		None
16	HR1						Yes				None
17	CA8	00000X	00000X				Yes				None
18	CA9	00000X	00000X				Yes				None
19	CA7	00000X	00000X				Yes	Default			None
20	M32						Yes	** NA **			None
21	M35						Yes	** NA **			None
22	M36						Yes	** NA **			None
23	M39A						Yes	** NA **			None
24	CA3						Yes	Default			None
25	CA4						Yes	Default			None
26	CA1						Yes	Default			None
27	CA2						Yes	Default			None
28	CA5						Yes	Default			None
29	CA6						Yes	Default			None
30	M64	BenPIN					Yes	** NA **			None
31	M65						Yes	** NA **			None
32	M66	BenPIN					Yes	** NA **			None
33	M67						Yes	** NA **			None
34	M68	BenPIN					Yes	** NA **			None
35	M69						Yes	** NA **			None
36	M70	BenPIN					Yes	** NA **			None
37	M71						Yes	** NA **			None
38	M72	BenPIN					Yes	** NA **			None
39	M73						Yes	** NA **			None
40	M74	BenPIN					Yes	** NA **			None
41	M75						Yes	** NA **			None
42	MP2						Yes		+y+3		None
43	M43						Yes	** NA **			None
44	M44						Yes	** NA **			None
45	H3						Yes				None
46	MP7						Yes		+y+3		None
47	MP9						Yes		+y+3		None
48	HR3						Yes				None
49	M52						Yes	** NA **			None
50	M53						Yes	** NA **			None
51	M54						Yes	** NA **			None
52	M55						Yes	** NA **			None
53	H2						Yes				None
54	MP4						Yes		+y+3		None
55	MP6						Yes		+y+3		None
56	HR2						Yes				None

**Member Advanced Data (Continued)**

	Label	I Release	J Release	I Offset[in]	J Offset[in]	T/C Only	Physical Defl Ra..	Analysis ...	Inactive	Seismi...
57	M66A						Yes ** NA **			None
58	M67A						Yes ** NA **			None
59	M68A						Yes ** NA **			None
60	M69A						Yes ** NA **			None
61	MP8						Yes	+y+3		None
62	M68B						Yes ** NA **			None
63	M69B						Yes ** NA **			None
64	MP5						Yes	+y+3		None
65	M71B						Yes ** NA **			None
66	M72B						Yes ** NA **			None

**Material Takeoff**

	Material	Size	Pieces	Length[in]	Weight[LB]
1	General				
2	RIGID		29	35.1	0
3	Total General		29	35.1	0
4					
5	Hot Rolled Steel				
6	A1011 36 Ksi	C3.38x2.06x0.25	6	198	98.255
7	A1011 36 Ksi	PL6.5x0.375	3	126	87.09
8	A1011 36 Ksi	L6.6x4.46x0.25	3	126	96.558
9	A36 Gr.36	PL 2.375x0.5	1	1.5	.505
10	A500 GR.C	2.88x0.120	3	288	84.974
11	A500 GR.C	HSS4X4X6	3	120	162.653
12	A500 GR.C	Pipe3.5x0.165	3	288	141.202
13	A500 GR.C	PIPE 2.5	9	864	394.45
14	A529 Gr. 50	L2x2x4	6	163.8	43.838
15	Total HR Steel		37	2175.3	1109.525

**Hot Rolled Steel Section Sets**

	Label	Shape	Type	Design List	Material	Design... A [in2]	Iyy [in...lzz [in... J [in4]
1	Corner Plates	PL6.5x0.375	Beam	None	A1011 ...	Typical 2.438	.029 8.582 .11
2	6"x0.37" Plate	Plate 6x.37	Beam	None	A1011 ...	Typical 2.22	.025 6.66 .097
3	Grating Angle	L2x2x4	Beam	None	A529 G...	Typical .944	.346 .346 .021
4	Face Pipes(3.5x.1...	Pipe3.5x0.165	Beam	None	A500 G...	Typical 1.729	2.409 2.409 4.819
5	Antenna Pipes	PIPE 2.5	Beam	None	A500 G...	Typical 1.61	1.45 1.45 2.89
6	Channel(3.38x2.06)	C3.38x2.06x0.25	Beam	None	A1011 ...	Typical 1.75	.715 3.026 .034
7	Square Tubing	HSS4X4X6	Beam	None	A500 G...	Typical 4.78	10.3 10.3 17.5
8	Handrail Connector	L6.6x4.46x0.25	Beam	None	A1011 ...	Typical 2.703	4.759 12.473 .055



**Hot Rolled Steel Section Sets (Continued)**

	Label	Shape	Type	Design List	Material	Design... A [in2]	Iyy [in...lzz [in... J [in4]
9	Handrail	2.88x0.120	Beam	None	A500 G...	Typical 1.04	.993 .993 1.985

**Basic Load Cases**

	BLC Description	Category	X Gr...	Y Gr...	Z Gr...	Joint	Point	Distributed	Area(Memb...	Surface(Plate/Wall)
1	Self Weight	DL		-1			13		3	
2	Wind Load AZI 0	WLZ					26			
3	Wind Load AZI 30	None					26			
4	Wind Load AZI 60	None					26			
5	Wind Load AZI 90	WLX					26			
6	Wind Load AZI 1...	None					26			
7	Wind Load AZI 1...	None					26			
8	Wind Load AZI 1...	None					26			
9	Wind Load AZI 2...	None					26			
10	Wind Load AZI 2...	None					26			
11	Wind Load AZI 2...	None					26			
12	Wind Load AZI 3...	None					26			
13	Wind Load AZI 3...	None					26			
14	Distr. Wind Load Z	WLZ						66		
15	Distr. Wind Load X	WLX						66		
16	Ice Weight	OL1					13	66	3	
17	Ice Wind Load A...	OL2					26			
18	Ice Wind Load A...	None					26			
19	Ice Wind Load A...	None					26			
20	Ice Wind Load A...	OL3					26			
21	Ice Wind Load A...	None					26			
22	Ice Wind Load A...	None					26			
23	Ice Wind Load A...	None					26			
24	Ice Wind Load A...	None					26			
25	Ice Wind Load A...	None					26			
26	Ice Wind Load A...	None					26			
27	Ice Wind Load A...	None					26			
28	Ice Wind Load A...	None					26			
29	Distr. Ice Wind L...	OL2						66		
30	Distr. Ice Wind L...	OL3						66		
31	Seismic Load Z	ELZ			-.288		13			
32	Seismic Load X	ELX	-.288				13			
33	Service Live Loa...	LL					3			
34	Maintenance Loa...	LL					1			
35	Maintenance Loa...	LL					1			
36	Maintenance Loa...	LL					1			
37	Maintenance Loa...	LL					1			



### Basic Load Cases (Continued)

	BLC Description	Category	X Gr...	Y Gr...	Z Gr...	Joint	Point	Distributed	Area(Memb...	Surface(Plate/Wall)
38	Maintenance Loa...	LL				1				
39	Maintenance Loa...	LL				1				
40	Maintenance Loa...	LL				1				
41	Maintenance Loa...	LL				1				
42	Maintenance Loa...	LL				1				
43	BLC 1 Transient ...	None						9		
44	BLC 16 Transien...	None						9		

### Load Combinations

	Description	S...	P...	S...B...	Fa...B...	Fa...B...	Fa...B...	Fa...B...	Fa...B...	Fa...B...	Fa...B...	Fa...B...	Fa...B...	Fa...B...	Fa...B...	Fa...B...
1	1.4DL	Y...Y		1	1.4											
2	1.2DL + 1WL AZI 0	Y...Y		1	1.2	2	1	14	1	15						
3	1.2DL + 1WL AZI 30	Y...Y		1	1.2	3	1	14	.866	15	.5					
4	1.2DL + 1WL AZI 60	Y...Y		1	1.2	4	1	14	.5	15	.866					
5	1.2DL + 1WL AZI 90	Y...Y		1	1.2	5	1	14		15	1					
6	1.2DL + 1WL AZI 120	Y...Y		1	1.2	6	1	14	-.5	15	.866					
7	1.2DL + 1WL AZI 150	Y...Y		1	1.2	7	1	14	-.8...	15	.5					
8	1.2DL + 1WL AZI 180	Y...Y		1	1.2	8	1	14	-1	15						
9	1.2DL + 1WL AZI 210	Y...Y		1	1.2	9	1	14	-.8...	15	-.5					
10	1.2DL + 1WL AZI 240	Y...Y		1	1.2	10	1	14	-.5	15	-.8...					
11	1.2DL + 1WL AZI 270	Y...Y		1	1.2	11	1	14		15	-1					
12	1.2DL + 1WL AZI 300	Y...Y		1	1.2	12	1	14	.5	15	-.8...					
13	1.2DL + 1WL AZI 330	Y...Y		1	1.2	13	1	14	.866	15	-.5					
14	0.9DL + 1WL AZI 0	Y...Y		1	.9	2	1	14	1	15						
15	0.9DL + 1WL AZI 30	Y...Y		1	.9	3	1	14	.866	15	.5					
16	0.9DL + 1WL AZI 60	Y...Y		1	.9	4	1	14	.5	15	.866					
17	0.9DL + 1WL AZI 90	Y...Y		1	.9	5	1	14		15	1					
18	0.9DL + 1WL AZI 120	Y...Y		1	.9	6	1	14	-.5	15	.866					
19	0.9DL + 1WL AZI 150	Y...Y		1	.9	7	1	14	-.8...	15	.5					
20	0.9DL + 1WL AZI 180	Y...Y		1	.9	8	1	14	-1	15						
21	0.9DL + 1WL AZI 210	Y...Y		1	.9	9	1	14	-.8...	15	-.5					
22	0.9DL + 1WL AZI 240	Y...Y		1	.9	10	1	14	-.5	15	-.8...					
23	0.9DL + 1WL AZI 270	Y...Y		1	.9	11	1	14		15	-1					
24	0.9DL + 1WL AZI 300	Y...Y		1	.9	12	1	14	.5	15	-.8...					
25	0.9DL + 1WL AZI 330	Y...Y		1	.9	13	1	14	.866	15	-.5					
26	1.2D + 1.0Di	Y...Y		1	1.2	16	1									
27	1.2D + 1.0Di +1.0Wi AZI 0	Y...Y		1	1.2	16	1	17	1	29	1	30				
28	1.2D + 1.0Di +1.0Wi AZI 30	Y...Y		1	1.2	16	1	18	1	29	.866	30	.5			
29	1.2D + 1.0Di +1.0Wi AZI 60	Y...Y		1	1.2	16	1	19	1	29	.5	30	.866			
30	1.2D + 1.0Di +1.0Wi AZI 90	Y...Y		1	1.2	16	1	20	1	29		30	1			
31	1.2D + 1.0Di +1.0Wi AZI 120	Y...Y		1	1.2	16	1	21	1	29	-.5	30	.866			





**Load Combinations (Continued)**

	Description	S...	P...	S...B...	Fa...B...	Fa...B...	Fa...B...	Fa...B...	Fa...B...	Fa...B...	Fa...B...	Fa...B...	Fa...B...	Fa...B...	Fa...B...	Fa...B...	Fa...B...	Fa...B...	Fa...B...
32	1.2D + 1.0Di + 1.0Wi AZI 150	Y...	Y	1	1.2	16	1	22	1	29	-8...	30	.5						
33	1.2D + 1.0Di + 1.0Wi AZI 180	Y...	Y	1	1.2	16	1	23	1	29	-1	30							
34	1.2D + 1.0Di + 1.0Wi AZI 210	Y...	Y	1	1.2	16	1	24	1	29	-8...	30	-.5						
35	1.2D + 1.0Di + 1.0Wi AZI 240	Y...	Y	1	1.2	16	1	25	1	29	-.5	30	-8...						
36	1.2D + 1.0Di + 1.0Wi AZI 270	Y...	Y	1	1.2	16	1	26	1	29		30	-1						
37	1.2D + 1.0Di + 1.0Wi AZI 300	Y...	Y	1	1.2	16	1	27	1	29	.5	30	-8...						
38	1.2D + 1.0Di + 1.0Wi AZI 330	Y...	Y	1	1.2	16	1	28	1	29	.866	30	-.5						
39	(1.2 + 0.2Sds)DL + 1.0E AZI 0	Y...	Y	1	1.2	.31	1	32											
40	(1.2 + 0.2Sds)DL + 1.0E AZI 30	Y...	Y	1	1.2	.31	.866	32	.5										
41	(1.2 + 0.2Sds)DL + 1.0E AZI 60	Y...	Y	1	1.2	.31	.5	32	.866										
42	(1.2 + 0.2Sds)DL + 1.0E AZI 90	Y...	Y	1	1.2	.31		32	1										
43	(1.2 + 0.2Sds)DL + 1.0E AZI 1..	Y...	Y	1	1.2	.31	-.5	32	.866										
44	(1.2 + 0.2Sds)DL + 1.0E AZI 1..	Y...	Y	1	1.2	.31	-8...	32	.5										
45	(1.2 + 0.2Sds)DL + 1.0E AZI 1..	Y...	Y	1	1.2	.31	-1	32											
46	(1.2 + 0.2Sds)DL + 1.0E AZI 2..	Y...	Y	1	1.2	.31	-8...	32	-.5										
47	(1.2 + 0.2Sds)DL + 1.0E AZI 2..	Y...	Y	1	1.2	.31	-.5	32	-8...										
48	(1.2 + 0.2Sds)DL + 1.0E AZI 2..	Y...	Y	1	1.2	.31		32	-1										
49	(1.2 + 0.2Sds)DL + 1.0E AZI 3..	Y...	Y	1	1.2	.31	.5	32	-8...										
50	(1.2 + 0.2Sds)DL + 1.0E AZI 3..	Y...	Y	1	1.2	.31	.866	32	-.5										
51	(0.9 - 0.2Sds)DL + 1.0E AZI 0	Y...	Y	1	.862	31	1	32											
52	(0.9 - 0.2Sds)DL + 1.0E AZI 30	Y...	Y	1	.862	31	.866	32	.5										
53	(0.9 - 0.2Sds)DL + 1.0E AZI 60	Y...	Y	1	.862	31	.5	32	.866										
54	(0.9 - 0.2Sds)DL + 1.0E AZI 90	Y...	Y	1	.862	31		32	1										
55	(0.9 - 0.2Sds)DL + 1.0E AZI 1..	Y...	Y	1	.862	31	-.5	32	.866										
56	(0.9 - 0.2Sds)DL + 1.0E AZI 1..	Y...	Y	1	.862	31	-8...	32	.5										
57	(0.9 - 0.2Sds)DL + 1.0E AZI 1..	Y...	Y	1	.862	31	-1	32											
58	(0.9 - 0.2Sds)DL + 1.0E AZI 2..	Y...	Y	1	.862	31	-8...	32	-.5										
59	(0.9 - 0.2Sds)DL + 1.0E AZI 2..	Y...	Y	1	.862	31	-.5	32	-8...										
60	(0.9 - 0.2Sds)DL + 1.0E AZI 2..	Y...	Y	1	.862	31		32	-1										
61	(0.9 - 0.2Sds)DL + 1.0E AZI 3..	Y...	Y	1	.862	31	.5	32	-8...										
62	(0.9 - 0.2Sds)DL + 1.0E AZI 3..	Y...	Y	1	.862	31	.866	32	-.5										
63	1.0DL + 1.5LL + 1.0SWL (60 ...	Y...	Y	1	1	2	.25	14	.25	15		33	1.5						
64	1.0DL + 1.5LL + 1.0SWL (60 ...	Y...	Y	1	1	3	.25	14	.216	15	.125	33	1.5						
65	1.0DL + 1.5LL + 1.0SWL (60 ...	Y...	Y	1	1	4	.25	14	.125	15	.216	33	1.5						
66	1.0DL + 1.5LL + 1.0SWL (60 ...	Y...	Y	1	1	5	.25	14		15	.25	33	1.5						
67	1.0DL + 1.5LL + 1.0SWL (60 ...	Y...	Y	1	1	6	.25	14	-.1...	15	.216	33	1.5						
68	1.0DL + 1.5LL + 1.0SWL (60 ...	Y...	Y	1	1	7	.25	14	-.2...	15	.125	33	1.5						
69	1.0DL + 1.5LL + 1.0SWL (60 ...	Y...	Y	1	1	8	.25	14	-.25	15		33	1.5						
70	1.0DL + 1.5LL + 1.0SWL (60 ...	Y...	Y	1	1	9	.25	14	-.2...	15	-.1...	33	1.5						
71	1.0DL + 1.5LL + 1.0SWL (60 ...	Y...	Y	1	1	10	.25	14	-.1...	15	-.2...	33	1.5						
72	1.0DL + 1.5LL + 1.0SWL (60 ...	Y...	Y	1	1	11	.25	14		15	-.25	33	1.5						
73	1.0DL + 1.5LL + 1.0SWL (60 ...	Y...	Y	1	1	12	.25	14	.125	15	-.2...	33	1.5						

**Load Combinations (Continued)**

Description	S...	P...	S...B...	Fa...B...	Fa...B...	Fa...B...	Fa...B...	Fa...B...	Fa...B...	Fa...B...	Fa...B...	Fa...B...	Fa...B...	Fa...B...	Fa...B...	Fa...B...	Fa...B...	Fa...B...
74	1.0DL + 1.5LL + 1.0SWL (60 ...	Y...	Y	1	1	13	.25	14	.216	15	-1...	33	1.5					
75	1.2DL + 1.5LL	Y...	Y	1	1.2	33	1.5											
76	1.2DL + 1.5LM-MP1 + 1SWL (...	Y...	Y	1	1.2	34	1.5	2	.063	14	.063	15						
77	1.2DL + 1.5LM-MP1 + 1SWL (...	Y...	Y	1	1.2	34	1.5	3	.063	14	.054	15	.031					
78	1.2DL + 1.5LM-MP1 + 1SWL (...	Y...	Y	1	1.2	34	1.5	4	.063	14	.031	15	.054					
79	1.2DL + 1.5LM-MP1 + 1SWL (...	Y...	Y	1	1.2	34	1.5	5	.063	14		15	.063					
80	1.2DL + 1.5LM-MP1 + 1SWL (...	Y...	Y	1	1.2	34	1.5	6	.063	14	-0...	15	.054					
81	1.2DL + 1.5LM-MP1 + 1SWL (...	Y...	Y	1	1.2	34	1.5	7	.063	14	-0...	15	.031					
82	1.2DL + 1.5LM-MP1 + 1SWL (...	Y...	Y	1	1.2	34	1.5	8	.063	14	-0...	15						
83	1.2DL + 1.5LM-MP1 + 1SWL (...	Y...	Y	1	1.2	34	1.5	9	.063	14	-0...	15	-0...					
84	1.2DL + 1.5LM-MP1 + 1SWL (...	Y...	Y	1	1.2	34	1.5	10	.063	14	-0...	15	-0...					
85	1.2DL + 1.5LM-MP1 + 1SWL (...	Y...	Y	1	1.2	34	1.5	11	.063	14		15	-0...					
86	1.2DL + 1.5LM-MP1 + 1SWL (...	Y...	Y	1	1.2	34	1.5	12	.063	14	.031	15	-0...					
87	1.2DL + 1.5LM-MP1 + 1SWL (...	Y...	Y	1	1.2	34	1.5	13	.063	14	.054	15	-0...					
88	1.2DL + 1.5LM-MP2 + 1SWL (...	Y...	Y	1	1.2	35	1.5	2	.063	14	.063	15						
89	1.2DL + 1.5LM-MP2 + 1SWL (...	Y...	Y	1	1.2	35	1.5	3	.063	14	.054	15	.031					
90	1.2DL + 1.5LM-MP2 + 1SWL (...	Y...	Y	1	1.2	35	1.5	4	.063	14	.031	15	.054					
91	1.2DL + 1.5LM-MP2 + 1SWL (...	Y...	Y	1	1.2	35	1.5	5	.063	14		15	.063					
92	1.2DL + 1.5LM-MP2 + 1SWL (...	Y...	Y	1	1.2	35	1.5	6	.063	14	-0...	15	.054					
93	1.2DL + 1.5LM-MP2 + 1SWL (...	Y...	Y	1	1.2	35	1.5	7	.063	14	-0...	15	.031					
94	1.2DL + 1.5LM-MP2 + 1SWL (...	Y...	Y	1	1.2	35	1.5	8	.063	14	-0...	15						
95	1.2DL + 1.5LM-MP2 + 1SWL (...	Y...	Y	1	1.2	35	1.5	9	.063	14	-0...	15	-0...					
96	1.2DL + 1.5LM-MP2 + 1SWL (...	Y...	Y	1	1.2	35	1.5	10	.063	14	-0...	15	-0...					
97	1.2DL + 1.5LM-MP2 + 1SWL (...	Y...	Y	1	1.2	35	1.5	11	.063	14		15	-0...					
98	1.2DL + 1.5LM-MP2 + 1SWL (...	Y...	Y	1	1.2	35	1.5	12	.063	14	.031	15	-0...					
99	1.2DL + 1.5LM-MP2 + 1SWL (...	Y...	Y	1	1.2	35	1.5	13	.063	14	.054	15	-0...					
100	1.2DL + 1.5LM-MP3 + 1SWL (...	Y...	Y	1	1.2	36	1.5	2	.063	14	.063	15						
101	1.2DL + 1.5LM-MP3 + 1SWL (...	Y...	Y	1	1.2	36	1.5	3	.063	14	.054	15	.031					
102	1.2DL + 1.5LM-MP3 + 1SWL (...	Y...	Y	1	1.2	36	1.5	4	.063	14	.031	15	.054					
103	1.2DL + 1.5LM-MP3 + 1SWL (...	Y...	Y	1	1.2	36	1.5	5	.063	14		15	.063					
104	1.2DL + 1.5LM-MP3 + 1SWL (...	Y...	Y	1	1.2	36	1.5	6	.063	14	-0...	15	.054					
105	1.2DL + 1.5LM-MP3 + 1SWL (...	Y...	Y	1	1.2	36	1.5	7	.063	14	-0...	15	.031					
106	1.2DL + 1.5LM-MP3 + 1SWL (...	Y...	Y	1	1.2	36	1.5	8	.063	14	-0...	15						
107	1.2DL + 1.5LM-MP3 + 1SWL (...	Y...	Y	1	1.2	36	1.5	9	.063	14	-0...	15	-0...					
108	1.2DL + 1.5LM-MP3 + 1SWL (...	Y...	Y	1	1.2	36	1.5	10	.063	14	-0...	15	-0...					
109	1.2DL + 1.5LM-MP3 + 1SWL (...	Y...	Y	1	1.2	36	1.5	11	.063	14		15	-0...					
110	1.2DL + 1.5LM-MP3 + 1SWL (...	Y...	Y	1	1.2	36	1.5	12	.063	14	.031	15	-0...					
111	1.2DL + 1.5LM-MP3 + 1SWL (...	Y...	Y	1	1.2	36	1.5	13	.063	14	.054	15	-0...					
112	1.2DL + 1.5LM-MP4 + 1SWL (...	Y...	Y	1	1.2	37	1.5	2	.063	14	.063	15						
113	1.2DL + 1.5LM-MP4 + 1SWL (...	Y...	Y	1	1.2	37	1.5	3	.063	14	.054	15	.031					
114	1.2DL + 1.5LM-MP4 + 1SWL (...	Y...	Y	1	1.2	37	1.5	4	.063	14	.031	15	.054					
115	1.2DL + 1.5LM-MP4 + 1SWL (...	Y...	Y	1	1.2	37	1.5	5	.063	14		15	.063					



**Load Combinations (Continued)**

	Description	S...	P...	S...B...	Fa...B...	Fa...B...	Fa...B...	Fa...B...	Fa...B...	Fa...B...	Fa...B...	Fa...B...	Fa...B...	Fa...B...	Fa...B...	Fa...B...	Fa...B...	Fa...B...	Fa...B...
116	1.2DL + 1.5LM-MP4 + 1SWL (...Y...)	Y		1	1.2	37	1.5	6	.063	14	-0...	15	.054						
117	1.2DL + 1.5LM-MP4 + 1SWL (...Y...)	Y		1	1.2	37	1.5	7	.063	14	-0...	15	.031						
118	1.2DL + 1.5LM-MP4 + 1SWL (...Y...)	Y		1	1.2	37	1.5	8	.063	14	-0...	15							
119	1.2DL + 1.5LM-MP4 + 1SWL (...Y...)	Y		1	1.2	37	1.5	9	.063	14	-0...	15	-0...						
120	1.2DL + 1.5LM-MP4 + 1SWL (...Y...)	Y		1	1.2	37	1.5	10	.063	14	-0...	15	-0...						
121	1.2DL + 1.5LM-MP4 + 1SWL (...Y...)	Y		1	1.2	37	1.5	11	.063	14		15	-0...						
122	1.2DL + 1.5LM-MP4 + 1SWL (...Y...)	Y		1	1.2	37	1.5	12	.063	14	.031	15	-0...						
123	1.2DL + 1.5LM-MP4 + 1SWL (...Y...)	Y		1	1.2	37	1.5	13	.063	14	.054	15	-0...						
124	1.2DL + 1.5LM-MP5 + 1SWL (...Y...)	Y		1	1.2	38	1.5	2	.063	14	.063	15							
125	1.2DL + 1.5LM-MP5 + 1SWL (...Y...)	Y		1	1.2	38	1.5	3	.063	14	.054	15	.031						
126	1.2DL + 1.5LM-MP5 + 1SWL (...Y...)	Y		1	1.2	38	1.5	4	.063	14	.031	15	.054						
127	1.2DL + 1.5LM-MP5 + 1SWL (...Y...)	Y		1	1.2	38	1.5	5	.063	14		15	.063						
128	1.2DL + 1.5LM-MP5 + 1SWL (...Y...)	Y		1	1.2	38	1.5	6	.063	14	-0...	15	.054						
129	1.2DL + 1.5LM-MP5 + 1SWL (...Y...)	Y		1	1.2	38	1.5	7	.063	14	-0...	15	.031						
130	1.2DL + 1.5LM-MP5 + 1SWL (...Y...)	Y		1	1.2	38	1.5	8	.063	14	-0...	15							
131	1.2DL + 1.5LM-MP5 + 1SWL (...Y...)	Y		1	1.2	38	1.5	9	.063	14	-0...	15	-0...						
132	1.2DL + 1.5LM-MP5 + 1SWL (...Y...)	Y		1	1.2	38	1.5	10	.063	14	-0...	15	-0...						
133	1.2DL + 1.5LM-MP5 + 1SWL (...Y...)	Y		1	1.2	38	1.5	11	.063	14		15	-0...						
134	1.2DL + 1.5LM-MP5 + 1SWL (...Y...)	Y		1	1.2	38	1.5	12	.063	14	.031	15	-0...						
135	1.2DL + 1.5LM-MP5 + 1SWL (...Y...)	Y		1	1.2	38	1.5	13	.063	14	.054	15	-0...						
136	1.2DL + 1.5LM-MP6 + 1SWL (...Y...)	Y		1	1.2	39	1.5	2	.063	14	.063	15							
137	1.2DL + 1.5LM-MP6 + 1SWL (...Y...)	Y		1	1.2	39	1.5	3	.063	14	.054	15	.031						
138	1.2DL + 1.5LM-MP6 + 1SWL (...Y...)	Y		1	1.2	39	1.5	4	.063	14	.031	15	.054						
139	1.2DL + 1.5LM-MP6 + 1SWL (...Y...)	Y		1	1.2	39	1.5	5	.063	14		15	.063						
140	1.2DL + 1.5LM-MP6 + 1SWL (...Y...)	Y		1	1.2	39	1.5	6	.063	14	-0...	15	.054						
141	1.2DL + 1.5LM-MP6 + 1SWL (...Y...)	Y		1	1.2	39	1.5	7	.063	14	-0...	15	.031						
142	1.2DL + 1.5LM-MP6 + 1SWL (...Y...)	Y		1	1.2	39	1.5	8	.063	14	-0...	15							
143	1.2DL + 1.5LM-MP6 + 1SWL (...Y...)	Y		1	1.2	39	1.5	9	.063	14	-0...	15	-0...						
144	1.2DL + 1.5LM-MP6 + 1SWL (...Y...)	Y		1	1.2	39	1.5	10	.063	14	-0...	15	-0...						
145	1.2DL + 1.5LM-MP6 + 1SWL (...Y...)	Y		1	1.2	39	1.5	11	.063	14		15	-0...						
146	1.2DL + 1.5LM-MP6 + 1SWL (...Y...)	Y		1	1.2	39	1.5	12	.063	14	.031	15	-0...						
147	1.2DL + 1.5LM-MP6 + 1SWL (...Y...)	Y		1	1.2	39	1.5	13	.063	14	.054	15	-0...						
148	1.2DL + 1.5LM-MP7 + 1SWL (...Y...)	Y		1	1.2	40	1.5	2	.063	14	.063	15							
149	1.2DL + 1.5LM-MP7 + 1SWL (...Y...)	Y		1	1.2	40	1.5	3	.063	14	.054	15	.031						
150	1.2DL + 1.5LM-MP7 + 1SWL (...Y...)	Y		1	1.2	40	1.5	4	.063	14	.031	15	.054						
151	1.2DL + 1.5LM-MP7 + 1SWL (...Y...)	Y		1	1.2	40	1.5	5	.063	14		15	.063						
152	1.2DL + 1.5LM-MP7 + 1SWL (...Y...)	Y		1	1.2	40	1.5	6	.063	14	-0...	15	.054						
153	1.2DL + 1.5LM-MP7 + 1SWL (...Y...)	Y		1	1.2	40	1.5	7	.063	14	-0...	15	.031						
154	1.2DL + 1.5LM-MP7 + 1SWL (...Y...)	Y		1	1.2	40	1.5	8	.063	14	-0...	15							
155	1.2DL + 1.5LM-MP7 + 1SWL (...Y...)	Y		1	1.2	40	1.5	9	.063	14	-0...	15	-0...						
156	1.2DL + 1.5LM-MP7 + 1SWL (...Y...)	Y		1	1.2	40	1.5	10	.063	14	-0...	15	-0...						
157	1.2DL + 1.5LM-MP7 + 1SWL (...Y...)	Y		1	1.2	40	1.5	11	.063	14		15	-0...						

**Load Combinations (Continued)**

	Description	S...	P...	S...B...	Fa...B...	Fa...B...	Fa...B...	Fa...B...	Fa...B...	Fa...B...	Fa...B...	Fa...B...	Fa...B...	Fa...B...	Fa...B...	Fa...B...	Fa...B...	Fa...B...
158	1.2DL + 1.5LM-MP7 + 1SWL (...Y...)	Y		1	1.2	40	1.5	12	.063	14	.031	15	-0...					
159	1.2DL + 1.5LM-MP7 + 1SWL (...Y...)	Y		1	1.2	40	1.5	13	.063	14	.054	15	-0...					
160	1.2DL + 1.5LM-MP8 + 1SWL (...Y...)	Y		1	1.2	41	1.5	2	.063	14	.063	15						
161	1.2DL + 1.5LM-MP8 + 1SWL (...Y...)	Y		1	1.2	41	1.5	3	.063	14	.054	15	.031					
162	1.2DL + 1.5LM-MP8 + 1SWL (...Y...)	Y		1	1.2	41	1.5	4	.063	14	.031	15	.054					
163	1.2DL + 1.5LM-MP8 + 1SWL (...Y...)	Y		1	1.2	41	1.5	5	.063	14		15	.063					
164	1.2DL + 1.5LM-MP8 + 1SWL (...Y...)	Y		1	1.2	41	1.5	6	.063	14	-0...	15	.054					
165	1.2DL + 1.5LM-MP8 + 1SWL (...Y...)	Y		1	1.2	41	1.5	7	.063	14	-0...	15	.031					
166	1.2DL + 1.5LM-MP8 + 1SWL (...Y...)	Y		1	1.2	41	1.5	8	.063	14	-0...	15						
167	1.2DL + 1.5LM-MP8 + 1SWL (...Y...)	Y		1	1.2	41	1.5	9	.063	14	-0...	15	-0...					
168	1.2DL + 1.5LM-MP8 + 1SWL (...Y...)	Y		1	1.2	41	1.5	10	.063	14	-0...	15	-0...					
169	1.2DL + 1.5LM-MP8 + 1SWL (...Y...)	Y		1	1.2	41	1.5	11	.063	14		15	-0...					
170	1.2DL + 1.5LM-MP8 + 1SWL (...Y...)	Y		1	1.2	41	1.5	12	.063	14	.031	15	-0...					
171	1.2DL + 1.5LM-MP8 + 1SWL (...Y...)	Y		1	1.2	41	1.5	13	.063	14	.054	15	-0...					
172	1.2DL + 1.5LM-MP9 + 1SWL (...Y...)	Y		1	1.2	42	1.5	2	.063	14	.063	15						
173	1.2DL + 1.5LM-MP9 + 1SWL (...Y...)	Y		1	1.2	42	1.5	3	.063	14	.054	15	.031					
174	1.2DL + 1.5LM-MP9 + 1SWL (...Y...)	Y		1	1.2	42	1.5	4	.063	14	.031	15	.054					
175	1.2DL + 1.5LM-MP9 + 1SWL (...Y...)	Y		1	1.2	42	1.5	5	.063	14		15	.063					
176	1.2DL + 1.5LM-MP9 + 1SWL (...Y...)	Y		1	1.2	42	1.5	6	.063	14	-0...	15	.054					
177	1.2DL + 1.5LM-MP9 + 1SWL (...Y...)	Y		1	1.2	42	1.5	7	.063	14	-0...	15	.031					
178	1.2DL + 1.5LM-MP9 + 1SWL (...Y...)	Y		1	1.2	42	1.5	8	.063	14	-0...	15						
179	1.2DL + 1.5LM-MP9 + 1SWL (...Y...)	Y		1	1.2	42	1.5	9	.063	14	-0...	15	-0...					
180	1.2DL + 1.5LM-MP9 + 1SWL (...Y...)	Y		1	1.2	42	1.5	10	.063	14	-0...	15	-0...					
181	1.2DL + 1.5LM-MP9 + 1SWL (...Y...)	Y		1	1.2	42	1.5	11	.063	14		15	-0...					
182	1.2DL + 1.5LM-MP9 + 1SWL (...Y...)	Y		1	1.2	42	1.5	12	.063	14	.031	15	-0...					

**Joint Boundary Conditions**

	Joint Label	X [k/in]	Y [k/in]	Z [k/in]	X Rot.[k-ft/rad]	Y Rot.[k-ft/rad]	Z Rot.[k-ft/rad]
1	P24	Reaction	Reaction	Reaction	Reaction	Reaction	Reaction
2	P13	Reaction	Reaction	Reaction	Reaction	Reaction	Reaction
3	P1	Reaction	Reaction	Reaction	Reaction	Reaction	Reaction

**Envelope Joint Reactions**

	Joint	X [lb]	LC	Y [lb]	LC	Z [lb]	LC	MX [lb-ft]	LC	MY [lb-ft]	LC	MZ [lb-ft]	LC
1	P24	759.88	6	2466.3...	35	1156.36	13	610.09	16	1459.051	19	4393.842	35
2		-744.35	24	-313.6...	16	-1148.2...	19	-3788.6...	35	-1477.186	13	-1177.37	16
3	P13	927.564	4	2954.3...	31	1222.7...	15	624.461	24	1639.65	15	923.675	24
4		-924.925	22	-218.4...	24	-1231.0...	9	-2805.6...	92	-1687.121	9	-6614.178	31
5	P1	1191.064	17	2641.1...	27	616.888	2	6323.17	27	1361.503	11	1577.785	115

**Envelope Joint Reactions (Continued)**

Joint	X [lb]	LC	Y [lb]	LC	Z [lb]	LC	MX [lb-ft]	LC	MY [lb-ft]	LC	MZ [lb-ft]	LC
6	-1209.293	11	-299.1...	20	-619.891	20	-1286.9...	20	-1310.395	17	-856.545	157
7	Totals: ...	5	2740.562	34	7439.21	14						
8	-2740.554	23	1532.8...	53	-2902.66	8						

**Member Point Loads (BLC 1 : Self Weight)**

	Member Label	Direction	Magnitude[lb,lb-ft]	Location[in, %]
1	MP1	Y	-32.25	0
2	MP1	Y	-32.25	72
3	MP1	Y	-74.95	12
4	MP1	Y	-63.93	12
5	S2	Y	-21.85	12
6	MP4	Y	-32.25	0
7	MP4	Y	-32.25	72
8	MP4	Y	-74.95	12
9	MP4	Y	-63.93	12
10	MP7	Y	-32.25	0
11	MP7	Y	-32.25	72
12	MP7	Y	-74.95	12
13	MP7	Y	-63.93	12

**Member Point Loads (BLC 2 : Wind Load AZI 0)**

	Member Label	Direction	Magnitude[lb,lb-ft]	Location[in, %]
1	MP1	X	0	0
2	MP1	Z	-123.93	0
3	MP1	X	0	72
4	MP1	Z	-123.93	72
5	MP1	X	0	12
6	MP1	Z	-60.76	12
7	MP1	X	0	12
8	MP1	Z	-60.76	12
9	S2	X	0	12
10	S2	Z	-57.76	12
11	MP4	X	0	0
12	MP4	Z	-68.23	0
13	MP4	X	0	72
14	MP4	Z	-68.23	72
15	MP4	X	0	12
16	MP4	Z	-42.79	12
17	MP4	X	0	12
18	MP4	Z	-39.16	12



**Member Point Loads (BLC 2 : Wind Load AZI 0) (Continued)**

	Member Label	Direction	Magnitude[lb,lb-ft]	Location[in,%]
19	MP7	X	0	0
20	MP7	Z	-68.23	0
21	MP7	X	0	72
22	MP7	Z	-68.23	72
23	MP7	X	0	12
24	MP7	Z	-42.79	12
25	MP7	X	0	12
26	MP7	Z	-39.16	12

**Member Point Loads (BLC 3 : Wind Load AZI 30)**

	Member Label	Direction	Magnitude[lb,lb-ft]	Location[in,%]
1	MP1	X	-52.68	0
2	MP1	Z	-91.25	0
3	MP1	X	-52.68	72
4	MP1	Z	-91.25	72
5	MP1	X	-27.38	12
6	MP1	Z	-47.43	12
7	MP1	X	-26.78	12
8	MP1	Z	-46.38	12
9	S2	X	-25.79	12
10	S2	Z	-44.66	12
11	MP4	X	-52.68	0
12	MP4	Z	-91.25	0
13	MP4	X	-52.68	72
14	MP4	Z	-91.25	72
15	MP4	X	-27.38	12
16	MP4	Z	-47.43	12
17	MP4	X	-26.78	12
18	MP4	Z	-46.38	12
19	MP7	X	-24.83	0
20	MP7	Z	-43.01	0
21	MP7	X	-24.83	72
22	MP7	Z	-43.01	72
23	MP7	X	-18.4	12
24	MP7	Z	-31.87	12
25	MP7	X	-15.98	12
26	MP7	Z	-27.68	12

**Member Point Loads (BLC 4 : Wind Load AZI 60)**

	Member Label	Direction	Magnitude[lb,lb-ft]	Location[in,%]
1	MP1	X	-59.09	0



**Member Point Loads (BLC 4 : Wind Load AZI 60) (Continued)**

	Member Label	Direction	Magnitude[lb,lb-ft]	Location[in,%]
2	MP1	Z	-34.12	0
3	MP1	X	-59.09	72
4	MP1	Z	-34.12	72
5	MP1	X	-37.05	12
6	MP1	Z	-21.39	12
7	MP1	X	-33.92	12
8	MP1	Z	-19.58	12
9	S2	X	-33.94	12
10	S2	Z	-19.6	12
11	MP4	X	-107.33	0
12	MP4	Z	-61.97	0
13	MP4	X	-107.33	72
14	MP4	Z	-61.97	72
15	MP4	X	-52.62	12
16	MP4	Z	-30.38	12
17	MP4	X	-52.62	12
18	MP4	Z	-30.38	12
19	MP7	X	-59.09	0
20	MP7	Z	-34.12	0
21	MP7	X	-59.09	72
22	MP7	Z	-34.12	72
23	MP7	X	-37.05	12
24	MP7	Z	-21.39	12
25	MP7	X	-33.92	12
26	MP7	Z	-19.58	12

**Member Point Loads (BLC 5 : Wind Load AZI 90)**

	Member Label	Direction	Magnitude[lb,lb-ft]	Location[in,%]
1	MP1	X	-49.67	0
2	MP1	Z	0	0
3	MP1	X	-49.67	72
4	MP1	Z	0	72
5	MP1	X	-36.8	12
6	MP1	Z	0	12
7	MP1	X	-31.96	12
8	MP1	Z	0	12
9	S2	X	-33.01	12
10	S2	Z	0	12
11	MP4	X	-105.37	0
12	MP4	Z	0	0
13	MP4	X	-105.37	72
14	MP4	Z	0	72



**Member Point Loads (BLC 5 : Wind Load AZI 90) (Continued)**

	Member Label	Direction	Magnitude[lb,lb-ft]	Location[in,%]
15	MP4	X	-54.77	12
16	MP4	Z	0	12
17	MP4	X	-53.56	12
18	MP4	Z	0	12
19	MP7	X	-105.37	0
20	MP7	Z	0	0
21	MP7	X	-105.37	72
22	MP7	Z	0	72
23	MP7	X	-54.77	12
24	MP7	Z	0	12
25	MP7	X	-53.56	12
26	MP7	Z	0	12

**Member Point Loads (BLC 6 : Wind Load AZI 120)**

	Member Label	Direction	Magnitude[lb,lb-ft]	Location[in,%]
1	MP1	X	-59.09	0
2	MP1	Z	34.12	0
3	MP1	X	-59.09	72
4	MP1	Z	34.12	72
5	MP1	X	-37.05	12
6	MP1	Z	21.39	12
7	MP1	X	-33.92	12
8	MP1	Z	19.58	12
9	S2	X	-33.94	12
10	S2	Z	19.6	12
11	MP4	X	-59.09	0
12	MP4	Z	34.12	0
13	MP4	X	-59.09	72
14	MP4	Z	34.12	72
15	MP4	X	-37.05	12
16	MP4	Z	21.39	12
17	MP4	X	-33.92	12
18	MP4	Z	19.58	12
19	MP7	X	-107.33	0
20	MP7	Z	61.97	0
21	MP7	X	-107.33	72
22	MP7	Z	61.97	72
23	MP7	X	-52.62	12
24	MP7	Z	30.38	12
25	MP7	X	-52.62	12
26	MP7	Z	30.38	12



**Member Point Loads (BLC 7 : Wind Load AZI 150)**

	Member Label	Direction	Magnitude[lb,lb-ft]	Location[in,%]
1	MP1	X	-52.68	0
2	MP1	Z	91.25	0
3	MP1	X	-52.68	72
4	MP1	Z	91.25	72
5	MP1	X	-27.38	12
6	MP1	Z	47.43	12
7	MP1	X	-26.78	12
8	MP1	Z	46.38	12
9	S2	X	-25.79	12
10	S2	Z	44.66	12
11	MP4	X	-24.83	0
12	MP4	Z	43.01	0
13	MP4	X	-24.83	72
14	MP4	Z	43.01	72
15	MP4	X	-18.4	12
16	MP4	Z	31.87	12
17	MP4	X	-15.98	12
18	MP4	Z	27.68	12
19	MP7	X	-52.68	0
20	MP7	Z	91.25	0
21	MP7	X	-52.68	72
22	MP7	Z	91.25	72
23	MP7	X	-27.38	12
24	MP7	Z	47.43	12
25	MP7	X	-26.78	12
26	MP7	Z	46.38	12

**Member Point Loads (BLC 8 : Wind Load AZI 180)**

	Member Label	Direction	Magnitude[lb,lb-ft]	Location[in,%]
1	MP1	X	0	0
2	MP1	Z	123.93	0
3	MP1	X	0	72
4	MP1	Z	123.93	72
5	MP1	X	0	12
6	MP1	Z	60.76	12
7	MP1	X	0	12
8	MP1	Z	60.76	12
9	S2	X	0	12
10	S2	Z	57.76	12
11	MP4	X	0	0
12	MP4	Z	68.23	0
13	MP4	X	0	72



**Member Point Loads (BLC 8 : Wind Load AZI 180) (Continued)**

	Member Label	Direction	Magnitude[lb,lb-ft]	Location[in,%]
14	MP4	Z	68.23	72
15	MP4	X	0	12
16	MP4	Z	42.79	12
17	MP4	X	0	12
18	MP4	Z	39.16	12
19	MP7	X	0	0
20	MP7	Z	68.23	0
21	MP7	X	0	72
22	MP7	Z	68.23	72
23	MP7	X	0	12
24	MP7	Z	42.79	12
25	MP7	X	0	12
26	MP7	Z	39.16	12

**Member Point Loads (BLC 9 : Wind Load AZI 210)**

	Member Label	Direction	Magnitude[lb,lb-ft]	Location[in,%]
1	MP1	X	52.68	0
2	MP1	Z	91.25	0
3	MP1	X	52.68	72
4	MP1	Z	91.25	72
5	MP1	X	27.38	12
6	MP1	Z	47.43	12
7	MP1	X	26.78	12
8	MP1	Z	46.38	12
9	S2	X	25.79	12
10	S2	Z	44.66	12
11	MP4	X	52.68	0
12	MP4	Z	91.25	0
13	MP4	X	52.68	72
14	MP4	Z	91.25	72
15	MP4	X	27.38	12
16	MP4	Z	47.43	12
17	MP4	X	26.78	12
18	MP4	Z	46.38	12
19	MP7	X	24.83	0
20	MP7	Z	43.01	0
21	MP7	X	24.83	72
22	MP7	Z	43.01	72
23	MP7	X	18.4	12
24	MP7	Z	31.87	12
25	MP7	X	15.98	12
26	MP7	Z	27.68	12



**Member Point Loads (BLC 10 : Wind Load AZI 240)**

	Member Label	Direction	Magnitude[lb,lb-ft]	Location[in,%]
1	MP1	X	59.09	0
2	MP1	Z	34.12	0
3	MP1	X	59.09	72
4	MP1	Z	34.12	72
5	MP1	X	37.05	12
6	MP1	Z	21.39	12
7	MP1	X	33.92	12
8	MP1	Z	19.58	12
9	S2	X	33.94	12
10	S2	Z	19.6	12
11	MP4	X	107.33	0
12	MP4	Z	61.97	0
13	MP4	X	107.33	72
14	MP4	Z	61.97	72
15	MP4	X	52.62	12
16	MP4	Z	30.38	12
17	MP4	X	52.62	12
18	MP4	Z	30.38	12
19	MP7	X	59.09	0
20	MP7	Z	34.12	0
21	MP7	X	59.09	72
22	MP7	Z	34.12	72
23	MP7	X	37.05	12
24	MP7	Z	21.39	12
25	MP7	X	33.92	12
26	MP7	Z	19.58	12

**Member Point Loads (BLC 11 : Wind Load AZI 270)**

	Member Label	Direction	Magnitude[lb,lb-ft]	Location[in,%]
1	MP1	X	49.67	0
2	MP1	Z	0	0
3	MP1	X	49.67	72
4	MP1	Z	0	72
5	MP1	X	36.8	12
6	MP1	Z	0	12
7	MP1	X	31.96	12
8	MP1	Z	0	12
9	S2	X	33.01	12
10	S2	Z	0	12
11	MP4	X	105.37	0
12	MP4	Z	0	0
13	MP4	X	105.37	72



**Member Point Loads (BLC 11 : Wind Load AZI 270) (Continued)**

	Member Label	Direction	Magnitude[lb,lb-ft]	Location[in,%]
14	MP4	Z	0	72
15	MP4	X	54.77	12
16	MP4	Z	0	12
17	MP4	X	53.56	12
18	MP4	Z	0	12
19	MP7	X	105.37	0
20	MP7	Z	0	0
21	MP7	X	105.37	72
22	MP7	Z	0	72
23	MP7	X	54.77	12
24	MP7	Z	0	12
25	MP7	X	53.56	12
26	MP7	Z	0	12

**Member Point Loads (BLC 12 : Wind Load AZI 300)**

	Member Label	Direction	Magnitude[lb,lb-ft]	Location[in,%]
1	MP1	X	59.09	0
2	MP1	Z	-34.12	0
3	MP1	X	59.09	72
4	MP1	Z	-34.12	72
5	MP1	X	37.05	12
6	MP1	Z	-21.39	12
7	MP1	X	33.92	12
8	MP1	Z	-19.58	12
9	S2	X	33.94	12
10	S2	Z	-19.6	12
11	MP4	X	59.09	0
12	MP4	Z	-34.12	0
13	MP4	X	59.09	72
14	MP4	Z	-34.12	72
15	MP4	X	37.05	12
16	MP4	Z	-21.39	12
17	MP4	X	33.92	12
18	MP4	Z	-19.58	12
19	MP7	X	107.33	0
20	MP7	Z	-61.97	0
21	MP7	X	107.33	72
22	MP7	Z	-61.97	72
23	MP7	X	52.62	12
24	MP7	Z	-30.38	12
25	MP7	X	52.62	12
26	MP7	Z	-30.38	12

**Member Point Loads (BLC 13 : Wind Load AZI 330)**

	Member Label	Direction	Magnitude[lb,lb-ft]	Location[in,%]
1	MP1	X	52.68	0
2	MP1	Z	-91.25	0
3	MP1	X	52.68	72
4	MP1	Z	-91.25	72
5	MP1	X	27.38	12
6	MP1	Z	-47.43	12
7	MP1	X	26.78	12
8	MP1	Z	-46.38	12
9	S2	X	25.79	12
10	S2	Z	-44.66	12
11	MP4	X	24.83	0
12	MP4	Z	-43.01	0
13	MP4	X	24.83	72
14	MP4	Z	-43.01	72
15	MP4	X	18.4	12
16	MP4	Z	-31.87	12
17	MP4	X	15.98	12
18	MP4	Z	-27.68	12
19	MP7	X	52.68	0
20	MP7	Z	-91.25	0
21	MP7	X	52.68	72
22	MP7	Z	-91.25	72
23	MP7	X	27.38	12
24	MP7	Z	-47.43	12
25	MP7	X	26.78	12
26	MP7	Z	-46.38	12

**Member Point Loads (BLC 16 : Ice Weight)**

	Member Label	Direction	Magnitude[lb,lb-ft]	Location[in,%]
1	MP1	Y	-193.134	0
2	MP1	Y	-193.134	72
3	MP1	Y	-104.095	12
4	MP1	Y	-97.979	12
5	S2	Y	-95.656	12
6	MP4	Y	-193.134	0
7	MP4	Y	-193.134	72
8	MP4	Y	-104.095	12
9	MP4	Y	-97.979	12
10	MP7	Y	-193.134	0
11	MP7	Y	-193.134	72
12	MP7	Y	-104.095	12
13	MP7	Y	-97.979	12



**Member Point Loads (BLC 17 : Ice Wind Load AZI 0)**

	Member Label	Direction	Magnitude[lb,lb-ft]	Location[in,%]
1	MP1	X	0	0
2	MP1	Z	-17.97	0
3	MP1	X	0	72
4	MP1	Z	-17.97	72
5	MP1	X	0	12
6	MP1	Z	-7.35	12
7	MP1	X	0	12
8	MP1	Z	-7.35	12
9	S2	X	0	12
10	S2	Z	-7.15	12
11	MP4	X	0	0
12	MP4	Z	-13.76	0
13	MP4	X	0	72
14	MP4	Z	-13.76	72
15	MP4	X	0	12
16	MP4	Z	-6.36	12
17	MP4	X	0	12
18	MP4	Z	-6.15	12
19	MP7	X	0	0
20	MP7	Z	-13.76	0
21	MP7	X	0	72
22	MP7	Z	-13.76	72
23	MP7	X	0	12
24	MP7	Z	-6.36	12
25	MP7	X	0	12
26	MP7	Z	-6.15	12

**Member Point Loads (BLC 18 : Ice Wind Load AZI 30)**

	Member Label	Direction	Magnitude[lb,lb-ft]	Location[in,%]
1	MP1	X	-8.28	0
2	MP1	Z	-14.35	0
3	MP1	X	-8.28	72
4	MP1	Z	-14.35	72
5	MP1	X	-3.51	12
6	MP1	Z	-6.08	12
7	MP1	X	-3.48	12
8	MP1	Z	-6.02	12
9	S2	X	-3.41	12
10	S2	Z	-5.91	12
11	MP4	X	-8.28	0
12	MP4	Z	-14.35	0
13	MP4	X	-8.28	72



**Member Point Loads (BLC 18 : Ice Wind Load AZI 30) (Continued)**

	Member Label	Direction	Magnitude[lb,lb-ft]	Location[in,%]
14	MP4	Z	-14.35	72
15	MP4	X	-3.51	12
16	MP4	Z	-6.08	12
17	MP4	X	-3.48	12
18	MP4	Z	-6.02	12
19	MP7	X	-6.18	0
20	MP7	Z	-10.7	0
21	MP7	X	-6.18	72
22	MP7	Z	-10.7	72
23	MP7	X	-3.01	12
24	MP7	Z	-5.22	12
25	MP7	X	-2.87	12
26	MP7	Z	-4.98	12

**Member Point Loads (BLC 19 : Ice Wind Load AZI 60)**

	Member Label	Direction	Magnitude[lb,lb-ft]	Location[in,%]
1	MP1	X	-11.92	0
2	MP1	Z	-6.88	0
3	MP1	X	-11.92	72
4	MP1	Z	-6.88	72
5	MP1	X	-5.5	12
6	MP1	Z	-3.18	12
7	MP1	X	-5.32	12
8	MP1	Z	-3.07	12
9	S2	X	-5.35	12
10	S2	Z	-3.09	12
11	MP4	X	-15.56	0
12	MP4	Z	-8.98	0
13	MP4	X	-15.56	72
14	MP4	Z	-8.98	72
15	MP4	X	-6.37	12
16	MP4	Z	-3.68	12
17	MP4	X	-6.37	12
18	MP4	Z	-3.68	12
19	MP7	X	-11.92	0
20	MP7	Z	-6.88	0
21	MP7	X	-11.92	72
22	MP7	Z	-6.88	72
23	MP7	X	-5.5	12
24	MP7	Z	-3.18	12
25	MP7	X	-5.32	12
26	MP7	Z	-3.07	12



**Member Point Loads (BLC 20 : Ice Wind Load AZI 90)**

	Member Label	Direction	Magnitude[lb,lb-ft]	Location[in,%]
1	MP1	X	-12.36	0
2	MP1	Z	0	0
3	MP1	X	-12.36	72
4	MP1	Z	0	72
5	MP1	X	-6.02	12
6	MP1	Z	0	12
7	MP1	X	-5.74	12
8	MP1	Z	0	12
9	S2	X	-5.85	12
10	S2	Z	0	12
11	MP4	X	-16.56	0
12	MP4	Z	0	0
13	MP4	X	-16.56	72
14	MP4	Z	0	72
15	MP4	X	-7.02	12
16	MP4	Z	0	12
17	MP4	X	-6.95	12
18	MP4	Z	0	12
19	MP7	X	-16.56	0
20	MP7	Z	0	0
21	MP7	X	-16.56	72
22	MP7	Z	0	72
23	MP7	X	-7.02	12
24	MP7	Z	0	12
25	MP7	X	-6.95	12
26	MP7	Z	0	12

**Member Point Loads (BLC 21 : Ice Wind Load AZI 120)**

	Member Label	Direction	Magnitude[lb,lb-ft]	Location[in,%]
1	MP1	X	-11.92	0
2	MP1	Z	6.88	0
3	MP1	X	-11.92	72
4	MP1	Z	6.88	72
5	MP1	X	-5.5	12
6	MP1	Z	3.18	12
7	MP1	X	-5.32	12
8	MP1	Z	3.07	12
9	S2	X	-5.35	12
10	S2	Z	3.09	12
11	MP4	X	-11.92	0
12	MP4	Z	6.88	0
13	MP4	X	-11.92	72





**Member Point Loads (BLC 21 : Ice Wind Load AZI 120) (Continued)**

	Member Label	Direction	Magnitude[lb,lb-ft]	Location[in, %]
14	MP4	Z	6.88	72
15	MP4	X	-5.5	12
16	MP4	Z	3.18	12
17	MP4	X	-5.32	12
18	MP4	Z	3.07	12
19	MP7	X	-15.56	0
20	MP7	Z	8.98	0
21	MP7	X	-15.56	72
22	MP7	Z	8.98	72
23	MP7	X	-6.37	12
24	MP7	Z	3.68	12
25	MP7	X	-6.37	12
26	MP7	Z	3.68	12

**Member Point Loads (BLC 22 : Ice Wind Load AZI 150)**

	Member Label	Direction	Magnitude[lb,lb-ft]	Location[in, %]
1	MP1	X	-8.28	0
2	MP1	Z	14.35	0
3	MP1	X	-8.28	72
4	MP1	Z	14.35	72
5	MP1	X	-3.51	12
6	MP1	Z	6.08	12
7	MP1	X	-3.48	12
8	MP1	Z	6.02	12
9	S2	X	-3.41	12
10	S2	Z	5.91	12
11	MP4	X	-6.18	0
12	MP4	Z	10.7	0
13	MP4	X	-6.18	72
14	MP4	Z	10.7	72
15	MP4	X	-3.01	12
16	MP4	Z	5.22	12
17	MP4	X	-2.87	12
18	MP4	Z	4.98	12
19	MP7	X	-8.28	0
20	MP7	Z	14.35	0
21	MP7	X	-8.28	72
22	MP7	Z	14.35	72
23	MP7	X	-3.51	12
24	MP7	Z	6.08	12
25	MP7	X	-3.48	12
26	MP7	Z	6.02	12



**Member Point Loads (BLC 23 : Ice Wind Load AZI 180)**

	Member Label	Direction	Magnitude[lb,lb-ft]	Location[in,%]
1	MP1	X	0	0
2	MP1	Z	17.97	0
3	MP1	X	0	72
4	MP1	Z	17.97	72
5	MP1	X	0	12
6	MP1	Z	7.35	12
7	MP1	X	0	12
8	MP1	Z	7.35	12
9	S2	X	0	12
10	S2	Z	7.15	12
11	MP4	X	0	0
12	MP4	Z	13.76	0
13	MP4	X	0	72
14	MP4	Z	13.76	72
15	MP4	X	0	12
16	MP4	Z	6.36	12
17	MP4	X	0	12
18	MP4	Z	6.15	12
19	MP7	X	0	0
20	MP7	Z	13.76	0
21	MP7	X	0	72
22	MP7	Z	13.76	72
23	MP7	X	0	12
24	MP7	Z	6.36	12
25	MP7	X	0	12
26	MP7	Z	6.15	12

**Member Point Loads (BLC 24 : Ice Wind Load AZI 210)**

	Member Label	Direction	Magnitude[lb,lb-ft]	Location[in,%]
1	MP1	X	8.28	0
2	MP1	Z	14.35	0
3	MP1	X	8.28	72
4	MP1	Z	14.35	72
5	MP1	X	3.51	12
6	MP1	Z	6.08	12
7	MP1	X	3.48	12
8	MP1	Z	6.02	12
9	S2	X	3.41	12
10	S2	Z	5.91	12
11	MP4	X	8.28	0
12	MP4	Z	14.35	0
13	MP4	X	8.28	72



**Member Point Loads (BLC 24 : Ice Wind Load AZI 210) (Continued)**

	Member Label	Direction	Magnitude[lb,lb-ft]	Location[in,%]
14	MP4	Z	14.35	72
15	MP4	X	3.51	12
16	MP4	Z	6.08	12
17	MP4	X	3.48	12
18	MP4	Z	6.02	12
19	MP7	X	6.18	0
20	MP7	Z	10.7	0
21	MP7	X	6.18	72
22	MP7	Z	10.7	72
23	MP7	X	3.01	12
24	MP7	Z	5.22	12
25	MP7	X	2.87	12
26	MP7	Z	4.98	12

**Member Point Loads (BLC 25 : Ice Wind Load AZI 240)**

	Member Label	Direction	Magnitude[lb,lb-ft]	Location[in,%]
1	MP1	X	11.92	0
2	MP1	Z	6.88	0
3	MP1	X	11.92	72
4	MP1	Z	6.88	72
5	MP1	X	5.5	12
6	MP1	Z	3.18	12
7	MP1	X	5.32	12
8	MP1	Z	3.07	12
9	S2	X	5.35	12
10	S2	Z	3.09	12
11	MP4	X	15.56	0
12	MP4	Z	8.98	0
13	MP4	X	15.56	72
14	MP4	Z	8.98	72
15	MP4	X	6.37	12
16	MP4	Z	3.68	12
17	MP4	X	6.37	12
18	MP4	Z	3.68	12
19	MP7	X	11.92	0
20	MP7	Z	6.88	0
21	MP7	X	11.92	72
22	MP7	Z	6.88	72
23	MP7	X	5.5	12
24	MP7	Z	3.18	12
25	MP7	X	5.32	12
26	MP7	Z	3.07	12



**Member Point Loads (BLC 26 : Ice Wind Load AZI 270)**

	Member Label	Direction	Magnitude[lb,lb-ft]	Location[in,%]
1	MP1	X	12.36	0
2	MP1	Z	0	0
3	MP1	X	12.36	72
4	MP1	Z	0	72
5	MP1	X	6.02	12
6	MP1	Z	0	12
7	MP1	X	5.74	12
8	MP1	Z	0	12
9	S2	X	5.85	12
10	S2	Z	0	12
11	MP4	X	16.56	0
12	MP4	Z	0	0
13	MP4	X	16.56	72
14	MP4	Z	0	72
15	MP4	X	7.02	12
16	MP4	Z	0	12
17	MP4	X	6.95	12
18	MP4	Z	0	12
19	MP7	X	16.56	0
20	MP7	Z	0	0
21	MP7	X	16.56	72
22	MP7	Z	0	72
23	MP7	X	7.02	12
24	MP7	Z	0	12
25	MP7	X	6.95	12
26	MP7	Z	0	12

**Member Point Loads (BLC 27 : Ice Wind Load AZI 300)**

	Member Label	Direction	Magnitude[lb,lb-ft]	Location[in,%]
1	MP1	X	11.92	0
2	MP1	Z	-6.88	0
3	MP1	X	11.92	72
4	MP1	Z	-6.88	72
5	MP1	X	5.5	12
6	MP1	Z	-3.18	12
7	MP1	X	5.32	12
8	MP1	Z	-3.07	12
9	S2	X	5.35	12
10	S2	Z	-3.09	12
11	MP4	X	11.92	0
12	MP4	Z	-6.88	0
13	MP4	X	11.92	72



**Member Point Loads (BLC 27 : Ice Wind Load AZI 300) (Continued)**

	Member Label	Direction	Magnitude[lb,lb-ft]	Location[in,%]
14	MP4	Z	-6.88	72
15	MP4	X	5.5	12
16	MP4	Z	-3.18	12
17	MP4	X	5.32	12
18	MP4	Z	-3.07	12
19	MP7	X	15.56	0
20	MP7	Z	-8.98	0
21	MP7	X	15.56	72
22	MP7	Z	-8.98	72
23	MP7	X	6.37	12
24	MP7	Z	-3.68	12
25	MP7	X	6.37	12
26	MP7	Z	-3.68	12

**Member Point Loads (BLC 28 : Ice Wind Load AZI 330)**

	Member Label	Direction	Magnitude[lb,lb-ft]	Location[in,%]
1	MP1	X	8.28	0
2	MP1	Z	-14.35	0
3	MP1	X	8.28	72
4	MP1	Z	-14.35	72
5	MP1	X	3.51	12
6	MP1	Z	-6.08	12
7	MP1	X	3.48	12
8	MP1	Z	-6.02	12
9	S2	X	3.41	12
10	S2	Z	-5.91	12
11	MP4	X	6.18	0
12	MP4	Z	-10.7	0
13	MP4	X	6.18	72
14	MP4	Z	-10.7	72
15	MP4	X	3.01	12
16	MP4	Z	-5.22	12
17	MP4	X	2.87	12
18	MP4	Z	-4.98	12
19	MP7	X	8.28	0
20	MP7	Z	-14.35	0
21	MP7	X	8.28	72
22	MP7	Z	-14.35	72
23	MP7	X	3.51	12
24	MP7	Z	-6.08	12
25	MP7	X	3.48	12
26	MP7	Z	-6.02	12



**Member Point Loads (BLC 31 : Seismic Load Z)**

	Member Label	Direction	Magnitude[lb,lb-ft]	Location[in,%]
1	MP1	Z	-9.288	0
2	MP1	Z	-9.288	72
3	MP1	Z	-21.586	12
4	MP1	Z	-18.412	12
5	S2	Z	-6.293	12
6	MP4	Z	-9.288	0
7	MP4	Z	-9.288	72
8	MP4	Z	-21.586	12
9	MP4	Z	-18.412	12
10	MP7	Z	-9.288	0
11	MP7	Z	-9.288	72
12	MP7	Z	-21.586	12
13	MP7	Z	-18.412	12

**Member Point Loads (BLC 32 : Seismic Load X)**

	Member Label	Direction	Magnitude[lb,lb-ft]	Location[in,%]
1	MP1	X	-9.288	0
2	MP1	X	-9.288	72
3	MP1	X	-21.586	12
4	MP1	X	-18.412	12
5	S2	X	-6.293	12
6	MP4	X	-9.288	0
7	MP4	X	-9.288	72
8	MP4	X	-21.586	12
9	MP4	X	-18.412	12
10	MP7	X	-9.288	0
11	MP7	X	-9.288	72
12	MP7	X	-21.586	12
13	MP7	X	-18.412	12

**Joint Loads and Enforced Displacements (BLC 33 : Service Live Loads)**

	Joint Label	L,D,M	Direction	Magnitude[(lb,lb-ft), (in,rad), (lb*s^2/in, lb*s^2*in)]
1	N72B	L	Y	-250
2	N135A	L	Y	-250
3	N129B	L	Y	-250

**Joint Loads and Enforced Displacements (BLC 34 : Maintenance Load 1)**

	Joint Label	L,D,M	Direction	Magnitude[(lb,lb-ft), (in,rad), (lb*s^2/in, lb*s^2*in)]
1	N70A	L	Y	-500

**Joint Loads and Enforced Displacements (BLC 35 : Maintenance Load 2)**

	Joint Label	L,D,M	Direction	Magnitude[(lb,lb-ft), (in,rad), (lb*s^2/in, lb*s^2*in)]
1	N69A	L	Y	-500

**Joint Loads and Enforced Displacements (BLC 36 : Maintenance Load 3)**

	Joint Label	L,D,M	Direction	Magnitude[(lb,lb-ft), (in,rad), (lb*s^2/in, lb*s^2*in)]
1	N76	L	Y	-500

**Joint Loads and Enforced Displacements (BLC 37 : Maintenance Load 4)**

	Joint Label	L,D,M	Direction	Magnitude[(lb,lb-ft), (in,rad), (lb*s^2/in, lb*s^2*in)]
1	N94	L	Y	-500

**Joint Loads and Enforced Displacements (BLC 38 : Maintenance Load 5)**

	Joint Label	L,D,M	Direction	Magnitude[(lb,lb-ft), (in,rad), (lb*s^2/in, lb*s^2*in)]
1	N93	L	Y	-500

**Joint Loads and Enforced Displacements (BLC 39 : Maintenance Load 6)**

	Joint Label	L,D,M	Direction	Magnitude[(lb,lb-ft), (in,rad), (lb*s^2/in, lb*s^2*in)]
1	N122	L	Y	-500

**Joint Loads and Enforced Displacements (BLC 40 : Maintenance Load 7)**

	Joint Label	L,D,M	Direction	Magnitude[(lb,lb-ft), (in,rad), (lb*s^2/in, lb*s^2*in)]
1	N121	L	Y	-500

**Joint Loads and Enforced Displacements (BLC 41 : Maintenance Load 8)**

	Joint Label	L,D,M	Direction	Magnitude[(lb,lb-ft), (in,rad), (lb*s^2/in, lb*s^2*in)]
1	N133B	L	Y	-500

**Joint Loads and Enforced Displacements (BLC 42 : Maintenance Load 9)**

	Joint Label	L,D,M	Direction	Magnitude[(lb,lb-ft), (in,rad), (lb*s^2/in, lb*s^2*in)]
1	N139	L	Y	-500

**Member Distributed Loads (BLC 14 : Distr. Wind Load Z)**

	Member Label	Direction	Start Magnitude[lb/ft,...]	End Magn...	Start Location..	End Location[in,%]
1	S3	SZ	-68.765	-68.765	0	%100
2	GA4	SZ	-68.765	-68.765	0	%100
3	GA3	SZ	-68.765	-68.765	0	%100
4	P3	SZ	-68.765	-68.765	0	%100
5	S2	SZ	-68.765	-68.765	0	%100
6	GA2	SZ	-68.765	-68.765	0	%100



**Member Distributed Loads (BLC 14 : Distr. Wind Load Z) (Continued)**

	Member Label	Direction	Start Magnitude[lb/ft,...	End Magn...	Start Location...	End Location[in, %]
7	GA1	SZ	-68.765	-68.765	0	%100
8	P2	SZ	-68.765	-68.765	0	%100
9	S1	SZ	-68.765	-68.765	0	%100
10	GA6	SZ	-68.765	-68.765	0	%100
11	GA5	SZ	-68.765	-68.765	0	%100
12	P1	SZ	-68.765	-68.765	0	%100
13	H1	SZ	-41.259	-41.259	0	%100
14	MP1	SZ	-41.259	-41.259	0	%100
15	MP3	SZ	-41.259	-41.259	0	%100
16	HR1	SZ	-41.259	-41.259	0	%100
17	CA8	SZ	-68.765	-68.765	0	%100
18	CA9	SZ	-68.765	-68.765	0	%100
19	CA7	SZ	-68.765	-68.765	0	%100
20	M32	SZ	0	0	0	%100
21	M35	SZ	0	0	0	%100
22	M36	SZ	0	0	0	%100
23	M39A	SZ	0	0	0	%100
24	CA3	SZ	-68.765	-68.765	0	%100
25	CA4	SZ	-68.765	-68.765	0	%100
26	CA1	SZ	-68.765	-68.765	0	%100
27	CA2	SZ	-68.765	-68.765	0	%100
28	CA5	SZ	-68.765	-68.765	0	%100
29	CA6	SZ	-68.765	-68.765	0	%100
30	M64	SZ	0	0	0	%100
31	M65	SZ	0	0	0	%100
32	M66	SZ	0	0	0	%100
33	M67	SZ	0	0	0	%100
34	M68	SZ	0	0	0	%100
35	M69	SZ	0	0	0	%100
36	M70	SZ	0	0	0	%100
37	M71	SZ	0	0	0	%100
38	M72	SZ	0	0	0	%100
39	M73	SZ	0	0	0	%100
40	M74	SZ	0	0	0	%100
41	M75	SZ	-68.765	-68.765	0	%100
42	MP2	SZ	-41.259	-41.259	0	%100
43	M43	SZ	0	0	0	%100
44	M44	SZ	0	0	0	%100
45	H3	SZ	-41.259	-41.259	0	%100
46	MP7	SZ	-41.259	-41.259	0	%100
47	MP9	SZ	-41.259	-41.259	0	%100
48	HR3	SZ	-41.259	-41.259	0	%100





**Member Distributed Loads (BLC 14 : Distr. Wind Load Z) (Continued)**

	Member Label	Direction	Start Magnitude[lb/ft,...	End Magn...	Start Location...	End Location[in,%]
49	M52	SZ	0	0	0	%100
50	M53	SZ	0	0	0	%100
51	M54	SZ	0	0	0	%100
52	M55	SZ	0	0	0	%100
53	H2	SZ	-41.259	-41.259	0	%100
54	MP4	SZ	-41.259	-41.259	0	%100
55	MP6	SZ	-41.259	-41.259	0	%100
56	HR2	SZ	-41.259	-41.259	0	%100
57	M66A	SZ	0	0	0	%100
58	M67A	SZ	0	0	0	%100
59	M68A	SZ	0	0	0	%100
60	M69A	SZ	0	0	0	%100
61	MP8	SZ	-41.259	-41.259	0	%100
62	M68B	SZ	0	0	0	%100
63	M69B	SZ	0	0	0	%100
64	MP5	SZ	-41.259	-41.259	0	%100
65	M71B	SZ	0	0	0	%100
66	M72B	SZ	0	0	0	%100

**Member Distributed Loads (BLC 15 : Distr. Wind Load X)**

	Member Label	Direction	Start Magnitude[lb/ft,...	End Magn...	Start Location...	End Location[in,%]
1	S3	SX	-68.765	-68.765	0	%100
2	GA4	SX	-68.765	-68.765	0	%100
3	GA3	SX	-68.765	-68.765	0	%100
4	P3	SX	-68.765	-68.765	0	%100
5	S2	SX	-68.765	-68.765	0	%100
6	GA2	SX	-68.765	-68.765	0	%100
7	GA1	SX	-68.765	-68.765	0	%100
8	P2	SX	-68.765	-68.765	0	%100
9	S1	SX	-68.765	-68.765	0	%100
10	GA6	SX	-68.765	-68.765	0	%100
11	GA5	SX	-68.765	-68.765	0	%100
12	P1	SX	-68.765	-68.765	0	%100
13	H1	SX	-41.259	-41.259	0	%100
14	MP1	SX	-41.259	-41.259	0	%100
15	MP3	SX	-41.259	-41.259	0	%100
16	HR1	SX	-41.259	-41.259	0	%100
17	CA8	SX	-68.765	-68.765	0	%100
18	CA9	SX	-68.765	-68.765	0	%100
19	CA7	SX	-68.765	-68.765	0	%100
20	M32	SX	0	0	0	%100
21	M35	SX	0	0	0	%100



**Member Distributed Loads (BLC 15 : Distr. Wind Load X) (Continued)**

	Member Label	Direction	Start Magnitude[lb/ft,...	End Magn...	Start Location...	End Location[in,%]
22	M36	SX	0	0	0	%100
23	M39A	SX	0	0	0	%100
24	CA3	SX	-68.765	-68.765	0	%100
25	CA4	SX	-68.765	-68.765	0	%100
26	CA1	SX	-68.765	-68.765	0	%100
27	CA2	SX	-68.765	-68.765	0	%100
28	CA5	SX	-68.765	-68.765	0	%100
29	CA6	SX	-68.765	-68.765	0	%100
30	M64	SX	0	0	0	%100
31	M65	SX	0	0	0	%100
32	M66	SX	0	0	0	%100
33	M67	SX	0	0	0	%100
34	M68	SX	0	0	0	%100
35	M69	SX	0	0	0	%100
36	M70	SX	0	0	0	%100
37	M71	SX	0	0	0	%100
38	M72	SX	0	0	0	%100
39	M73	SX	0	0	0	%100
40	M74	SX	0	0	0	%100
41	M75	SX	-68.765	-68.765	0	%100
42	MP2	SX	-41.259	-41.259	0	%100
43	M43	SX	0	0	0	%100
44	M44	SX	0	0	0	%100
45	H3	SX	-41.259	-41.259	0	%100
46	MP7	SX	-41.259	-41.259	0	%100
47	MP9	SX	-41.259	-41.259	0	%100
48	HR3	SX	-41.259	-41.259	0	%100
49	M52	SX	0	0	0	%100
50	M53	SX	0	0	0	%100
51	M54	SX	0	0	0	%100
52	M55	SX	0	0	0	%100
53	H2	SX	-41.259	-41.259	0	%100
54	MP4	SX	-41.259	-41.259	0	%100
55	MP6	SX	-41.259	-41.259	0	%100
56	HR2	SX	-41.259	-41.259	0	%100
57	M66A	SX	0	0	0	%100
58	M67A	SX	0	0	0	%100
59	M68A	SX	0	0	0	%100
60	M69A	SX	0	0	0	%100
61	MP8	SX	-41.259	-41.259	0	%100
62	M68B	SX	0	0	0	%100
63	M69B	SX	0	0	0	%100



**Member Distributed Loads (BLC 15 : Distr. Wind Load X) (Continued)**

	Member Label	Direction	Start Magnitude[lb/ft,...	End Magn...	Start Location...	End Location[in,%]
64	MP5	SX	-41.259	-41.259	0	%100
65	M71B	SX	0	0	0	%100
66	M72B	SX	0	0	0	%100

**Member Distributed Loads (BLC 16 : Ice Weight)**

	Member Label	Direction	Start Magnitude[lb/ft,...	End Magn...	Start Location...	End Location[in,%]
1	S3	Y	-21.757	-21.757	0	%100
2	GA4	Y	-13.976	-13.976	0	%100
3	GA3	Y	-13.976	-13.976	0	%100
4	P3	Y	-24.106	-24.106	0	%100
5	S2	Y	-21.757	-21.757	0	%100
6	GA2	Y	-13.976	-13.976	0	%100
7	GA1	Y	-13.976	-13.976	0	%100
8	P2	Y	-24.106	-24.106	0	%100
9	S1	Y	-21.757	-21.757	0	%100
10	GA6	Y	-13.976	-13.976	0	%100
11	GA5	Y	-13.976	-13.976	0	%100
12	P1	Y	-24.106	-24.106	0	%100
13	H1	Y	-15.823	-15.823	0	%100
14	MP1	Y	-14.104	-14.104	0	%100
15	MP3	Y	-14.104	-14.104	0	%100
16	HR1	Y	-14.118	-14.118	0	%100
17	CA8	Y	-28.108	-28.108	0	%100
18	CA9	Y	-28.108	-28.108	0	%100
19	CA7	Y	-28.108	-28.108	0	%100
20	M32	Y	-6.195	-6.195	0	%100
21	M35	Y	-6.195	-6.195	0	%100
22	M36	Y	-6.195	-6.195	0	%100
23	M39A	Y	-6.195	-6.195	0	%100
24	CA3	Y	-17.084	-17.084	0	%100
25	CA4	Y	-17.084	-17.084	0	%100
26	CA1	Y	-17.084	-17.084	0	%100
27	CA2	Y	-17.084	-17.084	0	%100
28	CA5	Y	-17.084	-17.084	0	%100
29	CA6	Y	-17.084	-17.084	0	%100
30	M64	Y	-6.195	-6.195	0	%100
31	M65	Y	-6.195	-6.195	0	%100
32	M66	Y	-6.195	-6.195	0	%100
33	M67	Y	-6.195	-6.195	0	%100
34	M68	Y	-6.195	-6.195	0	%100
35	M69	Y	-6.195	-6.195	0	%100
36	M70	Y	-6.195	-6.195	0	%100



**Member Distributed Loads (BLC 16 : Ice Weight) (Continued)**

	Member Label	Direction	Start Magnitude[lb/ft,...	End Magn...	Start Location...	End Location[in,%]
37	M71	Y	-6.195	-6.195	0	%100
38	M72	Y	-6.195	-6.195	0	%100
39	M73	Y	-6.195	-6.195	0	%100
40	M74	Y	-6.195	-6.195	0	%100
41	M75	Y	-12.872	-12.872	0	%100
42	MP2	Y	-14.104	-14.104	0	%100
43	M43	Y	-6.195	-6.195	0	%100
44	M44	Y	-6.195	-6.195	0	%100
45	H3	Y	-15.823	-15.823	0	%100
46	MP7	Y	-14.104	-14.104	0	%100
47	MP9	Y	-14.104	-14.104	0	%100
48	HR3	Y	-14.118	-14.118	0	%100
49	M52	Y	-6.195	-6.195	0	%100
50	M53	Y	-6.195	-6.195	0	%100
51	M54	Y	-6.195	-6.195	0	%100
52	M55	Y	-6.195	-6.195	0	%100
53	H2	Y	-15.823	-15.823	0	%100
54	MP4	Y	-14.104	-14.104	0	%100
55	MP6	Y	-14.104	-14.104	0	%100
56	HR2	Y	-14.118	-14.118	0	%100
57	M66A	Y	-6.195	-6.195	0	%100
58	M67A	Y	-6.195	-6.195	0	%100
59	M68A	Y	-6.195	-6.195	0	%100
60	M69A	Y	-6.195	-6.195	0	%100
61	MP8	Y	-14.104	-14.104	0	%100
62	M68B	Y	-6.195	-6.195	0	%100
63	M69B	Y	-6.195	-6.195	0	%100
64	MP5	Y	-14.104	-14.104	0	%100
65	M71B	Y	-6.195	-6.195	0	%100
66	M72B	Y	-6.195	-6.195	0	%100

**Member Distributed Loads (BLC 29 : Distr. Ice Wind Load Z)**

	Member Label	Direction	Start Magnitude[lb/ft,...	End Magn...	Start Location...	End Location[in,%]
1	S3	SZ	-12.866	-12.866	0	%100
2	GA4	SZ	-18.568	-18.568	0	%100
3	GA3	SZ	-18.568	-18.568	0	%100
4	P3	SZ	-12.118	-12.118	0	%100
5	S2	SZ	-12.866	-12.866	0	%100
6	GA2	SZ	-18.568	-18.568	0	%100
7	GA1	SZ	-18.568	-18.568	0	%100
8	P2	SZ	-12.118	-12.118	0	%100
9	S1	SZ	-12.866	-12.866	0	%100



**Member Distributed Loads (BLC 29 : Distr. Ice Wind Load Z) (Continued)**

	Member Label	Direction	Start Magnitude[lb/ft,...	End Magn...	Start Location...	End Location[in,%]
10	GA6	SZ	-18.568	-18.568	0	%100
11	GA5	SZ	-18.568	-18.568	0	%100
12	P1	SZ	-12.118	-12.118	0	%100
13	H1	SZ	-16.38	-16.38	0	%100
14	MP1	SZ	-18.384	-18.384	0	%100
15	MP3	SZ	-18.384	-18.384	0	%100
16	HR1	SZ	-18.364	-18.364	0	%100
17	CA8	SZ	-11.213	-11.213	0	%100
18	CA9	SZ	-11.213	-11.213	0	%100
19	CA7	SZ	-11.213	-11.213	0	%100
20	M32	SZ	0	0	0	%100
21	M35	SZ	0	0	0	%100
22	M36	SZ	0	0	0	%100
23	M39A	SZ	0	0	0	%100
24	CA3	SZ	-15.313	-15.313	0	%100
25	CA4	SZ	-15.313	-15.313	0	%100
26	CA1	SZ	-15.313	-15.313	0	%100
27	CA2	SZ	-15.313	-15.313	0	%100
28	CA5	SZ	-15.313	-15.313	0	%100
29	CA6	SZ	-15.313	-15.313	0	%100
30	M64	SZ	0	0	0	%100
31	M65	SZ	0	0	0	%100
32	M66	SZ	0	0	0	%100
33	M67	SZ	0	0	0	%100
34	M68	SZ	0	0	0	%100
35	M69	SZ	0	0	0	%100
36	M70	SZ	0	0	0	%100
37	M71	SZ	0	0	0	%100
38	M72	SZ	0	0	0	%100
39	M73	SZ	0	0	0	%100
40	M74	SZ	0	0	0	%100
41	M75	SZ	-20.454	-20.454	0	%100
42	MP2	SZ	-18.384	-18.384	0	%100
43	M43	SZ	0	0	0	%100
44	M44	SZ	0	0	0	%100
45	H3	SZ	-16.38	-16.38	0	%100
46	MP7	SZ	-18.384	-18.384	0	%100
47	MP9	SZ	-18.384	-18.384	0	%100
48	HR3	SZ	-18.364	-18.364	0	%100
49	M52	SZ	0	0	0	%100
50	M53	SZ	0	0	0	%100
51	M54	SZ	0	0	0	%100



**Member Distributed Loads (BLC 29 : Distr. Ice Wind Load Z) (Continued)**

	Member Label	Direction	Start Magnitude[lb/ft,...	End Magn...	Start Location...	End Location[in,%]
52	M55	SZ	0	0	0	%100
53	H2	SZ	-16.38	-16.38	0	%100
54	MP4	SZ	-18.384	-18.384	0	%100
55	MP6	SZ	-18.384	-18.384	0	%100
56	HR2	SZ	-18.364	-18.364	0	%100
57	M66A	SZ	0	0	0	%100
58	M67A	SZ	0	0	0	%100
59	M68A	SZ	0	0	0	%100
60	M69A	SZ	0	0	0	%100
61	MP8	SZ	-18.384	-18.384	0	%100
62	M68B	SZ	0	0	0	%100
63	M69B	SZ	0	0	0	%100
64	MP5	SZ	-18.384	-18.384	0	%100
65	M71B	SZ	0	0	0	%100
66	M72B	SZ	0	0	0	%100

**Member Distributed Loads (BLC 30 : Distr. Ice Wind Load X)**

	Member Label	Direction	Start Magnitude[lb/ft,...	End Magn...	Start Location...	End Location[in,%]
1	S3	SX	-12.866	-12.866	0	%100
2	GA4	SX	-18.568	-18.568	0	%100
3	GA3	SX	-18.568	-18.568	0	%100
4	P3	SX	-12.118	-12.118	0	%100
5	S2	SX	-12.866	-12.866	0	%100
6	GA2	SX	-18.568	-18.568	0	%100
7	GA1	SX	-18.568	-18.568	0	%100
8	P2	SX	-12.118	-12.118	0	%100
9	S1	SX	-12.866	-12.866	0	%100
10	GA6	SX	-18.568	-18.568	0	%100
11	GA5	SX	-18.568	-18.568	0	%100
12	P1	SX	-12.118	-12.118	0	%100
13	H1	SX	-16.38	-16.38	0	%100
14	MP1	SX	-18.384	-18.384	0	%100
15	MP3	SX	-18.384	-18.384	0	%100
16	HR1	SX	-18.364	-18.364	0	%100
17	CA8	SX	-11.213	-11.213	0	%100
18	CA9	SX	-11.213	-11.213	0	%100
19	CA7	SX	-11.213	-11.213	0	%100
20	M32	SX	0	0	0	%100
21	M35	SX	0	0	0	%100
22	M36	SX	0	0	0	%100
23	M39A	SX	0	0	0	%100
24	CA3	SX	-15.313	-15.313	0	%100



**Member Distributed Loads (BLC 30 : Distr. Ice Wind Load X) (Continued)**

	Member Label	Direction	Start Magnitude[lb/ft,...	End Magn...	Start Location...	End Location[in, %]
25	CA4	SX	-15.313	-15.313	0	%100
26	CA1	SX	-15.313	-15.313	0	%100
27	CA2	SX	-15.313	-15.313	0	%100
28	CA5	SX	-15.313	-15.313	0	%100
29	CA6	SX	-15.313	-15.313	0	%100
30	M64	SX	0	0	0	%100
31	M65	SX	0	0	0	%100
32	M66	SX	0	0	0	%100
33	M67	SX	0	0	0	%100
34	M68	SX	0	0	0	%100
35	M69	SX	0	0	0	%100
36	M70	SX	0	0	0	%100
37	M71	SX	0	0	0	%100
38	M72	SX	0	0	0	%100
39	M73	SX	0	0	0	%100
40	M74	SX	0	0	0	%100
41	M75	SX	-20.454	-20.454	0	%100
42	MP2	SX	-18.384	-18.384	0	%100
43	M43	SX	0	0	0	%100
44	M44	SX	0	0	0	%100
45	H3	SX	-16.38	-16.38	0	%100
46	MP7	SX	-18.384	-18.384	0	%100
47	MP9	SX	-18.384	-18.384	0	%100
48	HR3	SX	-18.364	-18.364	0	%100
49	M52	SX	0	0	0	%100
50	M53	SX	0	0	0	%100
51	M54	SX	0	0	0	%100
52	M55	SX	0	0	0	%100
53	H2	SX	-16.38	-16.38	0	%100
54	MP4	SX	-18.384	-18.384	0	%100
55	MP6	SX	-18.384	-18.384	0	%100
56	HR2	SX	-18.364	-18.364	0	%100
57	M66A	SX	0	0	0	%100
58	M67A	SX	0	0	0	%100
59	M68A	SX	0	0	0	%100
60	M69A	SX	0	0	0	%100
61	MP8	SX	-18.384	-18.384	0	%100
62	M68B	SX	0	0	0	%100
63	M69B	SX	0	0	0	%100
64	MP5	SX	-18.384	-18.384	0	%100
65	M71B	SX	0	0	0	%100
66	M72B	SX	0	0	0	%100



**Member Distributed Loads (BLC 43 : BLC 1 Transient Area Loads)**

	Member Label	Direction	Start Magnitude[lb/ft,...	End Magn...	Start Location...	End Location[in, %]
1	S2	Y	-3.185	-3.185	16.404	40
2	GA2	Y	-1.605	-1.605	3.828	27.295
3	GA1	Y	-1.605	-1.605	3.828	27.295
4	S3	Y	-3.185	-3.185	16.404	40
5	GA4	Y	-1.605	-1.605	3.828	27.295
6	GA3	Y	-1.605	-1.605	3.828	27.295
7	S1	Y	-3.185	-3.185	16.404	40
8	GA6	Y	-1.605	-1.605	3.828	27.295
9	GA5	Y	-1.605	-1.605	3.828	27.295

**Member Distributed Loads (BLC 44 : BLC 16 Transient Area Loads)**

	Member Label	Direction	Start Magnitude[lb/ft,...	End Magn...	Start Location...	End Location[in, %]
1	S2	Y	-38.224	-38.224	16.404	40
2	GA2	Y	-19.263	-19.263	3.828	27.295
3	GA1	Y	-19.263	-19.263	3.828	27.295
4	S3	Y	-38.224	-38.224	16.404	40
5	GA4	Y	-19.263	-19.263	3.828	27.295
6	GA3	Y	-19.263	-19.263	3.828	27.295
7	S1	Y	-38.224	-38.224	16.404	40
8	GA6	Y	-19.263	-19.263	3.828	27.295
9	GA5	Y	-19.263	-19.263	3.828	27.295

**Member Area Loads (BLC 1 : Self Weight)**

	Joint A	Joint B	Joint C	Joint D	Direction	Distribution	Magnitude[psf]
1	P22	P21	P20	P23	Y	Two Way	-1.75
2	P10	P11	P12	P9	Y	Two Way	-1.75
3	P31	P34	P33	P32	Y	Two Way	-1.75

**Member Area Loads (BLC 16 : Ice Weight)**

	Joint A	Joint B	Joint C	Joint D	Direction	Distribution	Magnitude[psf]
1	P22	P21	P20	P23	Y	Two Way	-21
2	P10	P11	P12	P9	Y	Two Way	-21
3	P31	P34	P33	P32	Y	Two Way	-21

**Envelope AISC 15th(360-16): LRFD Steel Code Checks**

	Member	Shape	Code Check	Loc[in]	LC	She...Loc[in]	Dir	LC	phi*P...	phi*P...	phi*M...	phi*Mn z-z [lb...Cb	Eqn
1	CA1	C3.38x2.06...	.333	0	31	.057 28.188	y	36	4776...	56700	2202...	5751.945	1.... H1-1b
2	S2	HSS4X4X6	.329	0	32	.117 0	y	32	1882...	1978...	2204...	22045.5	1.... H1-1b
3	CA3	C3.38x2.06...	.303	0	27	.056 28.188	y	32	4776...	56700	2202...	5751.945	1.... H1-1b



**Envelope AISC 15th(360-16): LRFD Steel Code Checks (Continued)**

Member	Shape	Code Check	Loc[in]	LC	She...	Loc[in]	Dir	LC	phi*P...	phi*P...	phi*M...	phi*Mn z-z	lb...	Cb	Eqn
4	CA5	C3.38x2.06...	.301	0	35	.055	28.187	y	28	4776...	56700	2202...	5751.945	1...	H1-1b
5	S3	HSS4X4X6	.298	0	38	.117	0	y	29	1882...	1978...	2204...	22045.5	1...	H1-1b
6	P2	PL6.5x0.375	.290	21	31	.117	21	y	31	3658...	78975	616.9...	8388.66	1...	H1-1b
7	CA4	C3.38x2.06...	.270	33	27	.047	33	y	31	4776...	56700	2202...	5751.945	1...	H1-1b
8	CA6	C3.38x2.06...	.269	33	30	.046	33	y	38	4776...	56700	2202...	5751.945	1...	H1-1b
9	CA2	C3.38x2.06...	.266	33	31	.048	33	y	34	4776...	56700	2202...	5751.945	1...	H1-1b
10	S1	HSS4X4X6	.264	0	36	.107	0	y	86	1882...	1978...	2204...	22045.5	1...	H1-1b
11	P3	PL6.5x0.375	.263	21	2	.167	36.312	y	30	3658...	78975	616.9...	8009.997	1...	H1-1b
12	P1	PL6.5x0.375	.240	21	10	.132	36.312	y	27	3658...	78975	616.9...	8008.018	1...	H1-1b
13	CA8	L6.6x4.46x0...	.208	41.562	22	.030	42	z	4	5117...	87561	2464...	7125.374	1...	H2-1
14	M75	PL 2.375x0.5	.207	1.5	12	.269	0	y	28	3825...	38475	400.7...	1903.711	2...	H1-1b
15	HR2	2.88x0.120	.205	90	3	.102	92		4	2249...	4307...	3155...	3155.674	1...	H1-1b
16	CA7	L6.6x4.46x0...	.204	41.562	3	.028	42	z	8	5117...	87561	2464...	7125.374	1...	H2-1
17	HR3	2.88x0.120	.202	6	2	.095	92		6	2249...	4307...	3155...	3155.674	1...	H1-1b
18	HR1	2.88x0.120	.197	6	4	.090	6		4	2249...	4307...	3155...	3155.674	1...	H1-1b
19	CA9	L6.6x4.46x0...	.186	41.562	18	.026	42	z	12	5117...	87561	2464...	7125.374	1...	H2-1
20	MP2	PIPE 2.5	.172	70	5	.061	70		5	3348...	66654	4726.5	4726.5	4...	H1-1b
21	MP5	PIPE 2.5	.166	70	7	.052	70		7	3348...	66654	4726.5	4726.5	4...	H1-1b
22	GA4	L2x2x4	.158	0	2	.011	27.295	y	9	2952...	42480	959.63	2190.068	2...	H2-1
23	MP8	PIPE 2.5	.149	70	9	.064	70		3	3348...	66654	4726.5	4726.5	4...	H1-1b
24	GA5	L2x2x4	.149	0	9	.025	27.295	y	38	2952...	42480	959.63	2190.068	2...	H2-1
25	GA2	L2x2x4	.144	0	12	.012	0	y	12	2952...	42480	959.63	2190.068	2...	H2-1
26	GA1	L2x2x4	.135	0	6	.026	27.295	y	34	2952...	42480	959.63	2190.068	2...	H2-1
27	MP9	PIPE 2.5	.134	70	2	.060	70		7	3348...	66654	4726.5	4726.5	3...	H1-1b
28	GA3	L2x2x4	.134	0	7	.027	27.295	y	30	2952...	42480	959.63	2190.068	2...	H2-1
29	GA6	L2x2x4	.133	0	4	.011	0	y	4	2952...	42480	959.63	2190.068	2...	H2-1
30	MP6	PIPE 2.5	.122	70	7	.066	70		6	3348...	66654	4726.5	4726.5	4...	H1-1b
31	MP1	PIPE 2.5	.119	70	11	.073	26		8	3348...	66654	4726.5	4726.5	2...	H1-1b
32	MP3	PIPE 2.5	.116	70	5	.067	70		3	3348...	66654	4726.5	4726.5	4...	H1-1b
33	MP4	PIPE 2.5	.116	70	7	.067	26		4	3348...	66654	4726.5	4726.5	1...	H1-1b
34	MP7	PIPE 2.5	.113	70	9	.060	26		6	3348...	66654	4726.5	4726.5	3...	H1-1b
35	H1	Pipe3.5x0.1...	.104	90	31	.057	48		4	4587...	7158...	6337...	6337.65	2...	H1-1b
36	H3	Pipe3.5x0.1...	.103	31	2	.067	90		27	4587...	7158...	6337...	6337.65	1...	H1-1b
37	H2	Pipe3.5x0.1...	.098	31	6	.056	90		34	4587...	7158...	6337...	6337.65	1...	H1-1b

## Bolt Calculation Tool, V1.5.1

PROJECT DATA	
Site Name:	BOBDL00152B
Site Number:	BOBDL00152B
Connection Description:	Platform to Monopole

MAXIMUM BOLT LOADS		
Bolt Tension:	8724.09	lbs
Bolt Shear:	1646.68	lbs

WORST CASE BOLT LOADS <sup>1</sup>		
Bolt Tension:	8724.09	lbs
Bolt Shear:	1556.05	lbs

BOLT PROPERTIES		
Bolt Type:	Bolt	-
Bolt Diameter:	0.625	in
Bolt Grade:	A325	-
# of Bolts:	4	-
Threads Excluded?	No	-

<sup>1</sup> Worst case bolt loads correspond to Load combination #32 on member S2 in RISA-3D, which causes the maximum demand on the bolts.

Member Information
I nodes of S3, S2, S1

BOLT CHECK		
Tensile Strength	20340.15	
Shear Strength	13805.83	
Max Tensile Usage	42.9%	
Max Shear Usage	11.9%	
Interaction Check (Worst Case)	0.20	≤1.05
Result	Pass	

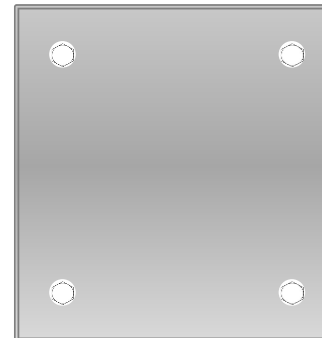

# POWER DENSITY STUDY

RADIO FREQUENCY EMISSIONS ANALYSIS REPORT  
EVALUATION OF HUMAN EXPOSURE POTENTIAL  
TO NON-IONIZING EMISSIONS

Dish Wireless Existing Facility

Site ID: BOBDL00152B

BOBDL00152B

Canton - 309 East Hill Rd (fka Hoffman Road)  
Canton, Connecticut 06019

**October 5, 2021**

**EBI Project Number: 6221003986**

Site Compliance Summary	
Compliance Status:	<b>COMPLIANT</b>
Site total MPE% of FCC general population allowable limit:	<b>12.81%</b>

October 5, 2021

Dish Wireless

Emissions Analysis for Site: BOBDL00152B - BOBDL00152B

EBI Consulting was directed to analyze the proposed Dish Wireless facility located at **Canton - 309 East Hill Rd (fka Hoffman Road)** in **Canton, Connecticut** for the purpose of determining whether the emissions from the Proposed Dish Wireless Antenna Installation located on this property are within specified federal limits.

All information used in this report was analyzed as a percentage of current Maximum Permissible Exposure (% MPE) as listed in the FCC OET Bulletin 65 Edition 97-01 and ANSI/IEEE Std C95.1. The FCC regulates Maximum Permissible Exposure in units of microwatts per square centimeter ( $\mu\text{W}/\text{cm}^2$ ). The number of  $\mu\text{W}/\text{cm}^2$  calculated at each sample point is called the power density. The exposure limit for power density varies depending upon the frequencies being utilized. Wireless Carriers and Paging Services use different frequency bands each with different exposure limits; therefore, it is necessary to report results and limits in terms of percent MPE rather than power density.

All results were compared to the FCC (Federal Communications Commission) radio frequency exposure rules, 47 CFR 1.1307(b)(1) – (b)(3), to determine compliance with the Maximum Permissible Exposure (MPE) limits for General Population/Uncontrolled environments as defined below.

General population/uncontrolled exposure limits apply to situations in which the general population may be exposed or in which persons who are exposed as a consequence of their employment may not be made fully aware of the potential for exposure or cannot exercise control over their exposure. Therefore, members of the general population would always be considered under this category when exposure is not employment related, for example, in the case of a telecommunications tower that exposes persons in a nearby residential area.

Public exposure to radio frequencies is regulated and enforced in units of microwatts per square centimeter ( $\mu\text{W}/\text{cm}^2$ ). The general population exposure limits for the 600 MHz and 700 MHz frequency bands are approximately  $400 \mu\text{W}/\text{cm}^2$  and  $467 \mu\text{W}/\text{cm}^2$ , respectively. The general population exposure limit for the 1900 MHz (PCS), 2100 MHz (AWS) and 11 GHz frequency bands is  $1000 \mu\text{W}/\text{cm}^2$ . Because each carrier will be using different frequency bands, and each frequency band has different exposure limits, it is necessary to report percent of MPE rather than power density.

Occupational/controlled exposure limits apply to situations in which persons are exposed as a consequence of their employment and in which those persons who are exposed have been made fully

aware of the potential for exposure and can exercise control over their exposure. Occupational/controlled exposure limits also apply where exposure is of a transient nature as a result of incidental passage through a location where exposure levels may be above general population/uncontrolled limits (see below), as long as the exposed person has been made fully aware of the potential for exposure and can exercise control over his or her exposure by leaving the area or by some other appropriate means.

Additional details can be found in FCC OET 65.

## **CALCULATIONS**

Calculations were done for the proposed Dish Wireless Wireless antenna facility located at Canton - 309 East Hill Rd (fka Hoffman Road) in Canton, Connecticut using the equipment information listed below. All calculations were performed per the specifications under FCC OET 65. Since Dish Wireless is proposing highly focused directional panel antennas, which project most of the emitted energy out toward the horizon, all calculations were performed assuming a lobe representing the maximum gain of the antenna per the antenna manufacturer's supplied specifications, minus 20 dB for directional panel antennas and 20 dB for highly focused parabolic microwave dishes, was focused at the base of the tower. For this report, the sample point is the top of a 6-foot person standing at the base of the tower.

For all calculations, all equipment was calculated using the following assumptions:

- 1) 4 n71 channels (600 MHz Band) were considered for each sector of the proposed installation. These Channels have a transmit power of 30 Watts per Channel.
- 2) 4 n70 channels (PCS Band - 1900 MHz) were considered for each sector of the proposed installation. These Channels have a transmit power of 40 Watts per Channel.
- 3) 4 n66 channels (AWS Band - 2190 MHz) were considered for each sector of the proposed installation. These Channels have a transmit power of 40 Watts per Channel.
- 4) All radios at the proposed installation were considered to be running at full power and were uncombined in their RF transmissions paths per carrier prescribed configuration. Per FCC OET Bulletin No. 65 - Edition 97-01 recommendations to achieve the maximum anticipated value at each sample point, all power levels emitting from the proposed antenna installation are increased by a factor of 2.56 to account for possible in-phase reflections from the surrounding environment. This is rarely the case, and if so, is never continuous.
- 5) For the following calculations, the sample point was the top of a 6-foot person standing at the base of the tower. The maximum gain of the antenna per the antenna manufacturer's supplied specifications, minus 20 dB for directional panel antennas and 20 dB for highly focused parabolic microwave dishes, was used in this direction. This value is a very conservative

estimate as gain reductions for these particular antennas are typically much higher in this direction.

- 6) The antennas used in this modeling are the JMA MX08FRO665-21 for the 600 MHz / 1900 MHz / 2190 MHz channel(s) in Sector A, the JMA MX08FRO665-21 for the 600 MHz / 1900 MHz / 2190 MHz channel(s) in Sector B, the JMA MX08FRO665-21 for the 600 MHz / 1900 MHz / 2190 MHz channel(s) in Sector C.. This is based on feedback from the carrier with regard to anticipated antenna selection. All Antenna gain values and associated transmit power levels are shown in the Site Inventory and Power Data table below. The maximum gain of the antenna per the antenna manufacturer's supplied specifications, minus 20 dB for directional panel antennas and 20 dB for highly focused parabolic microwave dishes, was used for all calculations. This value is a very conservative estimate as gain reductions for these particular antennas are typically much higher in this direction.
- 7) The antenna mounting height centerline of the proposed antennas is 108 feet above ground level (AGL).
- 8) Emissions values for additional carriers were taken from the Connecticut Siting Council active database. Values in this database are provided by the individual carriers themselves.
- 9) All calculations were done with respect to uncontrolled / general population threshold limits.

## Dish Wireless Site Inventory and Power Data

Sector:	A	Sector:	B	Sector:	C
Antenna #:	1	Antenna #:	1	Antenna #:	1
Make / Model:	JMA MX08FRO665-21	Make / Model:	JMA MX08FRO665-21	Make / Model:	JMA MX08FRO665-21
Frequency Bands:	600 MHz / 1900 MHz / 2190 MHz	Frequency Bands:	600 MHz / 1900 MHz / 2190 MHz	Frequency Bands:	600 MHz / 1900 MHz / 2190 MHz
Gain:	17.45 dBd / 22.65 dBd / 22.65 dBd	Gain:	17.45 dBd / 22.65 dBd / 22.65 dBd	Gain:	17.45 dBd / 22.65 dBd / 22.65 dBd
Height (AGL):	108 feet	Height (AGL):	108 feet	Height (AGL):	108 feet
Channel Count:	12	Channel Count:	12	Channel Count:	12
Total TX Power (W):	440 Watts	Total TX Power (W):	440 Watts	Total TX Power (W):	440 Watts
ERP (W):	5,236.31	ERP (W):	5,236.31	ERP (W):	5,236.31
Antenna AI MPE %:	<b>2.27%</b>	Antenna BI MPE %:	<b>2.27%</b>	Antenna CI MPE %:	<b>2.27%</b>



Site Composite MPE %	
Carrier	MPE %
Dish Wireless (Max at Sector A):	2.27%
Verizon	6.59%
AT&T	2.31%
T-Mobile	1.64%
<b>Site Total MPE % :</b>	<b>12.81%</b>

Dish Wireless MPE % Per Sector	
Dish Wireless Sector A Total:	2.27%
Dish Wireless Sector B Total:	2.27%
Dish Wireless Sector C Total:	2.27%
<b>Site Total MPE % :</b>	<b>12.81%</b>

Dish Wireless Maximum MPE Power Values (Sector A)							
Dish Wireless Frequency Band / Technology (Sector A)	# Channels	Watts ERP (Per Channel)	Height (feet)	Total Power Density ( $\mu\text{W}/\text{cm}^2$ )	Frequency (MHz)	Allowable MPE ( $\mu\text{W}/\text{cm}^2$ )	Calculated % MPE
Dish Wireless 600 MHz n71	4	223.68	108.0	3.09	600 MHz n71	400	0.77%
Dish Wireless 1900 MHz n70	4	542.70	108.0	7.50	1900 MHz n70	1000	0.75%
Dish Wireless 2190 MHz n66	4	542.70	108.0	7.50	2190 MHz n66	1000	0.75%
						<b>Total:</b>	<b>2.27%</b>

• NOTE: Totals may vary by approximately 0.01% due to summation of remainders in calculations.

## Summary

All calculations performed for this analysis yielded results that were **within** the allowable limits for general population exposure to RF Emissions.

The anticipated maximum composite contributions from the Dish Wireless facility as well as the site composite emissions value with regards to compliance with FCC's allowable limits for general population exposure to RF Emissions are shown here:

Dish Wireless Sector	Power Density Value (%)
Sector A:	2.27%
Sector B:	2.27%
Sector C:	2.27%
Dish Wireless Maximum MPE % (Sector A):	2.27%
Site Total:	12.81%
Site Compliance Status:	<b>COMPLIANT</b>

The anticipated composite MPE value for this site assuming all carriers present is **12.81%** of the allowable FCC established general population limit sampled at the ground level. This is based upon values listed in the Connecticut Siting Council database for existing carrier emissions.

FCC guidelines state that if a site is found to be out of compliance (over allowable thresholds), that carriers over a 5% contribution to the composite value will require measures to bring the site into compliance. For this facility, the composite values calculated were well within the allowable 100% threshold standard per the federal government.



November 09, 2021

Dear Customer,

The following is the proof-of-delivery for tracking number: 775109432861

---

**Delivery Information:**

---

<b>Status:</b>	Delivered	<b>Delivered To:</b>	Residence
<b>Signed for by:</b>	Signature not required	<b>Delivery Location:</b>	90 PARK RD
<b>Service type:</b>	FedEx 2Day		
<b>Special Handling:</b>	Deliver Weekday; Residential Delivery		BARKHAMSTED, CT, 06063
		<b>Delivery date:</b>	Nov 9, 2021 13:24

---

**Shipping Information:**

---

<b>Tracking number:</b>	775109432861	<b>Ship Date:</b>	Nov 5, 2021
		<b>Weight:</b>	1.0 LB/0.45 KG

**Recipient:**  
James H. & Katherine E. Hart,  
90 Park Rd  
BARKHAMSTED, CT, US, 06063

**Shipper:**  
Corey Milan, NB+C  
100 Apollo Dr.  
Suite 303  
CHELMSFORD, MA, US, 01824

**Reference** 100814

Thank you for choosing FedEx

Dear Customer,

The following is the proof-of-delivery for tracking number: 775109397763

---

**Delivery Information:**

---

<b>Status:</b>	Delivered	<b>Delivered To:</b>	Receptionist/Front Desk
<b>Signed for by:</b>	L.SMITH	<b>Delivery Location:</b>	4 MARKET ST
<b>Service type:</b>	FedEx 2Day		
<b>Special Handling:</b>	Deliver Weekday		COLLINSVILLE, CT, 06022
		<b>Delivery date:</b>	Nov 9, 2021 11:17

---

**Shipping Information:**

---

<b>Tracking number:</b>	775109397763	<b>Ship Date:</b>	Nov 5, 2021
		<b>Weight:</b>	1.0 LB/0.45 KG

**Recipient:**  
Jerry Waters,  
PO Box 168  
4 Market Street  
COLLINSVILLE, CT, US, 06022

**Shipper:**  
Corey Milan, NB+C  
100 Apollo Dr.  
Suite 303  
CHELMSFORD, MA, US, 01824

**Reference** 100814



Dear Customer,

The following is the proof-of-delivery for tracking number: 775109368480

---

**Delivery Information:**

---

<b>Status:</b>	Delivered	<b>Delivered To:</b>	Receptionist/Front Desk
<b>Signed for by:</b>	L.SMITH	<b>Delivery Location:</b>	4 MARKET ST
<b>Service type:</b>	FedEx 2Day		
<b>Special Handling:</b>	Deliver Weekday		COLLINSVILLE, CT, 06022
		<b>Delivery date:</b>	Nov 9, 2021 11:17

---

**Shipping Information:**

---

<b>Tracking number:</b>	775109368480	<b>Ship Date:</b>	Nov 5, 2021
		<b>Weight:</b>	3.0 LB/1.36 KG

**Recipient:**  
Robert Bessel,  
PO Box 168  
4 Market Street  
COLLINSVILLE, CT, US, 06022

**Shipper:**  
Corey Milan, NB+C  
100 Apollo Dr.  
Suite 303  
CHELMSFORD, MA, US, 01824

**Reference** 100814

