



STATE OF CONNECTICUT
CONNECTICUT SITING COUNCIL

Ten Franklin Square, New Britain, CT 06051
Phone: (860) 827-2935 Fax: (860) 827-2950
E-Mail: siting.council@ct.gov
www.ct.gov/csc

September 16, 2009

Thomas J. Regan, Esq.
Brown Rudnick LLP
CityPlace I, 185 Asylum Street
Hartford, CT 06103

RE: **EM-T-MOBILE-017-090813** – T-Mobile USA, Inc. notice of intent to modify an existing telecommunications facility located at 371 Terryville Avenue, Bristol, Connecticut.

Dear Attorney Regan:

The Connecticut Siting Council (Council) hereby acknowledges your notice to modify this existing telecommunications facility, pursuant to Section 16-50j-73 of the Regulations of Connecticut State Agencies.

The proposed modifications are to be implemented as specified here and in your notice dated August 13, 2009, including the placement of all necessary equipment and shelters within the tower compound. The modifications are in compliance with the exception criteria in Section 16-50j-72 (b) of the Regulations of Connecticut State Agencies as changes to an existing facility site that would not increase tower height, extend the boundaries of the tower site, increase noise levels at the tower site boundary by six decibels, and increase the total radio frequencies electromagnetic radiation power density measured at the tower site boundary to or above the standard adopted by the State Department of Environmental Protection pursuant to General Statutes § 22a-162. This facility has also been carefully modeled to ensure that radio frequency emissions are conservatively below State and federal standards applicable to the frequencies now used on this tower.

This decision is under the exclusive jurisdiction of the Council. Please be advised that the validity of this action shall expire one year from the date of this letter. Any additional change to this facility will require explicit notice to this agency pursuant to Regulations of Connecticut State Agencies Section 16-50j-73. Such notice shall include all relevant information regarding the proposed change with cumulative worst-case modeling of radio frequency exposure at the closest point of uncontrolled access to the tower base, consistent with Federal Communications Commission, Office of Engineering and Technology, Bulletin 65. Any deviation from this format may result in the Council implementing enforcement proceedings pursuant to General Statutes § 16-50u including, without limitation, imposition of expenses resulting from such failure and of civil penalties in an amount not less than one thousand dollars per day for each day of construction or operation in material violation.

Thank you for your attention and cooperation.

Very truly yours,



S. Derek Phelps
Executive Director

SDP/MP/laf

c: The Honorable Art Ward, Mayor, City of Bristol
Alan Weiner, Planner/Dev. Coordinator, City of Bristol
Christopher B. Fisher, Esq., Cuddy & Feder LLP



STATE OF CONNECTICUT
CONNECTICUT SITING COUNCIL

Ten Franklin Square, New Britain, CT 06051
Phone: (860) 827-2935 Fax: (860) 827-2950
E-Mail: siting.council@ct.gov
www.ct.gov/csc

August 17, 2009

The Honorable Art Ward
Mayor
City of Bristol
City Hall
111 North Main Street
P.O.Box 114
Bristol, CT 06010-0114

RE: **EM-T-MOBILE-017-090813** – T-Mobile USA, Inc. notice of intent to modify an existing telecommunications facility located at 371 Terryville Avenue, Bristol, Connecticut.

Dear Mayor Ward:

The Connecticut Siting Council (Council) received this request to modify an existing telecommunications facility, pursuant to Regulations of Connecticut State Agencies Section 16-50j-72.

If you have any questions or comments regarding this proposal, please call me or inform the Council by August 31, 2009.

Thank you for your cooperation and consideration.

Very truly yours,

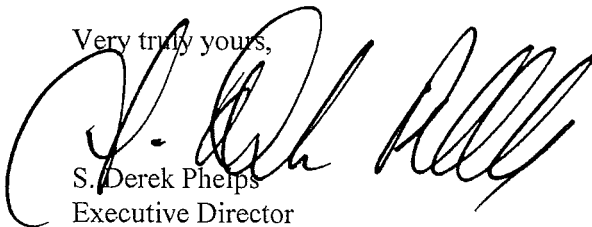

S. Derek Phelps
Executive Director

SDP/laf

Enclosure: Notice of Intent

c: Alan Weiner, Planner/Dev. Coordinator, City of Bristol

THOMAS J. REGAN
Direct Dial: (860) 509-6522
tregan@brownrudnick.com



CityPlace I
185 Asylum
Street
Hartford
Connecticut
06103
tel 860.509.6500
fax 860.509.6501

EM-T-MOBILE-017-090813

Via Hand Delivery

August 13, 2009

RECEIVED
AUG 13 2009
CONNECTICUT
SITING COUNCIL

Daniel F. Caruso, Chairman
Connecticut Siting Council
10 Franklin Square
New Britain, CT 06051

RE: T-Mobile USA, Inc - Exempt Modification

Dear Mr. Caruso:

Enclosed for filing are an original and five copies of T-Mobile USA, Inc.'s Notice of Exempt Modification to an existing monopole at 371 Terryville Avenue in Bristol.

I have also enclosed a sixth copy of the Notice which I would like to have date-stamped and returned to the courier delivering this package.

A check in the amount of \$500.00 is enclosed to cover the filing fee. If you have any questions, please feel free to contact me.

Very truly yours,

BROWN RUDNICK LLP

By: Thomas J. Regan
Thomas J. Regan

Enclosures

40263287 v1 - MERCIECM - 025064/0016

b
r
o
w
n
r
u
d
n
i
c
k
c
o
m

CONNECTICUT SITING COUNCIL

In re:

T-Mobile USA, Inc. Notice to Make an Exempt : **EXEMPT MODIFICATION NO.** _____
Modification to an Existing Facility at 371 :
Terryville Avenue, Bristol, Connecticut. : August 13, 2009

NOTICE OF EXEMPT MODIFICATION

Pursuant to Conn. Agencies Regs. §§ 16-50j-73 and 16-50j-72(b), T-Mobile USA, Inc. ("T-Mobile") hereby gives notice to the Connecticut Siting Council ("Council") and the Town of Bristol of T-Mobile's intent to make an exempt modification to an existing monopole tower (the "Tower") located at 371 Terryville Avenue in Bristol, Connecticut. Specifically, T-Mobile plans to upgrade its wireless system in Connecticut by implementing its Universal Mobile Telecommunications System ("UMTS"). UMTS is a third-generation ("3G") technology that utilizes a code division multiple access ("CDMA") base to allow for fast and large data transfers. To accomplish this upgrade, T-Mobile must modify its antenna and equipment configurations at many of its existing sites.

Once the UMTS upgrade is complete, T-Mobile will operate on a more unified communication system, allowing international wireless telephones to function world-wide. Furthermore, UMTS will enhance Global Positioning System ("GPS") navigation capabilities and provide emergency responders with more advanced tracking capabilities. The proposed UMTS technology is compatible with the existing second-generation ("2G") Global System for Mobile Communication ("GSM") currently on the Tower and the

proposed upgrade is expected to enhance the existing 2G system. At this site T-Mobile proposes to add UMTS technology and install associated equipment at the base of the Tower.

Under the Council's regulations (Conn. Agencies Regs. § 16-50j-72(b)), T-Mobile's plans do not constitute a modification subject to the Council's review because T-Mobile will not change the height of the Tower, will not extend the boundaries of the compound, will not increase the noise levels at the site, and will not increase the total radio frequency electromagnetic radiation power density at the site to levels above applicable standards.

The Tower is a 170-foot monopole tower located at 371 Terryville Avenue in Bristol, Connecticut (41° 40' 51.204" / 72° 57' 56.519"). There are multiple carriers located on the Tower. The Tower is owned by AT&T. Currently, T-Mobile has 3 GSM dual pole antennas and 3 Tower Mounted Amplifiers ("TMA") that will remain. The antennas have a centerline of 130 feet. A site plan with Tower specifications is attached.

T-Mobile plans to add 3 new quad pole UMTS antennas (1 per sector) and 3 UMTS Twin TMAs (1 per sector) to the Tower. The proposed antennas and TMAs will have the same centerline as the existing antennas and TMAs – 130 feet. To confirm the Tower can support these changes, AT&T commissioned GDP Associates to perform a structural analysis of the Tower (attached). According to the structural analysis, dated May 19, 2009, the "tower and its foundation are sufficient for the proposed, existing, and reserved loadings..." (Page 1, Structural Analysis).

In addition, T-Mobile plans to run 6, 1-5/8 inch coax cables inside the Tower. T-Mobile plans to install the UMTS equipment cabinet on its existing 20-foot by 10-foot concrete pad. Hence, no increase in the size of the concrete pad or compound is necessary. The proposed telephone and electrical conduits will be located on top of the existing concrete pad from the existing power protection cabinet to the proposed UMTS equipment cabinet.

Therefore, excluding brief, minor, construction-related noise during the addition of the antennas and the installation of the equipment cabinet, T-Mobile's changes to the Tower will not increase noise levels at the site.

The proposed antennas and TMA will not adversely impact the health and safety of the surrounding community or the people working on the Tower. The total radio frequency exposure measured around the Tower will be below the National Council on Radiation Protection and Measurements' ("NCRP") standard adopted by the Federal Communications Commission ("FCC"). The worst-case power density analysis measured at the base of the Tower indicates that T-Mobile's antennas will emit 5.685% of the NCRP's standard for maximum permissible exposure. A cumulative power density analysis indicates that together, all of the antennas on the Tower will emit only 21.025 % of the NCRP's standard for maximum permissible exposure. Therefore, the power density levels will be below the FCC mandated radio frequency exposure limits in all locations around the Tower, even with extremely conservative assumptions. The power density analysis is attached.

In conclusion, T-Mobile's proposed plan to add antennas and TMAs at this site does not constitute a modification subject to the Council's jurisdiction because T-Mobile will not increase the height of the Tower, will not extend the boundaries of the site, will not increase the noise levels at the site, and the total radio frequency electromagnetic radiation power density will stay within all applicable standards. *See* Conn. Agencies Regs. § 16-50j-72.

T-Mobile USA, Inc.

By: Thomas J. Regan
Thomas J. Regan
Brown Rudnick LLP
185 Asylum Street, CityPlace I
Hartford, CT 06103-3402
Email - tregan@brownrudnick.com
Phone - 860.509.6522
Fax - 860.509.6622

Certificate of Service

This is to certify that on this 13th day of August, 2009, the foregoing Notice of Exempt Modification was sent, via first class mail, to the following:

The Honorable Arthur J. Ward, Mayor
City of Bristol
111 North Main Street
Bristol, CT 06010

By: Thomas J. Regan
Thomas J. Regan

40263283 v1 - MERCIECM - 025064/0016

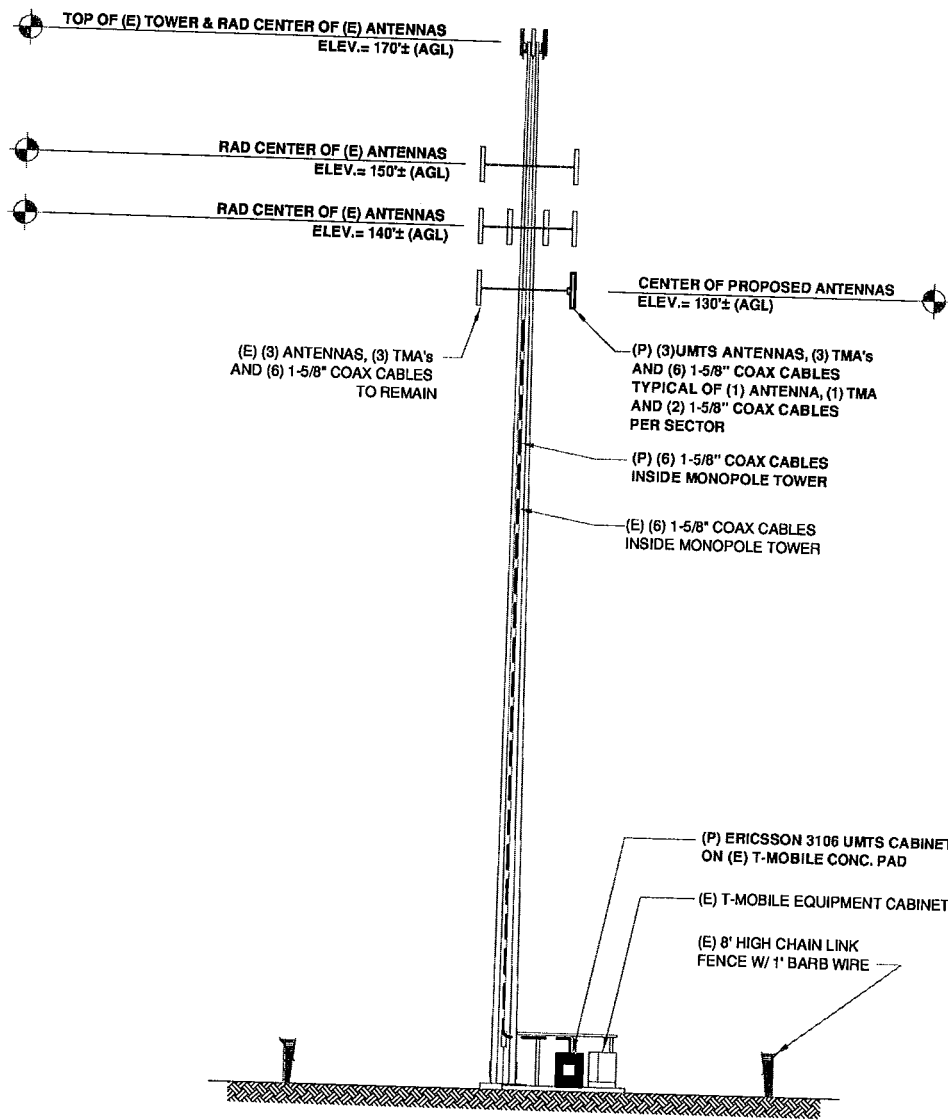

ELEVATION

SCALE: 1" = 30'-0"

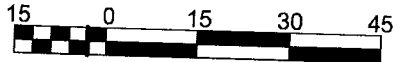

ALL EQUIPMENT LOCATIONS ARE APPROXIMATE AND ARE SUBJECT TO APPROVAL BY LESSEE/LICENSEE'S STRUCTURAL & RF ENGINEERS. LOCATIONS OF POWER & TELEPHONE FACILITIES ARE SUBJECT TO APPROVAL BY UTILITY COMPANIES.

TRANSCEND WIRELESS, LLC

10 INDUSTRIAL AVE.
MAHWAH, NJ 07430
OFFICE: (201) 684-0055
FAX: (201) 684-0066

FOR

OMNIPPOINT COMMUNICATIONS, INC. DBA T-MOBILE USA, INC

35 GRIFFIN ROAD SOUTH
BLOOMFIELD, CT 06002
OFFICE: (860) 692-7100
FAX: (860) 692-7159



15 Cypress St., Suite 300
Newton Centre, MA 02459
Office: 617-965-0789
Fax: 617-663-6032

SITE NUMBER: CTHA114B	
SITE NAME: AT&T 27074	
ADDRESS: 371 TERRYVILLE AVE BRISTOL, CT 06010	
DRAWN BY: G.C.	
1: REVISED	07-31-09
0: FINAL	03-11-09
A: REVIEW	02-12-09
REVISION	DATE

APPROVALS

Site Owner	_____	Date	_____
Construction Manager	_____	Date	_____
RF Engineer	_____	Date	_____
Site Acquisition	_____	Date	_____

The above parties hereby approve and accept these documents and authorize the contractor to proceed with the construction described herein, all construction documents are subject to review by the local building department and any changes or modifications they may impose.

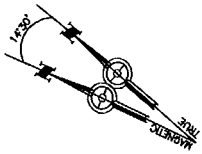

FINAL CONFIGURATION

CABINETS: 2	(E) (1) CABINET TO REMAIN (P) (1) CABINET TO BE ADDED
ANTENNAS: 6	(E) (3) TO REMAIN (P) (3) QUAD POL TO BE ADDED
TMA: 6	(E) (3) TO REMAIN (P) (3) TO BE ADDED
COAX: 12	(E) (6) TO REMAIN (P) (6) TO BE ADDED

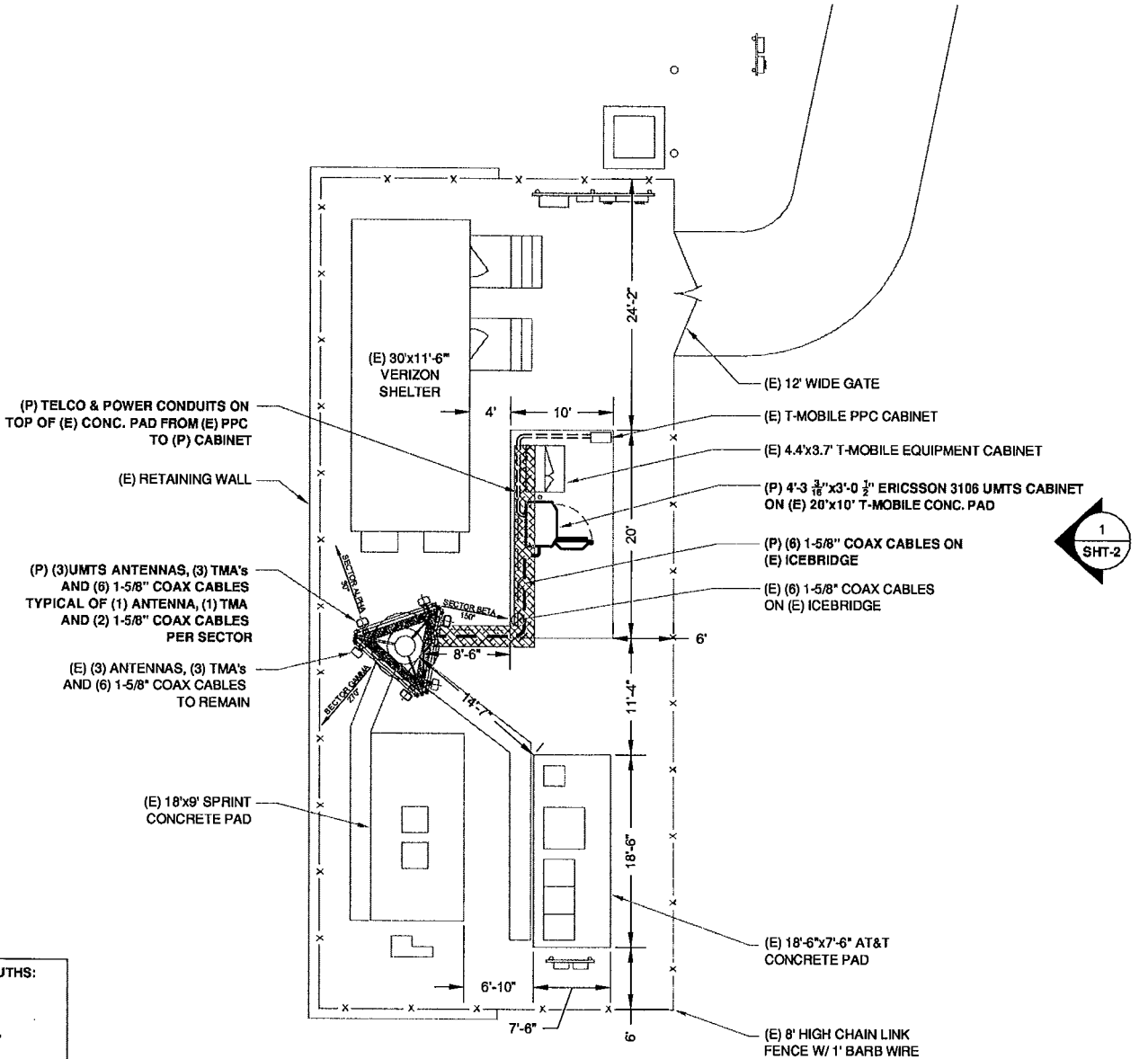

ANTENNA AZIMUTHS:

SECTOR A= 30°
SECTOR B= 150°
SECTOR C= 270°

ALL EQUIPMENT LOCATIONS ARE APPROXIMATE AND ARE SUBJECT TO APPROVAL BY LESSEE/LICENSEE'S STRUCTURAL & RF ENGINEERS. LOCATIONS OF POWER & TELEPHONE FACILITIES ARE SUBJECT TO APPROVAL BY UTILITY COMPANIES.

PLAN

SCALE: 1" = 16'-0"

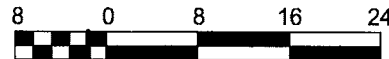

TRANSCEND WIRELESS, LLC

10 INDUSTRIAL AVE
MAHWAH, NJ 07430
OFFICE: (201) 684-0055
FAX: (201) 684-0066

FOR

**OMNIPOINT COMMUNICATIONS, INC.
DBA T-MOBILE USA, INC**

35 GRIFFIN ROAD SOUTH
BLOOMFIELD, CT 06002
OFFICE: (860) 692-7100
FAX: (860) 692-7159



15 Cypress St., Suite 300
Newton Centre, MA 02459
Office: 617-965-0789
Fax: 617-663-6032

SITE NUMBER: CTHA114B	
SITE NAME: AT&T 27074	
ADDRESS: 371 TERRYVILLE AVE BRISTOL, CT 06010	
DRAWN BY G.C.	
1: REVISED	07-31-09
0: FINAL	03-11-09
A: REVIEW	02-12-09
REVISION	DATE

APPROVALS	
Site Owner	_____ Date _____
Construction Manager	_____ Date _____
RF Engineer	_____ Date _____
Site Acquisition	_____ Date _____
The above parties hereby approve and accept these documents and authorize the contractor to proceed with the construction described herein, all construction documents are subject to review by the local building department and any changes or modifications they may impose.	



at&t

Dijana Arnautovic
AT&T Mobility
5405 Windward Pkwy
Alpharetta GA. 30004
(770) 708-6114



GPD ASSOCIATES
Kevin Clements
520 South Main St., Suite 2531
Akron, Ohio 44311
(330) 572-2195
kclements@gpdgroup.com

GPD# 2009263.89
May 19, 2009

STRUCTURAL ANALYSIS REPORT

AT&T DESIGNATION:	Site USID:	27074
	Site FA:	10070954
	Site Name:	BRISTOL CENTER
T-MOBILE DESIGNATION:	Site Number:	CTHA114B
ANALYSIS CRITERIA:	Codes:	TIA/EIA-222-F & 2003 IBC 80-mph with 0" ice 69-mph with 1/2" ice

SITE DATA: 371 Terryville Ave., Bristol, CT 06010, Hartford County
Latitude 41° 40' 51.204"N, Longitude 72° 57' 56.519"W
168.5' Monopole

Ms. Arnautovic,

GPD is pleased to submit this Structural Analysis Report to determine the structural integrity of the aforementioned tower. The purpose of the analysis is to determine the suitability of the tower with the addition of the following proposed loading configuration:

Elev. 130' (3) RFS APX16DWV-16DWV-S-E-ACU Antennas on an existing 13' LP Platform w/ (6) 1-5/8" internal coax
(3) Andrew OneBase Twin Dual Duplex Tower Mounted Amplifiers mounted behind the antennas

Based on our analysis we have determined the designs of the tower and its foundation are sufficient for the proposed, existing, and reserved loadings as referenced in Appendix A.

We at GPD appreciate the opportunity of providing our continuing professional services to you and AT&T. If you have any questions please do not hesitate to call.

Respectfully submitted,

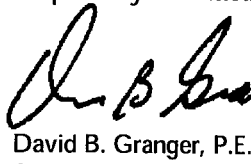
David B. Granger, P.E.
Connecticut #: 17557

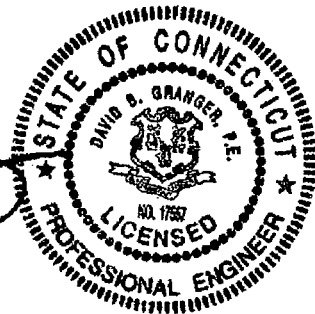

SUMMARY & RESULTS

The purpose of this analysis was to verify whether the existing structure is capable of carrying the proposed loading configuration as specified by T-Mobile to AT&T. This report was commissioned by Ms. Dijana Arnautovic of AT&T.

TOWER SUMMARY AND RESULTS

Member	Capacity	Results
Monopole	82.6%	Pass
Base Plate	85.9%	Pass
Anchor Rods	75.5%	Pass
Foundation	76.9%	Pass

ANALYSIS METHOD

RISA Tower (Version 5.3.0.1), a commercially available software program, was used to create a three-dimensional model of the tower and calculate primary member stresses for various dead, live, wind, and ice load cases. Selected output from the analysis is included in Appendix B. The following table details the information provided to complete this structural analysis. This analysis is solely based on this information and being provided without the benefit of a site visit.

DOCUMENTS PROVIDED

Document	Remarks	Source
Preliminary Tower Summary	T-Mobile Co-location document	Siterra
Site Lease Application	T-Mobile Application, dated 3/26/09	Siterra
Manufacturer Drawings	Engineered Endeavors, Inc., Project #: 12027, dated 12/2/03	Siterra
Geotechnical Report	VN Engineers, Project #: 23-124G, dated 11/11/03	Siterra
Previous Structural Analysis	Malouf Engineering Intl., Inc., Project #: CT00816M-07V0, dated 7/23/07	Siterra
Previous Structural Analysis	GPD Associates Project #: 2008264.33 Rev. 3, dated 9/16/08	Siterra

ASSUMPTIONS

This structural analysis is based on the theoretical capacity of the members and is not a condition assessment of the monopole. This analysis is from information supplied, and therefore, its results are based on and are as accurate as that supplied data. GPD has made no independent determination, nor is it required to, of its accuracy. The following assumptions were made for this structural analysis.

1. The monopole shaft sizes and shape are considered accurate as supplied. The material grade is as per data supplied and/or as assumed and as stated in the materials section.
2. The antenna configuration is as supplied and/or as modeled in the analysis. It is assumed to be complete and accurate. All antennas, mounts, coax and waveguides are assumed to be properly installed and supported as per manufacturer requirements
3. Some assumptions are made regarding antennas and mount sizes and their projected areas based on best interpretation of data supplied and of best knowledge of antenna type and industry practice.
4. All mounts, if applicable, are considered adequate to support the loading. No actual analysis of the mount(s) is performed. This analysis is limited to analyzing the tower only.
5. The soil parameters are as per data supplied or as assumed and stated in the calculations. If no data is available, the foundation system is not verified.
6. The tower and structures have been properly maintained in accordance with TIA Standards and/or with manufacturer's specifications.
7. All welds and connections are assumed to develop at least the member capacity, unless determined otherwise and explicitly stated in this report.
8. Tower Mounted Amplifiers are assumed to be installed behind antennas.
9. All existing loading was obtained from the most recent previous structural analysis by GPD Associates Project #: 2008264.33 Rev. 3, dated 9/16/08, site photos, and the provided preliminary tower summary and is assumed to be accurate.
10. All proposed coax is assumed to be internal to the monopole.

If any of these assumptions are not valid or have been made in error, this analysis may be affected, and GPD Associates should be allowed to review any new information to determine its effect on the structural integrity of the tower.

DISCLAIMER OF WARRANTIES

GPD ASSOCIATES has not performed a site visit to the tower to verify the member sizes or antenna/coax loading. If the existing conditions are not as represented on the tower elevation contained in this report, we should be contacted immediately to evaluate the significance of the discrepancy. This is not a condition assessment of the tower or foundation. This report does not replace a full tower inspection. The tower and foundations are assumed to have been properly fabricated, erected, maintained, in good condition, twist free, and plumb.

The engineering services rendered by GPD ASSOCIATES in connection with this Structural Analysis are limited to a computer analysis of the tower structure and theoretical capacity of its main structural members. All tower components have been assumed to only resist dead loads when no other loads are applied. No allowance was made for any damaged, bent, missing, loose, or rusted members (above and below ground). No allowance was made for loose bolts or cracked welds.

GPD ASSOCIATES does not analyze the fabrication of the structure (including welding). It is not possible to have all the very detailed information needed to perform a thorough analysis of every structural sub-component and connection of an existing tower. GPD ASSOCIATES provides a limited scope of service in that we cannot verify the adequacy of every weld, plate connection detail, etc. The purpose of this report is to assess the feasibility of adding appurtenances usually accompanied by transmission lines to the structure.

It is the owner's responsibility to determine the amount of ice accumulation, if any, that should be considered in the structural analysis.

The attached sketches are a schematic representation of the analyzed tower. If any material is fabricated from these sketches, the contractor shall be responsible for field verifying the existing conditions, proper fit, and clearance in the field. Any mentions of structural modifications are reasonable estimates and should not be used as a precise construction document. Precise modification drawings are obtainable from GPD ASSOCIATES, but are beyond the scope of this report.

Miscellaneous items such as antenna mounts, etc., have not been designed or detailed as a part of our work. We recommend that material of adequate size and strength be purchased from a reputable tower manufacturer.

GPD ASSOCIATES makes no warranties, expressed and/or implied, in connection with this report and disclaims any liability arising from material, fabrication, and erection of this tower. GPD ASSOCIATES will not be responsible whatsoever for, or on account of, consequential or incidental damages sustained by any person, firm, or organization as a result of any data or conclusions contained in this report. The maximum liability of GPD ASSOCIATES pursuant to this report will be limited to the total fee received for preparation of this report.

APPENDIX A

Tower Analysis Summary Form

Tower Analysis Summary Form

General Info	
Site Name	BRISTOL CENTER
Site Number	27074
FA Number	10070954
Date of Analysis	5/19/2009
Company Performing Analysis	GPD

The information contained in this summary report is not to be used independently from the PE stamped tower analysis.

Tower Info	
Tower Type (G, SST, MP)	MP
Tower Height (top of steel AGL)	165.5
Tower Manufacturer	EEL
Tower Model	n/a
Manufacturer Drawings	EEL, Inc. Project #: 12027
Foundation Design	EEL, Inc. Project #: 12027
Geotech Report	WN Engineers Project #: 23-124G
Tower Mapping	n/a
Previous Structural Analysis	GPD, Project #: 20092564.23, Rev. 3
Modification Drawings	n/a

Design Parameters	
Design Code Used	TIA/EIA-222-F
Location of Tower (County, State)	Hartford, Connecticut
Basic Wind Speed (mb)	80-fastest
Ice Thickness (in)	0.5
Structure Classification (I, II, III)	
Exposure Category (B, C, D)	
Topographic Category (1 to 5)	

Analysis Results (% Maximum Usage)	
Tower	85.9%
Foundation	76.9%
Guy Wire	n/a

Steel Yield Strength (ksi)	
Pole	65
Base Plate	60
Anchor Rods	75

Existing / Reserved Loading

Antenna Owner	Mount Height (ft)	Antenna Cl. (ft)	Antenna			Mount			Transmission Line					
			Quantity	Type	Manufacturer	Model	Quantity	Manufacturer	Type	Quantity	Model	Size	Attachment Leg/Face	
AT&T Mobility	169	169	3	Panel	Kathrein	300-10121	3		pipe mount	Unknown	4-5/8"	6	Unknown	Internal
AT&T Mobility	169	169	6	TMA	Powerwave	LGP 2140T	6		on same mount	Unknown	3/8"	1	Unknown	Internal
Sprint	166	166	6	Panel	Decebel	DB950F4072E-M	3		12' T-Arm	Unknown	1-5/8"	6	Unknown	Internal
Verizon	146	146	6	Panel	Anel	LPD-6513	1		13' LP Platform	Unknown	1-5/8"	6	Unknown	Internal
Verizon	146	146	6	Panel	Anel	LPD-1650S38CFX7	1		on same mount	Unknown	1-5/8"	6	Unknown	Internal
T-Mobile	130	130	3	Panel	RFS	APX13-209014-C	1		13' LP Platform	Unknown	1-5/8"	6	Unknown	Internal
T-Mobile	130	130	3	TMA	Andrew	OneBase™ Twin Dual Duplex	30,150,270		on same mount	Unknown	1-5/8"	6	Unknown	Internal
Sprint	70	70	1	GPS	Unknown	GPS Unit	1		pipe mount	Unknown	1/2"	1	Unknown	Internal

Proposed Loading

Antenna Owner	Mount Height (ft)	Antenna Cl. (ft)	Antenna			Mount			Transmission Line					
			Quantity	Type	Manufacturer	Model	Quantity	Manufacturer	Type	Quantity	Model	Size	Attachment Leg/Face	
T-Mobile	130	130	3	Panel	RFS	APX16DMV-16DMV-S-E-ACU	30,150,270		on existing mount	Unknown	1-5/8"	6	LD7-50A	Internal
T-Mobile	130	130	3	TMA	Andrew	OneBase™ Twin Dual Duplex	30,150,270		on existing mount	Unknown	1-5/8"	6	LD7-50A	Internal

Note: Proposed loading in addition to existing loading at 130'. Proposed coax to be internal to monopole for analysis results to be valid.

APPENDIX B

RISA Tower Output File

RISATower GPD Associates 520 South Main Street, Suite 2531 Akron, OH 44311 Phone: (330) 572-2286 FAX: (330) 572-2102	Job	27074 BRISTOL CENTER	Page	1 of 3
	Project	2009263.89	Date	09:46:39 05/19/09
	Client	AT&T Mobility	Designed by	sleduc

Tower Input Data

There is a pole section.

This tower is designed using the TIA/EIA-222-F standard.

The following design criteria apply:

Tower is located in Hartford County, Connecticut.

Basic wind speed of 80 mph.

Nominal ice thickness of 0.5000 in.

Ice density of 56 pcf.

A wind speed of 69 mph is used in combination with ice.

Temperature drop of 50 °F.

Deflections calculated using a wind speed of 50 mph.

A non-linear (P-delta) analysis was used.

Pressures are calculated at each section.

Stress ratio used in pole design is 1.333.

Local bending stresses due to climbing loads, feedline supports, and appurtenance mounts are not considered.

Feed Line/Linear Appurtenances - Entered As Area

Description	Face or Leg	Allow Shield	Component Type	Placement ft	Total Number		C _{AA}		Weight
							ft ² /ft	plf	
LDF2-50A (3/8 FOAM)	C	No	Inside Pole	168.50 - 8.00	1	No Ice	0.00	0.08	
LDF7-50A (1-5/8 FOAM)	C	No	Inside Pole	168.50 - 8.00	6	1/2" Ice	0.00	0.08	
						No Ice	0.00	0.82	
LDF4-50A (1/2 FOAM)	B	No	Inside Pole	70.00 - 8.00	1	1/2" Ice	0.00	0.15	
						No Ice	0.00	0.82	
LDF7-50A (1-5/8 FOAM)	B	No	Inside Pole	166.00 - 8.00	6	1/2" Ice	0.00	0.15	
						No Ice	0.00	0.82	
LDF7-50A (1-5/8 FOAM)	A	No	Inside Pole	146.00 - 8.00	12	1/2" Ice	0.00	0.82	
						No Ice	0.00	0.82	
LDF7-50A (1-5/8 FOAM)	C	No	Inside Pole	130.00 - 8.00	12	1/2" Ice	0.00	0.82	
						No Ice	0.00	0.82	

Discrete Tower Loads

Description	Face or Leg	Offset Type	Offsets:		Azimuth Adjustment	Placement ft	C _{AA}		Weight
			Horz Lateral ft	Vert ft			C _{AA} Front ft ²	C _{AA} Side ft ²	
800 10121 w/ mount pipe	A	From Leg	0.50	0.0000	169.00	No Ice	5.80	4.72	0.07
						1/2" Ice	6.35	5.56	0.11
						0.00			
800 10121 w/ mount pipe	B	From Leg	0.50	0.0000	169.00	No Ice	5.80	4.72	0.07
						1/2" Ice	6.35	5.56	0.11
						0.00			
800 10121 w/ mount pipe	C	From Leg	0.50	0.0000	169.00	No Ice	5.80	4.72	0.07
						1/2" Ice	6.35	5.56	0.11
						0.00			

RISATower GPD Associates 520 South Main Street, Suite 2531 Akron, OH 44311 Phone: (330) 572-2286 FAX: (330) 572-2102	Job	27074 BRISTOL CENTER	Page	2 of 3
	Project	2009263.89	Date	09:46:39 05/19/09
	Client	AT&T Mobility	Designed by	sleduc

Description	Face or Leg	Offset Type	Offsets:		Azimuth Adjustment	Placement	C _{AA}		Weight
			Horz Lateral	Vert			Front	Side	
			ft	ft	°	ft	ft ²	ft ²	K
12' T-arms (3)	C	None			0.0000	166.00	No Ice 1/2" Ice	14.10 16.00	1.00 1.20
(2) DB950F40T2E-M	A	From Centroid-Le g	3.98 -0.35 0.00		-5.0000	166.00	No Ice 1/2" Ice	6.42 6.88	4.63 5.01 0.02 0.06
(2) DB950F40T2E-M	B	From Centroid-Le g	0.69 3.94 0.00		80.0000	166.00	No Ice 1/2" Ice	6.42 6.88	4.63 5.01 0.02 0.06
(2) DB950F40T2E-M	C	From Centroid-Le g	3.06 2.57 0.00		40.0000	166.00	No Ice 1/2" Ice	6.42 6.88	4.63 5.01 0.02 0.06
PiROD 13' Low Profile Platform	C	None			0.0000	146.00	No Ice 1/2" Ice	15.70 20.10	1.30 1.76
(2) LPA-185063/8CF	A	From Centroid-Fa ce	4.00 0.00 0.00		0.0000	146.00	No Ice 1/2" Ice	2.97 3.30	2.75 3.05 0.01 0.03
(2) LPA-185063/8CF	B	From Centroid-Fa ce	4.00 0.00 0.00		0.0000	146.00	No Ice 1/2" Ice	2.97 3.30	2.75 3.05 0.01 0.03
(2) LPA-185063/8CF	C	From Centroid-Fa ce	4.00 0.00 0.00		0.0000	146.00	No Ice 1/2" Ice	2.97 3.30	2.75 3.05 0.01 0.03
(2) LPD-6513	A	From Centroid-Fa ce	4.00 0.00 0.00		0.0000	146.00	No Ice 1/2" Ice	6.42 6.82	5.15 5.53 0.03 0.05
(2) LPD-6513	B	From Centroid-Fa ce	4.00 0.00 0.00		0.0000	146.00	No Ice 1/2" Ice	6.42 6.82	5.15 5.53 0.03 0.05
(2) LPD-6513	C	From Centroid-Fa ce	4.00 0.00 0.00		0.0000	146.00	No Ice 1/2" Ice	6.42 6.82	5.15 5.53 0.03 0.05
PiROD 13' Low Profile Platform	C	None			0.0000	130.00	No Ice 1/2" Ice	15.70 20.10	1.30 1.76
APX16DWV-16DWV-S-E-A CU	A	From Centroid-Le g	3.46 2.00 0.00		30.0000	130.00	No Ice 1/2" Ice	6.70 7.13	2.00 2.33 0.04 0.07
APX16DWV-16DWV-S-E-A CU	B	From Centroid-Le g	3.46 2.00 0.00		30.0000	130.00	No Ice 1/2" Ice	6.70 7.13	2.00 2.33 0.04 0.07
APX16DWV-16DWV-S-E-A CU	C	From Centroid-Le g	3.46 2.00 0.00		30.0000	130.00	No Ice 1/2" Ice	6.70 7.13	2.00 2.33 0.04 0.07
(2) Onebase Twin Dual Duplex TMA	A	From Centroid-Le g	3.46 2.00 0.00		30.0000	130.00	No Ice 1/2" Ice	0.00 0.00	0.31 0.39 0.01 0.02
(2) Onebase Twin Dual Duplex TMA	B	From Centroid-Le g	3.46 2.00 0.00		30.0000	130.00	No Ice 1/2" Ice	0.00 0.00	0.31 0.39 0.01 0.02
(2) Onebase Twin Dual Duplex TMA	C	From Centroid-Le g	3.46 2.00 0.00		30.0000	130.00	No Ice 1/2" Ice	0.00 0.00	0.31 0.39 0.01 0.02
GPS	C	From Leg	0.50 0.00 0.00		0.0000	70.00	No Ice 1/2" Ice	0.17 0.24	0.17 0.24 0.00 0.00
APXV18-209014-C w/Mount Pipe	A	From Centroid-Le g	3.46 2.00 0.00		30.0000	130.00	No Ice 1/2" Ice	4.10 4.71	3.69 4.74 0.04 0.08

RISATower GPD Associates 520 South Main Street, Suite 2531 Akron, OH 44311 Phone: (330) 572-2286 FAX: (330) 572-2102	Job	27074 BRISTOL CENTER	Page	3 of 3
	Project	2009263.89	Date	09:46:39 05/19/09
	Client	AT&T Mobility	Designed by	sleduc

Description	Face or Leg	Offset Type	Offsets: Horz Lateral Vert	Azimuth Adjustment	Placement	C _{AA} Front	C _{AA} Side	Weight	
			ft ft ft	°	ft	ft ²	ft ²	K	
APXV18-209014-C w/Mount Pipe	B	From Centroid-Le g	3.46 2.00 0.00	30.0000	130.00	No Ice 1/2" Ice	4.10 4.71	3.69 4.74	0.04 0.08
APXV18-209014-C w/Mount Pipe	C	From Centroid-Le g	3.46 2.00 0.00	30.0000	130.00	No Ice 1/2" Ice	4.10 4.71	3.69 4.74	0.04 0.08
(2) LGP21401	A	From Leg	0.50 0.00 0.00	0.0000	169.00	No Ice 1/2" Ice	0.00 0.00	0.23 0.31	0.01 0.02
(2) LGP21401	B	From Leg	0.50 0.00 0.00	0.0000	169.00	No Ice 1/2" Ice	0.00 0.00	0.23 0.31	0.01 0.02
(2) LGP21401	C	From Leg	0.50 0.00 0.00	0.0000	169.00	No Ice 1/2" Ice	0.00 0.00	0.23 0.31	0.01 0.02

Section Capacity Table

Section No.	Elevation ft	Component Type	Size	Critical Element	P K	SF*P _{allow} K	% Capacity	Pass Fail
L1	168.5 - 130.67	Pole	TP25.31x19x0.1875	1	-4.04	758.32	43.7	Pass
L2	130.67 - 84.71	Pole	TP32.49x24.3228x0.25	2	-10.44	1298.86	79.5	Pass
L3	84.71 - 43.79	Pole	TP38.69x31.2363x0.3125	3	-16.99	1933.14	82.6	Pass
L4	43.79 - 0	Pole	TP45.25x37.1771x0.375	4	-27.57	2776.76	79.8	Pass
Summary								
Pole (L3)							82.6	Pass
RATING =							82.6	Pass

APPENDIX C

Tower Elevation Drawings

Section	1	2	3	4	18.9
Length (ft)	37.83	49.63	45.50	49.21	48.21
Number of Sides	18	18	18	18	18
Thickness (in)	0.1875	0.2500	0.3125	0.3750	0.3750
Lap Splice (ft)	3.67	4.59	5.42	37.1771	37.1771
Top Dia (in)	19.0000	24.3228	31.2363	45.2500	45.2500
Bot Dia (in)	25.3100	32.4900	38.6900		
Grade		A572-65			
Weight (K)	1.7	3.8	5.3	8.1	8.1

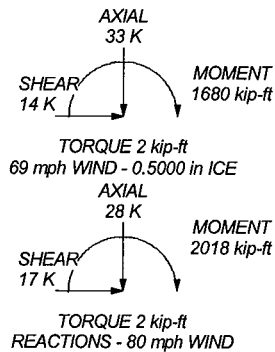
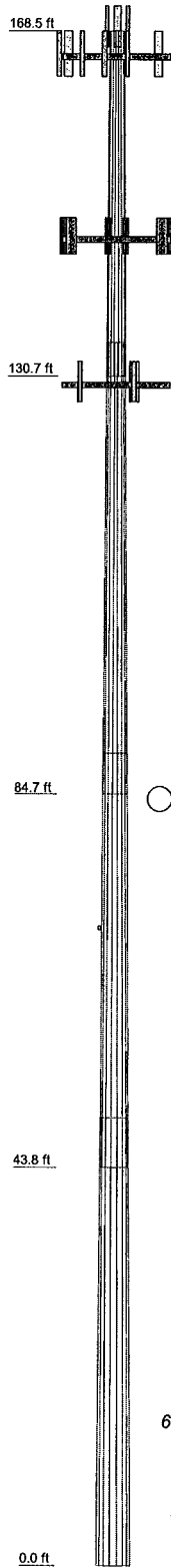

DESIGNED APPURTENANCE LOADING

TYPE	ELEVATION	TYPE	ELEVATION
800 10121 w/ mount pipe	169	PIROD 13' Low Profile Platform	146
800 10121 w/ mount pipe	169	(2) LPA-185063/BCF	146
800 10121 w/ mount pipe	169	(2) LPA-185063/BCF	146
(2) LGP21401	169	APX16DWV-16DWV-S-E-ACU	130
(2) LGP21401	169	(2) Onebase Twin Dual Duplex TMA	130
(2) LGP21401	169	(2) Onebase Twin Dual Duplex TMA	130
(2) DB950F40T2E-M	166	(2) Onebase Twin Dual Duplex TMA	130
12' T-arms (3)	166	APXV18-209014-C w/Mount Pipe	130
(2) DB950F40T2E-M	166	APXV18-209014-C w/Mount Pipe	130
(2) DB950F40T2E-M	166	APXV18-209014-C w/Mount Pipe	130
(2) LPA-185063/BCF	146	PIROD 13' Low Profile Platform	130
(2) LPD-6513	146	APX16DWV-16DWV-S-E-ACU	130
(2) LPD-6513	146	APX16DWV-16DWV-S-E-ACU	130
(2) LPD-6513	146	GPS	70

MATERIAL STRENGTH

GRADE	Fy	Fu	GRADE	Fy	Fu
A572-65	65 ksi	80 ksi			

TOWER DESIGN NOTES

1. Tower is located in Hartford County, Connecticut.
2. Tower designed for a 80 mph basic wind in accordance with the TIA/EIA-222-F Standard.
3. Tower is also designed for a 69 mph basic wind with 0.50 in ice.
4. Deflections are based upon a 50 mph wind.
5. TOWER RATING: 82.6%

 GPD GROUP Consulting Engineers	GPD Associates 520 South Main Street, Suite 2531 Akron, OH 44311 Phone: (330) 572-2286 FAX: (330) 572-2102		Job: 27074 BRISTOL CENTER	
	Project: 2009263.89		Client: AT&T Mobility	Drawn by: sleduc
	Code: TIA/EIA-222-F		Date: 05/19/09	App'd:
	Path: N:\2009\2009263\89\RISA\27074 Bristol Center.ed		Scale: NTS	Dwg No. E-1

Feedline Distribution Chart

0' - 168'6"

_____ Round _____
_____ Flat _____
_____ App In Face _____
_____ App Out Face _____
_____ Truss Leg _____

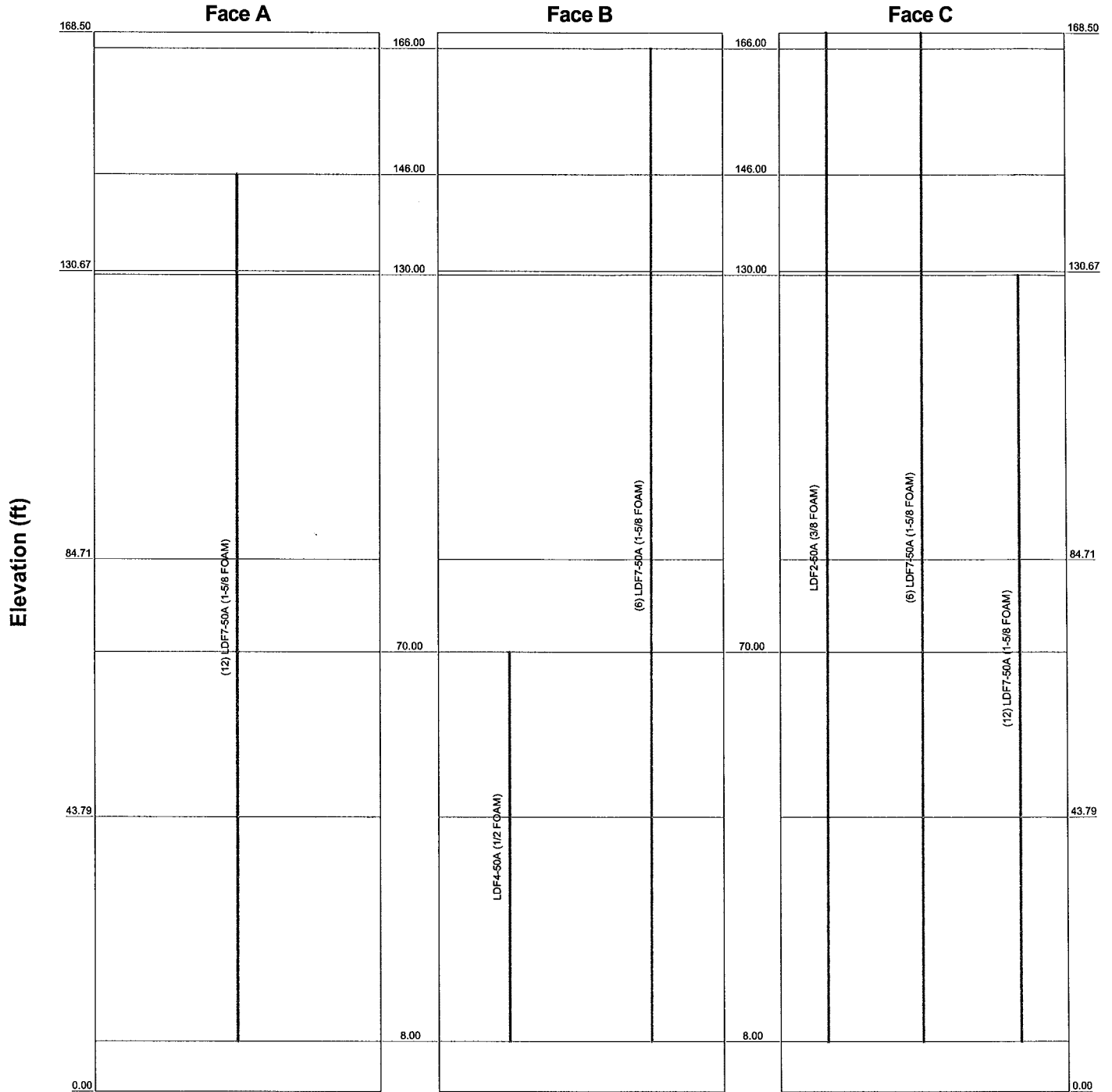

 GPD GROUP Consulting Engineers	GPD Associates		Job: 27074 BRISTOL CENTER		
	520 South Main Street, Suite 2531		Project: 2009263.89		
	Akron, OH 44311		Client: AT&T Mobility	Drawn by: sleduc	App'd:
	Phone: (330) 572-2286		Code: TIA/EIA-222-F	Date: 05/19/09	Scale: NTS
	FAX: (330) 572-2102		Path: N:\2009\2009263\89\TIA\27074 Bristol Center.dwg		
Dwg No. E-7					

Feedline Plan

Round Flat App In Face App Out Face

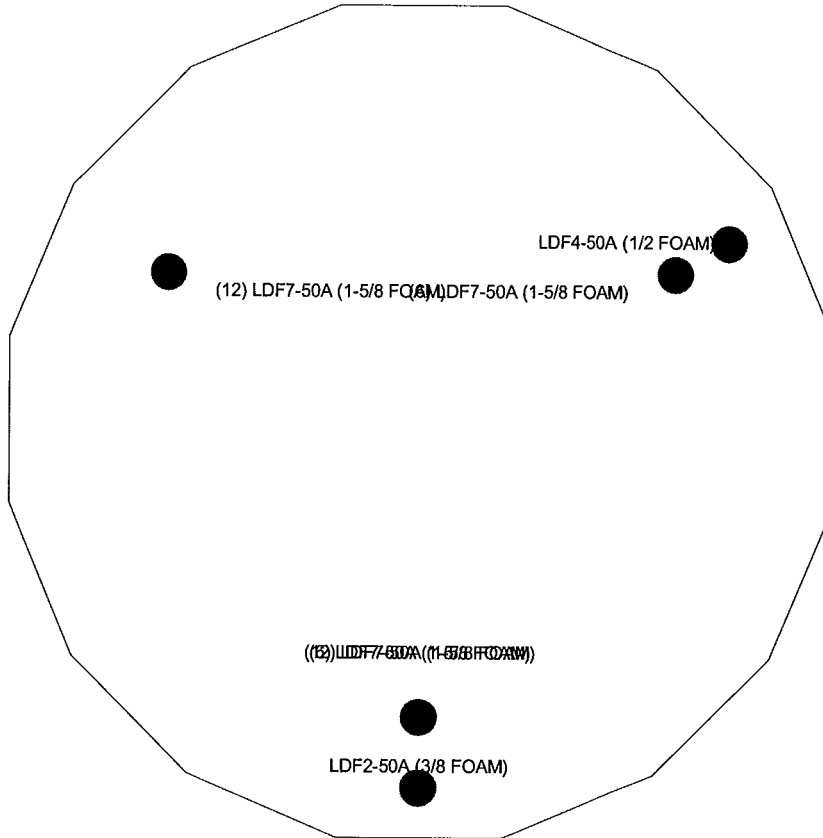

 GPD GROUP Consulting Engineers	GPD Associates 520 South Main Street, Suite 2531 Akron, OH 44311 Phone: (330) 572-2286 FAX: (330) 572-2102		Job: 27074 BRISTOL CENTER	
	Project: 2009263.89		Drawn by: sleduc	App'd:
	Client: AT&T Mobility		Date: 05/19/09	Scale: NTS
	Code: TIA/EIA-222-F		Path: <small>N:\2009\2009263\89\RISA\27074 Bristol Center.dwg</small>	
			Dwg No. E-7	

APPENDIX D

Anchor Rod & Base Plate Analysis

Anchor Rod and Base Plate Stresses
27074 BRISTOL CENTER
2009263.89

Overtuning Moment =	2018.00	k*ft
Axial Force =	28.00	k
Shear Force =	17.00	k

Anchor Rods		
Pole Diameter =	45.25	in
Number of Rods =	12	
Type =	Upset Rod	
Rod Yield Strength (Fy) =	75	ksi
Rod Circle =	54	in
Rod Diameter =	2.25	in
Net Tensile Area =	3.25	in ²
Max Tension on Rod =	147.15	kips
Max Compression on Rod =	151.81	kips
Allow. Rod Force =	195.00	kips
Anchor Rod Capacity =	75.5%	OK

Base Plate		
Location =	External	
Plate Strength (Fy) =	60	ksi
Plate Thickness =	2	in
w_{calc} =	29.47	in
w_{max} =	33.9762	in
w =	29.47	in
S =	19.65	in ³
f_b =	51.56	ksi
F_b =	60	ksi
Base Plate Capacity =	85.9%	OK

EXTERNAL

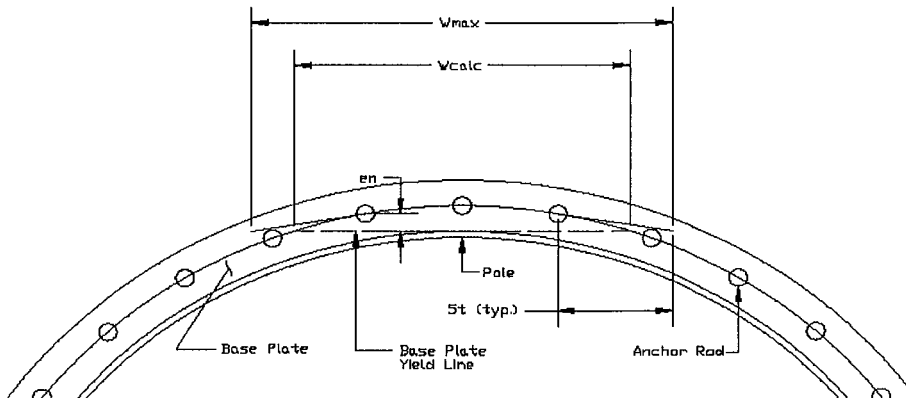

INTERNAL

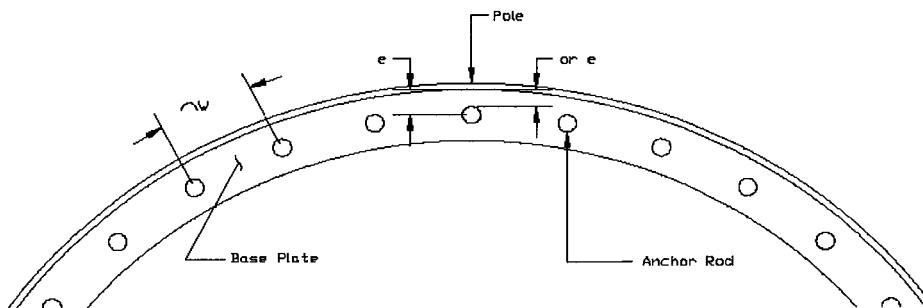

APPENDIX E

Foundation Analysis

 * PIER FOUNDATIONS ANALYSIS AND DESIGN - (C) 1995, POWER LINE SYSTEMS, INC.*

*** ANALYSIS IDENTIFICATION : 27074 BRISTOL CENTER
 NOTES : 2009263.89(INPUT LOADS FACTORED FOR THE STRUCTURAL DESIGN OF THE PIER)

*** PIER PROPERTIES CONCRETE STRENGTH (ksi) = 4.00 STEEL STRENGTH (ksi) = 60.00
 DIAMETER (ft) = 6.500 DISTANCE FROM TOP OF PIER TO GROUND LEVEL (ft) = 1.00

LAYER	TYPE	THICKNESS (ft)	DEPTH AT TOP OF LAYER (ft)	DENSITY (pcf)	CU (psf)	KP (degrees)	PHI (degrees)
1	C	3.00	0.00	120.0	0.0		
2	S	25.00	3.00	120.0	3.000	30.00	

*** DESIGN (FACTORED) LOADS AT TOP OF PIER MOMENT (ft-k) = 3414.8 VERTICAL (k) = 35.1 SHEAR (k) = 27.0
 ADDITIONAL SAFETY FACTOR AGAINST SOIL FAILURE = 1.54

*** CALCULATED PIER LENGTH (ft) = 22.000<-----REBAR CONTROLS

*** CHECK OF SOILS PROPERTIES AND ULTIMATE RESISTING FORCES ALONG PIER

TYPE	TOP OF LAYER BELOW TOP OF PIER (ft)	THICKNESS (ft)	DENSITY (pcf)	CU (psf)	KP	FORCE (k)	ARM (ft)
C	1.00	3.00	120.0	0.0		0.00	2.50
S	4.00	12.20	120.0		3.000	779.28	11.46
S	16.20	5.80	120.0		3.000	-737.04	19.25

*** SHEAR AND MOMENTS ALONG PIER

DISTANCE BELOW TOP OF PIER (ft)	WITH THE ADDITIONAL SAFETY FACTOR		WITHOUT ADDITIONAL SAFETY FACTOR	
	SHEAR (k)	MOMENT (ft-k)	SHEAR (k)	MOMENT (ft-k)
0.00	42.2	5259.0	27.4	3414.9
2.20	42.2	5351.9	27.4	3475.2
4.40	33.2	5443.0	21.6	3534.4
6.60	-36.2	5446.0	-23.5	3536.3
8.80	-139.7	5258.6	-90.7	3414.7
11.00	-277.2	4806.3	-180.0	3120.9
13.20	-448.6	4014.1	-291.3	2606.6
15.40	-654.0	2807.5	-424.7	1823.0
17.60	-580.7	1327.4	-377.1	861.9
19.80	-307.3	344.3	-199.6	223.6
22.00	0.0	0.0	0.0	0.0

*** TOTAL REINFORCEMENT PCT = 0.52 REINFORCEMENT AREA (in^2) = 24.85
 *** USABLE AXIAL CAP. (k) = 35.1 USABLE MOMENT CAP. (ft-k) = 3571.1

*** US Standard Re-Bars (Select one of the following):

125 BARS #4	(AREA = 0.20 in^2	DIA = 0.500 in)	AT SPACING (in) =	1.71
81 BARS #5	(AREA = 0.31 in^2	DIA = 0.625 in)	AT SPACING (in) =	2.64
57 BARS #6	(AREA = 0.44 in^2	DIA = 0.750 in)	AT SPACING (in) =	3.75
42 BARS #7	(AREA = 0.60 in^2	DIA = 0.875 in)	AT SPACING (in) =	5.09
32 BARS #8	(AREA = 0.79 in^2	DIA = 1.000 in)	AT SPACING (in) =	6.68
25 BARS #9	(AREA = 1.00 in^2	DIA = 1.128 in)	AT SPACING (in) =	8.55
20 BARS #10	(AREA = 1.27 in^2	DIA = 1.270 in)	AT SPACING (in) =	10.68
16 BARS #11	(AREA = 1.56 in^2	DIA = 1.410 in)	AT SPACING (in) =	13.35
12 BARS #14	(AREA = 2.25 in^2	DIA = 1.693 in)	AT SPACING (in) =	17.80

-----REBAR CONTROLS

*** PRESSURE UNDER CAISSON DUE TO DESIGN AXIAL LOAD (psf) = 1057.8

Technical Memo

To: Transcend
From: Farid Marbough - Radio Frequency Engineer
cc: Jason Overbey
Subject: Power Density Report for CTHA114B
Date: August 12, 2009

1. Introduction:

This report is the result of an Electromagnetic Field Intensities (EMF - Power Densities) study for the T-Mobile antenna installation on a Monopole at 371 Terryville Avenue, Bristol, CT. This study incorporates the most conservative consideration for determining the practical combined worst case power density levels that would be theoretically encountered from locations surrounding the transmitting location.

2. Discussion:

The following assumptions were used in the calculations:

- 1) The emissions from T-Mobile transmitters are in the (1935-1944.8), (2140-2145), (2110-2120)MHz frequency Band.
- 2) The antenna array consists of three sectors, with 2 antennas per sector.
- 3) The model number for GSM antenna is APXV18-209014-C.
- 3) The model number for UMTS antenna is APX16DWV-16DWV.
- 4) GSM antenna center line height is 130 ft.
- 4) UMTS antenna center line height is 130 ft.
- 5) The maximum transmit power from any GSM sector is 1653.94 Watts Effective Radiated Power (EiRP) assuming 8 channels per sector.
- 5) The maximum transmit power from any UMTS sector is 2330.72 Watts Effective Radiated Power (EiRP) assuming 2 channels per sector.
- 6) All the antennas are simultaneously transmitting and receiving, 24 hours a day.
- 7) Power levels emitting from the antennas are increased by a factor of 2.56 to account for possible in-phase reflections from the surrounding environment. This is rarely the case, and if so, is never continuous.
- 8) The average ground level of the studied area does not change significantly with respect to the transmitting location.

Equations given in "FCC OET Bulletin 65, Edition 97-01" were then used with the above information to perform the calculations.

3. Conclusion:

Based on the above worst case assumptions, the power density calculation from the T-Mobile antenna installation on a Monopole at 371 Terryville Avenue, Bristol, CT, is 0.05685 mW/cm². This value represents 5.685% of the Maximum Permissible Exposure (MPE) standard of 1 milliwatt per square centimeter (mW/cm²) set forth in the FCC/ANSI/IEEE C95.1-1991. Furthermore, the proposed antenna location for T-Mobile will not interfere with existing public safety communications, AM or FM radio broadcasts, TV, Police Communications, HAM Radio communications or any other signals in the area. The combined Power Density from other carriers is 15.34%. The combined Power Density for the site is 21.025% of the M.P.E. standard.

Connecticut Market



Worst Case Power Density

Site: CTHA114B
Site Address: 371 Terryville Avenue
Town: Bristol
Tower Height: 160 ft.
Tower Style: Monopole

GSM Data		UMTS Data	
Base Station TX output	20 W	Base Station TX output	40 W
Number of channels	8	Number of channels	2
Antenna Model	APXV18-209014-C	Antenna Model	APX16DWV-16DWV
Cable Size	1 5/8 in.	Cable Size	1 5/8 in.
Cable Length	160 ft.	Cable Length	160 ft.
Antenna Height	130.0 ft.	Antenna Height	130.0 ft.
Ground Reflection	1.6	Ground Reflection	1.6
Frequency	1945.0 MHz	Frequency	2.1 GHz
Jumper & Connector loss	4.50 dB	Jumper & Connector loss	1.50 dB
Antenna Gain	16.5 dBi	Antenna Gain	18.0 dBi
Cable Loss per foot	0.0116 dB	Cable Loss per foot	0.0116 dB
Total Cable Loss	1.8560 dB	Total Cable Loss	1.8560 dB
Total Attenuation	6.3560 dB	Total Attenuation	3.3560 dB
Total EIRP per Channel (In Watts)	53.15 dBm 206.74 W	Total EIRP per Channel (In Watts)	60.66 dBm 1165.36 W
Total EIRP per Sector (In Watts)	62.19 dBm 1653.94 W	Total EIRP per Sector (In Watts)	63.67 dBm 2330.72 W
nsg	10.1440	nsg	14.6440
Power Density (S) = 0.023599 mW/cm ²		Power Density (S) = 0.033256 mW/cm ²	
T-Mobile Worst Case % MPE =		5.6855%	

Equation Used:

$$S = \frac{(1000 \text{ (grf)})^2 (\text{Power})^{(nsg/10)}}{4\pi (R)^2}$$

Office of Engineering and Technology (OET) Bulletin 65, Edition 97-01, August 1997

Co-Location Total

Carrier	% of Standard
Verizon	7.6000 %
Cingular	3.5400 %
Sprint	4.2000 %
AT&T Wireless	
Pocket	
MetroPCS	
Nextel	
Other Antenna Systems	
Total Excluding T-Mobile	15.3400 %
T-Mobile	5.6855
Total % MPE for Site	21.0255%