

September 5, 2023

Melanie A. Bachman
Executive Director
Connecticut Siting Council
10 Franklin Square
New Britain, CT 06051

RE: **Notice of Exempt Modification for Verizon
Crown #822765_Crown_VZW
10 Sylvia Street, Branford, CT 06405
Latitude: 41° 17' 38.16" / Longitude: -72° 47' 8.54"**

Dear Ms. Bachman:

Verizon Wireless is requesting to file an exempt modification for an existing tower located at 10 Sylvia Street, Branford, CT 06405. The property is owned by 322 East Main Street LLC and the tower is owned by Crown Castle. Verizon now intends to add three (3) interference mitigation filters to be installed at the 112-foot level of the tower of the 125-foot monopole. This modification may include B2, B5, B17, B14, B29, B30, B66 & n77 hardware that is 4G(LTE) and/or 5GNR capable through remote software configuration and either or both services may be turned on or off at various times.

Panned Modification:

Tower:

Installed New:

(3) Kaelus BSF0020F3V1-1 Twin Bandstop 900MHZ Interference Mitigation Filters

The proposed work in this application only pertains to the installation of interference mitigation filter(s) and does not involve any additional equipment that may be called out in the Mount Analysis and/or in Table 1 of the Structural Analysis Reports.

The facility was approved by the Town of Branford Planning and Zoning Commission, application #98-9.3. This approval was given without conditions. Please see attached.

Please accept this letter as notification pursuant to Regulations of Connecticut State Agencies §16-50j-73, for construction that constitutes an exempt modification pursuant to R.C.S.A. § 16-50j-72(b)(2). In accordance with R.C.S.A. § 16-SOj-73, a copy of this letter is being sent to First Selectman James B. Cosgrove and Town Planner Harry Smith for the municipality and 322 East Main Street LLC for the property owner. Crown Castle is the tower owner. The proposed modifications will not result in an increase in the height of the existing tower.

1. The proposed modifications will not require the extension of the site boundary.
2. The proposed modification will not increase noise levels at the facility by six decibels or more, or to levels that exceed state and local criteria.

Melanie A. Bachman

Page 2

3. The operation of the replacement antennas will not increase radio frequency emissions at the facility to a level at or above the Federal Communication Commission safety standard.
4. The proposed modifications will not cause a change or alteration in the physical or environmental characteristics of the site.
5. The existing structure and its foundation can support the proposed loading.

For the foregoing reasons, Verizon respectfully submits that the proposed modifications to the above-reference telecommunications facility constitutes an exempt modification under R.C.S.A. § 16-50j-72(b)(2). Please send approval/rejection letter to Attn: Domenica Tatasciore.

Sincerely,



Domenica Tatasciore
Site Acquisition Specialist
1800 W. Park Drive
Westborough, MA 01581
(508) 621-9161/ Domenica.Tatasciore@crowncastle.com

Attachments

cc:

First Selectman James B. Cosgrove
Town of Branford
1019 Main Street
Branford, CT 06405
203-488-8394

Town Planner Harry Smith
Town of Branford
1019 Main Street
Branford, CT 06405
203-488-1255

322 East Main Street LLC, Property Owner
375 Fairfield Avenue
Stamford, CT 06902
203-967-8367

Crown Castle, Tower Owner

CROWN CASTLE USA INC.
2000 CORPORATE DRIVE
CANONSBURG PA 15317
724-416-2000

JPMorgan Chase Bank, N.A.
DALLAS TX
32-61/1110

2891357

SIX HUNDRED TWENTY FIVE AND 00/100*****

DATE 08/30/23

\$*****625.00

Pay To Connecticut Siting Council
The Ten Franklin Square
Order Of New Britain CT 06051

2695915

Robert A. Cole VP and Controller
[Signature] Asst. Controller

VOID AFTER 180 DAYS

⑈ 2891357⑈ ⑆ 111000614⑆ 103410453⑈

Check No 2891357

Check Date 08/30/23

Stub 1 of 1

CKRQ 822765 654626 ZAP	08/30/23	Invoice Summ	625.00	625.00
			<u>625.00</u>	<u>625.00</u>

From: TrackingUpdates@fedex.com
To: [Tatasclore, Domenica](#)
Subject: FedEx Shipment 773252499644: Your package has been delivered
Date: Wednesday, September 6, 2023 10:24:30 AM

CAUTION: This email originated from outside of the organization. Do not click links or open attachments unless you recognize the sender and know the content is safe.

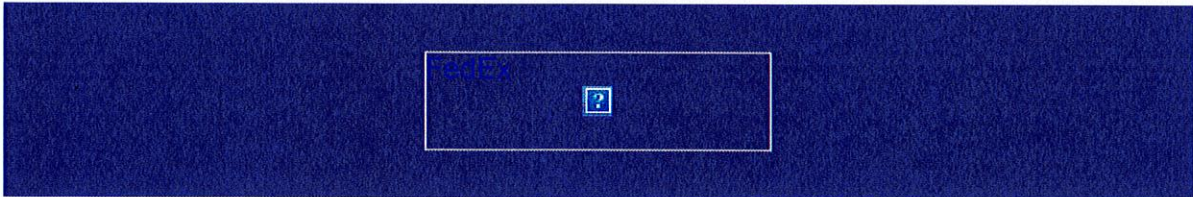

Hi. Your package was
delivered Wed, 09/06/2023 at
10:15am.



Delivered to 1019 MAIN ST, BRANFORD, CT 06405
Received by C.LRK

[OBTAIN PROOF OF DELIVERY](#)

How was your delivery ?



TRACKING NUMBER	773252499644
FROM	Crown Castle 1800 West Park Drive Suite 200 WESTBOROUGH, MA, US, 01581
TO	Town of Branford First Selectman James B. Cosgrove 1019 Main Street BRANFORD, CT, US, 06405
REFERENCE	799001.7680
SHIPPER REFERENCE	799001.7680
SHIP DATE	Tue 9/05/2023 05:24 PM
DELIVERED TO	Receptionist/Front Desk
PACKAGING TYPE	FedEx Envelope
ORIGIN	WESTBOROUGH, MA, US, 01581
DESTINATION	BRANFORD, CT, US, 06405
NUMBER OF PIECES	1
TOTAL SHIPMENT WEIGHT	0.50 LB
SERVICE TYPE	FedEx Priority Overnight

Wondering when a package will arrive?

Enter your tracking number to see your estimated delivery time within a 4-hour window.

[TRACK A PACKAGE](#)

From: TrackingUpdates@fedex.com
To: [Tatasciore, Domenica](#)
Subject: FedEx Shipment 773252546404: Your package has been delivered
Date: Wednesday, September 6, 2023 10:24:42 AM

CAUTION: This email originated from outside of the organization. Do not click links or open attachments unless you recognize the sender and know the content is safe.

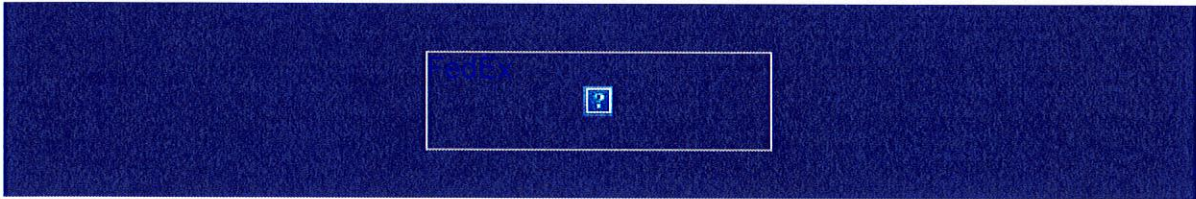

Hi. Your package was
delivered Wed, 09/06/2023 at
10:15am.



Delivered to 1019 MAIN ST, BRANFORD, CT 06405
Received by C.LRK

[OBTAIN PROOF OF DELIVERY](#)

How was your delivery ?



TRACKING NUMBER	773252546404
FROM	Crown Castle 1800 West Park Drive Suite 200 WESTBOROUGH, MA, US, 01581
TO	Town of Branford Town Planner Harry Smith 1019 Main Street BRANFORD, CT, US, 06405
REFERENCE	799001.7680
SHIPPER REFERENCE	799001.7680
SHIP DATE	Tue 9/05/2023 05:24 PM
DELIVERED TO	Receptionist/Front Desk
PACKAGING TYPE	FedEx Envelope
ORIGIN	WESTBOROUGH, MA, US, 01581
DESTINATION	BRANFORD, CT, US, 06405
NUMBER OF PIECES	1
TOTAL SHIPMENT WEIGHT	0.50 LB
SERVICE TYPE	FedEx Priority Overnight

Wondering when a package will arrive?

Enter your tracking number to see your estimated delivery time within a 4-hour window.

[TRACK A PACKAGE](#)

From: TrackingUpdates@fedex.com
To: [Tatasciore, Domenica](#)
Subject: FedEx Shipment 773252591679: Your package has been delivered
Date: Wednesday, September 6, 2023 10:42:47 AM

CAUTION: This email originated from outside of the organization. Do not click links or open attachments unless you recognize the sender and know the content is safe.



Hi. Your package was
delivered Wed, 09/06/2023 at
10:33am.



Delivered to 375 FAIRFIELD AVE, STAMFORD, CT 06902
Received by B.WILLIAMS

[OBTAIN PROOF OF DELIVERY](#)

How was your delivery ?



TRACKING NUMBER	773252591679
FROM	Crown Castle 1800 West Park Drive Suite 200 WESTBOROUGH, MA, US, 01581
TO	322 East Main Street LLC 375 Fairfield Avenue STAMFORD, CT, US, 06902
REFERENCE	799001.7680
SHIPPER REFERENCE	799001.7680
SHIP DATE	Tue 9/05/2023 05:24 PM
DELIVERED TO	Mailroom
PACKAGING TYPE	FedEx Envelope
ORIGIN	WESTBOROUGH, MA, US, 01581
DESTINATION	STAMFORD, CT, US, 06902
NUMBER OF PIECES	1
TOTAL SHIPMENT WEIGHT	0.50 LB
SERVICE TYPE	FedEx Priority Overnight

Wondering when a package will arrive?

Enter your tracking number to see your estimated delivery time within a 4-hour window.

[TRACK A PACKAGE](#)

VOL. 662 PAGE 502
PLANNING AND ZONING COMMISSION
TOWN OF BRANFORD TOWN HALL DRIVE P.O. BOX 150
Branford, Connecticut 06405 488-1255

NOTICE OF DECISION

November 10, 1998

J. Brendan Sharkey, Esq. For Omnipoint Communications, Inc.
25 VanZant Street #18E
East Norwalk, Connecticut 06855

SUBJECT: Special Exception APPLICATION # 98-9.3

LOCATION: 10 Sylvia Street

OWNERS OF RECORD: TKJ SYLVIA ASSOCIATES, LLC

Dear Sir:

At a meeting of the Branford Planning & Zoning Commission held on Thursday, November 5, 1998, the Commission voted to:

Approve your above subject application with the conditions noted below.

Very truly yours,

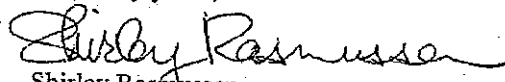
Shirley Rasmussen
Town Planner

NOTE: This Special Exception shall become effective only after it is filed on the Land Records in the office of the Town Clerk.

- 1. Omnipoint must construct tower so that it can easily be extended to provide spaces for two (2) other carriers for co-location purposes.

NOTE: Special Exception shall become null and void in the event the applicant fails to obtain a building permit within one (1) year of date of approval.
(Per Section 31.7 of the Branford Zoning Regulations)

RECEIVED FOR RECORD Nov 19 1998
at 3:49 P.M. AND RECORDED BY
GEORGETTE A. LASKE
BRANFORD TOWN CLERK



Property Information

Property Location	10 SYLVIA ST
Owner	322 EAST MAIN STREET LLC
Co-Owner	na
Mailing Address	375 FAIRFIELD AVE STAMFORD CT 06902
Land Use	3160 COMM WHS MDL96
Land Class	C
Zoning Code	BL
Census Tract	

Neighborhood	400
Acreage	0.95
Utilities	Public Water,Septic
Lot Setting/Desc	Bus. District Level
Book / Page	1132/0054

Photo



Sketch

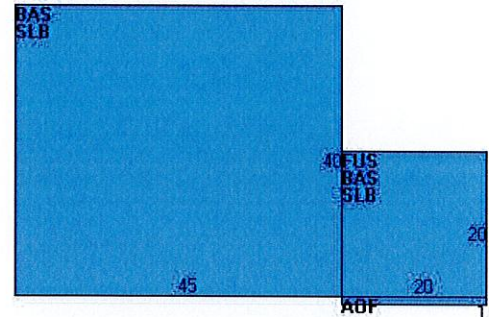

Primary Construction Details

Year Built	1960
Building Desc.	COMM WHS MDL96
Building Style	Health Club
Building Grade	C
Stories	1
Occupancy	1.00
Exterior Walls	Concr/Cinder
Exterior Walls 2	Wood on Sheath
Roof Style	Gable/Hip
Roof Cover	Asphalt
Interior Walls	Minim/Masonry
Interior Walls 2	Drywall
Interior Floors 1	Concr-Finished
Interior Floors 2	Ceram Clay Til

Heating Fuel	Gas
Heating Type	Hot Air-no Duc
AC Type	None
Bedrooms	0
Full Bathrooms	0
Half Bathrooms	0
Extra Fixtures	0
Total Rooms	0
Bath Style	NA
Kitchen Style	NA
Fin Bsmt Area	
Fin Bsmt Quality	
Bsmt Gar	
Fireplaces	

(*Industrial / Commercial Details)

Building Use	Ind/Comm
Building Condition	A
Sprinkler %	NA
Heat / AC	HEAT/AC SPLIT
Frame Type	MASONRY
Baths / Plumbing	AVERAGE
Ceiling / Wall	CEIL & MIN WL
Rooms / Prtns	AVERAGE
Wall Height	16.00
First Floor Use	NA
Foundation	NA



Town of Branford, CT

Property Listing Report

Map Block Lot

G05/F05/004/ Bldg # 1

Sec # 1

PID 1103

Account

000614

Valuation Summary (Assessed value = 70% of Appraised Value)

Item	Appraised	Assessed
Buildings	210600	147400
Extras	4100	2900
Improvements		
Outbuildings	16000	11200
Land	481500	337100
Total	712200	498600

Sub Areas

Subarea Type	Gross Area (sq ft)	Living Area (sq ft)
Office	420	420
First Floor	2200	2200
Slab	2200	0
Total Area	4820	2620

Outbuilding and Extra Features

Type	Description
PAVING-ASPHALT	18000 S.F.
FENCE-6' CHAIN	200 L.F.
PAVING-CONC	72 S.F.
COMMUN UTILITY	36 S.F.
GEN 15-30KW PRMT BKP	1 UNITS
HGH PRE-SOD PL	3 UNITS
AIR CONDITION	800 S.F.

Sales History

Owner of Record	Book/ Page	Sale Date	Sale Price
322 EAST MAIN STREET LLC	1132/0054	2013-05-02	468000
T K J SYLVIA ASSOCIATES LLC	0571/0583	1994-06-07	0

Town of Branford, Connecticut - Assessment Parcel Map

Parcel: G05-F05-004-00017

Address: 10 SYLVIA ST

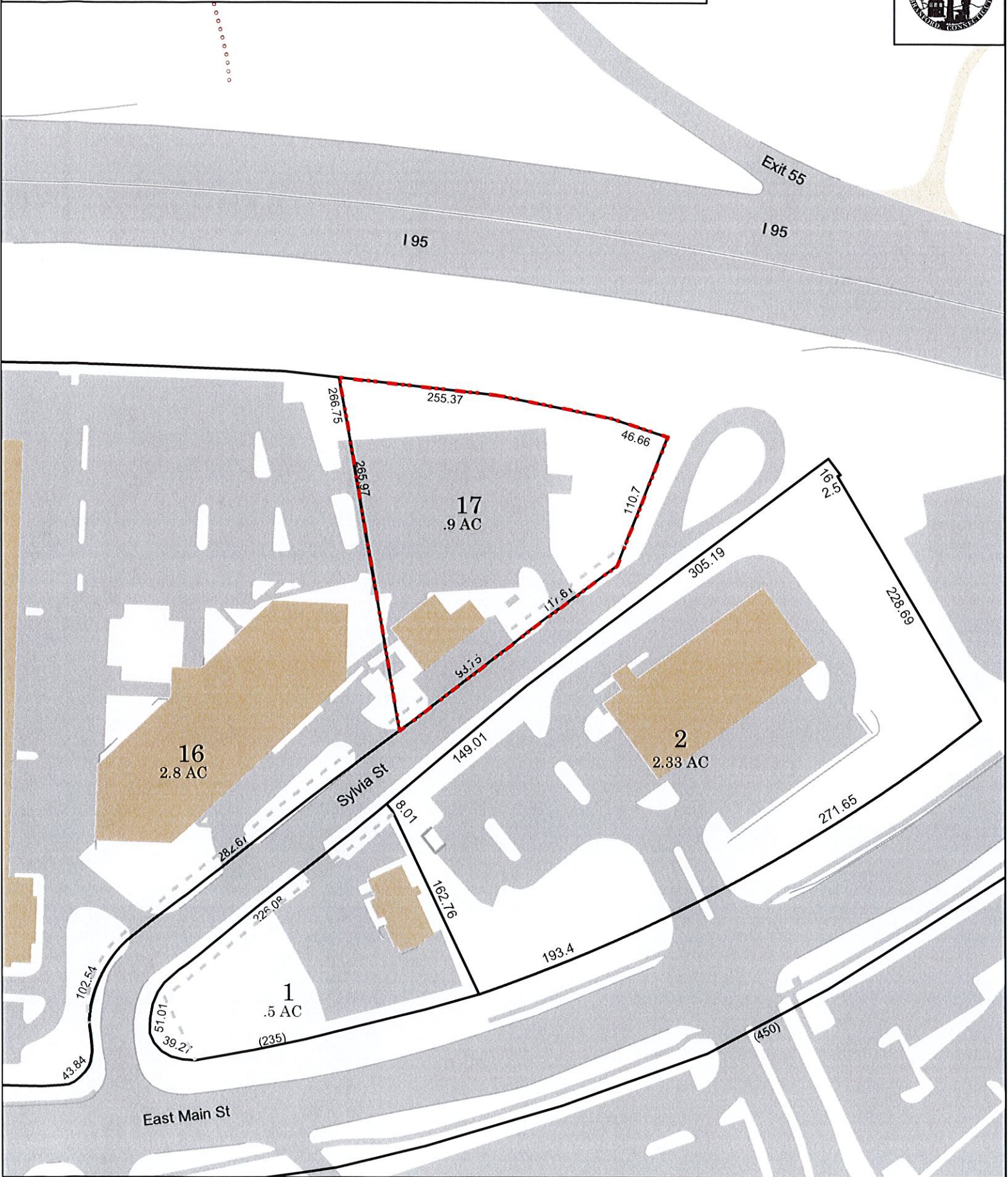

Approximate Scale: 1 inch : 100 feet

Grand List Date: June 2023

Disclaimer:

This map is for informational purposes only. All information is subject to verification by any user. The Town of Branford and its mapping contractors assume no legal responsibility for the information contained herein.

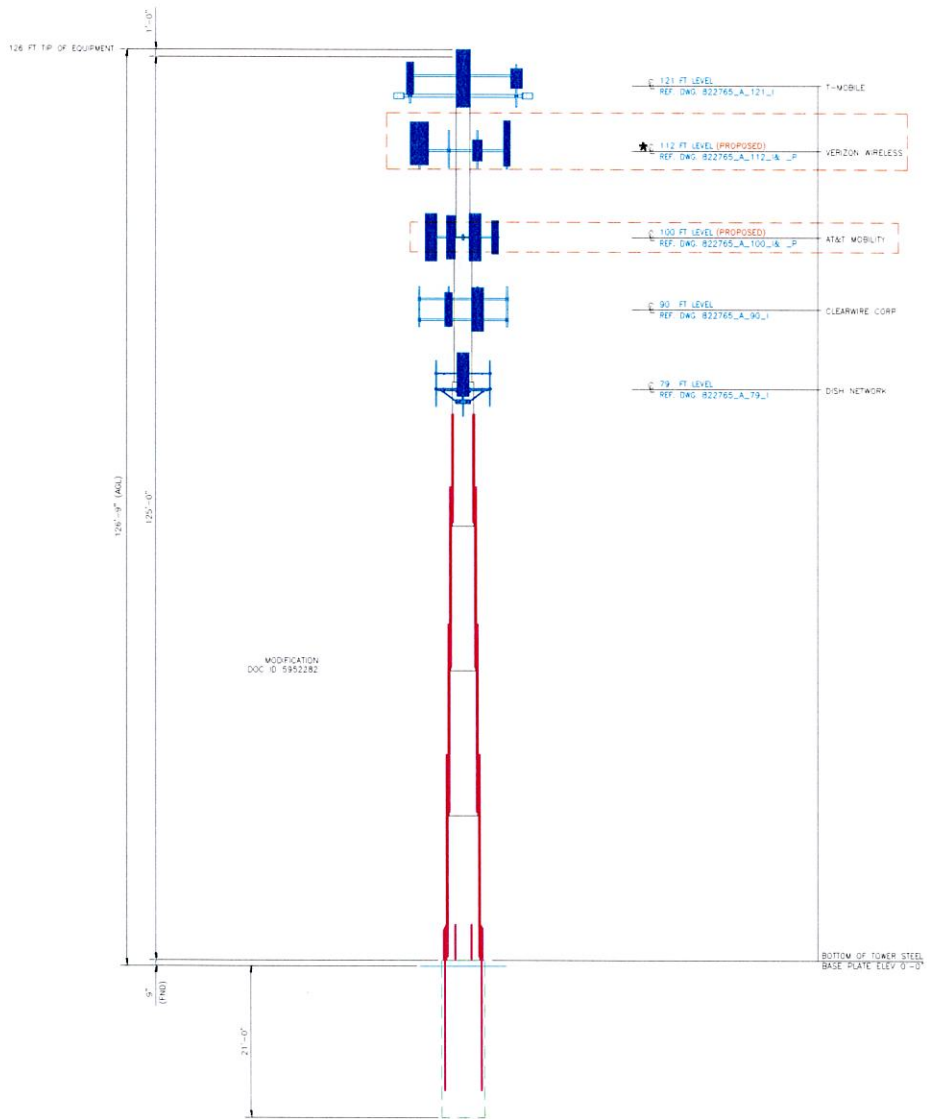

BSF0020F3V1-1

TWIN BANDSTOP 900MHZ INTERFERENCE MITIGATION FILTER

The BSF0020 is ideal for co-located 700, 850 and 900 networks. Utilising a 2.6MHz guardband the BSF0020 provides rejection of the 900 UL band while passing 700/850 UL and DL bands. Capable of being used in an outdoor environment the BSF0020 contains two identical bandstop filters, suitable for 2x2 MIMO configuration, offering excellent insertion loss, group delay and rejection.

FEATURES

- Passes full 700 and 850 bands
- Low insertion loss
- Rejection of 900MHz uplink
- DC/AISG pass
- Twin unit
- Dual twin mounting available



TECHNICAL SPECIFICATIONS

BAND NAME	700 PATH / 850 UPLINK PATH	850 DOWNLINK PATH
Passband	698 - 849MHz	869 - 891.5MHz
Insertion loss	0.1dB typical / 0.3dB maximum	0.5dB typical, 1.45dB maximum
Return loss	24dB typical, 18dB minimum	
Maximum input power (Per Port)	100W average	200W average and 66W per 5MHz
Rejection	53dB minimum @ 894.1 - 896.5MHz	

ELECTRICAL

Impedance	50Ohms
Intermodulation products	-160dBc maximum in UL Band (assuming 20MHz Signal), with 2 x 43dBm carriers -153dBc maximum with 2 x 43dBm

DC / AISG

Passband	0 - 13MHz
Insertion loss	0.3dB maximum
Return loss	15dB minimum
Input voltage range	± 33V
DC current rating	2A continuous, 4A peak
Compliance	3GPP TS 25.461

ENVIRONMENTAL

For further details of environmental compliance, please contact Kaelus.

Temperature range	-20°C to +60°C -4°F to +140°F
Ingress protection	IP67
Altitude	2600m 8530ft
Lightning protection	RF port: ±5kA maximum (8/20us), IEC 61000-4-5 – Unit must be terminated with some lightning protection circuits.
MTBF	>1,000,000 hours
Compliance	ETSI EN 300 019 class 4.1H, RoHS, NEBS GR-487-CORE

MECHANICAL

Dimensions H x D x W	269 x 277 x 80mm 10.60 x 10.90 x 3.15in (Excluding brackets and connectors)
Weight	8.0 kg 17.6 lbs (no bracket)
Finish	Powder coated, light grey (RAL7035)
Connectors	RF: 4.3-10 (F) x 4
Mounting	Optional pole/wall bracket supplied with two metal clamps 45-178mm diameter poles or custom bracket. See ordering information.

ORDERING INFORMATION

PART NUMBER	CONFIGURATION	OPTIONAL FEATURES	CONNECTORS
BSF0020F3V1	TWIN, 2 in / 2 out	DC/AISG PASS NO BRACKET	4.3-10 (F)
BSF0020F3V1-1	TWIN, 2 in / 2 out	DC/AISG PASS	4.3-10 (F)
BSF0020F3V1-2	QUAD, 4 in / 4 out	DC/AISG PASS	4.3-10 (F)

ELECTRICAL BLOCK DIAGRAM

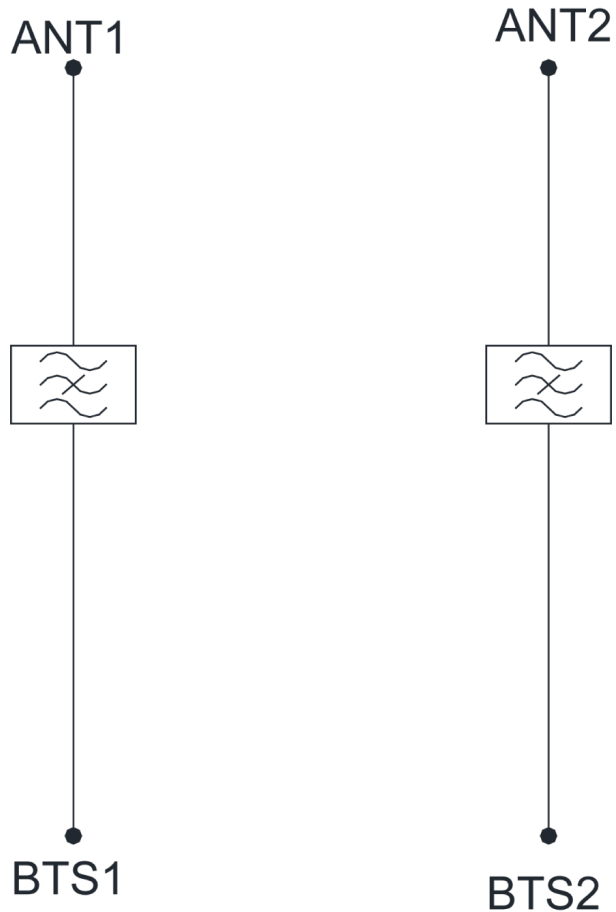

MECHANICAL BLOCK DIAGRAM

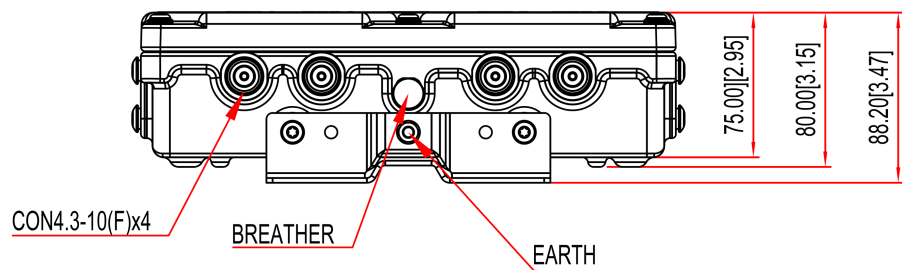
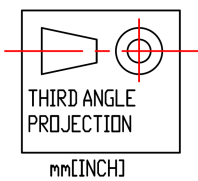
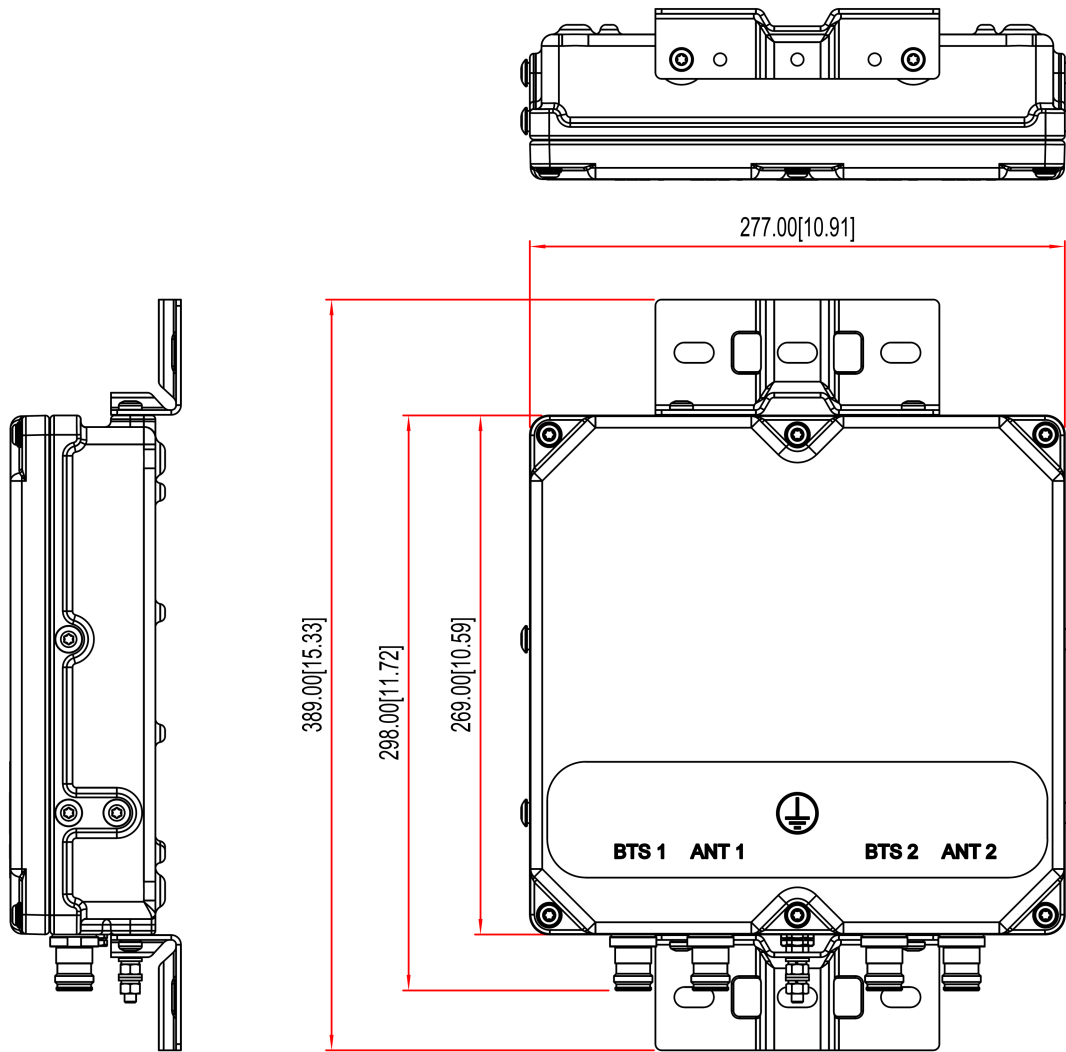

Colliers Engineering & Design CT, PC
1055 Washington Boulevard
Stamford, CT 06901
203.324.0800
peter.albano@collierseng.com

Antenna Mount Analysis Report and PMI Requirements

Mount ReAnalysis

SMART Tool Project #: 10206412
Colliers Engineering & Design CT, PC Project #: 23777059 (Rev. 1)

July 10, 2023

Site Information

Site ID: 5000386426-VZW / BRANFORD_4_CT - A
Site Name: BRANFORD_4_CT - A
Carrier Name: Verizon Wireless
Address: 10 Silvia St
Branford, Connecticut 06405
New Haven County
Latitude: 41.2939261°
Longitude: -72.7857085°

Structure Information

Tower Type: 125-Ft Monopole
Mount Type: 12.50-Ft Platform

FUZE ID # 17123774

Analysis Results

Platform: 52.9% Pass*

***Antennas and equipment to be installed in compliance with PMI Requirements of this mount analysis.**

***Contractor PMI Requirements:

Included at the end of this MA report

Available & Submitted via portal at <https://pmi.vzwsmart.com>

For additional questions and support, please reach out to:

pmisupport@colliersengineering.com

Report Prepared By: Frank Centone



Executive Summary:

The objective of this report is to determine the capacity of the antenna support mount at the subject facility for the final wireless telecommunications configuration, per the applicable codes and standards. Any modification listed under Sources of Information was assumed completed and was included in this analysis.

This analysis is inclusive of the mount structure only and does not address the structural capacity of the supporting structure. This mounting frame was not analyzed as an anchor attachment point for fall protection. All climbing activities are required to have a fall protection plan completed by a competent person.

Sources of Information:

Document Type	Remarks
Radio Frequency Data Sheet (RFDS)	Verizon RFDS Site ID: 50002274 Dated July 15, 2021
Previous Mount Modification Report	Maser Consulting Connecticut Project #: 21781008A Dated August 9, 2021
Post Modification Inspection	Colliers Engineering & Design CT, PC Project #: 21781008 Dated March 21, 2023
Mount Mapping Report	Hudson Design Group, LLC Site ID: 467600 Dated June 15, 2021
Filter Add Scope	Provided by Verizon Wireless

Analysis Criteria:

Codes and Standards:	ANSI/TIA-222-H 2022 Connecticut State Building Code (DSBC), Effective October 1, 2022
Wind Parameters:	Basic Wind Speed (Ultimate 3-sec. Gust), V_{ULT} : 125 mph Ice Wind Speed (3-sec. Gust): 50 mph Design Ice Thickness: 1.00 in Risk Category: II Exposure Category: B Topographic Category: 1 Topographic Feature Considered: N/A Topographic Method: N/A Ground Elevation Factor, K_e : 0.998
Seismic Parameters:	S_s : 0.201 g S_1 : 0.054 g
Maintenance Parameters:	Wind Speed (3-sec. Gust): 30 mph Maintenance Load, L_v : 250 lbs. Maintenance Load, L_m : 500 lbs.
Analysis Software:	RISA-3D (V17)

Final Loading Configuration:

The following equipment has been considered for the analysis of the mount:

Mount Elevation (ft)	Equipment Elevation (ft)	Quantity	Manufacturer	Model	Status
110.00	112.00	6	Kaelus	BSF0020F3V1-1	Added
		3	Commscope	HBXX-6517DS-A2M	Retained
		6	JMA Wireless	MX06FRO660-03	
		3	Samsung	MT6407-77A	
		3	Samsung	RF4439d-25A	
		3	Samsung	RF4440d-13A	
		2	Raycap	OVP6*	

*Equipment is flush mounted directly to the Monopole. They are not mounted on the platform mount and are not included in this mount analysis.

It is acceptable to install up to any three (3) of the OVP model numbers listed below as required at any location other than the mount face without affecting the structural capacity of the mount. If OVP units are installed on the mount face, a mount re-analysis may be required unless replacing an existing OVP.

Model Number	Ports	AKA
DB-B1-6C-12AB-0Z	6	OVP-6
RVZDC-6627-PF-48	12	OVP-12

Standard Conditions:

1. All engineering services are performed on the basis that the information provided to Colliers Engineering & Design CT, PC and used in this analysis is current and correct. The existing equipment loading has been applied at locations determined from the supplied documentation. Any deviation from the loading locations specified in this report shall be communicated to Colliers Engineering & Design CT, PC to verify deviation will not adversely impact the analysis.
2. Mounts are assumed to have been properly fabricated, installed and maintained in good condition, twist free and plumb in accordance with its original design and manufacturer’s specifications.

Obvious safety and structural issues/deficiencies noticed at the time of the mount mapping and reported in the Mount Mapping Report are assumed to be corrected and documented as part of the PMI process and are not considered in the mount analysis.

The mount analysis and the mount mapping are not a condition assessment of the mount. Proper maintenance and condition assessments are still required post analysis.

3. For mount analyses completed from other data sources (including new replacement mounts) and not specifically mapped in accordance with the NSTD-446 Standard, the mounts are assumed to have been properly fabricated, installed and maintained in good condition, twist free and plumb in accordance with its original design and manufacturer’s specifications.
4. All member connections are assumed to have been designed to meet or exceed the load carrying capacity of the connected member unless otherwise specified in this report.

5. The mount was checked up to, and including, the bolts that fasten it to the mount collar/attachment and threaded rod connections in collar members if applicable. Local deformation and interaction between the mount collar/attachment and the supporting tower structure are outside the scope of this analysis.
6. All services are performed, results obtained, and recommendations made in accordance with generally accepted engineering principles and practices. Colliers Engineering & Design is not responsible for the conclusion, opinions, and recommendations made by others based on the information supplied.
7. Structural Steel Grades have been assumed as follows, if applicable, unless otherwise noted in this analysis:
 - o Channel, Solid Round, Angle, Plate ASTM A36 (Gr. 36)
 - o HSS (Rectangular) ASTM 500 (Gr. B-46)
 - o Pipe ASTM A53 (Gr. B-35)
 - o Threaded Rod F1554 (Gr. 36)
 - o Bolts ASTM A325

Discrepancies between in-field conditions and the assumptions listed above may render this analysis invalid unless explicitly approved by Colliers Engineering & Design CT, PC.

Analysis Results:

Component	Utilization %	Pass/Fail
Face Horizontal	17.0	Pass
Standoff Horizontal	34.4	Pass
Corner Plate	20.0	Pass
Platform Crossmember	17.2	Pass
Grating Support	12.9	Pass
Mount Pipe	43.3	Pass
Cross Arm Plate	33.8	Pass
Support Rail	21.3	Pass
Support Rail Corner	38.8	Pass
Mount Connection	52.9	Pass

Structure Rating – (Controlling Utilization of all Components)	52.9%
---	--------------

Mount Steel (EPA)a per ANSI/TIA-222-H Section 2.6.11.2:

Ice Thickness (In)	Mount Pipes Excluded		Mount Pipes Included	
	Front (EPA)a (Sq. Ft.)	Side (EPA)a (Sq. Ft.)	Front (EPA)a (Sq. Ft.)	Side (EPA)a (Sq. Ft.)
0	24.1	24.1	38.2	38.2
0.5	31.1	31.1	50.9	50.9
1	37.7	37.7	63.1	63.1

Notes:

- (EPA)a values listed above may be used in the absence of more precise information
- (EPA)a values in the table above include 3 sector(s).
- Ka factors included in (EPA)a calculations

Requirements:

The existing mount is **SUFFICIENT** for the final loading configuration shown in attachment 2 and do not require modifications. Additional requirements are noted below.

If required, ANSI/ASSP rigging plan review services compliant with the requirements of ANSI/TIA 322 are available for a Construction Class IV site or other. Separate review fees will apply.

Attachments:

1. **Contractor Required Post Installation Inspection (PMI) Report Deliverables**
2. Antenna Placement Diagrams
3. Mount Photos
4. Mount Mapping Report (for reference only)
5. Analysis Calculations

Mount Desktop – Post Modification Inspection (PMI) Report Requirements

Documents & Photos Required from Contractor – **Passing Mount Analysis**

Passing Mount Analysis requires a PMI due to a modification in loading.

Electronic pdf version of this can be downloaded at <https://pmi.vzsmart.com>.

For additional questions and support, please reach out to pmisupport@colliersengineering.com

MDG #: 5000386426

SMART Project #: 10206412

Fuze Project ID: 17123774

Purpose – to provide SMART Tool structural vendor the proper documentation in order to complete the required Mount Desktop review of the Post Modification Inspection Report.

- Contractor is responsible for making certain the photos provided as noted below provide confirmation that the installation was completed in accordance with this Passing Mount Analysis.
- Contractor shall relay any data that can impact the performance of the mount, this includes safety issues.

Base Requirements:

- If installation will cause damage to the structure, the climbing facility, or safety climb if present or any installed system, SMART Tool vendor to be notified prior to install. Any special photos outside of the standard requirements will be indicated on the drawings.
- Provide “as built mount drawings” showing contractor’s name, contact information, preparer’s signature, and date. Any deviations from the drawings (Proposed modification) shall be shown. NOTE: If loading is different than what is conveyed in the passing mount analysis (MA) contact the SMART Tool vendor immediately.
- Each photo should be time and date stamped
- Photos should be high resolution.
- Contractor shall ensure that the safety climb wire rope is supported and not adversely impacted by the install of the modification components. This may involve the install of wire rope guides, or other items to protect the wire rope. If there is conflict, contact the SMART Tool engineer for recommendations.
- The PMI can be accessed at the following portal: <https://pmi.vzsmart.com>

Photo Requirements:

- Photos taken at ground level
 - Photo of Gate Signs showing the tower owner, site name, and number.
 - Overall tower structure after installation.
 - Photos of the mount after installation; if the mounts are at different rad elevations, pictures must be provided for all elevations that equipment was installed.
- Photos taken at Mount Elevation
 - Photos showing the safety climb wire rope above and below the mount prior to installation.
 - Photos showing the climbing facility and safety climb if present.

- Photos showing each individual sector after installation. Each entire sector shall be in one photo to show the interconnection of members.
 - These photos shall also certify that the placement and geometry of the equipment on the mount is as depicted in the antenna placement diagram in this form.
- Photos that show the model number of each antenna and piece of equipment installed per sector.

Antenna & equipment placement and Geometry Confirmation:

- The contractor shall certify that the antenna & equipment placement and geometry is in accordance with the sketch and table as included in the mount analysis and noted below.
 - The contractor certifies that the photos support and the equipment on the mount is as depicted on the sketch and table included in this form and with the mount analysis provided.

OR

- The contractor notes that the equipment on the mount is not in accordance with the sketch and has noted the differences below and provided photo documentation of any alterations.

Special Instructions / Validation as required from the MA or any other information the contractor deems necessary to share that was identified:

Issue:

Response:

Special Instruction Confirmation:

- The contractor has read and acknowledges the above special instructions.
- All hardware listed in the Special Instructions above (if applicable) has been properly installed, and the existing hardware was inspected.
- The material utilized was as specified in the SMART Tool engineering vendor Special Instructions above (if applicable) and included in the material certification folder is a packing list or invoice for these materials.

OR

The material utilized was approved by a SMART Tool engineering vendor as an “equivalent” and this approval is included as part of the contractor submission.

Comments:

--

Contractor certifies that the climbing facility / safety climb was not damaged prior to starting work:

Yes No

Contractor certifies no new damage created during the current installation:

Yes No

Contractor to certify the condition of the safety climb and verify no damage when leaving the site:

Safety Climb in Good Condition Safety Climb Damaged

Certifying Individual:

Company:	
Employee Name:	
Contact Phone:	
Email:	
Date:	

Plan View

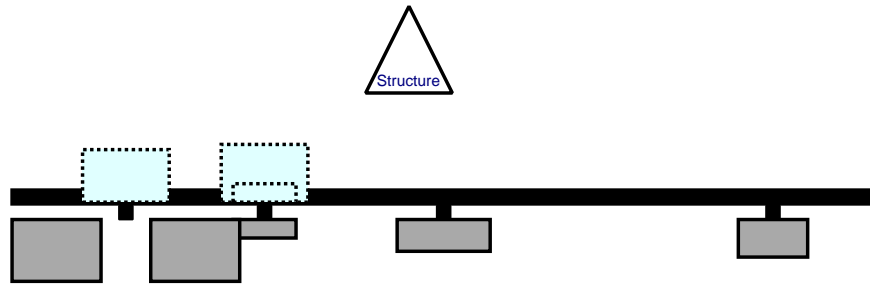

Front View - Looking at Structure

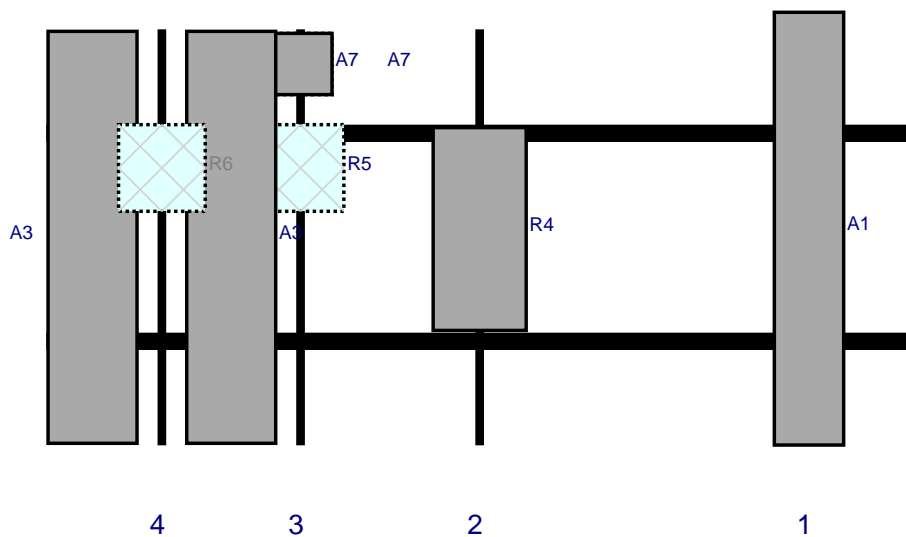

Ref#	Model	Height (in)	Width (in)	H Dist Frm L.	Pipe #	Pipe Pos V	Ant Pos	C. Ant Frm T.	Ant H Off	Status	Validation
A1	HBXX-6517DS-A2M	74.9	12	132	1	a	Front	34.5	0	Retained	03/02/2023
R4	MT6407-77A	35.1	16.1	75	2	a	Front	34.56	0	Retained	03/02/2023
R5	RF4439d-25A	15	15	44	3	a	Behind	24	0	Retained	03/02/2023
A7	BSF0020F3V1-1	10.6	10.9	44	3	a	Behind	6	0	Added	
A7	BSF0020F3V1-1	10.6	10.9	44	3	b	Front	6	0	Added	
A3	MX06FRO660-03	71.3	15.4	20	4	a	Front	36	12	Retained	03/02/2023
A3	MX06FRO660-03	71.3	15.4	20	4	b	Front	36	-12	Retained	03/02/2023
R6	RF4440d-13A	15	15	20	4	a	Behind	24	0	Retained	03/02/2023

Plan View

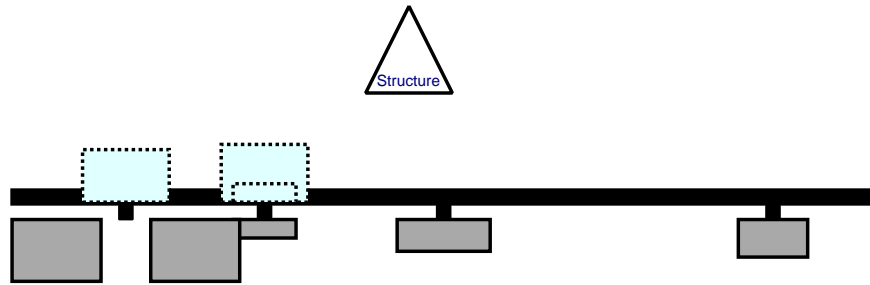

Front View - Looking at Structure

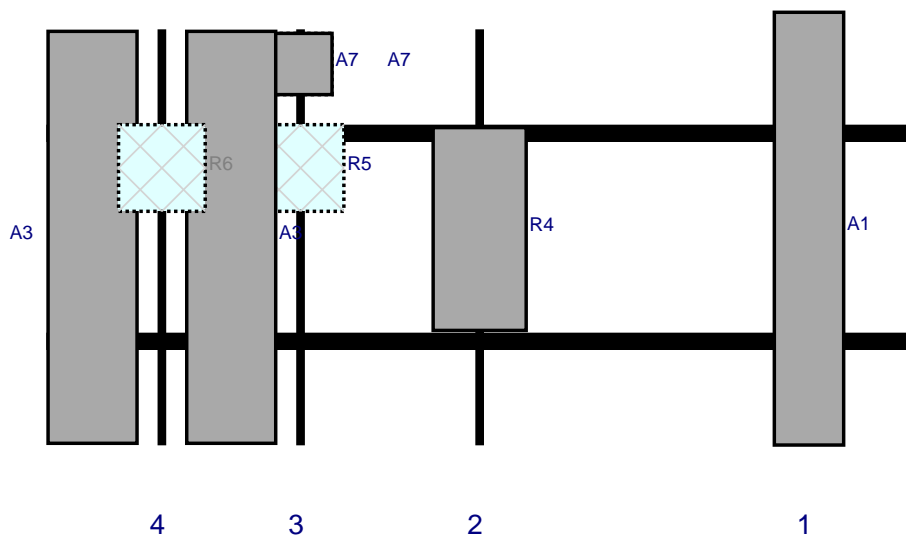

Ref#	Model	Height (in)	Width (in)	H Dist Frm L.	Pipe #	Pipe Pos V	Ant Pos	C. Ant Frm T.	Ant H Off	Status	Validation
A1	HBXX-6517DS-A2M	74.9	12	132	1	a	Front	34.5	0	Retained	03/02/2023
R4	MT6407-77A	35.1	16.1	75	2	a	Front	34.56	0	Retained	03/02/2023
R5	RF4439d-25A	15	15	44	3	a	Behind	24	0	Retained	03/02/2023
A7	BSF0020F3V1-1	10.6	10.9	44	3	a	Behind	6	0	Added	
A7	BSF0020F3V1-1	10.6	10.9	44	3	b	Front	6	0	Added	
A3	MX06FRO660-03	71.3	15.4	20	4	a	Front	36	12	Retained	03/02/2023
A3	MX06FRO660-03	71.3	15.4	20	4	b	Front	36	-12	Retained	03/02/2023
R6	RF4440d-13A	15	15	20	4	a	Behind	24	0	Retained	03/02/2023

Plan View

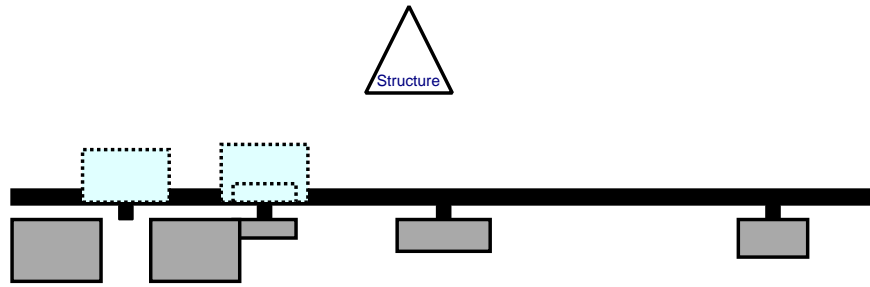

Front View - Looking at Structure

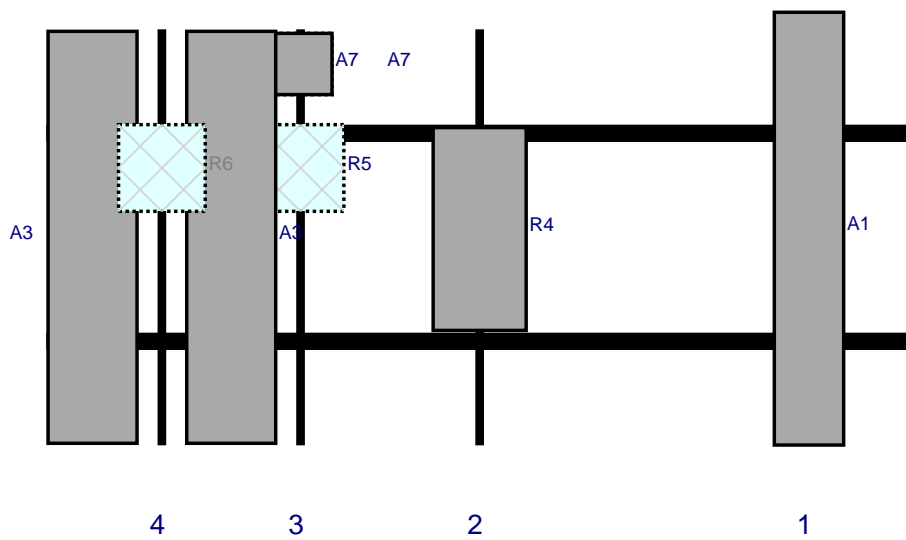

Ref#	Model	Height (in)	Width (in)	H Dist Frm L.	Pipe #	Pipe Pos V	Ant Pos	C. Ant Frm T.	Ant H Off	Status	Validation
A1	HBXX-6517DS-A2M	74.9	12	132	1	a	Front	34.5	0	Retained	03/02/2023
R4	MT6407-77A	35.1	16.1	75	2	a	Front	34.56	0	Retained	03/02/2023
R5	RF4439d-25A	15	15	44	3	a	Behind	24	0	Retained	03/02/2023
A7	BSF0020F3V1-1	10.6	10.9	44	3	a	Behind	6	0	Added	
A7	BSF0020F3V1-1	10.6	10.9	44	3	b	Front	6	0	Added	
A3	MX06FRO660-03	71.3	15.4	20	4	a	Front	36	12	Retained	03/02/2023
A3	MX06FRO660-03	71.3	15.4	20	4	b	Front	36	-12	Retained	03/02/2023
R6	RF4440d-13A	15	15	20	4	a	Behind	24	0	Retained	03/02/2023





Antenna Mount Mapping Form (PATENT PENDING)

FCC #

Tower Owner:	OTHER	Mapping Date:	6/15/2021
Site Name:	BRANFORD 4 CT	Tower Type:	Monopole
Site Number or ID:	467600	Tower Height (Ft.):	
Mapping Contractor:	HUDSON DESIGN GROUP, LLC.	Mount Elevation (Ft.):	111.75

This antenna mapping form is the property of TES and under **PATENT PENDING**. The formation contained herein is considered confidential in nature and is to be used only for the specific customer it was intended for. Reproduction, transmission, publication, modification or disclosure by any method is prohibited except by express written permission of TES. All means and methods are the responsibility of the contractor and the work shall be compliant with ANSI/ASSE A 10.48, OSHA, FCC, FAA and other safety requirements that may apply. TES is not warranting the usability of the safety climb as it must be assessed prior to each use in compliance with OSHA requirements.

Please insert the sketches of the antenna mount from the "Sketches" tab with dimensions and members here.

Mount Pipe Configuration and Geometries [Unit = Inches]							
Sector / Position	Mount Pipe Size & Length	Vertical Offset Dimension "u"	Horizontal Offset "C1, C2, C3, etc."	Sector / Position	Mount Pipe Size & Length	Vertical Offset Dimension "u"	Horizontal Offset "C1, C2, C3, etc."
A1				C1			
A2				C2			
A3				C3			
A4				C4			
A5				C5			
A6				C6			
B1				D1			
B2				D2			
B3				D3			
B4				D4			
B5				D5			
B6				D6			

Distance between bottom rail and mount CL elevation (dim d). Unit is inches. See 'Mount Elev Ref' tab for details. :
 Distance from top of bottom support rail to lowest tip of ant./eqpt. of Carrier above. (N/A if > 10 ft.) :
 Distance from top of bottom support rail to highest tip of ant./eqpt. of Carrier below. (N/A if > 10 ft.) :

Please enter additional information or comments below.

TOWER WAS MAPPED FROM GROUND ONLY

Tower Face Width at Mount Elev. (ft.):	Tower Leg Size or Pole Shaft Diameter at Mount Elev. (in.):

For T-Arms/Platforms on monopoles, report the weld size from the main standoff to the plate bolting into the collar mount.

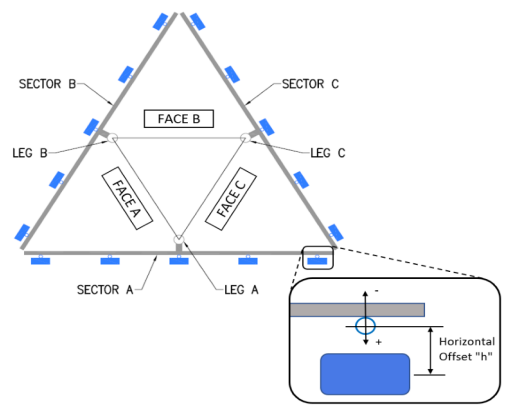

Ants. Items	Enter antenna model. If not labeled, enter "Unknown".					Mounting Locations [Units are inches and degrees]			Photos of antennas
	Antenna Models if Known	Width (in.)	Depth (in.)	Height (in.)	Coax Size and Qty	Antenna Center-line (Ft.)	Vertical Distances "b _{1a} , b _{2a} , b _{3a} , b _{1b} ,..." (Inches)	Horiz. Offset "h" (Use "-" if Ant. is behind)	

Sector A									
Ant _{1a}	UNKNOWN					111.75			6
Ant _{1b}	UNKNOWN					111.75		5.00	6
Ant _{1c}									
Ant _{2a}	UNKNOWN					111.75			7
Ant _{2b}	UNKNOWN					111.75		5.00	7
Ant _{2c}									
Ant _{3a}	UNKNOWN					111.75			
Ant _{3b}								5.00	9
Ant _{3c}									
Ant _{4a}									
Ant _{4b}	UNKNOWN					111.75		5.00	9
Ant _{4c}									
Ant _{5a}									
Ant _{5b}									
Ant _{5c}									
Ant on Standoff									
Ant on Standoff									
Ant on Tower									
Ant on Tower									

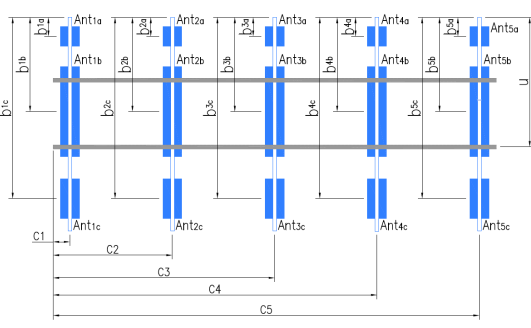

Antenna Layout (Looking Out From Tower)

Observed Safety and Structural Issues During the Mount Mapping

Issue #	Description of Issue	Photo #
1	This was a ground audit and we added a possible mount dwg that is a possible match for reference only	
2		
3		
4		
5		
6		
7		
8		

Observed Obstructions to Tower Lighting System

If the tower lighting system is being obstructed by the carrier's equipment (for example: a light nested by the antennas), please provide photos and fill in the information below.		Photo #
Description of Obstruction:		
Type of Light:	Photo #	Additional Comments:
Lighting Technology:	Photo #	
Elevation (AGL) at base of light (Ft.):	Photo #	
Is a service loop available?	Photo #	
Is beacon installed on an extension?	Photo #	

Mapping Notes

1. Please report any visible structural or safety issues observed on the antenna mounts (Damaged members, loose connections, tilting mounts, safety climb issues, etc.)
2. If the thickness of the existing pipes or tubing can't be obtained from a general tool (such as Caliper), please use an ultrasonic measurement tool (thickness gauge) to measure the thickness.
3. Please create all required detail sketches of the mounts and insert them into the "Sketches" tab.
4. Please measure and enter the bolt sizes and types under the Members Box in the spreadsheet of the mount type.
5. Take and label the photos of the tower, mounts, connections, antennas and all measurements. Minimum 50 photos are required.
6. Please measure and report the size and length of all existing antenna mounting pipes.
7. Please measure and report the antenna information for all sectors.
8. Don't delete or rearrange any sheet or contents of any sheet from this mapping form.

Standard Conditions

1. Obvious safety and structural issues/deficiencies noticed at the time of the mount mapping are to be reported in this mapping. However, this mount mapping is not a condition assessment of the mount.



Antenna Mount Mapping Form (PATENT PENDING)

FCC #

Tower Owner:	OTHER	Mapping Date:	6/15/2021
Site Name:	BRANFORD 4 CT	Tower Type:	Monopole
Site Number or ID:	467600	Tower Height (Ft.):	
Mapping Contractor:	HUDSON DESIGN GROUP, LLC.	Mount Elevation (Ft.):	111.75

This antenna mapping form is the property of TES and under **PATENT PENDING**. The formation contained herein is considered confidential in nature and is to be used only for the specific customer it was intended for. Reproduction, transmission, publication, modification or disclosure by any method is prohibited except by express written permission of TES. All means and methods are the responsibility of the contractor and the work shall be compliant with ANSI/ASSE A 10.48, OSHA, FCC, FAA and other safety requirements that may apply. TES is not warranting the usability of the safety climb as it must be assessed prior to each use in compliance with OSHA requirements.

Please Insert Sketches of the Antenna Mount

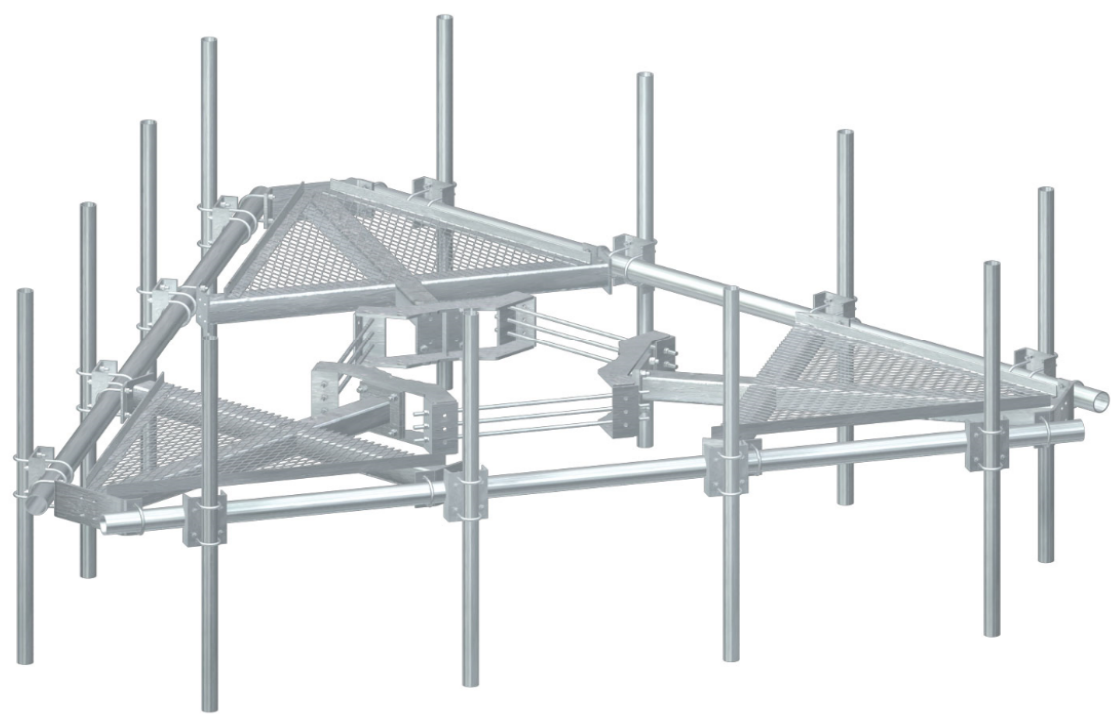

Please Insert Sketches of the Antenna Mount, cont'd

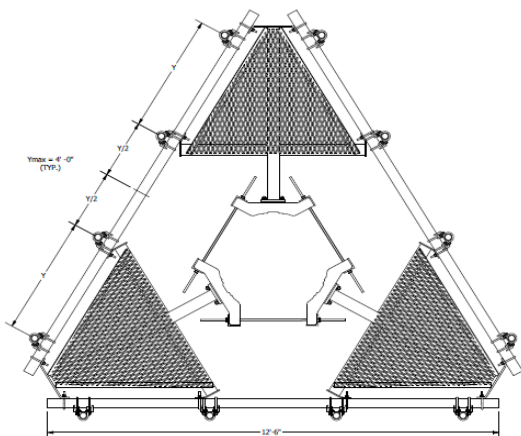

PARTS LIST			
PART DESCRIPTION	LENGTH	UNIT WT.	NET WT.
CO-LOCATION MOUNT WELDMENT		68.61	206.42
1/2" X 48" THREADED ROD (HDG.)		0.40	3.59
1/2" X 24" THREADED ROD (HDG.)		0.40	3.59
PROFILE PLATFORM CORNER		212.10	636.31
2-3/4" HDG A325 HEX BOLT	2.75	0.36	4.27
1" HDG A325 FLATWASHER		0.03	0.41
5/8" HDG LOCKWASHER		0.03	0.78
5/8" HDG A325 HEX NUT		0.13	3.90
150" SCH 40 GALVANIZED PIPE	150.000 in	94.80	284.40
3-5/8" X 6" X 3" U-BOLT (HDG.)		0.26	9.25
2" HDG USS FLATWASHER		0.03	4.09
1/2" HDG LOCKWASHER		0.01	1.67
1" HDG HEAVY 2H HEX NUT		0.07	8.60
ALL SUPPORT CROSS PLATE	8.250 in	8.61	103.33
1/2" X 4-1/2" X 2" U-BOLT (HDG.)		0.26	6.17
ANTENNA MOUNTING PIPE		C	D
			E

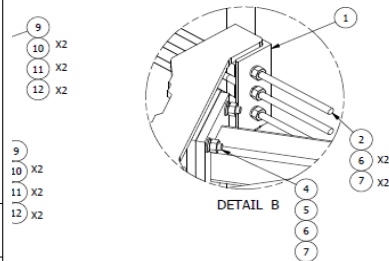

TOLERANCE NOTE TOLERANCES ON DIMENSIONS, UNLESS OTHERWISE NOTED ARE: SAWS, SHEARED AND GAS CUT EDGES (± 0.030") DRILLED AND GAS CUT HOLES (± 0.030") - NO CONING OF HOLES LASER CUT EDGES AND HOLES (± 0.010") - NO CONING OF HOLES BENDS ARE ± 1/2 DEGREE - ALL OTHER MACHINING (± 0.030") ALL OTHER ASSEMBLY (± 0.060")		DESCRIPTION LOW PROFILE CO-LOCATION PLATFORM FOR 12 ANTENNAS WITH 12' 6" FACE WIDTH FOR 12" - 36" DIAMETER POLES		SITE PRO 1 Engineering Support Team 1-888-753-7446 Locations: New York, NY; Atlanta, GA; Los Angeles, CA; Plymouth, IN; Dallas, TX	
PROPRIETARY NOTE THE DATA AND TECHNIQUES CONTAINED IN THIS DRAWING ARE PROPRIETARY INFORMATION OF VALMONT INDUSTRIES AND CONSIDERED A TRADE SECRET. ANY USE OR DISCLOSURE WITHOUT THE CONSENT OF VALMONT INDUSTRIES IS STRICTLY PROHIBITED.		DRAWN BY: CEK 1/20/2012 CPD NO: semb DRAWING USAGE: CUSTOMER ENG. APPROVAL: BMC 7/9/2015		PART NO.: SEE ASSEMBLY NO. "A" DWG. NO.: RMQP-4XX	

ASSEMBLY NO. "A"	PART NO. "B"	LENGTH, "C"	UNIT WEIGHT, "D"	NET WEIGHT, "E"	TOTAL WEIGHT
RMQP-463	P263	63"	20.18	242.16	1591.11
RMQP-472	P272	72"	23.07	276.84	1635.79
RMQP-484	P284	84"	26.91	322.92	1671.87
RMQP-496	P296	96"	30.76	369.12	1718.07
RMQP-4126	P2126	126"	40.75	489.00	1837.95

TOLERANCE NOTE TOLERANCES ON DIMENSIONS, UNLESS OTHERWISE NOTED ARE: SAWS, SHEARED AND GAS CUT EDGES (± 0.030") DRILLED AND GAS CUT HOLES (± 0.030") - NO CONING OF HOLES LASER CUT EDGES AND HOLES (± 0.010") - NO CONING OF HOLES BENDS ARE ± 1/2 DEGREE - ALL OTHER MACHINING (± 0.030") ALL OTHER ASSEMBLY (± 0.060")		DESCRIPTION LOW PROFILE CO-LOCATION PLATFORM FOR 12 ANTENNAS WITH 12' 6" FACE WIDTH FOR 12" - 36" DIAMETER POLES		SITE PRO 1 Engineering Support Team 1-888-753-7446 Locations: New York, NY; Atlanta, GA; Los Angeles, CA; Plymouth, IN; Dallas, TX	
PROPRIETARY NOTE THE DATA AND TECHNIQUES CONTAINED IN THIS DRAWING ARE PROPRIETARY INFORMATION OF VALMONT INDUSTRIES AND CONSIDERED A TRADE SECRET. ANY USE OR DISCLOSURE WITHOUT THE CONSENT OF VALMONT INDUSTRIES IS STRICTLY PROHIBITED.		DRAWN BY: CEK 1/20/2012 CPD NO: semb DRAWING USAGE: CUSTOMER ENG. APPROVAL: BMC 7/9/2015		PART NO.: SEE ASSEMBLY NO. "A" DWG. NO.: RMQP-4XX	

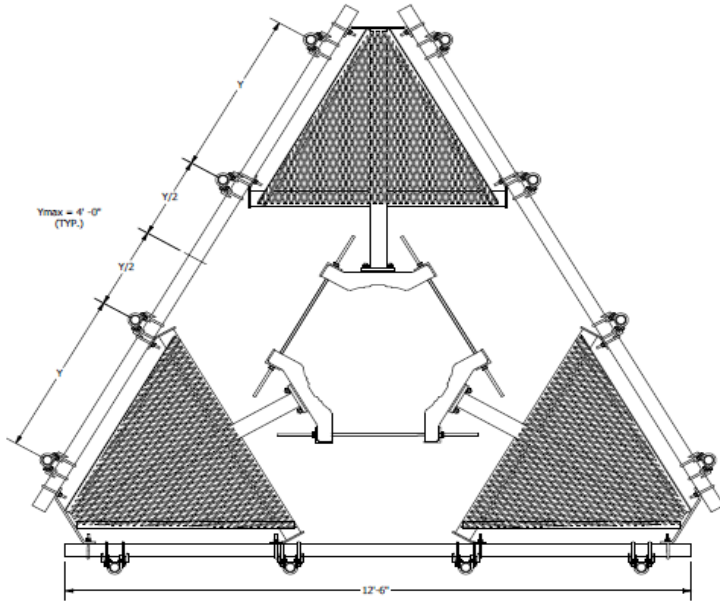

TOLERANCE NOTE TOLERANCES ON DIMENSIONS, UNLESS OTHERWISE NOTED ARE: SAWS, SHEARED AND GAS CUT EDGES (± 0.030") DRILLED AND GAS CUT HOLES (± 0.030") - NO CONING OF HOLES LASER CUT EDGES AND HOLES (± 0.010") - NO CONING OF HOLES BENDS ARE ± 1/2 DEGREE - ALL OTHER MACHINING (± 0.030") ALL OTHER ASSEMBLY (± 0.060")		DESCRIPTION LOW PROFILE CO-LOCATION PLATFORM FOR 12 ANTENNAS WITH 12' 6" FACE WIDTH FOR 12" - 36" DIAMETER POLES		SITE PRO 1 Engineering Support Team 1-888-753-7446 Locations: New York, NY; Atlanta, GA; Los Angeles, CA; Plymouth, IN; Dallas, TX	
PROPRIETARY NOTE THE DATA AND TECHNIQUES CONTAINED IN THIS DRAWING ARE PROPRIETARY INFORMATION OF VALMONT INDUSTRIES AND CONSIDERED A TRADE SECRET. ANY USE OR DISCLOSURE WITHOUT THE CONSENT OF VALMONT INDUSTRIES IS STRICTLY PROHIBITED.		DRAWN BY: CEK 1/20/2012 CPD NO: semb DRAWING USAGE: CUSTOMER ENG. APPROVAL: BMC 7/9/2015		PART NO.: SEE ASSEMBLY NO. "A" DWG. NO.: RMQP-4XX	

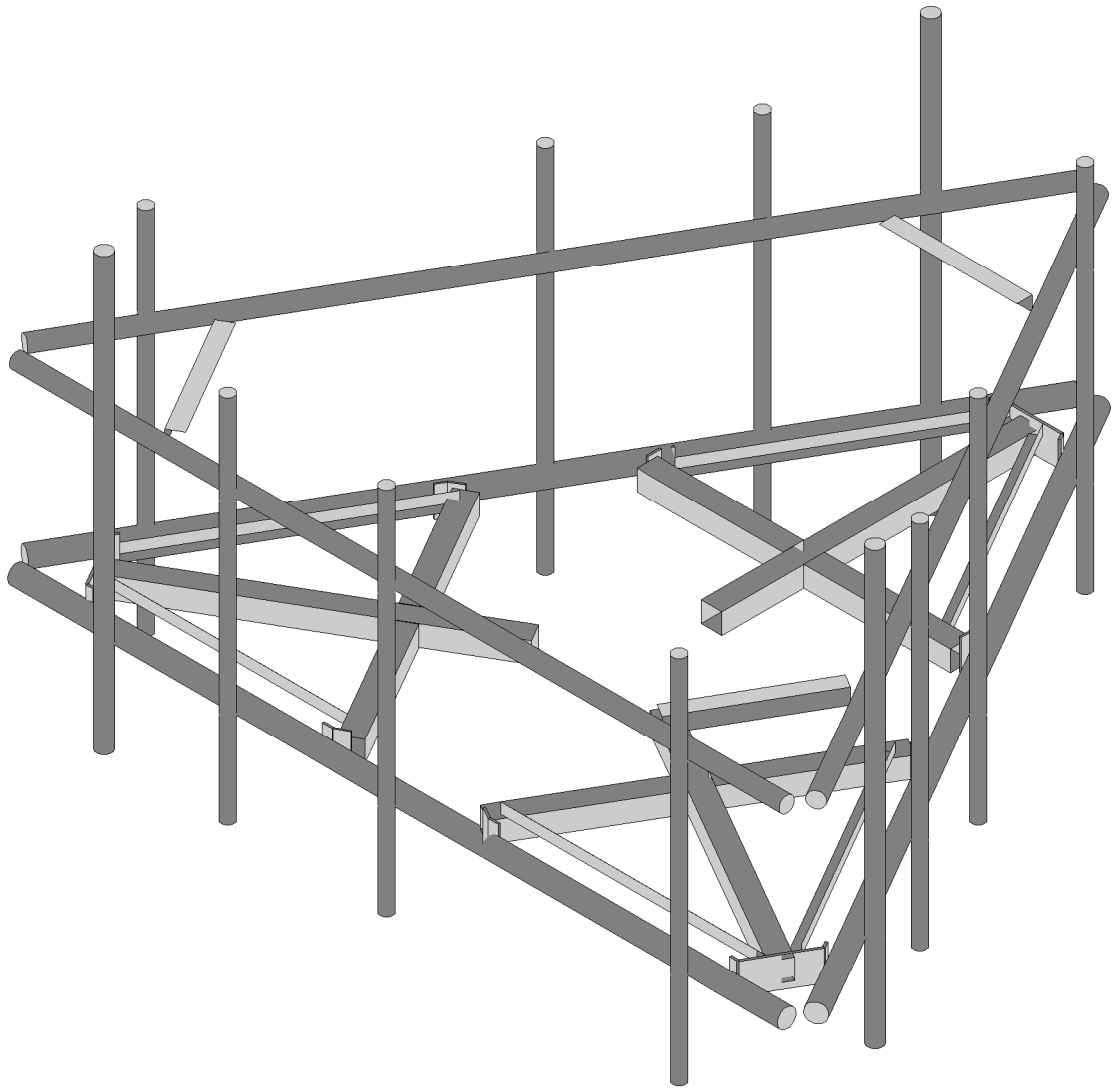

Envelope Only Solution

		SK - 1
		July 6, 2023 at 1:02 PM
	Rendered Model	5000386426-VZW_MT_LO_H.r3d



Code Check (Env)	
■	No Calc
■	> 1.0
■	99-1.0
■	75-99
■	50-75
■	0-50

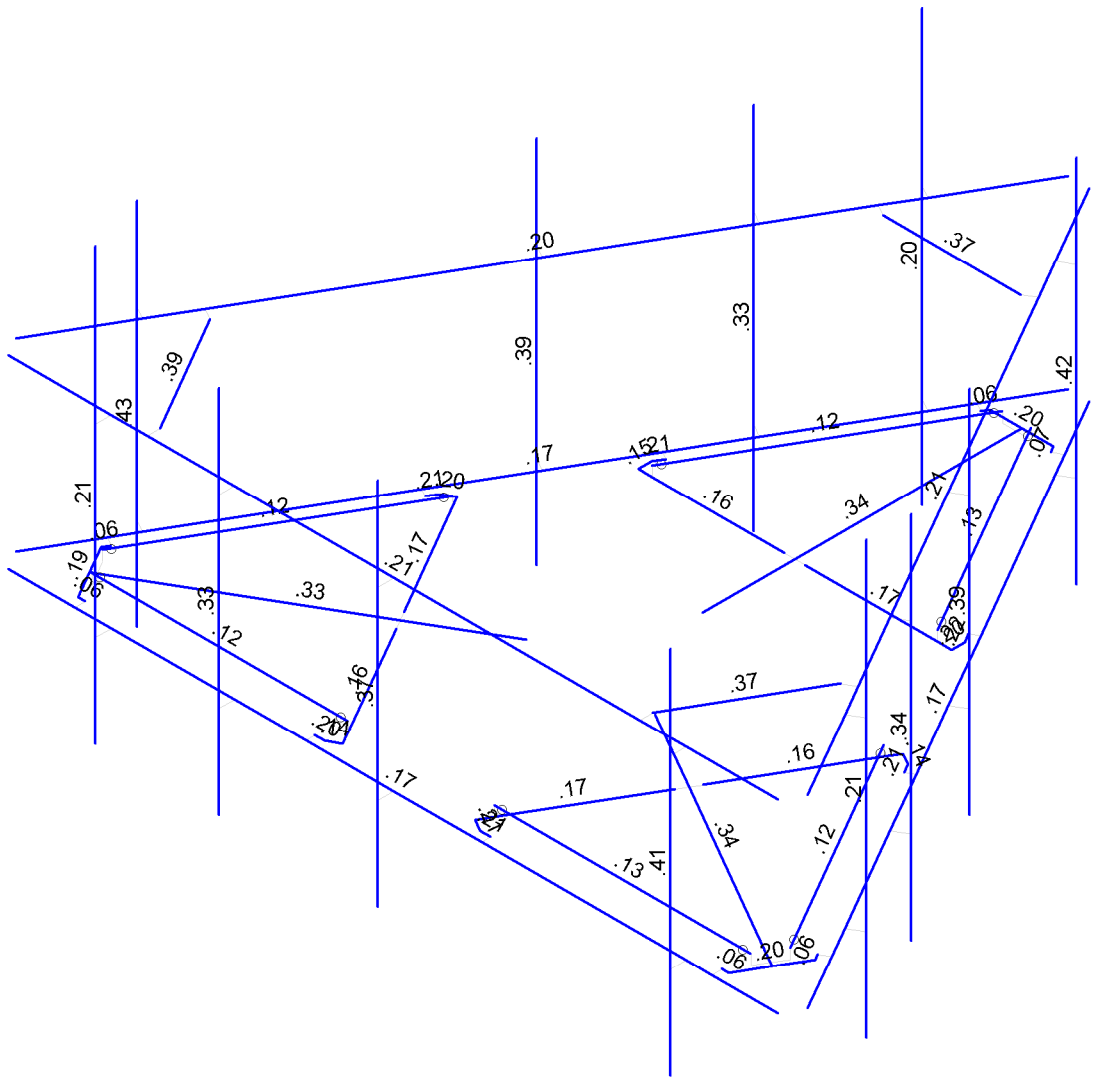

Member Code Checks Displayed (Enveloped)
Envelope Only Solution

		SK - 2
		July 6, 2023 at 1:02 PM
	Bending Check	5000386426-VZW_MT_LO_H.r3d

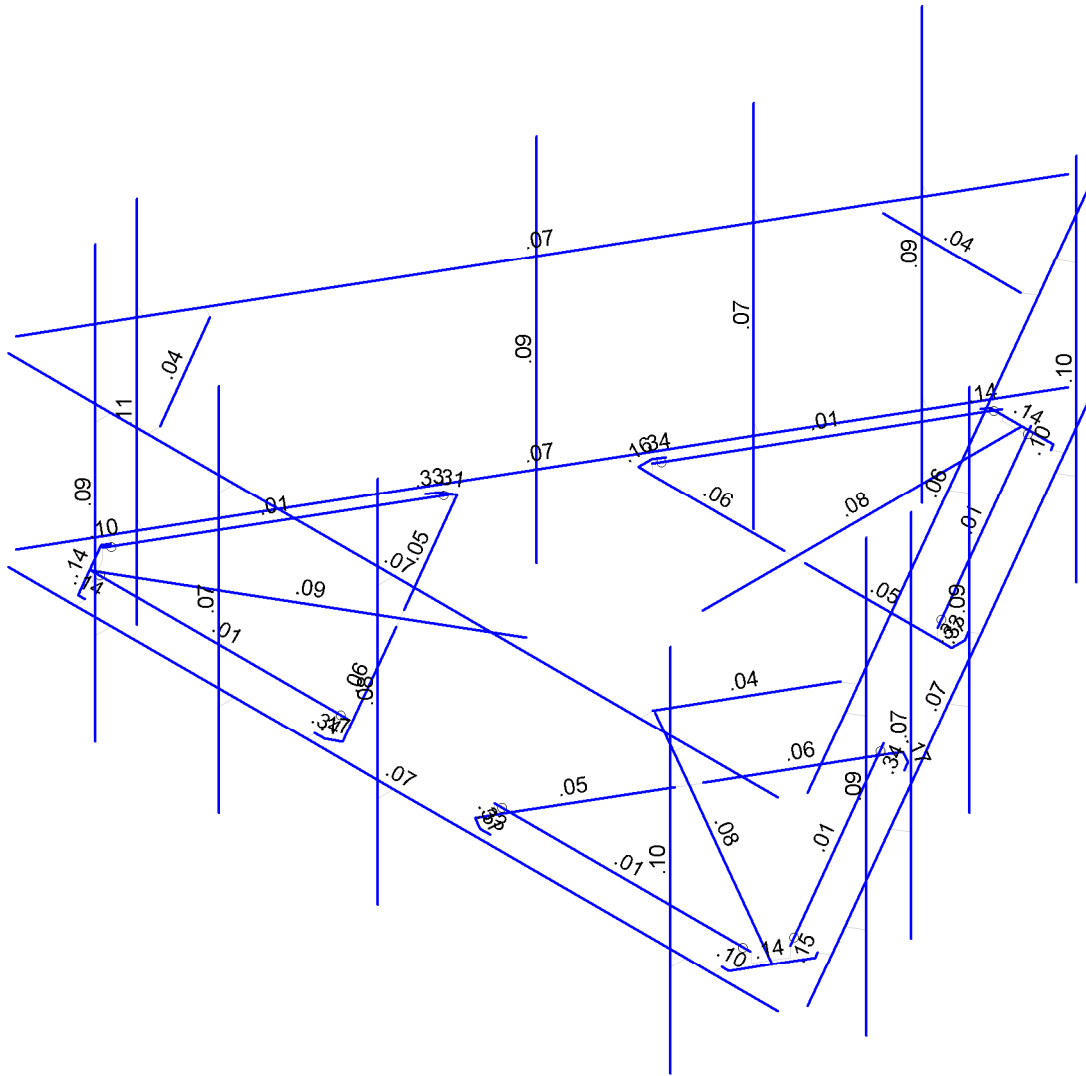

Member Shear Checks Displayed (Enveloped)
Envelope Only Solution

		SK - 3
		July 6, 2023 at 1:02 PM
	Shear Check	5000386426-VZW_MT_LO_H.r3d



Company :
 Designer :
 Job Number :
 Model Name :

July 6, 2023
 1:03 PM
 Checked By: _____

Basic Load Cases

	BLC Description	Category	X Gravity	Y Gravity	Z Gravity	Joint	Point	Distributed Area(Me...)	Surface(P...
1	Antenna D	None					99		
2	Antenna Di	None					99		
3	Antenna Wo (0 Deg)	None					99		
4	Antenna Wo (30 Deg)	None					99		
5	Antenna Wo (60 Deg)	None					99		
6	Antenna Wo (90 Deg)	None					99		
7	Antenna Wo (120 Deg)	None					99		
8	Antenna Wo (150 Deg)	None					99		
9	Antenna Wo (180 Deg)	None					99		
10	Antenna Wo (210 Deg)	None					99		
11	Antenna Wo (240 Deg)	None					99		
12	Antenna Wo (270 Deg)	None					99		
13	Antenna Wo (300 Deg)	None					99		
14	Antenna Wo (330 Deg)	None					99		
15	Antenna Wi (0 Deg)	None					99		
16	Antenna Wi (30 Deg)	None					99		
17	Antenna Wi (60 Deg)	None					99		
18	Antenna Wi (90 Deg)	None					99		
19	Antenna Wi (120 Deg)	None					99		
20	Antenna Wi (150 Deg)	None					99		
21	Antenna Wi (180 Deg)	None					99		
22	Antenna Wi (210 Deg)	None					99		
23	Antenna Wi (240 Deg)	None					99		
24	Antenna Wi (270 Deg)	None					99		
25	Antenna Wi (300 Deg)	None					99		
26	Antenna Wi (330 Deg)	None					99		
27	Antenna Wm (0 Deg)	None					99		
28	Antenna Wm (30 Deg)	None					99		
29	Antenna Wm (60 Deg)	None					99		
30	Antenna Wm (90 Deg)	None					99		
31	Antenna Wm (120 Deg)	None					99		
32	Antenna Wm (150 Deg)	None					99		
33	Antenna Wm (180 Deg)	None					99		
34	Antenna Wm (210 Deg)	None					99		
35	Antenna Wm (240 Deg)	None					99		
36	Antenna Wm (270 Deg)	None					99		
37	Antenna Wm (300 Deg)	None					99		
38	Antenna Wm (330 Deg)	None					99		
39	Structure D	None		-1					3
40	Structure Di	None						57	3
41	Structure Wo (0 Deg)	None						114	
42	Structure Wo (30 Deg)	None						114	
43	Structure Wo (60 Deg)	None						114	
44	Structure Wo (90 Deg)	None						114	
45	Structure Wo (120 D...	None						114	
46	Structure Wo (150 D...	None						114	
47	Structure Wo (180 D...	None						114	
48	Structure Wo (210 D...	None						114	
49	Structure Wo (240 D...	None						114	
50	Structure Wo (270 D...	None						114	
51	Structure Wo (300 D...	None						114	
52	Structure Wo (330 D...	None						114	
53	Structure Wi (0 Deg)	None						114	



Company :
 Designer :
 Job Number :
 Model Name :

July 6, 2023
 1:03 PM
 Checked By: _____

Basic Load Cases (Continued)

BLC Description	Category	X Gravity	Y Gravity	Z Gravity	Joint	Point	Distributed Area(Me...	Surface(P...
54 Structure Wi (30 Deg)	None						114	
55 Structure Wi (60 Deg)	None						114	
56 Structure Wi (90 Deg)	None						114	
57 Structure Wi (120 De..)	None						114	
58 Structure Wi (150 De..)	None						114	
59 Structure Wi (180 De..)	None						114	
60 Structure Wi (210 De..)	None						114	
61 Structure Wi (240 De..)	None						114	
62 Structure Wi (270 De..)	None						114	
63 Structure Wi (300 De..)	None						114	
64 Structure Wi (330 De..)	None						114	
65 Structure Wm (0 Deg)	None						114	
66 Structure Wm (30 De..)	None						114	
67 Structure Wm (60 De..)	None						114	
68 Structure Wm (90 De..)	None						114	
69 Structure Wm (120 D..)	None						114	
70 Structure Wm (150 D..)	None						114	
71 Structure Wm (180 D..)	None						114	
72 Structure Wm (210 D..)	None						114	
73 Structure Wm (240 D..)	None						114	
74 Structure Wm (270 D..)	None						114	
75 Structure Wm (300 D..)	None						114	
76 Structure Wm (330 D..)	None						114	
77 Lm1	None					1		
78 Lm2	None					1		
79 Lv1	None					1		
80 Lv2	None					1		
81 Antenna Ev	None					99		
82 Antenna Eh (0 Deg)	None					66		
83 Antenna Eh (90 Deg)	None					66		
84 Structure Ev	ELY		-0.043					3
85 Structure Eh (0 Deg)	ELZ			-0.107				3
86 Structure Eh (90 Deg)	ELX	.107						3
87 BLC 39 Transient Are..	None						30	
88 BLC 40 Transient Are..	None						30	
89 BLC 84 Transient Are..	None						30	
90 BLC 85 Transient Are..	None						30	
91 BLC 86 Transient Are..	None						30	

Load Combinations

Description	S...	P...	S...	B...	Fa...	B...	Fa...	B...	Fa...	B...	Fa...	B...	Fa...	B...	Fa...	B...	Fa...	B...	Fa...	
1 1.2D+1.0Wo (0 Deg)	Yes	Y			1	1.2	39	1.2	3	1	41	1								
2 1.2D+1.0Wo (30 Deg)	Yes	Y			1	1.2	39	1.2	4	1	42	1								
3 1.2D+1.0Wo (60 Deg)	Yes	Y			1	1.2	39	1.2	5	1	43	1								
4 1.2D+1.0Wo (90 Deg)	Yes	Y			1	1.2	39	1.2	6	1	44	1								
5 1.2D+1.0Wo (120 Deg)	Yes	Y			1	1.2	39	1.2	7	1	45	1								
6 1.2D+1.0Wo (150 Deg)	Yes	Y			1	1.2	39	1.2	8	1	46	1								
7 1.2D+1.0Wo (180 Deg)	Yes	Y			1	1.2	39	1.2	9	1	47	1								
8 1.2D+1.0Wo (210 Deg)	Yes	Y			1	1.2	39	1.2	10	1	48	1								
9 1.2D+1.0Wo (240 Deg)	Yes	Y			1	1.2	39	1.2	11	1	49	1								
10 1.2D+1.0Wo (270 Deg)	Yes	Y			1	1.2	39	1.2	12	1	50	1								
11 1.2D+1.0Wo (300 Deg)	Yes	Y			1	1.2	39	1.2	13	1	51	1								
12 1.2D+1.0Wo (330 Deg)	Yes	Y			1	1.2	39	1.2	14	1	52	1								
13 1.2D + 1.0Di + 1.0Wi (0 Deg)	Yes	Y			1	1.2	39	1.2	2	1	40	1	15	1	53	1				
14 1.2D + 1.0Di + 1.0Wi (30 Deg)	Yes	Y			1	1.2	39	1.2	2	1	40	1	16	1	54	1				



Company :
 Designer :
 Job Number :
 Model Name :

July 6, 2023
 1:03 PM
 Checked By: _____

Load Combinations (Continued)

	Description	S...	P...	S...	B...	Fa...	B...	Fa...	B...	Fa...	B...	Fa...	B...	Fa...	B...	Fa...	B...	Fa...	B...	Fa...	B...	Fa...	B...	Fa...	B...	Fa...	B...	Fa...	B...														
72	0.9D - 1.0Ev + 1.0Eh (240 Deg)	Yes	Y			1	.9	39	.9	81	-1	E...	-1	82	-.5	83	-8...	E...	-.5	E...	-.8...																						
73	0.9D - 1.0Ev + 1.0Eh (270 Deg)	Yes	Y			1	.9	39	.9	81	-1	E...	-1	82		83	-1	E...		E...	-1																						
74	0.9D - 1.0Ev + 1.0Eh (300 Deg)	Yes	Y			1	.9	39	.9	81	-1	E...	-1	82	.5	83	-8...	E...	.5	E...	-.8...																						
75	0.9D - 1.0Ev + 1.0Eh (330 Deg)	Yes	Y			1	.9	39	.9	81	-1	E...	-1	82	.866	83	-.5	E...	.866	E...	-.5																						

Joint Coordinates and Temperatures

	Label	X [ft]	Y [ft]	Z [ft]	Temp [F]	Detach From Diap...
1	N1	6.25	0	3.810523	0	
2	N2	-6.25	0	3.810523	0	
3	N3	0	0	-1.208333	0	
4	N5	-2.541667	0	-2.708333	0	
5	N6	2.315104	0.166667	-2.708333	0	
6	N7	-2.315104	0.166667	-2.708333	0	
7	N8	4.75	0	3.810523	0	
8	N9	4.75	0	4.060523	0	
9	N10	-4.583333	0	3.810523	0	
10	N11	-4.583333	0	4.060523	0	
11	N12	-0.	0	3.810523	0	
12	N13	-0.	0	4.060523	0	
13	N14	-2.583333	0	3.810523	0	
14	N15	-2.583333	0	4.060523	0	
15	N16	-2.583333	-1.5	4.060523	0	
16	N17	-2.583333	4.5	4.060523	0	
17	N18	-4.583333	-1.5	4.060523	0	
18	N19	-4.583333	5.5	4.060523	0	
19	N20	-0.	-1.5	4.060523	0	
20	N21	-0.	4.5	4.060523	0	
21	N22	4.75	-1.5	4.060523	0	
22	N23	4.75	4.5	4.060523	0	
23	N24	0	0	-2.708333	0	
24	N27	0	0	-6.395833	0	
25	CP	0	0	0	0	
26	N29	2.315104	0	-2.708333	0	
27	N30	-2.315104	0	-2.708333	0	
28	N101	2.541667	0	-2.708333	0	
29	N102	-0.166667	0	-2.708333	0	
30	N103A	0.166667	0	-2.708333	0	
31	N104A	-2.541667	0	-2.927083	0	
32	N105	2.541667	0	-2.927083	0	
33	N131	2.458333	0	-3.071421	0	
34	N135	0.571615	0	-6.298857	0	
35	N144	-2.458333	0	-3.071421	0	
36	N148	-0.571615	0	-6.298857	0	
37	N86A	2.584629	0	-3.144338	0	
38	N86B	-2.584629	0	-3.144338	0	
39	N86C	-0.515625	0	-6.395833	0	
40	N87A	0.515625	0	-6.395833	0	
41	N86D	0.715429	0	-6.381888	0	
42	N86E	-0.715429	0	-6.381888	0	
43	N88A	0	0	-6.3125	0	
44	N87C	0.234238	0.166667	-6.3125	0	
45	N86G	0.234238	0	-6.3125	0	
46	N87B	-0.234238	0.166667	-6.3125	0	
47	N88C	-0.234238	0	-6.3125	0	
48	N87D	-1.046447	0	0.604167	0	



Company :
 Designer :
 Job Number :
 Model Name :

July 6, 2023
 1:03 PM
 Checked By: _____

Joint Coordinates and Temperatures (Continued)

	Label	X [ft]	Y [ft]	Z [ft]	Temp [F]	Detach From Diap...
49	N88B	-1.074652	0	3.555315	0	
50	N89	-3.503038	0.166667	-0.650772	0	
51	N90	-1.187933	0.166667	3.359106	0	
52	N91	-2.345485	0	1.354167	0	
53	N92	-5.538954	0	3.197917	0	
54	N93	-3.503038	0	-0.650772	0	
55	N94	-1.187933	0	3.359106	0	
56	N95	-3.616319	0	-0.846981	0	
57	N96	-2.262152	0	1.498504	0	
58	N97	-2.428819	0	1.209829	0	
59	N98	-1.264095	0	3.66469	0	
60	N99	-3.805762	0	-0.737606	0	
61	N100	-3.889095	0	-0.593269	0	
62	N101A	-5.740777	0	2.654396	0	
63	N102A	-1.430762	0	3.66469	0	
64	N103	-5.169162	0	3.644461	0	
65	N104	-4.015391	0	-0.666185	0	
66	N105A	-1.430762	0	3.810523	0	
67	N106	-5.281142	0	3.644461	0	
68	N107	-5.796767	0	2.751372	0	
69	N108	-5.884591	0	2.571364	0	
70	N109	-5.169162	0	3.810523	0	
71	N110	-5.466785	0	3.15625	0	
72	N111	-5.583904	0.166667	2.953394	0	
73	N112	-5.583904	0	2.953394	0	
74	N113	-5.349667	0.166667	3.359106	0	
75	N114	-5.349667	0	3.359106	0	
76	N115	1.046447	0	0.604167	0	
77	N116	3.616319	0	-0.846981	0	
78	N117	1.187933	0.166667	3.359106	0	
79	N118	3.503038	0.166667	-0.650772	0	
80	N119	2.345485	0	1.354167	0	
81	N120	5.538954	0	3.197917	0	
82	N121	1.187933	0	3.359106	0	
83	N122	3.503038	0	-0.650772	0	
84	N123	1.074652	0	3.555315	0	
85	N124	2.428819	0	1.209829	0	
86	N125	2.262152	0	1.498504	0	
87	N126	3.805762	0	-0.737606	0	
88	N127	1.264095	0	3.66469	0	
89	N128	1.430762	0	3.66469	0	
90	N129	5.169162	0	3.644461	0	
91	N130	3.889095	0	-0.593269	0	
92	N131A	5.740777	0	2.654396	0	
93	N132	1.430762	0	3.810523	0	
94	N133	4.015391	0	-0.666186	0	
95	N134	5.796767	0	2.751372	0	
96	N135A	5.281142	0	3.644461	0	
97	N136	5.169162	0	3.810523	0	
98	N137	5.884591	0	2.571364	0	
99	N138	5.466785	0	3.15625	0	
100	N139	5.349667	0.166667	3.359106	0	
101	N140	5.349667	0	3.359106	0	
102	N141	5.583904	0.166667	2.953394	0	
103	N142	5.583904	0	2.953394	0	
104	N104B	0.17501	0	-7.31792	0	
105	N105B	6.42501	0	3.507397	0	

Joint Coordinates and Temperatures (Continued)

	Label	X [ft]	Y [ft]	Z [ft]	Temp [F]	Detach From Diap...
106	N124A	-6.42501	0	3.507397	0	
107	N125A	-0.17501	0	-7.31792	0	
108	N108A	0.92501	0	-6.018882	0	
109	N109A	1.141516	0	-6.143882	0	
110	N110A	5.591677	0	2.064021	0	
111	N111A	5.808183	0	1.939021	0	
112	N112A	3.30001	0	-1.905262	0	
113	N113A	3.516516	0	-2.030262	0	
114	N114A	4.591677	0	0.331971	0	
115	N115A	4.808183	0	0.206971	0	
116	N116A	4.808183	-1.5	0.206971	0	
117	N117A	4.808183	4.5	0.206971	0	
118	N118A	5.808183	-1.5	1.939021	0	
119	N119A	5.808183	5.5	1.939021	0	
120	N120A	3.516516	-1.5	-2.030262	0	
121	N121A	3.516516	4.5	-2.030262	0	
122	N122A	1.141516	-1.5	-6.143882	0	
123	N123A	1.141516	4.5	-6.143882	0	
124	N124B	-5.67501	0	2.208359	0	
125	N125B	-5.891516	0	2.083359	0	
126	N126A	-1.008343	0	-5.874545	0	
127	N127A	-1.22485	0	-5.999545	0	
128	N128A	-3.30001	0	-1.905262	0	
129	N129A	-3.516516	0	-2.030262	0	
130	N130A	-2.008343	0	-4.142494	0	
131	N131B	-2.22485	0	-4.267494	0	
132	N132A	-2.22485	-1.5	-4.267494	0	
133	N133A	-2.22485	4.5	-4.267494	0	
134	N134A	-1.22485	-1.5	-5.999545	0	
135	N135B	-1.22485	5.5	-5.999545	0	
136	N136A	-3.516516	-1.5	-2.030262	0	
137	N137A	-3.516516	4.5	-2.030262	0	
138	N138A	-5.891516	-1.5	2.083359	0	
139	N139A	-5.891516	4.5	2.083359	0	
140	N140A	6.25	3	3.810523	0	
141	N141A	-6.25	3	3.810523	0	
142	N142A	4.75	3	3.810523	0	
143	N143	4.75	3	4.060523	0	
144	N144A	-4.583333	3	3.810523	0	
145	N145	-4.583333	3	4.060523	0	
146	N146	-0.	3	3.810523	0	
147	N147	-0.	3	4.060523	0	
148	N148A	-2.583333	3	3.810523	0	
149	N149	-2.583333	3	4.060523	0	
150	N150	0.17501	3	-7.31792	0	
151	N151	6.42501	3	3.507397	0	
152	N152	-6.42501	3	3.507397	0	
153	N153	-0.17501	3	-7.31792	0	
154	N154	0.92501	3	-6.018882	0	
155	N155	1.141516	3	-6.143882	0	
156	N156	5.591677	3	2.064021	0	
157	N157	5.808183	3	1.939021	0	
158	N158	3.30001	3	-1.905262	0	
159	N159	3.516516	3	-2.030262	0	
160	N160	4.591677	3	0.331971	0	
161	N161	4.808183	3	0.206971	0	
162	N162	-5.67501	3	2.208359	0	



Company :
 Designer :
 Job Number :
 Model Name :

July 6, 2023
 1:03 PM
 Checked By: _____

Joint Coordinates and Temperatures (Continued)

	Label	X [ft]	Y [ft]	Z [ft]	Temp [F]	Detach From Diap...
163	N163	-5.891516	3	2.083359	0	
164	N164	-1.008343	3	-5.874545	0	
165	N165	-1.22485	3	-5.999545	0	
166	N166	-3.30001	3	-1.905262	0	
167	N167	-3.516516	3	-2.030262	0	
168	N168	-2.008343	3	-4.142494	0	
169	N169	-2.22485	3	-4.267494	0	
170	N170	-4	3	3.810523	0	
171	N171	-4	3	3.6	0	
172	N172	4	3	3.810523	0	
173	N173	4	3	3.6	0	
174	N174	5.30001	3	1.55884	0	
175	N175	5.117691	3	1.664102	0	
176	N176	1.30001	3	-5.369363	0	
177	N177	1.117691	3	-5.264102	0	
178	N178	-1.30001	3	-5.369363	0	
179	N179	-1.117691	3	-5.264102	0	
180	N180	-5.30001	3	1.55884	0	
181	N181	-5.117691	3	1.664102	0	

Hot Rolled Steel Section Sets

	Label	Shape	Type	Design List	Material	Design R...	A [in2]	Iyy [in4]	Izz [in4]	J [in4]
1	Face Horizontal	PIPE 3.0	Beam	Pipe	A53 Gr.B	Typical	2.07	2.85	2.85	5.69
2	Standoff Horizontal	HSS4X4X4	Beam	SquareTube	A500 Gr.B Rect	Typical	3.37	7.8	7.8	12.8
3	Corner Plate	PL1/2x6	Beam	BAR	A36 Gr.36	Typical	3	.063	9	.237
4	Platform Crossmem...	HSS4X4X4	Beam	SquareTube	A500 Gr.B Rect	Typical	3.37	7.8	7.8	12.8
5	Grating Support	L2x2x3	Beam	Single Angle	A36 Gr.36	Typical	.722	.271	.271	.009
6	Mount Pipe	PIPE 2.0	Column	Pipe	A53 Gr.B	Typical	1.02	.627	.627	1.25
7	Cross Arm Plate	PL3/8x6	Column	RECT	A36 Gr.36	Typical	2.25	.026	6.75	.101
8	Support Rail	PIPE 2.5	Beam	Pipe	A53 Gr.B	Typical	1.61	1.45	1.45	2.89
9	Support Rail Corner	L3X3X4	Column	RECT	A36 Gr.36	Typical	1.44	1.23	1.23	.031
10	Replacement Pipe	PIPE 2.5	Column	Pipe	A53 Gr.B	Typical	1.61	1.45	1.45	2.89

Hot Rolled Steel Properties

	Label	E [ksi]	G [ksi]	Nu	Therm (/1E...Density[k/ft...	Yield[ksi]	Ry	Fu[ksi]	Rt	
1	A992	29000	11154	.3	.65	.49	50	1.1	65	1.1
2	A36 Gr.36	29000	11154	.3	.65	.49	36	1.5	58	1.2
3	A572 Gr.50	29000	11154	.3	.65	.49	50	1.1	65	1.1
4	A500 Gr.B RND	29000	11154	.3	.65	.527	42	1.4	58	1.3
5	A500 Gr.B Rect	29000	11154	.3	.65	.527	46	1.4	58	1.3
6	A53 Gr.B	29000	11154	.3	.65	.49	35	1.6	60	1.2
7	A1085	29000	11154	.3	.65	.49	50	1.4	65	1.3
8	Q235	29000	11154	.3	.65	.49	35	1.5	58	1.2

Member Primary Data

	Label	I Joint	J Joint	K Joint	Rotate(deg)	Section/Shape	Type	Design List	Material	Design Rules
1	M1	N1	N2			Face Horizontal	Beam	Pipe	A53 Gr.B	Typical
2	M4	N3	N27			Standoff Horiz...	Beam	SquareTube	A500 Gr.B...	Typical
3	M10	N101	N103A			Platform Cross...	Beam	SquareTube	A500 Gr.B...	Typical
4	M19	N8	N9			RIGID	None	None	RIGID	Typical
5	M20	N10	N11			RIGID	None	None	RIGID	Typical
6	M21	N12	N13			RIGID	None	None	RIGID	Typical

Member Primary Data (Continued)

	Label	I Joint	J Joint	K Joint	Rotate(deg)	Section/Shape	Type	Design List	Material	Design Rules
7	M22	N14	N15			RIGID	None	None	RIGID	Typical
8	MP3A	N17	N16			Mount Pipe	Column	Pipe	A53 Gr.B	Typical
9	MP4A	N19	N18			Replacement ...	Column	Pipe	A53 Gr.B	Typical
10	MP2A	N21	N20			Mount Pipe	Column	Pipe	A53 Gr.B	Typical
11	MP1A	N23	N22			Mount Pipe	Column	Pipe	A53 Gr.B	Typical
12	M43	N102	N5			Platform Cross...	Beam	SquareTube	A500 Gr.B...	Typical
13	M46	N86C	N87A			Corner Plate	Beam	BAR	A36 Gr.36	Typical
14	M35A	N7	N30			RIGID	None	None	RIGID	Typical
15	M36A	N6	N29			RIGID	None	None	RIGID	Typical
16	M51B	N87C	N6			Grating Support	Beam	Single Angle	A36 Gr.36	Typical
17	M52B	N7	N87B			Grating Support	Beam	Single Angle	A36 Gr.36	Typical
18	M52	N87B	N88C			RIGID	None	None	RIGID	Typical
19	M58	N102	N24			RIGID	None	None	RIGID	Typical
20	M59	N24	N103A			RIGID	None	None	RIGID	Typical
21	M76	N101	N105			Cross Arm Plate	Column	RECT	A36 Gr.36	Typical
22	M77	N105	N131			Cross Arm Plate	Column	RECT	A36 Gr.36	Typical
23	M79	N131	N86A			RIGID	None	None	RIGID	Typical
24	M80	N87A	N135			Corner Plate	Beam	BAR	A36 Gr.36	Typical
25	M83	N135	N86D			RIGID	None	None	RIGID	Typical
26	M84	N5	N104A			Cross Arm Plate	Column	RECT	A36 Gr.36	Typical
27	M85	N104A	N144			Cross Arm Plate	Column	RECT	A36 Gr.36	Typical
28	M88	N144	N86B			RIGID	None	None	RIGID	Typical
29	M91	N86C	N148			Corner Plate	Beam	BAR	A36 Gr.36	Typical
30	M92	N148	N86E			RIGID	None	None	RIGID	Typical
31	M50	N88C	N88A			RIGID	None	None	RIGID	Typical
32	M51	N88A	N86G			RIGID	None	None	RIGID	Typical
33	M51A	N87C	N86G			RIGID	None	None	RIGID	Typical
34	M52A	N87D	N92			Standoff Horiz...	Beam	SquareTube	A500 Gr.B...	Typical
35	M53	N95	N97			Platform Cross...	Beam	SquareTube	A500 Gr.B...	Typical
36	M54	N96	N88B			Platform Cross...	Beam	SquareTube	A500 Gr.B...	Typical
37	M55	N106	N107			Corner Plate	Beam	BAR	A36 Gr.36	Typical
38	M56	N90	N94			RIGID	None	None	RIGID	Typical
39	M57	N89	N93			RIGID	None	None	RIGID	Typical
40	M58A	N111	N89			Grating Support	Beam	Single Angle	A36 Gr.36	Typical
41	M59A	N90	N113			Grating Support	Beam	Single Angle	A36 Gr.36	Typical
42	M60	N113	N114			RIGID	None	None	RIGID	Typical
43	M61	N96	N91			RIGID	None	None	RIGID	Typical
44	M62	N91	N97			RIGID	None	None	RIGID	Typical
45	M63	N95	N99			Cross Arm Plate	Column	RECT	A36 Gr.36	Typical
46	M64	N99	N100			Cross Arm Plate	Column	RECT	A36 Gr.36	Typical
47	M65	N100	N104			RIGID	None	None	RIGID	Typical
48	M66	N107	N101A			Corner Plate	Beam	BAR	A36 Gr.36	Typical
49	M67	N101A	N108			RIGID	None	None	RIGID	Typical
50	M68	N88B	N98			Cross Arm Plate	Column	RECT	A36 Gr.36	Typical
51	M69	N98	N102A			Cross Arm Plate	Column	RECT	A36 Gr.36	Typical
52	M70	N102A	N105A			RIGID	None	None	RIGID	Typical
53	M71	N106	N103			Corner Plate	Beam	BAR	A36 Gr.36	Typical
54	M72	N103	N109			RIGID	None	None	RIGID	Typical
55	M73	N114	N110			RIGID	None	None	RIGID	Typical
56	M74	N110	N112			RIGID	None	None	RIGID	Typical
57	M75	N111	N112			RIGID	None	None	RIGID	Typical
58	M76A	N115	N120			Standoff Horiz...	Beam	SquareTube	A500 Gr.B...	Typical
59	M77A	N123	N125			Platform Cross...	Beam	SquareTube	A500 Gr.B...	Typical
60	M78	N124	N116			Platform Cross...	Beam	SquareTube	A500 Gr.B...	Typical
61	M79A	N134	N135A			Corner Plate	Beam	BAR	A36 Gr.36	Typical
62	M80A	N118	N122			RIGID	None	None	RIGID	Typical
63	M81	N117	N121			RIGID	None	None	RIGID	Typical

Member Primary Data (Continued)

	Label	I Joint	J Joint	K Joint	Rotate(deg)	Section/Shape	Type	Design List	Material	Design Rules
64	M82	N139	N117			Grating Support	Beam	Single Angle	A36 Gr.36	Typical
65	M83A	N118	N141			Grating Support	Beam	Single Angle	A36 Gr.36	Typical
66	M84A	N141	N142			RIGID	None	None	RIGID	Typical
67	M85A	N124	N119			RIGID	None	None	RIGID	Typical
68	M86	N119	N125			RIGID	None	None	RIGID	Typical
69	M87	N123	N127			Cross Arm Plate	Column	RECT	A36 Gr.36	Typical
70	M88A	N127	N128			Cross Arm Plate	Column	RECT	A36 Gr.36	Typical
71	M89	N128	N132			RIGID	None	None	RIGID	Typical
72	M90	N135A	N129			Corner Plate	Beam	BAR	A36 Gr.36	Typical
73	M91A	N129	N136			RIGID	None	None	RIGID	Typical
74	M92A	N116	N126			Cross Arm Plate	Column	RECT	A36 Gr.36	Typical
75	M93	N126	N130			Cross Arm Plate	Column	RECT	A36 Gr.36	Typical
76	M94	N130	N133			RIGID	None	None	RIGID	Typical
77	M95	N134	N131A			Corner Plate	Beam	BAR	A36 Gr.36	Typical
78	M96	N131A	N137			RIGID	None	None	RIGID	Typical
79	M97	N142	N138			RIGID	None	None	RIGID	Typical
80	M98	N138	N140			RIGID	None	None	RIGID	Typical
81	M99	N139	N140			RIGID	None	None	RIGID	Typical
82	M82A	N104B	N105B			Face Horizontal	Beam	Pipe	A53 Gr.B	Typical
83	M91B	N124A	N125A			Face Horizontal	Beam	Pipe	A53 Gr.B	Typical
84	M84B	N108A	N109A			RIGID	None	None	RIGID	Typical
85	M85B	N110A	N111A			RIGID	None	None	RIGID	Typical
86	M86A	N112A	N113A			RIGID	None	None	RIGID	Typical
87	M87A	N114A	N115A			RIGID	None	None	RIGID	Typical
88	MP3C	N117A	N116A			Mount Pipe	Column	Pipe	A53 Gr.B	Typical
89	MP4C	N119A	N118A			Replacement ...	Column	Pipe	A53 Gr.B	Typical
90	MP2C	N121A	N120A			Mount Pipe	Column	Pipe	A53 Gr.B	Typical
91	MP1C	N123A	N122A			Mount Pipe	Column	Pipe	A53 Gr.B	Typical
92	M92B	N124B	N125B			RIGID	None	None	RIGID	Typical
93	M93A	N126A	N127A			RIGID	None	None	RIGID	Typical
94	M94A	N128A	N129A			RIGID	None	None	RIGID	Typical
95	M95A	N130A	N131B			RIGID	None	None	RIGID	Typical
96	MP3B	N133A	N132A			Mount Pipe	Column	Pipe	A53 Gr.B	Typical
97	MP4B	N135B	N134A			Replacement ...	Column	Pipe	A53 Gr.B	Typical
98	MP2B	N137A	N136A			Mount Pipe	Column	Pipe	A53 Gr.B	Typical
99	MP1B	N139A	N138A			Mount Pipe	Column	Pipe	A53 Gr.B	Typical
100	M100	N140A	N141A			Support Rail	Beam	Pipe	A53 Gr.B	Typical
101	M101	N142A	N143			RIGID	None	None	RIGID	Typical
102	M102	N144A	N145			RIGID	None	None	RIGID	Typical
103	M103	N146	N147			RIGID	None	None	RIGID	Typical
104	M104	N148A	N149			RIGID	None	None	RIGID	Typical
105	M105	N150	N151			Support Rail	Beam	Pipe	A53 Gr.B	Typical
106	M106	N152	N153			Support Rail	Beam	Pipe	A53 Gr.B	Typical
107	M107	N154	N155			RIGID	None	None	RIGID	Typical
108	M108	N156	N157			RIGID	None	None	RIGID	Typical
109	M109	N158	N159			RIGID	None	None	RIGID	Typical
110	M110	N160	N161			RIGID	None	None	RIGID	Typical
111	M111	N162	N163			RIGID	None	None	RIGID	Typical
112	M112	N164	N165			RIGID	None	None	RIGID	Typical
113	M113	N166	N167			RIGID	None	None	RIGID	Typical
114	M114	N168	N169			RIGID	None	None	RIGID	Typical
115	M115	N170	N171			RIGID	None	None	RIGID	Typical
116	M116	N172	N173			RIGID	None	None	RIGID	Typical
117	M117	N174	N175			RIGID	None	None	RIGID	Typical
118	M118	N176	N177			RIGID	None	None	RIGID	Typical
119	M119	N178	N179			RIGID	None	None	RIGID	Typical
120	M120	N180	N181			RIGID	None	None	RIGID	Typical

Member Primary Data (Continued)

	Label	I Joint	J Joint	K Joint	Rotate(deg)	Section/Shape	Type	Design List	Material	Design Rules
121	M121	N171	N181		90	Support Rail C...	Column	RECT	A36 Gr.36	Typical
122	M122	N179	N177		90	Support Rail C...	Column	RECT	A36 Gr.36	Typical
123	M123	N175	N173		90	Support Rail C...	Column	RECT	A36 Gr.36	Typical

Member Advanced Data

	Label	I Release	J Release	I Offset[in]	J Offset[in]	T/C Only	Physical	Defl Rat...	Analysis ...	Inactive	Seismic...
1	M1						Yes	Default			None
2	M4						Yes				None
3	M10						Yes	Default			None
4	M19						Yes	** NA **			None
5	M20						Yes	** NA **			None
6	M21						Yes	** NA **			None
7	M22						Yes	** NA **			None
8	MP3A						Yes	** NA **			None
9	MP4A						Yes	** NA **			None
10	MP2A						Yes	** NA **			None
11	MP1A						Yes	** NA **			None
12	M43						Yes	Default			None
13	M46						Yes	Default			None
14	M35A						Yes	** NA **			None
15	M36A						Yes	** NA **			None
16	M51B	OOOOOX	OOOOOX				Yes	Default			None
17	M52B	OOOOOX	OOOOOX				Yes	Default			None
18	M52						Yes	** NA **			None
19	M58						Yes	** NA **			None
20	M59						Yes	** NA **			None
21	M76						Yes	** NA **			None
22	M77						Yes	** NA **			None
23	M79		BenPIN				Yes	** NA **			None
24	M80						Yes				None
25	M83		BenPIN				Yes	** NA **			None
26	M84						Yes	** NA **			None
27	M85						Yes	** NA **			None
28	M88		BenPIN				Yes	** NA **			None
29	M91						Yes				None
30	M92		BenPIN				Yes	** NA **			None
31	M50						Yes	** NA **			None
32	M51						Yes	** NA **			None
33	M51A						Yes	** NA **			None
34	M52A						Yes				None
35	M53						Yes	Default			None
36	M54						Yes	Default			None
37	M55						Yes	Default			None
38	M56						Yes	** NA **			None
39	M57						Yes	** NA **			None
40	M58A	OOOOOX	OOOOOX				Yes	Default			None
41	M59A	OOOOOX	OOOOOX				Yes	Default			None
42	M60						Yes	** NA **			None
43	M61						Yes	** NA **			None
44	M62						Yes	** NA **			None
45	M63						Yes	** NA **			None
46	M64						Yes	** NA **			None
47	M65		BenPIN				Yes	** NA **			None
48	M66						Yes				None
49	M67		BenPIN				Yes	** NA **			None



Company :
 Designer :
 Job Number :
 Model Name :

July 6, 2023
 1:03 PM
 Checked By: _____

Member Advanced Data (Continued)

	Label	I Release	J Release	I Offset[in]	J Offset[in]	T/C Only	Physical	Defl Rat...	Analysis ...	Inactive	Seismic...
50	M68						Yes	** NA **			None
51	M69						Yes	** NA **			None
52	M70		BenPIN				Yes	** NA **			None
53	M71						Yes				None
54	M72		BenPIN				Yes	** NA **			None
55	M73						Yes	** NA **			None
56	M74						Yes	** NA **			None
57	M75						Yes	** NA **			None
58	M76A						Yes				None
59	M77A						Yes	Default			None
60	M78						Yes	Default			None
61	M79A						Yes	Default			None
62	M80A						Yes	** NA **			None
63	M81						Yes	** NA **			None
64	M82	OOOOOX	OOOOOX				Yes	Default			None
65	M83A	OOOOOX	OOOOOX				Yes	Default			None
66	M84A						Yes	** NA **			None
67	M85A						Yes	** NA **			None
68	M86						Yes	** NA **			None
69	M87						Yes	** NA **			None
70	M88A						Yes	** NA **			None
71	M89		BenPIN				Yes	** NA **			None
72	M90						Yes				None
73	M91A		BenPIN				Yes	** NA **			None
74	M92A						Yes	** NA **			None
75	M93						Yes	** NA **			None
76	M94		BenPIN				Yes	** NA **			None
77	M95						Yes				None
78	M96		BenPIN				Yes	** NA **			None
79	M97						Yes	** NA **			None
80	M98						Yes	** NA **			None
81	M99						Yes	** NA **			None
82	M82A						Yes	Default			None
83	M91B						Yes	Default			None
84	M84B						Yes	** NA **			None
85	M85B						Yes	** NA **			None
86	M86A						Yes	** NA **			None
87	M87A						Yes	** NA **			None
88	MP3C						Yes	** NA **			None
89	MP4C						Yes	** NA **			None
90	MP2C						Yes	** NA **			None
91	MP1C						Yes	** NA **			None
92	M92B						Yes	** NA **			None
93	M93A						Yes	** NA **			None
94	M94A						Yes	** NA **			None
95	M95A						Yes	** NA **			None
96	MP3B						Yes	** NA **			None
97	MP4B						Yes	** NA **			None
98	MP2B						Yes	** NA **			None
99	MP1B						Yes	** NA **			None
100	M100						Yes	Default			None
101	M101						Yes	** NA **			None
102	M102						Yes	** NA **			None
103	M103						Yes	** NA **			None
104	M104						Yes	** NA **			None
105	M105						Yes	Default			None
106	M106						Yes	Default			None

Member Advanced Data (Continued)

	Label	I Release	J Release	I Offset[in]	J Offset[in]	T/C Only	Physical	Defl Rat...	Analysis ...	Inactive	Seismic...
107	M107						Yes	** NA **			None
108	M108						Yes	** NA **			None
109	M109						Yes	** NA **			None
110	M110						Yes	** NA **			None
111	M111						Yes	** NA **			None
112	M112						Yes	** NA **			None
113	M113						Yes	** NA **			None
114	M114						Yes	** NA **			None
115	M115	OOOOOX					Yes	** NA **			None
116	M116	OOOOOX					Yes	** NA **			None
117	M117	OOOOOX					Yes	** NA **			None
118	M118	OOOOOX					Yes	** NA **			None
119	M119	OOOOOX					Yes	** NA **			None
120	M120	OOOOOX					Yes	** NA **			None
121	M121						Yes	** NA **			None
122	M122						Yes	** NA **			None
123	M123						Yes	** NA **			None

Member Point Loads (BLC 1 : Antenna D)

	Member Label	Direction	Magnitude[lb.k-ft]	Location[ft.%]
1	MP3A	Y	-17.6	.5
2	MP3A	My	.009	.5
3	MP3A	Mz	0	.5
4	MP3B	Y	-17.6	.5
5	MP3B	My	-.007	.5
6	MP3B	Mz	.005	.5
7	MP3C	Y	-17.6	.5
8	MP3C	My	-.003	.5
9	MP3C	Mz	-.008	.5
10	MP1A	Y	-20.4	.75
11	MP1A	My	-.01	.75
12	MP1A	Mz	0	.75
13	MP1A	Y	-20.4	5
14	MP1A	My	-.01	5
15	MP1A	Mz	0	5
16	MP1B	Y	-20.4	.75
17	MP1B	My	.008	.75
18	MP1B	Mz	-.006	.75
19	MP1B	Y	-20.4	5
20	MP1B	My	.008	5
21	MP1B	Mz	-.006	5
22	MP1C	Y	-20.4	.75
23	MP1C	My	.003	.75
24	MP1C	Mz	.01	.75
25	MP1C	Y	-20.4	5
26	MP1C	My	.003	5
27	MP1C	Mz	.01	5
28	MP4A	Y	-23	.5
29	MP4A	My	-.011	.5
30	MP4A	Mz	.023	.5
31	MP4A	Y	-23	5.5
32	MP4A	My	-.011	5.5
33	MP4A	Mz	.023	5.5
34	MP4B	Y	-23	.5
35	MP4B	My	-.004	.5



Company :
 Designer :
 Job Number :
 Model Name :

July 6, 2023
 1:03 PM
 Checked By: _____

Member Point Loads (BLC 1 : Antenna D) (Continued)

Member Label	Direction	Magnitude[lb.k-ft]	Location[ft.%]	
36	MP4B	Mz	-0.25	.5
37	MP4B	Y	-23	5.5
38	MP4B	My	-.004	5.5
39	MP4B	Mz	-.025	5.5
40	MP4C	Y	-23	.5
41	MP4C	My	.026	.5
42	MP4C	Mz	.003	.5
43	MP4C	Y	-23	5.5
44	MP4C	My	.026	5.5
45	MP4C	Mz	.003	5.5
46	MP4A	Y	-23	.5
47	MP4A	My	-.011	.5
48	MP4A	Mz	-.023	.5
49	MP4A	Y	-23	5.5
50	MP4A	My	-.011	5.5
51	MP4A	Mz	-.023	5.5
52	MP4B	Y	-23	.5
53	MP4B	My	.023	.5
54	MP4B	Mz	.012	.5
55	MP4B	Y	-23	5.5
56	MP4B	My	.023	5.5
57	MP4B	Mz	.012	5.5
58	MP4C	Y	-23	.5
59	MP4C	My	-.018	.5
60	MP4C	Mz	.019	.5
61	MP4C	Y	-23	5.5
62	MP4C	My	-.018	5.5
63	MP4C	Mz	.019	5.5
64	MP2A	Y	-43.55	1.88
65	MP2A	My	-.022	1.88
66	MP2A	Mz	0	1.88
67	MP2A	Y	-43.55	3.88
68	MP2A	My	-.022	3.88
69	MP2A	Mz	0	3.88
70	MP2B	Y	-43.55	1.88
71	MP2B	My	.018	1.88
72	MP2B	Mz	-.012	1.88
73	MP2B	Y	-43.55	3.88
74	MP2B	My	.018	3.88
75	MP2B	Mz	-.012	3.88
76	MP2C	Y	-43.55	1.88
77	MP2C	My	.007	1.88
78	MP2C	Mz	.02	1.88
79	MP2C	Y	-43.55	3.88
80	MP2C	My	.007	3.88
81	MP2C	Mz	.02	3.88
82	MP3A	Y	-74.7	2
83	MP3A	My	.025	2
84	MP3A	Mz	0	2
85	MP3B	Y	-74.7	2
86	MP3B	My	-.012	2
87	MP3B	Mz	.022	2
88	MP3C	Y	-74.7	2
89	MP3C	My	-.012	2
90	MP3C	Mz	-.022	2
91	MP4A	Y	-70.3	2
92	MP4A	My	.023	2

Member Point Loads (BLC 1 : Antenna D) (Continued)

	Member Label	Direction	Magnitude[lb.k-ft]	Location[ft.%]
93	MP4A	Mz	0	2
94	MP4B	Y	-70.3	2
95	MP4B	My	-.012	2
96	MP4B	Mz	.02	2
97	MP4C	Y	-70.3	2
98	MP4C	My	-.012	2
99	MP4C	Mz	-.02	2

Member Point Loads (BLC 2 : Antenna Di)

	Member Label	Direction	Magnitude[lb.k-ft]	Location[ft.%]
1	MP3A	Y	-16.871	.5
2	MP3A	My	.008	.5
3	MP3A	Mz	0	.5
4	MP3B	Y	-16.871	.5
5	MP3B	My	-.007	.5
6	MP3B	Mz	.005	.5
7	MP3C	Y	-16.871	.5
8	MP3C	My	-.003	.5
9	MP3C	Mz	-.008	.5
10	MP1A	Y	-59.648	.75
11	MP1A	My	-.03	.75
12	MP1A	Mz	0	.75
13	MP1A	Y	-59.648	5
14	MP1A	My	-.03	5
15	MP1A	Mz	0	5
16	MP1B	Y	-59.648	.75
17	MP1B	My	.024	.75
18	MP1B	Mz	-.017	.75
19	MP1B	Y	-59.648	5
20	MP1B	My	.024	5
21	MP1B	Mz	-.017	5
22	MP1C	Y	-59.648	.75
23	MP1C	My	.01	.75
24	MP1C	Mz	.028	.75
25	MP1C	Y	-59.648	5
26	MP1C	My	.01	5
27	MP1C	Mz	.028	5
28	MP4A	Y	-80.453	.5
29	MP4A	My	-.04	.5
30	MP4A	Mz	.08	.5
31	MP4A	Y	-80.453	5.5
32	MP4A	My	-.04	5.5
33	MP4A	Mz	.08	5.5
34	MP4B	Y	-80.453	.5
35	MP4B	My	-.013	.5
36	MP4B	Mz	-.089	.5
37	MP4B	Y	-80.453	5.5
38	MP4B	My	-.013	5.5
39	MP4B	Mz	-.089	5.5
40	MP4C	Y	-80.453	.5
41	MP4C	My	.089	.5
42	MP4C	Mz	.01	.5
43	MP4C	Y	-80.453	5.5
44	MP4C	My	.089	5.5
45	MP4C	Mz	.01	5.5
46	MP4A	Y	-80.453	.5



Company :
 Designer :
 Job Number :
 Model Name :

July 6, 2023
 1:03 PM
 Checked By: _____

Member Point Loads (BLC 2 : Antenna Di) (Continued)

	Member Label	Direction	Magnitude[lb.k-ft]	Location[ft. %]
47	MP4A	My	-.04	.5
48	MP4A	Mz	-.08	.5
49	MP4A	Y	-80.453	5.5
50	MP4A	My	-.04	5.5
51	MP4A	Mz	-.08	5.5
52	MP4B	Y	-80.453	.5
53	MP4B	My	.079	.5
54	MP4B	Mz	.043	.5
55	MP4B	Y	-80.453	5.5
56	MP4B	My	.079	5.5
57	MP4B	Mz	.043	5.5
58	MP4C	Y	-80.453	.5
59	MP4C	My	-.062	.5
60	MP4C	Mz	.065	.5
61	MP4C	Y	-80.453	5.5
62	MP4C	My	-.062	5.5
63	MP4C	Mz	.065	5.5
64	MP2A	Y	-34.72	1.88
65	MP2A	My	-.017	1.88
66	MP2A	Mz	0	1.88
67	MP2A	Y	-34.72	3.88
68	MP2A	My	-.017	3.88
69	MP2A	Mz	0	3.88
70	MP2B	Y	-34.72	1.88
71	MP2B	My	.014	1.88
72	MP2B	Mz	-.01	1.88
73	MP2B	Y	-34.72	3.88
74	MP2B	My	.014	3.88
75	MP2B	Mz	-.01	3.88
76	MP2C	Y	-34.72	1.88
77	MP2C	My	.006	1.88
78	MP2C	Mz	.016	1.88
79	MP2C	Y	-34.72	3.88
80	MP2C	My	.006	3.88
81	MP2C	Mz	.016	3.88
82	MP3A	Y	-43.757	2
83	MP3A	My	.015	2
84	MP3A	Mz	0	2
85	MP3B	Y	-43.757	2
86	MP3B	My	-.007	2
87	MP3B	Mz	.013	2
88	MP3C	Y	-43.757	2
89	MP3C	My	-.007	2
90	MP3C	Mz	-.013	2
91	MP4A	Y	-41.667	2
92	MP4A	My	.014	2
93	MP4A	Mz	0	2
94	MP4B	Y	-41.667	2
95	MP4B	My	-.007	2
96	MP4B	Mz	.012	2
97	MP4C	Y	-41.667	2
98	MP4C	My	-.007	2
99	MP4C	Mz	-.012	2

Member Point Loads (BLC 3 : Antenna Wo (0 Deg))

	Member Label	Direction	Magnitude[lb.k-ft]	Location[ft. %]
--	--------------	-----------	--------------------	-----------------



Company :
 Designer :
 Job Number :
 Model Name :

July 6, 2023
 1:03 PM
 Checked By: _____

Member Point Loads (BLC 3 : Antenna Wo (0 Deg)) (Continued)

	Member Label	Direction	Magnitude[lb.k-ft]	Location[ft.%]
1	MP3A	X	0	.5
2	MP3A	Z	-33.279	.5
3	MP3A	Mx	0	.5
4	MP3B	X	0	.5
5	MP3B	Z	-25.651	.5
6	MP3B	Mx	-.007	.5
7	MP3C	X	0	.5
8	MP3C	Z	-12.806	.5
9	MP3C	Mx	.006	.5
10	MP1A	X	0	.75
11	MP1A	Z	-148.195	.75
12	MP1A	Mx	0	.75
13	MP1A	X	0	5
14	MP1A	Z	-148.195	5
15	MP1A	Mx	0	5
16	MP1B	X	0	.75
17	MP1B	Z	-129.338	.75
18	MP1B	Mx	.037	.75
19	MP1B	X	0	5
20	MP1B	Z	-129.338	5
21	MP1B	Mx	.037	5
22	MP1C	X	0	.75
23	MP1C	Z	-97.581	.75
24	MP1C	Mx	-.046	.75
25	MP1C	X	0	5
26	MP1C	Z	-97.581	5
27	MP1C	Mx	-.046	5
28	MP4A	X	0	.5
29	MP4A	Z	-81.984	.5
30	MP4A	Mx	-.082	.5
31	MP4A	X	0	5.5
32	MP4A	Z	-81.984	5.5
33	MP4A	Mx	-.082	5.5
34	MP4B	X	0	.5
35	MP4B	Z	-75.198	.5
36	MP4B	Mx	.083	.5
37	MP4B	X	0	5.5
38	MP4B	Z	-75.198	5.5
39	MP4B	Mx	.083	5.5
40	MP4C	X	0	.5
41	MP4C	Z	-63.771	.5
42	MP4C	Mx	-.008	.5
43	MP4C	X	0	5.5
44	MP4C	Z	-63.771	5.5
45	MP4C	Mx	-.008	5.5
46	MP4A	X	0	.5
47	MP4A	Z	-81.984	.5
48	MP4A	Mx	.082	.5
49	MP4A	X	0	5.5
50	MP4A	Z	-81.984	5.5
51	MP4A	Mx	.082	5.5
52	MP4B	X	0	.5
53	MP4B	Z	-75.198	.5
54	MP4B	Mx	-.04	.5
55	MP4B	X	0	5.5
56	MP4B	Z	-75.198	5.5
57	MP4B	Mx	-.04	5.5



Company :
 Designer :
 Job Number :
 Model Name :

July 6, 2023
 1:03 PM
 Checked By: _____

Member Point Loads (BLC 3 : Antenna Wo (0 Deg)) (Continued)

	Member Label	Direction	Magnitude[lb.k-ft]	Location[ft.%]
58	MP4C	X	0	.5
59	MP4C	Z	-63.771	.5
60	MP4C	Mx	-.052	.5
61	MP4C	X	0	5.5
62	MP4C	Z	-63.771	5.5
63	MP4C	Mx	-.052	5.5
64	MP2A	X	0	1.88
65	MP2A	Z	-67.945	1.88
66	MP2A	Mx	0	1.88
67	MP2A	X	0	3.88
68	MP2A	Z	-67.945	3.88
69	MP2A	Mx	0	3.88
70	MP2B	X	0	1.88
71	MP2B	Z	-53.29	1.88
72	MP2B	Mx	.015	1.88
73	MP2B	X	0	3.88
74	MP2B	Z	-53.29	3.88
75	MP2B	Mx	.015	3.88
76	MP2C	X	0	1.88
77	MP2C	Z	-28.61	1.88
78	MP2C	Mx	-.013	1.88
79	MP2C	X	0	3.88
80	MP2C	Z	-28.61	3.88
81	MP2C	Mx	-.013	3.88
82	MP3A	X	0	2
83	MP3A	Z	-53.732	2
84	MP3A	Mx	0	2
85	MP3B	X	0	2
86	MP3B	Z	-40.472	2
87	MP3B	Mx	-.012	2
88	MP3C	X	0	2
89	MP3C	Z	-40.472	2
90	MP3C	Mx	.012	2
91	MP4A	X	0	2
92	MP4A	Z	-53.732	2
93	MP4A	Mx	0	2
94	MP4B	X	0	2
95	MP4B	Z	-37.872	2
96	MP4B	Mx	-.011	2
97	MP4C	X	0	2
98	MP4C	Z	-37.872	2
99	MP4C	Mx	.011	2

Member Point Loads (BLC 4 : Antenna Wo (30 Deg))

	Member Label	Direction	Magnitude[lb.k-ft]	Location[ft.%]
1	MP3A	X	13.741	.5
2	MP3A	Z	-23.801	.5
3	MP3A	Mx	.007	.5
4	MP3B	X	7.117	.5
5	MP3B	Z	-12.328	.5
6	MP3B	Mx	-.006	.5
7	MP3C	X	11.85	.5
8	MP3C	Z	-20.524	.5
9	MP3C	Mx	.008	.5
10	MP1A	X	66.933	.75
11	MP1A	Z	-115.931	.75



Company :
 Designer :
 Job Number :
 Model Name :

July 6, 2023
 1:03 PM
 Checked By: _____

Member Point Loads (BLC 4 : Antenna Wo (30 Deg)) (Continued)

	Member Label	Direction	Magnitude[lb.k-ft]	Location[ft.%]
12	MP1A	Mx	-.033	.75
13	MP1A	X	66.933	5
14	MP1A	Z	-115.931	5
15	MP1A	Mx	-.033	5
16	MP1B	X	50.557	.75
17	MP1B	Z	-87.567	.75
18	MP1B	Mx	.046	.75
19	MP1B	X	50.557	5
20	MP1B	Z	-87.567	5
21	MP1B	Mx	.046	5
22	MP1C	X	62.256	.75
23	MP1C	Z	-107.831	.75
24	MP1C	Mx	-.04	.75
25	MP1C	X	62.256	5
26	MP1C	Z	-107.831	5
27	MP1C	Mx	-.04	5
28	MP4A	X	38.414	.5
29	MP4A	Z	-66.535	.5
30	MP4A	Mx	-.086	.5
31	MP4A	X	38.414	5.5
32	MP4A	Z	-66.535	5.5
33	MP4A	Mx	-.086	5.5
34	MP4B	X	32.521	.5
35	MP4B	Z	-56.328	.5
36	MP4B	Mx	.057	.5
37	MP4B	X	32.521	5.5
38	MP4B	Z	-56.328	5.5
39	MP4B	Mx	.057	5.5
40	MP4C	X	36.731	.5
41	MP4C	Z	-63.62	.5
42	MP4C	Mx	.033	.5
43	MP4C	X	36.731	5.5
44	MP4C	Z	-63.62	5.5
45	MP4C	Mx	.033	5.5
46	MP4A	X	38.414	.5
47	MP4A	Z	-66.535	.5
48	MP4A	Mx	.047	.5
49	MP4A	X	38.414	5.5
50	MP4A	Z	-66.535	5.5
51	MP4A	Mx	.047	5.5
52	MP4B	X	32.521	.5
53	MP4B	Z	-56.328	.5
54	MP4B	Mx	.002	.5
55	MP4B	X	32.521	5.5
56	MP4B	Z	-56.328	5.5
57	MP4B	Mx	.002	5.5
58	MP4C	X	36.731	.5
59	MP4C	Z	-63.62	.5
60	MP4C	Mx	-.08	.5
61	MP4C	X	36.731	5.5
62	MP4C	Z	-63.62	5.5
63	MP4C	Mx	-.08	5.5
64	MP2A	X	28.404	1.88
65	MP2A	Z	-49.197	1.88
66	MP2A	Mx	-.014	1.88
67	MP2A	X	28.404	3.88
68	MP2A	Z	-49.197	3.88

Member Point Loads (BLC 4 : Antenna Wo (30 Deg)) (Continued)

	Member Label	Direction	Magnitude[lb.k-ft]	Location[ft.%]
69	MP2A	Mx	-.014	3.88
70	MP2B	X	15.678	1.88
71	MP2B	Z	-27.155	1.88
72	MP2B	Mx	.014	1.88
73	MP2B	X	15.678	3.88
74	MP2B	Z	-27.155	3.88
75	MP2B	Mx	.014	3.88
76	MP2C	X	24.77	1.88
77	MP2C	Z	-42.902	1.88
78	MP2C	Mx	-.016	1.88
79	MP2C	X	24.77	3.88
80	MP2C	Z	-42.902	3.88
81	MP2C	Mx	-.016	3.88
82	MP3A	X	24.656	2
83	MP3A	Z	-42.705	2
84	MP3A	Mx	.008	2
85	MP3B	X	18.026	2
86	MP3B	Z	-31.222	2
87	MP3B	Mx	-.012	2
88	MP3C	X	24.656	2
89	MP3C	Z	-42.705	2
90	MP3C	Mx	.008	2
91	MP4A	X	24.223	2
92	MP4A	Z	-41.955	2
93	MP4A	Mx	.008	2
94	MP4B	X	16.293	2
95	MP4B	Z	-28.22	2
96	MP4B	Mx	-.011	2
97	MP4C	X	24.223	2
98	MP4C	Z	-41.955	2
99	MP4C	Mx	.008	2

Member Point Loads (BLC 5 : Antenna Wo (60 Deg))

	Member Label	Direction	Magnitude[lb.k-ft]	Location[ft.%]
1	MP3A	X	13.761	.5
2	MP3A	Z	-7.945	.5
3	MP3A	Mx	.007	.5
4	MP3B	X	8.894	.5
5	MP3B	Z	-5.135	.5
6	MP3B	Mx	-.005	.5
7	MP3C	X	28.215	.5
8	MP3C	Z	-16.29	.5
9	MP3C	Mx	.003	.5
10	MP1A	X	91.111	.75
11	MP1A	Z	-52.603	.75
12	MP1A	Mx	-.046	.75
13	MP1A	X	91.111	5
14	MP1A	Z	-52.603	5
15	MP1A	Mx	-.046	5
16	MP1B	X	79.078	.75
17	MP1B	Z	-45.656	.75
18	MP1B	Mx	.045	.75
19	MP1B	X	79.078	5
20	MP1B	Z	-45.656	5
21	MP1B	Mx	.045	5
22	MP1C	X	126.844	.75

Member Point Loads (BLC 5 : Antenna Wo (60 Deg)) (Continued)

	Member Label	Direction	Magnitude[lb.k-ft]	Location[ft. %]
23	MP1C	Z	-73.233	.75
24	MP1C	Mx	-.013	.75
25	MP1C	X	126.844	5
26	MP1C	Z	-73.233	5
27	MP1C	Mx	-.013	5
28	MP4A	X	57.603	.5
29	MP4A	Z	-33.257	.5
30	MP4A	Mx	-.062	.5
31	MP4A	X	57.603	5.5
32	MP4A	Z	-33.257	5.5
33	MP4A	Mx	-.062	5.5
34	MP4B	X	53.273	.5
35	MP4B	Z	-30.757	.5
36	MP4B	Mx	.025	.5
37	MP4B	X	53.273	5.5
38	MP4B	Z	-30.757	5.5
39	MP4B	Mx	.025	5.5
40	MP4C	X	70.462	.5
41	MP4C	Z	-40.681	.5
42	MP4C	Mx	.073	.5
43	MP4C	X	70.462	5.5
44	MP4C	Z	-40.681	5.5
45	MP4C	Mx	.073	5.5
46	MP4A	X	57.603	.5
47	MP4A	Z	-33.257	.5
48	MP4A	Mx	.004	.5
49	MP4A	X	57.603	5.5
50	MP4A	Z	-33.257	5.5
51	MP4A	Mx	.004	5.5
52	MP4B	X	53.273	.5
53	MP4B	Z	-30.757	.5
54	MP4B	Mx	.036	.5
55	MP4B	X	53.273	5.5
56	MP4B	Z	-30.757	5.5
57	MP4B	Mx	.036	5.5
58	MP4C	X	70.462	.5
59	MP4C	Z	-40.681	.5
60	MP4C	Mx	-.087	.5
61	MP4C	X	70.462	5.5
62	MP4C	Z	-40.681	5.5
63	MP4C	Mx	-.087	5.5
64	MP2A	X	29.909	1.88
65	MP2A	Z	-17.268	1.88
66	MP2A	Mx	-.015	1.88
67	MP2A	X	29.909	3.88
68	MP2A	Z	-17.268	3.88
69	MP2A	Mx	-.015	3.88
70	MP2B	X	20.557	1.88
71	MP2B	Z	-11.869	1.88
72	MP2B	Mx	.012	1.88
73	MP2B	X	20.557	3.88
74	MP2B	Z	-11.869	3.88
75	MP2B	Mx	.012	3.88
76	MP2C	X	57.678	1.88
77	MP2C	Z	-33.301	1.88
78	MP2C	Mx	-.006	1.88
79	MP2C	X	57.678	3.88



Company :
 Designer :
 Job Number :
 Model Name :

July 6, 2023
 1:03 PM
 Checked By: _____

Member Point Loads (BLC 5 : Antenna Wo (60 Deg)) (Continued)

	Member Label	Direction	Magnitude[lb.k-ft]	Location[ft.%]
80	MP2C	Z	-33.301	3.88
81	MP2C	Mx	-.006	3.88
82	MP3A	X	35.05	2
83	MP3A	Z	-20.236	2
84	MP3A	Mx	.012	2
85	MP3B	X	35.05	2
86	MP3B	Z	-20.236	2
87	MP3B	Mx	-.012	2
88	MP3C	X	46.533	2
89	MP3C	Z	-26.866	2
90	MP3C	Mx	0	2
91	MP4A	X	32.798	2
92	MP4A	Z	-18.936	2
93	MP4A	Mx	.011	2
94	MP4B	X	32.798	2
95	MP4B	Z	-18.936	2
96	MP4B	Mx	-.011	2
97	MP4C	X	46.533	2
98	MP4C	Z	-26.866	2
99	MP4C	Mx	0	2

Member Point Loads (BLC 6 : Antenna Wo (90 Deg))

	Member Label	Direction	Magnitude[lb.k-ft]	Location[ft.%]
1	MP3A	X	10.094	.5
2	MP3A	Z	0	.5
3	MP3A	Mx	.005	.5
4	MP3B	X	17.721	.5
5	MP3B	Z	0	.5
6	MP3B	Mx	-.007	.5
7	MP3C	X	30.567	.5
8	MP3C	Z	0	.5
9	MP3C	Mx	-.005	.5
10	MP1A	X	90.876	.75
11	MP1A	Z	0	.75
12	MP1A	Mx	-.045	.75
13	MP1A	X	90.876	5
14	MP1A	Z	0	5
15	MP1A	Mx	-.045	5
16	MP1B	X	109.733	.75
17	MP1B	Z	0	.75
18	MP1B	Mx	.045	.75
19	MP1B	X	109.733	5
20	MP1B	Z	0	5
21	MP1B	Mx	.045	5
22	MP1C	X	141.49	.75
23	MP1C	Z	0	.75
24	MP1C	Mx	.024	.75
25	MP1C	X	141.49	5
26	MP1C	Z	0	5
27	MP1C	Mx	.024	5
28	MP4A	X	61.358	.5
29	MP4A	Z	0	.5
30	MP4A	Mx	-.031	.5
31	MP4A	X	61.358	5.5
32	MP4A	Z	0	5.5
33	MP4A	Mx	-.031	5.5



Company :
 Designer :
 Job Number :
 Model Name :

July 6, 2023
 1:03 PM
 Checked By: _____

Member Point Loads (BLC 6 : Antenna Wo (90 Deg)) (Continued)

	Member Label	Direction	Magnitude[lb.k-ft]	Location[ft.%]
34	MP4B	X	68.144	.5
35	MP4B	Z	0	.5
36	MP4B	Mx	-.011	.5
37	MP4B	X	68.144	5.5
38	MP4B	Z	0	5.5
39	MP4B	Mx	-.011	5.5
40	MP4C	X	79.571	.5
41	MP4C	Z	0	.5
42	MP4C	Mx	.088	.5
43	MP4C	X	79.571	5.5
44	MP4C	Z	0	5.5
45	MP4C	Mx	.088	5.5
46	MP4A	X	61.358	.5
47	MP4A	Z	0	.5
48	MP4A	Mx	-.031	.5
49	MP4A	X	61.358	5.5
50	MP4A	Z	0	5.5
51	MP4A	Mx	-.031	5.5
52	MP4B	X	68.144	.5
53	MP4B	Z	0	.5
54	MP4B	Mx	.067	.5
55	MP4B	X	68.144	5.5
56	MP4B	Z	0	5.5
57	MP4B	Mx	.067	5.5
58	MP4C	X	79.571	.5
59	MP4C	Z	0	.5
60	MP4C	Mx	-.061	.5
61	MP4C	X	79.571	5.5
62	MP4C	Z	0	5.5
63	MP4C	Mx	-.061	5.5
64	MP2A	X	23.399	1.88
65	MP2A	Z	0	1.88
66	MP2A	Mx	-.012	1.88
67	MP2A	X	23.399	3.88
68	MP2A	Z	0	3.88
69	MP2A	Mx	-.012	3.88
70	MP2B	X	38.054	1.88
71	MP2B	Z	0	1.88
72	MP2B	Mx	.016	1.88
73	MP2B	X	38.054	3.88
74	MP2B	Z	0	3.88
75	MP2B	Mx	.016	3.88
76	MP2C	X	62.734	1.88
77	MP2C	Z	0	1.88
78	MP2C	Mx	.011	1.88
79	MP2C	X	62.734	3.88
80	MP2C	Z	0	3.88
81	MP2C	Mx	.011	3.88
82	MP3A	X	36.052	2
83	MP3A	Z	0	2
84	MP3A	Mx	.012	2
85	MP3B	X	49.312	2
86	MP3B	Z	0	2
87	MP3B	Mx	-.008	2
88	MP3C	X	49.312	2
89	MP3C	Z	0	2
90	MP3C	Mx	-.008	2



Company :
 Designer :
 Job Number :
 Model Name :

July 6, 2023
 1:03 PM
 Checked By: _____

Member Point Loads (BLC 6 : Antenna Wo (90 Deg)) (Continued)

	Member Label	Direction	Magnitude[lb.k-ft]	Location[ft.%]
91	MP4A	X	32.586	2
92	MP4A	Z	0	2
93	MP4A	Mx	.011	2
94	MP4B	X	48.445	2
95	MP4B	Z	0	2
96	MP4B	Mx	-.008	2
97	MP4C	X	48.445	2
98	MP4C	Z	0	2
99	MP4C	Mx	-.008	2

Member Point Loads (BLC 7 : Antenna Wo (120 Deg))

	Member Label	Direction	Magnitude[lb.k-ft]	Location[ft.%]
1	MP3A	X	13.761	.5
2	MP3A	Z	7.945	.5
3	MP3A	Mx	.007	.5
4	MP3B	X	25.234	.5
5	MP3B	Z	14.569	.5
6	MP3B	Mx	-.006	.5
7	MP3C	X	17.038	.5
8	MP3C	Z	9.837	.5
9	MP3C	Mx	-.008	.5
10	MP1A	X	91.111	.75
11	MP1A	Z	52.603	.75
12	MP1A	Mx	-.046	.75
13	MP1A	X	91.111	5
14	MP1A	Z	52.603	5
15	MP1A	Mx	-.046	5
16	MP1B	X	119.475	.75
17	MP1B	Z	68.979	.75
18	MP1B	Mx	.029	.75
19	MP1B	X	119.475	5
20	MP1B	Z	68.979	5
21	MP1B	Mx	.029	5
22	MP1C	X	99.211	.75
23	MP1C	Z	57.279	.75
24	MP1C	Mx	.044	.75
25	MP1C	X	99.211	5
26	MP1C	Z	57.279	5
27	MP1C	Mx	.044	5
28	MP4A	X	57.603	.5
29	MP4A	Z	33.257	.5
30	MP4A	Mx	.004	.5
31	MP4A	X	57.603	5.5
32	MP4A	Z	33.257	5.5
33	MP4A	Mx	.004	5.5
34	MP4B	X	67.81	.5
35	MP4B	Z	39.15	.5
36	MP4B	Mx	-.054	.5
37	MP4B	X	67.81	5.5
38	MP4B	Z	39.15	5.5
39	MP4B	Mx	-.054	5.5
40	MP4C	X	60.518	.5
41	MP4C	Z	34.94	.5
42	MP4C	Mx	.072	.5
43	MP4C	X	60.518	5.5
44	MP4C	Z	34.94	5.5



Company :
 Designer :
 Job Number :
 Model Name :

July 6, 2023
 1:03 PM
 Checked By: _____

Member Point Loads (BLC 7 : Antenna Wo (120 Deg)) (Continued)

	Member Label	Direction	Magnitude[lb.k-ft]	Location[ft.%]
45	MP4C	Mx	.072	5.5
46	MP4A	X	57.603	.5
47	MP4A	Z	33.257	.5
48	MP4A	Mx	-.062	.5
49	MP4A	X	57.603	5.5
50	MP4A	Z	33.257	5.5
51	MP4A	Mx	-.062	5.5
52	MP4B	X	67.81	.5
53	MP4B	Z	39.15	.5
54	MP4B	Mx	.088	.5
55	MP4B	X	67.81	5.5
56	MP4B	Z	39.15	5.5
57	MP4B	Mx	.088	5.5
58	MP4C	X	60.518	.5
59	MP4C	Z	34.94	.5
60	MP4C	Mx	-.018	.5
61	MP4C	X	60.518	5.5
62	MP4C	Z	34.94	5.5
63	MP4C	Mx	-.018	5.5
64	MP2A	X	29.909	1.88
65	MP2A	Z	17.268	1.88
66	MP2A	Mx	-.015	1.88
67	MP2A	X	29.909	3.88
68	MP2A	Z	17.268	3.88
69	MP2A	Mx	-.015	3.88
70	MP2B	X	51.952	1.88
71	MP2B	Z	29.994	1.88
72	MP2B	Mx	.013	1.88
73	MP2B	X	51.952	3.88
74	MP2B	Z	29.994	3.88
75	MP2B	Mx	.013	3.88
76	MP2C	X	36.204	1.88
77	MP2C	Z	20.902	1.88
78	MP2C	Mx	.016	1.88
79	MP2C	X	36.204	3.88
80	MP2C	Z	20.902	3.88
81	MP2C	Mx	.016	3.88
82	MP3A	X	35.05	2
83	MP3A	Z	20.236	2
84	MP3A	Mx	.012	2
85	MP3B	X	46.533	2
86	MP3B	Z	26.866	2
87	MP3B	Mx	0	2
88	MP3C	X	35.05	2
89	MP3C	Z	20.236	2
90	MP3C	Mx	-.012	2
91	MP4A	X	32.798	2
92	MP4A	Z	18.936	2
93	MP4A	Mx	.011	2
94	MP4B	X	46.533	2
95	MP4B	Z	26.866	2
96	MP4B	Mx	0	2
97	MP4C	X	32.798	2
98	MP4C	Z	18.936	2
99	MP4C	Mx	-.011	2



Company :
 Designer :
 Job Number :
 Model Name :

July 6, 2023
 1:03 PM
 Checked By: _____

Member Point Loads (BLC 8 : Antenna Wo (150 Deg))

	Member Label	Direction	Magnitude[lb.k-ft]	Location[ft.%]
1	MP3A	X	13.741	.5
2	MP3A	Z	23.801	.5
3	MP3A	Mx	.007	.5
4	MP3B	X	16.551	.5
5	MP3B	Z	28.668	.5
6	MP3B	Mx	.001	.5
7	MP3C	X	5.396	.5
8	MP3C	Z	9.347	.5
9	MP3C	Mx	-.005	.5
10	MP1A	X	66.933	.75
11	MP1A	Z	115.931	.75
12	MP1A	Mx	-.033	.75
13	MP1A	X	66.933	5
14	MP1A	Z	115.931	5
15	MP1A	Mx	-.033	5
16	MP1B	X	73.88	.75
17	MP1B	Z	127.964	.75
18	MP1B	Mx	-.006	.75
19	MP1B	X	73.88	5
20	MP1B	Z	127.964	5
21	MP1B	Mx	-.006	5
22	MP1C	X	46.302	.75
23	MP1C	Z	80.198	.75
24	MP1C	Mx	.046	.75
25	MP1C	X	46.302	5
26	MP1C	Z	80.198	5
27	MP1C	Mx	.046	5
28	MP4A	X	38.414	.5
29	MP4A	Z	66.535	.5
30	MP4A	Mx	.047	.5
31	MP4A	X	38.414	5.5
32	MP4A	Z	66.535	5.5
33	MP4A	Mx	.047	5.5
34	MP4B	X	40.914	.5
35	MP4B	Z	70.865	.5
36	MP4B	Mx	-.085	.5
37	MP4B	X	40.914	5.5
38	MP4B	Z	70.865	5.5
39	MP4B	Mx	-.085	5.5
40	MP4C	X	30.99	.5
41	MP4C	Z	53.676	.5
42	MP4C	Mx	.041	.5
43	MP4C	X	30.99	5.5
44	MP4C	Z	53.676	5.5
45	MP4C	Mx	.041	5.5
46	MP4A	X	38.414	.5
47	MP4A	Z	66.535	.5
48	MP4A	Mx	-.086	.5
49	MP4A	X	38.414	5.5
50	MP4A	Z	66.535	5.5
51	MP4A	Mx	-.086	5.5
52	MP4B	X	40.914	.5
53	MP4B	Z	70.865	.5
54	MP4B	Mx	.078	.5
55	MP4B	X	40.914	5.5
56	MP4B	Z	70.865	5.5
57	MP4B	Mx	.078	5.5



Company :
 Designer :
 Job Number :
 Model Name :

July 6, 2023
 1:03 PM
 Checked By: _____

Member Point Loads (BLC 8 : Antenna Wo (150 Deg)) (Continued)

	Member Label	Direction	Magnitude[lb.k-ft]	Location[ft.%]
58	MP4C	X	30.99	.5
59	MP4C	Z	53.676	.5
60	MP4C	Mx	.02	.5
61	MP4C	X	30.99	5.5
62	MP4C	Z	53.676	5.5
63	MP4C	Mx	.02	5.5
64	MP2A	X	28.404	1.88
65	MP2A	Z	49.197	1.88
66	MP2A	Mx	-.014	1.88
67	MP2A	X	28.404	3.88
68	MP2A	Z	49.197	3.88
69	MP2A	Mx	-.014	3.88
70	MP2B	X	33.803	1.88
71	MP2B	Z	58.549	1.88
72	MP2B	Mx	-.003	1.88
73	MP2B	X	33.803	3.88
74	MP2B	Z	58.549	3.88
75	MP2B	Mx	-.003	3.88
76	MP2C	X	12.371	1.88
77	MP2C	Z	21.428	1.88
78	MP2C	Mx	.012	1.88
79	MP2C	X	12.371	3.88
80	MP2C	Z	21.428	3.88
81	MP2C	Mx	.012	3.88
82	MP3A	X	24.656	2
83	MP3A	Z	42.705	2
84	MP3A	Mx	.008	2
85	MP3B	X	24.656	2
86	MP3B	Z	42.705	2
87	MP3B	Mx	.008	2
88	MP3C	X	18.026	2
89	MP3C	Z	31.222	2
90	MP3C	Mx	-.012	2
91	MP4A	X	24.223	2
92	MP4A	Z	41.955	2
93	MP4A	Mx	.008	2
94	MP4B	X	24.223	2
95	MP4B	Z	41.955	2
96	MP4B	Mx	.008	2
97	MP4C	X	16.293	2
98	MP4C	Z	28.22	2
99	MP4C	Mx	-.011	2

Member Point Loads (BLC 9 : Antenna Wo (180 Deg))

	Member Label	Direction	Magnitude[lb.k-ft]	Location[ft.%]
1	MP3A	X	0	.5
2	MP3A	Z	33.279	.5
3	MP3A	Mx	0	.5
4	MP3B	X	0	.5
5	MP3B	Z	25.651	.5
6	MP3B	Mx	.007	.5
7	MP3C	X	0	.5
8	MP3C	Z	12.806	.5
9	MP3C	Mx	-.006	.5
10	MP1A	X	0	.75
11	MP1A	Z	148.195	.75



Company :
 Designer :
 Job Number :
 Model Name :

July 6, 2023
 1:03 PM
 Checked By: _____

Member Point Loads (BLC 9 : Antenna Wo (180 Deg)) (Continued)

	Member Label	Direction	Magnitude[lb.k-ft]	Location[ft.%]
12	MP1A	Mx	0	.75
13	MP1A	X	0	5
14	MP1A	Z	148.195	5
15	MP1A	Mx	0	5
16	MP1B	X	0	.75
17	MP1B	Z	129.338	.75
18	MP1B	Mx	-.037	.75
19	MP1B	X	0	5
20	MP1B	Z	129.338	5
21	MP1B	Mx	-.037	5
22	MP1C	X	0	.75
23	MP1C	Z	97.581	.75
24	MP1C	Mx	.046	.75
25	MP1C	X	0	5
26	MP1C	Z	97.581	5
27	MP1C	Mx	.046	5
28	MP4A	X	0	.5
29	MP4A	Z	81.984	.5
30	MP4A	Mx	.082	.5
31	MP4A	X	0	5.5
32	MP4A	Z	81.984	5.5
33	MP4A	Mx	.082	5.5
34	MP4B	X	0	.5
35	MP4B	Z	75.198	.5
36	MP4B	Mx	-.083	.5
37	MP4B	X	0	5.5
38	MP4B	Z	75.198	5.5
39	MP4B	Mx	-.083	5.5
40	MP4C	X	0	.5
41	MP4C	Z	63.771	.5
42	MP4C	Mx	.008	.5
43	MP4C	X	0	5.5
44	MP4C	Z	63.771	5.5
45	MP4C	Mx	.008	5.5
46	MP4A	X	0	.5
47	MP4A	Z	81.984	.5
48	MP4A	Mx	-.082	.5
49	MP4A	X	0	5.5
50	MP4A	Z	81.984	5.5
51	MP4A	Mx	-.082	5.5
52	MP4B	X	0	.5
53	MP4B	Z	75.198	.5
54	MP4B	Mx	.04	.5
55	MP4B	X	0	5.5
56	MP4B	Z	75.198	5.5
57	MP4B	Mx	.04	5.5
58	MP4C	X	0	.5
59	MP4C	Z	63.771	.5
60	MP4C	Mx	.052	.5
61	MP4C	X	0	5.5
62	MP4C	Z	63.771	5.5
63	MP4C	Mx	.052	5.5
64	MP2A	X	0	1.88
65	MP2A	Z	67.945	1.88
66	MP2A	Mx	0	1.88
67	MP2A	X	0	3.88
68	MP2A	Z	67.945	3.88

Member Point Loads (BLC 9 : Antenna Wo (180 Deg)) (Continued)

	Member Label	Direction	Magnitude[lb.k-ft]	Location[ft.%]
69	MP2A	Mx	0	3.88
70	MP2B	X	0	1.88
71	MP2B	Z	53.29	1.88
72	MP2B	Mx	-.015	1.88
73	MP2B	X	0	3.88
74	MP2B	Z	53.29	3.88
75	MP2B	Mx	-.015	3.88
76	MP2C	X	0	1.88
77	MP2C	Z	28.61	1.88
78	MP2C	Mx	.013	1.88
79	MP2C	X	0	3.88
80	MP2C	Z	28.61	3.88
81	MP2C	Mx	.013	3.88
82	MP3A	X	0	2
83	MP3A	Z	53.732	2
84	MP3A	Mx	0	2
85	MP3B	X	0	2
86	MP3B	Z	40.472	2
87	MP3B	Mx	.012	2
88	MP3C	X	0	2
89	MP3C	Z	40.472	2
90	MP3C	Mx	-.012	2
91	MP4A	X	0	2
92	MP4A	Z	53.732	2
93	MP4A	Mx	0	2
94	MP4B	X	0	2
95	MP4B	Z	37.872	2
96	MP4B	Mx	.011	2
97	MP4C	X	0	2
98	MP4C	Z	37.872	2
99	MP4C	Mx	-.011	2

Member Point Loads (BLC 10 : Antenna Wo (210 Deg))

	Member Label	Direction	Magnitude[lb.k-ft]	Location[ft.%]
1	MP3A	X	-13.741	.5
2	MP3A	Z	23.801	.5
3	MP3A	Mx	-.007	.5
4	MP3B	X	-7.117	.5
5	MP3B	Z	12.328	.5
6	MP3B	Mx	.006	.5
7	MP3C	X	-11.85	.5
8	MP3C	Z	20.524	.5
9	MP3C	Mx	-.008	.5
10	MP1A	X	-66.933	.75
11	MP1A	Z	115.931	.75
12	MP1A	Mx	.033	.75
13	MP1A	X	-66.933	5
14	MP1A	Z	115.931	5
15	MP1A	Mx	.033	5
16	MP1B	X	-50.557	.75
17	MP1B	Z	87.567	.75
18	MP1B	Mx	-.046	.75
19	MP1B	X	-50.557	5
20	MP1B	Z	87.567	5
21	MP1B	Mx	-.046	5
22	MP1C	X	-62.256	.75

Member Point Loads (BLC 10 : Antenna Wo (210 Deg)) (Continued)

	Member Label	Direction	Magnitude[lb.k-ft]	Location[ft.%]
23	MP1C	Z	107.831	.75
24	MP1C	Mx	.04	.75
25	MP1C	X	-62.256	5
26	MP1C	Z	107.831	5
27	MP1C	Mx	.04	5
28	MP4A	X	-38.414	.5
29	MP4A	Z	66.535	.5
30	MP4A	Mx	.086	.5
31	MP4A	X	-38.414	5.5
32	MP4A	Z	66.535	5.5
33	MP4A	Mx	.086	5.5
34	MP4B	X	-32.521	.5
35	MP4B	Z	56.328	.5
36	MP4B	Mx	-.057	.5
37	MP4B	X	-32.521	5.5
38	MP4B	Z	56.328	5.5
39	MP4B	Mx	-.057	5.5
40	MP4C	X	-36.731	.5
41	MP4C	Z	63.62	.5
42	MP4C	Mx	-.033	.5
43	MP4C	X	-36.731	5.5
44	MP4C	Z	63.62	5.5
45	MP4C	Mx	-.033	5.5
46	MP4A	X	-38.414	.5
47	MP4A	Z	66.535	.5
48	MP4A	Mx	-.047	.5
49	MP4A	X	-38.414	5.5
50	MP4A	Z	66.535	5.5
51	MP4A	Mx	-.047	5.5
52	MP4B	X	-32.521	.5
53	MP4B	Z	56.328	.5
54	MP4B	Mx	-.002	.5
55	MP4B	X	-32.521	5.5
56	MP4B	Z	56.328	5.5
57	MP4B	Mx	-.002	5.5
58	MP4C	X	-36.731	.5
59	MP4C	Z	63.62	.5
60	MP4C	Mx	.08	.5
61	MP4C	X	-36.731	5.5
62	MP4C	Z	63.62	5.5
63	MP4C	Mx	.08	5.5
64	MP2A	X	-28.404	1.88
65	MP2A	Z	49.197	1.88
66	MP2A	Mx	.014	1.88
67	MP2A	X	-28.404	3.88
68	MP2A	Z	49.197	3.88
69	MP2A	Mx	.014	3.88
70	MP2B	X	-15.678	1.88
71	MP2B	Z	27.155	1.88
72	MP2B	Mx	-.014	1.88
73	MP2B	X	-15.678	3.88
74	MP2B	Z	27.155	3.88
75	MP2B	Mx	-.014	3.88
76	MP2C	X	-24.77	1.88
77	MP2C	Z	42.902	1.88
78	MP2C	Mx	.016	1.88
79	MP2C	X	-24.77	3.88

Member Point Loads (BLC 10 : Antenna Wo (210 Deg)) (Continued)

	Member Label	Direction	Magnitude[lb.k-ft]	Location[ft.%]
80	MP2C	Z	42.902	3.88
81	MP2C	Mx	.016	3.88
82	MP3A	X	-24.656	2
83	MP3A	Z	42.705	2
84	MP3A	Mx	-.008	2
85	MP3B	X	-18.026	2
86	MP3B	Z	31.222	2
87	MP3B	Mx	.012	2
88	MP3C	X	-24.656	2
89	MP3C	Z	42.705	2
90	MP3C	Mx	-.008	2
91	MP4A	X	-24.223	2
92	MP4A	Z	41.955	2
93	MP4A	Mx	-.008	2
94	MP4B	X	-16.293	2
95	MP4B	Z	28.22	2
96	MP4B	Mx	.011	2
97	MP4C	X	-24.223	2
98	MP4C	Z	41.955	2
99	MP4C	Mx	-.008	2

Member Point Loads (BLC 11 : Antenna Wo (240 Deg))

	Member Label	Direction	Magnitude[lb.k-ft]	Location[ft.%]
1	MP3A	X	-13.761	.5
2	MP3A	Z	7.945	.5
3	MP3A	Mx	-.007	.5
4	MP3B	X	-8.894	.5
5	MP3B	Z	5.135	.5
6	MP3B	Mx	.005	.5
7	MP3C	X	-28.215	.5
8	MP3C	Z	16.29	.5
9	MP3C	Mx	-.003	.5
10	MP1A	X	-91.111	.75
11	MP1A	Z	52.603	.75
12	MP1A	Mx	.046	.75
13	MP1A	X	-91.111	5
14	MP1A	Z	52.603	5
15	MP1A	Mx	.046	5
16	MP1B	X	-79.078	.75
17	MP1B	Z	45.656	.75
18	MP1B	Mx	-.045	.75
19	MP1B	X	-79.078	5
20	MP1B	Z	45.656	5
21	MP1B	Mx	-.045	5
22	MP1C	X	-126.844	.75
23	MP1C	Z	73.233	.75
24	MP1C	Mx	.013	.75
25	MP1C	X	-126.844	5
26	MP1C	Z	73.233	5
27	MP1C	Mx	.013	5
28	MP4A	X	-57.603	.5
29	MP4A	Z	33.257	.5
30	MP4A	Mx	.062	.5
31	MP4A	X	-57.603	5.5
32	MP4A	Z	33.257	5.5
33	MP4A	Mx	.062	5.5



Company :
 Designer :
 Job Number :
 Model Name :

July 6, 2023
 1:03 PM
 Checked By: _____

Member Point Loads (BLC 11 : Antenna Wo (240 Deg)) (Continued)

	Member Label	Direction	Magnitude[lb.k-ft]	Location[ft.%]
34	MP4B	X	-53.273	.5
35	MP4B	Z	30.757	.5
36	MP4B	Mx	-.025	.5
37	MP4B	X	-53.273	5.5
38	MP4B	Z	30.757	5.5
39	MP4B	Mx	-.025	5.5
40	MP4C	X	-70.462	.5
41	MP4C	Z	40.681	.5
42	MP4C	Mx	-.073	.5
43	MP4C	X	-70.462	5.5
44	MP4C	Z	40.681	5.5
45	MP4C	Mx	-.073	5.5
46	MP4A	X	-57.603	.5
47	MP4A	Z	33.257	.5
48	MP4A	Mx	-.004	.5
49	MP4A	X	-57.603	5.5
50	MP4A	Z	33.257	5.5
51	MP4A	Mx	-.004	5.5
52	MP4B	X	-53.273	.5
53	MP4B	Z	30.757	.5
54	MP4B	Mx	-.036	.5
55	MP4B	X	-53.273	5.5
56	MP4B	Z	30.757	5.5
57	MP4B	Mx	-.036	5.5
58	MP4C	X	-70.462	.5
59	MP4C	Z	40.681	.5
60	MP4C	Mx	.087	.5
61	MP4C	X	-70.462	5.5
62	MP4C	Z	40.681	5.5
63	MP4C	Mx	.087	5.5
64	MP2A	X	-29.909	1.88
65	MP2A	Z	17.268	1.88
66	MP2A	Mx	.015	1.88
67	MP2A	X	-29.909	3.88
68	MP2A	Z	17.268	3.88
69	MP2A	Mx	.015	3.88
70	MP2B	X	-20.557	1.88
71	MP2B	Z	11.869	1.88
72	MP2B	Mx	-.012	1.88
73	MP2B	X	-20.557	3.88
74	MP2B	Z	11.869	3.88
75	MP2B	Mx	-.012	3.88
76	MP2C	X	-57.678	1.88
77	MP2C	Z	33.301	1.88
78	MP2C	Mx	.006	1.88
79	MP2C	X	-57.678	3.88
80	MP2C	Z	33.301	3.88
81	MP2C	Mx	.006	3.88
82	MP3A	X	-35.05	2
83	MP3A	Z	20.236	2
84	MP3A	Mx	-.012	2
85	MP3B	X	-35.05	2
86	MP3B	Z	20.236	2
87	MP3B	Mx	.012	2
88	MP3C	X	-46.533	2
89	MP3C	Z	26.866	2
90	MP3C	Mx	0	2



Company :
 Designer :
 Job Number :
 Model Name :

July 6, 2023
 1:03 PM
 Checked By: _____

Member Point Loads (BLC 11 : Antenna Wo (240 Deg)) (Continued)

	Member Label	Direction	Magnitude[lb.k-ft]	Location[ft.%]
91	MP4A	X	-32.798	2
92	MP4A	Z	18.936	2
93	MP4A	Mx	-.011	2
94	MP4B	X	-32.798	2
95	MP4B	Z	18.936	2
96	MP4B	Mx	.011	2
97	MP4C	X	-46.533	2
98	MP4C	Z	26.866	2
99	MP4C	Mx	0	2

Member Point Loads (BLC 12 : Antenna Wo (270 Deg))

	Member Label	Direction	Magnitude[lb.k-ft]	Location[ft.%]
1	MP3A	X	-10.094	.5
2	MP3A	Z	0	.5
3	MP3A	Mx	-.005	.5
4	MP3B	X	-17.721	.5
5	MP3B	Z	0	.5
6	MP3B	Mx	.007	.5
7	MP3C	X	-30.567	.5
8	MP3C	Z	0	.5
9	MP3C	Mx	.005	.5
10	MP1A	X	-90.876	.75
11	MP1A	Z	0	.75
12	MP1A	Mx	.045	.75
13	MP1A	X	-90.876	5
14	MP1A	Z	0	5
15	MP1A	Mx	.045	5
16	MP1B	X	-109.733	.75
17	MP1B	Z	0	.75
18	MP1B	Mx	-.045	.75
19	MP1B	X	-109.733	5
20	MP1B	Z	0	5
21	MP1B	Mx	-.045	5
22	MP1C	X	-141.49	.75
23	MP1C	Z	0	.75
24	MP1C	Mx	-.024	.75
25	MP1C	X	-141.49	5
26	MP1C	Z	0	5
27	MP1C	Mx	-.024	5
28	MP4A	X	-61.358	.5
29	MP4A	Z	0	.5
30	MP4A	Mx	.031	.5
31	MP4A	X	-61.358	5.5
32	MP4A	Z	0	5.5
33	MP4A	Mx	.031	5.5
34	MP4B	X	-68.144	.5
35	MP4B	Z	0	.5
36	MP4B	Mx	.011	.5
37	MP4B	X	-68.144	5.5
38	MP4B	Z	0	5.5
39	MP4B	Mx	.011	5.5
40	MP4C	X	-79.571	.5
41	MP4C	Z	0	.5
42	MP4C	Mx	-.088	.5
43	MP4C	X	-79.571	5.5
44	MP4C	Z	0	5.5



Company :
 Designer :
 Job Number :
 Model Name :

July 6, 2023
 1:03 PM
 Checked By: _____

Member Point Loads (BLC 12 : Antenna Wo (270 Deg)) (Continued)

	Member Label	Direction	Magnitude[lb.k-ft]	Location[ft.%]
45	MP4C	Mx	-.088	5.5
46	MP4A	X	-61.358	.5
47	MP4A	Z	0	.5
48	MP4A	Mx	.031	.5
49	MP4A	X	-61.358	5.5
50	MP4A	Z	0	5.5
51	MP4A	Mx	.031	5.5
52	MP4B	X	-68.144	.5
53	MP4B	Z	0	.5
54	MP4B	Mx	-.067	.5
55	MP4B	X	-68.144	5.5
56	MP4B	Z	0	5.5
57	MP4B	Mx	-.067	5.5
58	MP4C	X	-79.571	.5
59	MP4C	Z	0	.5
60	MP4C	Mx	.061	.5
61	MP4C	X	-79.571	5.5
62	MP4C	Z	0	5.5
63	MP4C	Mx	.061	5.5
64	MP2A	X	-23.399	1.88
65	MP2A	Z	0	1.88
66	MP2A	Mx	.012	1.88
67	MP2A	X	-23.399	3.88
68	MP2A	Z	0	3.88
69	MP2A	Mx	.012	3.88
70	MP2B	X	-38.054	1.88
71	MP2B	Z	0	1.88
72	MP2B	Mx	-.016	1.88
73	MP2B	X	-38.054	3.88
74	MP2B	Z	0	3.88
75	MP2B	Mx	-.016	3.88
76	MP2C	X	-62.734	1.88
77	MP2C	Z	0	1.88
78	MP2C	Mx	-.011	1.88
79	MP2C	X	-62.734	3.88
80	MP2C	Z	0	3.88
81	MP2C	Mx	-.011	3.88
82	MP3A	X	-36.052	2
83	MP3A	Z	0	2
84	MP3A	Mx	-.012	2
85	MP3B	X	-49.312	2
86	MP3B	Z	0	2
87	MP3B	Mx	.008	2
88	MP3C	X	-49.312	2
89	MP3C	Z	0	2
90	MP3C	Mx	.008	2
91	MP4A	X	-32.586	2
92	MP4A	Z	0	2
93	MP4A	Mx	-.011	2
94	MP4B	X	-48.445	2
95	MP4B	Z	0	2
96	MP4B	Mx	.008	2
97	MP4C	X	-48.445	2
98	MP4C	Z	0	2
99	MP4C	Mx	.008	2



Company :
 Designer :
 Job Number :
 Model Name :

July 6, 2023
 1:03 PM
 Checked By: _____

Member Point Loads (BLC 13 : Antenna Wo (300 Deg))

	Member Label	Direction	Magnitude[lb.k-ft]	Location[ft.%]
1	MP3A	X	-13.761	.5
2	MP3A	Z	-7.945	.5
3	MP3A	Mx	-.007	.5
4	MP3B	X	-25.234	.5
5	MP3B	Z	-14.569	.5
6	MP3B	Mx	.006	.5
7	MP3C	X	-17.038	.5
8	MP3C	Z	-9.837	.5
9	MP3C	Mx	.008	.5
10	MP1A	X	-91.111	.75
11	MP1A	Z	-52.603	.75
12	MP1A	Mx	.046	.75
13	MP1A	X	-91.111	5
14	MP1A	Z	-52.603	5
15	MP1A	Mx	.046	5
16	MP1B	X	-119.475	.75
17	MP1B	Z	-68.979	.75
18	MP1B	Mx	-.029	.75
19	MP1B	X	-119.475	5
20	MP1B	Z	-68.979	5
21	MP1B	Mx	-.029	5
22	MP1C	X	-99.211	.75
23	MP1C	Z	-57.279	.75
24	MP1C	Mx	-.044	.75
25	MP1C	X	-99.211	5
26	MP1C	Z	-57.279	5
27	MP1C	Mx	-.044	5
28	MP4A	X	-57.603	.5
29	MP4A	Z	-33.257	.5
30	MP4A	Mx	-.004	.5
31	MP4A	X	-57.603	5.5
32	MP4A	Z	-33.257	5.5
33	MP4A	Mx	-.004	5.5
34	MP4B	X	-67.81	.5
35	MP4B	Z	-39.15	.5
36	MP4B	Mx	.054	.5
37	MP4B	X	-67.81	5.5
38	MP4B	Z	-39.15	5.5
39	MP4B	Mx	.054	5.5
40	MP4C	X	-60.518	.5
41	MP4C	Z	-34.94	.5
42	MP4C	Mx	-.072	.5
43	MP4C	X	-60.518	5.5
44	MP4C	Z	-34.94	5.5
45	MP4C	Mx	-.072	5.5
46	MP4A	X	-57.603	.5
47	MP4A	Z	-33.257	.5
48	MP4A	Mx	.062	.5
49	MP4A	X	-57.603	5.5
50	MP4A	Z	-33.257	5.5
51	MP4A	Mx	.062	5.5
52	MP4B	X	-67.81	.5
53	MP4B	Z	-39.15	.5
54	MP4B	Mx	-.088	.5
55	MP4B	X	-67.81	5.5
56	MP4B	Z	-39.15	5.5
57	MP4B	Mx	-.088	5.5



Company :
 Designer :
 Job Number :
 Model Name :

July 6, 2023
 1:03 PM
 Checked By: _____

Member Point Loads (BLC 13 : Antenna Wo (300 Deg)) (Continued)

	Member Label	Direction	Magnitude[lb.k-ft]	Location[ft.%]
58	MP4C	X	-60.518	.5
59	MP4C	Z	-34.94	.5
60	MP4C	Mx	.018	.5
61	MP4C	X	-60.518	5.5
62	MP4C	Z	-34.94	5.5
63	MP4C	Mx	.018	5.5
64	MP2A	X	-29.909	1.88
65	MP2A	Z	-17.268	1.88
66	MP2A	Mx	.015	1.88
67	MP2A	X	-29.909	3.88
68	MP2A	Z	-17.268	3.88
69	MP2A	Mx	.015	3.88
70	MP2B	X	-51.952	1.88
71	MP2B	Z	-29.994	1.88
72	MP2B	Mx	-.013	1.88
73	MP2B	X	-51.952	3.88
74	MP2B	Z	-29.994	3.88
75	MP2B	Mx	-.013	3.88
76	MP2C	X	-36.204	1.88
77	MP2C	Z	-20.902	1.88
78	MP2C	Mx	-.016	1.88
79	MP2C	X	-36.204	3.88
80	MP2C	Z	-20.902	3.88
81	MP2C	Mx	-.016	3.88
82	MP3A	X	-35.05	2
83	MP3A	Z	-20.236	2
84	MP3A	Mx	-.012	2
85	MP3B	X	-46.533	2
86	MP3B	Z	-26.866	2
87	MP3B	Mx	0	2
88	MP3C	X	-35.05	2
89	MP3C	Z	-20.236	2
90	MP3C	Mx	.012	2
91	MP4A	X	-32.798	2
92	MP4A	Z	-18.936	2
93	MP4A	Mx	-.011	2
94	MP4B	X	-46.533	2
95	MP4B	Z	-26.866	2
96	MP4B	Mx	0	2
97	MP4C	X	-32.798	2
98	MP4C	Z	-18.936	2
99	MP4C	Mx	.011	2

Member Point Loads (BLC 14 : Antenna Wo (330 Deg))

	Member Label	Direction	Magnitude[lb.k-ft]	Location[ft.%]
1	MP3A	X	-13.741	.5
2	MP3A	Z	-23.801	.5
3	MP3A	Mx	-.007	.5
4	MP3B	X	-16.551	.5
5	MP3B	Z	-28.668	.5
6	MP3B	Mx	-.001	.5
7	MP3C	X	-5.396	.5
8	MP3C	Z	-9.347	.5
9	MP3C	Mx	.005	.5
10	MP1A	X	-66.933	.75
11	MP1A	Z	-115.931	.75

Member Point Loads (BLC 14 : Antenna Wo (330 Deg)) (Continued)

	Member Label	Direction	Magnitude[lb.k-ft]	Location[ft.%]
12	MP1A	Mx	.033	.75
13	MP1A	X	-66.933	5
14	MP1A	Z	-115.931	5
15	MP1A	Mx	.033	5
16	MP1B	X	-73.88	.75
17	MP1B	Z	-127.964	.75
18	MP1B	Mx	.006	.75
19	MP1B	X	-73.88	5
20	MP1B	Z	-127.964	5
21	MP1B	Mx	.006	5
22	MP1C	X	-46.302	.75
23	MP1C	Z	-80.198	.75
24	MP1C	Mx	-.046	.75
25	MP1C	X	-46.302	5
26	MP1C	Z	-80.198	5
27	MP1C	Mx	-.046	5
28	MP4A	X	-38.414	.5
29	MP4A	Z	-66.535	.5
30	MP4A	Mx	-.047	.5
31	MP4A	X	-38.414	5.5
32	MP4A	Z	-66.535	5.5
33	MP4A	Mx	-.047	5.5
34	MP4B	X	-40.914	.5
35	MP4B	Z	-70.865	.5
36	MP4B	Mx	.085	.5
37	MP4B	X	-40.914	5.5
38	MP4B	Z	-70.865	5.5
39	MP4B	Mx	.085	5.5
40	MP4C	X	-30.99	.5
41	MP4C	Z	-53.676	.5
42	MP4C	Mx	-.041	.5
43	MP4C	X	-30.99	5.5
44	MP4C	Z	-53.676	5.5
45	MP4C	Mx	-.041	5.5
46	MP4A	X	-38.414	.5
47	MP4A	Z	-66.535	.5
48	MP4A	Mx	.086	.5
49	MP4A	X	-38.414	5.5
50	MP4A	Z	-66.535	5.5
51	MP4A	Mx	.086	5.5
52	MP4B	X	-40.914	.5
53	MP4B	Z	-70.865	.5
54	MP4B	Mx	-.078	.5
55	MP4B	X	-40.914	5.5
56	MP4B	Z	-70.865	5.5
57	MP4B	Mx	-.078	5.5
58	MP4C	X	-30.99	.5
59	MP4C	Z	-53.676	.5
60	MP4C	Mx	-.02	.5
61	MP4C	X	-30.99	5.5
62	MP4C	Z	-53.676	5.5
63	MP4C	Mx	-.02	5.5
64	MP2A	X	-28.404	1.88
65	MP2A	Z	-49.197	1.88
66	MP2A	Mx	.014	1.88
67	MP2A	X	-28.404	3.88
68	MP2A	Z	-49.197	3.88

Member Point Loads (BLC 14 : Antenna Wo (330 Deg)) (Continued)

	Member Label	Direction	Magnitude[lb.k-ft]	Location[ft.%]
69	MP2A	Mx	.014	3.88
70	MP2B	X	-33.803	1.88
71	MP2B	Z	-58.549	1.88
72	MP2B	Mx	.003	1.88
73	MP2B	X	-33.803	3.88
74	MP2B	Z	-58.549	3.88
75	MP2B	Mx	.003	3.88
76	MP2C	X	-12.371	1.88
77	MP2C	Z	-21.428	1.88
78	MP2C	Mx	-.012	1.88
79	MP2C	X	-12.371	3.88
80	MP2C	Z	-21.428	3.88
81	MP2C	Mx	-.012	3.88
82	MP3A	X	-24.656	2
83	MP3A	Z	-42.705	2
84	MP3A	Mx	-.008	2
85	MP3B	X	-24.656	2
86	MP3B	Z	-42.705	2
87	MP3B	Mx	-.008	2
88	MP3C	X	-18.026	2
89	MP3C	Z	-31.222	2
90	MP3C	Mx	.012	2
91	MP4A	X	-24.223	2
92	MP4A	Z	-41.955	2
93	MP4A	Mx	-.008	2
94	MP4B	X	-24.223	2
95	MP4B	Z	-41.955	2
96	MP4B	Mx	-.008	2
97	MP4C	X	-16.293	2
98	MP4C	Z	-28.22	2
99	MP4C	Mx	.011	2

Member Point Loads (BLC 15 : Antenna Wi (0 Deg))

	Member Label	Direction	Magnitude[lb.k-ft]	Location[ft.%]
1	MP3A	X	0	.5
2	MP3A	Z	-6.785	.5
3	MP3A	Mx	0	.5
4	MP3B	X	0	.5
5	MP3B	Z	-5.39	.5
6	MP3B	Mx	-.002	.5
7	MP3C	X	0	.5
8	MP3C	Z	-3.04	.5
9	MP3C	Mx	.001	.5
10	MP1A	X	0	.75
11	MP1A	Z	-25.974	.75
12	MP1A	Mx	0	.75
13	MP1A	X	0	5
14	MP1A	Z	-25.974	5
15	MP1A	Mx	0	5
16	MP1B	X	0	.75
17	MP1B	Z	-22.938	.75
18	MP1B	Mx	.007	.75
19	MP1B	X	0	5
20	MP1B	Z	-22.938	5
21	MP1B	Mx	.007	5
22	MP1C	X	0	.75

Member Point Loads (BLC 15 : Antenna Wi (0 Deg)) (Continued)

	Member Label	Direction	Magnitude[lb.k-ft]	Location[ft.%]
23	MP1C	Z	-17.826	.75
24	MP1C	Mx	-.008	.75
25	MP1C	X	0	5
26	MP1C	Z	-17.826	5
27	MP1C	Mx	-.008	5
28	MP4A	X	0	.5
29	MP4A	Z	-29.79	.5
30	MP4A	Mx	-.03	.5
31	MP4A	X	0	5.5
32	MP4A	Z	-29.79	5.5
33	MP4A	Mx	-.03	5.5
34	MP4B	X	0	.5
35	MP4B	Z	-27.4	.5
36	MP4B	Mx	.03	.5
37	MP4B	X	0	5.5
38	MP4B	Z	-27.4	5.5
39	MP4B	Mx	.03	5.5
40	MP4C	X	0	.5
41	MP4C	Z	-23.376	.5
42	MP4C	Mx	-.003	.5
43	MP4C	X	0	5.5
44	MP4C	Z	-23.376	5.5
45	MP4C	Mx	-.003	5.5
46	MP4A	X	0	.5
47	MP4A	Z	-29.79	.5
48	MP4A	Mx	.03	.5
49	MP4A	X	0	5.5
50	MP4A	Z	-29.79	5.5
51	MP4A	Mx	.03	5.5
52	MP4B	X	0	.5
53	MP4B	Z	-27.4	.5
54	MP4B	Mx	-.015	.5
55	MP4B	X	0	5.5
56	MP4B	Z	-27.4	5.5
57	MP4B	Mx	-.015	5.5
58	MP4C	X	0	.5
59	MP4C	Z	-23.376	.5
60	MP4C	Mx	-.019	.5
61	MP4C	X	0	5.5
62	MP4C	Z	-23.376	5.5
63	MP4C	Mx	-.019	5.5
64	MP2A	X	0	1.88
65	MP2A	Z	-14.686	1.88
66	MP2A	Mx	0	1.88
67	MP2A	X	0	3.88
68	MP2A	Z	-14.686	3.88
69	MP2A	Mx	0	3.88
70	MP2B	X	0	1.88
71	MP2B	Z	-11.908	1.88
72	MP2B	Mx	.003	1.88
73	MP2B	X	0	3.88
74	MP2B	Z	-11.908	3.88
75	MP2B	Mx	.003	3.88
76	MP2C	X	0	1.88
77	MP2C	Z	-7.231	1.88
78	MP2C	Mx	-.003	1.88
79	MP2C	X	0	3.88



Company :
 Designer :
 Job Number :
 Model Name :

July 6, 2023
 1:03 PM
 Checked By: _____

Member Point Loads (BLC 15 : Antenna Wi (0 Deg)) (Continued)

	Member Label	Direction	Magnitude[lb.k-ft]	Location[ft.%]
80	MP2C	Z	-7.231	3.88
81	MP2C	Mx	-.003	3.88
82	MP3A	X	0	2
83	MP3A	Z	-12.362	2
84	MP3A	Mx	0	2
85	MP3B	X	0	2
86	MP3B	Z	-9.534	2
87	MP3B	Mx	-.003	2
88	MP3C	X	0	2
89	MP3C	Z	-9.534	2
90	MP3C	Mx	.003	2
91	MP4A	X	0	2
92	MP4A	Z	-12.362	2
93	MP4A	Mx	0	2
94	MP4B	X	0	2
95	MP4B	Z	-9.025	2
96	MP4B	Mx	-.003	2
97	MP4C	X	0	2
98	MP4C	Z	-9.025	2
99	MP4C	Mx	.003	2

Member Point Loads (BLC 16 : Antenna Wi (30 Deg))

	Member Label	Direction	Magnitude[lb.k-ft]	Location[ft.%]
1	MP3A	X	2.863	.5
2	MP3A	Z	-4.958	.5
3	MP3A	Mx	.001	.5
4	MP3B	X	1.651	.5
5	MP3B	Z	-2.859	.5
6	MP3B	Mx	-.001	.5
7	MP3C	X	2.517	.5
8	MP3C	Z	-4.359	.5
9	MP3C	Mx	.002	.5
10	MP1A	X	11.834	.75
11	MP1A	Z	-20.496	.75
12	MP1A	Mx	-.006	.75
13	MP1A	X	11.834	5
14	MP1A	Z	-20.496	5
15	MP1A	Mx	-.006	5
16	MP1B	X	9.197	.75
17	MP1B	Z	-15.93	.75
18	MP1B	Mx	.008	.75
19	MP1B	X	9.197	5
20	MP1B	Z	-15.93	5
21	MP1B	Mx	.008	5
22	MP1C	X	11.081	.75
23	MP1C	Z	-19.192	.75
24	MP1C	Mx	-.007	.75
25	MP1C	X	11.081	5
26	MP1C	Z	-19.192	5
27	MP1C	Mx	-.007	5
28	MP4A	X	13.987	.5
29	MP4A	Z	-24.226	.5
30	MP4A	Mx	-.031	.5
31	MP4A	X	13.987	5.5
32	MP4A	Z	-24.226	5.5
33	MP4A	Mx	-.031	5.5



Company :
 Designer :
 Job Number :
 Model Name :

July 6, 2023
 1:03 PM
 Checked By: _____

Member Point Loads (BLC 16 : Antenna Wi (30 Deg)) (Continued)

	Member Label	Direction	Magnitude[lb.k-ft]	Location[ft.%]
34	MP4B	X	11.912	.5
35	MP4B	Z	-20.632	.5
36	MP4B	Mx	.021	.5
37	MP4B	X	11.912	5.5
38	MP4B	Z	-20.632	5.5
39	MP4B	Mx	.021	5.5
40	MP4C	X	13.394	.5
41	MP4C	Z	-23.2	.5
42	MP4C	Mx	.012	.5
43	MP4C	X	13.394	5.5
44	MP4C	Z	-23.2	5.5
45	MP4C	Mx	.012	5.5
46	MP4A	X	13.987	.5
47	MP4A	Z	-24.226	.5
48	MP4A	Mx	.017	.5
49	MP4A	X	13.987	5.5
50	MP4A	Z	-24.226	5.5
51	MP4A	Mx	.017	5.5
52	MP4B	X	11.912	.5
53	MP4B	Z	-20.632	.5
54	MP4B	Mx	.000728	.5
55	MP4B	X	11.912	5.5
56	MP4B	Z	-20.632	5.5
57	MP4B	Mx	.000728	5.5
58	MP4C	X	13.394	.5
59	MP4C	Z	-23.2	.5
60	MP4C	Mx	-.029	.5
61	MP4C	X	13.394	5.5
62	MP4C	Z	-23.2	5.5
63	MP4C	Mx	-.029	5.5
64	MP2A	X	6.288	1.88
65	MP2A	Z	-10.89	1.88
66	MP2A	Mx	-.003	1.88
67	MP2A	X	6.288	3.88
68	MP2A	Z	-10.89	3.88
69	MP2A	Mx	-.003	3.88
70	MP2B	X	3.876	1.88
71	MP2B	Z	-6.713	1.88
72	MP2B	Mx	.004	1.88
73	MP2B	X	3.876	3.88
74	MP2B	Z	-6.713	3.88
75	MP2B	Mx	.004	3.88
76	MP2C	X	5.599	1.88
77	MP2C	Z	-9.697	1.88
78	MP2C	Mx	-.004	1.88
79	MP2C	X	5.599	3.88
80	MP2C	Z	-9.697	3.88
81	MP2C	Mx	-.004	3.88
82	MP3A	X	5.709	2
83	MP3A	Z	-9.889	2
84	MP3A	Mx	.002	2
85	MP3B	X	4.295	2
86	MP3B	Z	-7.44	2
87	MP3B	Mx	-.003	2
88	MP3C	X	5.709	2
89	MP3C	Z	-9.889	2
90	MP3C	Mx	.002	2



Company :
 Designer :
 Job Number :
 Model Name :

July 6, 2023
 1:03 PM
 Checked By: _____

Member Point Loads (BLC 16 : Antenna Wi (30 Deg)) (Continued)

	Member Label	Direction	Magnitude[lb.k-ft]	Location[ft.%]
91	MP4A	X	5.625	2
92	MP4A	Z	-9.742	2
93	MP4A	Mx	.002	2
94	MP4B	X	3.956	2
95	MP4B	Z	-6.852	2
96	MP4B	Mx	-.003	2
97	MP4C	X	5.625	2
98	MP4C	Z	-9.742	2
99	MP4C	Mx	.002	2

Member Point Loads (BLC 17 : Antenna Wi (60 Deg))

	Member Label	Direction	Magnitude[lb.k-ft]	Location[ft.%]
1	MP3A	X	3.122	.5
2	MP3A	Z	-1.802	.5
3	MP3A	Mx	.002	.5
4	MP3B	X	2.231	.5
5	MP3B	Z	-1.288	.5
6	MP3B	Mx	-.001	.5
7	MP3C	X	5.765	.5
8	MP3C	Z	-3.329	.5
9	MP3C	Mx	.000578	.5
10	MP1A	X	16.501	.75
11	MP1A	Z	-9.527	.75
12	MP1A	Mx	-.008	.75
13	MP1A	X	16.501	5
14	MP1A	Z	-9.527	5
15	MP1A	Mx	-.008	5
16	MP1B	X	14.564	.75
17	MP1B	Z	-8.408	.75
18	MP1B	Mx	.008	.75
19	MP1B	X	14.564	5
20	MP1B	Z	-8.408	5
21	MP1B	Mx	.008	5
22	MP1C	X	22.253	.75
23	MP1C	Z	-12.848	.75
24	MP1C	Mx	-.002	.75
25	MP1C	X	22.253	5
26	MP1C	Z	-12.848	5
27	MP1C	Mx	-.002	5
28	MP4A	X	21.081	.5
29	MP4A	Z	-12.171	.5
30	MP4A	Mx	-.023	.5
31	MP4A	X	21.081	5.5
32	MP4A	Z	-12.171	5.5
33	MP4A	Mx	-.023	5.5
34	MP4B	X	19.557	.5
35	MP4B	Z	-11.291	.5
36	MP4B	Mx	.009	.5
37	MP4B	X	19.557	5.5
38	MP4B	Z	-11.291	5.5
39	MP4B	Mx	.009	5.5
40	MP4C	X	25.609	.5
41	MP4C	Z	-14.785	.5
42	MP4C	Mx	.027	.5
43	MP4C	X	25.609	5.5
44	MP4C	Z	-14.785	5.5



Company :
 Designer :
 Job Number :
 Model Name :

July 6, 2023
 1:03 PM
 Checked By: _____

Member Point Loads (BLC 17 : Antenna Wi (60 Deg)) (Continued)

	Member Label	Direction	Magnitude[lb.k-ft]	Location[ft.%]
45	MP4C	Mx	.027	5.5
46	MP4A	X	21.081	.5
47	MP4A	Z	-12.171	.5
48	MP4A	Mx	.002	.5
49	MP4A	X	21.081	5.5
50	MP4A	Z	-12.171	5.5
51	MP4A	Mx	.002	5.5
52	MP4B	X	19.557	.5
53	MP4B	Z	-11.291	.5
54	MP4B	Mx	.013	.5
55	MP4B	X	19.557	5.5
56	MP4B	Z	-11.291	5.5
57	MP4B	Mx	.013	5.5
58	MP4C	X	25.609	.5
59	MP4C	Z	-14.785	.5
60	MP4C	Mx	-.032	.5
61	MP4C	X	25.609	5.5
62	MP4C	Z	-14.785	5.5
63	MP4C	Mx	-.032	5.5
64	MP2A	X	7.235	1.88
65	MP2A	Z	-4.177	1.88
66	MP2A	Mx	-.004	1.88
67	MP2A	X	7.235	3.88
68	MP2A	Z	-4.177	3.88
69	MP2A	Mx	-.004	3.88
70	MP2B	X	5.462	1.88
71	MP2B	Z	-3.154	1.88
72	MP2B	Mx	.003	1.88
73	MP2B	X	5.462	3.88
74	MP2B	Z	-3.154	3.88
75	MP2B	Mx	.003	3.88
76	MP2C	X	12.498	1.88
77	MP2C	Z	-7.216	1.88
78	MP2C	Mx	-.001	1.88
79	MP2C	X	12.498	3.88
80	MP2C	Z	-7.216	3.88
81	MP2C	Mx	-.001	3.88
82	MP3A	X	8.256	2
83	MP3A	Z	-4.767	2
84	MP3A	Mx	.003	2
85	MP3B	X	8.256	2
86	MP3B	Z	-4.767	2
87	MP3B	Mx	-.003	2
88	MP3C	X	10.705	2
89	MP3C	Z	-6.181	2
90	MP3C	Mx	0	2
91	MP4A	X	7.815	2
92	MP4A	Z	-4.512	2
93	MP4A	Mx	.003	2
94	MP4B	X	7.815	2
95	MP4B	Z	-4.512	2
96	MP4B	Mx	-.003	2
97	MP4C	X	10.705	2
98	MP4C	Z	-6.181	2
99	MP4C	Mx	0	2



Company :
 Designer :
 Job Number :
 Model Name :

July 6, 2023
 1:03 PM
 Checked By: _____

Member Point Loads (BLC 18 : Antenna Wi (90 Deg))

	Member Label	Direction	Magnitude[lb.k-ft]	Location[ft.%]
1	MP3A	X	2.544	.5
2	MP3A	Z	0	.5
3	MP3A	Mx	.001	.5
4	MP3B	X	3.94	.5
5	MP3B	Z	0	.5
6	MP3B	Mx	-.002	.5
7	MP3C	X	6.289	.5
8	MP3C	Z	0	.5
9	MP3C	Mx	-.001	.5
10	MP1A	X	16.747	.75
11	MP1A	Z	0	.75
12	MP1A	Mx	-.008	.75
13	MP1A	X	16.747	5
14	MP1A	Z	0	5
15	MP1A	Mx	-.008	5
16	MP1B	X	19.782	.75
17	MP1B	Z	0	.75
18	MP1B	Mx	.008	.75
19	MP1B	X	19.782	5
20	MP1B	Z	0	5
21	MP1B	Mx	.008	5
22	MP1C	X	24.895	.75
23	MP1C	Z	0	.75
24	MP1C	Mx	.004	.75
25	MP1C	X	24.895	5
26	MP1C	Z	0	5
27	MP1C	Mx	.004	5
28	MP4A	X	22.527	.5
29	MP4A	Z	0	.5
30	MP4A	Mx	-.011	.5
31	MP4A	X	22.527	5.5
32	MP4A	Z	0	5.5
33	MP4A	Mx	-.011	5.5
34	MP4B	X	24.916	.5
35	MP4B	Z	0	.5
36	MP4B	Mx	-.004	.5
37	MP4B	X	24.916	5.5
38	MP4B	Z	0	5.5
39	MP4B	Mx	-.004	5.5
40	MP4C	X	28.94	.5
41	MP4C	Z	0	.5
42	MP4C	Mx	.032	.5
43	MP4C	X	28.94	5.5
44	MP4C	Z	0	5.5
45	MP4C	Mx	.032	5.5
46	MP4A	X	22.527	.5
47	MP4A	Z	0	.5
48	MP4A	Mx	-.011	.5
49	MP4A	X	22.527	5.5
50	MP4A	Z	0	5.5
51	MP4A	Mx	-.011	5.5
52	MP4B	X	24.916	.5
53	MP4B	Z	0	.5
54	MP4B	Mx	.024	.5
55	MP4B	X	24.916	5.5
56	MP4B	Z	0	5.5
57	MP4B	Mx	.024	5.5



Company :
 Designer :
 Job Number :
 Model Name :

July 6, 2023
 1:03 PM
 Checked By: _____

Member Point Loads (BLC 18 : Antenna Wi (90 Deg)) (Continued)

	Member Label	Direction	Magnitude[lb.k-ft]	Location[ft.%]
58	MP4C	X	28.94	.5
59	MP4C	Z	0	.5
60	MP4C	Mx	-.022	.5
61	MP4C	X	28.94	5.5
62	MP4C	Z	0	5.5
63	MP4C	Mx	-.022	5.5
64	MP2A	X	6.243	1.88
65	MP2A	Z	0	1.88
66	MP2A	Mx	-.003	1.88
67	MP2A	X	6.243	3.88
68	MP2A	Z	0	3.88
69	MP2A	Mx	-.003	3.88
70	MP2B	X	9.021	1.88
71	MP2B	Z	0	1.88
72	MP2B	Mx	.004	1.88
73	MP2B	X	9.021	3.88
74	MP2B	Z	0	3.88
75	MP2B	Mx	.004	3.88
76	MP2C	X	13.698	1.88
77	MP2C	Z	0	1.88
78	MP2C	Mx	.002	1.88
79	MP2C	X	13.698	3.88
80	MP2C	Z	0	3.88
81	MP2C	Mx	.002	3.88
82	MP3A	X	8.591	2
83	MP3A	Z	0	2
84	MP3A	Mx	.003	2
85	MP3B	X	11.419	2
86	MP3B	Z	0	2
87	MP3B	Mx	-.002	2
88	MP3C	X	11.419	2
89	MP3C	Z	0	2
90	MP3C	Mx	-.002	2
91	MP4A	X	7.912	2
92	MP4A	Z	0	2
93	MP4A	Mx	.003	2
94	MP4B	X	11.249	2
95	MP4B	Z	0	2
96	MP4B	Mx	-.002	2
97	MP4C	X	11.249	2
98	MP4C	Z	0	2
99	MP4C	Mx	-.002	2

Member Point Loads (BLC 19 : Antenna Wi (120 Deg))

	Member Label	Direction	Magnitude[lb.k-ft]	Location[ft.%]
1	MP3A	X	3.122	.5
2	MP3A	Z	1.802	.5
3	MP3A	Mx	.002	.5
4	MP3B	X	5.22	.5
5	MP3B	Z	3.014	.5
6	MP3B	Mx	-.001	.5
7	MP3C	X	3.721	.5
8	MP3C	Z	2.148	.5
9	MP3C	Mx	-.002	.5
10	MP1A	X	16.501	.75
11	MP1A	Z	9.527	.75

Member Point Loads (BLC 19 : Antenna Wi (120 Deg)) (Continued)

	Member Label	Direction	Magnitude[lb.k-ft]	Location[ft.%]
12	MP1A	Mx	-.008	.75
13	MP1A	X	16.501	5
14	MP1A	Z	9.527	5
15	MP1A	Mx	-.008	5
16	MP1B	X	21.067	.75
17	MP1B	Z	12.163	.75
18	MP1B	Mx	.005	.75
19	MP1B	X	21.067	5
20	MP1B	Z	12.163	5
21	MP1B	Mx	.005	5
22	MP1C	X	17.805	.75
23	MP1C	Z	10.28	.75
24	MP1C	Mx	.008	.75
25	MP1C	X	17.805	5
26	MP1C	Z	10.28	5
27	MP1C	Mx	.008	5
28	MP4A	X	21.081	.5
29	MP4A	Z	12.171	.5
30	MP4A	Mx	.002	.5
31	MP4A	X	21.081	5.5
32	MP4A	Z	12.171	5.5
33	MP4A	Mx	.002	5.5
34	MP4B	X	24.675	.5
35	MP4B	Z	14.246	.5
36	MP4B	Mx	-.02	.5
37	MP4B	X	24.675	5.5
38	MP4B	Z	14.246	5.5
39	MP4B	Mx	-.02	5.5
40	MP4C	X	22.108	.5
41	MP4C	Z	12.764	.5
42	MP4C	Mx	.026	.5
43	MP4C	X	22.108	5.5
44	MP4C	Z	12.764	5.5
45	MP4C	Mx	.026	5.5
46	MP4A	X	21.081	.5
47	MP4A	Z	12.171	.5
48	MP4A	Mx	-.023	.5
49	MP4A	X	21.081	5.5
50	MP4A	Z	12.171	5.5
51	MP4A	Mx	-.023	5.5
52	MP4B	X	24.675	.5
53	MP4B	Z	14.246	.5
54	MP4B	Mx	.032	.5
55	MP4B	X	24.675	5.5
56	MP4B	Z	14.246	5.5
57	MP4B	Mx	.032	5.5
58	MP4C	X	22.108	.5
59	MP4C	Z	12.764	.5
60	MP4C	Mx	-.007	.5
61	MP4C	X	22.108	5.5
62	MP4C	Z	12.764	5.5
63	MP4C	Mx	-.007	5.5
64	MP2A	X	7.235	1.88
65	MP2A	Z	4.177	1.88
66	MP2A	Mx	-.004	1.88
67	MP2A	X	7.235	3.88
68	MP2A	Z	4.177	3.88

Member Point Loads (BLC 19 : Antenna Wi (120 Deg)) (Continued)

	Member Label	Direction	Magnitude[lb.k-ft]	Location[ft.%]
69	MP2A	Mx	-.004	3.88
70	MP2B	X	11.412	1.88
71	MP2B	Z	6.589	1.88
72	MP2B	Mx	.003	1.88
73	MP2B	X	11.412	3.88
74	MP2B	Z	6.589	3.88
75	MP2B	Mx	.003	3.88
76	MP2C	X	8.428	1.88
77	MP2C	Z	4.866	1.88
78	MP2C	Mx	.004	1.88
79	MP2C	X	8.428	3.88
80	MP2C	Z	4.866	3.88
81	MP2C	Mx	.004	3.88
82	MP3A	X	8.256	2
83	MP3A	Z	4.767	2
84	MP3A	Mx	.003	2
85	MP3B	X	10.705	2
86	MP3B	Z	6.181	2
87	MP3B	Mx	0	2
88	MP3C	X	8.256	2
89	MP3C	Z	4.767	2
90	MP3C	Mx	-.003	2
91	MP4A	X	7.815	2
92	MP4A	Z	4.512	2
93	MP4A	Mx	.003	2
94	MP4B	X	10.705	2
95	MP4B	Z	6.181	2
96	MP4B	Mx	0	2
97	MP4C	X	7.815	2
98	MP4C	Z	4.512	2
99	MP4C	Mx	-.003	2

Member Point Loads (BLC 20 : Antenna Wi (150 Deg))

	Member Label	Direction	Magnitude[lb.k-ft]	Location[ft.%]
1	MP3A	X	2.863	.5
2	MP3A	Z	4.958	.5
3	MP3A	Mx	.001	.5
4	MP3B	X	3.377	.5
5	MP3B	Z	5.848	.5
6	MP3B	Mx	.000294	.5
7	MP3C	X	1.336	.5
8	MP3C	Z	2.314	.5
9	MP3C	Mx	-.001	.5
10	MP1A	X	11.834	.75
11	MP1A	Z	20.496	.75
12	MP1A	Mx	-.006	.75
13	MP1A	X	11.834	5
14	MP1A	Z	20.496	5
15	MP1A	Mx	-.006	5
16	MP1B	X	12.952	.75
17	MP1B	Z	22.434	.75
18	MP1B	Mx	-.001	.75
19	MP1B	X	12.952	5
20	MP1B	Z	22.434	5
21	MP1B	Mx	-.001	5
22	MP1C	X	8.512	.75



Company :
 Designer :
 Job Number :
 Model Name :

July 6, 2023
 1:03 PM
 Checked By: _____

Member Point Loads (BLC 20 : Antenna Wi (150 Deg)) (Continued)

	Member Label	Direction	Magnitude[lb.k-ft]	Location[ft.%]
23	MP1C	Z	14.744	.75
24	MP1C	Mx	.008	.75
25	MP1C	X	8.512	5
26	MP1C	Z	14.744	5
27	MP1C	Mx	.008	5
28	MP4A	X	13.987	.5
29	MP4A	Z	24.226	.5
30	MP4A	Mx	.017	.5
31	MP4A	X	13.987	5.5
32	MP4A	Z	24.226	5.5
33	MP4A	Mx	.017	5.5
34	MP4B	X	14.867	.5
35	MP4B	Z	25.751	.5
36	MP4B	Mx	-.031	.5
37	MP4B	X	14.867	5.5
38	MP4B	Z	25.751	5.5
39	MP4B	Mx	-.031	5.5
40	MP4C	X	11.373	.5
41	MP4C	Z	19.698	.5
42	MP4C	Mx	.015	.5
43	MP4C	X	11.373	5.5
44	MP4C	Z	19.698	5.5
45	MP4C	Mx	.015	5.5
46	MP4A	X	13.987	.5
47	MP4A	Z	24.226	.5
48	MP4A	Mx	-.031	.5
49	MP4A	X	13.987	5.5
50	MP4A	Z	24.226	5.5
51	MP4A	Mx	-.031	5.5
52	MP4B	X	14.867	.5
53	MP4B	Z	25.751	.5
54	MP4B	Mx	.028	.5
55	MP4B	X	14.867	5.5
56	MP4B	Z	25.751	5.5
57	MP4B	Mx	.028	5.5
58	MP4C	X	11.373	.5
59	MP4C	Z	19.698	.5
60	MP4C	Mx	.007	.5
61	MP4C	X	11.373	5.5
62	MP4C	Z	19.698	5.5
63	MP4C	Mx	.007	5.5
64	MP2A	X	6.288	1.88
65	MP2A	Z	10.89	1.88
66	MP2A	Mx	-.003	1.88
67	MP2A	X	6.288	3.88
68	MP2A	Z	10.89	3.88
69	MP2A	Mx	-.003	3.88
70	MP2B	X	7.311	1.88
71	MP2B	Z	12.663	1.88
72	MP2B	Mx	-.000637	1.88
73	MP2B	X	7.311	3.88
74	MP2B	Z	12.663	3.88
75	MP2B	Mx	-.000637	3.88
76	MP2C	X	3.249	1.88
77	MP2C	Z	5.627	1.88
78	MP2C	Mx	.003	1.88
79	MP2C	X	3.249	3.88

Member Point Loads (BLC 20 : Antenna Wi (150 Deg)) (Continued)

	Member Label	Direction	Magnitude[lb.k-ft]	Location[ft.%]
80	MP2C	Z	5.627	3.88
81	MP2C	Mx	.003	3.88
82	MP3A	X	5.709	2
83	MP3A	Z	9.889	2
84	MP3A	Mx	.002	2
85	MP3B	X	5.709	2
86	MP3B	Z	9.889	2
87	MP3B	Mx	.002	2
88	MP3C	X	4.295	2
89	MP3C	Z	7.44	2
90	MP3C	Mx	-.003	2
91	MP4A	X	5.625	2
92	MP4A	Z	9.742	2
93	MP4A	Mx	.002	2
94	MP4B	X	5.625	2
95	MP4B	Z	9.742	2
96	MP4B	Mx	.002	2
97	MP4C	X	3.956	2
98	MP4C	Z	6.852	2
99	MP4C	Mx	-.003	2

Member Point Loads (BLC 21 : Antenna Wi (180 Deg))

	Member Label	Direction	Magnitude[lb.k-ft]	Location[ft.%]
1	MP3A	X	0	.5
2	MP3A	Z	6.785	.5
3	MP3A	Mx	0	.5
4	MP3B	X	0	.5
5	MP3B	Z	5.39	.5
6	MP3B	Mx	.002	.5
7	MP3C	X	0	.5
8	MP3C	Z	3.04	.5
9	MP3C	Mx	-.001	.5
10	MP1A	X	0	.75
11	MP1A	Z	25.974	.75
12	MP1A	Mx	0	.75
13	MP1A	X	0	5
14	MP1A	Z	25.974	5
15	MP1A	Mx	0	5
16	MP1B	X	0	.75
17	MP1B	Z	22.938	.75
18	MP1B	Mx	-.007	.75
19	MP1B	X	0	5
20	MP1B	Z	22.938	5
21	MP1B	Mx	-.007	5
22	MP1C	X	0	.75
23	MP1C	Z	17.826	.75
24	MP1C	Mx	.008	.75
25	MP1C	X	0	5
26	MP1C	Z	17.826	5
27	MP1C	Mx	.008	5
28	MP4A	X	0	.5
29	MP4A	Z	29.79	.5
30	MP4A	Mx	.03	.5
31	MP4A	X	0	5.5
32	MP4A	Z	29.79	5.5
33	MP4A	Mx	.03	5.5



Company :
 Designer :
 Job Number :
 Model Name :

July 6, 2023
 1:03 PM
 Checked By: _____

Member Point Loads (BLC 21 : Antenna Wi (180 Deg)) (Continued)

	Member Label	Direction	Magnitude[lb.k-ft]	Location[ft.%]
34	MP4B	X	0	.5
35	MP4B	Z	27.4	.5
36	MP4B	Mx	-.03	.5
37	MP4B	X	0	5.5
38	MP4B	Z	27.4	5.5
39	MP4B	Mx	-.03	5.5
40	MP4C	X	0	.5
41	MP4C	Z	23.376	.5
42	MP4C	Mx	.003	.5
43	MP4C	X	0	5.5
44	MP4C	Z	23.376	5.5
45	MP4C	Mx	.003	5.5
46	MP4A	X	0	.5
47	MP4A	Z	29.79	.5
48	MP4A	Mx	-.03	.5
49	MP4A	X	0	5.5
50	MP4A	Z	29.79	5.5
51	MP4A	Mx	-.03	5.5
52	MP4B	X	0	.5
53	MP4B	Z	27.4	.5
54	MP4B	Mx	.015	.5
55	MP4B	X	0	5.5
56	MP4B	Z	27.4	5.5
57	MP4B	Mx	.015	5.5
58	MP4C	X	0	.5
59	MP4C	Z	23.376	.5
60	MP4C	Mx	.019	.5
61	MP4C	X	0	5.5
62	MP4C	Z	23.376	5.5
63	MP4C	Mx	.019	5.5
64	MP2A	X	0	1.88
65	MP2A	Z	14.686	1.88
66	MP2A	Mx	0	1.88
67	MP2A	X	0	3.88
68	MP2A	Z	14.686	3.88
69	MP2A	Mx	0	3.88
70	MP2B	X	0	1.88
71	MP2B	Z	11.908	1.88
72	MP2B	Mx	-.003	1.88
73	MP2B	X	0	3.88
74	MP2B	Z	11.908	3.88
75	MP2B	Mx	-.003	3.88
76	MP2C	X	0	1.88
77	MP2C	Z	7.231	1.88
78	MP2C	Mx	.003	1.88
79	MP2C	X	0	3.88
80	MP2C	Z	7.231	3.88
81	MP2C	Mx	.003	3.88
82	MP3A	X	0	2
83	MP3A	Z	12.362	2
84	MP3A	Mx	0	2
85	MP3B	X	0	2
86	MP3B	Z	9.534	2
87	MP3B	Mx	.003	2
88	MP3C	X	0	2
89	MP3C	Z	9.534	2
90	MP3C	Mx	-.003	2



Company :
 Designer :
 Job Number :
 Model Name :

July 6, 2023
 1:03 PM
 Checked By: _____

Member Point Loads (BLC 21 : Antenna Wi (180 Deg)) (Continued)

	Member Label	Direction	Magnitude[lb.k-ft]	Location[ft.%]
91	MP4A	X	0	2
92	MP4A	Z	12.362	2
93	MP4A	Mx	0	2
94	MP4B	X	0	2
95	MP4B	Z	9.025	2
96	MP4B	Mx	.003	2
97	MP4C	X	0	2
98	MP4C	Z	9.025	2
99	MP4C	Mx	-.003	2

Member Point Loads (BLC 22 : Antenna Wi (210 Deg))

	Member Label	Direction	Magnitude[lb.k-ft]	Location[ft.%]
1	MP3A	X	-2.863	.5
2	MP3A	Z	4.958	.5
3	MP3A	Mx	-.001	.5
4	MP3B	X	-1.651	.5
5	MP3B	Z	2.859	.5
6	MP3B	Mx	.001	.5
7	MP3C	X	-2.517	.5
8	MP3C	Z	4.359	.5
9	MP3C	Mx	-.002	.5
10	MP1A	X	-11.834	.75
11	MP1A	Z	20.496	.75
12	MP1A	Mx	.006	.75
13	MP1A	X	-11.834	5
14	MP1A	Z	20.496	5
15	MP1A	Mx	.006	5
16	MP1B	X	-9.197	.75
17	MP1B	Z	15.93	.75
18	MP1B	Mx	-.008	.75
19	MP1B	X	-9.197	5
20	MP1B	Z	15.93	5
21	MP1B	Mx	-.008	5
22	MP1C	X	-11.081	.75
23	MP1C	Z	19.192	.75
24	MP1C	Mx	.007	.75
25	MP1C	X	-11.081	5
26	MP1C	Z	19.192	5
27	MP1C	Mx	.007	5
28	MP4A	X	-13.987	.5
29	MP4A	Z	24.226	.5
30	MP4A	Mx	.031	.5
31	MP4A	X	-13.987	5.5
32	MP4A	Z	24.226	5.5
33	MP4A	Mx	.031	5.5
34	MP4B	X	-11.912	.5
35	MP4B	Z	20.632	.5
36	MP4B	Mx	-.021	.5
37	MP4B	X	-11.912	5.5
38	MP4B	Z	20.632	5.5
39	MP4B	Mx	-.021	5.5
40	MP4C	X	-13.394	.5
41	MP4C	Z	23.2	.5
42	MP4C	Mx	-.012	.5
43	MP4C	X	-13.394	5.5
44	MP4C	Z	23.2	5.5



Company :
 Designer :
 Job Number :
 Model Name :

July 6, 2023
 1:03 PM
 Checked By: _____

Member Point Loads (BLC 22 : Antenna Wi (210 Deg)) (Continued)

	Member Label	Direction	Magnitude[lb.k-ft]	Location[ft.%]
45	MP4C	Mx	-.012	5.5
46	MP4A	X	-13.987	.5
47	MP4A	Z	24.226	.5
48	MP4A	Mx	-.017	.5
49	MP4A	X	-13.987	5.5
50	MP4A	Z	24.226	5.5
51	MP4A	Mx	-.017	5.5
52	MP4B	X	-11.912	.5
53	MP4B	Z	20.632	.5
54	MP4B	Mx	-.000728	.5
55	MP4B	X	-11.912	5.5
56	MP4B	Z	20.632	5.5
57	MP4B	Mx	-.000728	5.5
58	MP4C	X	-13.394	.5
59	MP4C	Z	23.2	.5
60	MP4C	Mx	.029	.5
61	MP4C	X	-13.394	5.5
62	MP4C	Z	23.2	5.5
63	MP4C	Mx	.029	5.5
64	MP2A	X	-6.288	1.88
65	MP2A	Z	10.89	1.88
66	MP2A	Mx	.003	1.88
67	MP2A	X	-6.288	3.88
68	MP2A	Z	10.89	3.88
69	MP2A	Mx	.003	3.88
70	MP2B	X	-3.876	1.88
71	MP2B	Z	6.713	1.88
72	MP2B	Mx	-.004	1.88
73	MP2B	X	-3.876	3.88
74	MP2B	Z	6.713	3.88
75	MP2B	Mx	-.004	3.88
76	MP2C	X	-5.599	1.88
77	MP2C	Z	9.697	1.88
78	MP2C	Mx	.004	1.88
79	MP2C	X	-5.599	3.88
80	MP2C	Z	9.697	3.88
81	MP2C	Mx	.004	3.88
82	MP3A	X	-5.709	2
83	MP3A	Z	9.889	2
84	MP3A	Mx	-.002	2
85	MP3B	X	-4.295	2
86	MP3B	Z	7.44	2
87	MP3B	Mx	.003	2
88	MP3C	X	-5.709	2
89	MP3C	Z	9.889	2
90	MP3C	Mx	-.002	2
91	MP4A	X	-5.625	2
92	MP4A	Z	9.742	2
93	MP4A	Mx	-.002	2
94	MP4B	X	-3.956	2
95	MP4B	Z	6.852	2
96	MP4B	Mx	.003	2
97	MP4C	X	-5.625	2
98	MP4C	Z	9.742	2
99	MP4C	Mx	-.002	2



Company :
 Designer :
 Job Number :
 Model Name :

July 6, 2023
 1:03 PM
 Checked By: _____

Member Point Loads (BLC 23 : Antenna Wi (240 Deg))

	Member Label	Direction	Magnitude[lb.k-ft]	Location[ft.%]
1	MP3A	X	-3.122	.5
2	MP3A	Z	1.802	.5
3	MP3A	Mx	-.002	.5
4	MP3B	X	-2.231	.5
5	MP3B	Z	1.288	.5
6	MP3B	Mx	.001	.5
7	MP3C	X	-5.765	.5
8	MP3C	Z	3.329	.5
9	MP3C	Mx	-.000578	.5
10	MP1A	X	-16.501	.75
11	MP1A	Z	9.527	.75
12	MP1A	Mx	.008	.75
13	MP1A	X	-16.501	5
14	MP1A	Z	9.527	5
15	MP1A	Mx	.008	5
16	MP1B	X	-14.564	.75
17	MP1B	Z	8.408	.75
18	MP1B	Mx	-.008	.75
19	MP1B	X	-14.564	5
20	MP1B	Z	8.408	5
21	MP1B	Mx	-.008	5
22	MP1C	X	-22.253	.75
23	MP1C	Z	12.848	.75
24	MP1C	Mx	.002	.75
25	MP1C	X	-22.253	5
26	MP1C	Z	12.848	5
27	MP1C	Mx	.002	5
28	MP4A	X	-21.081	.5
29	MP4A	Z	12.171	.5
30	MP4A	Mx	.023	.5
31	MP4A	X	-21.081	5.5
32	MP4A	Z	12.171	5.5
33	MP4A	Mx	.023	5.5
34	MP4B	X	-19.557	.5
35	MP4B	Z	11.291	.5
36	MP4B	Mx	-.009	.5
37	MP4B	X	-19.557	5.5
38	MP4B	Z	11.291	5.5
39	MP4B	Mx	-.009	5.5
40	MP4C	X	-25.609	.5
41	MP4C	Z	14.785	.5
42	MP4C	Mx	-.027	.5
43	MP4C	X	-25.609	5.5
44	MP4C	Z	14.785	5.5
45	MP4C	Mx	-.027	5.5
46	MP4A	X	-21.081	.5
47	MP4A	Z	12.171	.5
48	MP4A	Mx	-.002	.5
49	MP4A	X	-21.081	5.5
50	MP4A	Z	12.171	5.5
51	MP4A	Mx	-.002	5.5
52	MP4B	X	-19.557	.5
53	MP4B	Z	11.291	.5
54	MP4B	Mx	-.013	.5
55	MP4B	X	-19.557	5.5
56	MP4B	Z	11.291	5.5
57	MP4B	Mx	-.013	5.5



Company :
 Designer :
 Job Number :
 Model Name :

July 6, 2023
 1:03 PM
 Checked By: _____

Member Point Loads (BLC 23 : Antenna Wi (240 Deg)) (Continued)

	Member Label	Direction	Magnitude[lb.k-ft]	Location[ft.%]
58	MP4C	X	-25.609	.5
59	MP4C	Z	14.785	.5
60	MP4C	Mx	.032	.5
61	MP4C	X	-25.609	5.5
62	MP4C	Z	14.785	5.5
63	MP4C	Mx	.032	5.5
64	MP2A	X	-7.235	1.88
65	MP2A	Z	4.177	1.88
66	MP2A	Mx	.004	1.88
67	MP2A	X	-7.235	3.88
68	MP2A	Z	4.177	3.88
69	MP2A	Mx	.004	3.88
70	MP2B	X	-5.462	1.88
71	MP2B	Z	3.154	1.88
72	MP2B	Mx	-.003	1.88
73	MP2B	X	-5.462	3.88
74	MP2B	Z	3.154	3.88
75	MP2B	Mx	-.003	3.88
76	MP2C	X	-12.498	1.88
77	MP2C	Z	7.216	1.88
78	MP2C	Mx	.001	1.88
79	MP2C	X	-12.498	3.88
80	MP2C	Z	7.216	3.88
81	MP2C	Mx	.001	3.88
82	MP3A	X	-8.256	2
83	MP3A	Z	4.767	2
84	MP3A	Mx	-.003	2
85	MP3B	X	-8.256	2
86	MP3B	Z	4.767	2
87	MP3B	Mx	.003	2
88	MP3C	X	-10.705	2
89	MP3C	Z	6.181	2
90	MP3C	Mx	0	2
91	MP4A	X	-7.815	2
92	MP4A	Z	4.512	2
93	MP4A	Mx	-.003	2
94	MP4B	X	-7.815	2
95	MP4B	Z	4.512	2
96	MP4B	Mx	.003	2
97	MP4C	X	-10.705	2
98	MP4C	Z	6.181	2
99	MP4C	Mx	0	2

Member Point Loads (BLC 24 : Antenna Wi (270 Deg))

	Member Label	Direction	Magnitude[lb.k-ft]	Location[ft.%]
1	MP3A	X	-2.544	.5
2	MP3A	Z	0	.5
3	MP3A	Mx	-.001	.5
4	MP3B	X	-3.94	.5
5	MP3B	Z	0	.5
6	MP3B	Mx	.002	.5
7	MP3C	X	-6.289	.5
8	MP3C	Z	0	.5
9	MP3C	Mx	.001	.5
10	MP1A	X	-16.747	.75
11	MP1A	Z	0	.75

Member Point Loads (BLC 24 : Antenna Wi (270 Deg)) (Continued)

	Member Label	Direction	Magnitude[lb.k-ft]	Location[ft.%]
12	MP1A	Mx	.008	.75
13	MP1A	X	-16.747	5
14	MP1A	Z	0	5
15	MP1A	Mx	.008	5
16	MP1B	X	-19.782	.75
17	MP1B	Z	0	.75
18	MP1B	Mx	-.008	.75
19	MP1B	X	-19.782	5
20	MP1B	Z	0	5
21	MP1B	Mx	-.008	5
22	MP1C	X	-24.895	.75
23	MP1C	Z	0	.75
24	MP1C	Mx	-.004	.75
25	MP1C	X	-24.895	5
26	MP1C	Z	0	5
27	MP1C	Mx	-.004	5
28	MP4A	X	-22.527	.5
29	MP4A	Z	0	.5
30	MP4A	Mx	.011	.5
31	MP4A	X	-22.527	5.5
32	MP4A	Z	0	5.5
33	MP4A	Mx	.011	5.5
34	MP4B	X	-24.916	.5
35	MP4B	Z	0	.5
36	MP4B	Mx	.004	.5
37	MP4B	X	-24.916	5.5
38	MP4B	Z	0	5.5
39	MP4B	Mx	.004	5.5
40	MP4C	X	-28.94	.5
41	MP4C	Z	0	.5
42	MP4C	Mx	-.032	.5
43	MP4C	X	-28.94	5.5
44	MP4C	Z	0	5.5
45	MP4C	Mx	-.032	5.5
46	MP4A	X	-22.527	.5
47	MP4A	Z	0	.5
48	MP4A	Mx	.011	.5
49	MP4A	X	-22.527	5.5
50	MP4A	Z	0	5.5
51	MP4A	Mx	.011	5.5
52	MP4B	X	-24.916	.5
53	MP4B	Z	0	.5
54	MP4B	Mx	-.024	.5
55	MP4B	X	-24.916	5.5
56	MP4B	Z	0	5.5
57	MP4B	Mx	-.024	5.5
58	MP4C	X	-28.94	.5
59	MP4C	Z	0	.5
60	MP4C	Mx	.022	.5
61	MP4C	X	-28.94	5.5
62	MP4C	Z	0	5.5
63	MP4C	Mx	.022	5.5
64	MP2A	X	-6.243	1.88
65	MP2A	Z	0	1.88
66	MP2A	Mx	.003	1.88
67	MP2A	X	-6.243	3.88
68	MP2A	Z	0	3.88

Member Point Loads (BLC 24 : Antenna Wi (270 Deg)) (Continued)

	Member Label	Direction	Magnitude[lb.k-ft]	Location[ft.%]
69	MP2A	Mx	.003	3.88
70	MP2B	X	-9.021	1.88
71	MP2B	Z	0	1.88
72	MP2B	Mx	-.004	1.88
73	MP2B	X	-9.021	3.88
74	MP2B	Z	0	3.88
75	MP2B	Mx	-.004	3.88
76	MP2C	X	-13.698	1.88
77	MP2C	Z	0	1.88
78	MP2C	Mx	-.002	1.88
79	MP2C	X	-13.698	3.88
80	MP2C	Z	0	3.88
81	MP2C	Mx	-.002	3.88
82	MP3A	X	-8.591	2
83	MP3A	Z	0	2
84	MP3A	Mx	-.003	2
85	MP3B	X	-11.419	2
86	MP3B	Z	0	2
87	MP3B	Mx	.002	2
88	MP3C	X	-11.419	2
89	MP3C	Z	0	2
90	MP3C	Mx	.002	2
91	MP4A	X	-7.912	2
92	MP4A	Z	0	2
93	MP4A	Mx	-.003	2
94	MP4B	X	-11.249	2
95	MP4B	Z	0	2
96	MP4B	Mx	.002	2
97	MP4C	X	-11.249	2
98	MP4C	Z	0	2
99	MP4C	Mx	.002	2

Member Point Loads (BLC 25 : Antenna Wi (300 Deg))

	Member Label	Direction	Magnitude[lb.k-ft]	Location[ft.%]
1	MP3A	X	-3.122	.5
2	MP3A	Z	-1.802	.5
3	MP3A	Mx	-.002	.5
4	MP3B	X	-5.22	.5
5	MP3B	Z	-3.014	.5
6	MP3B	Mx	.001	.5
7	MP3C	X	-3.721	.5
8	MP3C	Z	-2.148	.5
9	MP3C	Mx	.002	.5
10	MP1A	X	-16.501	.75
11	MP1A	Z	-9.527	.75
12	MP1A	Mx	.008	.75
13	MP1A	X	-16.501	5
14	MP1A	Z	-9.527	5
15	MP1A	Mx	.008	5
16	MP1B	X	-21.067	.75
17	MP1B	Z	-12.163	.75
18	MP1B	Mx	-.005	.75
19	MP1B	X	-21.067	5
20	MP1B	Z	-12.163	5
21	MP1B	Mx	-.005	5
22	MP1C	X	-17.805	.75

Member Point Loads (BLC 25 : Antenna Wi (300 Deg)) (Continued)

	Member Label	Direction	Magnitude[lb.k-ft]	Location[ft.%]
23	MP1C	Z	-10.28	.75
24	MP1C	Mx	-.008	.75
25	MP1C	X	-17.805	5
26	MP1C	Z	-10.28	5
27	MP1C	Mx	-.008	5
28	MP4A	X	-21.081	.5
29	MP4A	Z	-12.171	.5
30	MP4A	Mx	-.002	.5
31	MP4A	X	-21.081	5.5
32	MP4A	Z	-12.171	5.5
33	MP4A	Mx	-.002	5.5
34	MP4B	X	-24.675	.5
35	MP4B	Z	-14.246	.5
36	MP4B	Mx	.02	.5
37	MP4B	X	-24.675	5.5
38	MP4B	Z	-14.246	5.5
39	MP4B	Mx	.02	5.5
40	MP4C	X	-22.108	.5
41	MP4C	Z	-12.764	.5
42	MP4C	Mx	-.026	.5
43	MP4C	X	-22.108	5.5
44	MP4C	Z	-12.764	5.5
45	MP4C	Mx	-.026	5.5
46	MP4A	X	-21.081	.5
47	MP4A	Z	-12.171	.5
48	MP4A	Mx	.023	.5
49	MP4A	X	-21.081	5.5
50	MP4A	Z	-12.171	5.5
51	MP4A	Mx	.023	5.5
52	MP4B	X	-24.675	.5
53	MP4B	Z	-14.246	.5
54	MP4B	Mx	-.032	.5
55	MP4B	X	-24.675	5.5
56	MP4B	Z	-14.246	5.5
57	MP4B	Mx	-.032	5.5
58	MP4C	X	-22.108	.5
59	MP4C	Z	-12.764	.5
60	MP4C	Mx	.007	.5
61	MP4C	X	-22.108	5.5
62	MP4C	Z	-12.764	5.5
63	MP4C	Mx	.007	5.5
64	MP2A	X	-7.235	1.88
65	MP2A	Z	-4.177	1.88
66	MP2A	Mx	.004	1.88
67	MP2A	X	-7.235	3.88
68	MP2A	Z	-4.177	3.88
69	MP2A	Mx	.004	3.88
70	MP2B	X	-11.412	1.88
71	MP2B	Z	-6.589	1.88
72	MP2B	Mx	-.003	1.88
73	MP2B	X	-11.412	3.88
74	MP2B	Z	-6.589	3.88
75	MP2B	Mx	-.003	3.88
76	MP2C	X	-8.428	1.88
77	MP2C	Z	-4.866	1.88
78	MP2C	Mx	-.004	1.88
79	MP2C	X	-8.428	3.88



Company :
 Designer :
 Job Number :
 Model Name :

July 6, 2023
 1:03 PM
 Checked By: _____

Member Point Loads (BLC 25 : Antenna Wi (300 Deg)) (Continued)

	Member Label	Direction	Magnitude[lb.k-ft]	Location[ft.%]
80	MP2C	Z	-4.866	3.88
81	MP2C	Mx	-.004	3.88
82	MP3A	X	-8.256	2
83	MP3A	Z	-4.767	2
84	MP3A	Mx	-.003	2
85	MP3B	X	-10.705	2
86	MP3B	Z	-6.181	2
87	MP3B	Mx	0	2
88	MP3C	X	-8.256	2
89	MP3C	Z	-4.767	2
90	MP3C	Mx	.003	2
91	MP4A	X	-7.815	2
92	MP4A	Z	-4.512	2
93	MP4A	Mx	-.003	2
94	MP4B	X	-10.705	2
95	MP4B	Z	-6.181	2
96	MP4B	Mx	0	2
97	MP4C	X	-7.815	2
98	MP4C	Z	-4.512	2
99	MP4C	Mx	.003	2

Member Point Loads (BLC 26 : Antenna Wi (330 Deg))

	Member Label	Direction	Magnitude[lb.k-ft]	Location[ft.%]
1	MP3A	X	-2.863	.5
2	MP3A	Z	-4.958	.5
3	MP3A	Mx	-.001	.5
4	MP3B	X	-3.377	.5
5	MP3B	Z	-5.848	.5
6	MP3B	Mx	-.000294	.5
7	MP3C	X	-1.336	.5
8	MP3C	Z	-2.314	.5
9	MP3C	Mx	.001	.5
10	MP1A	X	-11.834	.75
11	MP1A	Z	-20.496	.75
12	MP1A	Mx	.006	.75
13	MP1A	X	-11.834	5
14	MP1A	Z	-20.496	5
15	MP1A	Mx	.006	5
16	MP1B	X	-12.952	.75
17	MP1B	Z	-22.434	.75
18	MP1B	Mx	.001	.75
19	MP1B	X	-12.952	5
20	MP1B	Z	-22.434	5
21	MP1B	Mx	.001	5
22	MP1C	X	-8.512	.75
23	MP1C	Z	-14.744	.75
24	MP1C	Mx	-.008	.75
25	MP1C	X	-8.512	5
26	MP1C	Z	-14.744	5
27	MP1C	Mx	-.008	5
28	MP4A	X	-13.987	.5
29	MP4A	Z	-24.226	.5
30	MP4A	Mx	-.017	.5
31	MP4A	X	-13.987	5.5
32	MP4A	Z	-24.226	5.5
33	MP4A	Mx	-.017	5.5



Company :
 Designer :
 Job Number :
 Model Name :

July 6, 2023
 1:03 PM
 Checked By: _____

Member Point Loads (BLC 26 : Antenna Wi (330 Deg)) (Continued)

	Member Label	Direction	Magnitude[lb.k-ft]	Location[ft.%]
34	MP4B	X	-14.867	.5
35	MP4B	Z	-25.751	.5
36	MP4B	Mx	.031	.5
37	MP4B	X	-14.867	5.5
38	MP4B	Z	-25.751	5.5
39	MP4B	Mx	.031	5.5
40	MP4C	X	-11.373	.5
41	MP4C	Z	-19.698	.5
42	MP4C	Mx	-.015	.5
43	MP4C	X	-11.373	5.5
44	MP4C	Z	-19.698	5.5
45	MP4C	Mx	-.015	5.5
46	MP4A	X	-13.987	.5
47	MP4A	Z	-24.226	.5
48	MP4A	Mx	.031	.5
49	MP4A	X	-13.987	5.5
50	MP4A	Z	-24.226	5.5
51	MP4A	Mx	.031	5.5
52	MP4B	X	-14.867	.5
53	MP4B	Z	-25.751	.5
54	MP4B	Mx	-.028	.5
55	MP4B	X	-14.867	5.5
56	MP4B	Z	-25.751	5.5
57	MP4B	Mx	-.028	5.5
58	MP4C	X	-11.373	.5
59	MP4C	Z	-19.698	.5
60	MP4C	Mx	-.007	.5
61	MP4C	X	-11.373	5.5
62	MP4C	Z	-19.698	5.5
63	MP4C	Mx	-.007	5.5
64	MP2A	X	-6.288	1.88
65	MP2A	Z	-10.89	1.88
66	MP2A	Mx	.003	1.88
67	MP2A	X	-6.288	3.88
68	MP2A	Z	-10.89	3.88
69	MP2A	Mx	.003	3.88
70	MP2B	X	-7.311	1.88
71	MP2B	Z	-12.663	1.88
72	MP2B	Mx	.000637	1.88
73	MP2B	X	-7.311	3.88
74	MP2B	Z	-12.663	3.88
75	MP2B	Mx	.000637	3.88
76	MP2C	X	-3.249	1.88
77	MP2C	Z	-5.627	1.88
78	MP2C	Mx	-.003	1.88
79	MP2C	X	-3.249	3.88
80	MP2C	Z	-5.627	3.88
81	MP2C	Mx	-.003	3.88
82	MP3A	X	-5.709	2
83	MP3A	Z	-9.889	2
84	MP3A	Mx	-.002	2
85	MP3B	X	-5.709	2
86	MP3B	Z	-9.889	2
87	MP3B	Mx	-.002	2
88	MP3C	X	-4.295	2
89	MP3C	Z	-7.44	2
90	MP3C	Mx	.003	2



Company :
 Designer :
 Job Number :
 Model Name :

July 6, 2023
 1:03 PM
 Checked By: _____

Member Point Loads (BLC 26 : Antenna Wi (330 Deg)) (Continued)

	Member Label	Direction	Magnitude[lb.k-ft]	Location[ft.%]
91	MP4A	X	-5.625	2
92	MP4A	Z	-9.742	2
93	MP4A	Mx	-.002	2
94	MP4B	X	-5.625	2
95	MP4B	Z	-9.742	2
96	MP4B	Mx	-.002	2
97	MP4C	X	-3.956	2
98	MP4C	Z	-6.852	2
99	MP4C	Mx	.003	2

Member Point Loads (BLC 27 : Antenna Wm (0 Deg))

	Member Label	Direction	Magnitude[lb.k-ft]	Location[ft.%]
1	MP3A	X	0	.5
2	MP3A	Z	-1.917	.5
3	MP3A	Mx	0	.5
4	MP3B	X	0	.5
5	MP3B	Z	-1.478	.5
6	MP3B	Mx	-.000424	.5
7	MP3C	X	0	.5
8	MP3C	Z	-.738	.5
9	MP3C	Mx	.000347	.5
10	MP1A	X	0	.75
11	MP1A	Z	-8.536	.75
12	MP1A	Mx	0	.75
13	MP1A	X	0	5
14	MP1A	Z	-8.536	5
15	MP1A	Mx	0	5
16	MP1B	X	0	.75
17	MP1B	Z	-7.45	.75
18	MP1B	Mx	.002	.75
19	MP1B	X	0	5
20	MP1B	Z	-7.45	5
21	MP1B	Mx	.002	5
22	MP1C	X	0	.75
23	MP1C	Z	-5.621	.75
24	MP1C	Mx	-.003	.75
25	MP1C	X	0	5
26	MP1C	Z	-5.621	5
27	MP1C	Mx	-.003	5
28	MP4A	X	0	.5
29	MP4A	Z	-4.722	.5
30	MP4A	Mx	-.005	.5
31	MP4A	X	0	5.5
32	MP4A	Z	-4.722	5.5
33	MP4A	Mx	-.005	5.5
34	MP4B	X	0	.5
35	MP4B	Z	-4.331	.5
36	MP4B	Mx	.005	.5
37	MP4B	X	0	5.5
38	MP4B	Z	-4.331	5.5
39	MP4B	Mx	.005	5.5
40	MP4C	X	0	.5
41	MP4C	Z	-3.673	.5
42	MP4C	Mx	-.00047	.5
43	MP4C	X	0	5.5
44	MP4C	Z	-3.673	5.5



Company :
 Designer :
 Job Number :
 Model Name :

July 6, 2023
 1:03 PM
 Checked By: _____

Member Point Loads (BLC 27 : Antenna Wm (0 Deg)) (Continued)

	Member Label	Direction	Magnitude[lb.k-ft]	Location[ft.%]
45	MP4C	Mx	-.00047	5.5
46	MP4A	X	0	.5
47	MP4A	Z	-4.722	.5
48	MP4A	Mx	.005	.5
49	MP4A	X	0	5.5
50	MP4A	Z	-4.722	5.5
51	MP4A	Mx	.005	5.5
52	MP4B	X	0	.5
53	MP4B	Z	-4.331	.5
54	MP4B	Mx	-.002	.5
55	MP4B	X	0	5.5
56	MP4B	Z	-4.331	5.5
57	MP4B	Mx	-.002	5.5
58	MP4C	X	0	.5
59	MP4C	Z	-3.673	.5
60	MP4C	Mx	-.003	.5
61	MP4C	X	0	5.5
62	MP4C	Z	-3.673	5.5
63	MP4C	Mx	-.003	5.5
64	MP2A	X	0	1.88
65	MP2A	Z	-3.914	1.88
66	MP2A	Mx	0	1.88
67	MP2A	X	0	3.88
68	MP2A	Z	-3.914	3.88
69	MP2A	Mx	0	3.88
70	MP2B	X	0	1.88
71	MP2B	Z	-3.069	1.88
72	MP2B	Mx	.00088	1.88
73	MP2B	X	0	3.88
74	MP2B	Z	-3.069	3.88
75	MP2B	Mx	.00088	3.88
76	MP2C	X	0	1.88
77	MP2C	Z	-1.648	1.88
78	MP2C	Mx	-.000774	1.88
79	MP2C	X	0	3.88
80	MP2C	Z	-1.648	3.88
81	MP2C	Mx	-.000774	3.88
82	MP3A	X	0	2
83	MP3A	Z	-3.095	2
84	MP3A	Mx	0	2
85	MP3B	X	0	2
86	MP3B	Z	-2.331	2
87	MP3B	Mx	-.000673	2
88	MP3C	X	0	2
89	MP3C	Z	-2.331	2
90	MP3C	Mx	.000673	2
91	MP4A	X	0	2
92	MP4A	Z	-3.095	2
93	MP4A	Mx	0	2
94	MP4B	X	0	2
95	MP4B	Z	-2.181	2
96	MP4B	Mx	-.00063	2
97	MP4C	X	0	2
98	MP4C	Z	-2.181	2
99	MP4C	Mx	.00063	2

Member Point Loads (BLC 28 : Antenna Wm (30 Deg))

	Member Label	Direction	Magnitude[lb.k-ft]	Location[ft.%]
1	MP3A	X	.791	.5
2	MP3A	Z	-1.371	.5
3	MP3A	Mx	.000396	.5
4	MP3B	X	.41	.5
5	MP3B	Z	-.71	.5
6	MP3B	Mx	-.000372	.5
7	MP3C	X	.683	.5
8	MP3C	Z	-1.182	.5
9	MP3C	Mx	.000439	.5
10	MP1A	X	3.855	.75
11	MP1A	Z	-6.678	.75
12	MP1A	Mx	-.002	.75
13	MP1A	X	3.855	5
14	MP1A	Z	-6.678	5
15	MP1A	Mx	-.002	5
16	MP1B	X	2.912	.75
17	MP1B	Z	-5.044	.75
18	MP1B	Mx	.003	.75
19	MP1B	X	2.912	5
20	MP1B	Z	-5.044	5
21	MP1B	Mx	.003	5
22	MP1C	X	3.586	.75
23	MP1C	Z	-6.211	.75
24	MP1C	Mx	-.002	.75
25	MP1C	X	3.586	5
26	MP1C	Z	-6.211	5
27	MP1C	Mx	-.002	5
28	MP4A	X	2.213	.5
29	MP4A	Z	-3.832	.5
30	MP4A	Mx	-.005	.5
31	MP4A	X	2.213	5.5
32	MP4A	Z	-3.832	5.5
33	MP4A	Mx	-.005	5.5
34	MP4B	X	1.873	.5
35	MP4B	Z	-3.244	.5
36	MP4B	Mx	.003	.5
37	MP4B	X	1.873	5.5
38	MP4B	Z	-3.244	5.5
39	MP4B	Mx	.003	5.5
40	MP4C	X	2.116	.5
41	MP4C	Z	-3.665	.5
42	MP4C	Mx	.002	.5
43	MP4C	X	2.116	5.5
44	MP4C	Z	-3.665	5.5
45	MP4C	Mx	.002	5.5
46	MP4A	X	2.213	.5
47	MP4A	Z	-3.832	.5
48	MP4A	Mx	.003	.5
49	MP4A	X	2.213	5.5
50	MP4A	Z	-3.832	5.5
51	MP4A	Mx	.003	5.5
52	MP4B	X	1.873	.5
53	MP4B	Z	-3.244	.5
54	MP4B	Mx	.000114	.5
55	MP4B	X	1.873	5.5
56	MP4B	Z	-3.244	5.5
57	MP4B	Mx	.000114	5.5



Company :
 Designer :
 Job Number :
 Model Name :

July 6, 2023
 1:03 PM
 Checked By: _____

Member Point Loads (BLC 28 : Antenna Wm (30 Deg)) (Continued)

	Member Label	Direction	Magnitude[lb.k-ft]	Location[ft.%]
58	MP4C	X	2.116	.5
59	MP4C	Z	-3.665	.5
60	MP4C	Mx	-.005	.5
61	MP4C	X	2.116	5.5
62	MP4C	Z	-3.665	5.5
63	MP4C	Mx	-.005	5.5
64	MP2A	X	1.636	1.88
65	MP2A	Z	-2.834	1.88
66	MP2A	Mx	-.000818	1.88
67	MP2A	X	1.636	3.88
68	MP2A	Z	-2.834	3.88
69	MP2A	Mx	-.000818	3.88
70	MP2B	X	.903	1.88
71	MP2B	Z	-1.564	1.88
72	MP2B	Mx	.000818	1.88
73	MP2B	X	.903	3.88
74	MP2B	Z	-1.564	3.88
75	MP2B	Mx	.000818	3.88
76	MP2C	X	1.427	1.88
77	MP2C	Z	-2.471	1.88
78	MP2C	Mx	-.000917	1.88
79	MP2C	X	1.427	3.88
80	MP2C	Z	-2.471	3.88
81	MP2C	Mx	-.000917	3.88
82	MP3A	X	1.42	2
83	MP3A	Z	-2.46	2
84	MP3A	Mx	.000473	2
85	MP3B	X	1.038	2
86	MP3B	Z	-1.798	2
87	MP3B	Mx	-.000692	2
88	MP3C	X	1.42	2
89	MP3C	Z	-2.46	2
90	MP3C	Mx	.000473	2
91	MP4A	X	1.395	2
92	MP4A	Z	-2.417	2
93	MP4A	Mx	.000465	2
94	MP4B	X	.938	2
95	MP4B	Z	-1.625	2
96	MP4B	Mx	-.000625	2
97	MP4C	X	1.395	2
98	MP4C	Z	-2.417	2
99	MP4C	Mx	.000465	2

Member Point Loads (BLC 29 : Antenna Wm (60 Deg))

	Member Label	Direction	Magnitude[lb.k-ft]	Location[ft.%]
1	MP3A	X	.793	.5
2	MP3A	Z	-.458	.5
3	MP3A	Mx	.000396	.5
4	MP3B	X	.512	.5
5	MP3B	Z	-.296	.5
6	MP3B	Mx	-.000295	.5
7	MP3C	X	1.625	.5
8	MP3C	Z	-.938	.5
9	MP3C	Mx	.000163	.5
10	MP1A	X	5.248	.75
11	MP1A	Z	-3.03	.75



Company :
Designer :
Job Number :
Model Name :

July 6, 2023
1:03 PM
Checked By: _____

Member Point Loads (BLC 29 : Antenna Wm (60 Deg)) (Continued)

	Member Label	Direction	Magnitude[lb.k-ft]	Location[ft.%]
12	MP1A	Mx	-.003	.75
13	MP1A	X	5.248	5
14	MP1A	Z	-3.03	5
15	MP1A	Mx	-.003	5
16	MP1B	X	4.555	.75
17	MP1B	Z	-2.63	.75
18	MP1B	Mx	.003	.75
19	MP1B	X	4.555	5
20	MP1B	Z	-2.63	5
21	MP1B	Mx	.003	5
22	MP1C	X	7.306	.75
23	MP1C	Z	-4.218	.75
24	MP1C	Mx	-.000732	.75
25	MP1C	X	7.306	5
26	MP1C	Z	-4.218	5
27	MP1C	Mx	-.000732	5
28	MP4A	X	3.318	.5
29	MP4A	Z	-1.916	.5
30	MP4A	Mx	-.004	.5
31	MP4A	X	3.318	5.5
32	MP4A	Z	-1.916	5.5
33	MP4A	Mx	-.004	5.5
34	MP4B	X	3.069	.5
35	MP4B	Z	-1.772	.5
36	MP4B	Mx	.001	.5
37	MP4B	X	3.069	5.5
38	MP4B	Z	-1.772	5.5
39	MP4B	Mx	.001	5.5
40	MP4C	X	4.059	.5
41	MP4C	Z	-2.343	.5
42	MP4C	Mx	.004	.5
43	MP4C	X	4.059	5.5
44	MP4C	Z	-2.343	5.5
45	MP4C	Mx	.004	5.5
46	MP4A	X	3.318	.5
47	MP4A	Z	-1.916	.5
48	MP4A	Mx	.000257	.5
49	MP4A	X	3.318	5.5
50	MP4A	Z	-1.916	5.5
51	MP4A	Mx	.000257	5.5
52	MP4B	X	3.069	.5
53	MP4B	Z	-1.772	.5
54	MP4B	Mx	.002	.5
55	MP4B	X	3.069	5.5
56	MP4B	Z	-1.772	5.5
57	MP4B	Mx	.002	5.5
58	MP4C	X	4.059	.5
59	MP4C	Z	-2.343	.5
60	MP4C	Mx	-.005	.5
61	MP4C	X	4.059	5.5
62	MP4C	Z	-2.343	5.5
63	MP4C	Mx	-.005	5.5
64	MP2A	X	1.723	1.88
65	MP2A	Z	-.995	1.88
66	MP2A	Mx	-.000862	1.88
67	MP2A	X	1.723	3.88
68	MP2A	Z	-.995	3.88

Member Point Loads (BLC 29 : Antenna Wm (60 Deg)) (Continued)

	Member Label	Direction	Magnitude[lb.k-ft]	Location[ft.%]
69	MP2A	Mx	-.000862	3.88
70	MP2B	X	1.184	1.88
71	MP2B	Z	-.684	1.88
72	MP2B	Mx	.000681	1.88
73	MP2B	X	1.184	3.88
74	MP2B	Z	-.684	3.88
75	MP2B	Mx	.000681	3.88
76	MP2C	X	3.322	1.88
77	MP2C	Z	-1.918	1.88
78	MP2C	Mx	-.000333	1.88
79	MP2C	X	3.322	3.88
80	MP2C	Z	-1.918	3.88
81	MP2C	Mx	-.000333	3.88
82	MP3A	X	2.019	2
83	MP3A	Z	-1.166	2
84	MP3A	Mx	.000673	2
85	MP3B	X	2.019	2
86	MP3B	Z	-1.166	2
87	MP3B	Mx	-.000673	2
88	MP3C	X	2.68	2
89	MP3C	Z	-1.547	2
90	MP3C	Mx	0	2
91	MP4A	X	1.889	2
92	MP4A	Z	-1.091	2
93	MP4A	Mx	.00063	2
94	MP4B	X	1.889	2
95	MP4B	Z	-1.091	2
96	MP4B	Mx	-.00063	2
97	MP4C	X	2.68	2
98	MP4C	Z	-1.547	2
99	MP4C	Mx	0	2

Member Point Loads (BLC 30 : Antenna Wm (90 Deg))

	Member Label	Direction	Magnitude[lb.k-ft]	Location[ft.%]
1	MP3A	X	.581	.5
2	MP3A	Z	0	.5
3	MP3A	Mx	.00029	.5
4	MP3B	X	1.021	.5
5	MP3B	Z	0	.5
6	MP3B	Mx	-.000418	.5
7	MP3C	X	1.761	.5
8	MP3C	Z	0	.5
9	MP3C	Mx	-.000301	.5
10	MP1A	X	5.234	.75
11	MP1A	Z	0	.75
12	MP1A	Mx	-.003	.75
13	MP1A	X	5.234	5
14	MP1A	Z	0	5
15	MP1A	Mx	-.003	5
16	MP1B	X	6.321	.75
17	MP1B	Z	0	.75
18	MP1B	Mx	.003	.75
19	MP1B	X	6.321	5
20	MP1B	Z	0	5
21	MP1B	Mx	.003	5
22	MP1C	X	8.15	.75



Company :
 Designer :
 Job Number :
 Model Name :

July 6, 2023
 1:03 PM
 Checked By: _____

Member Point Loads (BLC 30 : Antenna Wm (90 Deg)) (Continued)

	Member Label	Direction	Magnitude[lb.k-ft]	Location[ft.%]
23	MP1C	Z	0	.75
24	MP1C	Mx	.001	.75
25	MP1C	X	8.15	5
26	MP1C	Z	0	5
27	MP1C	Mx	.001	5
28	MP4A	X	3.534	.5
29	MP4A	Z	0	.5
30	MP4A	Mx	-.002	.5
31	MP4A	X	3.534	5.5
32	MP4A	Z	0	5.5
33	MP4A	Mx	-.002	5.5
34	MP4B	X	3.925	.5
35	MP4B	Z	0	.5
36	MP4B	Mx	-.000644	.5
37	MP4B	X	3.925	5.5
38	MP4B	Z	0	5.5
39	MP4B	Mx	-.000644	5.5
40	MP4C	X	4.583	.5
41	MP4C	Z	0	.5
42	MP4C	Mx	.005	.5
43	MP4C	X	4.583	5.5
44	MP4C	Z	0	5.5
45	MP4C	Mx	.005	5.5
46	MP4A	X	3.534	.5
47	MP4A	Z	0	.5
48	MP4A	Mx	-.002	.5
49	MP4A	X	3.534	5.5
50	MP4A	Z	0	5.5
51	MP4A	Mx	-.002	5.5
52	MP4B	X	3.925	.5
53	MP4B	Z	0	.5
54	MP4B	Mx	.004	.5
55	MP4B	X	3.925	5.5
56	MP4B	Z	0	5.5
57	MP4B	Mx	.004	5.5
58	MP4C	X	4.583	.5
59	MP4C	Z	0	.5
60	MP4C	Mx	-.004	.5
61	MP4C	X	4.583	5.5
62	MP4C	Z	0	5.5
63	MP4C	Mx	-.004	5.5
64	MP2A	X	1.348	1.88
65	MP2A	Z	0	1.88
66	MP2A	Mx	-.000674	1.88
67	MP2A	X	1.348	3.88
68	MP2A	Z	0	3.88
69	MP2A	Mx	-.000674	3.88
70	MP2B	X	2.192	1.88
71	MP2B	Z	0	1.88
72	MP2B	Mx	.000898	1.88
73	MP2B	X	2.192	3.88
74	MP2B	Z	0	3.88
75	MP2B	Mx	.000898	3.88
76	MP2C	X	3.613	1.88
77	MP2C	Z	0	1.88
78	MP2C	Mx	.000618	1.88
79	MP2C	X	3.613	3.88

Member Point Loads (BLC 30 : Antenna Wm (90 Deg)) (Continued)

	Member Label	Direction	Magnitude[lb.k-ft]	Location[ft.%]
80	MP2C	Z	0	3.88
81	MP2C	Mx	.000618	3.88
82	MP3A	X	2.077	2
83	MP3A	Z	0	2
84	MP3A	Mx	.000692	2
85	MP3B	X	2.84	2
86	MP3B	Z	0	2
87	MP3B	Mx	-.000473	2
88	MP3C	X	2.84	2
89	MP3C	Z	0	2
90	MP3C	Mx	-.000473	2
91	MP4A	X	1.877	2
92	MP4A	Z	0	2
93	MP4A	Mx	.000626	2
94	MP4B	X	2.79	2
95	MP4B	Z	0	2
96	MP4B	Mx	-.000465	2
97	MP4C	X	2.79	2
98	MP4C	Z	0	2
99	MP4C	Mx	-.000465	2

Member Point Loads (BLC 31 : Antenna Wm (120 Deg))

	Member Label	Direction	Magnitude[lb.k-ft]	Location[ft.%]
1	MP3A	X	.793	.5
2	MP3A	Z	.458	.5
3	MP3A	Mx	.000396	.5
4	MP3B	X	1.453	.5
5	MP3B	Z	.839	.5
6	MP3B	Mx	-.000354	.5
7	MP3C	X	.981	.5
8	MP3C	Z	.567	.5
9	MP3C	Mx	-.000434	.5
10	MP1A	X	5.248	.75
11	MP1A	Z	3.03	.75
12	MP1A	Mx	-.003	.75
13	MP1A	X	5.248	5
14	MP1A	Z	3.03	5
15	MP1A	Mx	-.003	5
16	MP1B	X	6.882	.75
17	MP1B	Z	3.973	.75
18	MP1B	Mx	.002	.75
19	MP1B	X	6.882	5
20	MP1B	Z	3.973	5
21	MP1B	Mx	.002	5
22	MP1C	X	5.715	.75
23	MP1C	Z	3.299	.75
24	MP1C	Mx	.003	.75
25	MP1C	X	5.715	5
26	MP1C	Z	3.299	5
27	MP1C	Mx	.003	5
28	MP4A	X	3.318	.5
29	MP4A	Z	1.916	.5
30	MP4A	Mx	.000257	.5
31	MP4A	X	3.318	5.5
32	MP4A	Z	1.916	5.5
33	MP4A	Mx	.000257	5.5



Company :
 Designer :
 Job Number :
 Model Name :

July 6, 2023
 1:03 PM
 Checked By: _____

Member Point Loads (BLC 31 : Antenna Wm (120 Deg)) (Continued)

	Member Label	Direction	Magnitude[lb.k-ft]	Location[ft.%]
34	MP4B	X	3.906	.5
35	MP4B	Z	2.255	.5
36	MP4B	Mx	-.003	.5
37	MP4B	X	3.906	5.5
38	MP4B	Z	2.255	5.5
39	MP4B	Mx	-.003	5.5
40	MP4C	X	3.486	.5
41	MP4C	Z	2.013	.5
42	MP4C	Mx	.004	.5
43	MP4C	X	3.486	5.5
44	MP4C	Z	2.013	5.5
45	MP4C	Mx	.004	5.5
46	MP4A	X	3.318	.5
47	MP4A	Z	1.916	.5
48	MP4A	Mx	-.004	.5
49	MP4A	X	3.318	5.5
50	MP4A	Z	1.916	5.5
51	MP4A	Mx	-.004	5.5
52	MP4B	X	3.906	.5
53	MP4B	Z	2.255	.5
54	MP4B	Mx	.005	.5
55	MP4B	X	3.906	5.5
56	MP4B	Z	2.255	5.5
57	MP4B	Mx	.005	5.5
58	MP4C	X	3.486	.5
59	MP4C	Z	2.013	.5
60	MP4C	Mx	-.001	.5
61	MP4C	X	3.486	5.5
62	MP4C	Z	2.013	5.5
63	MP4C	Mx	-.001	5.5
64	MP2A	X	1.723	1.88
65	MP2A	Z	.995	1.88
66	MP2A	Mx	-.000862	1.88
67	MP2A	X	1.723	3.88
68	MP2A	Z	.995	3.88
69	MP2A	Mx	-.000862	3.88
70	MP2B	X	2.992	1.88
71	MP2B	Z	1.728	1.88
72	MP2B	Mx	.00073	1.88
73	MP2B	X	2.992	3.88
74	MP2B	Z	1.728	3.88
75	MP2B	Mx	.00073	3.88
76	MP2C	X	2.085	1.88
77	MP2C	Z	1.204	1.88
78	MP2C	Mx	.000922	1.88
79	MP2C	X	2.085	3.88
80	MP2C	Z	1.204	3.88
81	MP2C	Mx	.000922	3.88
82	MP3A	X	2.019	2
83	MP3A	Z	1.166	2
84	MP3A	Mx	.000673	2
85	MP3B	X	2.68	2
86	MP3B	Z	1.547	2
87	MP3B	Mx	0	2
88	MP3C	X	2.019	2
89	MP3C	Z	1.166	2
90	MP3C	Mx	-.000673	2



Company :
 Designer :
 Job Number :
 Model Name :

July 6, 2023
 1:03 PM
 Checked By: _____

Member Point Loads (BLC 31 : Antenna Wm (120 Deg)) (Continued)

	Member Label	Direction	Magnitude[lb.k-ft]	Location[ft.%]
91	MP4A	X	1.889	2
92	MP4A	Z	1.091	2
93	MP4A	Mx	.00063	2
94	MP4B	X	2.68	2
95	MP4B	Z	1.547	2
96	MP4B	Mx	0	2
97	MP4C	X	1.889	2
98	MP4C	Z	1.091	2
99	MP4C	Mx	-.00063	2

Member Point Loads (BLC 32 : Antenna Wm (150 Deg))

	Member Label	Direction	Magnitude[lb.k-ft]	Location[ft.%]
1	MP3A	X	.791	.5
2	MP3A	Z	1.371	.5
3	MP3A	Mx	.000396	.5
4	MP3B	X	.953	.5
5	MP3B	Z	1.651	.5
6	MP3B	Mx	8.3e-5	.5
7	MP3C	X	.311	.5
8	MP3C	Z	.538	.5
9	MP3C	Mx	-.000306	.5
10	MP1A	X	3.855	.75
11	MP1A	Z	6.678	.75
12	MP1A	Mx	-.002	.75
13	MP1A	X	3.855	5
14	MP1A	Z	6.678	5
15	MP1A	Mx	-.002	5
16	MP1B	X	4.255	.75
17	MP1B	Z	7.371	.75
18	MP1B	Mx	-.000371	.75
19	MP1B	X	4.255	5
20	MP1B	Z	7.371	5
21	MP1B	Mx	-.000371	5
22	MP1C	X	2.667	.75
23	MP1C	Z	4.619	.75
24	MP1C	Mx	.003	.75
25	MP1C	X	2.667	5
26	MP1C	Z	4.619	5
27	MP1C	Mx	.003	5
28	MP4A	X	2.213	.5
29	MP4A	Z	3.832	.5
30	MP4A	Mx	.003	.5
31	MP4A	X	2.213	5.5
32	MP4A	Z	3.832	5.5
33	MP4A	Mx	.003	5.5
34	MP4B	X	2.357	.5
35	MP4B	Z	4.082	.5
36	MP4B	Mx	-.005	.5
37	MP4B	X	2.357	5.5
38	MP4B	Z	4.082	5.5
39	MP4B	Mx	-.005	5.5
40	MP4C	X	1.785	.5
41	MP4C	Z	3.092	.5
42	MP4C	Mx	.002	.5
43	MP4C	X	1.785	5.5
44	MP4C	Z	3.092	5.5



Company :
 Designer :
 Job Number :
 Model Name :

July 6, 2023
 1:03 PM
 Checked By: _____

Member Point Loads (BLC 32 : Antenna Wm (150 Deg)) (Continued)

	Member Label	Direction	Magnitude[lb.k-ft]	Location[ft.%]
45	MP4C	Mx	.002	5.5
46	MP4A	X	2.213	.5
47	MP4A	Z	3.832	.5
48	MP4A	Mx	-.005	.5
49	MP4A	X	2.213	5.5
50	MP4A	Z	3.832	5.5
51	MP4A	Mx	-.005	5.5
52	MP4B	X	2.357	.5
53	MP4B	Z	4.082	.5
54	MP4B	Mx	.004	.5
55	MP4B	X	2.357	5.5
56	MP4B	Z	4.082	5.5
57	MP4B	Mx	.004	5.5
58	MP4C	X	1.785	.5
59	MP4C	Z	3.092	.5
60	MP4C	Mx	.001	.5
61	MP4C	X	1.785	5.5
62	MP4C	Z	3.092	5.5
63	MP4C	Mx	.001	5.5
64	MP2A	X	1.636	1.88
65	MP2A	Z	2.834	1.88
66	MP2A	Mx	-.000818	1.88
67	MP2A	X	1.636	3.88
68	MP2A	Z	2.834	3.88
69	MP2A	Mx	-.000818	3.88
70	MP2B	X	1.947	1.88
71	MP2B	Z	3.372	1.88
72	MP2B	Mx	-.00017	1.88
73	MP2B	X	1.947	3.88
74	MP2B	Z	3.372	3.88
75	MP2B	Mx	-.00017	3.88
76	MP2C	X	.713	1.88
77	MP2C	Z	1.234	1.88
78	MP2C	Mx	.000702	1.88
79	MP2C	X	.713	3.88
80	MP2C	Z	1.234	3.88
81	MP2C	Mx	.000702	3.88
82	MP3A	X	1.42	2
83	MP3A	Z	2.46	2
84	MP3A	Mx	.000473	2
85	MP3B	X	1.42	2
86	MP3B	Z	2.46	2
87	MP3B	Mx	.000473	2
88	MP3C	X	1.038	2
89	MP3C	Z	1.798	2
90	MP3C	Mx	-.000692	2
91	MP4A	X	1.395	2
92	MP4A	Z	2.417	2
93	MP4A	Mx	.000465	2
94	MP4B	X	1.395	2
95	MP4B	Z	2.417	2
96	MP4B	Mx	.000465	2
97	MP4C	X	.938	2
98	MP4C	Z	1.625	2
99	MP4C	Mx	-.000625	2



Company :
 Designer :
 Job Number :
 Model Name :

July 6, 2023
 1:03 PM
 Checked By: _____

Member Point Loads (BLC 33 : Antenna Wm (180 Deg))

	Member Label	Direction	Magnitude[lb.k-ft]	Location[ft.%]
1	MP3A	X	0	.5
2	MP3A	Z	1.917	.5
3	MP3A	Mx	0	.5
4	MP3B	X	0	.5
5	MP3B	Z	1.478	.5
6	MP3B	Mx	.000424	.5
7	MP3C	X	0	.5
8	MP3C	Z	.738	.5
9	MP3C	Mx	-.000347	.5
10	MP1A	X	0	.75
11	MP1A	Z	8.536	.75
12	MP1A	Mx	0	.75
13	MP1A	X	0	5
14	MP1A	Z	8.536	5
15	MP1A	Mx	0	5
16	MP1B	X	0	.75
17	MP1B	Z	7.45	.75
18	MP1B	Mx	-.002	.75
19	MP1B	X	0	5
20	MP1B	Z	7.45	5
21	MP1B	Mx	-.002	5
22	MP1C	X	0	.75
23	MP1C	Z	5.621	.75
24	MP1C	Mx	.003	.75
25	MP1C	X	0	5
26	MP1C	Z	5.621	5
27	MP1C	Mx	.003	5
28	MP4A	X	0	.5
29	MP4A	Z	4.722	.5
30	MP4A	Mx	.005	.5
31	MP4A	X	0	5.5
32	MP4A	Z	4.722	5.5
33	MP4A	Mx	.005	5.5
34	MP4B	X	0	.5
35	MP4B	Z	4.331	.5
36	MP4B	Mx	-.005	.5
37	MP4B	X	0	5.5
38	MP4B	Z	4.331	5.5
39	MP4B	Mx	-.005	5.5
40	MP4C	X	0	.5
41	MP4C	Z	3.673	.5
42	MP4C	Mx	.00047	.5
43	MP4C	X	0	5.5
44	MP4C	Z	3.673	5.5
45	MP4C	Mx	.00047	5.5
46	MP4A	X	0	.5
47	MP4A	Z	4.722	.5
48	MP4A	Mx	-.005	.5
49	MP4A	X	0	5.5
50	MP4A	Z	4.722	5.5
51	MP4A	Mx	-.005	5.5
52	MP4B	X	0	.5
53	MP4B	Z	4.331	.5
54	MP4B	Mx	.002	.5
55	MP4B	X	0	5.5
56	MP4B	Z	4.331	5.5
57	MP4B	Mx	.002	5.5



Company :
 Designer :
 Job Number :
 Model Name :

July 6, 2023
 1:03 PM
 Checked By: _____

Member Point Loads (BLC 33 : Antenna Wm (180 Deg)) (Continued)

	Member Label	Direction	Magnitude[lb.k-ft]	Location[ft.%]
58	MP4C	X	0	.5
59	MP4C	Z	3.673	.5
60	MP4C	Mx	.003	.5
61	MP4C	X	0	5.5
62	MP4C	Z	3.673	5.5
63	MP4C	Mx	.003	5.5
64	MP2A	X	0	1.88
65	MP2A	Z	3.914	1.88
66	MP2A	Mx	0	1.88
67	MP2A	X	0	3.88
68	MP2A	Z	3.914	3.88
69	MP2A	Mx	0	3.88
70	MP2B	X	0	1.88
71	MP2B	Z	3.069	1.88
72	MP2B	Mx	-.00088	1.88
73	MP2B	X	0	3.88
74	MP2B	Z	3.069	3.88
75	MP2B	Mx	-.00088	3.88
76	MP2C	X	0	1.88
77	MP2C	Z	1.648	1.88
78	MP2C	Mx	.000774	1.88
79	MP2C	X	0	3.88
80	MP2C	Z	1.648	3.88
81	MP2C	Mx	.000774	3.88
82	MP3A	X	0	2
83	MP3A	Z	3.095	2
84	MP3A	Mx	0	2
85	MP3B	X	0	2
86	MP3B	Z	2.331	2
87	MP3B	Mx	.000673	2
88	MP3C	X	0	2
89	MP3C	Z	2.331	2
90	MP3C	Mx	-.000673	2
91	MP4A	X	0	2
92	MP4A	Z	3.095	2
93	MP4A	Mx	0	2
94	MP4B	X	0	2
95	MP4B	Z	2.181	2
96	MP4B	Mx	.00063	2
97	MP4C	X	0	2
98	MP4C	Z	2.181	2
99	MP4C	Mx	-.00063	2

Member Point Loads (BLC 34 : Antenna Wm (210 Deg))

	Member Label	Direction	Magnitude[lb.k-ft]	Location[ft.%]
1	MP3A	X	-.791	.5
2	MP3A	Z	1.371	.5
3	MP3A	Mx	-.000396	.5
4	MP3B	X	-.41	.5
5	MP3B	Z	.71	.5
6	MP3B	Mx	.000372	.5
7	MP3C	X	-.683	.5
8	MP3C	Z	1.182	.5
9	MP3C	Mx	-.000439	.5
10	MP1A	X	-3.855	.75
11	MP1A	Z	6.678	.75

Member Point Loads (BLC 34 : Antenna Wm (210 Deg)) (Continued)

	Member Label	Direction	Magnitude[lb.k-ft]	Location[ft.%]
12	MP1A	Mx	.002	.75
13	MP1A	X	-3.855	5
14	MP1A	Z	6.678	5
15	MP1A	Mx	.002	5
16	MP1B	X	-2.912	.75
17	MP1B	Z	5.044	.75
18	MP1B	Mx	-.003	.75
19	MP1B	X	-2.912	5
20	MP1B	Z	5.044	5
21	MP1B	Mx	-.003	5
22	MP1C	X	-3.586	.75
23	MP1C	Z	6.211	.75
24	MP1C	Mx	.002	.75
25	MP1C	X	-3.586	5
26	MP1C	Z	6.211	5
27	MP1C	Mx	.002	5
28	MP4A	X	-2.213	.5
29	MP4A	Z	3.832	.5
30	MP4A	Mx	.005	.5
31	MP4A	X	-2.213	5.5
32	MP4A	Z	3.832	5.5
33	MP4A	Mx	.005	5.5
34	MP4B	X	-1.873	.5
35	MP4B	Z	3.244	.5
36	MP4B	Mx	-.003	.5
37	MP4B	X	-1.873	5.5
38	MP4B	Z	3.244	5.5
39	MP4B	Mx	-.003	5.5
40	MP4C	X	-2.116	.5
41	MP4C	Z	3.665	.5
42	MP4C	Mx	-.002	.5
43	MP4C	X	-2.116	5.5
44	MP4C	Z	3.665	5.5
45	MP4C	Mx	-.002	5.5
46	MP4A	X	-2.213	.5
47	MP4A	Z	3.832	.5
48	MP4A	Mx	-.003	.5
49	MP4A	X	-2.213	5.5
50	MP4A	Z	3.832	5.5
51	MP4A	Mx	-.003	5.5
52	MP4B	X	-1.873	.5
53	MP4B	Z	3.244	.5
54	MP4B	Mx	-.000114	.5
55	MP4B	X	-1.873	5.5
56	MP4B	Z	3.244	5.5
57	MP4B	Mx	-.000114	5.5
58	MP4C	X	-2.116	.5
59	MP4C	Z	3.665	.5
60	MP4C	Mx	.005	.5
61	MP4C	X	-2.116	5.5
62	MP4C	Z	3.665	5.5
63	MP4C	Mx	.005	5.5
64	MP2A	X	-1.636	1.88
65	MP2A	Z	2.834	1.88
66	MP2A	Mx	.000818	1.88
67	MP2A	X	-1.636	3.88
68	MP2A	Z	2.834	3.88

Member Point Loads (BLC 34 : Antenna Wm (210 Deg)) (Continued)

	Member Label	Direction	Magnitude[lb.k-ft]	Location[ft.%]
69	MP2A	Mx	.000818	3.88
70	MP2B	X	-.903	1.88
71	MP2B	Z	1.564	1.88
72	MP2B	Mx	-.000818	1.88
73	MP2B	X	-.903	3.88
74	MP2B	Z	1.564	3.88
75	MP2B	Mx	-.000818	3.88
76	MP2C	X	-1.427	1.88
77	MP2C	Z	2.471	1.88
78	MP2C	Mx	.000917	1.88
79	MP2C	X	-1.427	3.88
80	MP2C	Z	2.471	3.88
81	MP2C	Mx	.000917	3.88
82	MP3A	X	-1.42	2
83	MP3A	Z	2.46	2
84	MP3A	Mx	-.000473	2
85	MP3B	X	-1.038	2
86	MP3B	Z	1.798	2
87	MP3B	Mx	.000692	2
88	MP3C	X	-1.42	2
89	MP3C	Z	2.46	2
90	MP3C	Mx	-.000473	2
91	MP4A	X	-1.395	2
92	MP4A	Z	2.417	2
93	MP4A	Mx	-.000465	2
94	MP4B	X	-.938	2
95	MP4B	Z	1.625	2
96	MP4B	Mx	.000625	2
97	MP4C	X	-1.395	2
98	MP4C	Z	2.417	2
99	MP4C	Mx	-.000465	2

Member Point Loads (BLC 35 : Antenna Wm (240 Deg))

	Member Label	Direction	Magnitude[lb.k-ft]	Location[ft.%]
1	MP3A	X	-.793	.5
2	MP3A	Z	.458	.5
3	MP3A	Mx	-.000396	.5
4	MP3B	X	-.512	.5
5	MP3B	Z	.296	.5
6	MP3B	Mx	.000295	.5
7	MP3C	X	-1.625	.5
8	MP3C	Z	.938	.5
9	MP3C	Mx	-.000163	.5
10	MP1A	X	-5.248	.75
11	MP1A	Z	3.03	.75
12	MP1A	Mx	.003	.75
13	MP1A	X	-5.248	5
14	MP1A	Z	3.03	5
15	MP1A	Mx	.003	5
16	MP1B	X	-4.555	.75
17	MP1B	Z	2.63	.75
18	MP1B	Mx	-.003	.75
19	MP1B	X	-4.555	5
20	MP1B	Z	2.63	5
21	MP1B	Mx	-.003	5
22	MP1C	X	-7.306	.75



Company :
 Designer :
 Job Number :
 Model Name :

July 6, 2023
 1:03 PM
 Checked By: _____

Member Point Loads (BLC 35 : Antenna Wm (240 Deg)) (Continued)

	Member Label	Direction	Magnitude[lb.k-ft]	Location[ft.%]
23	MP1C	Z	4.218	.75
24	MP1C	Mx	.000732	.75
25	MP1C	X	-7.306	5
26	MP1C	Z	4.218	5
27	MP1C	Mx	.000732	5
28	MP4A	X	-3.318	.5
29	MP4A	Z	1.916	.5
30	MP4A	Mx	.004	.5
31	MP4A	X	-3.318	5.5
32	MP4A	Z	1.916	5.5
33	MP4A	Mx	.004	5.5
34	MP4B	X	-3.069	.5
35	MP4B	Z	1.772	.5
36	MP4B	Mx	-.001	.5
37	MP4B	X	-3.069	5.5
38	MP4B	Z	1.772	5.5
39	MP4B	Mx	-.001	5.5
40	MP4C	X	-4.059	.5
41	MP4C	Z	2.343	.5
42	MP4C	Mx	-.004	.5
43	MP4C	X	-4.059	5.5
44	MP4C	Z	2.343	5.5
45	MP4C	Mx	-.004	5.5
46	MP4A	X	-3.318	.5
47	MP4A	Z	1.916	.5
48	MP4A	Mx	-.000257	.5
49	MP4A	X	-3.318	5.5
50	MP4A	Z	1.916	5.5
51	MP4A	Mx	-.000257	5.5
52	MP4B	X	-3.069	.5
53	MP4B	Z	1.772	.5
54	MP4B	Mx	-.002	.5
55	MP4B	X	-3.069	5.5
56	MP4B	Z	1.772	5.5
57	MP4B	Mx	-.002	5.5
58	MP4C	X	-4.059	.5
59	MP4C	Z	2.343	.5
60	MP4C	Mx	.005	.5
61	MP4C	X	-4.059	5.5
62	MP4C	Z	2.343	5.5
63	MP4C	Mx	.005	5.5
64	MP2A	X	-1.723	1.88
65	MP2A	Z	.995	1.88
66	MP2A	Mx	.000862	1.88
67	MP2A	X	-1.723	3.88
68	MP2A	Z	.995	3.88
69	MP2A	Mx	.000862	3.88
70	MP2B	X	-1.184	1.88
71	MP2B	Z	.684	1.88
72	MP2B	Mx	-.000681	1.88
73	MP2B	X	-1.184	3.88
74	MP2B	Z	.684	3.88
75	MP2B	Mx	-.000681	3.88
76	MP2C	X	-3.322	1.88
77	MP2C	Z	1.918	1.88
78	MP2C	Mx	.000333	1.88
79	MP2C	X	-3.322	3.88

Member Point Loads (BLC 35 : Antenna Wm (240 Deg)) (Continued)

	Member Label	Direction	Magnitude[lb.k-ft]	Location[ft.%]
80	MP2C	Z	1.918	3.88
81	MP2C	Mx	.000333	3.88
82	MP3A	X	-2.019	2
83	MP3A	Z	1.166	2
84	MP3A	Mx	-.000673	2
85	MP3B	X	-2.019	2
86	MP3B	Z	1.166	2
87	MP3B	Mx	.000673	2
88	MP3C	X	-2.68	2
89	MP3C	Z	1.547	2
90	MP3C	Mx	0	2
91	MP4A	X	-1.889	2
92	MP4A	Z	1.091	2
93	MP4A	Mx	-.00063	2
94	MP4B	X	-1.889	2
95	MP4B	Z	1.091	2
96	MP4B	Mx	.00063	2
97	MP4C	X	-2.68	2
98	MP4C	Z	1.547	2
99	MP4C	Mx	0	2

Member Point Loads (BLC 36 : Antenna Wm (270 Deg))

	Member Label	Direction	Magnitude[lb.k-ft]	Location[ft.%]
1	MP3A	X	-.581	.5
2	MP3A	Z	0	.5
3	MP3A	Mx	-.00029	.5
4	MP3B	X	-1.021	.5
5	MP3B	Z	0	.5
6	MP3B	Mx	.000418	.5
7	MP3C	X	-1.761	.5
8	MP3C	Z	0	.5
9	MP3C	Mx	.000301	.5
10	MP1A	X	-5.234	.75
11	MP1A	Z	0	.75
12	MP1A	Mx	.003	.75
13	MP1A	X	-5.234	5
14	MP1A	Z	0	5
15	MP1A	Mx	.003	5
16	MP1B	X	-6.321	.75
17	MP1B	Z	0	.75
18	MP1B	Mx	-.003	.75
19	MP1B	X	-6.321	5
20	MP1B	Z	0	5
21	MP1B	Mx	-.003	5
22	MP1C	X	-8.15	.75
23	MP1C	Z	0	.75
24	MP1C	Mx	-.001	.75
25	MP1C	X	-8.15	5
26	MP1C	Z	0	5
27	MP1C	Mx	-.001	5
28	MP4A	X	-3.534	.5
29	MP4A	Z	0	.5
30	MP4A	Mx	.002	.5
31	MP4A	X	-3.534	5.5
32	MP4A	Z	0	5.5
33	MP4A	Mx	.002	5.5



Company :
 Designer :
 Job Number :
 Model Name :

July 6, 2023
 1:03 PM
 Checked By: _____

Member Point Loads (BLC 36 : Antenna Wm (270 Deg)) (Continued)

	Member Label	Direction	Magnitude[lb.k-ft]	Location[ft.%]
34	MP4B	X	-3.925	.5
35	MP4B	Z	0	.5
36	MP4B	Mx	.000644	.5
37	MP4B	X	-3.925	5.5
38	MP4B	Z	0	5.5
39	MP4B	Mx	.000644	5.5
40	MP4C	X	-4.583	.5
41	MP4C	Z	0	.5
42	MP4C	Mx	-.005	.5
43	MP4C	X	-4.583	5.5
44	MP4C	Z	0	5.5
45	MP4C	Mx	-.005	5.5
46	MP4A	X	-3.534	.5
47	MP4A	Z	0	.5
48	MP4A	Mx	.002	.5
49	MP4A	X	-3.534	5.5
50	MP4A	Z	0	5.5
51	MP4A	Mx	.002	5.5
52	MP4B	X	-3.925	.5
53	MP4B	Z	0	.5
54	MP4B	Mx	-.004	.5
55	MP4B	X	-3.925	5.5
56	MP4B	Z	0	5.5
57	MP4B	Mx	-.004	5.5
58	MP4C	X	-4.583	.5
59	MP4C	Z	0	.5
60	MP4C	Mx	.004	.5
61	MP4C	X	-4.583	5.5
62	MP4C	Z	0	5.5
63	MP4C	Mx	.004	5.5
64	MP2A	X	-1.348	1.88
65	MP2A	Z	0	1.88
66	MP2A	Mx	.000674	1.88
67	MP2A	X	-1.348	3.88
68	MP2A	Z	0	3.88
69	MP2A	Mx	.000674	3.88
70	MP2B	X	-2.192	1.88
71	MP2B	Z	0	1.88
72	MP2B	Mx	-.000898	1.88
73	MP2B	X	-2.192	3.88
74	MP2B	Z	0	3.88
75	MP2B	Mx	-.000898	3.88
76	MP2C	X	-3.613	1.88
77	MP2C	Z	0	1.88
78	MP2C	Mx	-.000618	1.88
79	MP2C	X	-3.613	3.88
80	MP2C	Z	0	3.88
81	MP2C	Mx	-.000618	3.88
82	MP3A	X	-2.077	2
83	MP3A	Z	0	2
84	MP3A	Mx	-.000692	2
85	MP3B	X	-2.84	2
86	MP3B	Z	0	2
87	MP3B	Mx	.000473	2
88	MP3C	X	-2.84	2
89	MP3C	Z	0	2
90	MP3C	Mx	.000473	2



Company :
 Designer :
 Job Number :
 Model Name :

July 6, 2023
 1:03 PM
 Checked By: _____

Member Point Loads (BLC 36 : Antenna Wm (270 Deg)) (Continued)

	Member Label	Direction	Magnitude[lb.k-ft]	Location[ft.%]
91	MP4A	X	-1.877	2
92	MP4A	Z	0	2
93	MP4A	Mx	-.000626	2
94	MP4B	X	-2.79	2
95	MP4B	Z	0	2
96	MP4B	Mx	.000465	2
97	MP4C	X	-2.79	2
98	MP4C	Z	0	2
99	MP4C	Mx	.000465	2

Member Point Loads (BLC 37 : Antenna Wm (300 Deg))

	Member Label	Direction	Magnitude[lb.k-ft]	Location[ft.%]
1	MP3A	X	-.793	.5
2	MP3A	Z	-.458	.5
3	MP3A	Mx	-.000396	.5
4	MP3B	X	-1.453	.5
5	MP3B	Z	-.839	.5
6	MP3B	Mx	.000354	.5
7	MP3C	X	-.981	.5
8	MP3C	Z	-.567	.5
9	MP3C	Mx	.000434	.5
10	MP1A	X	-5.248	.75
11	MP1A	Z	-3.03	.75
12	MP1A	Mx	.003	.75
13	MP1A	X	-5.248	5
14	MP1A	Z	-3.03	5
15	MP1A	Mx	.003	5
16	MP1B	X	-6.882	.75
17	MP1B	Z	-3.973	.75
18	MP1B	Mx	-.002	.75
19	MP1B	X	-6.882	5
20	MP1B	Z	-3.973	5
21	MP1B	Mx	-.002	5
22	MP1C	X	-5.715	.75
23	MP1C	Z	-3.299	.75
24	MP1C	Mx	-.003	.75
25	MP1C	X	-5.715	5
26	MP1C	Z	-3.299	5
27	MP1C	Mx	-.003	5
28	MP4A	X	-3.318	.5
29	MP4A	Z	-1.916	.5
30	MP4A	Mx	-.000257	.5
31	MP4A	X	-3.318	5.5
32	MP4A	Z	-1.916	5.5
33	MP4A	Mx	-.000257	5.5
34	MP4B	X	-3.906	.5
35	MP4B	Z	-2.255	.5
36	MP4B	Mx	.003	.5
37	MP4B	X	-3.906	5.5
38	MP4B	Z	-2.255	5.5
39	MP4B	Mx	.003	5.5
40	MP4C	X	-3.486	.5
41	MP4C	Z	-2.013	.5
42	MP4C	Mx	-.004	.5
43	MP4C	X	-3.486	5.5
44	MP4C	Z	-2.013	5.5



Company :
 Designer :
 Job Number :
 Model Name :

July 6, 2023
 1:03 PM
 Checked By: _____

Member Point Loads (BLC 37 : Antenna Wm (300 Deg)) (Continued)

	Member Label	Direction	Magnitude[lb.k-ft]	Location[ft.%]
45	MP4C	Mx	-.004	5.5
46	MP4A	X	-3.318	.5
47	MP4A	Z	-1.916	.5
48	MP4A	Mx	.004	.5
49	MP4A	X	-3.318	5.5
50	MP4A	Z	-1.916	5.5
51	MP4A	Mx	.004	5.5
52	MP4B	X	-3.906	.5
53	MP4B	Z	-2.255	.5
54	MP4B	Mx	-.005	.5
55	MP4B	X	-3.906	5.5
56	MP4B	Z	-2.255	5.5
57	MP4B	Mx	-.005	5.5
58	MP4C	X	-3.486	.5
59	MP4C	Z	-2.013	.5
60	MP4C	Mx	.001	.5
61	MP4C	X	-3.486	5.5
62	MP4C	Z	-2.013	5.5
63	MP4C	Mx	.001	5.5
64	MP2A	X	-1.723	1.88
65	MP2A	Z	-.995	1.88
66	MP2A	Mx	.000862	1.88
67	MP2A	X	-1.723	3.88
68	MP2A	Z	-.995	3.88
69	MP2A	Mx	.000862	3.88
70	MP2B	X	-2.992	1.88
71	MP2B	Z	-1.728	1.88
72	MP2B	Mx	-.00073	1.88
73	MP2B	X	-2.992	3.88
74	MP2B	Z	-1.728	3.88
75	MP2B	Mx	-.00073	3.88
76	MP2C	X	-2.085	1.88
77	MP2C	Z	-1.204	1.88
78	MP2C	Mx	-.000922	1.88
79	MP2C	X	-2.085	3.88
80	MP2C	Z	-1.204	3.88
81	MP2C	Mx	-.000922	3.88
82	MP3A	X	-2.019	2
83	MP3A	Z	-1.166	2
84	MP3A	Mx	-.000673	2
85	MP3B	X	-2.68	2
86	MP3B	Z	-1.547	2
87	MP3B	Mx	0	2
88	MP3C	X	-2.019	2
89	MP3C	Z	-1.166	2
90	MP3C	Mx	.000673	2
91	MP4A	X	-1.889	2
92	MP4A	Z	-1.091	2
93	MP4A	Mx	-.00063	2
94	MP4B	X	-2.68	2
95	MP4B	Z	-1.547	2
96	MP4B	Mx	0	2
97	MP4C	X	-1.889	2
98	MP4C	Z	-1.091	2
99	MP4C	Mx	.00063	2



Company :
 Designer :
 Job Number :
 Model Name :

July 6, 2023
 1:03 PM
 Checked By: _____

Member Point Loads (BLC 38 : Antenna Wm (330 Deg))

	Member Label	Direction	Magnitude[lb.k-ft]	Location[ft.%]
1	MP3A	X	-.791	.5
2	MP3A	Z	-1.371	.5
3	MP3A	Mx	-.000396	.5
4	MP3B	X	-.953	.5
5	MP3B	Z	-1.651	.5
6	MP3B	Mx	-8.3e-5	.5
7	MP3C	X	-.311	.5
8	MP3C	Z	-.538	.5
9	MP3C	Mx	.000306	.5
10	MP1A	X	-3.855	.75
11	MP1A	Z	-6.678	.75
12	MP1A	Mx	.002	.75
13	MP1A	X	-3.855	5
14	MP1A	Z	-6.678	5
15	MP1A	Mx	.002	5
16	MP1B	X	-4.255	.75
17	MP1B	Z	-7.371	.75
18	MP1B	Mx	.000371	.75
19	MP1B	X	-4.255	5
20	MP1B	Z	-7.371	5
21	MP1B	Mx	.000371	5
22	MP1C	X	-2.667	.75
23	MP1C	Z	-4.619	.75
24	MP1C	Mx	-.003	.75
25	MP1C	X	-2.667	5
26	MP1C	Z	-4.619	5
27	MP1C	Mx	-.003	5
28	MP4A	X	-2.213	.5
29	MP4A	Z	-3.832	.5
30	MP4A	Mx	-.003	.5
31	MP4A	X	-2.213	5.5
32	MP4A	Z	-3.832	5.5
33	MP4A	Mx	-.003	5.5
34	MP4B	X	-2.357	.5
35	MP4B	Z	-4.082	.5
36	MP4B	Mx	.005	.5
37	MP4B	X	-2.357	5.5
38	MP4B	Z	-4.082	5.5
39	MP4B	Mx	.005	5.5
40	MP4C	X	-1.785	.5
41	MP4C	Z	-3.092	.5
42	MP4C	Mx	-.002	.5
43	MP4C	X	-1.785	5.5
44	MP4C	Z	-3.092	5.5
45	MP4C	Mx	-.002	5.5
46	MP4A	X	-2.213	.5
47	MP4A	Z	-3.832	.5
48	MP4A	Mx	.005	.5
49	MP4A	X	-2.213	5.5
50	MP4A	Z	-3.832	5.5
51	MP4A	Mx	.005	5.5
52	MP4B	X	-2.357	.5
53	MP4B	Z	-4.082	.5
54	MP4B	Mx	-.004	.5
55	MP4B	X	-2.357	5.5
56	MP4B	Z	-4.082	5.5
57	MP4B	Mx	-.004	5.5

Member Point Loads (BLC 38 : Antenna Wm (330 Deg)) (Continued)

	Member Label	Direction	Magnitude[lb.k-ft]	Location[ft.%]
58	MP4C	X	-1.785	.5
59	MP4C	Z	-3.092	.5
60	MP4C	Mx	-.001	.5
61	MP4C	X	-1.785	5.5
62	MP4C	Z	-3.092	5.5
63	MP4C	Mx	-.001	5.5
64	MP2A	X	-1.636	1.88
65	MP2A	Z	-2.834	1.88
66	MP2A	Mx	.000818	1.88
67	MP2A	X	-1.636	3.88
68	MP2A	Z	-2.834	3.88
69	MP2A	Mx	.000818	3.88
70	MP2B	X	-1.947	1.88
71	MP2B	Z	-3.372	1.88
72	MP2B	Mx	.00017	1.88
73	MP2B	X	-1.947	3.88
74	MP2B	Z	-3.372	3.88
75	MP2B	Mx	.00017	3.88
76	MP2C	X	-.713	1.88
77	MP2C	Z	-1.234	1.88
78	MP2C	Mx	-.000702	1.88
79	MP2C	X	-.713	3.88
80	MP2C	Z	-1.234	3.88
81	MP2C	Mx	-.000702	3.88
82	MP3A	X	-1.42	2
83	MP3A	Z	-2.46	2
84	MP3A	Mx	-.000473	2
85	MP3B	X	-1.42	2
86	MP3B	Z	-2.46	2
87	MP3B	Mx	-.000473	2
88	MP3C	X	-1.038	2
89	MP3C	Z	-1.798	2
90	MP3C	Mx	.000692	2
91	MP4A	X	-1.395	2
92	MP4A	Z	-2.417	2
93	MP4A	Mx	-.000465	2
94	MP4B	X	-1.395	2
95	MP4B	Z	-2.417	2
96	MP4B	Mx	-.000465	2
97	MP4C	X	-.938	2
98	MP4C	Z	-1.625	2
99	MP4C	Mx	.000625	2

Member Point Loads (BLC 77 : Lm1)

	Member Label	Direction	Magnitude[lb.k-ft]	Location[ft.%]
1	M20	Y	-500	0

Member Point Loads (BLC 78 : Lm2)

	Member Label	Direction	Magnitude[lb.k-ft]	Location[ft.%]
1	M21	Y	-500	0

Member Point Loads (BLC 79 : Lv1)

	Member Label	Direction	Magnitude[lb.k-ft]	Location[ft.%]
1	M1	Y	-250	0



Company :
 Designer :
 Job Number :
 Model Name :

July 6, 2023
 1:03 PM
 Checked By: _____

Member Point Loads (BLC 80 : Lv2)

	Member Label	Direction	Magnitude[lb.k-ft]	Location[ft.%]
1	M1	Y	-250	%50

Member Point Loads (BLC 81 : Antenna Ev)

	Member Label	Direction	Magnitude[lb.k-ft]	Location[ft.%]
1	MP3A	Y	-.755	.5
2	MP3A	My	.000377	.5
3	MP3A	Mz	0	.5
4	MP3B	Y	-.755	.5
5	MP3B	My	-.000309	.5
6	MP3B	Mz	.000216	.5
7	MP3C	Y	-.755	.5
8	MP3C	My	-.000129	.5
9	MP3C	Mz	-.000355	.5
10	MP1A	Y	-.875	.75
11	MP1A	My	-.000437	.75
12	MP1A	Mz	0	.75
13	MP1A	Y	-.875	5
14	MP1A	My	-.000437	5
15	MP1A	Mz	0	5
16	MP1B	Y	-.875	.75
17	MP1B	My	.000358	.75
18	MP1B	Mz	-.000251	.75
19	MP1B	Y	-.875	5
20	MP1B	My	.000358	5
21	MP1B	Mz	-.000251	5
22	MP1C	Y	-.875	.75
23	MP1C	My	.00015	.75
24	MP1C	Mz	.000411	.75
25	MP1C	Y	-.875	5
26	MP1C	My	.00015	5
27	MP1C	Mz	.000411	5
28	MP4A	Y	-.986	.5
29	MP4A	My	-.000493	.5
30	MP4A	Mz	.000986	.5
31	MP4A	Y	-.986	5.5
32	MP4A	My	-.000493	5.5
33	MP4A	Mz	.000986	5.5
34	MP4B	Y	-.986	.5
35	MP4B	My	-.000162	.5
36	MP4B	Mz	-.001	.5
37	MP4B	Y	-.986	5.5
38	MP4B	My	-.000162	5.5
39	MP4B	Mz	-.001	5.5
40	MP4C	Y	-.986	.5
41	MP4C	My	.001	.5
42	MP4C	Mz	.000126	.5
43	MP4C	Y	-.986	5.5
44	MP4C	My	.001	5.5
45	MP4C	Mz	.000126	5.5
46	MP4A	Y	-.986	.5
47	MP4A	My	-.000493	.5
48	MP4A	Mz	-.000986	.5
49	MP4A	Y	-.986	5.5
50	MP4A	My	-.000493	5.5
51	MP4A	Mz	-.000986	5.5
52	MP4B	Y	-.986	.5



Company :
 Designer :
 Job Number :
 Model Name :

July 6, 2023
 1:03 PM
 Checked By: _____

Member Point Loads (BLC 81 : Antenna Ev) (Continued)

	Member Label	Direction	Magnitude[lb.k-ft]	Location[ft. %]
53	MP4B	My	.00097	.5
54	MP4B	Mz	.000525	.5
55	MP4B	Y	-.986	5.5
56	MP4B	My	.00097	5.5
57	MP4B	Mz	.000525	5.5
58	MP4C	Y	-.986	.5
59	MP4C	My	-.000758	.5
60	MP4C	Mz	.000801	.5
61	MP4C	Y	-.986	5.5
62	MP4C	My	-.000758	5.5
63	MP4C	Mz	.000801	5.5
64	MP2A	Y	-1.867	1.88
65	MP2A	My	-.000934	1.88
66	MP2A	Mz	0	1.88
67	MP2A	Y	-1.867	3.88
68	MP2A	My	-.000934	3.88
69	MP2A	Mz	0	3.88
70	MP2B	Y	-1.867	1.88
71	MP2B	My	.000765	1.88
72	MP2B	Mz	-.000536	1.88
73	MP2B	Y	-1.867	3.88
74	MP2B	My	.000765	3.88
75	MP2B	Mz	-.000536	3.88
76	MP2C	Y	-1.867	1.88
77	MP2C	My	.000319	1.88
78	MP2C	Mz	.000877	1.88
79	MP2C	Y	-1.867	3.88
80	MP2C	My	.000319	3.88
81	MP2C	Mz	.000877	3.88
82	MP3A	Y	-3.203	2
83	MP3A	My	.001	2
84	MP3A	Mz	0	2
85	MP3B	Y	-3.203	2
86	MP3B	My	-.000534	2
87	MP3B	Mz	.000925	2
88	MP3C	Y	-3.203	2
89	MP3C	My	-.000534	2
90	MP3C	Mz	-.000925	2
91	MP4A	Y	-3.014	2
92	MP4A	My	.001	2
93	MP4A	Mz	0	2
94	MP4B	Y	-3.014	2
95	MP4B	My	-.000502	2
96	MP4B	Mz	.00087	2
97	MP4C	Y	-3.014	2
98	MP4C	My	-.000502	2
99	MP4C	Mz	-.00087	2

Member Point Loads (BLC 82 : Antenna Eh (0 Deg))

	Member Label	Direction	Magnitude[lb.k-ft]	Location[ft. %]
1	MP3A	Z	-1.887	.5
2	MP3A	Mx	0	.5
3	MP3B	Z	-1.887	.5
4	MP3B	Mx	-.000541	.5
5	MP3C	Z	-1.887	.5
6	MP3C	Mx	.000886	.5



Company :
 Designer :
 Job Number :
 Model Name :

July 6, 2023
 1:03 PM
 Checked By: _____

Member Point Loads (BLC 82 : Antenna Eh (0 Deg)) (Continued)

	Member Label	Direction	Magnitude[lb.k-ft]	Location[ft.%]
7	MP1A	Z	-2.187	.75
8	MP1A	Mx	0	.75
9	MP1A	Z	-2.187	5
10	MP1A	Mx	0	5
11	MP1B	Z	-2.187	.75
12	MP1B	Mx	.000627	.75
13	MP1B	Z	-2.187	5
14	MP1B	Mx	.000627	5
15	MP1C	Z	-2.187	.75
16	MP1C	Mx	-.001	.75
17	MP1C	Z	-2.187	5
18	MP1C	Mx	-.001	5
19	MP4A	Z	-2.466	.5
20	MP4A	Mx	-.002	.5
21	MP4A	Z	-2.466	5.5
22	MP4A	Mx	-.002	5.5
23	MP4B	Z	-2.466	.5
24	MP4B	Mx	.003	.5
25	MP4B	Z	-2.466	5.5
26	MP4B	Mx	.003	5.5
27	MP4C	Z	-2.466	.5
28	MP4C	Mx	-.000315	.5
29	MP4C	Z	-2.466	5.5
30	MP4C	Mx	-.000315	5.5
31	MP4A	Z	-2.466	.5
32	MP4A	Mx	.002	.5
33	MP4A	Z	-2.466	5.5
34	MP4A	Mx	.002	5.5
35	MP4B	Z	-2.466	.5
36	MP4B	Mx	-.001	.5
37	MP4B	Z	-2.466	5.5
38	MP4B	Mx	-.001	5.5
39	MP4C	Z	-2.466	.5
40	MP4C	Mx	-.002	.5
41	MP4C	Z	-2.466	5.5
42	MP4C	Mx	-.002	5.5
43	MP2A	Z	-4.669	1.88
44	MP2A	Mx	0	1.88
45	MP2A	Z	-4.669	3.88
46	MP2A	Mx	0	3.88
47	MP2B	Z	-4.669	1.88
48	MP2B	Mx	.001	1.88
49	MP2B	Z	-4.669	3.88
50	MP2B	Mx	.001	3.88
51	MP2C	Z	-4.669	1.88
52	MP2C	Mx	-.002	1.88
53	MP2C	Z	-4.669	3.88
54	MP2C	Mx	-.002	3.88
55	MP3A	Z	-8.008	2
56	MP3A	Mx	0	2
57	MP3B	Z	-8.008	2
58	MP3B	Mx	-.002	2
59	MP3C	Z	-8.008	2
60	MP3C	Mx	.002	2
61	MP4A	Z	-7.536	2
62	MP4A	Mx	0	2
63	MP4B	Z	-7.536	2



Company :
 Designer :
 Job Number :
 Model Name :

July 6, 2023
 1:03 PM
 Checked By: _____

Member Point Loads (BLC 82 : Antenna Eh (0 Deg)) (Continued)

	Member Label	Direction	Magnitude[lb.k-ft]	Location[ft.%]
64	MP4B	Mx	-.002	2
65	MP4C	Z	-7.536	2
66	MP4C	Mx	.002	2

Member Point Loads (BLC 83 : Antenna Eh (90 Deg))

	Member Label	Direction	Magnitude[lb.k-ft]	Location[ft.%]
1	MP3A	X	1.887	.5
2	MP3A	Mx	.000943	.5
3	MP3B	X	1.887	.5
4	MP3B	Mx	-.000773	.5
5	MP3C	X	1.887	.5
6	MP3C	Mx	-.000323	.5
7	MP1A	X	2.187	.75
8	MP1A	Mx	-.001	.75
9	MP1A	X	2.187	5
10	MP1A	Mx	-.001	5
11	MP1B	X	2.187	.75
12	MP1B	Mx	.000896	.75
13	MP1B	X	2.187	5
14	MP1B	Mx	.000896	5
15	MP1C	X	2.187	.75
16	MP1C	Mx	.000374	.75
17	MP1C	X	2.187	5
18	MP1C	Mx	.000374	5
19	MP4A	X	2.466	.5
20	MP4A	Mx	-.001	.5
21	MP4A	X	2.466	5.5
22	MP4A	Mx	-.001	5.5
23	MP4B	X	2.466	.5
24	MP4B	Mx	-.000404	.5
25	MP4B	X	2.466	5.5
26	MP4B	Mx	-.000404	5.5
27	MP4C	X	2.466	.5
28	MP4C	Mx	.003	.5
29	MP4C	X	2.466	5.5
30	MP4C	Mx	.003	5.5
31	MP4A	X	2.466	.5
32	MP4A	Mx	-.001	.5
33	MP4A	X	2.466	5.5
34	MP4A	Mx	-.001	5.5
35	MP4B	X	2.466	.5
36	MP4B	Mx	.002	.5
37	MP4B	X	2.466	5.5
38	MP4B	Mx	.002	5.5
39	MP4C	X	2.466	.5
40	MP4C	Mx	-.002	.5
41	MP4C	X	2.466	5.5
42	MP4C	Mx	-.002	5.5
43	MP2A	X	4.669	1.88
44	MP2A	Mx	-.002	1.88
45	MP2A	X	4.669	3.88
46	MP2A	Mx	-.002	3.88
47	MP2B	X	4.669	1.88
48	MP2B	Mx	.002	1.88
49	MP2B	X	4.669	3.88
50	MP2B	Mx	.002	3.88

Member Point Loads (BLC 83 : Antenna Eh (90 Deg)) (Continued)

	Member Label	Direction	Magnitude[lb.k-ft]	Location[ft.%]
51	MP2C	X	4.669	1.88
52	MP2C	Mx	.000798	1.88
53	MP2C	X	4.669	3.88
54	MP2C	Mx	.000798	3.88
55	MP3A	X	8.008	2
56	MP3A	Mx	.003	2
57	MP3B	X	8.008	2
58	MP3B	Mx	-.001	2
59	MP3C	X	8.008	2
60	MP3C	Mx	-.001	2
61	MP4A	X	7.536	2
62	MP4A	Mx	.003	2
63	MP4B	X	7.536	2
64	MP4B	Mx	-.001	2
65	MP4C	X	7.536	2
66	MP4C	Mx	-.001	2

Joint Loads and Enforced Displacements

Joint Label	L,D,M	Direction	Magnitude[(lb.k-ft), (in.rad), (lb*s^2/ft, lb*s^2*ft)]
No Data to Print ...			

Member Distributed Loads (BLC 40 : Structure Di)

	Member Label	Direction	Start Magnitude[lb/ft,F,ksf]	End Magnitude[lb/ft,F,ksf]	Start Location[ft]	End Location[ft]
1	M1	Y	-6.378	-6.378	0	%100
2	M4	Y	-9.35	-9.35	0	%100
3	M10	Y	-9.35	-9.35	0	%100
4	MP3A	Y	-4.827	-4.827	0	%100
5	MP4A	Y	-5.516	-5.516	0	%100
6	MP2A	Y	-4.827	-4.827	0	%100
7	MP1A	Y	-4.827	-4.827	0	%100
8	M43	Y	-9.35	-9.35	0	%100
9	M46	Y	-9.851	-9.851	0	%100
10	M51B	Y	-5.452	-5.452	0	%100
11	M52B	Y	-5.452	-5.452	0	%100
12	M76	Y	-9.839	-9.839	0	%100
13	M77	Y	-9.839	-9.839	0	%100
14	M80	Y	-9.851	-9.851	0	%100
15	M84	Y	-9.839	-9.839	0	%100
16	M85	Y	-9.839	-9.839	0	%100
17	M91	Y	-9.851	-9.851	0	%100
18	M52A	Y	-9.35	-9.35	0	%100
19	M53	Y	-9.35	-9.35	0	%100
20	M54	Y	-9.35	-9.35	0	%100
21	M55	Y	-9.851	-9.851	0	%100
22	M58A	Y	-5.452	-5.452	0	%100
23	M59A	Y	-5.452	-5.452	0	%100
24	M63	Y	-9.839	-9.839	0	%100
25	M64	Y	-9.839	-9.839	0	%100
26	M66	Y	-9.851	-9.851	0	%100
27	M68	Y	-9.839	-9.839	0	%100
28	M69	Y	-9.839	-9.839	0	%100
29	M71	Y	-9.851	-9.851	0	%100
30	M76A	Y	-9.35	-9.35	0	%100
31	M77A	Y	-9.35	-9.35	0	%100

Member Distributed Loads (BLC 40 : Structure Di) (Continued)

Member Label	Direction	Start Magnitude[lb/ft,F,ksf]	End Magnitude[lb/ft,F,ksf]	Start Location[f...]	End Location[ft...]
32	M78	Y	-9.35	0	%100
33	M79A	Y	-9.851	0	%100
34	M82	Y	-5.452	0	%100
35	M83A	Y	-5.452	0	%100
36	M87	Y	-9.839	0	%100
37	M88A	Y	-9.839	0	%100
38	M90	Y	-9.851	0	%100
39	M92A	Y	-9.839	0	%100
40	M93	Y	-9.839	0	%100
41	M95	Y	-9.851	0	%100
42	M82A	Y	-6.378	0	%100
43	M91B	Y	-6.378	0	%100
44	MP3C	Y	-4.827	0	%100
45	MP4C	Y	-5.516	0	%100
46	MP2C	Y	-4.827	0	%100
47	MP1C	Y	-4.827	0	%100
48	MP3B	Y	-4.827	0	%100
49	MP4B	Y	-5.516	0	%100
50	MP2B	Y	-4.827	0	%100
51	MP1B	Y	-4.827	0	%100
52	M100	Y	-5.516	0	%100
53	M105	Y	-5.516	0	%100
54	M106	Y	-5.516	0	%100
55	M121	Y	-7.401	0	%100
56	M122	Y	-7.401	0	%100
57	M123	Y	-7.401	0	%100

Member Distributed Loads (BLC 41 : Structure Wo (0 Deg))

Member Label	Direction	Start Magnitude[lb/ft,F,ksf]	End Magnitude[lb/ft,F,ksf]	Start Location[f...]	End Location[ft...]
1	M1	X	0	0	%100
2	M1	Z	-12.133	0	%100
3	M4	X	0	0	%100
4	M4	Z	0	0	%100
5	M10	X	0	0	%100
6	M10	Z	-10.428	0	%100
7	MP3A	X	0	0	%100
8	MP3A	Z	-8.233	0	%100
9	MP4A	X	0	0	%100
10	MP4A	Z	-9.966	0	%100
11	MP2A	X	0	0	%100
12	MP2A	Z	-8.233	0	%100
13	MP1A	X	0	0	%100
14	MP1A	Z	-8.233	0	%100
15	M43	X	0	0	%100
16	M43	Z	-10.428	0	%100
17	M46	X	0	0	%100
18	M46	Z	-20.799	0	%100
19	M51B	X	0	0	%100
20	M51B	Z	-2.887	0	%100
21	M52B	X	0	0	%100
22	M52B	Z	-2.887	0	%100
23	M76	X	0	0	%100
24	M76	Z	0	0	%100
25	M77	X	0	0	%100
26	M77	Z	-5.296	0	%100
27	M80	X	0	0	%100

Member Distributed Loads (BLC 41 : Structure Wo (0 Deg)) (Continued)

Member Label	Direction	Start Magnitude[lb/ft.F,ksf]	End Magnitude[lb/ft.F,ksf]	Start Locationft.	End Locationft.
28	M80	Z	-5.578	0	%100
29	M84	X	0	0	%100
30	M84	Z	0	0	%100
31	M85	X	0	0	%100
32	M85	Z	-5.296	0	%100
33	M91	X	0	0	%100
34	M91	Z	-5.578	0	%100
35	M52A	X	0	0	%100
36	M52A	Z	-9.243	0	%100
37	M53	X	0	0	%100
38	M53	Z	-2.607	0	%100
39	M54	X	0	0	%100
40	M54	Z	-2.607	0	%100
41	M55	X	0	0	%100
42	M55	Z	-5.2	0	%100
43	M58A	X	0	0	%100
44	M58A	Z	-2.887	0	%100
45	M59A	X	0	0	%100
46	M59A	Z	-11.549	0	%100
47	M63	X	0	0	%100
48	M63	Z	-15.6	0	%100
49	M64	X	0	0	%100
50	M64	Z	-5.296	0	%100
51	M66	X	0	0	%100
52	M66	Z	-5.578	0	%100
53	M68	X	0	0	%100
54	M68	Z	-15.6	0	%100
55	M69	X	0	0	%100
56	M69	Z	-21.185	0	%100
57	M71	X	0	0	%100
58	M71	Z	-22.313	0	%100
59	M76A	X	0	0	%100
60	M76A	Z	-9.243	0	%100
61	M77A	X	0	0	%100
62	M77A	Z	-2.607	0	%100
63	M78	X	0	0	%100
64	M78	Z	-2.607	0	%100
65	M79A	X	0	0	%100
66	M79A	Z	-5.2	0	%100
67	M82	X	0	0	%100
68	M82	Z	-11.549	0	%100
69	M83A	X	0	0	%100
70	M83A	Z	-2.887	0	%100
71	M87	X	0	0	%100
72	M87	Z	-15.6	0	%100
73	M88A	X	0	0	%100
74	M88A	Z	-21.185	0	%100
75	M90	X	0	0	%100
76	M90	Z	-22.313	0	%100
77	M92A	X	0	0	%100
78	M92A	Z	-15.6	0	%100
79	M93	X	0	0	%100
80	M93	Z	-5.296	0	%100
81	M95	X	0	0	%100
82	M95	Z	-5.578	0	%100
83	M82A	X	0	0	%100
84	M82A	Z	-3.033	0	%100

Member Distributed Loads (BLC 41 : Structure Wo (0 Deg)) (Continued)

Member Label	Direction	Start Magnitude[lb/ft,F,ksf]	End Magnitude[lb/ft,F,ksf]	Start Location[f..	End Location[ft..	
85	M91B	X	0	0	%100	
86	M91B	Z	-3.033	-3.033	0	%100
87	MP3C	X	0	0	0	%100
88	MP3C	Z	-8.233	-8.233	0	%100
89	MP4C	X	0	0	0	%100
90	MP4C	Z	-9.966	-9.966	0	%100
91	MP2C	X	0	0	0	%100
92	MP2C	Z	-8.233	-8.233	0	%100
93	MP1C	X	0	0	0	%100
94	MP1C	Z	-8.233	-8.233	0	%100
95	MP3B	X	0	0	0	%100
96	MP3B	Z	-8.233	-8.233	0	%100
97	MP4B	X	0	0	0	%100
98	MP4B	Z	-9.966	-9.966	0	%100
99	MP2B	X	0	0	0	%100
100	MP2B	Z	-8.233	-8.233	0	%100
101	MP1B	X	0	0	0	%100
102	MP1B	Z	-8.233	-8.233	0	%100
103	M100	X	0	0	0	%100
104	M100	Z	-9.966	-9.966	0	%100
105	M105	X	0	0	0	%100
106	M105	Z	-2.492	-2.492	0	%100
107	M106	X	0	0	0	%100
108	M106	Z	-2.492	-2.492	0	%100
109	M121	X	0	0	0	%100
110	M121	Z	-3.173	-3.173	0	%100
111	M122	X	0	0	0	%100
112	M122	Z	-12.694	-12.694	0	%100
113	M123	X	0	0	0	%100
114	M123	Z	-3.173	-3.173	0	%100

Member Distributed Loads (BLC 42 : Structure Wo (30 Deg))

Member Label	Direction	Start Magnitude[lb/ft,F,ksf]	End Magnitude[lb/ft,F,ksf]	Start Location[f..	End Location[ft..	
1	M1	X	4.55	4.55	0	%100
2	M1	Z	-7.881	-7.881	0	%100
3	M4	X	1.54	1.54	0	%100
4	M4	Z	-2.668	-2.668	0	%100
5	M10	X	3.91	3.91	0	%100
6	M10	Z	-6.773	-6.773	0	%100
7	MP3A	X	4.117	4.117	0	%100
8	MP3A	Z	-7.13	-7.13	0	%100
9	MP4A	X	4.983	4.983	0	%100
10	MP4A	Z	-8.631	-8.631	0	%100
11	MP2A	X	4.117	4.117	0	%100
12	MP2A	Z	-7.13	-7.13	0	%100
13	MP1A	X	4.117	4.117	0	%100
14	MP1A	Z	-7.13	-7.13	0	%100
15	M43	X	3.91	3.91	0	%100
16	M43	Z	-6.773	-6.773	0	%100
17	M46	X	7.8	7.8	0	%100
18	M46	Z	-13.51	-13.51	0	%100
19	M51B	X	4.331	4.331	0	%100
20	M51B	Z	-7.502	-7.502	0	%100
21	M52B	X	0	0	0	%100
22	M52B	Z	0	0	0	%100
23	M76	X	2.6	2.6	0	%100



Company :
 Designer :
 Job Number :
 Model Name :

July 6, 2023
 1:03 PM
 Checked By: _____

Member Distributed Loads (BLC 42 : Structure Wo (30 Deg)) (Continued)

Member Label	Direction	Start Magnitude[lb/ft.F.ksf]	End Magnitude[lb/ft.F.ksf]	Start Locationf..	End Locationft..
24	M76	Z	-4.503	0	%100
25	M77	X	7.944	0	%100
26	M77	Z	-13.76	0	%100
27	M80	X	8.367	0	%100
28	M80	Z	-14.493	0	%100
29	M84	X	2.6	0	%100
30	M84	Z	-4.503	0	%100
31	M85	X	0	0	%100
32	M85	Z	0	0	%100
33	M91	X	0	0	%100
34	M91	Z	0	0	%100
35	M52A	X	1.54	0	%100
36	M52A	Z	-2.668	0	%100
37	M53	X	3.91	0	%100
38	M53	Z	-6.773	0	%100
39	M54	X	3.91	0	%100
40	M54	Z	-6.773	0	%100
41	M55	X	7.8	0	%100
42	M55	Z	-13.51	0	%100
43	M58A	X	0	0	%100
44	M58A	Z	0	0	%100
45	M59A	X	4.331	0	%100
46	M59A	Z	-7.502	0	%100
47	M63	X	2.6	0	%100
48	M63	Z	-4.503	0	%100
49	M64	X	0	0	%100
50	M64	Z	0	0	%100
51	M66	X	0	0	%100
52	M66	Z	0	0	%100
53	M68	X	2.6	0	%100
54	M68	Z	-4.503	0	%100
55	M69	X	7.944	0	%100
56	M69	Z	-13.76	0	%100
57	M71	X	8.367	0	%100
58	M71	Z	-14.493	0	%100
59	M76A	X	6.162	0	%100
60	M76A	Z	-10.672	0	%100
61	M77A	X	0	0	%100
62	M77A	Z	0	0	%100
63	M78	X	0	0	%100
64	M78	Z	0	0	%100
65	M79A	X	0	0	%100
66	M79A	Z	0	0	%100
67	M82	X	4.331	0	%100
68	M82	Z	-7.502	0	%100
69	M83A	X	4.331	0	%100
70	M83A	Z	-7.502	0	%100
71	M87	X	10.4	0	%100
72	M87	Z	-18.013	0	%100
73	M88A	X	7.944	0	%100
74	M88A	Z	-13.76	0	%100
75	M90	X	8.367	0	%100
76	M90	Z	-14.493	0	%100
77	M92A	X	10.4	0	%100
78	M92A	Z	-18.013	0	%100
79	M93	X	7.944	0	%100
80	M93	Z	-13.76	0	%100



Company :
 Designer :
 Job Number :
 Model Name :

July 6, 2023
 1:03 PM
 Checked By: _____

Member Distributed Loads (BLC 42 : Structure Wo (30 Deg)) (Continued)

	Member Label	Direction	Start Magnitude[lb/ft.F,ksf]	End Magnitude[lb/ft.F,ksf]	Start Location[f..	End Location[ft..
81	M95	X	8.367	8.367	0	%100
82	M95	Z	-14.493	-14.493	0	%100
83	M82A	X	4.55	4.55	0	%100
84	M82A	Z	-7.881	-7.881	0	%100
85	M91B	X	0	0	0	%100
86	M91B	Z	0	0	0	%100
87	MP3C	X	4.117	4.117	0	%100
88	MP3C	Z	-7.13	-7.13	0	%100
89	MP4C	X	4.983	4.983	0	%100
90	MP4C	Z	-8.631	-8.631	0	%100
91	MP2C	X	4.117	4.117	0	%100
92	MP2C	Z	-7.13	-7.13	0	%100
93	MP1C	X	4.117	4.117	0	%100
94	MP1C	Z	-7.13	-7.13	0	%100
95	MP3B	X	4.117	4.117	0	%100
96	MP3B	Z	-7.13	-7.13	0	%100
97	MP4B	X	4.983	4.983	0	%100
98	MP4B	Z	-8.631	-8.631	0	%100
99	MP2B	X	4.117	4.117	0	%100
100	MP2B	Z	-7.13	-7.13	0	%100
101	MP1B	X	4.117	4.117	0	%100
102	MP1B	Z	-7.13	-7.13	0	%100
103	M100	X	3.737	3.737	0	%100
104	M100	Z	-6.473	-6.473	0	%100
105	M105	X	3.737	3.737	0	%100
106	M105	Z	-6.473	-6.473	0	%100
107	M106	X	0	0	0	%100
108	M106	Z	0	0	0	%100
109	M121	X	4.76	4.76	0	%100
110	M121	Z	-8.245	-8.245	0	%100
111	M122	X	4.76	4.76	0	%100
112	M122	Z	-8.245	-8.245	0	%100
113	M123	X	0	0	0	%100
114	M123	Z	0	0	0	%100

Member Distributed Loads (BLC 43 : Structure Wo (60 Deg))

	Member Label	Direction	Start Magnitude[lb/ft.F,ksf]	End Magnitude[lb/ft.F,ksf]	Start Location[f..	End Location[ft..
1	M1	X	2.627	2.627	0	%100
2	M1	Z	-1.517	-1.517	0	%100
3	M4	X	8.004	8.004	0	%100
4	M4	Z	-4.621	-4.621	0	%100
5	M10	X	2.258	2.258	0	%100
6	M10	Z	-1.303	-1.303	0	%100
7	MP3A	X	7.13	7.13	0	%100
8	MP3A	Z	-4.117	-4.117	0	%100
9	MP4A	X	8.631	8.631	0	%100
10	MP4A	Z	-4.983	-4.983	0	%100
11	MP2A	X	7.13	7.13	0	%100
12	MP2A	Z	-4.117	-4.117	0	%100
13	MP1A	X	7.13	7.13	0	%100
14	MP1A	Z	-4.117	-4.117	0	%100
15	M43	X	2.258	2.258	0	%100
16	M43	Z	-1.303	-1.303	0	%100
17	M46	X	4.503	4.503	0	%100
18	M46	Z	-2.6	-2.6	0	%100
19	M51B	X	10.002	10.002	0	%100



Company :
 Designer :
 Job Number :
 Model Name :

July 6, 2023
 1:03 PM
 Checked By: _____

Member Distributed Loads (BLC 43 : Structure Wo (60 Deg)) (Continued)

Member Label	Direction	Start Magnitude[lb/ft.F,ksf]	End Magnitude[lb/ft.F,ksf]	Start Locationft..	End Locationft..
20	M51B	Z	-5.775	-5.775	0 %100
21	M52B	X	2.501	2.501	0 %100
22	M52B	Z	-1.444	-1.444	0 %100
23	M76	X	13.51	13.51	0 %100
24	M76	Z	-7.8	-7.8	0 %100
25	M77	X	18.346	18.346	0 %100
26	M77	Z	-10.592	-10.592	0 %100
27	M80	X	19.324	19.324	0 %100
28	M80	Z	-11.157	-11.157	0 %100
29	M84	X	13.51	13.51	0 %100
30	M84	Z	-7.8	-7.8	0 %100
31	M85	X	4.587	4.587	0 %100
32	M85	Z	-2.648	-2.648	0 %100
33	M91	X	4.831	4.831	0 %100
34	M91	Z	-2.789	-2.789	0 %100
35	M52A	X	0	0	0 %100
36	M52A	Z	0	0	0 %100
37	M53	X	9.031	9.031	0 %100
38	M53	Z	-5.214	-5.214	0 %100
39	M54	X	9.031	9.031	0 %100
40	M54	Z	-5.214	-5.214	0 %100
41	M55	X	18.013	18.013	0 %100
42	M55	Z	-10.4	-10.4	0 %100
43	M58A	X	2.501	2.501	0 %100
44	M58A	Z	-1.444	-1.444	0 %100
45	M59A	X	2.501	2.501	0 %100
46	M59A	Z	-1.444	-1.444	0 %100
47	M63	X	0	0	0 %100
48	M63	Z	0	0	0 %100
49	M64	X	4.587	4.587	0 %100
50	M64	Z	-2.648	-2.648	0 %100
51	M66	X	4.831	4.831	0 %100
52	M66	Z	-2.789	-2.789	0 %100
53	M68	X	0	0	0 %100
54	M68	Z	0	0	0 %100
55	M69	X	4.587	4.587	0 %100
56	M69	Z	-2.648	-2.648	0 %100
57	M71	X	4.831	4.831	0 %100
58	M71	Z	-2.789	-2.789	0 %100
59	M76A	X	8.004	8.004	0 %100
60	M76A	Z	-4.621	-4.621	0 %100
61	M77A	X	2.258	2.258	0 %100
62	M77A	Z	-1.303	-1.303	0 %100
63	M78	X	2.258	2.258	0 %100
64	M78	Z	-1.303	-1.303	0 %100
65	M79A	X	4.503	4.503	0 %100
66	M79A	Z	-2.6	-2.6	0 %100
67	M82	X	2.501	2.501	0 %100
68	M82	Z	-1.444	-1.444	0 %100
69	M83A	X	10.002	10.002	0 %100
70	M83A	Z	-5.775	-5.775	0 %100
71	M87	X	13.51	13.51	0 %100
72	M87	Z	-7.8	-7.8	0 %100
73	M88A	X	4.587	4.587	0 %100
74	M88A	Z	-2.648	-2.648	0 %100
75	M90	X	4.831	4.831	0 %100
76	M90	Z	-2.789	-2.789	0 %100

Member Distributed Loads (BLC 43 : Structure Wo (60 Deg)) (Continued)

	Member Label	Direction	Start Magnitude[lb/ft.F,ksf]	End Magnitude[lb/ft.F,ksf]	Start Location[f..	End Location[ft..
77	M92A	X	13.51	13.51	0	%100
78	M92A	Z	-7.8	-7.8	0	%100
79	M93	X	18.346	18.346	0	%100
80	M93	Z	-10.592	-10.592	0	%100
81	M95	X	19.324	19.324	0	%100
82	M95	Z	-11.157	-11.157	0	%100
83	M82A	X	10.507	10.507	0	%100
84	M82A	Z	-6.066	-6.066	0	%100
85	M91B	X	2.627	2.627	0	%100
86	M91B	Z	-1.517	-1.517	0	%100
87	MP3C	X	7.13	7.13	0	%100
88	MP3C	Z	-4.117	-4.117	0	%100
89	MP4C	X	8.631	8.631	0	%100
90	MP4C	Z	-4.983	-4.983	0	%100
91	MP2C	X	7.13	7.13	0	%100
92	MP2C	Z	-4.117	-4.117	0	%100
93	MP1C	X	7.13	7.13	0	%100
94	MP1C	Z	-4.117	-4.117	0	%100
95	MP3B	X	7.13	7.13	0	%100
96	MP3B	Z	-4.117	-4.117	0	%100
97	MP4B	X	8.631	8.631	0	%100
98	MP4B	Z	-4.983	-4.983	0	%100
99	MP2B	X	7.13	7.13	0	%100
100	MP2B	Z	-4.117	-4.117	0	%100
101	MP1B	X	7.13	7.13	0	%100
102	MP1B	Z	-4.117	-4.117	0	%100
103	M100	X	2.158	2.158	0	%100
104	M100	Z	-1.246	-1.246	0	%100
105	M105	X	8.631	8.631	0	%100
106	M105	Z	-4.983	-4.983	0	%100
107	M106	X	2.158	2.158	0	%100
108	M106	Z	-1.246	-1.246	0	%100
109	M121	X	10.993	10.993	0	%100
110	M121	Z	-6.347	-6.347	0	%100
111	M122	X	2.748	2.748	0	%100
112	M122	Z	-1.587	-1.587	0	%100
113	M123	X	2.748	2.748	0	%100
114	M123	Z	-1.587	-1.587	0	%100

Member Distributed Loads (BLC 44 : Structure Wo (90 Deg))

	Member Label	Direction	Start Magnitude[lb/ft.F,ksf]	End Magnitude[lb/ft.F,ksf]	Start Location[f..	End Location[ft..
1	M1	X	0	0	0	%100
2	M1	Z	0	0	0	%100
3	M4	X	12.324	12.324	0	%100
4	M4	Z	0	0	0	%100
5	M10	X	0	0	0	%100
6	M10	Z	0	0	0	%100
7	MP3A	X	8.233	8.233	0	%100
8	MP3A	Z	0	0	0	%100
9	MP4A	X	9.966	9.966	0	%100
10	MP4A	Z	0	0	0	%100
11	MP2A	X	8.233	8.233	0	%100
12	MP2A	Z	0	0	0	%100
13	MP1A	X	8.233	8.233	0	%100
14	MP1A	Z	0	0	0	%100
15	M43	X	0	0	0	%100



Company :
 Designer :
 Job Number :
 Model Name :

July 6, 2023
 1:03 PM
 Checked By: _____

Member Distributed Loads (BLC 44 : Structure Wo (90 Deg)) (Continued)

Member Label	Direction	Start Magnitude[lb/ft,F,ksf]	End Magnitude[lb/ft,F,ksf]	Start Locationf..	End Locationft..	
16	M43	Z	0	0	%100	
17	M46	X	0	0	%100	
18	M46	Z	0	0	%100	
19	M51B	X	8.662	8.662	0	%100
20	M51B	Z	0	0	%100	
21	M52B	X	8.662	8.662	0	%100
22	M52B	Z	0	0	%100	
23	M76	X	20.799	20.799	0	%100
24	M76	Z	0	0	%100	
25	M77	X	15.888	15.888	0	%100
26	M77	Z	0	0	%100	
27	M80	X	16.735	16.735	0	%100
28	M80	Z	0	0	%100	
29	M84	X	20.799	20.799	0	%100
30	M84	Z	0	0	%100	
31	M85	X	15.888	15.888	0	%100
32	M85	Z	0	0	%100	
33	M91	X	16.735	16.735	0	%100
34	M91	Z	0	0	%100	
35	M52A	X	3.081	3.081	0	%100
36	M52A	Z	0	0	%100	
37	M53	X	7.821	7.821	0	%100
38	M53	Z	0	0	%100	
39	M54	X	7.821	7.821	0	%100
40	M54	Z	0	0	%100	
41	M55	X	15.6	15.6	0	%100
42	M55	Z	0	0	%100	
43	M58A	X	8.662	8.662	0	%100
44	M58A	Z	0	0	%100	
45	M59A	X	0	0	0	%100
46	M59A	Z	0	0	0	%100
47	M63	X	5.2	5.2	0	%100
48	M63	Z	0	0	0	%100
49	M64	X	15.888	15.888	0	%100
50	M64	Z	0	0	0	%100
51	M66	X	16.735	16.735	0	%100
52	M66	Z	0	0	0	%100
53	M68	X	5.2	5.2	0	%100
54	M68	Z	0	0	0	%100
55	M69	X	0	0	0	%100
56	M69	Z	0	0	0	%100
57	M71	X	0	0	0	%100
58	M71	Z	0	0	0	%100
59	M76A	X	3.081	3.081	0	%100
60	M76A	Z	0	0	0	%100
61	M77A	X	7.821	7.821	0	%100
62	M77A	Z	0	0	0	%100
63	M78	X	7.821	7.821	0	%100
64	M78	Z	0	0	0	%100
65	M79A	X	15.6	15.6	0	%100
66	M79A	Z	0	0	0	%100
67	M82	X	0	0	0	%100
68	M82	Z	0	0	0	%100
69	M83A	X	8.662	8.662	0	%100
70	M83A	Z	0	0	0	%100
71	M87	X	5.2	5.2	0	%100
72	M87	Z	0	0	0	%100

Member Distributed Loads (BLC 44 : Structure Wo (90 Deg)) (Continued)

	Member Label	Direction	Start Magnitude[lb/ft,F,ksf]	End Magnitude[lb/ft,F,ksf]	Start Location[f..	End Location[ft..
73	M88A	X	0	0	0	%100
74	M88A	Z	0	0	0	%100
75	M90	X	0	0	0	%100
76	M90	Z	0	0	0	%100
77	M92A	X	5.2	5.2	0	%100
78	M92A	Z	0	0	0	%100
79	M93	X	15.888	15.888	0	%100
80	M93	Z	0	0	0	%100
81	M95	X	16.735	16.735	0	%100
82	M95	Z	0	0	0	%100
83	M82A	X	9.1	9.1	0	%100
84	M82A	Z	0	0	0	%100
85	M91B	X	9.1	9.1	0	%100
86	M91B	Z	0	0	0	%100
87	MP3C	X	8.233	8.233	0	%100
88	MP3C	Z	0	0	0	%100
89	MP4C	X	9.966	9.966	0	%100
90	MP4C	Z	0	0	0	%100
91	MP2C	X	8.233	8.233	0	%100
92	MP2C	Z	0	0	0	%100
93	MP1C	X	8.233	8.233	0	%100
94	MP1C	Z	0	0	0	%100
95	MP3B	X	8.233	8.233	0	%100
96	MP3B	Z	0	0	0	%100
97	MP4B	X	9.966	9.966	0	%100
98	MP4B	Z	0	0	0	%100
99	MP2B	X	8.233	8.233	0	%100
100	MP2B	Z	0	0	0	%100
101	MP1B	X	8.233	8.233	0	%100
102	MP1B	Z	0	0	0	%100
103	M100	X	0	0	0	%100
104	M100	Z	0	0	0	%100
105	M105	X	7.475	7.475	0	%100
106	M105	Z	0	0	0	%100
107	M106	X	7.475	7.475	0	%100
108	M106	Z	0	0	0	%100
109	M121	X	9.52	9.52	0	%100
110	M121	Z	0	0	0	%100
111	M122	X	0	0	0	%100
112	M122	Z	0	0	0	%100
113	M123	X	9.52	9.52	0	%100
114	M123	Z	0	0	0	%100

Member Distributed Loads (BLC 45 : Structure Wo (120 Deg))

	Member Label	Direction	Start Magnitude[lb/ft,F,ksf]	End Magnitude[lb/ft,F,ksf]	Start Location[f..	End Location[ft..
1	M1	X	2.627	2.627	0	%100
2	M1	Z	1.517	1.517	0	%100
3	M4	X	8.004	8.004	0	%100
4	M4	Z	4.621	4.621	0	%100
5	M10	X	2.258	2.258	0	%100
6	M10	Z	1.303	1.303	0	%100
7	MP3A	X	7.13	7.13	0	%100
8	MP3A	Z	4.117	4.117	0	%100
9	MP4A	X	8.631	8.631	0	%100
10	MP4A	Z	4.983	4.983	0	%100
11	MP2A	X	7.13	7.13	0	%100

Member Distributed Loads (BLC 45 : Structure Wo (120 Deg)) (Continued)

Member Label	Direction	Start Magnitude[lb/ft,F,ksf]	End Magnitude[lb/ft,F,ksf]	Start Location[ft..]	End Location[ft..]
12	MP2A	Z	4.117	4.117	0 %100
13	MP1A	X	7.13	7.13	0 %100
14	MP1A	Z	4.117	4.117	0 %100
15	M43	X	2.258	2.258	0 %100
16	M43	Z	1.303	1.303	0 %100
17	M46	X	4.503	4.503	0 %100
18	M46	Z	2.6	2.6	0 %100
19	M51B	X	2.501	2.501	0 %100
20	M51B	Z	1.444	1.444	0 %100
21	M52B	X	10.002	10.002	0 %100
22	M52B	Z	5.775	5.775	0 %100
23	M76	X	13.51	13.51	0 %100
24	M76	Z	7.8	7.8	0 %100
25	M77	X	4.587	4.587	0 %100
26	M77	Z	2.648	2.648	0 %100
27	M80	X	4.831	4.831	0 %100
28	M80	Z	2.789	2.789	0 %100
29	M84	X	13.51	13.51	0 %100
30	M84	Z	7.8	7.8	0 %100
31	M85	X	18.346	18.346	0 %100
32	M85	Z	10.592	10.592	0 %100
33	M91	X	19.324	19.324	0 %100
34	M91	Z	11.157	11.157	0 %100
35	M52A	X	8.004	8.004	0 %100
36	M52A	Z	4.621	4.621	0 %100
37	M53	X	2.258	2.258	0 %100
38	M53	Z	1.303	1.303	0 %100
39	M54	X	2.258	2.258	0 %100
40	M54	Z	1.303	1.303	0 %100
41	M55	X	4.503	4.503	0 %100
42	M55	Z	2.6	2.6	0 %100
43	M58A	X	10.002	10.002	0 %100
44	M58A	Z	5.775	5.775	0 %100
45	M59A	X	2.501	2.501	0 %100
46	M59A	Z	1.444	1.444	0 %100
47	M63	X	13.51	13.51	0 %100
48	M63	Z	7.8	7.8	0 %100
49	M64	X	18.346	18.346	0 %100
50	M64	Z	10.592	10.592	0 %100
51	M66	X	19.324	19.324	0 %100
52	M66	Z	11.157	11.157	0 %100
53	M68	X	13.51	13.51	0 %100
54	M68	Z	7.8	7.8	0 %100
55	M69	X	4.587	4.587	0 %100
56	M69	Z	2.648	2.648	0 %100
57	M71	X	4.831	4.831	0 %100
58	M71	Z	2.789	2.789	0 %100
59	M76A	X	0	0	0 %100
60	M76A	Z	0	0	0 %100
61	M77A	X	9.031	9.031	0 %100
62	M77A	Z	5.214	5.214	0 %100
63	M78	X	9.031	9.031	0 %100
64	M78	Z	5.214	5.214	0 %100
65	M79A	X	18.013	18.013	0 %100
66	M79A	Z	10.4	10.4	0 %100
67	M82	X	2.501	2.501	0 %100
68	M82	Z	1.444	1.444	0 %100



Company :
 Designer :
 Job Number :
 Model Name :

July 6, 2023
 1:03 PM
 Checked By: _____

Member Distributed Loads (BLC 45 : Structure Wo (120 Deg)) (Continued)

	Member Label	Direction	Start Magnitude[lb/ft,F,ksf]	End Magnitude[lb/ft,F,ksf]	Start Location[f...]	End Location[ft...]
69	M83A	X	2.501	2.501	0	%100
70	M83A	Z	1.444	1.444	0	%100
71	M87	X	0	0	0	%100
72	M87	Z	0	0	0	%100
73	M88A	X	4.587	4.587	0	%100
74	M88A	Z	2.648	2.648	0	%100
75	M90	X	4.831	4.831	0	%100
76	M90	Z	2.789	2.789	0	%100
77	M92A	X	0	0	0	%100
78	M92A	Z	0	0	0	%100
79	M93	X	4.587	4.587	0	%100
80	M93	Z	2.648	2.648	0	%100
81	M95	X	4.831	4.831	0	%100
82	M95	Z	2.789	2.789	0	%100
83	M82A	X	2.627	2.627	0	%100
84	M82A	Z	1.517	1.517	0	%100
85	M91B	X	10.507	10.507	0	%100
86	M91B	Z	6.066	6.066	0	%100
87	MP3C	X	7.13	7.13	0	%100
88	MP3C	Z	4.117	4.117	0	%100
89	MP4C	X	8.631	8.631	0	%100
90	MP4C	Z	4.983	4.983	0	%100
91	MP2C	X	7.13	7.13	0	%100
92	MP2C	Z	4.117	4.117	0	%100
93	MP1C	X	7.13	7.13	0	%100
94	MP1C	Z	4.117	4.117	0	%100
95	MP3B	X	7.13	7.13	0	%100
96	MP3B	Z	4.117	4.117	0	%100
97	MP4B	X	8.631	8.631	0	%100
98	MP4B	Z	4.983	4.983	0	%100
99	MP2B	X	7.13	7.13	0	%100
100	MP2B	Z	4.117	4.117	0	%100
101	MP1B	X	7.13	7.13	0	%100
102	MP1B	Z	4.117	4.117	0	%100
103	M100	X	2.158	2.158	0	%100
104	M100	Z	1.246	1.246	0	%100
105	M105	X	2.158	2.158	0	%100
106	M105	Z	1.246	1.246	0	%100
107	M106	X	8.631	8.631	0	%100
108	M106	Z	4.983	4.983	0	%100
109	M121	X	2.748	2.748	0	%100
110	M121	Z	1.587	1.587	0	%100
111	M122	X	2.748	2.748	0	%100
112	M122	Z	1.587	1.587	0	%100
113	M123	X	10.993	10.993	0	%100
114	M123	Z	6.347	6.347	0	%100

Member Distributed Loads (BLC 46 : Structure Wo (150 Deg))

	Member Label	Direction	Start Magnitude[lb/ft,F,ksf]	End Magnitude[lb/ft,F,ksf]	Start Location[f...]	End Location[ft...]
1	M1	X	4.55	4.55	0	%100
2	M1	Z	7.881	7.881	0	%100
3	M4	X	1.54	1.54	0	%100
4	M4	Z	2.668	2.668	0	%100
5	M10	X	3.91	3.91	0	%100
6	M10	Z	6.773	6.773	0	%100
7	MP3A	X	4.117	4.117	0	%100

Member Distributed Loads (BLC 46 : Structure Wo (150 Deg)) (Continued)

Member Label	Direction	Start Magnitude[lb/ft,F,ksf]	End Magnitude[lb/ft,F,ksf]	Start Locationft..	End Locationft..
8	MP3A	Z	7.13	0	%100
9	MP4A	X	4.983	0	%100
10	MP4A	Z	8.631	0	%100
11	MP2A	X	4.117	0	%100
12	MP2A	Z	7.13	0	%100
13	MP1A	X	4.117	0	%100
14	MP1A	Z	7.13	0	%100
15	M43	X	3.91	0	%100
16	M43	Z	6.773	0	%100
17	M46	X	7.8	0	%100
18	M46	Z	13.51	0	%100
19	M51B	X	0	0	%100
20	M51B	Z	0	0	%100
21	M52B	X	4.331	0	%100
22	M52B	Z	7.502	0	%100
23	M76	X	2.6	0	%100
24	M76	Z	4.503	0	%100
25	M77	X	0	0	%100
26	M77	Z	0	0	%100
27	M80	X	0	0	%100
28	M80	Z	0	0	%100
29	M84	X	2.6	0	%100
30	M84	Z	4.503	0	%100
31	M85	X	7.944	0	%100
32	M85	Z	13.76	0	%100
33	M91	X	8.367	0	%100
34	M91	Z	14.493	0	%100
35	M52A	X	6.162	0	%100
36	M52A	Z	10.672	0	%100
37	M53	X	0	0	%100
38	M53	Z	0	0	%100
39	M54	X	0	0	%100
40	M54	Z	0	0	%100
41	M55	X	0	0	%100
42	M55	Z	0	0	%100
43	M58A	X	4.331	0	%100
44	M58A	Z	7.502	0	%100
45	M59A	X	4.331	0	%100
46	M59A	Z	7.502	0	%100
47	M63	X	10.4	0	%100
48	M63	Z	18.013	0	%100
49	M64	X	7.944	0	%100
50	M64	Z	13.76	0	%100
51	M66	X	8.367	0	%100
52	M66	Z	14.493	0	%100
53	M68	X	10.4	0	%100
54	M68	Z	18.013	0	%100
55	M69	X	7.944	0	%100
56	M69	Z	13.76	0	%100
57	M71	X	8.367	0	%100
58	M71	Z	14.493	0	%100
59	M76A	X	1.54	0	%100
60	M76A	Z	2.668	0	%100
61	M77A	X	3.91	0	%100
62	M77A	Z	6.773	0	%100
63	M78	X	3.91	0	%100
64	M78	Z	6.773	0	%100

Member Distributed Loads (BLC 46 : Structure Wo (150 Deg)) (Continued)

Member Label	Direction	Start Magnitude[lb/ft,F,ksf]	End Magnitude[lb/ft,F,ksf]	Start Location[f...]	End Location[ft...]
65	M79A	X	7.8	0	%100
66	M79A	Z	13.51	0	%100
67	M82	X	4.331	0	%100
68	M82	Z	7.502	0	%100
69	M83A	X	0	0	%100
70	M83A	Z	0	0	%100
71	M87	X	2.6	0	%100
72	M87	Z	4.503	0	%100
73	M88A	X	7.944	0	%100
74	M88A	Z	13.76	0	%100
75	M90	X	8.367	0	%100
76	M90	Z	14.493	0	%100
77	M92A	X	2.6	0	%100
78	M92A	Z	4.503	0	%100
79	M93	X	0	0	%100
80	M93	Z	0	0	%100
81	M95	X	0	0	%100
82	M95	Z	0	0	%100
83	M82A	X	0	0	%100
84	M82A	Z	0	0	%100
85	M91B	X	4.55	0	%100
86	M91B	Z	7.881	0	%100
87	MP3C	X	4.117	0	%100
88	MP3C	Z	7.13	0	%100
89	MP4C	X	4.983	0	%100
90	MP4C	Z	8.631	0	%100
91	MP2C	X	4.117	0	%100
92	MP2C	Z	7.13	0	%100
93	MP1C	X	4.117	0	%100
94	MP1C	Z	7.13	0	%100
95	MP3B	X	4.117	0	%100
96	MP3B	Z	7.13	0	%100
97	MP4B	X	4.983	0	%100
98	MP4B	Z	8.631	0	%100
99	MP2B	X	4.117	0	%100
100	MP2B	Z	7.13	0	%100
101	MP1B	X	4.117	0	%100
102	MP1B	Z	7.13	0	%100
103	M100	X	3.737	0	%100
104	M100	Z	6.473	0	%100
105	M105	X	0	0	%100
106	M105	Z	0	0	%100
107	M106	X	3.737	0	%100
108	M106	Z	6.473	0	%100
109	M121	X	0	0	%100
110	M121	Z	0	0	%100
111	M122	X	4.76	0	%100
112	M122	Z	8.245	0	%100
113	M123	X	4.76	0	%100
114	M123	Z	8.245	0	%100

Member Distributed Loads (BLC 47 : Structure Wo (180 Deg))

Member Label	Direction	Start Magnitude[lb/ft,F,ksf]	End Magnitude[lb/ft,F,ksf]	Start Location[f...]	End Location[ft...]
1	M1	X	0	0	%100
2	M1	Z	12.133	0	%100
3	M4	X	0	0	%100

Member Distributed Loads (BLC 47 : Structure Wo (180 Deg)) (Continued)

Member Label	Direction	Start Magnitude[lb/ft.F,ksf]	End Magnitude[lb/ft.F,ksf]	Start Locationf..	End Locationft..
4	M4	Z	0	0	%100
5	M10	X	0	0	%100
6	M10	Z	10.428	0	%100
7	MP3A	X	0	0	%100
8	MP3A	Z	8.233	0	%100
9	MP4A	X	0	0	%100
10	MP4A	Z	9.966	0	%100
11	MP2A	X	0	0	%100
12	MP2A	Z	8.233	0	%100
13	MP1A	X	0	0	%100
14	MP1A	Z	8.233	0	%100
15	M43	X	0	0	%100
16	M43	Z	10.428	0	%100
17	M46	X	0	0	%100
18	M46	Z	20.799	0	%100
19	M51B	X	0	0	%100
20	M51B	Z	2.887	0	%100
21	M52B	X	0	0	%100
22	M52B	Z	2.887	0	%100
23	M76	X	0	0	%100
24	M76	Z	0	0	%100
25	M77	X	0	0	%100
26	M77	Z	5.296	0	%100
27	M80	X	0	0	%100
28	M80	Z	5.578	0	%100
29	M84	X	0	0	%100
30	M84	Z	0	0	%100
31	M85	X	0	0	%100
32	M85	Z	5.296	0	%100
33	M91	X	0	0	%100
34	M91	Z	5.578	0	%100
35	M52A	X	0	0	%100
36	M52A	Z	9.243	0	%100
37	M53	X	0	0	%100
38	M53	Z	2.607	0	%100
39	M54	X	0	0	%100
40	M54	Z	2.607	0	%100
41	M55	X	0	0	%100
42	M55	Z	5.2	0	%100
43	M58A	X	0	0	%100
44	M58A	Z	2.887	0	%100
45	M59A	X	0	0	%100
46	M59A	Z	11.549	0	%100
47	M63	X	0	0	%100
48	M63	Z	15.6	0	%100
49	M64	X	0	0	%100
50	M64	Z	5.296	0	%100
51	M66	X	0	0	%100
52	M66	Z	5.578	0	%100
53	M68	X	0	0	%100
54	M68	Z	15.6	0	%100
55	M69	X	0	0	%100
56	M69	Z	21.185	0	%100
57	M71	X	0	0	%100
58	M71	Z	22.313	0	%100
59	M76A	X	0	0	%100
60	M76A	Z	9.243	0	%100



Company :
 Designer :
 Job Number :
 Model Name :

July 6, 2023
 1:03 PM
 Checked By: _____

Member Distributed Loads (BLC 47 : Structure Wo (180 Deg)) (Continued)

Member Label	Direction	Start Magnitude[lb/ft,F,ksf]	End Magnitude[lb/ft,F,ksf]	Start Location[f..	End Location[ft..
61	M77A	X	0	0	%100
62	M77A	Z	2.607	2.607	%100
63	M78	X	0	0	%100
64	M78	Z	2.607	2.607	%100
65	M79A	X	0	0	%100
66	M79A	Z	5.2	5.2	%100
67	M82	X	0	0	%100
68	M82	Z	11.549	11.549	%100
69	M83A	X	0	0	%100
70	M83A	Z	2.887	2.887	%100
71	M87	X	0	0	%100
72	M87	Z	15.6	15.6	%100
73	M88A	X	0	0	%100
74	M88A	Z	21.185	21.185	%100
75	M90	X	0	0	%100
76	M90	Z	22.313	22.313	%100
77	M92A	X	0	0	%100
78	M92A	Z	15.6	15.6	%100
79	M93	X	0	0	%100
80	M93	Z	5.296	5.296	%100
81	M95	X	0	0	%100
82	M95	Z	5.578	5.578	%100
83	M82A	X	0	0	%100
84	M82A	Z	3.033	3.033	%100
85	M91B	X	0	0	%100
86	M91B	Z	3.033	3.033	%100
87	MP3C	X	0	0	%100
88	MP3C	Z	8.233	8.233	%100
89	MP4C	X	0	0	%100
90	MP4C	Z	9.966	9.966	%100
91	MP2C	X	0	0	%100
92	MP2C	Z	8.233	8.233	%100
93	MP1C	X	0	0	%100
94	MP1C	Z	8.233	8.233	%100
95	MP3B	X	0	0	%100
96	MP3B	Z	8.233	8.233	%100
97	MP4B	X	0	0	%100
98	MP4B	Z	9.966	9.966	%100
99	MP2B	X	0	0	%100
100	MP2B	Z	8.233	8.233	%100
101	MP1B	X	0	0	%100
102	MP1B	Z	8.233	8.233	%100
103	M100	X	0	0	%100
104	M100	Z	9.966	9.966	%100
105	M105	X	0	0	%100
106	M105	Z	2.492	2.492	%100
107	M106	X	0	0	%100
108	M106	Z	2.492	2.492	%100
109	M121	X	0	0	%100
110	M121	Z	3.173	3.173	%100
111	M122	X	0	0	%100
112	M122	Z	12.694	12.694	%100
113	M123	X	0	0	%100
114	M123	Z	3.173	3.173	%100

Member Distributed Loads (BLC 48 : Structure Wo (210 Deg))

Member Label	Direction	Start Magnitude[lb/ft,F,ksf]	End Magnitude[lb/ft,F,ksf]	Start Location[f..	End Location[ft..
--------------	-----------	------------------------------	----------------------------	--------------------	-------------------

Member Distributed Loads (BLC 48 : Structure Wo (210 Deg)) (Continued)

	Member Label	Direction	Start Magnitude[lb/ft,F,ksf]	End Magnitude[lb/ft,F,ksf]	Start Location[f..	End Location[ft..
1	M1	X	-4.55	-4.55	0	%100
2	M1	Z	7.881	7.881	0	%100
3	M4	X	-1.54	-1.54	0	%100
4	M4	Z	2.668	2.668	0	%100
5	M10	X	-3.91	-3.91	0	%100
6	M10	Z	6.773	6.773	0	%100
7	MP3A	X	-4.117	-4.117	0	%100
8	MP3A	Z	7.13	7.13	0	%100
9	MP4A	X	-4.983	-4.983	0	%100
10	MP4A	Z	8.631	8.631	0	%100
11	MP2A	X	-4.117	-4.117	0	%100
12	MP2A	Z	7.13	7.13	0	%100
13	MP1A	X	-4.117	-4.117	0	%100
14	MP1A	Z	7.13	7.13	0	%100
15	M43	X	-3.91	-3.91	0	%100
16	M43	Z	6.773	6.773	0	%100
17	M46	X	-7.8	-7.8	0	%100
18	M46	Z	13.51	13.51	0	%100
19	M51B	X	-4.331	-4.331	0	%100
20	M51B	Z	7.502	7.502	0	%100
21	M52B	X	0	0	0	%100
22	M52B	Z	0	0	0	%100
23	M76	X	-2.6	-2.6	0	%100
24	M76	Z	4.503	4.503	0	%100
25	M77	X	-7.944	-7.944	0	%100
26	M77	Z	13.76	13.76	0	%100
27	M80	X	-8.367	-8.367	0	%100
28	M80	Z	14.493	14.493	0	%100
29	M84	X	-2.6	-2.6	0	%100
30	M84	Z	4.503	4.503	0	%100
31	M85	X	0	0	0	%100
32	M85	Z	0	0	0	%100
33	M91	X	0	0	0	%100
34	M91	Z	0	0	0	%100
35	M52A	X	-1.54	-1.54	0	%100
36	M52A	Z	2.668	2.668	0	%100
37	M53	X	-3.91	-3.91	0	%100
38	M53	Z	6.773	6.773	0	%100
39	M54	X	-3.91	-3.91	0	%100
40	M54	Z	6.773	6.773	0	%100
41	M55	X	-7.8	-7.8	0	%100
42	M55	Z	13.51	13.51	0	%100
43	M58A	X	0	0	0	%100
44	M58A	Z	0	0	0	%100
45	M59A	X	-4.331	-4.331	0	%100
46	M59A	Z	7.502	7.502	0	%100
47	M63	X	-2.6	-2.6	0	%100
48	M63	Z	4.503	4.503	0	%100
49	M64	X	0	0	0	%100
50	M64	Z	0	0	0	%100
51	M66	X	0	0	0	%100
52	M66	Z	0	0	0	%100
53	M68	X	-2.6	-2.6	0	%100
54	M68	Z	4.503	4.503	0	%100
55	M69	X	-7.944	-7.944	0	%100
56	M69	Z	13.76	13.76	0	%100
57	M71	X	-8.367	-8.367	0	%100

Member Distributed Loads (BLC 48 : Structure Wo (210 Deg)) (Continued)

Member Label	Direction	Start Magnitude[lb/ft.F.ksf]	End Magnitude[lb/ft.F.ksf]	Start Locationft.	End Locationft.
58	M71	Z	14.493	14.493	0 %100
59	M76A	X	-6.162	-6.162	0 %100
60	M76A	Z	10.672	10.672	0 %100
61	M77A	X	0	0	0 %100
62	M77A	Z	0	0	0 %100
63	M78	X	0	0	0 %100
64	M78	Z	0	0	0 %100
65	M79A	X	0	0	0 %100
66	M79A	Z	0	0	0 %100
67	M82	X	-4.331	-4.331	0 %100
68	M82	Z	7.502	7.502	0 %100
69	M83A	X	-4.331	-4.331	0 %100
70	M83A	Z	7.502	7.502	0 %100
71	M87	X	-10.4	-10.4	0 %100
72	M87	Z	18.013	18.013	0 %100
73	M88A	X	-7.944	-7.944	0 %100
74	M88A	Z	13.76	13.76	0 %100
75	M90	X	-8.367	-8.367	0 %100
76	M90	Z	14.493	14.493	0 %100
77	M92A	X	-10.4	-10.4	0 %100
78	M92A	Z	18.013	18.013	0 %100
79	M93	X	-7.944	-7.944	0 %100
80	M93	Z	13.76	13.76	0 %100
81	M95	X	-8.367	-8.367	0 %100
82	M95	Z	14.493	14.493	0 %100
83	M82A	X	-4.55	-4.55	0 %100
84	M82A	Z	7.881	7.881	0 %100
85	M91B	X	0	0	0 %100
86	M91B	Z	0	0	0 %100
87	MP3C	X	-4.117	-4.117	0 %100
88	MP3C	Z	7.13	7.13	0 %100
89	MP4C	X	-4.983	-4.983	0 %100
90	MP4C	Z	8.631	8.631	0 %100
91	MP2C	X	-4.117	-4.117	0 %100
92	MP2C	Z	7.13	7.13	0 %100
93	MP1C	X	-4.117	-4.117	0 %100
94	MP1C	Z	7.13	7.13	0 %100
95	MP3B	X	-4.117	-4.117	0 %100
96	MP3B	Z	7.13	7.13	0 %100
97	MP4B	X	-4.983	-4.983	0 %100
98	MP4B	Z	8.631	8.631	0 %100
99	MP2B	X	-4.117	-4.117	0 %100
100	MP2B	Z	7.13	7.13	0 %100
101	MP1B	X	-4.117	-4.117	0 %100
102	MP1B	Z	7.13	7.13	0 %100
103	M100	X	-3.737	-3.737	0 %100
104	M100	Z	6.473	6.473	0 %100
105	M105	X	-3.737	-3.737	0 %100
106	M105	Z	6.473	6.473	0 %100
107	M106	X	0	0	0 %100
108	M106	Z	0	0	0 %100
109	M121	X	-4.76	-4.76	0 %100
110	M121	Z	8.245	8.245	0 %100
111	M122	X	-4.76	-4.76	0 %100
112	M122	Z	8.245	8.245	0 %100
113	M123	X	0	0	0 %100
114	M123	Z	0	0	0 %100



Company :
 Designer :
 Job Number :
 Model Name :

July 6, 2023
 1:03 PM
 Checked By: _____

Member Distributed Loads (BLC 49 : Structure Wo (240 Deg))

	Member Label	Direction	Start Magnitude[lb/ft,F,ksf]	End Magnitude[lb/ft,F,ksf]	Start Location[f...]	End Location[ft...]
1	M1	X	-2.627	-2.627	0	%100
2	M1	Z	1.517	1.517	0	%100
3	M4	X	-8.004	-8.004	0	%100
4	M4	Z	4.621	4.621	0	%100
5	M10	X	-2.258	-2.258	0	%100
6	M10	Z	1.303	1.303	0	%100
7	MP3A	X	-7.13	-7.13	0	%100
8	MP3A	Z	4.117	4.117	0	%100
9	MP4A	X	-8.631	-8.631	0	%100
10	MP4A	Z	4.983	4.983	0	%100
11	MP2A	X	-7.13	-7.13	0	%100
12	MP2A	Z	4.117	4.117	0	%100
13	MP1A	X	-7.13	-7.13	0	%100
14	MP1A	Z	4.117	4.117	0	%100
15	M43	X	-2.258	-2.258	0	%100
16	M43	Z	1.303	1.303	0	%100
17	M46	X	-4.503	-4.503	0	%100
18	M46	Z	2.6	2.6	0	%100
19	M51B	X	-10.002	-10.002	0	%100
20	M51B	Z	5.775	5.775	0	%100
21	M52B	X	-2.501	-2.501	0	%100
22	M52B	Z	1.444	1.444	0	%100
23	M76	X	-13.51	-13.51	0	%100
24	M76	Z	7.8	7.8	0	%100
25	M77	X	-18.346	-18.346	0	%100
26	M77	Z	10.592	10.592	0	%100
27	M80	X	-19.324	-19.324	0	%100
28	M80	Z	11.157	11.157	0	%100
29	M84	X	-13.51	-13.51	0	%100
30	M84	Z	7.8	7.8	0	%100
31	M85	X	-4.587	-4.587	0	%100
32	M85	Z	2.648	2.648	0	%100
33	M91	X	-4.831	-4.831	0	%100
34	M91	Z	2.789	2.789	0	%100
35	M52A	X	0	0	0	%100
36	M52A	Z	0	0	0	%100
37	M53	X	-9.031	-9.031	0	%100
38	M53	Z	5.214	5.214	0	%100
39	M54	X	-9.031	-9.031	0	%100
40	M54	Z	5.214	5.214	0	%100
41	M55	X	-18.013	-18.013	0	%100
42	M55	Z	10.4	10.4	0	%100
43	M58A	X	-2.501	-2.501	0	%100
44	M58A	Z	1.444	1.444	0	%100
45	M59A	X	-2.501	-2.501	0	%100
46	M59A	Z	1.444	1.444	0	%100
47	M63	X	0	0	0	%100
48	M63	Z	0	0	0	%100
49	M64	X	-4.587	-4.587	0	%100
50	M64	Z	2.648	2.648	0	%100
51	M66	X	-4.831	-4.831	0	%100
52	M66	Z	2.789	2.789	0	%100
53	M68	X	0	0	0	%100
54	M68	Z	0	0	0	%100
55	M69	X	-4.587	-4.587	0	%100
56	M69	Z	2.648	2.648	0	%100
57	M71	X	-4.831	-4.831	0	%100

Member Distributed Loads (BLC 49 : Structure Wo (240 Deg)) (Continued)

Member Label	Direction	Start Magnitude[lb/ft.F.ksf]	End Magnitude[lb/ft.F.ksf]	Start Locationft.	End Locationft.
58	M71	Z	2.789	2.789	0 %100
59	M76A	X	-8.004	-8.004	0 %100
60	M76A	Z	4.621	4.621	0 %100
61	M77A	X	-2.258	-2.258	0 %100
62	M77A	Z	1.303	1.303	0 %100
63	M78	X	-2.258	-2.258	0 %100
64	M78	Z	1.303	1.303	0 %100
65	M79A	X	-4.503	-4.503	0 %100
66	M79A	Z	2.6	2.6	0 %100
67	M82	X	-2.501	-2.501	0 %100
68	M82	Z	1.444	1.444	0 %100
69	M83A	X	-10.002	-10.002	0 %100
70	M83A	Z	5.775	5.775	0 %100
71	M87	X	-13.51	-13.51	0 %100
72	M87	Z	7.8	7.8	0 %100
73	M88A	X	-4.587	-4.587	0 %100
74	M88A	Z	2.648	2.648	0 %100
75	M90	X	-4.831	-4.831	0 %100
76	M90	Z	2.789	2.789	0 %100
77	M92A	X	-13.51	-13.51	0 %100
78	M92A	Z	7.8	7.8	0 %100
79	M93	X	-18.346	-18.346	0 %100
80	M93	Z	10.592	10.592	0 %100
81	M95	X	-19.324	-19.324	0 %100
82	M95	Z	11.157	11.157	0 %100
83	M82A	X	-10.507	-10.507	0 %100
84	M82A	Z	6.066	6.066	0 %100
85	M91B	X	-2.627	-2.627	0 %100
86	M91B	Z	1.517	1.517	0 %100
87	MP3C	X	-7.13	-7.13	0 %100
88	MP3C	Z	4.117	4.117	0 %100
89	MP4C	X	-8.631	-8.631	0 %100
90	MP4C	Z	4.983	4.983	0 %100
91	MP2C	X	-7.13	-7.13	0 %100
92	MP2C	Z	4.117	4.117	0 %100
93	MP1C	X	-7.13	-7.13	0 %100
94	MP1C	Z	4.117	4.117	0 %100
95	MP3B	X	-7.13	-7.13	0 %100
96	MP3B	Z	4.117	4.117	0 %100
97	MP4B	X	-8.631	-8.631	0 %100
98	MP4B	Z	4.983	4.983	0 %100
99	MP2B	X	-7.13	-7.13	0 %100
100	MP2B	Z	4.117	4.117	0 %100
101	MP1B	X	-7.13	-7.13	0 %100
102	MP1B	Z	4.117	4.117	0 %100
103	M100	X	-2.158	-2.158	0 %100
104	M100	Z	1.246	1.246	0 %100
105	M105	X	-8.631	-8.631	0 %100
106	M105	Z	4.983	4.983	0 %100
107	M106	X	-2.158	-2.158	0 %100
108	M106	Z	1.246	1.246	0 %100
109	M121	X	-10.993	-10.993	0 %100
110	M121	Z	6.347	6.347	0 %100
111	M122	X	-2.748	-2.748	0 %100
112	M122	Z	1.587	1.587	0 %100
113	M123	X	-2.748	-2.748	0 %100
114	M123	Z	1.587	1.587	0 %100

Member Distributed Loads (BLC 50 : Structure Wo (270 Deg))

	Member Label	Direction	Start Magnitude[lb/ft,F,ksf]	End Magnitude[lb/ft,F,ksf]	Start Location[f..	End Location[ft..
1	M1	X	0	0	0	%100
2	M1	Z	0	0	0	%100
3	M4	X	-12.324	-12.324	0	%100
4	M4	Z	0	0	0	%100
5	M10	X	0	0	0	%100
6	M10	Z	0	0	0	%100
7	MP3A	X	-8.233	-8.233	0	%100
8	MP3A	Z	0	0	0	%100
9	MP4A	X	-9.966	-9.966	0	%100
10	MP4A	Z	0	0	0	%100
11	MP2A	X	-8.233	-8.233	0	%100
12	MP2A	Z	0	0	0	%100
13	MP1A	X	-8.233	-8.233	0	%100
14	MP1A	Z	0	0	0	%100
15	M43	X	0	0	0	%100
16	M43	Z	0	0	0	%100
17	M46	X	0	0	0	%100
18	M46	Z	0	0	0	%100
19	M51B	X	-8.662	-8.662	0	%100
20	M51B	Z	0	0	0	%100
21	M52B	X	-8.662	-8.662	0	%100
22	M52B	Z	0	0	0	%100
23	M76	X	-20.799	-20.799	0	%100
24	M76	Z	0	0	0	%100
25	M77	X	-15.888	-15.888	0	%100
26	M77	Z	0	0	0	%100
27	M80	X	-16.735	-16.735	0	%100
28	M80	Z	0	0	0	%100
29	M84	X	-20.799	-20.799	0	%100
30	M84	Z	0	0	0	%100
31	M85	X	-15.888	-15.888	0	%100
32	M85	Z	0	0	0	%100
33	M91	X	-16.735	-16.735	0	%100
34	M91	Z	0	0	0	%100
35	M52A	X	-3.081	-3.081	0	%100
36	M52A	Z	0	0	0	%100
37	M53	X	-7.821	-7.821	0	%100
38	M53	Z	0	0	0	%100
39	M54	X	-7.821	-7.821	0	%100
40	M54	Z	0	0	0	%100
41	M55	X	-15.6	-15.6	0	%100
42	M55	Z	0	0	0	%100
43	M58A	X	-8.662	-8.662	0	%100
44	M58A	Z	0	0	0	%100
45	M59A	X	0	0	0	%100
46	M59A	Z	0	0	0	%100
47	M63	X	-5.2	-5.2	0	%100
48	M63	Z	0	0	0	%100
49	M64	X	-15.888	-15.888	0	%100
50	M64	Z	0	0	0	%100
51	M66	X	-16.735	-16.735	0	%100
52	M66	Z	0	0	0	%100
53	M68	X	-5.2	-5.2	0	%100
54	M68	Z	0	0	0	%100
55	M69	X	0	0	0	%100
56	M69	Z	0	0	0	%100
57	M71	X	0	0	0	%100

Member Distributed Loads (BLC 50 : Structure Wo (270 Deg)) (Continued)

Member Label	Direction	Start Magnitude[lb/ft,F,ksf]	End Magnitude[lb/ft,F,ksf]	Start Location[ft]	End Location[ft]	
58	M71	Z	0	0	%100	
59	M76A	X	-3.081	-3.081	0	%100
60	M76A	Z	0	0	%100	
61	M77A	X	-7.821	-7.821	0	%100
62	M77A	Z	0	0	%100	
63	M78	X	-7.821	-7.821	0	%100
64	M78	Z	0	0	%100	
65	M79A	X	-15.6	-15.6	0	%100
66	M79A	Z	0	0	%100	
67	M82	X	0	0	0	%100
68	M82	Z	0	0	0	%100
69	M83A	X	-8.662	-8.662	0	%100
70	M83A	Z	0	0	0	%100
71	M87	X	-5.2	-5.2	0	%100
72	M87	Z	0	0	0	%100
73	M88A	X	0	0	0	%100
74	M88A	Z	0	0	0	%100
75	M90	X	0	0	0	%100
76	M90	Z	0	0	0	%100
77	M92A	X	-5.2	-5.2	0	%100
78	M92A	Z	0	0	0	%100
79	M93	X	-15.888	-15.888	0	%100
80	M93	Z	0	0	0	%100
81	M95	X	-16.735	-16.735	0	%100
82	M95	Z	0	0	0	%100
83	M82A	X	-9.1	-9.1	0	%100
84	M82A	Z	0	0	0	%100
85	M91B	X	-9.1	-9.1	0	%100
86	M91B	Z	0	0	0	%100
87	MP3C	X	-8.233	-8.233	0	%100
88	MP3C	Z	0	0	0	%100
89	MP4C	X	-9.966	-9.966	0	%100
90	MP4C	Z	0	0	0	%100
91	MP2C	X	-8.233	-8.233	0	%100
92	MP2C	Z	0	0	0	%100
93	MP1C	X	-8.233	-8.233	0	%100
94	MP1C	Z	0	0	0	%100
95	MP3B	X	-8.233	-8.233	0	%100
96	MP3B	Z	0	0	0	%100
97	MP4B	X	-9.966	-9.966	0	%100
98	MP4B	Z	0	0	0	%100
99	MP2B	X	-8.233	-8.233	0	%100
100	MP2B	Z	0	0	0	%100
101	MP1B	X	-8.233	-8.233	0	%100
102	MP1B	Z	0	0	0	%100
103	M100	X	0	0	0	%100
104	M100	Z	0	0	0	%100
105	M105	X	-7.475	-7.475	0	%100
106	M105	Z	0	0	0	%100
107	M106	X	-7.475	-7.475	0	%100
108	M106	Z	0	0	0	%100
109	M121	X	-9.52	-9.52	0	%100
110	M121	Z	0	0	0	%100
111	M122	X	0	0	0	%100
112	M122	Z	0	0	0	%100
113	M123	X	-9.52	-9.52	0	%100
114	M123	Z	0	0	0	%100

Member Distributed Loads (BLC 51 : Structure Wo (300 Deg))

	Member Label	Direction	Start Magnitude[lb/ft,F,ksf]	End Magnitude[lb/ft,F,ksf]	Start Location[f...]	End Location[ft...]
1	M1	X	-2.627	-2.627	0	%100
2	M1	Z	-1.517	-1.517	0	%100
3	M4	X	-8.004	-8.004	0	%100
4	M4	Z	-4.621	-4.621	0	%100
5	M10	X	-2.258	-2.258	0	%100
6	M10	Z	-1.303	-1.303	0	%100
7	MP3A	X	-7.13	-7.13	0	%100
8	MP3A	Z	-4.117	-4.117	0	%100
9	MP4A	X	-8.631	-8.631	0	%100
10	MP4A	Z	-4.983	-4.983	0	%100
11	MP2A	X	-7.13	-7.13	0	%100
12	MP2A	Z	-4.117	-4.117	0	%100
13	MP1A	X	-7.13	-7.13	0	%100
14	MP1A	Z	-4.117	-4.117	0	%100
15	M43	X	-2.258	-2.258	0	%100
16	M43	Z	-1.303	-1.303	0	%100
17	M46	X	-4.503	-4.503	0	%100
18	M46	Z	-2.6	-2.6	0	%100
19	M51B	X	-2.501	-2.501	0	%100
20	M51B	Z	-1.444	-1.444	0	%100
21	M52B	X	-10.002	-10.002	0	%100
22	M52B	Z	-5.775	-5.775	0	%100
23	M76	X	-13.51	-13.51	0	%100
24	M76	Z	-7.8	-7.8	0	%100
25	M77	X	-4.587	-4.587	0	%100
26	M77	Z	-2.648	-2.648	0	%100
27	M80	X	-4.831	-4.831	0	%100
28	M80	Z	-2.789	-2.789	0	%100
29	M84	X	-13.51	-13.51	0	%100
30	M84	Z	-7.8	-7.8	0	%100
31	M85	X	-18.346	-18.346	0	%100
32	M85	Z	-10.592	-10.592	0	%100
33	M91	X	-19.324	-19.324	0	%100
34	M91	Z	-11.157	-11.157	0	%100
35	M52A	X	-8.004	-8.004	0	%100
36	M52A	Z	-4.621	-4.621	0	%100
37	M53	X	-2.258	-2.258	0	%100
38	M53	Z	-1.303	-1.303	0	%100
39	M54	X	-2.258	-2.258	0	%100
40	M54	Z	-1.303	-1.303	0	%100
41	M55	X	-4.503	-4.503	0	%100
42	M55	Z	-2.6	-2.6	0	%100
43	M58A	X	-10.002	-10.002	0	%100
44	M58A	Z	-5.775	-5.775	0	%100
45	M59A	X	-2.501	-2.501	0	%100
46	M59A	Z	-1.444	-1.444	0	%100
47	M63	X	-13.51	-13.51	0	%100
48	M63	Z	-7.8	-7.8	0	%100
49	M64	X	-18.346	-18.346	0	%100
50	M64	Z	-10.592	-10.592	0	%100
51	M66	X	-19.324	-19.324	0	%100
52	M66	Z	-11.157	-11.157	0	%100
53	M68	X	-13.51	-13.51	0	%100
54	M68	Z	-7.8	-7.8	0	%100
55	M69	X	-4.587	-4.587	0	%100
56	M69	Z	-2.648	-2.648	0	%100
57	M71	X	-4.831	-4.831	0	%100

Member Distributed Loads (BLC 51 : Structure Wo (300 Deg)) (Continued)

	Member Label	Direction	Start Magnitude[lb/ft.F,ksf]	End Magnitude[lb/ft.F,ksf]	Start Locationft..	End Locationft..
58	M71	Z	-2.789	-2.789	0	%100
59	M76A	X	0	0	0	%100
60	M76A	Z	0	0	0	%100
61	M77A	X	-9.031	-9.031	0	%100
62	M77A	Z	-5.214	-5.214	0	%100
63	M78	X	-9.031	-9.031	0	%100
64	M78	Z	-5.214	-5.214	0	%100
65	M79A	X	-18.013	-18.013	0	%100
66	M79A	Z	-10.4	-10.4	0	%100
67	M82	X	-2.501	-2.501	0	%100
68	M82	Z	-1.444	-1.444	0	%100
69	M83A	X	-2.501	-2.501	0	%100
70	M83A	Z	-1.444	-1.444	0	%100
71	M87	X	0	0	0	%100
72	M87	Z	0	0	0	%100
73	M88A	X	-4.587	-4.587	0	%100
74	M88A	Z	-2.648	-2.648	0	%100
75	M90	X	-4.831	-4.831	0	%100
76	M90	Z	-2.789	-2.789	0	%100
77	M92A	X	0	0	0	%100
78	M92A	Z	0	0	0	%100
79	M93	X	-4.587	-4.587	0	%100
80	M93	Z	-2.648	-2.648	0	%100
81	M95	X	-4.831	-4.831	0	%100
82	M95	Z	-2.789	-2.789	0	%100
83	M82A	X	-2.627	-2.627	0	%100
84	M82A	Z	-1.517	-1.517	0	%100
85	M91B	X	-10.507	-10.507	0	%100
86	M91B	Z	-6.066	-6.066	0	%100
87	MP3C	X	-7.13	-7.13	0	%100
88	MP3C	Z	-4.117	-4.117	0	%100
89	MP4C	X	-8.631	-8.631	0	%100
90	MP4C	Z	-4.983	-4.983	0	%100
91	MP2C	X	-7.13	-7.13	0	%100
92	MP2C	Z	-4.117	-4.117	0	%100
93	MP1C	X	-7.13	-7.13	0	%100
94	MP1C	Z	-4.117	-4.117	0	%100
95	MP3B	X	-7.13	-7.13	0	%100
96	MP3B	Z	-4.117	-4.117	0	%100
97	MP4B	X	-8.631	-8.631	0	%100
98	MP4B	Z	-4.983	-4.983	0	%100
99	MP2B	X	-7.13	-7.13	0	%100
100	MP2B	Z	-4.117	-4.117	0	%100
101	MP1B	X	-7.13	-7.13	0	%100
102	MP1B	Z	-4.117	-4.117	0	%100
103	M100	X	-2.158	-2.158	0	%100
104	M100	Z	-1.246	-1.246	0	%100
105	M105	X	-2.158	-2.158	0	%100
106	M105	Z	-1.246	-1.246	0	%100
107	M106	X	-8.631	-8.631	0	%100
108	M106	Z	-4.983	-4.983	0	%100
109	M121	X	-2.748	-2.748	0	%100
110	M121	Z	-1.587	-1.587	0	%100
111	M122	X	-2.748	-2.748	0	%100
112	M122	Z	-1.587	-1.587	0	%100
113	M123	X	-10.993	-10.993	0	%100
114	M123	Z	-6.347	-6.347	0	%100

Member Distributed Loads (BLC 52 : Structure Wo (330 Deg))

	Member Label	Direction	Start Magnitude[lb/ft,F,ksf]	End Magnitude[lb/ft,F,ksf]	Start Location[f...]	End Location[ft...]
1	M1	X	-4.55	-4.55	0	%100
2	M1	Z	-7.881	-7.881	0	%100
3	M4	X	-1.54	-1.54	0	%100
4	M4	Z	-2.668	-2.668	0	%100
5	M10	X	-3.91	-3.91	0	%100
6	M10	Z	-6.773	-6.773	0	%100
7	MP3A	X	-4.117	-4.117	0	%100
8	MP3A	Z	-7.13	-7.13	0	%100
9	MP4A	X	-4.983	-4.983	0	%100
10	MP4A	Z	-8.631	-8.631	0	%100
11	MP2A	X	-4.117	-4.117	0	%100
12	MP2A	Z	-7.13	-7.13	0	%100
13	MP1A	X	-4.117	-4.117	0	%100
14	MP1A	Z	-7.13	-7.13	0	%100
15	M43	X	-3.91	-3.91	0	%100
16	M43	Z	-6.773	-6.773	0	%100
17	M46	X	-7.8	-7.8	0	%100
18	M46	Z	-13.51	-13.51	0	%100
19	M51B	X	0	0	0	%100
20	M51B	Z	0	0	0	%100
21	M52B	X	-4.331	-4.331	0	%100
22	M52B	Z	-7.502	-7.502	0	%100
23	M76	X	-2.6	-2.6	0	%100
24	M76	Z	-4.503	-4.503	0	%100
25	M77	X	0	0	0	%100
26	M77	Z	0	0	0	%100
27	M80	X	0	0	0	%100
28	M80	Z	0	0	0	%100
29	M84	X	-2.6	-2.6	0	%100
30	M84	Z	-4.503	-4.503	0	%100
31	M85	X	-7.944	-7.944	0	%100
32	M85	Z	-13.76	-13.76	0	%100
33	M91	X	-8.367	-8.367	0	%100
34	M91	Z	-14.493	-14.493	0	%100
35	M52A	X	-6.162	-6.162	0	%100
36	M52A	Z	-10.672	-10.672	0	%100
37	M53	X	0	0	0	%100
38	M53	Z	0	0	0	%100
39	M54	X	0	0	0	%100
40	M54	Z	0	0	0	%100
41	M55	X	0	0	0	%100
42	M55	Z	0	0	0	%100
43	M58A	X	-4.331	-4.331	0	%100
44	M58A	Z	-7.502	-7.502	0	%100
45	M59A	X	-4.331	-4.331	0	%100
46	M59A	Z	-7.502	-7.502	0	%100
47	M63	X	-10.4	-10.4	0	%100
48	M63	Z	-18.013	-18.013	0	%100
49	M64	X	-7.944	-7.944	0	%100
50	M64	Z	-13.76	-13.76	0	%100
51	M66	X	-8.367	-8.367	0	%100
52	M66	Z	-14.493	-14.493	0	%100
53	M68	X	-10.4	-10.4	0	%100
54	M68	Z	-18.013	-18.013	0	%100
55	M69	X	-7.944	-7.944	0	%100
56	M69	Z	-13.76	-13.76	0	%100
57	M71	X	-8.367	-8.367	0	%100

Member Distributed Loads (BLC 52 : Structure Wo (330 Deg)) (Continued)

Member Label	Direction	Start Magnitude [lb/ft.F.ksf]	End Magnitude [lb/ft.F.ksf]	Start Location [ft.].	End Location [ft.]
58	M71	Z	-14.493	-14.493	0 %100
59	M76A	X	-1.54	-1.54	0 %100
60	M76A	Z	-2.668	-2.668	0 %100
61	M77A	X	-3.91	-3.91	0 %100
62	M77A	Z	-6.773	-6.773	0 %100
63	M78	X	-3.91	-3.91	0 %100
64	M78	Z	-6.773	-6.773	0 %100
65	M79A	X	-7.8	-7.8	0 %100
66	M79A	Z	-13.51	-13.51	0 %100
67	M82	X	-4.331	-4.331	0 %100
68	M82	Z	-7.502	-7.502	0 %100
69	M83A	X	0	0	0 %100
70	M83A	Z	0	0	0 %100
71	M87	X	-2.6	-2.6	0 %100
72	M87	Z	-4.503	-4.503	0 %100
73	M88A	X	-7.944	-7.944	0 %100
74	M88A	Z	-13.76	-13.76	0 %100
75	M90	X	-8.367	-8.367	0 %100
76	M90	Z	-14.493	-14.493	0 %100
77	M92A	X	-2.6	-2.6	0 %100
78	M92A	Z	-4.503	-4.503	0 %100
79	M93	X	0	0	0 %100
80	M93	Z	0	0	0 %100
81	M95	X	0	0	0 %100
82	M95	Z	0	0	0 %100
83	M82A	X	0	0	0 %100
84	M82A	Z	0	0	0 %100
85	M91B	X	-4.55	-4.55	0 %100
86	M91B	Z	-7.881	-7.881	0 %100
87	MP3C	X	-4.117	-4.117	0 %100
88	MP3C	Z	-7.13	-7.13	0 %100
89	MP4C	X	-4.983	-4.983	0 %100
90	MP4C	Z	-8.631	-8.631	0 %100
91	MP2C	X	-4.117	-4.117	0 %100
92	MP2C	Z	-7.13	-7.13	0 %100
93	MP1C	X	-4.117	-4.117	0 %100
94	MP1C	Z	-7.13	-7.13	0 %100
95	MP3B	X	-4.117	-4.117	0 %100
96	MP3B	Z	-7.13	-7.13	0 %100
97	MP4B	X	-4.983	-4.983	0 %100
98	MP4B	Z	-8.631	-8.631	0 %100
99	MP2B	X	-4.117	-4.117	0 %100
100	MP2B	Z	-7.13	-7.13	0 %100
101	MP1B	X	-4.117	-4.117	0 %100
102	MP1B	Z	-7.13	-7.13	0 %100
103	M100	X	-3.737	-3.737	0 %100
104	M100	Z	-6.473	-6.473	0 %100
105	M105	X	0	0	0 %100
106	M105	Z	0	0	0 %100
107	M106	X	-3.737	-3.737	0 %100
108	M106	Z	-6.473	-6.473	0 %100
109	M121	X	0	0	0 %100
110	M121	Z	0	0	0 %100
111	M122	X	-4.76	-4.76	0 %100
112	M122	Z	-8.245	-8.245	0 %100
113	M123	X	-4.76	-4.76	0 %100
114	M123	Z	-8.245	-8.245	0 %100

Member Distributed Loads (BLC 53 : Structure Wi (0 Deg))

	Member Label	Direction	Start Magnitude[lb/ft,F,ksf]	End Magnitude[lb/ft,F,ksf]	Start Location[f...]	End Location[ft...]
1	M1	X	0	0	0	%100
2	M1	Z	-3.192	-3.192	0	%100
3	M4	X	0	0	0	%100
4	M4	Z	0	0	0	%100
5	M10	X	0	0	0	%100
6	M10	Z	-2.633	-2.633	0	%100
7	MP3A	X	0	0	0	%100
8	MP3A	Z	-2.569	-2.569	0	%100
9	MP4A	X	0	0	0	%100
10	MP4A	Z	-2.846	-2.846	0	%100
11	MP2A	X	0	0	0	%100
12	MP2A	Z	-2.569	-2.569	0	%100
13	MP1A	X	0	0	0	%100
14	MP1A	Z	-2.569	-2.569	0	%100
15	M43	X	0	0	0	%100
16	M43	Z	-2.633	-2.633	0	%100
17	M46	X	0	0	0	%100
18	M46	Z	-4.127	-4.127	0	%100
19	M51B	X	0	0	0	%100
20	M51B	Z	-0.758	-0.758	0	%100
21	M52B	X	0	0	0	%100
22	M52B	Z	-0.758	-0.758	0	%100
23	M76	X	0	0	0	%100
24	M76	Z	0	0	0	%100
25	M77	X	0	0	0	%100
26	M77	Z	-1.03	-1.03	0	%100
27	M80	X	0	0	0	%100
28	M80	Z	-1.075	-1.075	0	%100
29	M84	X	0	0	0	%100
30	M84	Z	0	0	0	%100
31	M85	X	0	0	0	%100
32	M85	Z	-1.03	-1.03	0	%100
33	M91	X	0	0	0	%100
34	M91	Z	-1.075	-1.075	0	%100
35	M52A	X	0	0	0	%100
36	M52A	Z	-2.417	-2.417	0	%100
37	M53	X	0	0	0	%100
38	M53	Z	-0.658	-0.658	0	%100
39	M54	X	0	0	0	%100
40	M54	Z	-0.658	-0.658	0	%100
41	M55	X	0	0	0	%100
42	M55	Z	-1.032	-1.032	0	%100
43	M58A	X	0	0	0	%100
44	M58A	Z	-0.758	-0.758	0	%100
45	M59A	X	0	0	0	%100
46	M59A	Z	-3.033	-3.033	0	%100
47	M63	X	0	0	0	%100
48	M63	Z	-3.043	-3.043	0	%100
49	M64	X	0	0	0	%100
50	M64	Z	-1.03	-1.03	0	%100
51	M66	X	0	0	0	%100
52	M66	Z	-1.075	-1.075	0	%100
53	M68	X	0	0	0	%100
54	M68	Z	-3.043	-3.043	0	%100
55	M69	X	0	0	0	%100
56	M69	Z	-4.119	-4.119	0	%100
57	M71	X	0	0	0	%100



Member Distributed Loads (BLC 53 : Structure Wi (0 Deg)) (Continued)

Member Label	Direction	Start Magnitude[lb/ft,F,ksf]	End Magnitude[lb/ft,F,ksf]	Start Location[ft]	End Location[ft]
58	M71	Z	-4.3	0	%100
59	M76A	X	0	0	%100
60	M76A	Z	-2.417	0	%100
61	M77A	X	0	0	%100
62	M77A	Z	-.658	0	%100
63	M78	X	0	0	%100
64	M78	Z	-.658	0	%100
65	M79A	X	0	0	%100
66	M79A	Z	-1.032	0	%100
67	M82	X	0	0	%100
68	M82	Z	-3.033	0	%100
69	M83A	X	0	0	%100
70	M83A	Z	-.758	0	%100
71	M87	X	0	0	%100
72	M87	Z	-3.043	0	%100
73	M88A	X	0	0	%100
74	M88A	Z	-4.119	0	%100
75	M90	X	0	0	%100
76	M90	Z	-4.3	0	%100
77	M92A	X	0	0	%100
78	M92A	Z	-3.043	0	%100
79	M93	X	0	0	%100
80	M93	Z	-1.03	0	%100
81	M95	X	0	0	%100
82	M95	Z	-1.075	0	%100
83	M82A	X	0	0	%100
84	M82A	Z	-.798	0	%100
85	M91B	X	0	0	%100
86	M91B	Z	-.798	0	%100
87	MP3C	X	0	0	%100
88	MP3C	Z	-2.569	0	%100
89	MP4C	X	0	0	%100
90	MP4C	Z	-2.846	0	%100
91	MP2C	X	0	0	%100
92	MP2C	Z	-2.569	0	%100
93	MP1C	X	0	0	%100
94	MP1C	Z	-2.569	0	%100
95	MP3B	X	0	0	%100
96	MP3B	Z	-2.569	0	%100
97	MP4B	X	0	0	%100
98	MP4B	Z	-2.846	0	%100
99	MP2B	X	0	0	%100
100	MP2B	Z	-2.569	0	%100
101	MP1B	X	0	0	%100
102	MP1B	Z	-2.569	0	%100
103	M100	X	0	0	%100
104	M100	Z	-2.846	0	%100
105	M105	X	0	0	%100
106	M105	Z	-.711	0	%100
107	M106	X	0	0	%100
108	M106	Z	-.711	0	%100
109	M121	X	0	0	%100
110	M121	Z	-.745	0	%100
111	M122	X	0	0	%100
112	M122	Z	-2.978	0	%100
113	M123	X	0	0	%100
114	M123	Z	-.745	0	%100

Member Distributed Loads (BLC 54 : Structure Wi (30 Deg))

	Member Label	Direction	Start Magnitude[lb/ft,F,ksf]	End Magnitude[lb/ft,F,ksf]	Start Location[f..	End Location[ft..
1	M1	X	1.197	1.197	0	%100
2	M1	Z	-2.074	-2.074	0	%100
3	M4	X	.403	.403	0	%100
4	M4	Z	-.698	-.698	0	%100
5	M10	X	.987	.987	0	%100
6	M10	Z	-1.71	-1.71	0	%100
7	MP3A	X	1.284	1.284	0	%100
8	MP3A	Z	-2.224	-2.224	0	%100
9	MP4A	X	1.423	1.423	0	%100
10	MP4A	Z	-2.465	-2.465	0	%100
11	MP2A	X	1.284	1.284	0	%100
12	MP2A	Z	-2.224	-2.224	0	%100
13	MP1A	X	1.284	1.284	0	%100
14	MP1A	Z	-2.224	-2.224	0	%100
15	M43	X	.987	.987	0	%100
16	M43	Z	-1.71	-1.71	0	%100
17	M46	X	1.548	1.548	0	%100
18	M46	Z	-2.681	-2.681	0	%100
19	M51B	X	1.137	1.137	0	%100
20	M51B	Z	-1.97	-1.97	0	%100
21	M52B	X	0	0	0	%100
22	M52B	Z	0	0	0	%100
23	M76	X	.507	.507	0	%100
24	M76	Z	-.879	-.879	0	%100
25	M77	X	1.545	1.545	0	%100
26	M77	Z	-2.676	-2.676	0	%100
27	M80	X	1.612	1.612	0	%100
28	M80	Z	-2.793	-2.793	0	%100
29	M84	X	.507	.507	0	%100
30	M84	Z	-.879	-.879	0	%100
31	M85	X	0	0	0	%100
32	M85	Z	0	0	0	%100
33	M91	X	0	0	0	%100
34	M91	Z	0	0	0	%100
35	M52A	X	.403	.403	0	%100
36	M52A	Z	-.698	-.698	0	%100
37	M53	X	.987	.987	0	%100
38	M53	Z	-1.71	-1.71	0	%100
39	M54	X	.987	.987	0	%100
40	M54	Z	-1.71	-1.71	0	%100
41	M55	X	1.548	1.548	0	%100
42	M55	Z	-2.681	-2.681	0	%100
43	M58A	X	0	0	0	%100
44	M58A	Z	0	0	0	%100
45	M59A	X	1.137	1.137	0	%100
46	M59A	Z	-1.97	-1.97	0	%100
47	M63	X	.507	.507	0	%100
48	M63	Z	-.879	-.879	0	%100
49	M64	X	0	0	0	%100
50	M64	Z	0	0	0	%100
51	M66	X	0	0	0	%100
52	M66	Z	0	0	0	%100
53	M68	X	.507	.507	0	%100
54	M68	Z	-.879	-.879	0	%100
55	M69	X	1.545	1.545	0	%100
56	M69	Z	-2.676	-2.676	0	%100
57	M71	X	1.612	1.612	0	%100

Member Distributed Loads (BLC 55 : Structure Wi (60 Deg))

	Member Label	Direction	Start Magnitude[lb/ft,F,ksf]	End Magnitude[lb/ft,F,ksf]	Start Location[f..	End Location[ft..
1	M1	X	.691	.691	0	%100
2	M1	Z	-.399	-.399	0	%100
3	M4	X	2.093	2.093	0	%100
4	M4	Z	-1.209	-1.209	0	%100
5	M10	X	.57	.57	0	%100
6	M10	Z	-.329	-.329	0	%100
7	MP3A	X	2.224	2.224	0	%100
8	MP3A	Z	-1.284	-1.284	0	%100
9	MP4A	X	2.465	2.465	0	%100
10	MP4A	Z	-1.423	-1.423	0	%100
11	MP2A	X	2.224	2.224	0	%100
12	MP2A	Z	-1.284	-1.284	0	%100
13	MP1A	X	2.224	2.224	0	%100
14	MP1A	Z	-1.284	-1.284	0	%100
15	M43	X	.57	.57	0	%100
16	M43	Z	-.329	-.329	0	%100
17	M46	X	.894	.894	0	%100
18	M46	Z	-.516	-.516	0	%100
19	M51B	X	2.627	2.627	0	%100
20	M51B	Z	-1.516	-1.516	0	%100
21	M52B	X	.657	.657	0	%100
22	M52B	Z	-.379	-.379	0	%100
23	M76	X	2.636	2.636	0	%100
24	M76	Z	-1.522	-1.522	0	%100
25	M77	X	3.568	3.568	0	%100
26	M77	Z	-2.06	-2.06	0	%100
27	M80	X	3.724	3.724	0	%100
28	M80	Z	-2.15	-2.15	0	%100
29	M84	X	2.636	2.636	0	%100
30	M84	Z	-1.522	-1.522	0	%100
31	M85	X	.892	.892	0	%100
32	M85	Z	-.515	-.515	0	%100
33	M91	X	.931	.931	0	%100
34	M91	Z	-.537	-.537	0	%100
35	M52A	X	0	0	0	%100
36	M52A	Z	0	0	0	%100
37	M53	X	2.28	2.28	0	%100
38	M53	Z	-1.317	-1.317	0	%100
39	M54	X	2.28	2.28	0	%100
40	M54	Z	-1.317	-1.317	0	%100
41	M55	X	3.574	3.574	0	%100
42	M55	Z	-2.063	-2.063	0	%100
43	M58A	X	.657	.657	0	%100
44	M58A	Z	-.379	-.379	0	%100
45	M59A	X	.657	.657	0	%100
46	M59A	Z	-.379	-.379	0	%100
47	M63	X	0	0	0	%100
48	M63	Z	0	0	0	%100
49	M64	X	.892	.892	0	%100
50	M64	Z	-.515	-.515	0	%100
51	M66	X	.931	.931	0	%100
52	M66	Z	-.537	-.537	0	%100
53	M68	X	0	0	0	%100
54	M68	Z	0	0	0	%100
55	M69	X	.892	.892	0	%100
56	M69	Z	-.515	-.515	0	%100
57	M71	X	.931	.931	0	%100

Member Distributed Loads (BLC 55 : Structure Wi (60 Deg)) (Continued)

Member Label	Direction	Start Magnitude[lb/ft,F,ksf]	End Magnitude[lb/ft,F,ksf]	Start Locationft..	End Locationft..
58	M71	Z	-.537	0	%100
59	M76A	X	2.093	0	%100
60	M76A	Z	-1.209	0	%100
61	M77A	X	.57	0	%100
62	M77A	Z	-.329	0	%100
63	M78	X	.57	0	%100
64	M78	Z	-.329	0	%100
65	M79A	X	.894	0	%100
66	M79A	Z	-.516	0	%100
67	M82	X	.657	0	%100
68	M82	Z	-.379	0	%100
69	M83A	X	2.627	0	%100
70	M83A	Z	-1.516	0	%100
71	M87	X	2.636	0	%100
72	M87	Z	-1.522	0	%100
73	M88A	X	.892	0	%100
74	M88A	Z	-.515	0	%100
75	M90	X	.931	0	%100
76	M90	Z	-.537	0	%100
77	M92A	X	2.636	0	%100
78	M92A	Z	-1.522	0	%100
79	M93	X	3.568	0	%100
80	M93	Z	-2.06	0	%100
81	M95	X	3.724	0	%100
82	M95	Z	-2.15	0	%100
83	M82A	X	2.765	0	%100
84	M82A	Z	-1.596	0	%100
85	M91B	X	.691	0	%100
86	M91B	Z	-.399	0	%100
87	MP3C	X	2.224	0	%100
88	MP3C	Z	-1.284	0	%100
89	MP4C	X	2.465	0	%100
90	MP4C	Z	-1.423	0	%100
91	MP2C	X	2.224	0	%100
92	MP2C	Z	-1.284	0	%100
93	MP1C	X	2.224	0	%100
94	MP1C	Z	-1.284	0	%100
95	MP3B	X	2.224	0	%100
96	MP3B	Z	-1.284	0	%100
97	MP4B	X	2.465	0	%100
98	MP4B	Z	-1.423	0	%100
99	MP2B	X	2.224	0	%100
100	MP2B	Z	-1.284	0	%100
101	MP1B	X	2.224	0	%100
102	MP1B	Z	-1.284	0	%100
103	M100	X	.616	0	%100
104	M100	Z	-.356	0	%100
105	M105	X	2.465	0	%100
106	M105	Z	-1.423	0	%100
107	M106	X	.616	0	%100
108	M106	Z	-.356	0	%100
109	M121	X	2.579	0	%100
110	M121	Z	-1.489	0	%100
111	M122	X	.645	0	%100
112	M122	Z	-.372	0	%100
113	M123	X	.645	0	%100
114	M123	Z	-.372	0	%100

Member Distributed Loads (BLC 56 : Structure Wi (90 Deg))

	Member Label	Direction	Start Magnitude[lb/ft,F,ksf]	End Magnitude[lb/ft,F,ksf]	Start Location[f...]	End Location[ft...]
1	M1	X	0	0	0	%100
2	M1	Z	0	0	0	%100
3	M4	X	3.223	3.223	0	%100
4	M4	Z	0	0	0	%100
5	M10	X	0	0	0	%100
6	M10	Z	0	0	0	%100
7	MP3A	X	2.569	2.569	0	%100
8	MP3A	Z	0	0	0	%100
9	MP4A	X	2.846	2.846	0	%100
10	MP4A	Z	0	0	0	%100
11	MP2A	X	2.569	2.569	0	%100
12	MP2A	Z	0	0	0	%100
13	MP1A	X	2.569	2.569	0	%100
14	MP1A	Z	0	0	0	%100
15	M43	X	0	0	0	%100
16	M43	Z	0	0	0	%100
17	M46	X	0	0	0	%100
18	M46	Z	0	0	0	%100
19	M51B	X	2.275	2.275	0	%100
20	M51B	Z	0	0	0	%100
21	M52B	X	2.275	2.275	0	%100
22	M52B	Z	0	0	0	%100
23	M76	X	4.058	4.058	0	%100
24	M76	Z	0	0	0	%100
25	M77	X	3.09	3.09	0	%100
26	M77	Z	0	0	0	%100
27	M80	X	3.225	3.225	0	%100
28	M80	Z	0	0	0	%100
29	M84	X	4.058	4.058	0	%100
30	M84	Z	0	0	0	%100
31	M85	X	3.09	3.09	0	%100
32	M85	Z	0	0	0	%100
33	M91	X	3.225	3.225	0	%100
34	M91	Z	0	0	0	%100
35	M52A	X	.806	.806	0	%100
36	M52A	Z	0	0	0	%100
37	M53	X	1.975	1.975	0	%100
38	M53	Z	0	0	0	%100
39	M54	X	1.975	1.975	0	%100
40	M54	Z	0	0	0	%100
41	M55	X	3.095	3.095	0	%100
42	M55	Z	0	0	0	%100
43	M58A	X	2.275	2.275	0	%100
44	M58A	Z	0	0	0	%100
45	M59A	X	0	0	0	%100
46	M59A	Z	0	0	0	%100
47	M63	X	1.014	1.014	0	%100
48	M63	Z	0	0	0	%100
49	M64	X	3.09	3.09	0	%100
50	M64	Z	0	0	0	%100
51	M66	X	3.225	3.225	0	%100
52	M66	Z	0	0	0	%100
53	M68	X	1.014	1.014	0	%100
54	M68	Z	0	0	0	%100
55	M69	X	0	0	0	%100
56	M69	Z	0	0	0	%100
57	M71	X	0	0	0	%100

Member Distributed Loads (BLC 56 : Structure Wi (90 Deg)) (Continued)

Member Label	Direction	Start Magnitude[lb/ft,F,ksf]	End Magnitude[lb/ft,F,ksf]	Start Locationft..	End Locationft..
58	M71	Z	0	0	%100
59	M76A	X	.806	.806	%100
60	M76A	Z	0	0	%100
61	M77A	X	1.975	1.975	%100
62	M77A	Z	0	0	%100
63	M78	X	1.975	1.975	%100
64	M78	Z	0	0	%100
65	M79A	X	3.095	3.095	%100
66	M79A	Z	0	0	%100
67	M82	X	0	0	%100
68	M82	Z	0	0	%100
69	M83A	X	2.275	2.275	%100
70	M83A	Z	0	0	%100
71	M87	X	1.014	1.014	%100
72	M87	Z	0	0	%100
73	M88A	X	0	0	%100
74	M88A	Z	0	0	%100
75	M90	X	0	0	%100
76	M90	Z	0	0	%100
77	M92A	X	1.014	1.014	%100
78	M92A	Z	0	0	%100
79	M93	X	3.09	3.09	%100
80	M93	Z	0	0	%100
81	M95	X	3.225	3.225	%100
82	M95	Z	0	0	%100
83	M82A	X	2.394	2.394	%100
84	M82A	Z	0	0	%100
85	M91B	X	2.394	2.394	%100
86	M91B	Z	0	0	%100
87	MP3C	X	2.569	2.569	%100
88	MP3C	Z	0	0	%100
89	MP4C	X	2.846	2.846	%100
90	MP4C	Z	0	0	%100
91	MP2C	X	2.569	2.569	%100
92	MP2C	Z	0	0	%100
93	MP1C	X	2.569	2.569	%100
94	MP1C	Z	0	0	%100
95	MP3B	X	2.569	2.569	%100
96	MP3B	Z	0	0	%100
97	MP4B	X	2.846	2.846	%100
98	MP4B	Z	0	0	%100
99	MP2B	X	2.569	2.569	%100
100	MP2B	Z	0	0	%100
101	MP1B	X	2.569	2.569	%100
102	MP1B	Z	0	0	%100
103	M100	X	0	0	%100
104	M100	Z	0	0	%100
105	M105	X	2.134	2.134	%100
106	M105	Z	0	0	%100
107	M106	X	2.134	2.134	%100
108	M106	Z	0	0	%100
109	M121	X	2.234	2.234	%100
110	M121	Z	0	0	%100
111	M122	X	0	0	%100
112	M122	Z	0	0	%100
113	M123	X	2.234	2.234	%100
114	M123	Z	0	0	%100



Company :
 Designer :
 Job Number :
 Model Name :

July 6, 2023
 1:03 PM
 Checked By: _____

Member Distributed Loads (BLC 57 : Structure Wi (120 Deg))

	Member Label	Direction	Start Magnitude[lb/ft,F,ksf]	End Magnitude[lb/ft,F,ksf]	Start Location[f..	End Location[ft..
1	M1	X	.691	.691	0	%100
2	M1	Z	.399	.399	0	%100
3	M4	X	2.093	2.093	0	%100
4	M4	Z	1.209	1.209	0	%100
5	M10	X	.57	.57	0	%100
6	M10	Z	.329	.329	0	%100
7	MP3A	X	2.224	2.224	0	%100
8	MP3A	Z	1.284	1.284	0	%100
9	MP4A	X	2.465	2.465	0	%100
10	MP4A	Z	1.423	1.423	0	%100
11	MP2A	X	2.224	2.224	0	%100
12	MP2A	Z	1.284	1.284	0	%100
13	MP1A	X	2.224	2.224	0	%100
14	MP1A	Z	1.284	1.284	0	%100
15	M43	X	.57	.57	0	%100
16	M43	Z	.329	.329	0	%100
17	M46	X	.894	.894	0	%100
18	M46	Z	.516	.516	0	%100
19	M51B	X	.657	.657	0	%100
20	M51B	Z	.379	.379	0	%100
21	M52B	X	2.627	2.627	0	%100
22	M52B	Z	1.516	1.516	0	%100
23	M76	X	2.636	2.636	0	%100
24	M76	Z	1.522	1.522	0	%100
25	M77	X	.892	.892	0	%100
26	M77	Z	.515	.515	0	%100
27	M80	X	.931	.931	0	%100
28	M80	Z	.537	.537	0	%100
29	M84	X	2.636	2.636	0	%100
30	M84	Z	1.522	1.522	0	%100
31	M85	X	3.568	3.568	0	%100
32	M85	Z	2.06	2.06	0	%100
33	M91	X	3.724	3.724	0	%100
34	M91	Z	2.15	2.15	0	%100
35	M52A	X	2.093	2.093	0	%100
36	M52A	Z	1.209	1.209	0	%100
37	M53	X	.57	.57	0	%100
38	M53	Z	.329	.329	0	%100
39	M54	X	.57	.57	0	%100
40	M54	Z	.329	.329	0	%100
41	M55	X	.894	.894	0	%100
42	M55	Z	.516	.516	0	%100
43	M58A	X	2.627	2.627	0	%100
44	M58A	Z	1.516	1.516	0	%100
45	M59A	X	.657	.657	0	%100
46	M59A	Z	.379	.379	0	%100
47	M63	X	2.636	2.636	0	%100
48	M63	Z	1.522	1.522	0	%100
49	M64	X	3.568	3.568	0	%100
50	M64	Z	2.06	2.06	0	%100
51	M66	X	3.724	3.724	0	%100
52	M66	Z	2.15	2.15	0	%100
53	M68	X	2.636	2.636	0	%100
54	M68	Z	1.522	1.522	0	%100
55	M69	X	.892	.892	0	%100
56	M69	Z	.515	.515	0	%100
57	M71	X	.931	.931	0	%100

Member Distributed Loads (BLC 57 : Structure Wi (120 Deg)) (Continued)

Member Label	Direction	Start Magnitude[lb/ft,F,ksf]	End Magnitude[lb/ft,F,ksf]	Start Locationft..	End Locationft..
58	M71	Z	.537	0	%100
59	M76A	X	0	0	%100
60	M76A	Z	0	0	%100
61	M77A	X	2.28	0	%100
62	M77A	Z	1.317	0	%100
63	M78	X	2.28	0	%100
64	M78	Z	1.317	0	%100
65	M79A	X	3.574	0	%100
66	M79A	Z	2.063	0	%100
67	M82	X	.657	0	%100
68	M82	Z	.379	0	%100
69	M83A	X	.657	0	%100
70	M83A	Z	.379	0	%100
71	M87	X	0	0	%100
72	M87	Z	0	0	%100
73	M88A	X	.892	0	%100
74	M88A	Z	.515	0	%100
75	M90	X	.931	0	%100
76	M90	Z	.537	0	%100
77	M92A	X	0	0	%100
78	M92A	Z	0	0	%100
79	M93	X	.892	0	%100
80	M93	Z	.515	0	%100
81	M95	X	.931	0	%100
82	M95	Z	.537	0	%100
83	M82A	X	.691	0	%100
84	M82A	Z	.399	0	%100
85	M91B	X	2.765	0	%100
86	M91B	Z	1.596	0	%100
87	MP3C	X	2.224	0	%100
88	MP3C	Z	1.284	0	%100
89	MP4C	X	2.465	0	%100
90	MP4C	Z	1.423	0	%100
91	MP2C	X	2.224	0	%100
92	MP2C	Z	1.284	0	%100
93	MP1C	X	2.224	0	%100
94	MP1C	Z	1.284	0	%100
95	MP3B	X	2.224	0	%100
96	MP3B	Z	1.284	0	%100
97	MP4B	X	2.465	0	%100
98	MP4B	Z	1.423	0	%100
99	MP2B	X	2.224	0	%100
100	MP2B	Z	1.284	0	%100
101	MP1B	X	2.224	0	%100
102	MP1B	Z	1.284	0	%100
103	M100	X	.616	0	%100
104	M100	Z	.356	0	%100
105	M105	X	.616	0	%100
106	M105	Z	.356	0	%100
107	M106	X	2.465	0	%100
108	M106	Z	1.423	0	%100
109	M121	X	.645	0	%100
110	M121	Z	.372	0	%100
111	M122	X	.645	0	%100
112	M122	Z	.372	0	%100
113	M123	X	2.579	0	%100
114	M123	Z	1.489	0	%100



Company :
 Designer :
 Job Number :
 Model Name :

July 6, 2023
 1:03 PM
 Checked By: _____

Member Distributed Loads (BLC 58 : Structure Wi (150 Deg))

	Member Label	Direction	Start Magnitude[lb/ft,F,ksf]	End Magnitude[lb/ft,F,ksf]	Start Location[f..	End Location[ft..
1	M1	X	1.197	1.197	0	%100
2	M1	Z	2.074	2.074	0	%100
3	M4	X	.403	.403	0	%100
4	M4	Z	.698	.698	0	%100
5	M10	X	.987	.987	0	%100
6	M10	Z	1.71	1.71	0	%100
7	MP3A	X	1.284	1.284	0	%100
8	MP3A	Z	2.224	2.224	0	%100
9	MP4A	X	1.423	1.423	0	%100
10	MP4A	Z	2.465	2.465	0	%100
11	MP2A	X	1.284	1.284	0	%100
12	MP2A	Z	2.224	2.224	0	%100
13	MP1A	X	1.284	1.284	0	%100
14	MP1A	Z	2.224	2.224	0	%100
15	M43	X	.987	.987	0	%100
16	M43	Z	1.71	1.71	0	%100
17	M46	X	1.548	1.548	0	%100
18	M46	Z	2.681	2.681	0	%100
19	M51B	X	0	0	0	%100
20	M51B	Z	0	0	0	%100
21	M52B	X	1.137	1.137	0	%100
22	M52B	Z	1.97	1.97	0	%100
23	M76	X	.507	.507	0	%100
24	M76	Z	.879	.879	0	%100
25	M77	X	0	0	0	%100
26	M77	Z	0	0	0	%100
27	M80	X	0	0	0	%100
28	M80	Z	0	0	0	%100
29	M84	X	.507	.507	0	%100
30	M84	Z	.879	.879	0	%100
31	M85	X	1.545	1.545	0	%100
32	M85	Z	2.676	2.676	0	%100
33	M91	X	1.612	1.612	0	%100
34	M91	Z	2.793	2.793	0	%100
35	M52A	X	1.611	1.611	0	%100
36	M52A	Z	2.791	2.791	0	%100
37	M53	X	0	0	0	%100
38	M53	Z	0	0	0	%100
39	M54	X	0	0	0	%100
40	M54	Z	0	0	0	%100
41	M55	X	0	0	0	%100
42	M55	Z	0	0	0	%100
43	M58A	X	1.137	1.137	0	%100
44	M58A	Z	1.97	1.97	0	%100
45	M59A	X	1.137	1.137	0	%100
46	M59A	Z	1.97	1.97	0	%100
47	M63	X	2.029	2.029	0	%100
48	M63	Z	3.514	3.514	0	%100
49	M64	X	1.545	1.545	0	%100
50	M64	Z	2.676	2.676	0	%100
51	M66	X	1.612	1.612	0	%100
52	M66	Z	2.793	2.793	0	%100
53	M68	X	2.029	2.029	0	%100
54	M68	Z	3.514	3.514	0	%100
55	M69	X	1.545	1.545	0	%100
56	M69	Z	2.676	2.676	0	%100
57	M71	X	1.612	1.612	0	%100

Member Distributed Loads (BLC 58 : Structure Wi (150 Deg)) (Continued)

Member Label	Direction	Start Magnitude[lb/ft,F,ksf]	End Magnitude[lb/ft,F,ksf]	Start Locationf..	End Locationft..
58	M71	Z	2.793	0	%100
59	M76A	X	.403	0	%100
60	M76A	Z	.698	0	%100
61	M77A	X	.987	0	%100
62	M77A	Z	1.71	0	%100
63	M78	X	.987	0	%100
64	M78	Z	1.71	0	%100
65	M79A	X	1.548	0	%100
66	M79A	Z	2.681	0	%100
67	M82	X	1.137	0	%100
68	M82	Z	1.97	0	%100
69	M83A	X	0	0	%100
70	M83A	Z	0	0	%100
71	M87	X	.507	0	%100
72	M87	Z	.879	0	%100
73	M88A	X	1.545	0	%100
74	M88A	Z	2.676	0	%100
75	M90	X	1.612	0	%100
76	M90	Z	2.793	0	%100
77	M92A	X	.507	0	%100
78	M92A	Z	.879	0	%100
79	M93	X	0	0	%100
80	M93	Z	0	0	%100
81	M95	X	0	0	%100
82	M95	Z	0	0	%100
83	M82A	X	0	0	%100
84	M82A	Z	0	0	%100
85	M91B	X	1.197	0	%100
86	M91B	Z	2.074	0	%100
87	MP3C	X	1.284	0	%100
88	MP3C	Z	2.224	0	%100
89	MP4C	X	1.423	0	%100
90	MP4C	Z	2.465	0	%100
91	MP2C	X	1.284	0	%100
92	MP2C	Z	2.224	0	%100
93	MP1C	X	1.284	0	%100
94	MP1C	Z	2.224	0	%100
95	MP3B	X	1.284	0	%100
96	MP3B	Z	2.224	0	%100
97	MP4B	X	1.423	0	%100
98	MP4B	Z	2.465	0	%100
99	MP2B	X	1.284	0	%100
100	MP2B	Z	2.224	0	%100
101	MP1B	X	1.284	0	%100
102	MP1B	Z	2.224	0	%100
103	M100	X	1.067	0	%100
104	M100	Z	1.848	0	%100
105	M105	X	0	0	%100
106	M105	Z	0	0	%100
107	M106	X	1.067	0	%100
108	M106	Z	1.848	0	%100
109	M121	X	0	0	%100
110	M121	Z	0	0	%100
111	M122	X	1.117	0	%100
112	M122	Z	1.935	0	%100
113	M123	X	1.117	0	%100
114	M123	Z	1.935	0	%100



Company :
 Designer :
 Job Number :
 Model Name :

July 6, 2023
 1:03 PM
 Checked By: _____

Member Distributed Loads (BLC 59 : Structure Wi (180 Deg))

	Member Label	Direction	Start Magnitude[lb/ft,F,ksf]	End Magnitude[lb/ft,F,ksf]	Start Location[f...]	End Location[ft...]
1	M1	X	0	0	0	%100
2	M1	Z	3.192	3.192	0	%100
3	M4	X	0	0	0	%100
4	M4	Z	0	0	0	%100
5	M10	X	0	0	0	%100
6	M10	Z	2.633	2.633	0	%100
7	MP3A	X	0	0	0	%100
8	MP3A	Z	2.569	2.569	0	%100
9	MP4A	X	0	0	0	%100
10	MP4A	Z	2.846	2.846	0	%100
11	MP2A	X	0	0	0	%100
12	MP2A	Z	2.569	2.569	0	%100
13	MP1A	X	0	0	0	%100
14	MP1A	Z	2.569	2.569	0	%100
15	M43	X	0	0	0	%100
16	M43	Z	2.633	2.633	0	%100
17	M46	X	0	0	0	%100
18	M46	Z	4.127	4.127	0	%100
19	M51B	X	0	0	0	%100
20	M51B	Z	.758	.758	0	%100
21	M52B	X	0	0	0	%100
22	M52B	Z	.758	.758	0	%100
23	M76	X	0	0	0	%100
24	M76	Z	0	0	0	%100
25	M77	X	0	0	0	%100
26	M77	Z	1.03	1.03	0	%100
27	M80	X	0	0	0	%100
28	M80	Z	1.075	1.075	0	%100
29	M84	X	0	0	0	%100
30	M84	Z	0	0	0	%100
31	M85	X	0	0	0	%100
32	M85	Z	1.03	1.03	0	%100
33	M91	X	0	0	0	%100
34	M91	Z	1.075	1.075	0	%100
35	M52A	X	0	0	0	%100
36	M52A	Z	2.417	2.417	0	%100
37	M53	X	0	0	0	%100
38	M53	Z	.658	.658	0	%100
39	M54	X	0	0	0	%100
40	M54	Z	.658	.658	0	%100
41	M55	X	0	0	0	%100
42	M55	Z	1.032	1.032	0	%100
43	M58A	X	0	0	0	%100
44	M58A	Z	.758	.758	0	%100
45	M59A	X	0	0	0	%100
46	M59A	Z	3.033	3.033	0	%100
47	M63	X	0	0	0	%100
48	M63	Z	3.043	3.043	0	%100
49	M64	X	0	0	0	%100
50	M64	Z	1.03	1.03	0	%100
51	M66	X	0	0	0	%100
52	M66	Z	1.075	1.075	0	%100
53	M68	X	0	0	0	%100
54	M68	Z	3.043	3.043	0	%100
55	M69	X	0	0	0	%100
56	M69	Z	4.119	4.119	0	%100
57	M71	X	0	0	0	%100

Member Distributed Loads (BLC 59 : Structure Wi (180 Deg)) (Continued)

Member Label	Direction	Start Magnitude[lb/ft,F,ksf]	End Magnitude[lb/ft,F,ksf]	Start Locationft..	End Locationft..
58	M71	Z	4.3	0	%100
59	M76A	X	0	0	%100
60	M76A	Z	2.417	0	%100
61	M77A	X	0	0	%100
62	M77A	Z	.658	0	%100
63	M78	X	0	0	%100
64	M78	Z	.658	0	%100
65	M79A	X	0	0	%100
66	M79A	Z	1.032	0	%100
67	M82	X	0	0	%100
68	M82	Z	3.033	0	%100
69	M83A	X	0	0	%100
70	M83A	Z	.758	0	%100
71	M87	X	0	0	%100
72	M87	Z	3.043	0	%100
73	M88A	X	0	0	%100
74	M88A	Z	4.119	0	%100
75	M90	X	0	0	%100
76	M90	Z	4.3	0	%100
77	M92A	X	0	0	%100
78	M92A	Z	3.043	0	%100
79	M93	X	0	0	%100
80	M93	Z	1.03	0	%100
81	M95	X	0	0	%100
82	M95	Z	1.075	0	%100
83	M82A	X	0	0	%100
84	M82A	Z	.798	0	%100
85	M91B	X	0	0	%100
86	M91B	Z	.798	0	%100
87	MP3C	X	0	0	%100
88	MP3C	Z	2.569	0	%100
89	MP4C	X	0	0	%100
90	MP4C	Z	2.846	0	%100
91	MP2C	X	0	0	%100
92	MP2C	Z	2.569	0	%100
93	MP1C	X	0	0	%100
94	MP1C	Z	2.569	0	%100
95	MP3B	X	0	0	%100
96	MP3B	Z	2.569	0	%100
97	MP4B	X	0	0	%100
98	MP4B	Z	2.846	0	%100
99	MP2B	X	0	0	%100
100	MP2B	Z	2.569	0	%100
101	MP1B	X	0	0	%100
102	MP1B	Z	2.569	0	%100
103	M100	X	0	0	%100
104	M100	Z	2.846	0	%100
105	M105	X	0	0	%100
106	M105	Z	.711	0	%100
107	M106	X	0	0	%100
108	M106	Z	.711	0	%100
109	M121	X	0	0	%100
110	M121	Z	.745	0	%100
111	M122	X	0	0	%100
112	M122	Z	2.978	0	%100
113	M123	X	0	0	%100
114	M123	Z	.745	0	%100

Member Distributed Loads (BLC 60 : Structure Wi (210 Deg))

Member Label	Direction	Start Magnitude[lb/ft,F,ksf]	End Magnitude[lb/ft,F,ksf]	Start Location[f..	End Location[f..
1	M1	X	-1.197	0	%100
2	M1	Z	2.074	0	%100
3	M4	X	-.403	0	%100
4	M4	Z	.698	0	%100
5	M10	X	-.987	0	%100
6	M10	Z	1.71	0	%100
7	MP3A	X	-1.284	0	%100
8	MP3A	Z	2.224	0	%100
9	MP4A	X	-1.423	0	%100
10	MP4A	Z	2.465	0	%100
11	MP2A	X	-1.284	0	%100
12	MP2A	Z	2.224	0	%100
13	MP1A	X	-1.284	0	%100
14	MP1A	Z	2.224	0	%100
15	M43	X	-.987	0	%100
16	M43	Z	1.71	0	%100
17	M46	X	-1.548	0	%100
18	M46	Z	2.681	0	%100
19	M51B	X	-1.137	0	%100
20	M51B	Z	1.97	0	%100
21	M52B	X	0	0	%100
22	M52B	Z	0	0	%100
23	M76	X	-.507	0	%100
24	M76	Z	.879	0	%100
25	M77	X	-1.545	0	%100
26	M77	Z	2.676	0	%100
27	M80	X	-1.612	0	%100
28	M80	Z	2.793	0	%100
29	M84	X	-.507	0	%100
30	M84	Z	.879	0	%100
31	M85	X	0	0	%100
32	M85	Z	0	0	%100
33	M91	X	0	0	%100
34	M91	Z	0	0	%100
35	M52A	X	-.403	0	%100
36	M52A	Z	.698	0	%100
37	M53	X	-.987	0	%100
38	M53	Z	1.71	0	%100
39	M54	X	-.987	0	%100
40	M54	Z	1.71	0	%100
41	M55	X	-1.548	0	%100
42	M55	Z	2.681	0	%100
43	M58A	X	0	0	%100
44	M58A	Z	0	0	%100
45	M59A	X	-1.137	0	%100
46	M59A	Z	1.97	0	%100
47	M63	X	-.507	0	%100
48	M63	Z	.879	0	%100
49	M64	X	0	0	%100
50	M64	Z	0	0	%100
51	M66	X	0	0	%100
52	M66	Z	0	0	%100
53	M68	X	-.507	0	%100
54	M68	Z	.879	0	%100
55	M69	X	-1.545	0	%100
56	M69	Z	2.676	0	%100
57	M71	X	-1.612	0	%100



Company :
 Designer :
 Job Number :
 Model Name :

July 6, 2023
 1:03 PM
 Checked By: _____

Member Distributed Loads (BLC 60 : Structure Wi (210 Deg)) (Continued)

Member Label	Direction	Start Magnitude[lb/ft.F,ksf]	End Magnitude[lb/ft.F,ksf]	Start Locationf..	End Locationft..
58	M71	Z	2.793	0	%100
59	M76A	X	-1.611	0	%100
60	M76A	Z	2.791	0	%100
61	M77A	X	0	0	%100
62	M77A	Z	0	0	%100
63	M78	X	0	0	%100
64	M78	Z	0	0	%100
65	M79A	X	0	0	%100
66	M79A	Z	0	0	%100
67	M82	X	-1.137	0	%100
68	M82	Z	1.97	0	%100
69	M83A	X	-1.137	0	%100
70	M83A	Z	1.97	0	%100
71	M87	X	-2.029	0	%100
72	M87	Z	3.514	0	%100
73	M88A	X	-1.545	0	%100
74	M88A	Z	2.676	0	%100
75	M90	X	-1.612	0	%100
76	M90	Z	2.793	0	%100
77	M92A	X	-2.029	0	%100
78	M92A	Z	3.514	0	%100
79	M93	X	-1.545	0	%100
80	M93	Z	2.676	0	%100
81	M95	X	-1.612	0	%100
82	M95	Z	2.793	0	%100
83	M82A	X	-1.197	0	%100
84	M82A	Z	2.074	0	%100
85	M91B	X	0	0	%100
86	M91B	Z	0	0	%100
87	MP3C	X	-1.284	0	%100
88	MP3C	Z	2.224	0	%100
89	MP4C	X	-1.423	0	%100
90	MP4C	Z	2.465	0	%100
91	MP2C	X	-1.284	0	%100
92	MP2C	Z	2.224	0	%100
93	MP1C	X	-1.284	0	%100
94	MP1C	Z	2.224	0	%100
95	MP3B	X	-1.284	0	%100
96	MP3B	Z	2.224	0	%100
97	MP4B	X	-1.423	0	%100
98	MP4B	Z	2.465	0	%100
99	MP2B	X	-1.284	0	%100
100	MP2B	Z	2.224	0	%100
101	MP1B	X	-1.284	0	%100
102	MP1B	Z	2.224	0	%100
103	M100	X	-1.067	0	%100
104	M100	Z	1.848	0	%100
105	M105	X	-1.067	0	%100
106	M105	Z	1.848	0	%100
107	M106	X	0	0	%100
108	M106	Z	0	0	%100
109	M121	X	-1.117	0	%100
110	M121	Z	1.935	0	%100
111	M122	X	-1.117	0	%100
112	M122	Z	1.935	0	%100
113	M123	X	0	0	%100
114	M123	Z	0	0	%100



Company :
 Designer :
 Job Number :
 Model Name :

July 6, 2023
 1:03 PM
 Checked By: _____

Member Distributed Loads (BLC 61 : Structure Wi (240 Deg))

	Member Label	Direction	Start Magnitude[lb/ft,F,ksf]	End Magnitude[lb/ft,F,ksf]	Start Location[f..	End Location[ft..
1	M1	X	-.691	-.691	0	%100
2	M1	Z	.399	.399	0	%100
3	M4	X	-2.093	-2.093	0	%100
4	M4	Z	1.209	1.209	0	%100
5	M10	X	-.57	-.57	0	%100
6	M10	Z	.329	.329	0	%100
7	MP3A	X	-2.224	-2.224	0	%100
8	MP3A	Z	1.284	1.284	0	%100
9	MP4A	X	-2.465	-2.465	0	%100
10	MP4A	Z	1.423	1.423	0	%100
11	MP2A	X	-2.224	-2.224	0	%100
12	MP2A	Z	1.284	1.284	0	%100
13	MP1A	X	-2.224	-2.224	0	%100
14	MP1A	Z	1.284	1.284	0	%100
15	M43	X	-.57	-.57	0	%100
16	M43	Z	.329	.329	0	%100
17	M46	X	-.894	-.894	0	%100
18	M46	Z	.516	.516	0	%100
19	M51B	X	-2.627	-2.627	0	%100
20	M51B	Z	1.516	1.516	0	%100
21	M52B	X	-.657	-.657	0	%100
22	M52B	Z	.379	.379	0	%100
23	M76	X	-2.636	-2.636	0	%100
24	M76	Z	1.522	1.522	0	%100
25	M77	X	-3.568	-3.568	0	%100
26	M77	Z	2.06	2.06	0	%100
27	M80	X	-3.724	-3.724	0	%100
28	M80	Z	2.15	2.15	0	%100
29	M84	X	-2.636	-2.636	0	%100
30	M84	Z	1.522	1.522	0	%100
31	M85	X	-.892	-.892	0	%100
32	M85	Z	.515	.515	0	%100
33	M91	X	-.931	-.931	0	%100
34	M91	Z	.537	.537	0	%100
35	M52A	X	0	0	0	%100
36	M52A	Z	0	0	0	%100
37	M53	X	-2.28	-2.28	0	%100
38	M53	Z	1.317	1.317	0	%100
39	M54	X	-2.28	-2.28	0	%100
40	M54	Z	1.317	1.317	0	%100
41	M55	X	-3.574	-3.574	0	%100
42	M55	Z	2.063	2.063	0	%100
43	M58A	X	-.657	-.657	0	%100
44	M58A	Z	.379	.379	0	%100
45	M59A	X	-.657	-.657	0	%100
46	M59A	Z	.379	.379	0	%100
47	M63	X	0	0	0	%100
48	M63	Z	0	0	0	%100
49	M64	X	-.892	-.892	0	%100
50	M64	Z	.515	.515	0	%100
51	M66	X	-.931	-.931	0	%100
52	M66	Z	.537	.537	0	%100
53	M68	X	0	0	0	%100
54	M68	Z	0	0	0	%100
55	M69	X	-.892	-.892	0	%100
56	M69	Z	.515	.515	0	%100
57	M71	X	-.931	-.931	0	%100

Member Distributed Loads (BLC 61 : Structure Wi (240 Deg)) (Continued)

Member Label	Direction	Start Magnitude[lb/ft.F,ksf]	End Magnitude[lb/ft.F,ksf]	Start Locationf..	End Locationft..
58	M71	Z	.537	0	%100
59	M76A	X	-2.093	0	%100
60	M76A	Z	1.209	0	%100
61	M77A	X	-.57	0	%100
62	M77A	Z	.329	0	%100
63	M78	X	-.57	0	%100
64	M78	Z	.329	0	%100
65	M79A	X	-.894	0	%100
66	M79A	Z	.516	0	%100
67	M82	X	-.657	0	%100
68	M82	Z	.379	0	%100
69	M83A	X	-2.627	0	%100
70	M83A	Z	1.516	0	%100
71	M87	X	-2.636	0	%100
72	M87	Z	1.522	0	%100
73	M88A	X	-.892	0	%100
74	M88A	Z	.515	0	%100
75	M90	X	-.931	0	%100
76	M90	Z	.537	0	%100
77	M92A	X	-2.636	0	%100
78	M92A	Z	1.522	0	%100
79	M93	X	-3.568	0	%100
80	M93	Z	2.06	0	%100
81	M95	X	-3.724	0	%100
82	M95	Z	2.15	0	%100
83	M82A	X	-2.765	0	%100
84	M82A	Z	1.596	0	%100
85	M91B	X	-.691	0	%100
86	M91B	Z	.399	0	%100
87	MP3C	X	-2.224	0	%100
88	MP3C	Z	1.284	0	%100
89	MP4C	X	-2.465	0	%100
90	MP4C	Z	1.423	0	%100
91	MP2C	X	-2.224	0	%100
92	MP2C	Z	1.284	0	%100
93	MP1C	X	-2.224	0	%100
94	MP1C	Z	1.284	0	%100
95	MP3B	X	-2.224	0	%100
96	MP3B	Z	1.284	0	%100
97	MP4B	X	-2.465	0	%100
98	MP4B	Z	1.423	0	%100
99	MP2B	X	-2.224	0	%100
100	MP2B	Z	1.284	0	%100
101	MP1B	X	-2.224	0	%100
102	MP1B	Z	1.284	0	%100
103	M100	X	-.616	0	%100
104	M100	Z	.356	0	%100
105	M105	X	-2.465	0	%100
106	M105	Z	1.423	0	%100
107	M106	X	-.616	0	%100
108	M106	Z	.356	0	%100
109	M121	X	-2.579	0	%100
110	M121	Z	1.489	0	%100
111	M122	X	-.645	0	%100
112	M122	Z	.372	0	%100
113	M123	X	-.645	0	%100
114	M123	Z	.372	0	%100



Company :
 Designer :
 Job Number :
 Model Name :

July 6, 2023
 1:03 PM
 Checked By: _____

Member Distributed Loads (BLC 62 : Structure Wi (270 Deg))

	Member Label	Direction	Start Magnitude[lb/ft,F,ksf]	End Magnitude[lb/ft,F,ksf]	Start Location[f..	End Location[ft..
1	M1	X	0	0	0	%100
2	M1	Z	0	0	0	%100
3	M4	X	-3.223	-3.223	0	%100
4	M4	Z	0	0	0	%100
5	M10	X	0	0	0	%100
6	M10	Z	0	0	0	%100
7	MP3A	X	-2.569	-2.569	0	%100
8	MP3A	Z	0	0	0	%100
9	MP4A	X	-2.846	-2.846	0	%100
10	MP4A	Z	0	0	0	%100
11	MP2A	X	-2.569	-2.569	0	%100
12	MP2A	Z	0	0	0	%100
13	MP1A	X	-2.569	-2.569	0	%100
14	MP1A	Z	0	0	0	%100
15	M43	X	0	0	0	%100
16	M43	Z	0	0	0	%100
17	M46	X	0	0	0	%100
18	M46	Z	0	0	0	%100
19	M51B	X	-2.275	-2.275	0	%100
20	M51B	Z	0	0	0	%100
21	M52B	X	-2.275	-2.275	0	%100
22	M52B	Z	0	0	0	%100
23	M76	X	-4.058	-4.058	0	%100
24	M76	Z	0	0	0	%100
25	M77	X	-3.09	-3.09	0	%100
26	M77	Z	0	0	0	%100
27	M80	X	-3.225	-3.225	0	%100
28	M80	Z	0	0	0	%100
29	M84	X	-4.058	-4.058	0	%100
30	M84	Z	0	0	0	%100
31	M85	X	-3.09	-3.09	0	%100
32	M85	Z	0	0	0	%100
33	M91	X	-3.225	-3.225	0	%100
34	M91	Z	0	0	0	%100
35	M52A	X	-.806	-.806	0	%100
36	M52A	Z	0	0	0	%100
37	M53	X	-1.975	-1.975	0	%100
38	M53	Z	0	0	0	%100
39	M54	X	-1.975	-1.975	0	%100
40	M54	Z	0	0	0	%100
41	M55	X	-3.095	-3.095	0	%100
42	M55	Z	0	0	0	%100
43	M58A	X	-2.275	-2.275	0	%100
44	M58A	Z	0	0	0	%100
45	M59A	X	0	0	0	%100
46	M59A	Z	0	0	0	%100
47	M63	X	-1.014	-1.014	0	%100
48	M63	Z	0	0	0	%100
49	M64	X	-3.09	-3.09	0	%100
50	M64	Z	0	0	0	%100
51	M66	X	-3.225	-3.225	0	%100
52	M66	Z	0	0	0	%100
53	M68	X	-1.014	-1.014	0	%100
54	M68	Z	0	0	0	%100
55	M69	X	0	0	0	%100
56	M69	Z	0	0	0	%100
57	M71	X	0	0	0	%100



Company :
Designer :
Job Number :
Model Name :

July 6, 2023
1:03 PM
Checked By: _____

Member Distributed Loads (BLC 62 : Structure Wi (270 Deg)) (Continued)

Member Label	Direction	Start Magnitude[lb/ft,F,ksf]	End Magnitude[lb/ft,F,ksf]	Start Locationf..	End Locationft..
58	M71	Z	0	0	%100
59	M76A	X	- .806	0	%100
60	M76A	Z	0	0	%100
61	M77A	X	-1.975	0	%100
62	M77A	Z	0	0	%100
63	M78	X	-1.975	0	%100
64	M78	Z	0	0	%100
65	M79A	X	-3.095	0	%100
66	M79A	Z	0	0	%100
67	M82	X	0	0	%100
68	M82	Z	0	0	%100
69	M83A	X	-2.275	0	%100
70	M83A	Z	0	0	%100
71	M87	X	-1.014	0	%100
72	M87	Z	0	0	%100
73	M88A	X	0	0	%100
74	M88A	Z	0	0	%100
75	M90	X	0	0	%100
76	M90	Z	0	0	%100
77	M92A	X	-1.014	0	%100
78	M92A	Z	0	0	%100
79	M93	X	-3.09	0	%100
80	M93	Z	0	0	%100
81	M95	X	-3.225	0	%100
82	M95	Z	0	0	%100
83	M82A	X	-2.394	0	%100
84	M82A	Z	0	0	%100
85	M91B	X	-2.394	0	%100
86	M91B	Z	0	0	%100
87	MP3C	X	-2.569	0	%100
88	MP3C	Z	0	0	%100
89	MP4C	X	-2.846	0	%100
90	MP4C	Z	0	0	%100
91	MP2C	X	-2.569	0	%100
92	MP2C	Z	0	0	%100
93	MP1C	X	-2.569	0	%100
94	MP1C	Z	0	0	%100
95	MP3B	X	-2.569	0	%100
96	MP3B	Z	0	0	%100
97	MP4B	X	-2.846	0	%100
98	MP4B	Z	0	0	%100
99	MP2B	X	-2.569	0	%100
100	MP2B	Z	0	0	%100
101	MP1B	X	-2.569	0	%100
102	MP1B	Z	0	0	%100
103	M100	X	0	0	%100
104	M100	Z	0	0	%100
105	M105	X	-2.134	0	%100
106	M105	Z	0	0	%100
107	M106	X	-2.134	0	%100
108	M106	Z	0	0	%100
109	M121	X	-2.234	0	%100
110	M121	Z	0	0	%100
111	M122	X	0	0	%100
112	M122	Z	0	0	%100
113	M123	X	-2.234	0	%100
114	M123	Z	0	0	%100

Member Distributed Loads (BLC 63 : Structure Wi (300 Deg))

	Member Label	Direction	Start Magnitude[lb/ft,F,ksf]	End Magnitude[lb/ft,F,ksf]	Start Location[f..	End Location[ft..
1	M1	X	-.691	-.691	0	%100
2	M1	Z	-.399	-.399	0	%100
3	M4	X	-2.093	-2.093	0	%100
4	M4	Z	-1.209	-1.209	0	%100
5	M10	X	-.57	-.57	0	%100
6	M10	Z	-.329	-.329	0	%100
7	MP3A	X	-2.224	-2.224	0	%100
8	MP3A	Z	-1.284	-1.284	0	%100
9	MP4A	X	-2.465	-2.465	0	%100
10	MP4A	Z	-1.423	-1.423	0	%100
11	MP2A	X	-2.224	-2.224	0	%100
12	MP2A	Z	-1.284	-1.284	0	%100
13	MP1A	X	-2.224	-2.224	0	%100
14	MP1A	Z	-1.284	-1.284	0	%100
15	M43	X	-.57	-.57	0	%100
16	M43	Z	-.329	-.329	0	%100
17	M46	X	-.894	-.894	0	%100
18	M46	Z	-.516	-.516	0	%100
19	M51B	X	-.657	-.657	0	%100
20	M51B	Z	-.379	-.379	0	%100
21	M52B	X	-2.627	-2.627	0	%100
22	M52B	Z	-1.516	-1.516	0	%100
23	M76	X	-2.636	-2.636	0	%100
24	M76	Z	-1.522	-1.522	0	%100
25	M77	X	-.892	-.892	0	%100
26	M77	Z	-.515	-.515	0	%100
27	M80	X	-.931	-.931	0	%100
28	M80	Z	-.537	-.537	0	%100
29	M84	X	-2.636	-2.636	0	%100
30	M84	Z	-1.522	-1.522	0	%100
31	M85	X	-3.568	-3.568	0	%100
32	M85	Z	-2.06	-2.06	0	%100
33	M91	X	-3.724	-3.724	0	%100
34	M91	Z	-2.15	-2.15	0	%100
35	M52A	X	-2.093	-2.093	0	%100
36	M52A	Z	-1.209	-1.209	0	%100
37	M53	X	-.57	-.57	0	%100
38	M53	Z	-.329	-.329	0	%100
39	M54	X	-.57	-.57	0	%100
40	M54	Z	-.329	-.329	0	%100
41	M55	X	-.894	-.894	0	%100
42	M55	Z	-.516	-.516	0	%100
43	M58A	X	-2.627	-2.627	0	%100
44	M58A	Z	-1.516	-1.516	0	%100
45	M59A	X	-.657	-.657	0	%100
46	M59A	Z	-.379	-.379	0	%100
47	M63	X	-2.636	-2.636	0	%100
48	M63	Z	-1.522	-1.522	0	%100
49	M64	X	-3.568	-3.568	0	%100
50	M64	Z	-2.06	-2.06	0	%100
51	M66	X	-3.724	-3.724	0	%100
52	M66	Z	-2.15	-2.15	0	%100
53	M68	X	-2.636	-2.636	0	%100
54	M68	Z	-1.522	-1.522	0	%100
55	M69	X	-.892	-.892	0	%100
56	M69	Z	-.515	-.515	0	%100
57	M71	X	-.931	-.931	0	%100

Member Distributed Loads (BLC 63 : Structure Wi (300 Deg)) (Continued)

Member Label	Direction	Start Magnitude[lb/ft,F,ksf]	End Magnitude[lb/ft,F,ksf]	Start Locationft..	End Locationft..
58	M71	Z	-537	0	%100
59	M76A	X	0	0	%100
60	M76A	Z	0	0	%100
61	M77A	X	-2.28	0	%100
62	M77A	Z	-1.317	0	%100
63	M78	X	-2.28	0	%100
64	M78	Z	-1.317	0	%100
65	M79A	X	-3.574	0	%100
66	M79A	Z	-2.063	0	%100
67	M82	X	-.657	0	%100
68	M82	Z	-.379	0	%100
69	M83A	X	-.657	0	%100
70	M83A	Z	-.379	0	%100
71	M87	X	0	0	%100
72	M87	Z	0	0	%100
73	M88A	X	-.892	0	%100
74	M88A	Z	-.515	0	%100
75	M90	X	-.931	0	%100
76	M90	Z	-.537	0	%100
77	M92A	X	0	0	%100
78	M92A	Z	0	0	%100
79	M93	X	-.892	0	%100
80	M93	Z	-.515	0	%100
81	M95	X	-.931	0	%100
82	M95	Z	-.537	0	%100
83	M82A	X	-.691	0	%100
84	M82A	Z	-.399	0	%100
85	M91B	X	-2.765	0	%100
86	M91B	Z	-1.596	0	%100
87	MP3C	X	-2.224	0	%100
88	MP3C	Z	-1.284	0	%100
89	MP4C	X	-2.465	0	%100
90	MP4C	Z	-1.423	0	%100
91	MP2C	X	-2.224	0	%100
92	MP2C	Z	-1.284	0	%100
93	MP1C	X	-2.224	0	%100
94	MP1C	Z	-1.284	0	%100
95	MP3B	X	-2.224	0	%100
96	MP3B	Z	-1.284	0	%100
97	MP4B	X	-2.465	0	%100
98	MP4B	Z	-1.423	0	%100
99	MP2B	X	-2.224	0	%100
100	MP2B	Z	-1.284	0	%100
101	MP1B	X	-2.224	0	%100
102	MP1B	Z	-1.284	0	%100
103	M100	X	-.616	0	%100
104	M100	Z	-.356	0	%100
105	M105	X	-.616	0	%100
106	M105	Z	-.356	0	%100
107	M106	X	-2.465	0	%100
108	M106	Z	-1.423	0	%100
109	M121	X	-.645	0	%100
110	M121	Z	-.372	0	%100
111	M122	X	-.645	0	%100
112	M122	Z	-.372	0	%100
113	M123	X	-2.579	0	%100
114	M123	Z	-1.489	0	%100



Company :
 Designer :
 Job Number :
 Model Name :

July 6, 2023
 1:03 PM
 Checked By: _____

Member Distributed Loads (BLC 64 : Structure Wi (330 Deg))

	Member Label	Direction	Start Magnitude[lb/ft,F,ksf]	End Magnitude[lb/ft,F,ksf]	Start Location[f..	End Location[ft..
1	M1	X	-1.197	-1.197	0	%100
2	M1	Z	-2.074	-2.074	0	%100
3	M4	X	-.403	-.403	0	%100
4	M4	Z	-.698	-.698	0	%100
5	M10	X	-.987	-.987	0	%100
6	M10	Z	-1.71	-1.71	0	%100
7	MP3A	X	-1.284	-1.284	0	%100
8	MP3A	Z	-2.224	-2.224	0	%100
9	MP4A	X	-1.423	-1.423	0	%100
10	MP4A	Z	-2.465	-2.465	0	%100
11	MP2A	X	-1.284	-1.284	0	%100
12	MP2A	Z	-2.224	-2.224	0	%100
13	MP1A	X	-1.284	-1.284	0	%100
14	MP1A	Z	-2.224	-2.224	0	%100
15	M43	X	-.987	-.987	0	%100
16	M43	Z	-1.71	-1.71	0	%100
17	M46	X	-1.548	-1.548	0	%100
18	M46	Z	-2.681	-2.681	0	%100
19	M51B	X	0	0	0	%100
20	M51B	Z	0	0	0	%100
21	M52B	X	-1.137	-1.137	0	%100
22	M52B	Z	-1.97	-1.97	0	%100
23	M76	X	-.507	-.507	0	%100
24	M76	Z	-.879	-.879	0	%100
25	M77	X	0	0	0	%100
26	M77	Z	0	0	0	%100
27	M80	X	0	0	0	%100
28	M80	Z	0	0	0	%100
29	M84	X	-.507	-.507	0	%100
30	M84	Z	-.879	-.879	0	%100
31	M85	X	-1.545	-1.545	0	%100
32	M85	Z	-2.676	-2.676	0	%100
33	M91	X	-1.612	-1.612	0	%100
34	M91	Z	-2.793	-2.793	0	%100
35	M52A	X	-1.611	-1.611	0	%100
36	M52A	Z	-2.791	-2.791	0	%100
37	M53	X	0	0	0	%100
38	M53	Z	0	0	0	%100
39	M54	X	0	0	0	%100
40	M54	Z	0	0	0	%100
41	M55	X	0	0	0	%100
42	M55	Z	0	0	0	%100
43	M58A	X	-1.137	-1.137	0	%100
44	M58A	Z	-1.97	-1.97	0	%100
45	M59A	X	-1.137	-1.137	0	%100
46	M59A	Z	-1.97	-1.97	0	%100
47	M63	X	-2.029	-2.029	0	%100
48	M63	Z	-3.514	-3.514	0	%100
49	M64	X	-1.545	-1.545	0	%100
50	M64	Z	-2.676	-2.676	0	%100
51	M66	X	-1.612	-1.612	0	%100
52	M66	Z	-2.793	-2.793	0	%100
53	M68	X	-2.029	-2.029	0	%100
54	M68	Z	-3.514	-3.514	0	%100
55	M69	X	-1.545	-1.545	0	%100
56	M69	Z	-2.676	-2.676	0	%100
57	M71	X	-1.612	-1.612	0	%100



Company :
 Designer :
 Job Number :
 Model Name :

July 6, 2023
 1:03 PM
 Checked By: _____

Member Distributed Loads (BLC 64 : Structure Wi (330 Deg)) (Continued)

Member Label	Direction	Start Magnitude[lb/ft.F,ksf]	End Magnitude[lb/ft.F,ksf]	Start Locationft..	End Locationft..
58	M71	Z	-2.793	0	%100
59	M76A	X	-.403	0	%100
60	M76A	Z	-.698	0	%100
61	M77A	X	-.987	0	%100
62	M77A	Z	-1.71	0	%100
63	M78	X	-.987	0	%100
64	M78	Z	-1.71	0	%100
65	M79A	X	-1.548	0	%100
66	M79A	Z	-2.681	0	%100
67	M82	X	-1.137	0	%100
68	M82	Z	-1.97	0	%100
69	M83A	X	0	0	%100
70	M83A	Z	0	0	%100
71	M87	X	-.507	0	%100
72	M87	Z	-.879	0	%100
73	M88A	X	-1.545	0	%100
74	M88A	Z	-2.676	0	%100
75	M90	X	-1.612	0	%100
76	M90	Z	-2.793	0	%100
77	M92A	X	-.507	0	%100
78	M92A	Z	-.879	0	%100
79	M93	X	0	0	%100
80	M93	Z	0	0	%100
81	M95	X	0	0	%100
82	M95	Z	0	0	%100
83	M82A	X	0	0	%100
84	M82A	Z	0	0	%100
85	M91B	X	-1.197	0	%100
86	M91B	Z	-2.074	0	%100
87	MP3C	X	-1.284	0	%100
88	MP3C	Z	-2.224	0	%100
89	MP4C	X	-1.423	0	%100
90	MP4C	Z	-2.465	0	%100
91	MP2C	X	-1.284	0	%100
92	MP2C	Z	-2.224	0	%100
93	MP1C	X	-1.284	0	%100
94	MP1C	Z	-2.224	0	%100
95	MP3B	X	-1.284	0	%100
96	MP3B	Z	-2.224	0	%100
97	MP4B	X	-1.423	0	%100
98	MP4B	Z	-2.465	0	%100
99	MP2B	X	-1.284	0	%100
100	MP2B	Z	-2.224	0	%100
101	MP1B	X	-1.284	0	%100
102	MP1B	Z	-2.224	0	%100
103	M100	X	-1.067	0	%100
104	M100	Z	-1.848	0	%100
105	M105	X	0	0	%100
106	M105	Z	0	0	%100
107	M106	X	-1.067	0	%100
108	M106	Z	-1.848	0	%100
109	M121	X	0	0	%100
110	M121	Z	0	0	%100
111	M122	X	-1.117	0	%100
112	M122	Z	-1.935	0	%100
113	M123	X	-1.117	0	%100
114	M123	Z	-1.935	0	%100



Company :
 Designer :
 Job Number :
 Model Name :

July 6, 2023
 1:03 PM
 Checked By: _____

Member Distributed Loads (BLC 65 : Structure Wm (0 Deg))

	Member Label	Direction	Start Magnitude[lb/ft,F,ksf]	End Magnitude[lb/ft,F,ksf]	Start Location[f..	End Location[f..
1	M1	X	0	0	0	%100
2	M1	Z	-.699	-.699	0	%100
3	M4	X	0	0	0	%100
4	M4	Z	0	0	0	%100
5	M10	X	0	0	0	%100
6	M10	Z	-.601	-.601	0	%100
7	MP3A	X	0	0	0	%100
8	MP3A	Z	-.474	-.474	0	%100
9	MP4A	X	0	0	0	%100
10	MP4A	Z	-.574	-.574	0	%100
11	MP2A	X	0	0	0	%100
12	MP2A	Z	-.474	-.474	0	%100
13	MP1A	X	0	0	0	%100
14	MP1A	Z	-.474	-.474	0	%100
15	M43	X	0	0	0	%100
16	M43	Z	-.601	-.601	0	%100
17	M46	X	0	0	0	%100
18	M46	Z	-1.198	-1.198	0	%100
19	M51B	X	0	0	0	%100
20	M51B	Z	-.166	-.166	0	%100
21	M52B	X	0	0	0	%100
22	M52B	Z	-.166	-.166	0	%100
23	M76	X	0	0	0	%100
24	M76	Z	0	0	0	%100
25	M77	X	0	0	0	%100
26	M77	Z	-.305	-.305	0	%100
27	M80	X	0	0	0	%100
28	M80	Z	-.321	-.321	0	%100
29	M84	X	0	0	0	%100
30	M84	Z	0	0	0	%100
31	M85	X	0	0	0	%100
32	M85	Z	-.305	-.305	0	%100
33	M91	X	0	0	0	%100
34	M91	Z	-.321	-.321	0	%100
35	M52A	X	0	0	0	%100
36	M52A	Z	-.532	-.532	0	%100
37	M53	X	0	0	0	%100
38	M53	Z	-.15	-.15	0	%100
39	M54	X	0	0	0	%100
40	M54	Z	-.15	-.15	0	%100
41	M55	X	0	0	0	%100
42	M55	Z	-.3	-.3	0	%100
43	M58A	X	0	0	0	%100
44	M58A	Z	-.166	-.166	0	%100
45	M59A	X	0	0	0	%100
46	M59A	Z	-.665	-.665	0	%100
47	M63	X	0	0	0	%100
48	M63	Z	-.899	-.899	0	%100
49	M64	X	0	0	0	%100
50	M64	Z	-.305	-.305	0	%100
51	M66	X	0	0	0	%100
52	M66	Z	-.321	-.321	0	%100
53	M68	X	0	0	0	%100
54	M68	Z	-.899	-.899	0	%100
55	M69	X	0	0	0	%100
56	M69	Z	-1.22	-1.22	0	%100
57	M71	X	0	0	0	%100



Company :
Designer :
Job Number :
Model Name :

July 6, 2023
1:03 PM
Checked By: _____

Member Distributed Loads (BLC 65 : Structure Wm (0 Deg)) (Continued)

Member Label	Direction	Start Magnitude[lb/ft,F,ksf]	End Magnitude[lb/ft,F,ksf]	Start Locationft	End Locationft
58	M71	Z	-1.285	0	%100
59	M76A	X	0	0	%100
60	M76A	Z	-.532	0	%100
61	M77A	X	0	0	%100
62	M77A	Z	-.15	0	%100
63	M78	X	0	0	%100
64	M78	Z	-.15	0	%100
65	M79A	X	0	0	%100
66	M79A	Z	-.3	0	%100
67	M82	X	0	0	%100
68	M82	Z	-.665	0	%100
69	M83A	X	0	0	%100
70	M83A	Z	-.166	0	%100
71	M87	X	0	0	%100
72	M87	Z	-.899	0	%100
73	M88A	X	0	0	%100
74	M88A	Z	-1.22	0	%100
75	M90	X	0	0	%100
76	M90	Z	-1.285	0	%100
77	M92A	X	0	0	%100
78	M92A	Z	-.899	0	%100
79	M93	X	0	0	%100
80	M93	Z	-.305	0	%100
81	M95	X	0	0	%100
82	M95	Z	-.321	0	%100
83	M82A	X	0	0	%100
84	M82A	Z	-.175	0	%100
85	M91B	X	0	0	%100
86	M91B	Z	-.175	0	%100
87	MP3C	X	0	0	%100
88	MP3C	Z	-.474	0	%100
89	MP4C	X	0	0	%100
90	MP4C	Z	-.574	0	%100
91	MP2C	X	0	0	%100
92	MP2C	Z	-.474	0	%100
93	MP1C	X	0	0	%100
94	MP1C	Z	-.474	0	%100
95	MP3B	X	0	0	%100
96	MP3B	Z	-.474	0	%100
97	MP4B	X	0	0	%100
98	MP4B	Z	-.574	0	%100
99	MP2B	X	0	0	%100
100	MP2B	Z	-.474	0	%100
101	MP1B	X	0	0	%100
102	MP1B	Z	-.474	0	%100
103	M100	X	0	0	%100
104	M100	Z	-.574	0	%100
105	M105	X	0	0	%100
106	M105	Z	-.144	0	%100
107	M106	X	0	0	%100
108	M106	Z	-.144	0	%100
109	M121	X	0	0	%100
110	M121	Z	-.183	0	%100
111	M122	X	0	0	%100
112	M122	Z	-.731	0	%100
113	M123	X	0	0	%100
114	M123	Z	-.183	0	%100

Member Distributed Loads (BLC 66 : Structure Wm (30 Deg))

	Member Label	Direction	Start Magnitude[lb/ft,F,ksf]	End Magnitude[lb/ft,F,ksf]	Start Location[f..	End Location[f..
1	M1	X	.262	.262	0	%100
2	M1	Z	-.454	-.454	0	%100
3	M4	X	.089	.089	0	%100
4	M4	Z	-.154	-.154	0	%100
5	M10	X	.225	.225	0	%100
6	M10	Z	-.39	-.39	0	%100
7	MP3A	X	.237	.237	0	%100
8	MP3A	Z	-.411	-.411	0	%100
9	MP4A	X	.287	.287	0	%100
10	MP4A	Z	-.497	-.497	0	%100
11	MP2A	X	.237	.237	0	%100
12	MP2A	Z	-.411	-.411	0	%100
13	MP1A	X	.237	.237	0	%100
14	MP1A	Z	-.411	-.411	0	%100
15	M43	X	.225	.225	0	%100
16	M43	Z	-.39	-.39	0	%100
17	M46	X	.449	.449	0	%100
18	M46	Z	-.778	-.778	0	%100
19	M51B	X	.249	.249	0	%100
20	M51B	Z	-.432	-.432	0	%100
21	M52B	X	0	0	0	%100
22	M52B	Z	0	0	0	%100
23	M76	X	.15	.15	0	%100
24	M76	Z	-.259	-.259	0	%100
25	M77	X	.458	.458	0	%100
26	M77	Z	-.793	-.793	0	%100
27	M80	X	.482	.482	0	%100
28	M80	Z	-.835	-.835	0	%100
29	M84	X	.15	.15	0	%100
30	M84	Z	-.259	-.259	0	%100
31	M85	X	0	0	0	%100
32	M85	Z	0	0	0	%100
33	M91	X	0	0	0	%100
34	M91	Z	0	0	0	%100
35	M52A	X	.089	.089	0	%100
36	M52A	Z	-.154	-.154	0	%100
37	M53	X	.225	.225	0	%100
38	M53	Z	-.39	-.39	0	%100
39	M54	X	.225	.225	0	%100
40	M54	Z	-.39	-.39	0	%100
41	M55	X	.449	.449	0	%100
42	M55	Z	-.778	-.778	0	%100
43	M58A	X	0	0	0	%100
44	M58A	Z	0	0	0	%100
45	M59A	X	.249	.249	0	%100
46	M59A	Z	-.432	-.432	0	%100
47	M63	X	.15	.15	0	%100
48	M63	Z	-.259	-.259	0	%100
49	M64	X	0	0	0	%100
50	M64	Z	0	0	0	%100
51	M66	X	0	0	0	%100
52	M66	Z	0	0	0	%100
53	M68	X	.15	.15	0	%100
54	M68	Z	-.259	-.259	0	%100
55	M69	X	.458	.458	0	%100
56	M69	Z	-.793	-.793	0	%100
57	M71	X	.482	.482	0	%100

Member Distributed Loads (BLC 66 : Structure Wm (30 Deg)) (Continued)

Member Label	Direction	Start Magnitude[lb/ft,F,ksf]	End Magnitude[lb/ft,F,ksf]	Start Locationft..	End Locationft..
58	M71	Z	-.835	0	%100
59	M76A	X	.355	0	%100
60	M76A	Z	-.615	0	%100
61	M77A	X	0	0	%100
62	M77A	Z	0	0	%100
63	M78	X	0	0	%100
64	M78	Z	0	0	%100
65	M79A	X	0	0	%100
66	M79A	Z	0	0	%100
67	M82	X	.249	0	%100
68	M82	Z	-.432	0	%100
69	M83A	X	.249	0	%100
70	M83A	Z	-.432	0	%100
71	M87	X	.599	0	%100
72	M87	Z	-1.038	0	%100
73	M88A	X	.458	0	%100
74	M88A	Z	-.793	0	%100
75	M90	X	.482	0	%100
76	M90	Z	-.835	0	%100
77	M92A	X	.599	0	%100
78	M92A	Z	-1.038	0	%100
79	M93	X	.458	0	%100
80	M93	Z	-.793	0	%100
81	M95	X	.482	0	%100
82	M95	Z	-.835	0	%100
83	M82A	X	.262	0	%100
84	M82A	Z	-.454	0	%100
85	M91B	X	0	0	%100
86	M91B	Z	0	0	%100
87	MP3C	X	.237	0	%100
88	MP3C	Z	-.411	0	%100
89	MP4C	X	.287	0	%100
90	MP4C	Z	-.497	0	%100
91	MP2C	X	.237	0	%100
92	MP2C	Z	-.411	0	%100
93	MP1C	X	.237	0	%100
94	MP1C	Z	-.411	0	%100
95	MP3B	X	.237	0	%100
96	MP3B	Z	-.411	0	%100
97	MP4B	X	.287	0	%100
98	MP4B	Z	-.497	0	%100
99	MP2B	X	.237	0	%100
100	MP2B	Z	-.411	0	%100
101	MP1B	X	.237	0	%100
102	MP1B	Z	-.411	0	%100
103	M100	X	.215	0	%100
104	M100	Z	-.373	0	%100
105	M105	X	.215	0	%100
106	M105	Z	-.373	0	%100
107	M106	X	0	0	%100
108	M106	Z	0	0	%100
109	M121	X	.274	0	%100
110	M121	Z	-.475	0	%100
111	M122	X	.274	0	%100
112	M122	Z	-.475	0	%100
113	M123	X	0	0	%100
114	M123	Z	0	0	%100



Company :
 Designer :
 Job Number :
 Model Name :

July 6, 2023
 1:03 PM
 Checked By: _____

Member Distributed Loads (BLC 67 : Structure Wm (60 Deg))

	Member Label	Direction	Start Magnitude[lb/ft,F,ksf]	End Magnitude[lb/ft,F,ksf]	Start Location[f..	End Location[ft..
1	M1	X	.151	.151	0	%100
2	M1	Z	-.087	-.087	0	%100
3	M4	X	.461	.461	0	%100
4	M4	Z	-.266	-.266	0	%100
5	M10	X	.13	.13	0	%100
6	M10	Z	-.075	-.075	0	%100
7	MP3A	X	.411	.411	0	%100
8	MP3A	Z	-.237	-.237	0	%100
9	MP4A	X	.497	.497	0	%100
10	MP4A	Z	-.287	-.287	0	%100
11	MP2A	X	.411	.411	0	%100
12	MP2A	Z	-.237	-.237	0	%100
13	MP1A	X	.411	.411	0	%100
14	MP1A	Z	-.237	-.237	0	%100
15	M43	X	.13	.13	0	%100
16	M43	Z	-.075	-.075	0	%100
17	M46	X	.259	.259	0	%100
18	M46	Z	-.15	-.15	0	%100
19	M51B	X	.576	.576	0	%100
20	M51B	Z	-.333	-.333	0	%100
21	M52B	X	.144	.144	0	%100
22	M52B	Z	-.083	-.083	0	%100
23	M76	X	.778	.778	0	%100
24	M76	Z	-.449	-.449	0	%100
25	M77	X	1.057	1.057	0	%100
26	M77	Z	-.61	-.61	0	%100
27	M80	X	1.113	1.113	0	%100
28	M80	Z	-.643	-.643	0	%100
29	M84	X	.778	.778	0	%100
30	M84	Z	-.449	-.449	0	%100
31	M85	X	.264	.264	0	%100
32	M85	Z	-.153	-.153	0	%100
33	M91	X	.278	.278	0	%100
34	M91	Z	-.161	-.161	0	%100
35	M52A	X	0	0	0	%100
36	M52A	Z	0	0	0	%100
37	M53	X	.52	.52	0	%100
38	M53	Z	-.3	-.3	0	%100
39	M54	X	.52	.52	0	%100
40	M54	Z	-.3	-.3	0	%100
41	M55	X	1.038	1.038	0	%100
42	M55	Z	-.599	-.599	0	%100
43	M58A	X	.144	.144	0	%100
44	M58A	Z	-.083	-.083	0	%100
45	M59A	X	.144	.144	0	%100
46	M59A	Z	-.083	-.083	0	%100
47	M63	X	0	0	0	%100
48	M63	Z	0	0	0	%100
49	M64	X	.264	.264	0	%100
50	M64	Z	-.153	-.153	0	%100
51	M66	X	.278	.278	0	%100
52	M66	Z	-.161	-.161	0	%100
53	M68	X	0	0	0	%100
54	M68	Z	0	0	0	%100
55	M69	X	.264	.264	0	%100
56	M69	Z	-.153	-.153	0	%100
57	M71	X	.278	.278	0	%100

Member Distributed Loads (BLC 67 : Structure Wm (60 Deg)) (Continued)

Member Label	Direction	Start Magnitude[lb/ft,F,ksf]	End Magnitude[lb/ft,F,ksf]	Start Locationft.	End Locationft.
58	M71	Z	-.161	0	%100
59	M76A	X	.461	0	%100
60	M76A	Z	-.266	0	%100
61	M77A	X	.13	0	%100
62	M77A	Z	-.075	0	%100
63	M78	X	.13	0	%100
64	M78	Z	-.075	0	%100
65	M79A	X	.259	0	%100
66	M79A	Z	-.15	0	%100
67	M82	X	.144	0	%100
68	M82	Z	-.083	0	%100
69	M83A	X	.576	0	%100
70	M83A	Z	-.333	0	%100
71	M87	X	.778	0	%100
72	M87	Z	-.449	0	%100
73	M88A	X	.264	0	%100
74	M88A	Z	-.153	0	%100
75	M90	X	.278	0	%100
76	M90	Z	-.161	0	%100
77	M92A	X	.778	0	%100
78	M92A	Z	-.449	0	%100
79	M93	X	1.057	0	%100
80	M93	Z	-.61	0	%100
81	M95	X	1.113	0	%100
82	M95	Z	-.643	0	%100
83	M82A	X	.605	0	%100
84	M82A	Z	-.349	0	%100
85	M91B	X	.151	0	%100
86	M91B	Z	-.087	0	%100
87	MP3C	X	.411	0	%100
88	MP3C	Z	-.237	0	%100
89	MP4C	X	.497	0	%100
90	MP4C	Z	-.287	0	%100
91	MP2C	X	.411	0	%100
92	MP2C	Z	-.237	0	%100
93	MP1C	X	.411	0	%100
94	MP1C	Z	-.237	0	%100
95	MP3B	X	.411	0	%100
96	MP3B	Z	-.237	0	%100
97	MP4B	X	.497	0	%100
98	MP4B	Z	-.287	0	%100
99	MP2B	X	.411	0	%100
100	MP2B	Z	-.237	0	%100
101	MP1B	X	.411	0	%100
102	MP1B	Z	-.237	0	%100
103	M100	X	.124	0	%100
104	M100	Z	-.072	0	%100
105	M105	X	.497	0	%100
106	M105	Z	-.287	0	%100
107	M106	X	.124	0	%100
108	M106	Z	-.072	0	%100
109	M121	X	.633	0	%100
110	M121	Z	-.366	0	%100
111	M122	X	.158	0	%100
112	M122	Z	-.091	0	%100
113	M123	X	.158	0	%100
114	M123	Z	-.091	0	%100



Company :
 Designer :
 Job Number :
 Model Name :

July 6, 2023
 1:03 PM
 Checked By: _____

Member Distributed Loads (BLC 68 : Structure Wm (90 Deg))

	Member Label	Direction	Start Magnitude[lb/ft,F,ksf]	End Magnitude[lb/ft,F,ksf]	Start Location[f..	End Location[ft..
1	M1	X	0	0	0	%100
2	M1	Z	0	0	0	%100
3	M4	X	.71	.71	0	%100
4	M4	Z	0	0	0	%100
5	M10	X	0	0	0	%100
6	M10	Z	0	0	0	%100
7	MP3A	X	.474	.474	0	%100
8	MP3A	Z	0	0	0	%100
9	MP4A	X	.574	.574	0	%100
10	MP4A	Z	0	0	0	%100
11	MP2A	X	.474	.474	0	%100
12	MP2A	Z	0	0	0	%100
13	MP1A	X	.474	.474	0	%100
14	MP1A	Z	0	0	0	%100
15	M43	X	0	0	0	%100
16	M43	Z	0	0	0	%100
17	M46	X	0	0	0	%100
18	M46	Z	0	0	0	%100
19	M51B	X	.499	.499	0	%100
20	M51B	Z	0	0	0	%100
21	M52B	X	.499	.499	0	%100
22	M52B	Z	0	0	0	%100
23	M76	X	1.198	1.198	0	%100
24	M76	Z	0	0	0	%100
25	M77	X	.915	.915	0	%100
26	M77	Z	0	0	0	%100
27	M80	X	.964	.964	0	%100
28	M80	Z	0	0	0	%100
29	M84	X	1.198	1.198	0	%100
30	M84	Z	0	0	0	%100
31	M85	X	.915	.915	0	%100
32	M85	Z	0	0	0	%100
33	M91	X	.964	.964	0	%100
34	M91	Z	0	0	0	%100
35	M52A	X	.177	.177	0	%100
36	M52A	Z	0	0	0	%100
37	M53	X	.45	.45	0	%100
38	M53	Z	0	0	0	%100
39	M54	X	.45	.45	0	%100
40	M54	Z	0	0	0	%100
41	M55	X	.899	.899	0	%100
42	M55	Z	0	0	0	%100
43	M58A	X	.499	.499	0	%100
44	M58A	Z	0	0	0	%100
45	M59A	X	0	0	0	%100
46	M59A	Z	0	0	0	%100
47	M63	X	.3	.3	0	%100
48	M63	Z	0	0	0	%100
49	M64	X	.915	.915	0	%100
50	M64	Z	0	0	0	%100
51	M66	X	.964	.964	0	%100
52	M66	Z	0	0	0	%100
53	M68	X	.3	.3	0	%100
54	M68	Z	0	0	0	%100
55	M69	X	0	0	0	%100
56	M69	Z	0	0	0	%100
57	M71	X	0	0	0	%100

Member Distributed Loads (BLC 68 : Structure Wm (90 Deg)) (Continued)

	Member Label	Direction	Start Magnitude[lb/ft,F,ksf]	End Magnitude[lb/ft,F,ksf]	Start Locationf..	End Locationft..
58	M71	Z	0	0	0	%100
59	M76A	X	.177	.177	0	%100
60	M76A	Z	0	0	0	%100
61	M77A	X	.45	.45	0	%100
62	M77A	Z	0	0	0	%100
63	M78	X	.45	.45	0	%100
64	M78	Z	0	0	0	%100
65	M79A	X	.899	.899	0	%100
66	M79A	Z	0	0	0	%100
67	M82	X	0	0	0	%100
68	M82	Z	0	0	0	%100
69	M83A	X	.499	.499	0	%100
70	M83A	Z	0	0	0	%100
71	M87	X	.3	.3	0	%100
72	M87	Z	0	0	0	%100
73	M88A	X	0	0	0	%100
74	M88A	Z	0	0	0	%100
75	M90	X	0	0	0	%100
76	M90	Z	0	0	0	%100
77	M92A	X	.3	.3	0	%100
78	M92A	Z	0	0	0	%100
79	M93	X	.915	.915	0	%100
80	M93	Z	0	0	0	%100
81	M95	X	.964	.964	0	%100
82	M95	Z	0	0	0	%100
83	M82A	X	.524	.524	0	%100
84	M82A	Z	0	0	0	%100
85	M91B	X	.524	.524	0	%100
86	M91B	Z	0	0	0	%100
87	MP3C	X	.474	.474	0	%100
88	MP3C	Z	0	0	0	%100
89	MP4C	X	.574	.574	0	%100
90	MP4C	Z	0	0	0	%100
91	MP2C	X	.474	.474	0	%100
92	MP2C	Z	0	0	0	%100
93	MP1C	X	.474	.474	0	%100
94	MP1C	Z	0	0	0	%100
95	MP3B	X	.474	.474	0	%100
96	MP3B	Z	0	0	0	%100
97	MP4B	X	.574	.574	0	%100
98	MP4B	Z	0	0	0	%100
99	MP2B	X	.474	.474	0	%100
100	MP2B	Z	0	0	0	%100
101	MP1B	X	.474	.474	0	%100
102	MP1B	Z	0	0	0	%100
103	M100	X	0	0	0	%100
104	M100	Z	0	0	0	%100
105	M105	X	.431	.431	0	%100
106	M105	Z	0	0	0	%100
107	M106	X	.431	.431	0	%100
108	M106	Z	0	0	0	%100
109	M121	X	.548	.548	0	%100
110	M121	Z	0	0	0	%100
111	M122	X	0	0	0	%100
112	M122	Z	0	0	0	%100
113	M123	X	.548	.548	0	%100
114	M123	Z	0	0	0	%100

Member Distributed Loads (BLC 69 : Structure Wm (120 Deg))

	Member Label	Direction	Start Magnitude[lb/ft,F,ksf]	End Magnitude[lb/ft,F,ksf]	Start Location[f..	End Location[ft..
1	M1	X	.151	.151	0	%100
2	M1	Z	.087	.087	0	%100
3	M4	X	.461	.461	0	%100
4	M4	Z	.266	.266	0	%100
5	M10	X	.13	.13	0	%100
6	M10	Z	.075	.075	0	%100
7	MP3A	X	.411	.411	0	%100
8	MP3A	Z	.237	.237	0	%100
9	MP4A	X	.497	.497	0	%100
10	MP4A	Z	.287	.287	0	%100
11	MP2A	X	.411	.411	0	%100
12	MP2A	Z	.237	.237	0	%100
13	MP1A	X	.411	.411	0	%100
14	MP1A	Z	.237	.237	0	%100
15	M43	X	.13	.13	0	%100
16	M43	Z	.075	.075	0	%100
17	M46	X	.259	.259	0	%100
18	M46	Z	.15	.15	0	%100
19	M51B	X	.144	.144	0	%100
20	M51B	Z	.083	.083	0	%100
21	M52B	X	.576	.576	0	%100
22	M52B	Z	.333	.333	0	%100
23	M76	X	.778	.778	0	%100
24	M76	Z	.449	.449	0	%100
25	M77	X	.264	.264	0	%100
26	M77	Z	.153	.153	0	%100
27	M80	X	.278	.278	0	%100
28	M80	Z	.161	.161	0	%100
29	M84	X	.778	.778	0	%100
30	M84	Z	.449	.449	0	%100
31	M85	X	1.057	1.057	0	%100
32	M85	Z	.61	.61	0	%100
33	M91	X	1.113	1.113	0	%100
34	M91	Z	.643	.643	0	%100
35	M52A	X	.461	.461	0	%100
36	M52A	Z	.266	.266	0	%100
37	M53	X	.13	.13	0	%100
38	M53	Z	.075	.075	0	%100
39	M54	X	.13	.13	0	%100
40	M54	Z	.075	.075	0	%100
41	M55	X	.259	.259	0	%100
42	M55	Z	.15	.15	0	%100
43	M58A	X	.576	.576	0	%100
44	M58A	Z	.333	.333	0	%100
45	M59A	X	.144	.144	0	%100
46	M59A	Z	.083	.083	0	%100
47	M63	X	.778	.778	0	%100
48	M63	Z	.449	.449	0	%100
49	M64	X	1.057	1.057	0	%100
50	M64	Z	.61	.61	0	%100
51	M66	X	1.113	1.113	0	%100
52	M66	Z	.643	.643	0	%100
53	M68	X	.778	.778	0	%100
54	M68	Z	.449	.449	0	%100
55	M69	X	.264	.264	0	%100
56	M69	Z	.153	.153	0	%100
57	M71	X	.278	.278	0	%100



Company :
 Designer :
 Job Number :
 Model Name :

July 6, 2023
 1:03 PM
 Checked By: _____

Member Distributed Loads (BLC 69 : Structure Wm (120 Deg)) (Continued)

Member Label	Direction	Start Magnitude[lb/ft.F,ksf]	End Magnitude[lb/ft.F,ksf]	Start Locationft.	End Locationft.
58	M71	Z	.161	0	%100
59	M76A	X	0	0	%100
60	M76A	Z	0	0	%100
61	M77A	X	.52	0	%100
62	M77A	Z	.3	0	%100
63	M78	X	.52	0	%100
64	M78	Z	.3	0	%100
65	M79A	X	1.038	0	%100
66	M79A	Z	.599	0	%100
67	M82	X	.144	0	%100
68	M82	Z	.083	0	%100
69	M83A	X	.144	0	%100
70	M83A	Z	.083	0	%100
71	M87	X	0	0	%100
72	M87	Z	0	0	%100
73	M88A	X	.264	0	%100
74	M88A	Z	.153	0	%100
75	M90	X	.278	0	%100
76	M90	Z	.161	0	%100
77	M92A	X	0	0	%100
78	M92A	Z	0	0	%100
79	M93	X	.264	0	%100
80	M93	Z	.153	0	%100
81	M95	X	.278	0	%100
82	M95	Z	.161	0	%100
83	M82A	X	.151	0	%100
84	M82A	Z	.087	0	%100
85	M91B	X	.605	0	%100
86	M91B	Z	.349	0	%100
87	MP3C	X	.411	0	%100
88	MP3C	Z	.237	0	%100
89	MP4C	X	.497	0	%100
90	MP4C	Z	.287	0	%100
91	MP2C	X	.411	0	%100
92	MP2C	Z	.237	0	%100
93	MP1C	X	.411	0	%100
94	MP1C	Z	.237	0	%100
95	MP3B	X	.411	0	%100
96	MP3B	Z	.237	0	%100
97	MP4B	X	.497	0	%100
98	MP4B	Z	.287	0	%100
99	MP2B	X	.411	0	%100
100	MP2B	Z	.237	0	%100
101	MP1B	X	.411	0	%100
102	MP1B	Z	.237	0	%100
103	M100	X	.124	0	%100
104	M100	Z	.072	0	%100
105	M105	X	.124	0	%100
106	M105	Z	.072	0	%100
107	M106	X	.497	0	%100
108	M106	Z	.287	0	%100
109	M121	X	.158	0	%100
110	M121	Z	.091	0	%100
111	M122	X	.158	0	%100
112	M122	Z	.091	0	%100
113	M123	X	.633	0	%100
114	M123	Z	.366	0	%100

Member Distributed Loads (BLC 70 : Structure Wm (150 Deg)) (Continued)

Member Label	Direction	Start Magnitude[lb/ft,F,ksf]	End Magnitude[lb/ft,F,ksf]	Start Locationft.	End Locationft.
58	M71	Z	.835	0	%100
59	M76A	X	.089	0	%100
60	M76A	Z	.154	0	%100
61	M77A	X	.225	0	%100
62	M77A	Z	.39	0	%100
63	M78	X	.225	0	%100
64	M78	Z	.39	0	%100
65	M79A	X	.449	0	%100
66	M79A	Z	.778	0	%100
67	M82	X	.249	0	%100
68	M82	Z	.432	0	%100
69	M83A	X	0	0	%100
70	M83A	Z	0	0	%100
71	M87	X	.15	0	%100
72	M87	Z	.259	0	%100
73	M88A	X	.458	0	%100
74	M88A	Z	.793	0	%100
75	M90	X	.482	0	%100
76	M90	Z	.835	0	%100
77	M92A	X	.15	0	%100
78	M92A	Z	.259	0	%100
79	M93	X	0	0	%100
80	M93	Z	0	0	%100
81	M95	X	0	0	%100
82	M95	Z	0	0	%100
83	M82A	X	0	0	%100
84	M82A	Z	0	0	%100
85	M91B	X	.262	0	%100
86	M91B	Z	.454	0	%100
87	MP3C	X	.237	0	%100
88	MP3C	Z	.411	0	%100
89	MP4C	X	.287	0	%100
90	MP4C	Z	.497	0	%100
91	MP2C	X	.237	0	%100
92	MP2C	Z	.411	0	%100
93	MP1C	X	.237	0	%100
94	MP1C	Z	.411	0	%100
95	MP3B	X	.237	0	%100
96	MP3B	Z	.411	0	%100
97	MP4B	X	.287	0	%100
98	MP4B	Z	.497	0	%100
99	MP2B	X	.237	0	%100
100	MP2B	Z	.411	0	%100
101	MP1B	X	.237	0	%100
102	MP1B	Z	.411	0	%100
103	M100	X	.215	0	%100
104	M100	Z	.373	0	%100
105	M105	X	0	0	%100
106	M105	Z	0	0	%100
107	M106	X	.215	0	%100
108	M106	Z	.373	0	%100
109	M121	X	0	0	%100
110	M121	Z	0	0	%100
111	M122	X	.274	0	%100
112	M122	Z	.475	0	%100
113	M123	X	.274	0	%100
114	M123	Z	.475	0	%100

Member Distributed Loads (BLC 71 : Structure Wm (180 Deg))

	Member Label	Direction	Start Magnitude[lb/ft,F,ksf]	End Magnitude[lb/ft,F,ksf]	Start Location[f..	End Location[f..
1	M1	X	0	0	0	%100
2	M1	Z	.699	.699	0	%100
3	M4	X	0	0	0	%100
4	M4	Z	0	0	0	%100
5	M10	X	0	0	0	%100
6	M10	Z	.601	.601	0	%100
7	MP3A	X	0	0	0	%100
8	MP3A	Z	.474	.474	0	%100
9	MP4A	X	0	0	0	%100
10	MP4A	Z	.574	.574	0	%100
11	MP2A	X	0	0	0	%100
12	MP2A	Z	.474	.474	0	%100
13	MP1A	X	0	0	0	%100
14	MP1A	Z	.474	.474	0	%100
15	M43	X	0	0	0	%100
16	M43	Z	.601	.601	0	%100
17	M46	X	0	0	0	%100
18	M46	Z	1.198	1.198	0	%100
19	M51B	X	0	0	0	%100
20	M51B	Z	.166	.166	0	%100
21	M52B	X	0	0	0	%100
22	M52B	Z	.166	.166	0	%100
23	M76	X	0	0	0	%100
24	M76	Z	0	0	0	%100
25	M77	X	0	0	0	%100
26	M77	Z	.305	.305	0	%100
27	M80	X	0	0	0	%100
28	M80	Z	.321	.321	0	%100
29	M84	X	0	0	0	%100
30	M84	Z	0	0	0	%100
31	M85	X	0	0	0	%100
32	M85	Z	.305	.305	0	%100
33	M91	X	0	0	0	%100
34	M91	Z	.321	.321	0	%100
35	M52A	X	0	0	0	%100
36	M52A	Z	.532	.532	0	%100
37	M53	X	0	0	0	%100
38	M53	Z	.15	.15	0	%100
39	M54	X	0	0	0	%100
40	M54	Z	.15	.15	0	%100
41	M55	X	0	0	0	%100
42	M55	Z	.3	.3	0	%100
43	M58A	X	0	0	0	%100
44	M58A	Z	.166	.166	0	%100
45	M59A	X	0	0	0	%100
46	M59A	Z	.665	.665	0	%100
47	M63	X	0	0	0	%100
48	M63	Z	.899	.899	0	%100
49	M64	X	0	0	0	%100
50	M64	Z	.305	.305	0	%100
51	M66	X	0	0	0	%100
52	M66	Z	.321	.321	0	%100
53	M68	X	0	0	0	%100
54	M68	Z	.899	.899	0	%100
55	M69	X	0	0	0	%100
56	M69	Z	1.22	1.22	0	%100
57	M71	X	0	0	0	%100

Member Distributed Loads (BLC 71 : Structure Wm (180 Deg)) (Continued)

Member Label	Direction	Start Magnitude[lb/ft,F,ksf]	End Magnitude[lb/ft,F,ksf]	Start Locationft.	End Locationft.
58	M71	Z	1.285	0	%100
59	M76A	X	0	0	%100
60	M76A	Z	.532	0	%100
61	M77A	X	0	0	%100
62	M77A	Z	.15	0	%100
63	M78	X	0	0	%100
64	M78	Z	.15	0	%100
65	M79A	X	0	0	%100
66	M79A	Z	.3	0	%100
67	M82	X	0	0	%100
68	M82	Z	.665	0	%100
69	M83A	X	0	0	%100
70	M83A	Z	.166	0	%100
71	M87	X	0	0	%100
72	M87	Z	.899	0	%100
73	M88A	X	0	0	%100
74	M88A	Z	1.22	0	%100
75	M90	X	0	0	%100
76	M90	Z	1.285	0	%100
77	M92A	X	0	0	%100
78	M92A	Z	.899	0	%100
79	M93	X	0	0	%100
80	M93	Z	.305	0	%100
81	M95	X	0	0	%100
82	M95	Z	.321	0	%100
83	M82A	X	0	0	%100
84	M82A	Z	.175	0	%100
85	M91B	X	0	0	%100
86	M91B	Z	.175	0	%100
87	MP3C	X	0	0	%100
88	MP3C	Z	.474	0	%100
89	MP4C	X	0	0	%100
90	MP4C	Z	.574	0	%100
91	MP2C	X	0	0	%100
92	MP2C	Z	.474	0	%100
93	MP1C	X	0	0	%100
94	MP1C	Z	.474	0	%100
95	MP3B	X	0	0	%100
96	MP3B	Z	.474	0	%100
97	MP4B	X	0	0	%100
98	MP4B	Z	.574	0	%100
99	MP2B	X	0	0	%100
100	MP2B	Z	.474	0	%100
101	MP1B	X	0	0	%100
102	MP1B	Z	.474	0	%100
103	M100	X	0	0	%100
104	M100	Z	.574	0	%100
105	M105	X	0	0	%100
106	M105	Z	.144	0	%100
107	M106	X	0	0	%100
108	M106	Z	.144	0	%100
109	M121	X	0	0	%100
110	M121	Z	.183	0	%100
111	M122	X	0	0	%100
112	M122	Z	.731	0	%100
113	M123	X	0	0	%100
114	M123	Z	.183	0	%100

Member Distributed Loads (BLC 72 : Structure Wm (210 Deg))

	Member Label	Direction	Start Magnitude[lb/ft,F,ksf]	End Magnitude[lb/ft,F,ksf]	Start Location[f..	End Location[ft..
1	M1	X	-.262	-.262	0	%100
2	M1	Z	.454	.454	0	%100
3	M4	X	-.089	-.089	0	%100
4	M4	Z	.154	.154	0	%100
5	M10	X	-.225	-.225	0	%100
6	M10	Z	.39	.39	0	%100
7	MP3A	X	-.237	-.237	0	%100
8	MP3A	Z	.411	.411	0	%100
9	MP4A	X	-.287	-.287	0	%100
10	MP4A	Z	.497	.497	0	%100
11	MP2A	X	-.237	-.237	0	%100
12	MP2A	Z	.411	.411	0	%100
13	MP1A	X	-.237	-.237	0	%100
14	MP1A	Z	.411	.411	0	%100
15	M43	X	-.225	-.225	0	%100
16	M43	Z	.39	.39	0	%100
17	M46	X	-.449	-.449	0	%100
18	M46	Z	.778	.778	0	%100
19	M51B	X	-.249	-.249	0	%100
20	M51B	Z	.432	.432	0	%100
21	M52B	X	0	0	0	%100
22	M52B	Z	0	0	0	%100
23	M76	X	-.15	-.15	0	%100
24	M76	Z	.259	.259	0	%100
25	M77	X	-.458	-.458	0	%100
26	M77	Z	.793	.793	0	%100
27	M80	X	-.482	-.482	0	%100
28	M80	Z	.835	.835	0	%100
29	M84	X	-.15	-.15	0	%100
30	M84	Z	.259	.259	0	%100
31	M85	X	0	0	0	%100
32	M85	Z	0	0	0	%100
33	M91	X	0	0	0	%100
34	M91	Z	0	0	0	%100
35	M52A	X	-.089	-.089	0	%100
36	M52A	Z	.154	.154	0	%100
37	M53	X	-.225	-.225	0	%100
38	M53	Z	.39	.39	0	%100
39	M54	X	-.225	-.225	0	%100
40	M54	Z	.39	.39	0	%100
41	M55	X	-.449	-.449	0	%100
42	M55	Z	.778	.778	0	%100
43	M58A	X	0	0	0	%100
44	M58A	Z	0	0	0	%100
45	M59A	X	-.249	-.249	0	%100
46	M59A	Z	.432	.432	0	%100
47	M63	X	-.15	-.15	0	%100
48	M63	Z	.259	.259	0	%100
49	M64	X	0	0	0	%100
50	M64	Z	0	0	0	%100
51	M66	X	0	0	0	%100
52	M66	Z	0	0	0	%100
53	M68	X	-.15	-.15	0	%100
54	M68	Z	.259	.259	0	%100
55	M69	X	-.458	-.458	0	%100
56	M69	Z	.793	.793	0	%100
57	M71	X	-.482	-.482	0	%100

Member Distributed Loads (BLC 72 : Structure Wm (210 Deg)) (Continued)

Member Label	Direction	Start Magnitude[lb/ft,F,ksf]	End Magnitude[lb/ft,F,ksf]	Start Locationft..	End Locationft..
58	M71	Z	.835	0	%100
59	M76A	X	-.355	0	%100
60	M76A	Z	.615	0	%100
61	M77A	X	0	0	%100
62	M77A	Z	0	0	%100
63	M78	X	0	0	%100
64	M78	Z	0	0	%100
65	M79A	X	0	0	%100
66	M79A	Z	0	0	%100
67	M82	X	-.249	0	%100
68	M82	Z	.432	0	%100
69	M83A	X	-.249	0	%100
70	M83A	Z	.432	0	%100
71	M87	X	-.599	0	%100
72	M87	Z	1.038	0	%100
73	M88A	X	-.458	0	%100
74	M88A	Z	.793	0	%100
75	M90	X	-.482	0	%100
76	M90	Z	.835	0	%100
77	M92A	X	-.599	0	%100
78	M92A	Z	1.038	0	%100
79	M93	X	-.458	0	%100
80	M93	Z	.793	0	%100
81	M95	X	-.482	0	%100
82	M95	Z	.835	0	%100
83	M82A	X	-.262	0	%100
84	M82A	Z	.454	0	%100
85	M91B	X	0	0	%100
86	M91B	Z	0	0	%100
87	MP3C	X	-.237	0	%100
88	MP3C	Z	.411	0	%100
89	MP4C	X	-.287	0	%100
90	MP4C	Z	.497	0	%100
91	MP2C	X	-.237	0	%100
92	MP2C	Z	.411	0	%100
93	MP1C	X	-.237	0	%100
94	MP1C	Z	.411	0	%100
95	MP3B	X	-.237	0	%100
96	MP3B	Z	.411	0	%100
97	MP4B	X	-.287	0	%100
98	MP4B	Z	.497	0	%100
99	MP2B	X	-.237	0	%100
100	MP2B	Z	.411	0	%100
101	MP1B	X	-.237	0	%100
102	MP1B	Z	.411	0	%100
103	M100	X	-.215	0	%100
104	M100	Z	.373	0	%100
105	M105	X	-.215	0	%100
106	M105	Z	.373	0	%100
107	M106	X	0	0	%100
108	M106	Z	0	0	%100
109	M121	X	-.274	0	%100
110	M121	Z	.475	0	%100
111	M122	X	-.274	0	%100
112	M122	Z	.475	0	%100
113	M123	X	0	0	%100
114	M123	Z	0	0	%100

Member Distributed Loads (BLC 73 : Structure Wm (240 Deg)) (Continued)

Member Label	Direction	Start Magnitude[lb/ft,F,ksf]	End Magnitude[lb/ft,F,ksf]	Start Locationft..	End Locationft..
58	M71	Z	.161	0	%100
59	M76A	X	-.461	0	%100
60	M76A	Z	.266	0	%100
61	M77A	X	-.13	0	%100
62	M77A	Z	.075	0	%100
63	M78	X	-.13	0	%100
64	M78	Z	.075	0	%100
65	M79A	X	-.259	0	%100
66	M79A	Z	.15	0	%100
67	M82	X	-.144	0	%100
68	M82	Z	.083	0	%100
69	M83A	X	-.576	0	%100
70	M83A	Z	.333	0	%100
71	M87	X	-.778	0	%100
72	M87	Z	.449	0	%100
73	M88A	X	-.264	0	%100
74	M88A	Z	.153	0	%100
75	M90	X	-.278	0	%100
76	M90	Z	.161	0	%100
77	M92A	X	-.778	0	%100
78	M92A	Z	.449	0	%100
79	M93	X	-1.057	0	%100
80	M93	Z	.61	0	%100
81	M95	X	-1.113	0	%100
82	M95	Z	.643	0	%100
83	M82A	X	-.605	0	%100
84	M82A	Z	.349	0	%100
85	M91B	X	-.151	0	%100
86	M91B	Z	.087	0	%100
87	MP3C	X	-.411	0	%100
88	MP3C	Z	.237	0	%100
89	MP4C	X	-.497	0	%100
90	MP4C	Z	.287	0	%100
91	MP2C	X	-.411	0	%100
92	MP2C	Z	.237	0	%100
93	MP1C	X	-.411	0	%100
94	MP1C	Z	.237	0	%100
95	MP3B	X	-.411	0	%100
96	MP3B	Z	.237	0	%100
97	MP4B	X	-.497	0	%100
98	MP4B	Z	.287	0	%100
99	MP2B	X	-.411	0	%100
100	MP2B	Z	.237	0	%100
101	MP1B	X	-.411	0	%100
102	MP1B	Z	.237	0	%100
103	M100	X	-.124	0	%100
104	M100	Z	.072	0	%100
105	M105	X	-.497	0	%100
106	M105	Z	.287	0	%100
107	M106	X	-.124	0	%100
108	M106	Z	.072	0	%100
109	M121	X	-.633	0	%100
110	M121	Z	.366	0	%100
111	M122	X	-.158	0	%100
112	M122	Z	.091	0	%100
113	M123	X	-.158	0	%100
114	M123	Z	.091	0	%100

Member Distributed Loads (BLC 74 : Structure Wm (270 Deg))

	Member Label	Direction	Start Magnitude[lb/ft,F,ksf]	End Magnitude[lb/ft,F,ksf]	Start Location[f..	End Location[ft..
1	M1	X	0	0	0	%100
2	M1	Z	0	0	0	%100
3	M4	X	-.71	-.71	0	%100
4	M4	Z	0	0	0	%100
5	M10	X	0	0	0	%100
6	M10	Z	0	0	0	%100
7	MP3A	X	-.474	-.474	0	%100
8	MP3A	Z	0	0	0	%100
9	MP4A	X	-.574	-.574	0	%100
10	MP4A	Z	0	0	0	%100
11	MP2A	X	-.474	-.474	0	%100
12	MP2A	Z	0	0	0	%100
13	MP1A	X	-.474	-.474	0	%100
14	MP1A	Z	0	0	0	%100
15	M43	X	0	0	0	%100
16	M43	Z	0	0	0	%100
17	M46	X	0	0	0	%100
18	M46	Z	0	0	0	%100
19	M51B	X	-.499	-.499	0	%100
20	M51B	Z	0	0	0	%100
21	M52B	X	-.499	-.499	0	%100
22	M52B	Z	0	0	0	%100
23	M76	X	-1.198	-1.198	0	%100
24	M76	Z	0	0	0	%100
25	M77	X	-.915	-.915	0	%100
26	M77	Z	0	0	0	%100
27	M80	X	-.964	-.964	0	%100
28	M80	Z	0	0	0	%100
29	M84	X	-1.198	-1.198	0	%100
30	M84	Z	0	0	0	%100
31	M85	X	-.915	-.915	0	%100
32	M85	Z	0	0	0	%100
33	M91	X	-.964	-.964	0	%100
34	M91	Z	0	0	0	%100
35	M52A	X	-.177	-.177	0	%100
36	M52A	Z	0	0	0	%100
37	M53	X	-.45	-.45	0	%100
38	M53	Z	0	0	0	%100
39	M54	X	-.45	-.45	0	%100
40	M54	Z	0	0	0	%100
41	M55	X	-.899	-.899	0	%100
42	M55	Z	0	0	0	%100
43	M58A	X	-.499	-.499	0	%100
44	M58A	Z	0	0	0	%100
45	M59A	X	0	0	0	%100
46	M59A	Z	0	0	0	%100
47	M63	X	-.3	-.3	0	%100
48	M63	Z	0	0	0	%100
49	M64	X	-.915	-.915	0	%100
50	M64	Z	0	0	0	%100
51	M66	X	-.964	-.964	0	%100
52	M66	Z	0	0	0	%100
53	M68	X	-.3	-.3	0	%100
54	M68	Z	0	0	0	%100
55	M69	X	0	0	0	%100
56	M69	Z	0	0	0	%100
57	M71	X	0	0	0	%100

Member Distributed Loads (BLC 74 : Structure Wm (270 Deg)) (Continued)

Member Label	Direction	Start Magnitude[lb/ft,F,ksf]	End Magnitude[lb/ft,F,ksf]	Start Locationft.	End Locationft.
58	M71	Z	0	0	%100
59	M76A	X	-.177	0	%100
60	M76A	Z	0	0	%100
61	M77A	X	-.45	0	%100
62	M77A	Z	0	0	%100
63	M78	X	-.45	0	%100
64	M78	Z	0	0	%100
65	M79A	X	-.899	0	%100
66	M79A	Z	0	0	%100
67	M82	X	0	0	%100
68	M82	Z	0	0	%100
69	M83A	X	-.499	0	%100
70	M83A	Z	0	0	%100
71	M87	X	-.3	0	%100
72	M87	Z	0	0	%100
73	M88A	X	0	0	%100
74	M88A	Z	0	0	%100
75	M90	X	0	0	%100
76	M90	Z	0	0	%100
77	M92A	X	-.3	0	%100
78	M92A	Z	0	0	%100
79	M93	X	-.915	0	%100
80	M93	Z	0	0	%100
81	M95	X	-.964	0	%100
82	M95	Z	0	0	%100
83	M82A	X	-.524	0	%100
84	M82A	Z	0	0	%100
85	M91B	X	-.524	0	%100
86	M91B	Z	0	0	%100
87	MP3C	X	-.474	0	%100
88	MP3C	Z	0	0	%100
89	MP4C	X	-.574	0	%100
90	MP4C	Z	0	0	%100
91	MP2C	X	-.474	0	%100
92	MP2C	Z	0	0	%100
93	MP1C	X	-.474	0	%100
94	MP1C	Z	0	0	%100
95	MP3B	X	-.474	0	%100
96	MP3B	Z	0	0	%100
97	MP4B	X	-.574	0	%100
98	MP4B	Z	0	0	%100
99	MP2B	X	-.474	0	%100
100	MP2B	Z	0	0	%100
101	MP1B	X	-.474	0	%100
102	MP1B	Z	0	0	%100
103	M100	X	0	0	%100
104	M100	Z	0	0	%100
105	M105	X	-.431	0	%100
106	M105	Z	0	0	%100
107	M106	X	-.431	0	%100
108	M106	Z	0	0	%100
109	M121	X	-.548	0	%100
110	M121	Z	0	0	%100
111	M122	X	0	0	%100
112	M122	Z	0	0	%100
113	M123	X	-.548	0	%100
114	M123	Z	0	0	%100

Member Distributed Loads (BLC 75 : Structure Wm (300 Deg))

	Member Label	Direction	Start Magnitude[lb/ft,F,ksf]	End Magnitude[lb/ft,F,ksf]	Start Location[f..	End Location[ft..
1	M1	X	- .151	- .151	0	%100
2	M1	Z	- .087	- .087	0	%100
3	M4	X	- .461	- .461	0	%100
4	M4	Z	- .266	- .266	0	%100
5	M10	X	- .13	- .13	0	%100
6	M10	Z	- .075	- .075	0	%100
7	MP3A	X	- .411	- .411	0	%100
8	MP3A	Z	- .237	- .237	0	%100
9	MP4A	X	- .497	- .497	0	%100
10	MP4A	Z	- .287	- .287	0	%100
11	MP2A	X	- .411	- .411	0	%100
12	MP2A	Z	- .237	- .237	0	%100
13	MP1A	X	- .411	- .411	0	%100
14	MP1A	Z	- .237	- .237	0	%100
15	M43	X	- .13	- .13	0	%100
16	M43	Z	- .075	- .075	0	%100
17	M46	X	- .259	- .259	0	%100
18	M46	Z	- .15	- .15	0	%100
19	M51B	X	- .144	- .144	0	%100
20	M51B	Z	- .083	- .083	0	%100
21	M52B	X	- .576	- .576	0	%100
22	M52B	Z	- .333	- .333	0	%100
23	M76	X	- .778	- .778	0	%100
24	M76	Z	- .449	- .449	0	%100
25	M77	X	- .264	- .264	0	%100
26	M77	Z	- .153	- .153	0	%100
27	M80	X	- .278	- .278	0	%100
28	M80	Z	- .161	- .161	0	%100
29	M84	X	- .778	- .778	0	%100
30	M84	Z	- .449	- .449	0	%100
31	M85	X	- 1.057	- 1.057	0	%100
32	M85	Z	- .61	- .61	0	%100
33	M91	X	- 1.113	- 1.113	0	%100
34	M91	Z	- .643	- .643	0	%100
35	M52A	X	- .461	- .461	0	%100
36	M52A	Z	- .266	- .266	0	%100
37	M53	X	- .13	- .13	0	%100
38	M53	Z	- .075	- .075	0	%100
39	M54	X	- .13	- .13	0	%100
40	M54	Z	- .075	- .075	0	%100
41	M55	X	- .259	- .259	0	%100
42	M55	Z	- .15	- .15	0	%100
43	M58A	X	- .576	- .576	0	%100
44	M58A	Z	- .333	- .333	0	%100
45	M59A	X	- .144	- .144	0	%100
46	M59A	Z	- .083	- .083	0	%100
47	M63	X	- .778	- .778	0	%100
48	M63	Z	- .449	- .449	0	%100
49	M64	X	- 1.057	- 1.057	0	%100
50	M64	Z	- .61	- .61	0	%100
51	M66	X	- 1.113	- 1.113	0	%100
52	M66	Z	- .643	- .643	0	%100
53	M68	X	- .778	- .778	0	%100
54	M68	Z	- .449	- .449	0	%100
55	M69	X	- .264	- .264	0	%100
56	M69	Z	- .153	- .153	0	%100
57	M71	X	- .278	- .278	0	%100



Company :
 Designer :
 Job Number :
 Model Name :

July 6, 2023
 1:03 PM
 Checked By: _____

Member Distributed Loads (BLC 75 : Structure Wm (300 Deg)) (Continued)

Member Label	Direction	Start Magnitude[lb/ft,F,ksf]	End Magnitude[lb/ft,F,ksf]	Start Locationft.	End Locationft.
58	M71	Z	- .161	0	%100
59	M76A	X	0	0	%100
60	M76A	Z	0	0	%100
61	M77A	X	-.52	0	%100
62	M77A	Z	-.3	0	%100
63	M78	X	-.52	0	%100
64	M78	Z	-.3	0	%100
65	M79A	X	-1.038	0	%100
66	M79A	Z	-.599	0	%100
67	M82	X	-.144	0	%100
68	M82	Z	-.083	0	%100
69	M83A	X	-.144	0	%100
70	M83A	Z	-.083	0	%100
71	M87	X	0	0	%100
72	M87	Z	0	0	%100
73	M88A	X	-.264	0	%100
74	M88A	Z	-.153	0	%100
75	M90	X	-.278	0	%100
76	M90	Z	-.161	0	%100
77	M92A	X	0	0	%100
78	M92A	Z	0	0	%100
79	M93	X	-.264	0	%100
80	M93	Z	-.153	0	%100
81	M95	X	-.278	0	%100
82	M95	Z	-.161	0	%100
83	M82A	X	-.151	0	%100
84	M82A	Z	-.087	0	%100
85	M91B	X	-.605	0	%100
86	M91B	Z	-.349	0	%100
87	MP3C	X	-.411	0	%100
88	MP3C	Z	-.237	0	%100
89	MP4C	X	-.497	0	%100
90	MP4C	Z	-.287	0	%100
91	MP2C	X	-.411	0	%100
92	MP2C	Z	-.237	0	%100
93	MP1C	X	-.411	0	%100
94	MP1C	Z	-.237	0	%100
95	MP3B	X	-.411	0	%100
96	MP3B	Z	-.237	0	%100
97	MP4B	X	-.497	0	%100
98	MP4B	Z	-.287	0	%100
99	MP2B	X	-.411	0	%100
100	MP2B	Z	-.237	0	%100
101	MP1B	X	-.411	0	%100
102	MP1B	Z	-.237	0	%100
103	M100	X	-.124	0	%100
104	M100	Z	-.072	0	%100
105	M105	X	-.124	0	%100
106	M105	Z	-.072	0	%100
107	M106	X	-.497	0	%100
108	M106	Z	-.287	0	%100
109	M121	X	-.158	0	%100
110	M121	Z	-.091	0	%100
111	M122	X	-.158	0	%100
112	M122	Z	-.091	0	%100
113	M123	X	-.633	0	%100
114	M123	Z	-.366	0	%100

Member Distributed Loads (BLC 76 : Structure Wm (330 Deg))

	Member Label	Direction	Start Magnitude[lb/ft,F,ksf]	End Magnitude[lb/ft,F,ksf]	Start Location[f..	End Location[ft..
1	M1	X	-.262	-.262	0	%100
2	M1	Z	-.454	-.454	0	%100
3	M4	X	-.089	-.089	0	%100
4	M4	Z	-.154	-.154	0	%100
5	M10	X	-.225	-.225	0	%100
6	M10	Z	-.39	-.39	0	%100
7	MP3A	X	-.237	-.237	0	%100
8	MP3A	Z	-.411	-.411	0	%100
9	MP4A	X	-.287	-.287	0	%100
10	MP4A	Z	-.497	-.497	0	%100
11	MP2A	X	-.237	-.237	0	%100
12	MP2A	Z	-.411	-.411	0	%100
13	MP1A	X	-.237	-.237	0	%100
14	MP1A	Z	-.411	-.411	0	%100
15	M43	X	-.225	-.225	0	%100
16	M43	Z	-.39	-.39	0	%100
17	M46	X	-.449	-.449	0	%100
18	M46	Z	-.778	-.778	0	%100
19	M51B	X	0	0	0	%100
20	M51B	Z	0	0	0	%100
21	M52B	X	-.249	-.249	0	%100
22	M52B	Z	-.432	-.432	0	%100
23	M76	X	-.15	-.15	0	%100
24	M76	Z	-.259	-.259	0	%100
25	M77	X	0	0	0	%100
26	M77	Z	0	0	0	%100
27	M80	X	0	0	0	%100
28	M80	Z	0	0	0	%100
29	M84	X	-.15	-.15	0	%100
30	M84	Z	-.259	-.259	0	%100
31	M85	X	-.458	-.458	0	%100
32	M85	Z	-.793	-.793	0	%100
33	M91	X	-.482	-.482	0	%100
34	M91	Z	-.835	-.835	0	%100
35	M52A	X	-.355	-.355	0	%100
36	M52A	Z	-.615	-.615	0	%100
37	M53	X	0	0	0	%100
38	M53	Z	0	0	0	%100
39	M54	X	0	0	0	%100
40	M54	Z	0	0	0	%100
41	M55	X	0	0	0	%100
42	M55	Z	0	0	0	%100
43	M58A	X	-.249	-.249	0	%100
44	M58A	Z	-.432	-.432	0	%100
45	M59A	X	-.249	-.249	0	%100
46	M59A	Z	-.432	-.432	0	%100
47	M63	X	-.599	-.599	0	%100
48	M63	Z	-1.038	-1.038	0	%100
49	M64	X	-.458	-.458	0	%100
50	M64	Z	-.793	-.793	0	%100
51	M66	X	-.482	-.482	0	%100
52	M66	Z	-.835	-.835	0	%100
53	M68	X	-.599	-.599	0	%100
54	M68	Z	-1.038	-1.038	0	%100
55	M69	X	-.458	-.458	0	%100
56	M69	Z	-.793	-.793	0	%100
57	M71	X	-.482	-.482	0	%100

Member Distributed Loads (BLC 76 : Structure Wm (330 Deg)) (Continued)

Member Label	Direction	Start Magnitude[lb/ft,F,ksf]	End Magnitude[lb/ft,F,ksf]	Start Locationft..	End Locationft..
58	M71	Z	- .835	0	%100
59	M76A	X	- .089	0	%100
60	M76A	Z	- .154	0	%100
61	M77A	X	- .225	0	%100
62	M77A	Z	- .39	0	%100
63	M78	X	- .225	0	%100
64	M78	Z	- .39	0	%100
65	M79A	X	- .449	0	%100
66	M79A	Z	- .778	0	%100
67	M82	X	- .249	0	%100
68	M82	Z	- .432	0	%100
69	M83A	X	0	0	%100
70	M83A	Z	0	0	%100
71	M87	X	- .15	0	%100
72	M87	Z	- .259	0	%100
73	M88A	X	- .458	0	%100
74	M88A	Z	- .793	0	%100
75	M90	X	- .482	0	%100
76	M90	Z	- .835	0	%100
77	M92A	X	- .15	0	%100
78	M92A	Z	- .259	0	%100
79	M93	X	0	0	%100
80	M93	Z	0	0	%100
81	M95	X	0	0	%100
82	M95	Z	0	0	%100
83	M82A	X	0	0	%100
84	M82A	Z	0	0	%100
85	M91B	X	- .262	0	%100
86	M91B	Z	- .454	0	%100
87	MP3C	X	- .237	0	%100
88	MP3C	Z	- .411	0	%100
89	MP4C	X	- .287	0	%100
90	MP4C	Z	- .497	0	%100
91	MP2C	X	- .237	0	%100
92	MP2C	Z	- .411	0	%100
93	MP1C	X	- .237	0	%100
94	MP1C	Z	- .411	0	%100
95	MP3B	X	- .237	0	%100
96	MP3B	Z	- .411	0	%100
97	MP4B	X	- .287	0	%100
98	MP4B	Z	- .497	0	%100
99	MP2B	X	- .237	0	%100
100	MP2B	Z	- .411	0	%100
101	MP1B	X	- .237	0	%100
102	MP1B	Z	- .411	0	%100
103	M100	X	- .215	0	%100
104	M100	Z	- .373	0	%100
105	M105	X	0	0	%100
106	M105	Z	0	0	%100
107	M106	X	- .215	0	%100
108	M106	Z	- .373	0	%100
109	M121	X	0	0	%100
110	M121	Z	0	0	%100
111	M122	X	- .274	0	%100
112	M122	Z	- .475	0	%100
113	M123	X	- .274	0	%100
114	M123	Z	- .475	0	%100

Member Distributed Loads (BLC 87 : BLC 39 Transient Area Loads)

	Member Label	Direction	Start Magnitude[lb/ft,F,ksf]	End Magnitude[lb/ft,F,ksf]	Start Location[f...]	End Location[ft...]
1	M82	Y	-1.884	-4.426	0	.832
2	M82	Y	-4.426	-7.044	.832	1.665
3	M82	Y	-7.044	-8.26	1.665	2.497
4	M82	Y	-8.26	-6.573	2.497	3.329
5	M82	Y	-6.573	-3.462	3.329	4.162
6	M83A	Y	-3.463	-6.545	0	.832
7	M83A	Y	-6.545	-8.189	.832	1.665
8	M83A	Y	-8.189	-6.902	1.665	2.497
9	M83A	Y	-6.902	-4.228	2.497	3.329
10	M83A	Y	-4.228	-1.661	3.329	4.162
11	M51B	Y	-1.661	-4.228	0	.832
12	M51B	Y	-4.228	-6.902	.832	1.665
13	M51B	Y	-6.902	-8.189	1.665	2.497
14	M51B	Y	-8.189	-6.545	2.497	3.329
15	M51B	Y	-6.545	-3.463	3.329	4.162
16	M52B	Y	-3.462	-6.573	0	.832
17	M52B	Y	-6.573	-8.26	.832	1.665
18	M52B	Y	-8.26	-7.044	1.665	2.497
19	M52B	Y	-7.044	-4.426	2.497	3.329
20	M52B	Y	-4.426	-1.884	3.329	4.162
21	M58A	Y	-1.661	-4.228	0	.832
22	M58A	Y	-4.228	-6.902	.832	1.665
23	M58A	Y	-6.902	-8.189	1.665	2.497
24	M58A	Y	-8.189	-6.545	2.497	3.329
25	M58A	Y	-6.545	-3.463	3.329	4.162
26	M59A	Y	-3.462	-6.573	0	.832
27	M59A	Y	-6.573	-8.26	.832	1.665
28	M59A	Y	-8.26	-7.044	1.665	2.497
29	M59A	Y	-7.044	-4.426	2.497	3.329
30	M59A	Y	-4.426	-1.884	3.329	4.162

Member Distributed Loads (BLC 88 : BLC 40 Transient Area Loads)

	Member Label	Direction	Start Magnitude[lb/ft,F,ksf]	End Magnitude[lb/ft,F,ksf]	Start Location[f...]	End Location[ft...]
1	M82	Y	-3.986	-9.363	0	.832
2	M82	Y	-9.363	-14.902	.832	1.665
3	M82	Y	-14.902	-17.474	1.665	2.497
4	M82	Y	-17.474	-13.905	2.497	3.329
5	M82	Y	-13.905	-7.323	3.329	4.162
6	M83A	Y	-7.326	-13.844	0	.832
7	M83A	Y	-13.844	-17.322	.832	1.665
8	M83A	Y	-17.322	-14.6	1.665	2.497
9	M83A	Y	-14.6	-8.944	2.497	3.329
10	M83A	Y	-8.944	-3.514	3.329	4.162
11	M51B	Y	-3.514	-8.944	0	.832
12	M51B	Y	-8.944	-14.6	.832	1.665
13	M51B	Y	-14.6	-17.322	1.665	2.497
14	M51B	Y	-17.322	-13.844	2.497	3.329
15	M51B	Y	-13.844	-7.326	3.329	4.162
16	M52B	Y	-7.323	-13.905	0	.832
17	M52B	Y	-13.905	-17.474	.832	1.665
18	M52B	Y	-17.474	-14.902	1.665	2.497
19	M52B	Y	-14.902	-9.363	2.497	3.329
20	M52B	Y	-9.363	-3.986	3.329	4.162
21	M58A	Y	-3.514	-8.944	0	.832
22	M58A	Y	-8.944	-14.6	.832	1.665
23	M58A	Y	-14.6	-17.322	1.665	2.497

Member Distributed Loads (BLC 88 : BLC 40 Transient Area Loads) (Continued)

	Member Label	Direction	Start Magnitude[lb/ft.F,ksf]	End Magnitude[lb/ft.F,ksf]	Start Locationf...	End Locationft...
24	M58A	Y	-17.322	-13.844	2.497	3.329
25	M58A	Y	-13.844	-7.326	3.329	4.162
26	M59A	Y	-7.323	-13.905	0	.832
27	M59A	Y	-13.905	-17.474	.832	1.665
28	M59A	Y	-17.474	-14.902	1.665	2.497
29	M59A	Y	-14.902	-9.363	2.497	3.329
30	M59A	Y	-9.363	-3.986	3.329	4.162

Member Distributed Loads (BLC 89 : BLC 84 Transient Area Loads)

	Member Label	Direction	Start Magnitude[lb/ft.F,ksf]	End Magnitude[lb/ft.F,ksf]	Start Locationf...	End Locationft...
1	M82	Y	-.081	-.19	0	.832
2	M82	Y	-.19	-.302	.832	1.665
3	M82	Y	-.302	-.354	1.665	2.497
4	M82	Y	-.354	-.282	2.497	3.329
5	M82	Y	-.282	-.148	3.329	4.162
6	M83A	Y	-.149	-.281	0	.832
7	M83A	Y	-.281	-.351	.832	1.665
8	M83A	Y	-.351	-.296	1.665	2.497
9	M83A	Y	-.296	-.181	2.497	3.329
10	M83A	Y	-.181	-.071	3.329	4.162
11	M51B	Y	-.071	-.181	0	.832
12	M51B	Y	-.181	-.296	.832	1.665
13	M51B	Y	-.296	-.351	1.665	2.497
14	M51B	Y	-.351	-.281	2.497	3.329
15	M51B	Y	-.281	-.149	3.329	4.162
16	M52B	Y	-.148	-.282	0	.832
17	M52B	Y	-.282	-.354	.832	1.665
18	M52B	Y	-.354	-.302	1.665	2.497
19	M52B	Y	-.302	-.19	2.497	3.329
20	M52B	Y	-.19	-.081	3.329	4.162
21	M58A	Y	-.071	-.181	0	.832
22	M58A	Y	-.181	-.296	.832	1.665
23	M58A	Y	-.296	-.351	1.665	2.497
24	M58A	Y	-.351	-.281	2.497	3.329
25	M58A	Y	-.281	-.149	3.329	4.162
26	M59A	Y	-.148	-.282	0	.832
27	M59A	Y	-.282	-.354	.832	1.665
28	M59A	Y	-.354	-.302	1.665	2.497
29	M59A	Y	-.302	-.19	2.497	3.329
30	M59A	Y	-.19	-.081	3.329	4.162

Member Distributed Loads (BLC 90 : BLC 85 Transient Area Loads)

	Member Label	Direction	Start Magnitude[lb/ft.F,ksf]	End Magnitude[lb/ft.F,ksf]	Start Locationf...	End Locationft...
1	M82	Z	-.202	-.474	0	.832
2	M82	Z	-.474	-.755	.832	1.665
3	M82	Z	-.755	-.885	1.665	2.497
4	M82	Z	-.885	-.704	2.497	3.329
5	M82	Z	-.704	-.371	3.329	4.162
6	M83A	Z	-.371	-.701	0	.832
7	M83A	Z	-.701	-.877	.832	1.665
8	M83A	Z	-.877	-.739	1.665	2.497
9	M83A	Z	-.739	-.453	2.497	3.329
10	M83A	Z	-.453	-.178	3.329	4.162
11	M51B	Z	-.178	-.453	0	.832
12	M51B	Z	-.453	-.739	.832	1.665
13	M51B	Z	-.739	-.877	1.665	2.497

Member Distributed Loads (BLC 90 : BLC 85 Transient Area Loads) (Continued)

	Member Label	Direction	Start Magnitude[lb/ft.F,ksf]	End Magnitude[lb/ft.F,ksf]	Start Location[f..	End Location[ft..
14	M51B	Z	- .877	- .701	2.497	3.329
15	M51B	Z	- .701	- .371	3.329	4.162
16	M52B	Z	- .371	- .704	0	.832
17	M52B	Z	- .704	- .885	.832	1.665
18	M52B	Z	- .885	- .755	1.665	2.497
19	M52B	Z	- .755	- .474	2.497	3.329
20	M52B	Z	- .474	- .202	3.329	4.162
21	M58A	Z	- .178	- .453	0	.832
22	M58A	Z	- .453	- .739	.832	1.665
23	M58A	Z	- .739	- .877	1.665	2.497
24	M58A	Z	- .877	- .701	2.497	3.329
25	M58A	Z	- .701	- .371	3.329	4.162
26	M59A	Z	- .371	- .704	0	.832
27	M59A	Z	- .704	- .885	.832	1.665
28	M59A	Z	- .885	- .755	1.665	2.497
29	M59A	Z	- .755	- .474	2.497	3.329
30	M59A	Z	- .474	- .202	3.329	4.162

Member Distributed Loads (BLC 91 : BLC 86 Transient Area Loads)

	Member Label	Direction	Start Magnitude[lb/ft.F,ksf]	End Magnitude[lb/ft.F,ksf]	Start Location[f..	End Location[ft..
1	M82	X	.202	.474	0	.832
2	M82	X	.474	.755	.832	1.665
3	M82	X	.755	.885	1.665	2.497
4	M82	X	.885	.704	2.497	3.329
5	M82	X	.704	.371	3.329	4.162
6	M83A	X	.371	.701	0	.832
7	M83A	X	.701	.877	.832	1.665
8	M83A	X	.877	.739	1.665	2.497
9	M83A	X	.739	.453	2.497	3.329
10	M83A	X	.453	.178	3.329	4.162
11	M51B	X	.178	.453	0	.832
12	M51B	X	.453	.739	.832	1.665
13	M51B	X	.739	.877	1.665	2.497
14	M51B	X	.877	.701	2.497	3.329
15	M51B	X	.701	.371	3.329	4.162
16	M52B	X	.371	.704	0	.832
17	M52B	X	.704	.885	.832	1.665
18	M52B	X	.885	.755	1.665	2.497
19	M52B	X	.755	.474	2.497	3.329
20	M52B	X	.474	.202	3.329	4.162
21	M58A	X	.178	.453	0	.832
22	M58A	X	.453	.739	.832	1.665
23	M58A	X	.739	.877	1.665	2.497
24	M58A	X	.877	.701	2.497	3.329
25	M58A	X	.701	.371	3.329	4.162
26	M59A	X	.371	.704	0	.832
27	M59A	X	.704	.885	.832	1.665
28	M59A	X	.885	.755	1.665	2.497
29	M59A	X	.755	.474	2.497	3.329
30	M59A	X	.474	.202	3.329	4.162

Member Area Loads (BLC 39 : Structure D)

	Joint A	Joint B	Joint C	Joint D	Direction	Distribution	Magnitude[ksf]
1	N118	N117	N139	N141	Y	Two Way	-.005
2	N6	N7	N87B	N87C	Y	Two Way	-.005



Company :
 Designer :
 Job Number :
 Model Name :

July 6, 2023
 1:03 PM
 Checked By: _____

Member Area Loads (BLC 39 : Structure D) (Continued)

	Joint A	Joint B	Joint C	Joint D	Direction	Distribution	Magnitude[ksf]
3	N89	N90	N113	N111	Y	Two Way	-.005

Member Area Loads (BLC 40 : Structure Di)

	Joint A	Joint B	Joint C	Joint D	Direction	Distribution	Magnitude[ksf]
1	N118	N117	N139	N141	Y	Two Way	-.011
2	N6	N7	N87B	N87C	Y	Two Way	-.011
3	N89	N90	N113	N111	Y	Two Way	-.011

Member Area Loads (BLC 84 : Structure Ev)

	Joint A	Joint B	Joint C	Joint D	Direction	Distribution	Magnitude[ksf]
1	N118	N117	N139	N141	Y	Two Way	-.000223
2	N6	N7	N87B	N87C	Y	Two Way	-.000223
3	N89	N90	N113	N111	Y	Two Way	-.000223

Member Area Loads (BLC 85 : Structure Eh (0 Deg))

	Joint A	Joint B	Joint C	Joint D	Direction	Distribution	Magnitude[ksf]
1	N118	N117	N139	N141	Z	Two Way	-.000557
2	N6	N7	N87B	N87C	Z	Two Way	-.000557
3	N89	N90	N113	N111	Z	Two Way	-.000557

Member Area Loads (BLC 86 : Structure Eh (90 Deg))

	Joint A	Joint B	Joint C	Joint D	Direction	Distribution	Magnitude[ksf]
1	N118	N117	N139	N141	X	Two Way	.000557
2	N6	N7	N87B	N87C	X	Two Way	.000557
3	N89	N90	N113	N111	X	Two Way	.000557

Envelope Joint Reactions

Joint		X [lb]	LC	Y [lb]	LC	Z [lb]	LC	MX [k-ft]	LC	MY [k-ft]	LC	MZ [k-ft]	LC	
1	N3	max	512.383	10	2473.69	13	1979.395	1	5.454	13	1.055	4	.153	2
2		min	-536.973	4	68.341	7	-2160.549	7	-1.167	7	-1.09	10	-.392	8
3	N87D	max	1618.681	9	2436.438	21	1044.514	3	.222	3	1.108	12	1.059	3
4		min	-1761.502	3	110.728	3	-930.162	9	-2.834	33	-1.139	6	-4.499	21
5	N115	max	1838.107	11	2473.703	17	1041.256	11	.831	11	1.028	8	4.806	17
6		min	-1671.218	5	97.624	11	-974.303	5	-2.69	5	-1.062	2	-.754	11
7	Totals:	max	3580.399	10	6585.594	13	3758.635	1						
8		min	-3580.392	4	2212.11	70	-3758.636	7						

Envelope AISC 15th(360-16): LRFD Steel Code Checks

Member	Shape	Code Check	L...	LC	Shear Check	Loc[ft]	Dir	LC	phi*Pn...	phi*Pnt...	phi*Mn...	phi*Mn...Cb	Eqn	
1	M1	PIPE 3.0	.169	4...	19	.075	4.948	6	28250...	65205	5.749	5.749	2...H1-1b	
2	M4	HSS4X4X4	.344	0	1	.080	0	y	23	124657...	139518	16.181	16.181	2...H1-1b
3	M10	HSS4X4X4	.172	2...	13	.046	2.375	y	13	136263...	139518	16.181	16.181	1...H1-1b
4	MP3A	PIPE 2.0	.329	4...	5	.071	1.938	3	20866...	32130	1.872	1.872	1...H1-1b	
5	MP4A	PIPE 2.5	.206	5...	5	.091	2.552	7	33961...	50715	3.596	3.596	1...H1-1b	
6	MP2A	PIPE 2.0	.367	4...	4	.083	4.5	9	20866...	32130	1.872	1.872	1...H1-1b	
7	MP1A	PIPE 2.0	.414	4...	9	.104	4.5	8	20866...	32130	1.872	1.872	1...H1-1b	
8	M43	HSS4X4X4	.162	0	24	.057	0	y	24	136263...	139518	16.181	16.181	1...H1-1b
9	M46	PL1/2x6	.195	2	.139	.516	y	3	66009...	97200	1.012	12.15	1...H1-1b
10	M51B	L2x2x3	.128	0	2	.013	0	y	16	9823.1...	23392.8	.558	1.086	1...H2-1
11	M52B	L2x2x3	.122	0	1	.011	0	y	21	9823.1...	23392.8	.558	1.077	1...H2-1
12	M76	PL3/8x6	.204	0	2	.308	0	y	18	70647...	72900	.57	9.113	1...H1-1b
13	M77	PL3/8x6	.217	7	.335	0	y	13	71583...	72900	.57	9.113	1...H1-1b

Envelope AISC 15th(360-16): LRFD Steel Code Checks (Continued)

Member	Shape	Code Check	L...	LC	Shear Check	Loc[ft]	Dir	LC	phi*Pn...	phi*Pnt...	phi*Mn...	phi*Mn...	Cb	Eqn
14	M80	PL1/2x6	.065	1	.101	.112	y	5	96757....	97200	1.012	12.15	1...H1-1b
15	M84	PL3/8x6	.151	0	1	.163	0	y	9	70647....	72900	.57	9.113	1...H1-1b
16	M85	PL3/8x6	.212	7	.338	0	y	24	71583....	72900	.57	9.113	1...H1-1b
17	M91	PL1/2x6	.061	1	.141	0	y	3	96757....	97200	1.012	12.15	1...H1-1b
18	M52A	HSS4X4X4	.330	0	21	.090	0	y	31	124657....	139518	16.181	16.181	2...H1-1b
19	M53	HSS4X4X4	.170	2...	21	.046	2.375	y	21	136263....	139518	16.181	16.181	1...H1-1b
20	M54	HSS4X4X4	.161	0	20	.057	0	y	20	136263....	139518	16.181	16.181	1...H1-1b
21	M55	PL1/2x6	.191	10	.141	.516	y	12	66009....	97200	1.012	12.15	1...H1-1b
22	M58A	L2x2x3	.124	0	10	.013	0	y	24	9823.1...	23392.8	.558	1.086	1...H2-1
23	M59A	L2x2x3	.116	4...	7	.011	0	y	17	9823.1...	23392.8	.558	1.116	1...H2-1
24	M63	PL3/8x6	.204	0	10	.306	0	y	14	70647....	72900	.57	9.113	1...H1-1b
25	M64	PL3/8x6	.206	3	.330	0	y	21	71583....	72900	.57	9.113	1...H1-1b
26	M66	PL1/2x6	.062	9	.104	.112	y	1	96757....	97200	1.012	12.15	1...H1-1b
27	M68	PL3/8x6	.140	0	8	.166	0	y	5	70647....	72900	.57	9.113	1...H1-1b
28	M69	PL3/8x6	.199	3	.338	0	y	19	71583....	72900	.57	9.113	1...H1-1b
29	M71	PL1/2x6	.057	9	.143	0	y	11	96757....	97200	1.012	12.15	1...H1-1b
30	M76A	HSS4X4X4	.338	0	17	.081	0	y	15	124657....	139518	16.181	16.181	2...H1-1b
31	M77A	HSS4X4X4	.172	2...	18	.046	2.375	y	17	136263....	139518	16.181	16.181	1...H1-1b
32	M78	HSS4X4X4	.163	0	16	.057	0	y	16	136263....	139518	16.181	16.181	1...H1-1b
33	M79A	PL1/2x6	.200	6	.142	.516	y	7	66009....	97200	1.012	12.15	1...H1-1b
34	M82	L2x2x3	.129	0	6	.013	0	y	20	9823.1...	23392.8	.558	1.085	1...H2-1
35	M83A	L2x2x3	.119	0	5	.011	0	y	13	9823.1...	23392.8	.558	1.078	1...H2-1
36	M87	PL3/8x6	.213	0	6	.306	0	y	22	70647....	72900	.57	9.113	1...H1-1b
37	M88A	PL3/8x6	.213	11	.333	0	y	17	71583....	72900	.57	9.113	1...H1-1b
38	M90	PL1/2x6	.064	5	.099	.112	y	8	96757....	97200	1.012	12.15	1...H1-1b
39	M92A	PL3/8x6	.143	0	5	.169	0	y	1	70647....	72900	.57	9.113	1...H1-1b
40	M93	PL3/8x6	.205	11	.341	0	y	15	71583....	72900	.57	9.113	1...H1-1b
41	M95	PL1/2x6	.059	5	.146	0	y	7	96757....	97200	1.012	12.15	1...H1-1b
42	M82A	PIPE 3.0	.170	4...	15	.071	4.948		2	28250....	65205	5.749	5.749	2...H1-1b
43	M91B	PIPE 3.0	.168	4...	23	.069	4.948		10	28250....	65205	5.749	5.749	2...H1-1b
44	MP3C	PIPE 2.0	.335	4...	12	.071	1.938		11	20866....	32130	1.872	1.872	1...H1-1b
45	MP4C	PIPE 2.5	.211	5...	1	.087	2.552		3	33961....	50715	3.596	3.596	1...H1-1b
46	MP2C	PIPE 2.0	.387	4...	6	.087	4.5		6	20866....	32130	1.872	1.872	1...H1-1b
47	MP1C	PIPE 2.0	.424	4...	5	.103	4.5		4	20866....	32130	1.872	1.872	1...H1-1b
48	MP3B	PIPE 2.0	.328	4...	8	.075	1.938		7	20866....	32130	1.872	1.872	1...H1-1b
49	MP4B	PIPE 2.5	.202	5...	9	.086	2.552		11	33961....	50715	3.596	3.596	1...H1-1b
50	MP2B	PIPE 2.0	.388	4...	1	.088	4.5		1	20866....	32130	1.872	1.872	1...H1-1b
51	MP1B	PIPE 2.0	.433	4...	1	.109	4.5		12	20866....	32130	1.872	1.872	1...H1-1b
52	M100	PIPE 2.5	.212	1...	5	.067	2.214		12	14558....	50715	3.596	3.596	2...H1-1b
53	M105	PIPE 2.5	.213	1...	1	.064	10.2...		11	14558....	50715	3.596	3.596	2...H1-1b
54	M106	PIPE 2.5	.204	2...	1	.068	10.2...		7	14558....	50715	3.596	3.596	1...H1-1b
55	M121	L3X3X4	.388	0	6	.044	0	y	12	41767....	46656	1.688	3.756	2...H2-1
56	M122	L3X3X4	.368	0	10	.042	0	y	4	41767....	46656	1.688	3.756	2...H2-1
57	M123	L3X3X4	.374	0	2	.043	.186	y	8	41767....	46656	1.688	3.756	2...H2-1

I. Mount-to-Tower Connection Check

Custom Orientation Required

Tower Connection Bolt Checks

Bolt Orientation

Bolt Quantity per Reaction:	4
d_x (in) (Delta X of typ. bolt config. sketch) :	6
d_y (in) (Delta Y of typ. bolt config. sketch) :	6
Bolt Type:	A325N
Bolt Diameter (in):	0.625
Required Tensile Strength / bolt (kips):	5.9
Required Shear Strength / bolt (kips):	0.6
Tensile Capacity / bolt (kips):	20.7
Shear Capacity / bolt (kips):	12.4
Bolt Overall Utilization:	28.7%

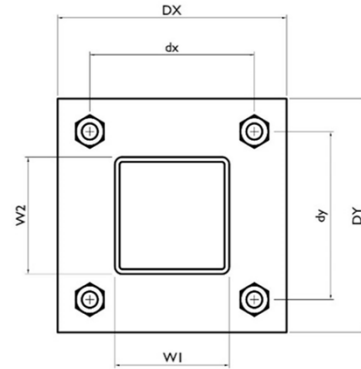

Tower Connection Baseplate Checks

Connecting Standoff Member Shape:	Rect Tube
Weld Stiffener Configuration:	No Stiffeners
Plate Width, D_x (in):	8
Plate Height, D_y (in):	8
W_1 (in):	4
W_2 (in):	4
Member Thickness (in):	0.25
Stiffener location a_1 (in):	
Stiffener location b_1 (in):	
Stiffener location a_2 (in):	
Stiffener location b_2 (in):	
F_y (ksi, plate):	36
Plate Thickness (in):	0.625
Length of Yield Line, L_y (in):	5.85
Bolt Eccentricity, e (in):	1.65
M_u (kip-in):	9.80
$\Phi * M_n$ (kip-in):	18.51
Plate Bending Utilization:	52.9%

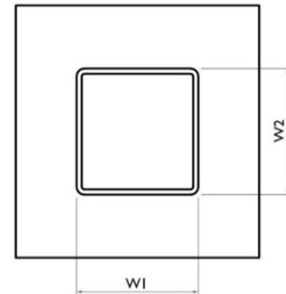

Tower Connection Weld Checks

Weld Shape:
 Weld Stiffener Configuration:
 Stiffener Notch Length, n (in):
 Weld Size (1/16 in):
 W1 (in):
 W2 (in):
 Weld Total Length (in):
 Z_x (in³/in):
 Z_y (in³/in):
 J_p (in⁴/in):
 c_x (in)
 c_y (in)
 Required combined strength (kip/in):
 Weld Capacity (kip/in):
 Weld Utilization:

Yes
Rectangle
None
5
4
4
16.00
21.33
21.33
85.33
2.25
2.25
2.13
6.96
30.6%

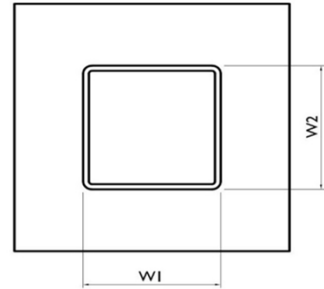

Date: **August 03, 2023**



Crown Castle
2000 Corporate Drive
Canonsburg, PA 15317
(724) 416-2000

Subject: **Structural Analysis Report**

Carrier Designation: **Verizon Wireless Co-Locate**
Site Number: 5000386426
Site Name: BRANFORD_4_CT - A

Crown Castle Designation: **BU Number:** 822765
Site Name: Branford/ I-95/ X55/ Dtn1
JDE Job Number: 751339
Work Order Number: 2246887
Order Number: 654626 Rev. 0

Engineering Firm Designation: **Crown Castle Project Number:** 2246887

Site Data: **10 Sylvia St., Branford, New Haven County, CT**
Latitude 41° 17' 38.16", Longitude -72° 47' 8.54"
125 Foot - Monopole Tower

Crown Castle is pleased to submit this “**Structural Analysis Report**” to determine the structural integrity of the above-mentioned tower.

The purpose of the analysis is to determine acceptability of the tower stress level. Based on our analysis we have determined the tower stress level for the structure and foundation, under the following load case, to be:

LC7: Proposed Equipment Configuration

Sufficient Capacity – 85.6%

This analysis has been performed in accordance with the 2022 Connecticut State Building Code based upon an ultimate 3-second gust wind speed of 122 mph. Applicable Standard references and design criteria are listed in Section 2 - "Analysis Criteria".

Structural analysis prepared by: Steven Hu

Respectfully submitted by:

Maham Barimani, P.E.
Senior Project Engineer

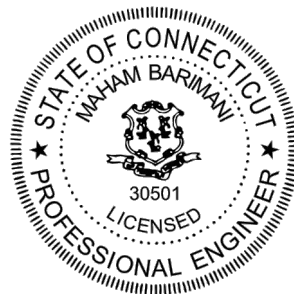

TABLE OF CONTENTS

1) INTRODUCTION

2) ANALYSIS CRITERIA

Table 1 - Proposed Equipment Configuration

Table 2 - Other Considered Equipment

3) ANALYSIS PROCEDURE

Table 3 - Documents Provided

3.1) Analysis Method

3.2) Assumptions

4) ANALYSIS RESULTS

Table 4 - Section Capacity (Summary)

Table 5 - Tower Component Stresses vs. Capacity - LC7

4.1) Recommendations

5) APPENDIX A

tnxTower Output

6) APPENDIX B

Base Level Drawing

7) APPENDIX C

Additional Calculations

1) INTRODUCTION

This tower is a 125 ft Monopole tower designed by Pirod Manufactures Inc. The tower has been modified to accommodate additional loading.

2) ANALYSIS CRITERIA

TIA-222 Revision:	TIA-222-H
Risk Category:	II
Wind Speed:	122 mph
Exposure Category:	B
Topographic Factor:	1
Ice Thickness:	1 in
Wind Speed with Ice:	50 mph
Service Wind Speed:	60 mph

Table 1 - Proposed Equipment Configuration

Mounting Level (ft)	Center Line Elevation (ft)	Number of Antennas	Antenna Manufacturer	Antenna Model	Number of Feed Lines	Feed Line Size (in)
112.0	113.0	3	andrew	HBXX-6517DS-A2M w/ Mount Pipe	2	1-5/8
		6	jma wireless	MX06FRO660-03 w/ Mount Pipe		
		2	raycap	RxxDC-3315-PF-48		
	112.0	3	kaelus	BSF0020F3V1		
		3	samsung telecommunications	MT6407-77A w/ Mount Pipe		
		3	samsung telecommunications	RFV01U-D1A		
		3	samsung telecommunications	RFV01U-D2A		
1	tower mounts	Platform Mount [LP 303-1_HR-1]				

Table 2 - Other Considered Equipment

Mounting Level (ft)	Center Line Elevation (ft)	Number of Antennas	Antenna Manufacturer	Antenna Model	Number of Feed Lines	Feed Line Size (in)
121.0	124.0	3	ericsson	RADIO 4460 B2/B25 B66_TMO	3	1-5/8
	122.0	3	commscope	VV-65A-R1_TMO w/ Mount Pipe		
		3	ericsson	AIR6449 B41_T-MOBILE w/ Mount Pipe		
		3	ericsson	RADIO 4449 B71/B85A		
	3	rfs celwave	APXVAALL24_43-U-NA20 w/ Mount Pipe			
121.0	1	tower mounts	Platform Mount [LP 405-1_HR-1]			
100.0	102.0	3	ericsson	AIR 6419 B77G_CCIV3 w/ Mount Pipe	3	3/8
	100.0	2	cci antennas	TPA65R-BU4D w/ Mount Pipe	6	13/16
		1	cci antennas	TPA65R-BU6DA-K w/ Mount Pipe	6	1-1/4

Mounting Level (ft)	Center Line Elevation (ft)	Number of Antennas	Antenna Manufacturer	Antenna Model	Number of Feed Lines	Feed Line Size (in)
		3	ericsson	RRUS 32 B30		
		3	ericsson	RRUS 4449 B5/B12		
		3	ericsson	RRUS 4478 B14_CCIV2		
		3	ericsson	RRUS 8843 B2/B66A		
		2	kathrein	80010964 w/ Mount Pipe		
		1	kathrein	80010965 w/ Mount Pipe		
		3	raycap	DC6-48-60-18-8F		
		1	tower mounts	Side Arm Mount [SO 102-3]		
		1	tower mounts	T-Arm Mount [TA 602-3_KCKR]		
	98.0	3	ericsson	AIR 6449 B77D_CCVI2 w/ Mount Pipe		
90.0	90.0	3	alcatel lucent	PCS 1900MHZ 4X45W-65MHZ	3 4	1/4 1-1/4
		6	alcatel lucent	RRH2X50-800		
		3	commscope	NNVV-65B-R4 w/ Mount Pipe		
		3	dragonwave	AIRPAIR ODU		
		3	nokia	FZHN		
		3	rfs celwave	APXVTM14-ALU-I20 w/ Mount Pipe		
		1	tower mounts	Platform Mount [LP 303-1_KCKR-HR-1]		
	88.0	2		A-ANT-18G-2-C		
79.0	81.0	3	fujitsu	TA08025-B604	1	1-1/2
		3	fujitsu	TA08025-B605		
		3	jma wireless	MX08FRO665-21 w/ Mount Pipe		
		1	raycap	RDIDC-9181-PF-48		
		79.0	1	tower mounts		

3) ANALYSIS PROCEDURE

Table 3 - Documents Provided

Document	Reference	Source
4-GEOTECHNICAL REPORTS	3552247	CCISITES
4-POST-MODIFICATION INSPECTION	6215120	CCISITES
4-POST-MODIFICATION INSPECTION	5937826	CCISITES
4-TOWER FOUNDATION DRAWINGS/DESIGN/SPECS	3910040	CCISITES
4-TOWER MANUFACTURER DRAWINGS	3552248	CCISITES
4-TOWER REINFORCEMENT DESIGN/DRAWINGS/DATA	5952282	CCISITES

3.1) Analysis Method

tnxTower (version 8.1.4.0), a commercially available analysis software package, was used to create a three-dimensional model of the tower and calculate member stresses for various loading cases. Selected output from the analysis is included in Appendix A. When applicable, Crown Castle has

calculated and provided the effective area for panel antennas using approved methods following the intent of the TIA-222 standard.

tnxTower was used to determine the loads on the modified structure. Additional calculations were performed to determine the stresses in the reinforcing elements. These calculations are presented in Appendix C.

3.2) Assumptions

- 1) Tower and structures were maintained in accordance with the TIA-222 Standard.
- 2) The configuration of antennas, transmission cables, mounts and other appurtenances are as specified in Tables 1 and 2 and the referenced drawings.

This analysis may be affected if any assumptions are not valid or have been made in error. Crown Castle should be notified to determine the effect on the structural integrity of the tower.

4) ANALYSIS RESULTS

Table 4 - Section Capacity (Summary)

Elevation (ft)	Component Type	Size	Critical Element	% Capacity	Pass / Fail
125 - 120	Pole	TP24x24x0.375	Pole	1.5%	Pass
120 - 115	Pole	TP24x24x0.375	Pole	4.3%	Pass
115 - 110	Pole	TP24x24x0.375	Pole	9.2%	Pass
110 - 105	Pole	TP24x24x0.375	Pole	15.1%	Pass
105 - 100	Pole	TP24x24x0.375	Pole	21.3%	Pass
100 - 95	Pole	TP30x30x0.375	Pole	20.9%	Pass
95 - 90	Pole	TP30x30x0.375	Pole	27.4%	Pass
90 - 85	Pole	TP30x30x0.375	Pole	35.8%	Pass
85 - 80	Pole	TP30x30x0.375	Pole	44.1%	Pass
80 - 75.7	Pole	TP36x36x0.375	Pole	37.5%	Pass
75.7 - 75.45	Pole + Reinf.	TP36x36x0.5625	Reinf. 4 Compression	29.7%	Pass
75.45 - 70.45	Pole + Reinf.	TP36x36x0.5625	Reinf. 4 Compression	35.1%	Pass
70.45 - 65.45	Pole + Reinf.	TP36x36x0.5625	Reinf. 4 Compression	40.7%	Pass
65.45 - 60.45	Pole + Reinf.	TP36x36x0.5625	Reinf. 4 Compression	46.5%	Pass
60.45 - 60	Pole + Reinf.	TP36x36x0.5625	Reinf. 4 Compression	47.0%	Pass
60 - 59.75	Pole + Reinf.	TP42x42x0.525	Pole	32.2%	Pass
59.75 - 54.75	Pole + Reinf.	TP42x42x0.525	Pole	36.2%	Pass
54.75 - 49.75	Pole + Reinf.	TP42x42x0.525	Pole	40.3%	Pass
49.75 - 44.75	Pole + Reinf.	TP42x42x0.525	Pole	44.5%	Pass
44.75 - 40	Pole + Reinf.	TP42x42x0.525	Pole	48.5%	Pass
40 - 39.75	Pole + Reinf.	TP48x48x0.5563	Pole	35.9%	Pass
39.75 - 34.75	Pole + Reinf.	TP48x48x0.5563	Pole	39.1%	Pass
34.75 - 29.75	Pole + Reinf.	TP48x48x0.5563	Pole	42.2%	Pass
29.75 - 24.75	Pole + Reinf.	TP48x48x0.5563	Pole	45.4%	Pass

24.75 - 20	Pole + Reinf.	TP48x48x0.5563	Pole	48.5%	Pass
20 - 19.75	Pole + Reinf.	TP54x54x0.5875	Pole	37.2%	Pass
19.75 - 14.75	Pole + Reinf.	TP54x54x0.5875	Pole	39.7%	Pass
14.75 - 9.75	Pole + Reinf.	TP54x54x0.5875	Pole	42.2%	Pass
9.75 - 4.75	Pole + Reinf.	TP54x54x0.5875	Pole	44.8%	Pass
4.75 - 4.38	Pole + Reinf.	TP54x54x0.5875	Pole	45.0%	Pass
4.38 - 4.13	Pole + Reinf.	TP54x54x0.4875	Pole	56.4%	Pass
4.13 - 0	Pole + Reinf.	TP54x54x0.4875	Pole	59.1%	Pass
				Summary	
			Pole	59.1%	Pass
			Reinforcement	47.0%	Pass
			Overall	59.1%	Pass

Table 5 - Tower Component Stresses vs. Capacity - LC7

Notes	Component	Elevation (ft)	% Capacity	Pass / Fail
1	Flange Bolts	100	19.6	Pass
1,2	Flange Plate		21.3	Pass
1	Flange Bolts	80	19.0	Pass
1	Flange Plate		36.4	Pass
1	Bridge Stiffener		47.9	Pass
1	Flange Bolts	60	25.3	Pass
1	Flange Plate		45.8	Pass
1	Bridge Stiffener		61.8	Pass
1	Flange Bolts	40	30.9	Pass
1	Flange Plate		55.0	Pass
1	Bridge Stiffener		73.7	Pass
1	Flange Bolts	20	26.2	Pass
1	Flange Plate		47.8	Pass
1	Bridge Stiffener		57.0	Pass
1	Anchor Rods	0	44.9	Pass
1	Base Plate		85.6	Pass
1	Base Foundation (Structure)		65.0	Pass
1	Base Foundation (Soil Interaction)		50.4	Pass

Structure Rating (max from all components) =	85.6%
---	--------------

Notes:

- 1) See additional documentation in "Appendix C – Additional Calculations" for calculations supporting the % capacity consumed.
- 2) Flange plates are assumed to have the same capacity as their respective shaft.

4.1) Recommendations

The tower and its foundation have sufficient capacity to carry the proposed load configuration. No modifications are required at this time.

APPENDIX A
TNXTOWER OUTPUT

Section	1	2	3	4	5	6	7	8	9	10	11	12	13	14	15	17	18	19	20	21	22	23	24	25	26	27	28	29	30	32
Size																														
Length (ft)																														
Grade																														
Weight (K)																														

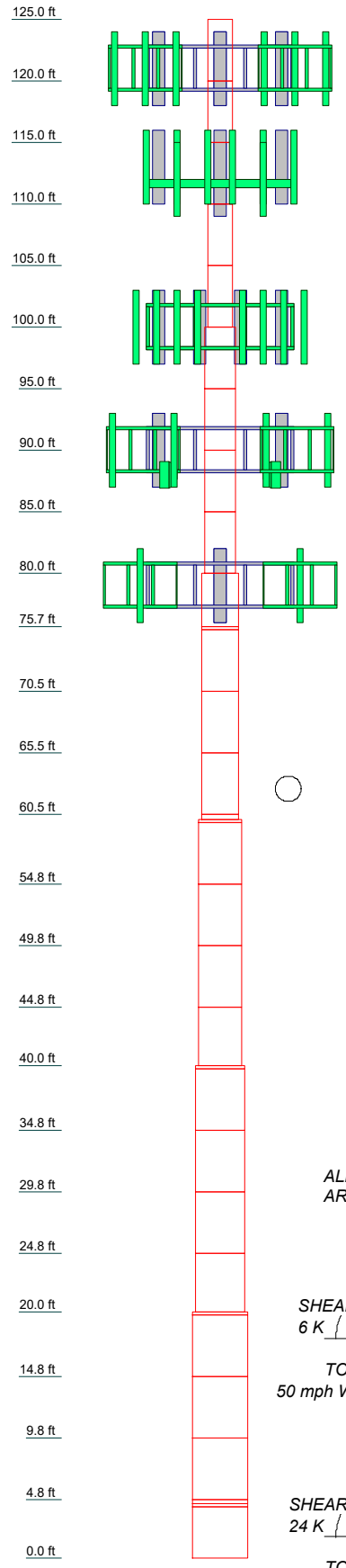

MATERIAL STRENGTH

GRADE	Fy	Fu	GRADE	Fy	Fu
A53-B-42	42 ksi	63 ksi			

TOWER DESIGN NOTES

1. Tower designed for Exposure B to the TIA-222-H Standard.
2. Tower designed for a 122 mph basic wind in accordance with the TIA-222-H Standard.
3. Tower is also designed for a 50 mph basic wind with 1.00 in ice. Ice is considered to increase in thickness with height.
4. Deflections are based upon a 60 mph wind.
5. Tower Risk Category II.
6. Topographic Category 1 with Crest Height of 0.00 ft
7. TOWER RATING: 59.1%

ALL REACTIONS ARE FACTORED

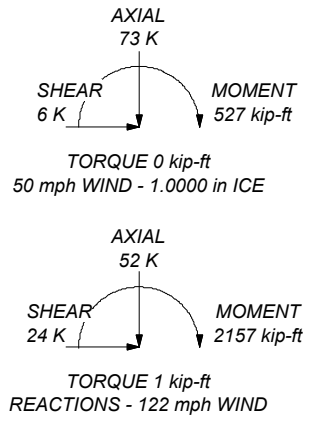

Crown Castle
 2000 Corporate Drive
 Canonsburg, PA 15317
 The Pathway to Possible Phone: (724) 416-2000 FAX:

Job: **BU 822765**
 Project:
 Client: Crown Castle Drawn by: SHu App'd:
 Code: TIA-222-H Date: 08/03/23 Scale: NTS
 Path: C:\Users\shu\Documents\WFH\822765\WO 2246887 - SAIProd\2023065_APP\582521_822765.dwg Dwg No. E-1

Tower Input Data

The tower is a monopole.
 This tower is designed using the TIA-222-H standard.
 The following design criteria apply:

- Tower base elevation above sea level: 56.00 ft.
- Basic wind speed of 122 mph.
- Risk Category II.
- Exposure Category B.
- Simplified Topographic Factor Procedure for wind speed-up calculations is used.
- Topographic Category: 1.
- Crest Height: 0.00 ft.
- Nominal ice thickness of 1.0000 in.
- Ice thickness is considered to increase with height.
- Ice density of 56 pcf.
- A wind speed of 50 mph is used in combination with ice.
- Temperature drop of 50 °F.
- Deflections calculated using a wind speed of 60 mph.
- TOWER RATING: 59.1%.
- A non-linear (P-delta) analysis was used.
- Pressures are calculated at each section.
- Stress ratio used in pole design is 1.
- Tower analysis based on target reliabilities in accordance with Annex S.
- Load Modification Factors used: $K_{es}(F_w) = 0.95$, $K_{es}(t_i) = 0.85$.
- Maximum demand-capacity ratio is: 1.05.
- Local bending stresses due to climbing loads, feed line supports, and appurtenance mounts are not considered.

Options

Consider Moments - Legs Consider Moments - Horizontals Consider Moments - Diagonals Use Moment Magnification ✓ Use Code Stress Ratios ✓ Use Code Safety Factors - Guys Escalate Ice Always Use Max Kz Use Special Wind Profile Include Bolts In Member Capacity Leg Bolts Are At Top Of Section Secondary Horizontal Braces Leg Use Diamond Inner Bracing (4 Sided) SR Members Have Cut Ends SR Members Are Concentric	Distribute Leg Loads As Uniform Assume Legs Pinned ✓ Assume Rigid Index Plate ✓ Use Clear Spans For Wind Area Use Clear Spans For KL/r Retension Guys To Initial Tension ✓ Bypass Mast Stability Checks ✓ Use Azimuth Dish Coefficients ✓ Project Wind Area of Appurt. Autocalc Torque Arm Areas Add IBC .6D+W Combination ✓ Sort Capacity Reports By Component Triangulate Diamond Inner Bracing Treat Feed Line Bundles As Cylinder Ignore KL/ry For 60 Deg. Angle Legs	Use ASCE 10 X-Brace Ly Rules Calculate Forces in Supporting Bracing Members Ignore Redundant Members in FEA SR Leg Bolts Resist Compression All Leg Panels Have Same Allowable Offset Girt At Foundation ✓ Consider Feed Line Torque Include Angle Block Shear Check Use TIA-222-H Bracing Resist. Exemption Use TIA-222-H Tension Splice Exemption <div style="text-align: center; background-color: #e0e0e0; padding: 2px;">Poles</div> ✓ Include Shear-Torsion Interaction Always Use Sub-Critical Flow Use Top Mounted Sockets Pole Without Linear Attachments Pole With Shroud Or No Appurtenances Outside and Inside Corner Radii Are Known
--	---	--

Pole Section Geometry

Section	Elevation ft	Section Length ft	Pole Size	Pole Grade	Socket Length ft
L1	125.00-120.00	5.00	P24x0.375	A53-B-42 (42 ksi)	

Section	Elevation ft	Section Length ft	Pole Size	Pole Grade	Socket Length ft
L2	120.00-115.00	5.00	P24x0.375	A53-B-42 (42 ksi)	
L3	115.00-110.00	5.00	P24x0.375	A53-B-42 (42 ksi)	
L4	110.00-105.00	5.00	P24x0.375	A53-B-42 (42 ksi)	
L5	105.00-100.00	5.00	P24x0.375	A53-B-42 (42 ksi)	
L6	100.00-95.00	5.00	P30x0.375	A53-B-42 (42 ksi)	
L7	95.00-90.00	5.00	P30x0.375	A53-B-42 (42 ksi)	
L8	90.00-85.00	5.00	P30x0.375	A53-B-42 (42 ksi)	
L9	85.00-80.00	5.00	P30x0.375	A53-B-42 (42 ksi)	
L10	80.00-75.70	4.30	P36x0.375	A53-B-42 (42 ksi)	
L11	75.70-75.45	0.25	P36x0.5625	A53-B-42 (42 ksi)	
L12	75.45-70.45	5.00	P36x0.5625	A53-B-42 (42 ksi)	
L13	70.45-65.45	5.00	P36x0.5625	A53-B-42 (42 ksi)	
L14	65.45-60.45	5.00	P36x0.5625	A53-B-42 (42 ksi)	
L15	60.45-60.00	0.45	P36x0.5625	A53-B-42 (42 ksi)	
L16	60.00-59.75	0.25	P42x0.525	A53-B-42 (42 ksi)	
L17	59.75-54.75	5.00	P42x0.525	A53-B-42 (42 ksi)	
L18	54.75-49.75	5.00	P42x0.525	A53-B-42 (42 ksi)	
L19	49.75-44.75	5.00	P42x0.525	A53-B-42 (42 ksi)	
L20	44.75-40.00	4.75	P42x0.525	A53-B-42 (42 ksi)	
L21	40.00-39.75	0.25	P48x0.55625	A53-B-42 (42 ksi)	
L22	39.75-34.75	5.00	P48x0.55625	A53-B-42 (42 ksi)	
L23	34.75-29.75	5.00	P48x0.55625	A53-B-42 (42 ksi)	
L24	29.75-24.75	5.00	P48x0.55625	A53-B-42 (42 ksi)	
L25	24.75-20.00	4.75	P48x0.55625	A53-B-42 (42 ksi)	
L26	20.00-19.75	0.25	P54x0.5875	A53-B-42 (42 ksi)	
L27	19.75-14.75	5.00	P54x0.5875	A53-B-42 (42 ksi)	
L28	14.75-9.75	5.00	P54x0.5875	A53-B-42 (42 ksi)	
L29	9.75-4.75	5.00	P54x0.5875	A53-B-42 (42 ksi)	
L30	4.75-4.38	0.37	P54x0.5875	A53-B-42 (42 ksi)	
L31	4.38-4.13	0.25	P54x0.4875	A53-B-42 (42 ksi)	
L32	4.13-0.00	4.13	P54x0.4875	A53-B-42 (42 ksi)	

Tower Elevation	Gusset Area (per face)	Gusset Thickness	Gusset Grade	Adjust. Factor A_r	Adjust. Factor A_r	Weight Mult.	Double Angle Stitch Bolt Spacing Diagonals in	Double Angle Stitch Bolt Spacing Horizontals in	Double Angle Stitch Bolt Spacing Redundants in
ft	ft ²	in							
L1 125.00-120.00				1	1	1			
L2 120.00-115.00				1	1	1			
L3 115.00-110.00				1	1	1			
L4 110.00-105.00				1	1	1			
L5 105.00-100.00				1	1	1			
L6 100.00-95.00				1	1	1			
L7 95.00-90.00				1	1	1			
L8 90.00-85.00				1	1	1			
L9 85.00-80.00				1	1	1			
L10 80.00-75.70				1	1	1			
L11 75.70-75.45				1	1	0.957627			
L12 75.45-70.45				1	1	0.957627			
L13 70.45-65.45				1	1	0.957627			
L14 65.45-60.45				1	1	0.957627			
L15 60.45-60.00				1	1	0.957627			
L16 60.00-59.75				1	1	0.980003			
L17 59.75-54.75				1	1	0.980003			
L18 54.75-49.75				1	1	0.980003			
L19 49.75-44.75				1	1	0.980003			
L20 44.75-40.00				1	1	0.980003			
L21 40.00-39.75				1	1	0.970732			
L22 39.75-34.75				1	1	0.970732			
L23 34.75-29.75				1	1	0.970732			
L24 29.75-24.75				1	1	0.970732			
L25 24.75-20.00				1	1	0.970732			
L26 20.00-19.75				1	1	0.96417			
L27 19.75-14.75				1	1	0.96417			
L28 14.75-9.75				1	1	0.96417			
L29 9.75-4.75				1	1	0.96417			
L30 4.75-4.38				1	1	0.96417			
L31 4.38-4.13				1	1	1.06826			
L32 4.13-0.00				1	1	1.06826			

Feed Line/Linear Appurtenances - Entered As Round Or Flat

Description	Sector	Exclude From Torque Calculation	Component Type	Placement ft	Total Number	Number Per Row	Start/End Position	Width or Diameter in	Perimeter in	Weight plf
90										
LDF4-50A(1/2)	C	No	Surface Ar (CaAa)	90.00 - 0.00	3	2	0.250 0.250	0.6300		0.15
HB114-1-0813U4-M5J(1-1/4)	C	No	Surface Ar (CaAa)	90.00 - 0.00	4	2	0.250 0.250	1.5400		1.20
Mods										
(Area) CCI-65FP-085125 (H)	A	No	Surface Af (CaAa)	20.50 - 0.00	1	1	0.000 0.000	8.5000	19.5000	0.00
(Area) CCI-65FP-085125 (H)	B	No	Surface Af (CaAa)	20.50 - 0.00	1	1	0.000 0.000	8.5000	19.5000	0.00
(Area) CCI-65FP-085125 (H)	C	No	Surface Af (CaAa)	20.50 - 0.00	1	1	0.000 0.000	8.5000	19.5000	0.00
**										
(Area) CCI-65FP-065125 (H)	A	No	Surface Af (CaAa)	40.50 - 20.50	1	1	0.000 0.000	6.5000	15.5000	0.00
(Area) CCI-65FP-065125 (H)	B	No	Surface Af (CaAa)	40.50 - 20.50	1	1	0.000 0.000	6.5000	15.5000	0.00
(Area) CCI-65FP-065125 (H)	C	No	Surface Af (CaAa)	40.50 - 20.50	1	1	0.000 0.000	6.5000	15.5000	0.00
**										
(Area) CCI-65FP-060100 (H)	A	No	Surface Af (CaAa)	75.50 - 40.50	1	1	0.000 0.000	6.0000	14.0000	0.00
(Area) CCI-65FP-060100 (H)	B	No	Surface Af (CaAa)	75.50 - 40.50	1	1	0.000 0.000	6.0000	14.0000	0.00
(Area) CCI-65FP-060100 (H)	C	No	Surface Af (CaAa)	75.50 - 40.50	1	1	0.000 0.000	6.0000	14.0000	0.00
**										
Bridge Stiffener 78"x4.5"x1"	A	No	Surface Af (CaAa)	83.92 - 77.48	1	1	0.000 0.000	4.5000	11.0000	0.00
Bridge Stiffener 78"x4.5"x1"	B	No	Surface Af (CaAa)	83.92 - 77.48	1	1	0.000 0.000	4.5000	11.0000	0.00
Bridge Stiffener 78"x4.5"x1"	C	No	Surface Af (CaAa)	83.92 - 77.48	1	1	0.000 0.000	4.5000	11.0000	0.00

PWRT-608-S(13/16)	A	No	Surface Ar (CaAa)	100.00 - 0.00	8	8	-0.500 -0.400	0.8200		0.62

Feed Line/Linear Appurtenances - Entered As Area

Description	Face or Leg	Allow Shield	Exclude From Torque Calculation	Component Type	Placement ft	Total Number		CAAA ft ² /ft	Weight plf
122									
HCS 6X12 4AWG(1-5/8)	B	No	No	Inside Pole	121.00 - 0.00	3	No Ice 1/2" Ice 1" Ice	0.00 0.00 0.00	2.40 2.40 2.40
112									
HB158-1-08U8-S8J18(1-5/8)	B	No	No	Inside Pole	112.00 - 0.00	2	No Ice 1/2" Ice 1" Ice	0.00 0.00 0.00	1.30 1.30 1.30
100									
LDF6-50A(1-1/4)	A	No	No	Inside Pole	100.00 - 0.00	6	No Ice 1/2" Ice 1" Ice	0.00 0.00 0.00	0.60 0.60 0.60
FB-L98B-034-XXX(3/8)	A	No	No	Inside Pole	100.00 - 0.00	1	No Ice 1/2" Ice 1" Ice	0.00 0.00 0.00	0.06 0.06 0.06
100266(3/8)	A	No	No	Inside Pole	100.00 - 0.00	1	No Ice 1/2" Ice 1" Ice	0.00 0.00 0.00	0.09 0.09 0.09
2" Flexible Conduit	A	No	No	Inside Pole	100.00 - 0.00	1	No Ice 1/2" Ice	0.00 0.00	0.34 0.34

Description	Face or Leg	Allow Shield	Exclude From Torque Calculation	Component Type	Placement ft	Total Number		C _{AA} ft ² /ft	Weight plf
							1" Ice	0.00	0.34
81 CU12PSM9P8XXX (1-3/8)	A	No	No	Inside Pole	79.00 - 0.00	1	No Ice 1/2" Ice 1" Ice	0.00 0.00 0.00	1.66 1.66 1.66

Feed Line/Linear Appurtenances Section Areas

Tower Section	Tower Elevation ft	Face	A _R ft ²	A _F ft ²	C _{AA} In Face ft ²	C _{AA} Out Face ft ²	Weight K
L1	125.00-120.00	A	0.000	0.000	0.000	0.000	0.00
		B	0.000	0.000	0.000	0.000	0.01
		C	0.000	0.000	0.000	0.000	0.00
L2	120.00-115.00	A	0.000	0.000	0.000	0.000	0.00
		B	0.000	0.000	0.000	0.000	0.04
		C	0.000	0.000	0.000	0.000	0.00
L3	115.00-110.00	A	0.000	0.000	0.000	0.000	0.00
		B	0.000	0.000	0.000	0.000	0.04
		C	0.000	0.000	0.000	0.000	0.00
L4	110.00-105.00	A	0.000	0.000	0.000	0.000	0.00
		B	0.000	0.000	0.000	0.000	0.05
		C	0.000	0.000	0.000	0.000	0.00
L5	105.00-100.00	A	0.000	0.000	0.000	0.000	0.00
		B	0.000	0.000	0.000	0.000	0.05
		C	0.000	0.000	0.000	0.000	0.00
L6	100.00-95.00	A	0.000	0.000	3.280	0.000	0.05
		B	0.000	0.000	0.000	0.000	0.05
		C	0.000	0.000	0.000	0.000	0.00
L7	95.00-90.00	A	0.000	0.000	3.280	0.000	0.05
		B	0.000	0.000	0.000	0.000	0.05
		C	0.000	0.000	0.000	0.000	0.00
L8	90.00-85.00	A	0.000	0.000	3.280	0.000	0.05
		B	0.000	0.000	0.000	0.000	0.05
		C	0.000	0.000	2.170	0.000	0.03
L9	85.00-80.00	A	0.000	0.000	5.816	0.000	0.05
		B	0.000	0.000	2.536	0.000	0.05
		C	0.000	0.000	4.706	0.000	0.03
L10	80.00-75.70	A	0.000	0.000	4.451	0.000	0.04
		B	0.000	0.000	1.631	0.000	0.04
		C	0.000	0.000	3.497	0.000	0.02
L11	75.70-75.45	A	0.000	0.000	0.214	0.000	0.00
		B	0.000	0.000	0.050	0.000	0.00
		C	0.000	0.000	0.159	0.000	0.00
L12	75.45-70.45	A	0.000	0.000	8.280	0.000	0.05
		B	0.000	0.000	5.000	0.000	0.05
		C	0.000	0.000	7.170	0.000	0.03
L13	70.45-65.45	A	0.000	0.000	8.280	0.000	0.05
		B	0.000	0.000	5.000	0.000	0.05
		C	0.000	0.000	7.170	0.000	0.03
L14	65.45-60.45	A	0.000	0.000	8.280	0.000	0.05
		B	0.000	0.000	5.000	0.000	0.05
		C	0.000	0.000	7.170	0.000	0.03
L15	60.45-60.00	A	0.000	0.000	0.745	0.000	0.00
		B	0.000	0.000	0.450	0.000	0.00
		C	0.000	0.000	0.645	0.000	0.00
L16	60.00-59.75	A	0.000	0.000	0.414	0.000	0.00
		B	0.000	0.000	0.250	0.000	0.00
		C	0.000	0.000	0.358	0.000	0.00
L17	59.75-54.75	A	0.000	0.000	8.280	0.000	0.05
		B	0.000	0.000	5.000	0.000	0.05

Tower Section	Tower Elevation ft	Face	A_R	A_F	C_{AA}	C_{AA}	Weight K
			ft ²	ft ²	In Face ft ²	Out Face ft ²	
L18	54.75-49.75	C	0.000	0.000	7.170	0.000	0.03
		A	0.000	0.000	8.280	0.000	0.05
		B	0.000	0.000	5.000	0.000	0.05
L19	49.75-44.75	C	0.000	0.000	7.170	0.000	0.03
		A	0.000	0.000	8.280	0.000	0.05
		B	0.000	0.000	5.000	0.000	0.05
L20	44.75-40.00	C	0.000	0.000	7.170	0.000	0.03
		A	0.000	0.000	7.908	0.000	0.05
		B	0.000	0.000	4.792	0.000	0.05
L21	40.00-39.75	C	0.000	0.000	6.853	0.000	0.02
		A	0.000	0.000	0.435	0.000	0.00
		B	0.000	0.000	0.271	0.000	0.00
L22	39.75-34.75	C	0.000	0.000	0.379	0.000	0.00
		A	0.000	0.000	8.697	0.000	0.05
		B	0.000	0.000	5.417	0.000	0.05
L23	34.75-29.75	C	0.000	0.000	7.587	0.000	0.03
		A	0.000	0.000	8.697	0.000	0.05
		B	0.000	0.000	5.417	0.000	0.05
L24	29.75-24.75	C	0.000	0.000	7.587	0.000	0.03
		A	0.000	0.000	8.697	0.000	0.05
		B	0.000	0.000	5.417	0.000	0.05
L25	24.75-20.00	C	0.000	0.000	7.587	0.000	0.03
		A	0.000	0.000	8.428	0.000	0.05
		B	0.000	0.000	5.313	0.000	0.05
L26	20.00-19.75	C	0.000	0.000	7.374	0.000	0.02
		A	0.000	0.000	0.518	0.000	0.00
		B	0.000	0.000	0.354	0.000	0.00
L27	19.75-14.75	C	0.000	0.000	0.463	0.000	0.00
		A	0.000	0.000	10.363	0.000	0.05
		B	0.000	0.000	7.083	0.000	0.05
L28	14.75-9.75	C	0.000	0.000	9.253	0.000	0.03
		A	0.000	0.000	10.363	0.000	0.05
		B	0.000	0.000	7.083	0.000	0.05
L29	9.75-4.75	C	0.000	0.000	9.253	0.000	0.03
		A	0.000	0.000	10.363	0.000	0.05
		B	0.000	0.000	7.083	0.000	0.05
L30	4.75-4.38	C	0.000	0.000	9.253	0.000	0.03
		A	0.000	0.000	0.767	0.000	0.00
		B	0.000	0.000	0.524	0.000	0.00
L31	4.38-4.13	C	0.000	0.000	0.685	0.000	0.00
		A	0.000	0.000	0.518	0.000	0.00
		B	0.000	0.000	0.354	0.000	0.00
L32	4.13-0.00	C	0.000	0.000	0.463	0.000	0.00
		A	0.000	0.000	8.560	0.000	0.04
		B	0.000	0.000	5.851	0.000	0.04
		C	0.000	0.000	7.643	0.000	0.02

Feed Line/Linear Appurtenances Section Areas - With Ice

Tower Section	Tower Elevation ft	Face or Leg	Ice Thickness in	A_R	A_F	C_{AA}	C_{AA}	Weight K
				ft ²	ft ²	In Face ft ²	Out Face ft ²	
L1	125.00-120.00	A	0.969	0.000	0.000	0.000	0.000	0.00
		B		0.000	0.000	0.000	0.000	0.01
		C		0.000	0.000	0.000	0.000	0.00
L2	120.00-115.00	A	0.965	0.000	0.000	0.000	0.000	0.00
		B		0.000	0.000	0.000	0.000	0.04
		C		0.000	0.000	0.000	0.000	0.00
L3	115.00-110.00	A	0.961	0.000	0.000	0.000	0.000	0.00
		B		0.000	0.000	0.000	0.000	0.04
		C		0.000	0.000	0.000	0.000	0.00
L4	110.00-105.00	A	0.957	0.000	0.000	0.000	0.000	0.00
		B		0.000	0.000	0.000	0.000	0.05
		C		0.000	0.000	0.000	0.000	0.00
L5	105.00-100.00	A	0.952	0.000	0.000	0.000	0.000	0.00
		B		0.000	0.000	0.000	0.000	0.05

Tower Section	Tower Elevation ft	Face or Leg	Ice Thickness in	A _R ft ²	A _F ft ²	C _A A _A In Face ft ²	C _A A _A Out Face ft ²	Weight K
L6	100.00-95.00	C		0.000	0.000	0.000	0.000	0.00
		A	0.947	0.000	0.000	5.284	0.000	0.08
		B		0.000	0.000	0.000	0.000	0.05
L7	95.00-90.00	C		0.000	0.000	0.000	0.000	0.00
		A	0.942	0.000	0.000	5.278	0.000	0.08
		B		0.000	0.000	0.000	0.000	0.05
L8	90.00-85.00	C		0.000	0.000	0.000	0.000	0.00
		A	0.937	0.000	0.000	5.271	0.000	0.08
		B		0.000	0.000	0.000	0.000	0.05
L9	85.00-80.00	C		0.000	0.000	5.055	0.000	0.07
		A	0.932	0.000	0.000	8.195	0.000	0.10
		B		0.000	0.000	2.930	0.000	0.07
L10	80.00-75.70	C		0.000	0.000	7.971	0.000	0.09
		A	0.926	0.000	0.000	6.404	0.000	0.09
		B		0.000	0.000	1.882	0.000	0.06
L11	75.70-75.45	C		0.000	0.000	6.206	0.000	0.07
		A	0.923	0.000	0.000	0.322	0.000	0.00
		B		0.000	0.000	0.059	0.000	0.00
L12	75.45-70.45	C		0.000	0.000	0.310	0.000	0.00
		A	0.920	0.000	0.000	11.170	0.000	0.12
		B		0.000	0.000	5.920	0.000	0.08
L13	70.45-65.45	C		0.000	0.000	10.933	0.000	0.10
		A	0.914	0.000	0.000	11.156	0.000	0.12
		B		0.000	0.000	5.914	0.000	0.08
L14	65.45-60.45	C		0.000	0.000	10.910	0.000	0.10
		A	0.907	0.000	0.000	11.140	0.000	0.12
		B		0.000	0.000	5.907	0.000	0.08
L15	60.45-60.00	C		0.000	0.000	10.886	0.000	0.10
		A	0.903	0.000	0.000	1.002	0.000	0.01
		B		0.000	0.000	0.531	0.000	0.01
L16	60.00-59.75	C		0.000	0.000	0.978	0.000	0.01
		A	0.902	0.000	0.000	0.556	0.000	0.01
		B		0.000	0.000	0.295	0.000	0.00
L17	59.75-54.75	C		0.000	0.000	0.544	0.000	0.00
		A	0.898	0.000	0.000	11.121	0.000	0.12
		B		0.000	0.000	5.898	0.000	0.08
L18	54.75-49.75	C		0.000	0.000	10.856	0.000	0.10
		A	0.890	0.000	0.000	11.102	0.000	0.11
		B		0.000	0.000	5.890	0.000	0.08
L19	49.75-44.75	C		0.000	0.000	10.827	0.000	0.10
		A	0.881	0.000	0.000	11.082	0.000	0.11
		B		0.000	0.000	5.881	0.000	0.08
L20	44.75-40.00	C		0.000	0.000	10.796	0.000	0.09
		A	0.872	0.000	0.000	10.550	0.000	0.11
		B		0.000	0.000	5.620	0.000	0.07
L21	40.00-39.75	C		0.000	0.000	10.266	0.000	0.09
		A	0.866	0.000	0.000	0.573	0.000	0.01
		B		0.000	0.000	0.314	0.000	0.00
L22	39.75-34.75	C		0.000	0.000	0.558	0.000	0.00
		A	0.860	0.000	0.000	11.452	0.000	0.11
		B		0.000	0.000	6.277	0.000	0.08
L23	34.75-29.75	C		0.000	0.000	11.140	0.000	0.10
		A	0.848	0.000	0.000	11.425	0.000	0.11
		B		0.000	0.000	6.265	0.000	0.08
L24	29.75-24.75	C		0.000	0.000	11.097	0.000	0.09
		A	0.834	0.000	0.000	11.393	0.000	0.11
		B		0.000	0.000	6.251	0.000	0.08
L25	24.75-20.00	C		0.000	0.000	11.048	0.000	0.09
		A	0.818	0.000	0.000	10.954	0.000	0.11
		B		0.000	0.000	6.088	0.000	0.08
L26	20.00-19.75	C		0.000	0.000	10.607	0.000	0.09
		A	0.808	0.000	0.000	0.650	0.000	0.01
		B		0.000	0.000	0.394	0.000	0.00
L27	19.75-14.75	C		0.000	0.000	0.631	0.000	0.00
		A	0.797	0.000	0.000	12.966	0.000	0.12
		B		0.000	0.000	7.870	0.000	0.08
L28	14.75-9.75	C		0.000	0.000	12.574	0.000	0.10
		A	0.770	0.000	0.000	12.907	0.000	0.11
		B		0.000	0.000	7.845	0.000	0.08

Tower Section	Tower Elevation ft	Face or Leg	Ice Thickness in	A _R ft ²	A _F ft ²	C _A A _A In Face ft ²	C _A A _A Out Face ft ²	Weight K
L29	9.75-4.75	C	0.730	0.000	0.000	12.482	0.000	0.09
		A		0.000	0.000	12.822	0.000	0.11
		B		0.000	0.000	7.809	0.000	0.08
L30	4.75-4.38	C	0.697	0.000	0.000	12.347	0.000	0.09
		A		0.000	0.000	0.943	0.000	0.01
		B		0.000	0.000	0.576	0.000	0.01
L31	4.38-4.13	C	0.693	0.000	0.000	0.905	0.000	0.01
		A		0.000	0.000	0.637	0.000	0.01
		B		0.000	0.000	0.389	0.000	0.00
L32	4.13-0.00	C	0.644	0.000	0.000	0.611	0.000	0.00
		A		0.000	0.000	10.435	0.000	0.09
		B		0.000	0.000	6.383	0.000	0.06
		C		0.000	0.000	9.954	0.000	0.07

Feed Line Center of Pressure

Section	Elevation ft	CP _x in	CP _z in	CP _x Ice in	CP _z Ice in
L1	125.00-120.00	0.0000	0.0000	0.0000	0.0000
L2	120.00-115.00	0.0000	0.0000	0.0000	0.0000
L3	115.00-110.00	0.0000	0.0000	0.0000	0.0000
L4	110.00-105.00	0.0000	0.0000	0.0000	0.0000
L5	105.00-100.00	0.0000	0.0000	0.0000	0.0000
L6	100.00-95.00	-4.2834	1.9071	-3.2444	1.4445
L7	95.00-90.00	-4.2834	1.9071	-3.2431	1.4439
L8	90.00-85.00	-4.9293	3.9494	-3.6378	3.2834
L9	85.00-80.00	-3.1049	2.4877	-2.8452	2.5668
L10	80.00-75.70	-3.7778	3.0184	-3.3236	2.9893
L11	75.70-75.45	-4.3598	3.4834	-3.5852	3.2239
L12	75.45-70.45	-2.5833	2.0640	-2.6098	2.3461
L13	70.45-65.45	-2.5833	2.0640	-2.6079	2.3432
L14	65.45-60.45	-2.5833	2.0640	-2.6059	2.3400
L15	60.45-60.00	-2.5833	2.0640	-2.6048	2.3382
L16	60.00-59.75	-2.8537	2.2755	-2.8583	2.5608
L17	59.75-54.75	-2.8537	2.2755	-2.8569	2.5587
L18	54.75-49.75	-2.8537	2.2755	-2.8540	2.5543
L19	49.75-44.75	-2.8537	2.2755	-2.8509	2.5496
L20	44.75-40.00	-2.8416	2.2658	-2.8407	2.5383
L21	40.00-39.75	-2.9842	2.3758	-3.0057	2.6808
L22	39.75-34.75	-2.9842	2.3758	-3.0033	2.6772
L23	34.75-29.75	-2.9842	2.3758	-2.9981	2.6696
L24	29.75-24.75	-2.9842	2.3758	-2.9921	2.6609
L25	24.75-20.00	-2.9383	2.3393	-2.9587	2.6273
L26	20.00-19.75	-2.8063	2.2315	-2.9411	2.6065
L27	19.75-14.75	-2.8063	2.2315	-2.9354	2.5987
L28	14.75-9.75	-2.8063	2.2315	-2.9218	2.5801
L29	9.75-4.75	-2.8063	2.2315	-2.9016	2.5526
L30	4.75-4.38	-2.8063	2.2315	-2.8845	2.5293
L31	4.38-4.13	-2.8063	2.2315	-2.8820	2.5258
L32	4.13-0.00	-2.8063	2.2315	-2.8566	2.4912

Note: For pole sections, center of pressure calculations do not consider feed line shielding.

Shielding Factor Ka

Tower Section	Feed Line Record No.	Description	Feed Line Segment Elev.	K _a No Ice	K _a Ice
L6	41	PWRT-608-S(13/16)	95.00 - 100.00	1.0000	1.0000
L7	41	PWRT-608-S(13/16)	90.00 - 95.00	1.0000	1.0000
L8	15	LDF4-50A(1/2)	85.00 - 90.00	1.0000	1.0000
L8	16	HB114-1-0813U4-M5J(1- 1/4)	85.00 - 90.00	1.0000	1.0000
L8	41	PWRT-608-S(13/16)	85.00 - 90.00	1.0000	1.0000
L9	15	LDF4-50A(1/2)	80.00 - 85.00	1.0000	1.0000
L9	16	HB114-1-0813U4-M5J(1- 1/4)	80.00 - 85.00	1.0000	1.0000
L9	36	Bridge Stiffener 78"x4.5"x1"	80.00 - 83.92	1.0000	1.0000
L9	37	Bridge Stiffener 78"x4.5"x1"	80.00 - 83.92	1.0000	1.0000
L9	38	Bridge Stiffener 78"x4.5"x1"	80.00 - 83.92	1.0000	1.0000
L9	41	PWRT-608-S(13/16)	80.00 - 85.00	1.0000	1.0000
L10	15	LDF4-50A(1/2)	75.70 - 80.00	1.0000	1.0000
L10	16	HB114-1-0813U4-M5J(1- 1/4)	75.70 - 80.00	1.0000	1.0000
L10	36	Bridge Stiffener 78"x4.5"x1"	77.48 - 80.00	1.0000	1.0000
L10	37	Bridge Stiffener 78"x4.5"x1"	77.48 - 80.00	1.0000	1.0000
L10	38	Bridge Stiffener 78"x4.5"x1"	77.48 - 80.00	1.0000	1.0000
L10	41	PWRT-608-S(13/16)	75.70 - 80.00	1.0000	1.0000
L11	15	LDF4-50A(1/2)	75.45 - 75.70	1.0000	1.0000
L11	16	HB114-1-0813U4-M5J(1- 1/4)	75.45 - 75.70	1.0000	1.0000
L11	28	(Area) CCI-65FP-060100 (H)	75.45 - 75.50	1.0000	1.0000
L11	29	(Area) CCI-65FP-060100 (H)	75.45 - 75.50	1.0000	1.0000
L11	30	(Area) CCI-65FP-060100 (H)	75.45 - 75.50	1.0000	1.0000
L11	41	PWRT-608-S(13/16)	75.45 - 75.70	1.0000	1.0000
L12	15	LDF4-50A(1/2)	70.45 - 75.45	1.0000	1.0000
L12	16	HB114-1-0813U4-M5J(1- 1/4)	70.45 - 75.45	1.0000	1.0000
L12	28	(Area) CCI-65FP-060100 (H)	70.45 - 75.45	1.0000	1.0000
L12	29	(Area) CCI-65FP-060100 (H)	70.45 - 75.45	1.0000	1.0000
L12	30	(Area) CCI-65FP-060100 (H)	70.45 - 75.45	1.0000	1.0000
L12	41	PWRT-608-S(13/16)	70.45 - 75.45	1.0000	1.0000
L13	15	LDF4-50A(1/2)	65.45 - 70.45	1.0000	1.0000
L13	16	HB114-1-0813U4-M5J(1- 1/4)	65.45 - 70.45	1.0000	1.0000
L13	28	(Area) CCI-65FP-060100 (H)	65.45 - 70.45	1.0000	1.0000
L13	29	(Area) CCI-65FP-060100 (H)	65.45 - 70.45	1.0000	1.0000
L13	30	(Area) CCI-65FP-060100 (H)	65.45 - 70.45	1.0000	1.0000
L13	41	PWRT-608-S(13/16)	65.45 -	1.0000	1.0000

Tower Section	Feed Line Record No.	Description	Feed Line Segment Elev.	K _a No Ice	K _a Ice
L14	15	LDF4-50A(1/2)	70.45 60.45 -	1.0000	1.0000
L14	16	HB114-1-0813U4-M5J(1-1/4)	65.45 60.45 -	1.0000	1.0000
L14	28	(Area) CCI-65FP-060100 (H)	65.45 60.45 -	1.0000	1.0000
L14	29	(Area) CCI-65FP-060100 (H)	65.45 60.45 -	1.0000	1.0000
L14	30	(Area) CCI-65FP-060100 (H)	65.45 60.45 -	1.0000	1.0000
L14	41	PWRT-608-S(13/16)	60.45 - 65.45	1.0000	1.0000
L15	15	LDF4-50A(1/2)	60.00 - 60.45	1.0000	1.0000
L15	16	HB114-1-0813U4-M5J(1-1/4)	60.00 - 60.45	1.0000	1.0000
L15	28	(Area) CCI-65FP-060100 (H)	60.00 - 60.45	1.0000	1.0000
L15	29	(Area) CCI-65FP-060100 (H)	60.00 - 60.45	1.0000	1.0000
L15	30	(Area) CCI-65FP-060100 (H)	60.00 - 60.45	1.0000	1.0000
L15	41	PWRT-608-S(13/16)	60.00 - 60.45	1.0000	1.0000
L16	15	LDF4-50A(1/2)	59.75 - 60.00	1.0000	1.0000
L16	16	HB114-1-0813U4-M5J(1-1/4)	59.75 - 60.00	1.0000	1.0000
L16	28	(Area) CCI-65FP-060100 (H)	59.75 - 60.00	1.0000	1.0000
L16	29	(Area) CCI-65FP-060100 (H)	59.75 - 60.00	1.0000	1.0000
L16	30	(Area) CCI-65FP-060100 (H)	59.75 - 60.00	1.0000	1.0000
L16	41	PWRT-608-S(13/16)	59.75 - 60.00	1.0000	1.0000
L17	15	LDF4-50A(1/2)	54.75 - 59.75	1.0000	1.0000
L17	16	HB114-1-0813U4-M5J(1-1/4)	54.75 - 59.75	1.0000	1.0000
L17	28	(Area) CCI-65FP-060100 (H)	54.75 - 59.75	1.0000	1.0000
L17	29	(Area) CCI-65FP-060100 (H)	54.75 - 59.75	1.0000	1.0000
L17	30	(Area) CCI-65FP-060100 (H)	54.75 - 59.75	1.0000	1.0000
L17	41	PWRT-608-S(13/16)	54.75 - 59.75	1.0000	1.0000
L18	15	LDF4-50A(1/2)	49.75 - 54.75	1.0000	1.0000
L18	16	HB114-1-0813U4-M5J(1-1/4)	49.75 - 54.75	1.0000	1.0000
L18	28	(Area) CCI-65FP-060100 (H)	49.75 - 54.75	1.0000	1.0000
L18	29	(Area) CCI-65FP-060100 (H)	49.75 - 54.75	1.0000	1.0000
L18	30	(Area) CCI-65FP-060100 (H)	49.75 - 54.75	1.0000	1.0000
L18	41	PWRT-608-S(13/16)	49.75 - 54.75	1.0000	1.0000
L19	15	LDF4-50A(1/2)	44.75 - 49.75	1.0000	1.0000
L19	16	HB114-1-0813U4-M5J(1-1/4)	44.75 - 49.75	1.0000	1.0000
L19	28	(Area) CCI-65FP-060100 (H)	44.75 - 49.75	1.0000	1.0000
L19	29	(Area) CCI-65FP-060100 (H)	44.75 - 49.75	1.0000	1.0000

Tower Section	Feed Line Record No.	Description	Feed Line Segment Elev.	K _a No Ice	K _a Ice
L19	30	(Area) CCI-65FP-060100 (H)	44.75 - 49.75	1.0000	1.0000
L19	41	PWRT-608-S(13/16)	44.75 - 49.75	1.0000	1.0000
L20	15	LDF4-50A(1/2)	40.00 - 44.75	1.0000	1.0000
L20	16	HB114-1-0813U4-M5J(1-1/4)	40.00 - 44.75	1.0000	1.0000
L20	24	(Area) CCI-65FP-065125 (H)	40.00 - 40.50	1.0000	1.0000
L20	25	(Area) CCI-65FP-065125 (H)	40.00 - 40.50	1.0000	1.0000
L20	26	(Area) CCI-65FP-065125 (H)	40.00 - 40.50	1.0000	1.0000
L20	28	(Area) CCI-65FP-060100 (H)	40.50 - 44.75	1.0000	1.0000
L20	29	(Area) CCI-65FP-060100 (H)	40.50 - 44.75	1.0000	1.0000
L20	30	(Area) CCI-65FP-060100 (H)	40.50 - 44.75	1.0000	1.0000
L20	41	PWRT-608-S(13/16)	40.00 - 44.75	1.0000	1.0000
L21	15	LDF4-50A(1/2)	39.75 - 40.00	1.0000	1.0000
L21	16	HB114-1-0813U4-M5J(1-1/4)	39.75 - 40.00	1.0000	1.0000
L21	24	(Area) CCI-65FP-065125 (H)	39.75 - 40.00	1.0000	1.0000
L21	25	(Area) CCI-65FP-065125 (H)	39.75 - 40.00	1.0000	1.0000
L21	26	(Area) CCI-65FP-065125 (H)	39.75 - 40.00	1.0000	1.0000
L21	41	PWRT-608-S(13/16)	39.75 - 40.00	1.0000	1.0000
L22	15	LDF4-50A(1/2)	34.75 - 39.75	1.0000	1.0000
L22	16	HB114-1-0813U4-M5J(1-1/4)	34.75 - 39.75	1.0000	1.0000
L22	24	(Area) CCI-65FP-065125 (H)	34.75 - 39.75	1.0000	1.0000
L22	25	(Area) CCI-65FP-065125 (H)	34.75 - 39.75	1.0000	1.0000
L22	26	(Area) CCI-65FP-065125 (H)	34.75 - 39.75	1.0000	1.0000
L22	41	PWRT-608-S(13/16)	34.75 - 39.75	1.0000	1.0000
L23	15	LDF4-50A(1/2)	29.75 - 34.75	1.0000	1.0000
L23	16	HB114-1-0813U4-M5J(1-1/4)	29.75 - 34.75	1.0000	1.0000
L23	24	(Area) CCI-65FP-065125 (H)	29.75 - 34.75	1.0000	1.0000
L23	25	(Area) CCI-65FP-065125 (H)	29.75 - 34.75	1.0000	1.0000
L23	26	(Area) CCI-65FP-065125 (H)	29.75 - 34.75	1.0000	1.0000
L23	41	PWRT-608-S(13/16)	29.75 - 34.75	1.0000	1.0000
L24	15	LDF4-50A(1/2)	24.75 - 29.75	1.0000	1.0000
L24	16	HB114-1-0813U4-M5J(1-1/4)	24.75 - 29.75	1.0000	1.0000
L24	24	(Area) CCI-65FP-065125 (H)	24.75 - 29.75	1.0000	1.0000
L24	25	(Area) CCI-65FP-065125 (H)	24.75 - 29.75	1.0000	1.0000
L24	26	(Area) CCI-65FP-065125 (H)	24.75 - 29.75	1.0000	1.0000
L24	41	PWRT-608-S(13/16)	24.75 -	1.0000	1.0000

Tower Section	Feed Line Record No.	Description	Feed Line Segment Elev.	K _a No Ice	K _a Ice
L25	15	LDF4-50A(1/2)	29.75 20.00 - 24.75	1.0000	1.0000
L25	16	HB114-1-0813U4-M5J(1-1/4)	20.00 - 24.75	1.0000	1.0000
L25	20	(Area) CCI-65FP-085125 (H)	20.00 - 20.50	1.0000	1.0000
L25	21	(Area) CCI-65FP-085125 (H)	20.00 - 20.50	1.0000	1.0000
L25	22	(Area) CCI-65FP-085125 (H)	20.00 - 20.50	1.0000	1.0000
L25	24	(Area) CCI-65FP-065125 (H)	20.50 - 24.75	1.0000	1.0000
L25	25	(Area) CCI-65FP-065125 (H)	20.50 - 24.75	1.0000	1.0000
L25	26	(Area) CCI-65FP-065125 (H)	20.50 - 24.75	1.0000	1.0000
L25	41	PWRT-608-S(13/16)	20.00 - 24.75	1.0000	1.0000
L26	15	LDF4-50A(1/2)	19.75 - 20.00	1.0000	1.0000
L26	16	HB114-1-0813U4-M5J(1-1/4)	19.75 - 20.00	1.0000	1.0000
L26	20	(Area) CCI-65FP-085125 (H)	19.75 - 20.00	1.0000	1.0000
L26	21	(Area) CCI-65FP-085125 (H)	19.75 - 20.00	1.0000	1.0000
L26	22	(Area) CCI-65FP-085125 (H)	19.75 - 20.00	1.0000	1.0000
L26	41	PWRT-608-S(13/16)	19.75 - 20.00	1.0000	1.0000
L27	15	LDF4-50A(1/2)	14.75 - 19.75	1.0000	1.0000
L27	16	HB114-1-0813U4-M5J(1-1/4)	14.75 - 19.75	1.0000	1.0000
L27	20	(Area) CCI-65FP-085125 (H)	14.75 - 19.75	1.0000	1.0000
L27	21	(Area) CCI-65FP-085125 (H)	14.75 - 19.75	1.0000	1.0000
L27	22	(Area) CCI-65FP-085125 (H)	14.75 - 19.75	1.0000	1.0000
L27	41	PWRT-608-S(13/16)	14.75 - 19.75	1.0000	1.0000
L28	15	LDF4-50A(1/2)	9.75 - 14.75	1.0000	1.0000
L28	16	HB114-1-0813U4-M5J(1-1/4)	9.75 - 14.75	1.0000	1.0000
L28	20	(Area) CCI-65FP-085125 (H)	9.75 - 14.75	1.0000	1.0000
L28	21	(Area) CCI-65FP-085125 (H)	9.75 - 14.75	1.0000	1.0000
L28	22	(Area) CCI-65FP-085125 (H)	9.75 - 14.75	1.0000	1.0000
L28	41	PWRT-608-S(13/16)	9.75 - 14.75	1.0000	1.0000
L29	15	LDF4-50A(1/2)	4.75 - 9.75	1.0000	1.0000
L29	16	HB114-1-0813U4-M5J(1-1/4)	4.75 - 9.75	1.0000	1.0000
L29	20	(Area) CCI-65FP-085125 (H)	4.75 - 9.75	1.0000	1.0000
L29	21	(Area) CCI-65FP-085125 (H)	4.75 - 9.75	1.0000	1.0000
L29	22	(Area) CCI-65FP-085125 (H)	4.75 - 9.75	1.0000	1.0000
L29	41	PWRT-608-S(13/16)	4.75 - 9.75	1.0000	1.0000
L30	15	LDF4-50A(1/2)	4.38 - 4.75	1.0000	1.0000
L30	16	HB114-1-0813U4-M5J(1-1/4)	4.38 - 4.75	1.0000	1.0000
L30	20	(Area) CCI-65FP-085125 (H)	4.38 - 4.75	1.0000	1.0000
L30	21	(Area) CCI-65FP-085125 (H)	4.38 - 4.75	1.0000	1.0000

Tower Section	Feed Line Record No.	Description	Feed Line Segment Elev.	K _a No Ice	K _a Ice
L30	22	(H) (Area) CCI-65FP-085125	4.38 - 4.75	1.0000	1.0000
L30	41	(H) PWRT-608-S(13/16)	4.38 - 4.75	1.0000	1.0000
L31	15	LDF4-50A(1/2)	4.13 - 4.38	1.0000	1.0000
L31	16	HB114-1-0813U4-M5J(1-1/4)	4.13 - 4.38	1.0000	1.0000
L31	20	(Area) CCI-65FP-085125	4.13 - 4.38	1.0000	1.0000
L31	21	(H) (Area) CCI-65FP-085125	4.13 - 4.38	1.0000	1.0000
L31	22	(H) (Area) CCI-65FP-085125	4.13 - 4.38	1.0000	1.0000
L31	41	(H) PWRT-608-S(13/16)	4.13 - 4.38	1.0000	1.0000
L32	15	LDF4-50A(1/2)	0.00 - 4.13	1.0000	1.0000
L32	16	HB114-1-0813U4-M5J(1-1/4)	0.00 - 4.13	1.0000	1.0000
L32	20	(Area) CCI-65FP-085125	0.00 - 4.13	1.0000	1.0000
L32	21	(H) (Area) CCI-65FP-085125	0.00 - 4.13	1.0000	1.0000
L32	22	(H) (Area) CCI-65FP-085125	0.00 - 4.13	1.0000	1.0000
L32	41	(H) PWRT-608-S(13/16)	0.00 - 4.13	1.0000	1.0000

Effective Width of Flat Linear Attachments / Feed Lines

Tower Section	Attachment Record No.	Description	Attachment Segment Elev.	Ratio Calculation Method	Effective Width Ratio
L9	36	Bridge Stiffener 78"x4.5"x1"	80.00 - 83.92	Auto	1.0000
L9	37	Bridge Stiffener 78"x4.5"x1"	80.00 - 83.92	Auto	1.0000
L9	38	Bridge Stiffener 78"x4.5"x1"	80.00 - 83.92	Auto	1.0000
L10	36	Bridge Stiffener 78"x4.5"x1"	77.48 - 80.00	Auto	1.0000
L10	37	Bridge Stiffener 78"x4.5"x1"	77.48 - 80.00	Auto	1.0000
L10	38	Bridge Stiffener 78"x4.5"x1"	77.48 - 80.00	Auto	1.0000
L11	28	(Area) CCI-65FP-060100	75.45 - 75.50	Auto	1.0000
L11	29	(H) (Area) CCI-65FP-060100	75.45 - 75.50	Auto	1.0000
L11	30	(H) (Area) CCI-65FP-060100	75.45 - 75.50	Auto	1.0000
L12	28	(Area) CCI-65FP-060100	70.45 - 75.45	Auto	1.0000
L12	29	(H) (Area) CCI-65FP-060100	70.45 - 75.45	Auto	1.0000
L12	30	(H) (Area) CCI-65FP-060100	70.45 - 75.45	Auto	1.0000
L13	28	(Area) CCI-65FP-060100	65.45 - 70.45	Auto	1.0000
L13	29	(H) (Area) CCI-65FP-060100	65.45 - 70.45	Auto	1.0000
L13	30	(H) (Area) CCI-65FP-060100	65.45 - 70.45	Auto	1.0000

Tower Section	Attachment Record No.	Description	Attachment Segment Elev.	Ratio Calculation Method	Effective Width Ratio
L14	28	(Area) CCI-65FP-060100 (H)	60.45 - 65.45	Auto	1.0000
L14	29	(Area) CCI-65FP-060100 (H)	60.45 - 65.45	Auto	1.0000
L14	30	(Area) CCI-65FP-060100 (H)	60.45 - 65.45	Auto	1.0000
L15	28	(Area) CCI-65FP-060100 (H)	60.00 - 60.45	Auto	1.0000
L15	29	(Area) CCI-65FP-060100 (H)	60.00 - 60.45	Auto	1.0000
L15	30	(Area) CCI-65FP-060100 (H)	60.00 - 60.45	Auto	1.0000
L16	28	(Area) CCI-65FP-060100 (H)	59.75 - 60.00	Auto	1.0000
L16	29	(Area) CCI-65FP-060100 (H)	59.75 - 60.00	Auto	1.0000
L16	30	(Area) CCI-65FP-060100 (H)	59.75 - 60.00	Auto	1.0000
L17	28	(Area) CCI-65FP-060100 (H)	54.75 - 59.75	Auto	1.0000
L17	29	(Area) CCI-65FP-060100 (H)	54.75 - 59.75	Auto	1.0000
L17	30	(Area) CCI-65FP-060100 (H)	54.75 - 59.75	Auto	1.0000
L18	28	(Area) CCI-65FP-060100 (H)	49.75 - 54.75	Auto	1.0000
L18	29	(Area) CCI-65FP-060100 (H)	49.75 - 54.75	Auto	1.0000
L18	30	(Area) CCI-65FP-060100 (H)	49.75 - 54.75	Auto	1.0000
L19	28	(Area) CCI-65FP-060100 (H)	44.75 - 49.75	Auto	1.0000
L19	29	(Area) CCI-65FP-060100 (H)	44.75 - 49.75	Auto	1.0000
L19	30	(Area) CCI-65FP-060100 (H)	44.75 - 49.75	Auto	1.0000
L20	24	(Area) CCI-65FP-065125 (H)	40.00 - 40.50	Auto	1.0000
L20	25	(Area) CCI-65FP-065125 (H)	40.00 - 40.50	Auto	1.0000
L20	26	(Area) CCI-65FP-065125 (H)	40.00 - 40.50	Auto	1.0000
L20	28	(Area) CCI-65FP-060100 (H)	40.50 - 44.75	Auto	1.0000
L20	29	(Area) CCI-65FP-060100 (H)	40.50 - 44.75	Auto	1.0000
L20	30	(Area) CCI-65FP-060100 (H)	40.50 - 44.75	Auto	1.0000
L21	24	(Area) CCI-65FP-065125 (H)	39.75 - 40.00	Auto	1.0000
L21	25	(Area) CCI-65FP-065125 (H)	39.75 - 40.00	Auto	1.0000
L21	26	(Area) CCI-65FP-065125 (H)	39.75 - 40.00	Auto	1.0000
L22	24	(Area) CCI-65FP-065125 (H)	34.75 - 39.75	Auto	1.0000
L22	25	(Area) CCI-65FP-065125 (H)	34.75 - 39.75	Auto	1.0000
L22	26	(Area) CCI-65FP-065125 (H)	34.75 - 39.75	Auto	1.0000
L23	24	(Area) CCI-65FP-065125 (H)	29.75 - 34.75	Auto	1.0000
L23	25	(Area) CCI-65FP-065125 (H)	29.75 - 34.75	Auto	1.0000
L23	26	(Area) CCI-65FP-065125 (H)	29.75 - 34.75	Auto	1.0000
L24	24	(Area) CCI-65FP-065125 (H)	24.75 - 29.75	Auto	1.0000

Tower Section	Attachment Record No.	Description	Attachment Segment Elev.	Ratio Calculation Method	Effective Width Ratio
L24	25	(Area) CCI-65FP-065125 (H)	24.75 - 29.75	Auto	1.0000
L24	26	(Area) CCI-65FP-065125 (H)	24.75 - 29.75	Auto	1.0000
L25	20	(Area) CCI-65FP-085125 (H)	20.00 - 20.50	Auto	1.0000
L25	21	(Area) CCI-65FP-085125 (H)	20.00 - 20.50	Auto	1.0000
L25	22	(Area) CCI-65FP-085125 (H)	20.00 - 20.50	Auto	1.0000
L25	24	(Area) CCI-65FP-065125 (H)	20.50 - 24.75	Auto	1.0000
L25	25	(Area) CCI-65FP-065125 (H)	20.50 - 24.75	Auto	1.0000
L25	26	(Area) CCI-65FP-065125 (H)	20.50 - 24.75	Auto	1.0000
L26	20	(Area) CCI-65FP-085125 (H)	19.75 - 20.00	Auto	1.0000
L26	21	(Area) CCI-65FP-085125 (H)	19.75 - 20.00	Auto	1.0000
L26	22	(Area) CCI-65FP-085125 (H)	19.75 - 20.00	Auto	1.0000
L27	20	(Area) CCI-65FP-085125 (H)	14.75 - 19.75	Auto	1.0000
L27	21	(Area) CCI-65FP-085125 (H)	14.75 - 19.75	Auto	1.0000
L27	22	(Area) CCI-65FP-085125 (H)	14.75 - 19.75	Auto	1.0000
L28	20	(Area) CCI-65FP-085125 (H)	9.75 - 14.75	Auto	1.0000
L28	21	(Area) CCI-65FP-085125 (H)	9.75 - 14.75	Auto	1.0000
L28	22	(Area) CCI-65FP-085125 (H)	9.75 - 14.75	Auto	1.0000
L29	20	(Area) CCI-65FP-085125 (H)	4.75 - 9.75	Auto	1.0000
L29	21	(Area) CCI-65FP-085125 (H)	4.75 - 9.75	Auto	1.0000
L29	22	(Area) CCI-65FP-085125 (H)	4.75 - 9.75	Auto	1.0000
L30	20	(Area) CCI-65FP-085125 (H)	4.38 - 4.75	Auto	1.0000
L30	21	(Area) CCI-65FP-085125 (H)	4.38 - 4.75	Auto	1.0000
L30	22	(Area) CCI-65FP-085125 (H)	4.38 - 4.75	Auto	1.0000
L31	20	(Area) CCI-65FP-085125 (H)	4.13 - 4.38	Auto	1.0000
L31	21	(Area) CCI-65FP-085125 (H)	4.13 - 4.38	Auto	1.0000
L31	22	(Area) CCI-65FP-085125 (H)	4.13 - 4.38	Auto	1.0000
L32	20	(Area) CCI-65FP-085125 (H)	0.00 - 4.13	Auto	1.0000
L32	21	(Area) CCI-65FP-085125 (H)	0.00 - 4.13	Auto	1.0000
L32	22	(Area) CCI-65FP-085125 (H)	0.00 - 4.13	Auto	1.0000

Discrete Tower Loads

Description	Face or Leg	Offset Type	Offsets: Horz Lateral Vert ft ft ft	Azimuth Adjustment °	Placement ft
122					
AIR6449 B41_T-MOBILE w/ Mount Pipe	A	From Leg	4.00 0.00 1.00	0.0000	121.00
AIR6449 B41_T-MOBILE w/ Mount Pipe	B	From Leg	4.00 0.00 1.00	0.0000	121.00
AIR6449 B41_T-MOBILE w/ Mount Pipe	C	From Leg	4.00 0.00 1.00	0.0000	121.00
APXVAALL24_43-U-NA20 w/ Mount Pipe	A	From Leg	4.00 0.00 1.00	0.0000	121.00
APXVAALL24_43-U-NA20 w/ Mount Pipe	B	From Leg	4.00 0.00 1.00	0.0000	121.00
APXVAALL24_43-U-NA20 w/ Mount Pipe	C	From Leg	4.00 0.00 1.00	0.0000	121.00
VV-65A-R1_TMO w/ Mount Pipe	A	From Leg	4.00 0.00 1.00	0.0000	121.00
VV-65A-R1_TMO w/ Mount Pipe	B	From Leg	4.00 0.00 1.00	0.0000	121.00
VV-65A-R1_TMO w/ Mount Pipe	C	From Leg	4.00 0.00 1.00	0.0000	121.00
RADIO 4460 B2/B25 B66_TMO	A	From Leg	4.00 0.00 3.00	0.0000	121.00
RADIO 4460 B2/B25 B66_TMO	B	From Leg	4.00 0.00 3.00	0.0000	121.00
RADIO 4460 B2/B25 B66_TMO	C	From Leg	4.00 0.00 3.00	0.0000	121.00
RADIO 4449 B71/B85A	A	From Leg	4.00 0.00 1.00	0.0000	121.00
RADIO 4449 B71/B85A	B	From Leg	4.00 0.00 1.00	0.0000	121.00
RADIO 4449 B71/B85A	C	From Leg	4.00 0.00 1.00	0.0000	121.00
Platform Mount [LP 405-1_HR-1] **112**	C	None		0.0000	121.00
MT6407-77A w/ Mount Pipe	A	From Centroid-Leg	4.00 0.00 0.00	0.0000	112.00
MT6407-77A w/ Mount Pipe	B	From Centroid-Leg	4.00 0.00 0.00	0.0000	112.00
MT6407-77A w/ Mount Pipe	C	From Centroid-Leg	4.00 0.00 0.00	0.0000	112.00
(2) MX06FRO660-03 w/ Mount Pipe	A	From Centroid-Leg	4.00 0.00 1.00	0.0000	112.00
(2) MX06FRO660-03 w/ Mount Pipe	B	From Centroid-Leg	4.00 0.00 1.00	0.0000	112.00
(2) MX06FRO660-03 w/ Mount Pipe	C	From Centroid-Leg	4.00 0.00	0.0000	112.00

Description	Face or Leg	Offset Type	Offsets: Horz Lateral Vert ft ft ft	Azimuth Adjustment °	Placement ft
HBXX-6517DS-A2M w/ Mount Pipe	A	From Centroid-Leg	1.00 4.00 0.00	0.0000	112.00
HBXX-6517DS-A2M w/ Mount Pipe	B	From Centroid-Leg	1.00 4.00 0.00	0.0000	112.00
HBXX-6517DS-A2M w/ Mount Pipe	C	From Centroid-Leg	1.00 4.00 0.00	0.0000	112.00
RFV01U-D1A	A	From Centroid-Leg	1.00 4.00 0.00	0.0000	112.00
RFV01U-D1A	B	From Centroid-Leg	0.00 4.00 0.00	0.0000	112.00
RFV01U-D1A	C	From Centroid-Leg	0.00 4.00 0.00	0.0000	112.00
RxxDC-3315-PF-48	A	From Centroid-Leg	0.00 4.00 0.00	0.0000	112.00
RxxDC-3315-PF-48	B	From Centroid-Leg	1.00 4.00 0.00	0.0000	112.00
RFV01U-D2A	A	From Centroid-Leg	1.00 4.00 0.00	0.0000	112.00
RFV01U-D2A	B	From Centroid-Leg	0.00 4.00 0.00	0.0000	112.00
RFV01U-D2A	C	From Centroid-Leg	0.00 4.00 0.00	0.0000	112.00
BSF0020F3V1	A	From Leg	0.00 4.00 0.00	0.0000	112.00
BSF0020F3V1	B	From Leg	0.00 4.00 0.00	0.0000	112.00
BSF0020F3V1	C	From Leg	0.00 4.00 0.00	0.0000	112.00
Platform Mount [LP 303-1_HR-1] **100**	C	None	0.0000	0.0000	112.00
TPA65R-BU4D w/ Mount Pipe	B	From Leg	4.00 0.00 0.00	0.0000	100.00
TPA65R-BU4D w/ Mount Pipe	C	From Leg	4.00 0.00 0.00	0.0000	100.00
TPA65R-BU6DA-K w/ Mount Pipe	A	From Leg	4.00 0.00 0.00	0.0000	100.00
AIR 6419 B77G_CCIV3 w/ Mount Pipe	A	From Leg	4.00 0.00 2.00	0.0000	100.00
AIR 6419 B77G_CCIV3 w/ Mount Pipe	B	From Leg	4.00 0.00 2.00	0.0000	100.00
AIR 6419 B77G_CCIV3 w/ Mount Pipe	C	From Leg	4.00 0.00 2.00	0.0000	100.00
AIR 6449 B77D_CCVI2 w/ Mount Pipe	A	From Leg	4.00 0.00	0.0000	100.00

Description	Face or Leg	Offset Type	Offsets: Horz Lateral Vert ft ft ft	Azimuth Adjustment °	Placement ft
AIR 6449 B77D_CCIV2 w/ Mount Pipe	B	From Leg	-2.00 4.00 0.00	0.0000	100.00
AIR 6449 B77D_CCIV2 w/ Mount Pipe	C	From Leg	-2.00 4.00 0.00	0.0000	100.00
RRUS 4478 B14_CCIV2	A	From Leg	-2.00 4.00 0.00	0.0000	100.00
RRUS 4478 B14_CCIV2	B	From Leg	0.00 4.00 0.00	0.0000	100.00
RRUS 4478 B14_CCIV2	C	From Leg	0.00 4.00 0.00	0.0000	100.00
80010964 w/ Mount Pipe	B	From Leg	0.00 4.00 0.00	0.0000	100.00
80010964 w/ Mount Pipe	C	From Leg	0.00 4.00 0.00	0.0000	100.00
80010965 w/ Mount Pipe	A	From Leg	0.00 4.00 0.00	0.0000	100.00
RRUS 32 B30	A	From Leg	0.00 4.00 0.00	0.0000	100.00
RRUS 32 B30	B	From Leg	0.00 4.00 0.00	0.0000	100.00
RRUS 32 B30	C	From Leg	0.00 4.00 0.00	0.0000	100.00
RRUS 4449 B5/B12	A	From Leg	0.00 4.00 0.00	0.0000	100.00
RRUS 4449 B5/B12	B	From Leg	0.00 4.00 0.00	0.0000	100.00
RRUS 4449 B5/B12	C	From Leg	0.00 4.00 0.00	0.0000	100.00
RRUS 8843 B2/B66A	A	From Leg	0.00 4.00 0.00	0.0000	100.00
RRUS 8843 B2/B66A	B	From Leg	0.00 4.00 0.00	0.0000	100.00
RRUS 8843 B2/B66A	C	From Leg	0.00 4.00 0.00	0.0000	100.00
(2) DC6-48-60-18-8F	A	From Leg	0.00 4.00 0.00	0.0000	100.00
DC6-48-60-18-8F	B	From Leg	0.00 4.00 0.00	0.0000	100.00
T-Arm Mount [TA 602-3_KCKR]	C	None		0.0000	100.00
Miscellaneous [NA 507-1]	C	None		0.0000	100.00
(2) 12.5' x 2.375" Mount Pipe	A	From Leg	4.00 0.00 0.00	0.0000	100.00
(2) 12.5' x 2.375" Mount Pipe	B	From Leg	0.00 4.00 0.00	0.0000	100.00

Description	Face or Leg	Offset Type	Offsets: Horz Lateral Vert ft ft ft	Azimuth Adjustment °	Placement ft
(2) 12.5' x 2.375" Mount Pipe	C	From Leg	0.00 4.00 0.00 0.00	0.0000	100.00
90 NNVV-65B-R4 w/ Mount Pipe	A	From Centroid-Leg	4.00 0.00 0.00	0.0000	90.00
NNVV-65B-R4 w/ Mount Pipe	B	From Centroid-Leg	4.00 0.00 0.00	0.0000	90.00
NNVV-65B-R4 w/ Mount Pipe	C	From Centroid-Leg	4.00 0.00 0.00	0.0000	90.00
APXVTM14-ALU-I20 w/ Mount Pipe	A	From Centroid-Leg	4.00 0.00 0.00	0.0000	90.00
APXVTM14-ALU-I20 w/ Mount Pipe	B	From Centroid-Leg	4.00 0.00 0.00	0.0000	90.00
APXVTM14-ALU-I20 w/ Mount Pipe	C	From Centroid-Leg	4.00 0.00 0.00	0.0000	90.00
PCS 1900MHZ 4X45W-65MHZ	A	From Centroid-Leg	4.00 0.00 0.00	0.0000	90.00
(2) PCS 1900MHZ 4X45W-65MHZ	B	From Centroid-Leg	4.00 0.00 0.00	0.0000	90.00
(2) RRH2X50-800	A	From Centroid-Leg	4.00 0.00 0.00	0.0000	90.00
(2) RRH2X50-800	B	From Centroid-Leg	4.00 0.00 0.00	0.0000	90.00
(2) RRH2X50-800	C	From Centroid-Leg	4.00 0.00 0.00	0.0000	90.00
FZHN	A	From Centroid-Leg	4.00 0.00 0.00	0.0000	90.00
FZHN	B	From Centroid-Leg	4.00 0.00 0.00	0.0000	90.00
FZHN	C	From Centroid-Leg	4.00 0.00 0.00	0.0000	90.00
(2) AIRPAIR ODU	B	From Centroid-Leg	4.00 0.00 0.00	0.0000	90.00
AIRPAIR ODU	C	From Centroid-Leg	4.00 0.00 0.00	0.0000	90.00
(2) 2.4" Dia x 6-ft Pipe	A	From Centroid-Leg	4.00 0.00 0.00	0.0000	90.00
(2) 2.4" Dia x 6-ft Pipe	B	From Centroid-Leg	4.00 0.00 0.00	0.0000	90.00
(2) 2.4" Dia x 6-ft Pipe	C	From Centroid-Leg	4.00 0.00 0.00	0.0000	90.00
Platform Mount [LP 303-1_KCKR-HR-1] **81**	C	None		0.0000	90.00
MX08FRO665-21 w/ Mount Pipe	A	From Centroid-Leg	4.00	0.0000	79.00

Description	Face or Leg	Offset Type	Offsets: Horz Lateral Vert ft ft ft	Azimuth Adjustment °	Placement ft
			0.00		
			2.00		
MX08FRO665-21 w/ Mount Pipe	B	From Centroid-Leg	4.00	0.0000	79.00
			0.00		
			2.00		
MX08FRO665-21 w/ Mount Pipe	C	From Centroid-Leg	4.00	0.0000	79.00
			0.00		
			2.00		
TA08025-B604	A	From Centroid-Leg	4.00	0.0000	79.00
			0.00		
			2.00		
TA08025-B604	B	From Centroid-Leg	4.00	0.0000	79.00
			0.00		
			2.00		
TA08025-B604	C	From Centroid-Leg	4.00	0.0000	79.00
			0.00		
			2.00		
TA08025-B605	A	From Centroid-Leg	4.00	0.0000	79.00
			0.00		
			2.00		
TA08025-B605	B	From Centroid-Leg	4.00	0.0000	79.00
			0.00		
			2.00		
TA08025-B605	C	From Centroid-Leg	4.00	0.0000	79.00
			0.00		
			2.00		
RDIDC-9181-PF-48	A	From Centroid-Leg	4.00	0.0000	79.00
			0.00		
			2.00		
(2) 2.4" Dia x 8-ft Mount Pipe	A	From Centroid-Leg	4.00	0.0000	79.00
			0.00		
			0.00		
(2) 2.4" Dia x 8-ft Mount Pipe	B	From Centroid-Leg	4.00	0.0000	79.00
			0.00		
			0.00		
(2) 2.4" Dia x 8-ft Mount Pipe	C	From Centroid-Leg	4.00	0.0000	79.00
			0.00		
			0.00		
Sabre_C10801018-32788 ***** *****	C	None		0.0000	79.00

Dishes

Description	Face or Leg	Dish Type	Offset Type	Offsets: Horz Lateral Vert ft ft ft	Azimuth Adjustment °	3 dB Beam Width °	Elevation ft	Outside Diameter ft
90								
A-ANT-18G-2-C	B	Paraboloid w/Shroud (HP)	From Centroid-Leg	4.00 0.00	90.0000		90.00	2.17
A-ANT-18G-2-C	C	Paraboloid w/Shroud (HP)	From Centroid-Leg	4.00 0.00	30.0000		90.00	2.17
				-2.00 -2.00				
***** **								

Load Combinations

Comb. No.	Description
1	Dead Only
2	1.2 Dead+1.0 Wind 0 deg - No Ice
3	0.9 Dead+1.0 Wind 0 deg - No Ice
4	1.2 Dead+1.0 Wind 30 deg - No Ice
5	0.9 Dead+1.0 Wind 30 deg - No Ice
6	1.2 Dead+1.0 Wind 60 deg - No Ice
7	0.9 Dead+1.0 Wind 60 deg - No Ice
8	1.2 Dead+1.0 Wind 90 deg - No Ice
9	0.9 Dead+1.0 Wind 90 deg - No Ice
10	1.2 Dead+1.0 Wind 120 deg - No Ice
11	0.9 Dead+1.0 Wind 120 deg - No Ice
12	1.2 Dead+1.0 Wind 150 deg - No Ice
13	0.9 Dead+1.0 Wind 150 deg - No Ice
14	1.2 Dead+1.0 Wind 180 deg - No Ice
15	0.9 Dead+1.0 Wind 180 deg - No Ice
16	1.2 Dead+1.0 Wind 210 deg - No Ice
17	0.9 Dead+1.0 Wind 210 deg - No Ice
18	1.2 Dead+1.0 Wind 240 deg - No Ice
19	0.9 Dead+1.0 Wind 240 deg - No Ice
20	1.2 Dead+1.0 Wind 270 deg - No Ice
21	0.9 Dead+1.0 Wind 270 deg - No Ice
22	1.2 Dead+1.0 Wind 300 deg - No Ice
23	0.9 Dead+1.0 Wind 300 deg - No Ice
24	1.2 Dead+1.0 Wind 330 deg - No Ice
25	0.9 Dead+1.0 Wind 330 deg - No Ice
26	1.2 Dead+1.0 Ice+1.0 Temp
27	1.2 Dead+1.0 Wind 0 deg+1.0 Ice+1.0 Temp
28	1.2 Dead+1.0 Wind 30 deg+1.0 Ice+1.0 Temp
29	1.2 Dead+1.0 Wind 60 deg+1.0 Ice+1.0 Temp
30	1.2 Dead+1.0 Wind 90 deg+1.0 Ice+1.0 Temp
31	1.2 Dead+1.0 Wind 120 deg+1.0 Ice+1.0 Temp
32	1.2 Dead+1.0 Wind 150 deg+1.0 Ice+1.0 Temp
33	1.2 Dead+1.0 Wind 180 deg+1.0 Ice+1.0 Temp
34	1.2 Dead+1.0 Wind 210 deg+1.0 Ice+1.0 Temp
35	1.2 Dead+1.0 Wind 240 deg+1.0 Ice+1.0 Temp
36	1.2 Dead+1.0 Wind 270 deg+1.0 Ice+1.0 Temp
37	1.2 Dead+1.0 Wind 300 deg+1.0 Ice+1.0 Temp
38	1.2 Dead+1.0 Wind 330 deg+1.0 Ice+1.0 Temp
39	Dead+Wind 0 deg - Service
40	Dead+Wind 30 deg - Service
41	Dead+Wind 60 deg - Service
42	Dead+Wind 90 deg - Service
43	Dead+Wind 120 deg - Service
44	Dead+Wind 150 deg - Service
45	Dead+Wind 180 deg - Service
46	Dead+Wind 210 deg - Service
47	Dead+Wind 240 deg - Service
48	Dead+Wind 270 deg - Service
49	Dead+Wind 300 deg - Service
50	Dead+Wind 330 deg - Service

Maximum Member Forces

Section No.	Elevation ft	Component Type	Condition	Gov. Load Comb.	Axial K	Major Axis Moment kip-ft	Minor Axis Moment kip-ft
L1	125 - 120	Pole	Max Tension	8	0.00	0.00	-0.00
			Max. Compression	26	-8.01	0.00	0.00
			Max. Mx	8	-4.88	-6.53	0.00
			Max. My	14	-4.88	-0.00	-6.53
			Max. Vy	8	3.59	-6.53	0.00
			Max. Vx	14	3.59	-0.00	-6.53
			Max. Torque	30			-0.02

Section No.	Elevation ft	Component Type	Condition	Gov. Load Comb.	Axial K	Major Axis Moment kip-ft	Minor Axis Moment kip-ft
L2	120 - 115	Pole	Max Tension	1	0.00	0.00	0.00
			Max. Compression	26	-8.77	0.00	0.00
			Max. Mx	8	-5.49	-25.12	0.00
			Max. My	14	-5.48	-0.00	-25.14
			Max. Vy	8	3.85	-25.12	0.00
			Max. Vx	14	3.85	-0.00	-25.14
L3	115 - 110	Pole	Max. Torque	30			-0.02
			Max Tension	1	0.00	0.00	0.00
			Max. Compression	26	-16.17	-0.29	0.17
			Max. Mx	8	-9.80	-53.96	0.00
			Max. My	2	-9.79	-0.03	54.00
			Max. Vy	8	7.58	-53.96	0.00
L4	110 - 105	Pole	Max. Vx	14	7.61	-0.13	-53.93
			Max. Torque	12			0.27
			Max Tension	1	0.00	0.00	0.00
			Max. Compression	26	-16.95	-0.29	0.17
			Max. Mx	8	-10.42	-92.47	-0.07
			Max. My	2	-10.42	0.04	92.61
L5	105 - 100	Pole	Max. Vy	8	7.82	-92.47	-0.07
			Max. Vx	14	7.85	-0.21	-92.56
			Max. Torque	12			0.27
			Max Tension	1	0.00	0.00	0.00
			Max. Compression	26	-17.72	-0.29	0.17
			Max. Mx	8	-11.05	-132.16	-0.15
L6	100 - 95	Pole	Max. My	2	-11.05	0.12	132.40
			Max. Vy	8	8.05	-132.16	-0.15
			Max. Vx	14	8.08	-0.29	-132.37
			Max. Torque	12			0.27
			Max Tension	1	0.00	0.00	0.00
			Max. Compression	26	-26.03	-0.47	1.30
L7	95 - 90	Pole	Max. Mx	8	-15.90	-194.08	0.15
			Max. My	2	-15.89	0.12	195.40
			Max. Vy	8	12.51	-194.08	0.15
			Max. Vx	14	12.67	-0.44	-194.60
			Max. Torque	22			-0.99
			Max Tension	1	0.00	0.00	0.00
L8	90 - 85	Pole	Max. Compression	26	-27.07	-0.40	1.34
			Max. Mx	8	-16.73	-257.29	0.10
			Max. My	2	-16.73	0.23	259.42
			Max. Vy	8	12.79	-257.29	0.10
			Max. Vx	14	12.95	-0.49	-258.62
			Max. Torque	22			-0.99
L9	85 - 80	Pole	Max Tension	1	0.00	0.00	0.00
			Max. Compression	26	-34.61	-1.25	0.81
			Max. Mx	8	-21.29	-337.39	0.02
			Max. My	2	-21.29	-0.25	339.31
			Max. Vy	8	16.16	-337.39	0.02
			Max. Vx	2	-16.25	-0.25	339.31
L10	80 - 75.7	Pole	Max. Torque	24			-1.26
			Max Tension	1	0.00	0.00	0.00
			Max. Compression	26	-35.78	-1.18	0.75
			Max. Mx	8	-22.18	-418.73	0.31
			Max. My	2	-22.18	-0.29	421.12
			Max. Vy	8	16.40	-418.73	0.31
L11	75.7 - 75.45	Pole	Max. Vx	2	-16.49	-0.29	421.12
			Max. Torque	24			-1.26
			Max Tension	1	0.00	0.00	0.00
			Max. Compression	26	-41.37	-1.11	0.93
			Max. Mx	8	-25.96	-498.35	0.64
			Max. My	2	-25.96	-0.33	501.37
L11	75.7 - 75.45	Pole	Max. Vy	8	18.78	-498.35	0.64
			Max. Vx	2	-18.89	-0.33	501.37
			Max. Torque	24			-1.33
			Max Tension	1	0.00	0.00	0.00
			Max. Compression	26	-41.45	-1.11	0.93
			Max. Mx	8	-26.04	-503.04	0.65
L11	75.7 - 75.45	Pole	Max. My	2	-26.03	-0.33	506.09
			Max. Vy	8	18.79	-503.04	0.65
			Max. Vx	2	-18.90	-0.33	506.09

Section No.	Elevation ft	Component Type	Condition	Gov. Load Comb.	Axial K	Major Axis Moment kip-ft	Minor Axis Moment kip-ft
L12	75.45 - 70.45	Pole	Max. Torque	24			-1.33
			Max Tension	1	0.00	0.00	0.00
			Max. Compression	26	-43.21	-1.02	0.86
			Max. Mx	8	-27.43	-597.68	0.93
			Max. My	14	-27.41	-0.33	-601.36
			Max. Vy	8	19.09	-597.68	0.93
			Max. Vx	14	19.50	-0.33	-601.36
L13	70.45 - 65.45	Pole	Max. Torque	24			-1.33
			Max Tension	1	0.00	0.00	0.00
			Max. Compression	26	-44.96	-0.94	0.79
			Max. Mx	8	-28.83	-693.79	1.21
			Max. My	14	-28.81	-0.12	-700.32
			Max. Vy	8	19.38	-693.79	1.21
			Max. Vx	14	20.08	-0.12	-700.32
L14	65.45 - 60.45	Pole	Max. Torque	24			-1.33
			Max Tension	1	0.00	0.00	0.00
			Max. Compression	26	-46.71	-0.86	0.72
			Max. Mx	8	-30.24	-791.27	1.49
			Max. My	14	-30.21	0.09	-802.15
			Max. Vy	8	19.64	-791.27	1.49
			Max. Vx	14	20.65	0.09	-802.15
L15	60.45 - 60	Pole	Max. Torque	24			-1.33
			Max Tension	1	0.00	0.00	0.00
			Max. Compression	26	-46.86	-0.85	0.72
			Max. Mx	8	-30.37	-800.11	1.52
			Max. My	14	-30.34	0.11	-811.45
			Max. Vy	8	19.66	-800.11	1.52
			Max. Vx	14	20.69	0.11	-811.45
L16	60 - 59.75	Pole	Max. Torque	24			-1.33
			Max Tension	1	0.00	0.00	0.00
			Max. Compression	26	-46.96	-0.85	0.71
			Max. Mx	8	-30.45	-805.03	1.53
			Max. My	14	-30.42	0.12	-816.63
			Max. Vy	8	19.68	-805.03	1.53
			Max. Vx	14	20.71	0.12	-816.63
L17	59.75 - 54.75	Pole	Max. Torque	24			-1.33
			Max Tension	1	0.00	0.00	0.00
			Max. Compression	26	-48.88	-0.75	0.64
			Max. Mx	8	-31.99	-904.15	1.81
			Max. My	14	-31.97	0.33	-920.99
			Max. Vy	8	20.00	-904.15	1.81
			Max. Vx	14	21.03	0.33	-920.99
L18	54.75 - 49.75	Pole	Max. Torque	24			-1.33
			Max Tension	1	0.00	0.00	0.00
			Max. Compression	26	-50.80	-0.66	0.56
			Max. Mx	8	-33.54	-1004.80	2.08
			Max. My	14	-33.52	0.55	-1026.88
			Max. Vy	8	20.29	-1004.80	2.08
			Max. Vx	14	21.32	0.55	-1026.88
L19	49.75 - 44.75	Pole	Max. Torque	24			-1.32
			Max Tension	1	0.00	0.00	0.00
			Max. Compression	26	-52.71	-0.57	0.48
			Max. Mx	8	-35.10	-1106.89	2.36
			Max. My	14	-35.08	0.77	-1134.20
			Max. Vy	8	20.57	-1106.89	2.36
			Max. Vx	14	21.60	0.77	-1134.20
L20	44.75 - 40	Pole	Max. Torque	24			-1.32
			Max Tension	1	0.00	0.00	0.00
			Max. Compression	26	-54.52	-0.48	0.41
			Max. Mx	8	-36.58	-1205.11	2.62
			Max. My	14	-36.56	0.97	-1237.39
			Max. Vy	8	20.82	-1205.11	2.62
			Max. Vx	14	21.85	0.97	-1237.39

Section No.	Elevation ft	Component Type	Condition	Gov. Load Comb.	Axial K	Major Axis Moment kip-ft	Minor Axis Moment kip-ft
L21	40 - 39.75	Pole	Max. Torque	24			-1.32
			Max Tension	1	0.00	0.00	0.00
			Max. Compression	26	-54.63	-0.47	0.41
			Max. Mx	8	-36.68	-1210.31	2.63
			Max. My	14	-36.66	0.98	-1242.85
			Max. Vy	8	20.83	-1210.31	2.63
L22	39.75 - 34.75	Pole	Max. Vx	14	21.85	0.98	-1242.85
			Max. Torque	24			-1.32
			Max Tension	1	0.00	0.00	0.00
			Max. Compression	26	-56.85	-0.37	0.32
			Max. Mx	8	-38.49	-1315.14	2.90
			Max. My	14	-38.48	1.20	-1352.92
L23	34.75 - 29.75	Pole	Max. Vy	8	21.13	-1315.14	2.90
			Max. Vx	14	22.16	1.20	-1352.92
			Max. Torque	24			-1.32
			Max Tension	1	0.00	0.00	0.00
			Max. Compression	26	-59.06	-0.26	0.24
			Max. Mx	8	-40.32	-1421.45	3.17
L24	29.75 - 24.75	Pole	Max. My	14	-40.30	1.43	-1464.46
			Max. Vy	8	21.42	-1421.45	3.17
			Max. Vx	14	22.45	1.43	-1464.46
			Max. Torque	24			-1.32
			Max Tension	1	0.00	0.00	0.00
			Max. Compression	26	-61.26	-0.16	0.15
L25	24.75 - 20	Pole	Max. Mx	8	-42.15	-1529.13	3.44
			Max. My	14	-42.14	1.65	-1577.36
			Max. Vy	8	21.69	-1529.13	3.44
			Max. Vx	14	22.71	1.65	-1577.36
			Max. Torque	24			-1.32
			Max Tension	1	0.00	0.00	0.00
L26	20 - 19.75	Pole	Max. Compression	26	-63.35	-0.06	0.07
			Max. Mx	8	-43.89	-1632.64	3.69
			Max. My	14	-43.88	1.86	-1685.83
			Max. Vy	8	21.93	-1632.64	3.69
			Max. Vx	14	22.96	1.86	-1685.83
			Max. Torque	24			-1.32
L27	19.75 - 14.75	Pole	Max Tension	1	0.00	0.00	0.00
			Max. Compression	26	-63.48	-0.06	0.07
			Max. Mx	8	-44.00	-1638.12	3.70
			Max. My	14	-43.99	1.87	-1691.57
			Max. Vy	8	21.94	-1638.12	3.70
			Max. Vx	14	22.96	1.87	-1691.57
L28	14.75 - 9.75	Pole	Max. Torque	24			-1.32
			Max Tension	1	0.00	0.00	0.00
			Max. Compression	26	-66.00	0.06	-0.02
			Max. Mx	8	-46.12	-1748.54	3.97
			Max. My	14	-46.11	2.10	-1807.21
			Max. Vy	8	22.26	-1748.54	3.97
L29	9.75 - 4.75	Pole	Max. Vx	14	23.28	2.10	-1807.21
			Max. Torque	24			-1.32
			Max Tension	1	0.00	0.00	0.00
			Max. Compression	26	-68.52	0.17	-0.11
			Max. Mx	8	-48.24	-1860.50	4.23
			Max. My	14	-48.23	2.33	-1924.38
L30	4.75 - 4.38	Pole	Max. Vy	8	22.56	-1860.50	4.23
			Max. Vx	14	23.58	2.33	-1924.38
			Max. Torque	24			-1.32
			Max Tension	1	0.00	0.00	0.00
			Max. Compression	26	-71.01	0.28	-0.20
			Max. Mx	8	-50.36	-1973.96	4.49
L30	4.75 - 4.38	Pole	Max. My	14	-50.36	2.55	-2043.04
			Max. Vy	8	22.86	-1973.96	4.49
			Max. Vx	14	23.88	2.55	-2043.04
			Max. Torque	24			-1.32
			Max Tension	1	0.00	0.00	0.00
			Max. Compression	26	-71.01	0.28	-0.20

Section No.	Elevation ft	Component Type	Condition	Gov. Load Comb.	Axial K	Major Axis Moment kip-ft	Minor Axis Moment kip-ft
L31	4.38 - 4.13	Pole	Max. Compression	26	-71.19	0.29	-0.20
			Max. Mx	8	-50.52	-1982.41	4.51
			Max. My	14	-50.52	2.57	-2051.88
			Max. Vy	8	22.87	-1982.41	4.51
			Max. Vx	14	23.89	2.57	-2051.88
			Max. Torque	24			-1.32
			Max Tension	1	0.00	0.00	0.00
			Max. Compression	26	-71.31	0.29	-0.21
			Max. Mx	8	-50.62	-1988.13	4.52
			Max. My	14	-50.62	2.58	-2057.86
L32	4.13 - 0	Pole	Max. Vy	8	22.89	-1988.13	4.52
			Max. Vx	14	23.91	2.58	-2057.86
			Max. Torque	24			-1.32
			Max Tension	1	0.00	0.00	0.00
			Max. Compression	26	-73.20	0.38	-0.27
			Max. Mx	8	-52.26	-2083.06	4.74
			Max. My	14	-52.25	2.77	-2157.07
			Max. Vy	8	23.12	-2083.06	4.74
			Max. Vx	14	24.13	2.77	-2157.07
			Max. Torque	24			-1.32

Maximum Reactions

Location	Condition	Gov. Load Comb.	Vertical K	Horizontal, X K	Horizontal, Z K
Pole	Max. Vert	26	73.20	0.00	0.00
	Max. H _x	20	52.26	23.07	-0.03
	Max. H _z	3	39.19	-0.01	23.22
	Max. M _x	2	2095.05	-0.01	23.22
	Max. M _z	8	2083.06	-23.11	0.06
	Max. Torsion	12	1.17	-11.57	-20.08
	Min. Vert	19	39.19	19.97	-11.59
	Min. H _x	8	52.26	-23.11	0.06
	Min. H _z	15	39.19	0.03	-24.12
	Min. M _x	14	-2157.07	0.03	-24.12
	Min. M _z	20	-2079.78	23.07	-0.03
	Min. Torsion	24	-1.32	11.51	20.11

Tower Mast Reaction Summary

Load Combination	Vertical K	Shear _x K	Shear _z K	Overturing Moment, M _x kip-ft	Overturing Moment, M _z kip-ft	Torque kip-ft
Dead Only	43.55	0.00	0.00	0.21	0.16	0.00
1.2 Dead+1.0 Wind 0 deg - No Ice	52.26	0.01	-23.22	-2095.05	-0.70	1.17
0.9 Dead+1.0 Wind 0 deg - No Ice	39.19	0.01	-23.22	-2082.58	-0.74	1.17
1.2 Dead+1.0 Wind 30 deg - No Ice	52.26	11.61	-20.09	-1811.92	-1045.76	1.01
0.9 Dead+1.0 Wind 30 deg - No Ice	39.19	11.61	-20.09	-1801.14	-1039.55	1.01
1.2 Dead+1.0 Wind 60 deg - No Ice	52.26	20.84	-12.09	-1080.62	-1861.42	0.44
0.9 Dead+1.0 Wind 60 deg - No Ice	39.19	20.84	-12.09	-1074.28	-1850.43	0.43
1.2 Dead+1.0 Wind 90 deg - No Ice	52.26	23.11	-0.06	-4.74	-2083.06	-0.15
0.9 Dead+1.0 Wind 90 deg - No Ice	39.19	23.11	-0.06	-4.78	-2070.64	-0.15

Load Combination	Vertical K	Shear _x K	Shear _z K	Overturning Moment, M _x kip-ft	Overturning Moment, M _z kip-ft	Torque kip-ft
1.2 Dead+1.0 Wind 120 deg - No Ice	52.26	20.15	11.68	1053.24	-1814.88	-0.90
0.9 Dead+1.0 Wind 120 deg - No Ice	39.19	20.15	11.68	1046.88	-1804.08	-0.90
1.2 Dead+1.0 Wind 150 deg - No Ice	52.26	11.57	20.08	1811.96	-1043.04	-1.17
0.9 Dead+1.0 Wind 150 deg - No Ice	39.19	11.57	20.08	1801.06	-1036.84	-1.16
1.2 Dead+1.0 Wind 180 deg - No Ice	52.26	-0.03	24.12	2157.07	2.77	-1.07
0.9 Dead+1.0 Wind 180 deg - No Ice	39.19	-0.03	24.12	2144.22	2.72	-1.06
1.2 Dead+1.0 Wind 210 deg - No Ice	52.26	-11.56	20.07	1810.70	1041.82	-0.75
0.9 Dead+1.0 Wind 210 deg - No Ice	39.19	-11.56	20.07	1799.80	1035.55	-0.75
1.2 Dead+1.0 Wind 240 deg - No Ice	52.26	-19.97	11.59	1045.86	1800.71	-0.26
0.9 Dead+1.0 Wind 240 deg - No Ice	39.19	-19.97	11.59	1039.55	1789.90	-0.26
1.2 Dead+1.0 Wind 270 deg - No Ice	52.26	-23.07	0.03	2.37	2079.78	0.31
0.9 Dead+1.0 Wind 270 deg - No Ice	39.19	-23.07	0.03	2.30	2067.30	0.31
1.2 Dead+1.0 Wind 300 deg - No Ice	52.26	-20.89	-12.08	-1080.05	1865.96	0.85
0.9 Dead+1.0 Wind 300 deg - No Ice	39.19	-20.89	-12.08	-1073.70	1854.87	0.84
1.2 Dead+1.0 Wind 330 deg - No Ice	52.26	-11.51	-20.11	-1814.32	1038.44	1.32
0.9 Dead+1.0 Wind 330 deg - No Ice	39.19	-11.51	-20.11	-1803.53	1032.19	1.32
1.2 Dead+1.0 Ice+1.0 Temp	73.20	0.00	0.00	0.27	0.38	0.00
1.2 Dead+1.0 Wind 0 deg+1.0 Ice+1.0 Temp	73.20	0.00	-6.10	-526.64	0.12	0.25
1.2 Dead+1.0 Wind 30 deg+1.0 Ice+1.0 Temp	73.20	3.05	-5.28	-455.60	-263.24	0.21
1.2 Dead+1.0 Wind 60 deg+1.0 Ice+1.0 Temp	73.20	5.28	-3.05	-263.47	-455.09	0.08
1.2 Dead+1.0 Wind 90 deg+1.0 Ice+1.0 Temp	73.20	6.09	-0.01	-0.78	-525.06	-0.04
1.2 Dead+1.0 Wind 120 deg+1.0 Ice+1.0 Temp	73.20	5.27	3.05	263.49	-454.72	-0.20
1.2 Dead+1.0 Wind 150 deg+1.0 Ice+1.0 Temp	73.20	3.05	5.28	455.94	-262.64	-0.25
1.2 Dead+1.0 Wind 180 deg+1.0 Ice+1.0 Temp	73.20	-0.01	6.10	526.62	0.87	-0.23
1.2 Dead+1.0 Wind 210 deg+1.0 Ice+1.0 Temp	73.20	-3.04	5.27	455.73	263.06	-0.16
1.2 Dead+1.0 Wind 240 deg+1.0 Ice+1.0 Temp	73.20	-5.26	3.05	263.30	454.65	-0.05
1.2 Dead+1.0 Wind 270 deg+1.0 Ice+1.0 Temp	73.20	-6.08	0.01	0.68	525.01	0.07
1.2 Dead+1.0 Wind 300 deg+1.0 Ice+1.0 Temp	73.20	-5.27	-3.04	-262.49	455.14	0.19
1.2 Dead+1.0 Wind 330 deg+1.0 Ice+1.0 Temp	73.20	-3.03	-5.28	-456.03	262.34	0.28
Dead+Wind 0 deg - Service	43.55	0.00	-5.29	-475.60	-0.05	0.27
Dead+Wind 30 deg - Service	43.55	2.65	-4.58	-411.31	-237.37	0.23
Dead+Wind 60 deg - Service	43.55	4.75	-2.76	-245.25	-422.60	0.09
Dead+Wind 90 deg - Service	43.55	5.27	-0.01	-0.93	-472.92	-0.04
Dead+Wind 120 deg - Service	43.55	4.59	2.66	239.32	-412.02	-0.21
Dead+Wind 150 deg - Service	43.55	2.64	4.58	411.62	-236.75	-0.27
Dead+Wind 180 deg - Service	43.55	-0.01	5.50	490.00	0.74	-0.25
Dead+Wind 210 deg - Service	43.55	-2.63	4.57	411.33	236.69	-0.17

Load Combination	Vertical K	Shear _x K	Shear _z K	Overturning Moment, M _x kip-ft	Overturning Moment, M _z kip-ft	Torque kip-ft
Dead+Wind 240 deg - Service	43.55	-4.55	2.64	237.65	409.03	-0.05
Dead+Wind 270 deg - Service	43.55	-5.26	0.01	0.69	472.40	0.08
Dead+Wind 300 deg - Service	43.55	-4.76	-2.75	-245.12	423.85	0.20
Dead+Wind 330 deg - Service	43.55	-2.62	-4.58	-411.85	235.93	0.31

Solution Summary

Load Comb.	Sum of Applied Forces			Sum of Reactions			% Error
	PX K	PY K	PZ K	PX K	PY K	PZ K	
1	0.00	-43.55	0.00	0.00	43.55	0.00	0.000%
2	0.01	-52.26	-23.22	-0.01	52.26	23.22	0.000%
3	0.01	-39.19	-23.22	-0.01	39.19	23.22	0.000%
4	11.61	-52.26	-20.09	-11.61	52.26	20.09	0.000%
5	11.61	-39.19	-20.09	-11.61	39.19	20.09	0.000%
6	20.84	-52.26	-12.09	-20.84	52.26	12.09	0.000%
7	20.84	-39.19	-12.09	-20.84	39.19	12.09	0.000%
8	23.11	-52.26	-0.06	-23.11	52.26	0.06	0.000%
9	23.11	-39.19	-0.06	-23.11	39.19	0.06	0.000%
10	20.15	-52.26	11.68	-20.15	52.26	-11.68	0.000%
11	20.15	-39.19	11.68	-20.15	39.19	-11.68	0.000%
12	11.57	-52.26	20.08	-11.57	52.26	-20.08	0.000%
13	11.57	-39.19	20.08	-11.57	39.19	-20.08	0.000%
14	-0.03	-52.26	24.12	0.03	52.26	-24.12	0.000%
15	-0.03	-39.19	24.12	0.03	39.19	-24.12	0.000%
16	-11.56	-52.26	20.07	11.56	52.26	-20.07	0.000%
17	-11.56	-39.19	20.07	11.56	39.19	-20.07	0.000%
18	-19.97	-52.26	11.59	19.97	52.26	-11.59	0.000%
19	-19.97	-39.19	11.59	19.97	39.19	-11.59	0.000%
20	-23.07	-52.26	0.03	23.07	52.26	-0.03	0.000%
21	-23.07	-39.19	0.03	23.07	39.19	-0.03	0.000%
22	-20.89	-52.26	-12.08	20.89	52.26	12.08	0.000%
23	-20.89	-39.19	-12.08	20.89	39.19	12.08	0.000%
24	-11.51	-52.26	-20.11	11.51	52.26	20.11	0.000%
25	-11.51	-39.19	-20.11	11.51	39.19	20.11	0.000%
26	0.00	-73.20	0.00	0.00	73.20	0.00	0.000%
27	0.00	-73.20	-6.10	-0.00	73.20	6.10	0.000%
28	3.05	-73.20	-5.28	-3.05	73.20	5.28	0.000%
29	5.28	-73.20	-3.05	-5.28	73.20	3.05	0.000%
30	6.09	-73.20	-0.01	-6.09	73.20	0.01	0.000%
31	5.27	-73.20	3.05	-5.27	73.20	-3.05	0.000%
32	3.05	-73.20	5.28	-3.05	73.20	-5.28	0.000%
33	-0.01	-73.20	6.10	0.01	73.20	-6.10	0.000%
34	-3.04	-73.20	5.27	3.04	73.20	-5.27	0.000%
35	-5.26	-73.20	3.05	5.26	73.20	-3.05	0.000%
36	-6.08	-73.20	0.01	6.08	73.20	-0.01	0.000%
37	-5.27	-73.20	-3.04	5.27	73.20	3.04	0.000%
38	-3.03	-73.20	-5.28	3.03	73.20	5.28	0.000%
39	0.00	-43.55	-5.29	-0.00	43.55	5.29	0.000%
40	2.65	-43.55	-4.58	-2.65	43.55	4.58	0.000%
41	4.75	-43.55	-2.76	-4.75	43.55	2.76	0.000%
42	5.27	-43.55	-0.01	-5.27	43.55	0.01	0.000%
43	4.59	-43.55	2.66	-4.59	43.55	-2.66	0.000%
44	2.64	-43.55	4.58	-2.64	43.55	-4.58	0.000%
45	-0.01	-43.55	5.50	0.01	43.55	-5.50	0.000%
46	-2.63	-43.55	4.57	2.63	43.55	-4.57	0.000%
47	-4.55	-43.55	2.64	4.55	43.55	-2.64	0.000%
48	-5.26	-43.55	0.01	5.26	43.55	-0.01	0.000%
49	-4.76	-43.55	-2.75	4.76	43.55	2.75	0.000%
50	-2.62	-43.55	-4.58	2.62	43.55	4.58	0.000%

Non-Linear Convergence Results

Load Combination	Converged?	Number of Cycles	Displacement Tolerance	Force Tolerance
1	Yes	4	0.00000001	0.00000001
2	Yes	5	0.00000001	0.00003455
3	Yes	4	0.00000001	0.00069839
4	Yes	5	0.00000001	0.00022256
5	Yes	5	0.00000001	0.00011090
6	Yes	5	0.00000001	0.00021487
7	Yes	5	0.00000001	0.00010618
8	Yes	4	0.00000001	0.00062170
9	Yes	4	0.00000001	0.00032953
10	Yes	5	0.00000001	0.00020201
11	Yes	5	0.00000001	0.00010004
12	Yes	5	0.00000001	0.00022447
13	Yes	5	0.00000001	0.00011193
14	Yes	5	0.00000001	0.00003213
15	Yes	4	0.00000001	0.00063842
16	Yes	5	0.00000001	0.00020054
17	Yes	5	0.00000001	0.00009944
18	Yes	5	0.00000001	0.00021062
19	Yes	5	0.00000001	0.00010478
20	Yes	4	0.00000001	0.00064374
21	Yes	4	0.00000001	0.00034972
22	Yes	5	0.00000001	0.00023045
23	Yes	5	0.00000001	0.00011433
24	Yes	5	0.00000001	0.00019548
25	Yes	5	0.00000001	0.00009677
26	Yes	4	0.00000001	0.00000001
27	Yes	5	0.00000001	0.00031249
28	Yes	5	0.00000001	0.00031900
29	Yes	5	0.00000001	0.00031871
30	Yes	5	0.00000001	0.00031166
31	Yes	5	0.00000001	0.00031749
32	Yes	5	0.00000001	0.00031721
33	Yes	5	0.00000001	0.00031030
34	Yes	5	0.00000001	0.00031566
35	Yes	5	0.00000001	0.00031516
36	Yes	5	0.00000001	0.00030921
37	Yes	5	0.00000001	0.00031650
38	Yes	5	0.00000001	0.00031763
39	Yes	4	0.00000001	0.00012050
40	Yes	4	0.00000001	0.00018151
41	Yes	4	0.00000001	0.00017242
42	Yes	4	0.00000001	0.00011111
43	Yes	4	0.00000001	0.00016646
44	Yes	4	0.00000001	0.00018446
45	Yes	4	0.00000001	0.00012075
46	Yes	4	0.00000001	0.00016468
47	Yes	4	0.00000001	0.00016982
48	Yes	4	0.00000001	0.00011116
49	Yes	4	0.00000001	0.00018539
50	Yes	4	0.00000001	0.00016562

Maximum Tower Deflections - Service Wind

Section No.	Elevation ft	Horz. Deflection in	Gov. Load Comb.	Tilt °	Twist °
L1	125 - 120	6.674	45	0.4601	0.0012
L2	120 - 115	6.193	45	0.4599	0.0012
L3	115 - 110	5.713	45	0.4573	0.0012
L4	110 - 105	5.237	45	0.4512	0.0011

Section No.	Elevation ft	Horz. Deflection in	Gov. Load Comb.	Tilt °	Twist °
L5	105 - 100	4.771	45	0.4390	0.0011
L6	100 - 95	4.320	45	0.4204	0.0010
L7	95 - 90	3.887	45	0.4066	0.0009
L8	90 - 85	3.471	45	0.3875	0.0009
L9	85 - 80	3.078	45	0.3625	0.0007
L10	80 - 75.7	2.714	45	0.3306	0.0006
L11	75.7 - 75.45	2.425	45	0.3115	0.0005
L12	75.45 - 70.45	2.409	45	0.3107	0.0005
L13	70.45 - 65.45	2.092	45	0.2926	0.0004
L14	65.45 - 60.45	1.797	45	0.2713	0.0004
L15	60.45 - 60	1.525	45	0.2467	0.0003
L16	60 - 59.75	1.502	45	0.2443	0.0003
L17	59.75 - 54.75	1.490	45	0.2434	0.0003
L18	54.75 - 49.75	1.244	45	0.2244	0.0003
L19	49.75 - 44.75	1.020	45	0.2030	0.0002
L20	44.75 - 40	0.820	45	0.1793	0.0002
L21	40 - 39.75	0.654	45	0.1547	0.0002
L22	39.75 - 34.75	0.646	45	0.1538	0.0002
L23	34.75 - 29.75	0.494	45	0.1359	0.0001
L24	29.75 - 24.75	0.362	45	0.1164	0.0001
L25	24.75 - 20	0.251	45	0.0953	0.0001
L26	20 - 19.75	0.166	45	0.0739	0.0001
L27	19.75 - 14.75	0.162	45	0.0731	0.0001
L28	14.75 - 9.75	0.094	45	0.0571	0.0001
L29	9.75 - 4.75	0.043	45	0.0399	0.0000
L30	4.75 - 4.38	0.011	45	0.0217	0.0000
L31	4.38 - 4.13	0.009	45	0.0203	0.0000
L32	4.13 - 0	0.008	45	0.0192	0.0000

Critical Deflections and Radius of Curvature - Service Wind

Elevation ft	Appurtenance	Gov. Load Comb.	Deflection in	Tilt °	Twist °	Radius of Curvature ft
121.00	AIR6449 B41_T-MOBILE w/ Mount Pipe	45	6.289	0.4601	0.0012	238132
112.00	MT6407-77A w/ Mount Pipe	45	5.426	0.4542	0.0012	42176
100.00	TPA65R-BU4D w/ Mount Pipe	45	4.320	0.4204	0.0010	17501
90.00	NNVV-65B-R4 w/ Mount Pipe	45	3.471	0.3875	0.0009	12957
88.00	A-ANT-18G-2-C	45	3.310	0.3785	0.0008	11403
79.00	MX08FRO665-21 w/ Mount Pipe	45	2.645	0.3252	0.0006	11013

Maximum Tower Deflections - Design Wind

Section No.	Elevation ft	Horz. Deflection in	Gov. Load Comb.	Tilt °	Twist °
L1	125 - 120	29.445	14	2.0305	0.0050
L2	120 - 115	27.320	14	2.0297	0.0050
L3	115 - 110	25.199	14	2.0182	0.0050
L4	110 - 105	23.099	14	1.9910	0.0049
L5	105 - 100	21.040	14	1.9374	0.0047
L6	100 - 95	19.052	14	1.8551	0.0044
L7	95 - 90	17.139	14	1.7945	0.0040
L8	90 - 85	15.302	14	1.7104	0.0036
L9	85 - 80	13.567	14	1.5995	0.0031
L10	80 - 75.7	11.964	14	1.4584	0.0025
L11	75.7 - 75.45	10.687	14	1.3739	0.0021
L12	75.45 - 70.45	10.615	14	1.3702	0.0021
L13	70.45 - 65.45	9.221	14	1.2902	0.0019
L14	65.45 - 60.45	7.918	14	1.1961	0.0016

Section No.	Elevation ft	Horz. Deflection in	Gov. Load Comb.	Tilt °	Twist °
L15	60.45 - 60	6.721	14	1.0874	0.0014
L16	60 - 59.75	6.619	14	1.0769	0.0014
L17	59.75 - 54.75	6.563	14	1.0730	0.0014
L18	54.75 - 49.75	5.483	14	0.9890	0.0012
L19	49.75 - 44.75	4.496	14	0.8948	0.0010
L20	44.75 - 40	3.612	14	0.7904	0.0009
L21	40 - 39.75	2.879	14	0.6815	0.0007
L22	39.75 - 34.75	2.844	14	0.6777	0.0007
L23	34.75 - 29.75	2.175	14	0.5985	0.0006
L24	29.75 - 24.75	1.593	14	0.5127	0.0005
L25	24.75 - 20	1.104	14	0.4199	0.0004
L26	20 - 19.75	0.732	14	0.3254	0.0003
L27	19.75 - 14.75	0.716	14	0.3220	0.0003
L28	14.75 - 9.75	0.415	14	0.2512	0.0002
L29	9.75 - 4.75	0.191	14	0.1758	0.0001
L30	4.75 - 4.38	0.049	14	0.0955	0.0001
L31	4.38 - 4.13	0.041	14	0.0894	0.0001
L32	4.13 - 0	0.037	14	0.0844	0.0001

Critical Deflections and Radius of Curvature - Design Wind

Elevation ft	Appurtenance	Gov. Load Comb.	Deflection in	Tilt °	Twist °	Radius of Curvature ft
121.00	AIR6449 B41_T-MOBILE w/ Mount Pipe	14	27.745	2.0305	0.0050	54020
112.00	MT6407-77A w/ Mount Pipe	14	23.936	2.0042	0.0050	9593
100.00	TPA65R-BU4D w/ Mount Pipe	14	19.052	1.8551	0.0044	3981
90.00	NNVV-65B-R4 w/ Mount Pipe	14	15.302	1.7104	0.0036	2950
88.00	A-ANT-18G-2-C	14	14.594	1.6703	0.0034	2594
79.00	MX08FRO665-21 w/ Mount Pipe	14	11.659	1.4345	0.0024	2501

Compression Checks

Pole Design Data

Section No.	Elevation ft	Size	L ft	L _u ft	KI/r	A in ²	P _u K	φP _n K	Ratio P _u / φP _n
L1	125 - 120 (1)	P24x0.375	5.00	0.00	0.0	27.832 5	-4.88	1052.07	0.005
L2	120 - 115 (2)	P24x0.375	5.00	0.00	0.0	27.832 5	-5.48	1052.07	0.005
L3	115 - 110 (3)	P24x0.375	5.00	0.00	0.0	27.832 5	-9.79	1052.07	0.009
L4	110 - 105 (4)	P24x0.375	5.00	0.00	0.0	27.832 5	-10.42	1052.07	0.010
L5	105 - 100 (5)	P24x0.375	5.00	0.00	0.0	27.832 5	-11.05	1052.07	0.011
L6	100 - 95 (6)	P30x0.375	5.00	0.00	0.0	34.901 1	-15.89	1311.06	0.012
L7	95 - 90 (7)	P30x0.375	5.00	0.00	0.0	34.901 1	-16.73	1311.06	0.013
L8	90 - 85 (8)	P30x0.375	5.00	0.00	0.0	34.901 1	-21.29	1311.06	0.016
L9	85 - 80 (9)	P30x0.375	5.00	0.00	0.0	34.901 1	-22.18	1311.06	0.017
L10	80 - 75.7 (10)	P36x0.375	4.30	0.00	0.0	41.969	-25.96	1490.10	0.017

Section No.	Elevation ft	Size	L ft	L _u ft	KI/r	A in ²	P _u K	φP _n K	Ratio P _u φP _n
L11	75.7 - 75.45 (11)	P36x0.5625	0.25	0.00	0.0	62.623 7 2	-26.03	2367.16	0.011
L12	75.45 - 70.45 (12)	P36x0.5625	5.00	0.00	0.0	62.623 2	-27.41	2367.16	0.012
L13	70.45 - 65.45 (13)	P36x0.5625	5.00	0.00	0.0	62.623 2	-28.81	2367.16	0.012
L14	65.45 - 60.45 (14)	P36x0.5625	5.00	0.00	0.0	62.623 2	-30.21	2367.16	0.013
L15	60.45 - 60 (15)	P36x0.5625	0.45	0.00	0.0	62.623 2	-30.34	2367.16	0.013
L16	60 - 59.75 (16)	P42x0.525	0.25	0.00	0.0	68.406 2	-30.42	2569.67	0.012
L17	59.75 - 54.75 (17)	P42x0.525	5.00	0.00	0.0	68.406 2	-31.97	2569.67	0.012
L18	54.75 - 49.75 (18)	P42x0.525	5.00	0.00	0.0	68.406 2	-33.52	2569.67	0.013
L19	49.75 - 44.75 (19)	P42x0.525	5.00	0.00	0.0	68.406 2	-35.08	2569.67	0.014
L20	44.75 - 40 (20)	P42x0.525	4.75	0.00	0.0	68.406 2	-36.56	2569.67	0.014
L21	40 - 39.75 (21)	P48x0.55625	0.25	0.00	0.0	82.908 5	-36.66	3039.70	0.012
L22	39.75 - 34.75 (22)	P48x0.55625	5.00	0.00	0.0	82.908 5	-38.48	3039.70	0.013
L23	34.75 - 29.75 (23)	P48x0.55625	5.00	0.00	0.0	82.908 5	-40.30	3039.70	0.013
L24	29.75 - 24.75 (24)	P48x0.55625	5.00	0.00	0.0	82.908 5	-42.14	3039.70	0.014
L25	24.75 - 20 (25)	P48x0.55625	4.75	0.00	0.0	82.908 5	-43.88	3039.70	0.014
L26	20 - 19.75 (26)	P54x0.5875	0.25	0.00	0.0	98.582 7	-43.99	3545.23	0.012
L27	19.75 - 14.75 (27)	P54x0.5875	5.00	0.00	0.0	98.582 7	-46.11	3545.23	0.013
L28	14.75 - 9.75 (28)	P54x0.5875	5.00	0.00	0.0	98.582 7	-48.23	3545.23	0.014
L29	9.75 - 4.75 (29)	P54x0.5875	5.00	0.00	0.0	98.582 7	-50.36	3545.23	0.014
L30	4.75 - 4.38 (30)	P54x0.5875	0.37	0.00	0.0	98.582 7	-50.52	3545.23	0.014
L31	4.38 - 4.13 (31)	P54x0.4875	0.25	0.00	0.0	81.955 8	-50.62	2797.17	0.018
L32	4.13 - 0 (32)	P54x0.4875	4.13	0.00	0.0	81.955 8	-52.25	2797.17	0.019

Pole Bending Design Data

Section No.	Elevation ft	Size	M _{ux} kip-ft	φM _{nx} kip-ft	Ratio M _{ux} φM _{nx}	M _{uy} kip-ft	φM _{ny} kip-ft	Ratio M _{uy} φM _{ny}
L1	125 - 120 (1)	P24x0.375	6.53	623.72	0.010	0.00	623.72	0.000
L2	120 - 115 (2)	P24x0.375	25.14	623.72	0.040	0.00	623.72	0.000
L3	115 - 110 (3)	P24x0.375	54.00	623.72	0.087	0.00	623.72	0.000
L4	110 - 105 (4)	P24x0.375	92.62	623.72	0.149	0.00	623.72	0.000
L5	105 - 100 (5)	P24x0.375	132.45	623.72	0.212	0.00	623.72	0.000
L6	100 - 95 (6)	P30x0.375	195.40	947.86	0.206	0.00	947.86	0.000
L7	95 - 90 (7)	P30x0.375	259.42	947.86	0.274	0.00	947.86	0.000
L8	90 - 85 (8)	P30x0.375	339.31	947.86	0.358	0.00	947.86	0.000
L9	85 - 80 (9)	P30x0.375	421.12	947.86	0.444	0.00	947.86	0.000
L10	80 - 75.7 (10)	P36x0.375	501.37	1338.81	0.374	0.00	1338.81	0.000
L11	75.7 - 75.45 (11)	P36x0.5625	506.09	2105.04	0.240	0.00	2105.04	0.000
L12	75.45 - 70.45 (12)	P36x0.5625	601.36	2105.04	0.286	0.00	2105.04	0.000

Section No.	Elevation ft	Size	M_{ux}	ϕM_{nx}	Ratio	M_{uy}	ϕM_{ny}	Ratio
			kip-ft	kip-ft	$\frac{M_{ux}}{\phi M_{nx}}$		kip-ft	kip-ft
L13	70.45 - 65.45 (13)	P36x0.5625	700.32	2105.04	0.333	0.00	2105.04	0.000
L14	65.45 - 60.45 (14)	P36x0.5625	802.15	2105.04	0.381	0.00	2105.04	0.000
L15	60.45 - 60 (15)	P36x0.5625	811.45	2105.04	0.385	0.00	2105.04	0.000
L16	60 - 59.75 (16)	P42x0.525	816.63	2600.93	0.314	0.00	2600.93	0.000
L17	59.75 - 54.75 (17)	P42x0.525	920.99	2600.93	0.354	0.00	2600.93	0.000
L18	54.75 - 49.75 (18)	P42x0.525	1026.88	2600.93	0.395	0.00	2600.93	0.000
L19	49.75 - 44.75 (19)	P42x0.525	1134.20	2600.93	0.436	0.00	2600.93	0.000
L20	44.75 - 40 (20)	P42x0.525	1237.39	2600.93	0.476	0.00	2600.93	0.000
L21	40 - 39.75 (21)	P48x0.55625	1242.85	3569.34	0.348	0.00	3569.34	0.000
L22	39.75 - 34.75 (22)	P48x0.55625	1352.92	3569.34	0.379	0.00	3569.34	0.000
L23	34.75 - 29.75 (23)	P48x0.55625	1464.46	3569.34	0.410	0.00	3569.34	0.000
L24	29.75 - 24.75 (24)	P48x0.55625	1577.37	3569.34	0.442	0.00	3569.34	0.000
L25	24.75 - 20 (25)	P48x0.55625	1685.83	3569.34	0.472	0.00	3569.34	0.000
L26	20 - 19.75 (26)	P54x0.5875	1691.57	4739.87	0.357	0.00	4739.87	0.000
L27	19.75 - 14.75 (27)	P54x0.5875	1807.21	4739.87	0.381	0.00	4739.87	0.000
L28	14.75 - 9.75 (28)	P54x0.5875	1924.38	4739.87	0.406	0.00	4739.87	0.000
L29	9.75 - 4.75 (29)	P54x0.5875	2043.04	4739.87	0.431	0.00	4739.87	0.000
L30	4.75 - 4.38 (30)	P54x0.5875	2051.88	4739.87	0.433	0.00	4739.87	0.000
L31	4.38 - 4.13 (31)	P54x0.4875	2057.86	3864.47	0.533	0.00	3864.47	0.000
L32	4.13 - 0 (32)	P54x0.4875	2157.07	3864.47	0.558	0.00	3864.47	0.000

Pole Shear Design Data

Section No.	Elevation ft	Size	Actual	ϕV_n	Ratio	Actual	ϕT_n	Ratio
			V_u K	K	$\frac{V_u}{\phi V_n}$	T_u kip-ft	kip-ft	$\frac{T_u}{\phi T_n}$
L1	125 - 120 (1)	P24x0.375	3.59	315.62	0.011	0.00	655.57	0.000
L2	120 - 115 (2)	P24x0.375	3.85	315.62	0.012	0.00	655.57	0.000
L3	115 - 110 (3)	P24x0.375	7.60	315.62	0.024	0.24	655.57	0.000
L4	110 - 105 (4)	P24x0.375	7.85	315.62	0.025	0.27	655.57	0.000
L5	105 - 100 (5)	P24x0.375	8.08	315.62	0.026	0.27	655.57	0.000
L6	100 - 95 (6)	P30x0.375	12.66	395.78	0.032	0.35	994.73	0.000
L7	95 - 90 (7)	P30x0.375	12.94	395.78	0.033	0.35	994.73	0.000
L8	90 - 85 (8)	P30x0.375	16.25	395.78	0.041	1.18	994.73	0.001
L9	85 - 80 (9)	P30x0.375	16.49	395.78	0.042	1.18	994.73	0.001
L10	80 - 75.7 (10)	P36x0.375	18.89	454.19	0.042	1.18	1094.28	0.001
L11	75.7 - 75.45 (11)	P36x0.5625	18.90	710.15	0.027	1.18	2212.54	0.001
L12	75.45 - 70.45 (12)	P36x0.5625	19.50	710.15	0.027	1.07	2212.54	0.000
L13	70.45 - 65.45 (13)	P36x0.5625	20.08	710.15	0.028	1.07	2212.54	0.000
L14	65.45 - 60.45 (14)	P36x0.5625	20.65	710.15	0.029	1.07	2212.54	0.000
L15	60.45 - 60 (15)	P36x0.5625	20.69	710.15	0.029	1.07	2212.54	0.000

Section No.	Elevation ft	Size	Actual V_u K	ϕV_n K	Ratio V_u ϕV_n	Actual T_u kip-ft	ϕT_n kip-ft	Ratio T_u ϕT_n
L16	60 - 59.75 (16)	P42x0.525	20.71	775.73	0.027	1.07	2800.23	0.000
L17	59.75 - 54.75 (17)	P42x0.525	21.03	775.73	0.027	1.07	2800.23	0.000
L18	54.75 - 49.75 (18)	P42x0.525	21.32	775.73	0.027	1.07	2800.23	0.000
L19	49.75 - 44.75 (19)	P42x0.525	21.60	775.73	0.028	1.07	2800.23	0.000
L20	44.75 - 40 (20)	P42x0.525	21.85	775.73	0.028	1.07	2800.23	0.000
L21	40 - 39.75 (21)	P48x0.55625	21.85	940.18	0.023	1.07	3775.58	0.000
L22	39.75 - 34.75 (22)	P48x0.55625	22.16	940.18	0.024	1.07	3775.58	0.000
L23	34.75 - 29.75 (23)	P48x0.55625	22.45	940.18	0.024	1.07	3775.58	0.000
L24	29.75 - 24.75 (24)	P48x0.55625	22.71	940.18	0.024	1.07	3775.58	0.000
L25	24.75 - 20 (25)	P48x0.55625	22.96	940.18	0.024	1.07	3775.58	0.000
L26	20 - 19.75 (26)	P54x0.5875	22.96	1117.93	0.021	1.07	4954.02	0.000
L27	19.75 - 14.75 (27)	P54x0.5875	23.28	1117.93	0.021	1.07	4954.02	0.000
L28	14.75 - 9.75 (28)	P54x0.5875	23.58	1117.93	0.021	1.07	4954.02	0.000
L29	9.75 - 4.75 (29)	P54x0.5875	23.88	1117.93	0.021	1.07	4954.02	0.000
L30	4.75 - 4.38 (30)	P54x0.5875	23.89	1117.93	0.021	1.07	4954.02	0.000
L31	4.38 - 4.13 (31)	P54x0.4875	23.91	903.52	0.026	1.07	3267.82	0.000
L32	4.13 - 0 (32)	P54x0.4875	24.13	903.52	0.027	1.07	3267.82	0.000

Pole Interaction Design Data

Section No.	Elevation ft	Ratio P_u ϕP_n	Ratio M_{ux} ϕM_{nx}	Ratio M_{uy} ϕM_{ny}	Ratio V_u ϕV_n	Ratio T_u ϕT_n	Comb. Stress Ratio	Allow. Stress Ratio	Criteria
L1	125 - 120 (1)	0.005	0.010	0.000	0.011	0.000	0.015	1.050	4.8.2
L2	120 - 115 (2)	0.005	0.040	0.000	0.012	0.000	0.046	1.050	4.8.2
L3	115 - 110 (3)	0.009	0.087	0.000	0.024	0.000	0.096	1.050	4.8.2
L4	110 - 105 (4)	0.010	0.149	0.000	0.025	0.000	0.159	1.050	4.8.2
L5	105 - 100 (5)	0.011	0.212	0.000	0.026	0.000	0.224	1.050	4.8.2
L6	100 - 95 (6)	0.012	0.206	0.000	0.032	0.000	0.219	1.050	4.8.2
L7	95 - 90 (7)	0.013	0.274	0.000	0.033	0.000	0.288	1.050	4.8.2
L8	90 - 85 (8)	0.016	0.358	0.000	0.041	0.001	0.376	1.050	4.8.2
L9	85 - 80 (9)	0.017	0.444	0.000	0.042	0.001	0.463	1.050	4.8.2
L10	80 - 75.7 (10)	0.017	0.374	0.000	0.042	0.001	0.394	1.050	4.8.2
L11	75.7 - 75.45 (11)	0.011	0.240	0.000	0.027	0.001	0.252	1.050	4.8.2
L12	75.45 - 70.45 (12)	0.012	0.286	0.000	0.027	0.000	0.298	1.050	4.8.2
L13	70.45 - 65.45 (13)	0.012	0.333	0.000	0.028	0.000	0.346	1.050	4.8.2
L14	65.45 - 60.45 (14)	0.013	0.381	0.000	0.029	0.000	0.395	1.050	4.8.2
L15	60.45 - 60 (15)	0.013	0.385	0.000	0.029	0.000	0.399	1.050	4.8.2
L16	60 - 59.75 (16)	0.012	0.314	0.000	0.027	0.000	0.327	1.050	4.8.2
L17	59.75 - 54.75 (17)	0.012	0.354	0.000	0.027	0.000	0.367	1.050	4.8.2

Section No.	Elevation ft	Ratio	Ratio	Ratio	Ratio	Ratio	Comb. Stress Ratio	Allow. Stress Ratio	Criteria
		P_u	M_{ux}	M_{uy}	V_u	T_u			
L18	54.75 - 49.75 (18)	0.013	0.395	0.000	0.027	0.000	0.409	1.050	4.8.2
L19	49.75 - 44.75 (19)	0.014	0.436	0.000	0.028	0.000	0.451	1.050	4.8.2
L20	44.75 - 40 (20)	0.014	0.476	0.000	0.028	0.000	0.491	1.050	4.8.2
L21	40 - 39.75 (21)	0.012	0.348	0.000	0.023	0.000	0.361	1.050	4.8.2
L22	39.75 - 34.75 (22)	0.013	0.379	0.000	0.024	0.000	0.392	1.050	4.8.2
L23	34.75 - 29.75 (23)	0.013	0.410	0.000	0.024	0.000	0.424	1.050	4.8.2
L24	29.75 - 24.75 (24)	0.014	0.442	0.000	0.024	0.000	0.456	1.050	4.8.2
L25	24.75 - 20 (25)	0.014	0.472	0.000	0.024	0.000	0.487	1.050	4.8.2
L26	20 - 19.75 (26)	0.012	0.357	0.000	0.021	0.000	0.370	1.050	4.8.2
L27	19.75 - 14.75 (27)	0.013	0.381	0.000	0.021	0.000	0.395	1.050	4.8.2
L28	14.75 - 9.75 (28)	0.014	0.406	0.000	0.021	0.000	0.420	1.050	4.8.2
L29	9.75 - 4.75 (29)	0.014	0.431	0.000	0.021	0.000	0.446	1.050	4.8.2
L30	4.75 - 4.38 (30)	0.014	0.433	0.000	0.021	0.000	0.448	1.050	4.8.2
L31	4.38 - 4.13 (31)	0.018	0.533	0.000	0.026	0.000	0.551	1.050	4.8.2
L32	4.13 - 0 (32)	0.019	0.558	0.000	0.027	0.000	0.578	1.050	4.8.2

Section Capacity Table

Section No.	Elevation ft	Component Type	Size	Critical Element	P K	ϕP_{allow} K	% Capacity	Pass Fail
L1	125 - 120	Pole	P24x0.375	1	-4.88	1104.67	1.5	Pass
L2	120 - 115	Pole	P24x0.375	2	-5.48	1104.67	4.3	Pass
L3	115 - 110	Pole	P24x0.375	3	-9.79	1104.67	9.2	Pass
L4	110 - 105	Pole	P24x0.375	4	-10.42	1104.67	15.1	Pass
L5	105 - 100	Pole	P24x0.375	5	-11.05	1104.67	21.3	Pass
L6	100 - 95	Pole	P30x0.375	6	-15.89	1376.61	20.9	Pass
L7	95 - 90	Pole	P30x0.375	7	-16.73	1376.61	27.4	Pass
L8	90 - 85	Pole	P30x0.375	8	-21.29	1376.61	35.8	Pass
L9	85 - 80	Pole	P30x0.375	9	-22.18	1376.61	44.1	Pass
L10	80 - 75.7	Pole	P36x0.375	10	-25.96	1564.60	37.5	Pass
L11	75.7 - 75.45	Pole	P36x0.5625	11	-26.03	2485.52	24.0	Pass
L12	75.45 - 70.45	Pole	P36x0.5625	12	-27.41	2485.52	28.4	Pass
L13	70.45 - 65.45	Pole	P36x0.5625	13	-28.81	2485.52	32.9	Pass
L14	65.45 - 60.45	Pole	P36x0.5625	14	-30.21	2485.52	37.6	Pass
L15	60.45 - 60	Pole	P36x0.5625	15	-30.34	2485.52	38.0	Pass
L16	60 - 59.75	Pole	P42x0.525	16	-30.42	2698.15	31.1	Pass
L17	59.75 - 54.75	Pole	P42x0.525	17	-31.97	2698.15	35.0	Pass
L18	54.75 - 49.75	Pole	P42x0.525	18	-33.52	2698.15	38.9	Pass
L19	49.75 - 44.75	Pole	P42x0.525	19	-35.08	2698.15	42.9	Pass
L20	44.75 - 40	Pole	P42x0.525	20	-36.56	2698.15	46.7	Pass
L21	40 - 39.75	Pole	P48x0.55625	21	-36.66	3191.68	34.4	Pass
L22	39.75 - 34.75	Pole	P48x0.55625	22	-38.48	3191.68	37.4	Pass
L23	34.75 - 29.75	Pole	P48x0.55625	23	-40.30	3191.68	40.4	Pass
L24	29.75 - 24.75	Pole	P48x0.55625	24	-42.14	3191.68	43.5	Pass
L25	24.75 - 20	Pole	P48x0.55625	25	-43.88	3191.68	46.4	Pass
L26	20 - 19.75	Pole	P54x0.5875	26	-43.99	3722.49	35.2	Pass
L27	19.75 - 14.75	Pole	P54x0.5875	27	-46.11	3722.49	37.6	Pass
L28	14.75 - 9.75	Pole	P54x0.5875	28	-48.23	3722.49	40.0	Pass

Section No.	Elevation ft	Component Type	Size	Critical Element	P K	ϕP_{allow} K	% Capacity	Pass Fail	
L29	9.75 - 4.75	Pole	P54x0.5875	29	-50.36	3722.49	42.4	Pass	
L30	4.75 - 4.38	Pole	P54x0.5875	30	-50.52	3722.49	42.6	Pass	
L31	4.38 - 4.13	Pole	P54x0.4875	31	-50.62	2937.03	52.5	Pass	
L32	4.13 - 0	Pole	P54x0.4875	32	-52.25	2937.03	55.0	Pass	
							Summary		
							Pole (L32)	55.0	Pass
							RATING =	55.0	Pass

***NOTE: Above stress ratios for reinforced sections are approximate. More exact calculations are presented in Appendix C.**

APPENDIX B
BASE LEVEL DRAWING



(OTHER CONSIDERED EQUIPMENT—IN CONDUIT)
(1) 3/8" TO 100 FT LEVEL
(OTHER CONSIDERED EQUIPMENT)
(2) 3/8" TO 100 FT LEVEL
(6) 13/16" TO 100 FT LEVEL
(6) 1-1/4" TO 100 FT LEVEL

(OTHER CONSIDERED EQUIPMENT)
(3) 1/2" TO 90 FT LEVEL
(4) 1-1/4" TO 90 FT LEVEL

CLIMBING PEGS
W/
SAFETY CLIMB

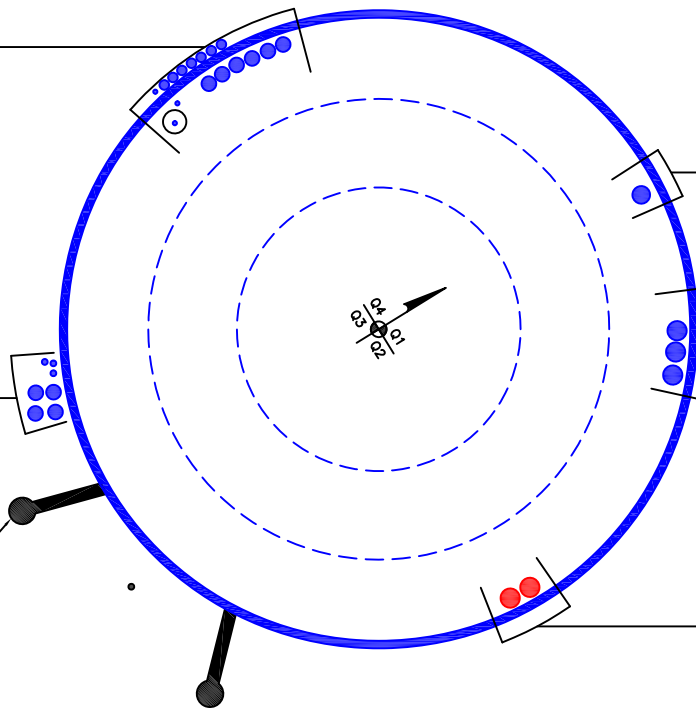

(OTHER CONSIDERED EQUIPMENT)
(1) 1-1/2" TO 79 FT LEVEL

(OTHER CONSIDERED EQUIPMENT)
(3) 1-5/8" TO 121 FT LEVEL

(PROPOSED EQUIPMENT CONFIGURATION)
(2) 1-5/8" TO 112 FT LEVEL

APPENDIX C
ADDITIONAL CALCULATIONS

Site BU: 822765
Work Order: 2246887



Copyright © 2019 Crown Castle

Pole Geometry

	Pole Height Above Base (ft)	Section Length (ft)	Lap Splice Length (ft)	Number of Sides	Top Diameter (in)	Bottom Diameter (in)	Wall Thickness (in)	Bend Radius (in)	Pole Material
1	125	25		0	24	24	0.375		A53-B-42
2	100	20		0	30.00	30	0.375		A53-B-42
3	80	20		0	36.00	36	0.375		A53-B-42
4	60	20		0	42.00	42	0.375		A53-B-42
5	40	20		0	48.00	48	0.375		A53-B-42
6	20	20		0	54.00	54	0.375		A53-B-42

Reinforcement Configuration

	Bottom Effective Elevation (ft)	Top Effective Elevation (ft)	Type	Model	Number	1	2	3	4	5	6	7	8	9	10	11	12	13	14	15	16	17	18
1	4.38	20	plate	CCI-CFP-085125	3	0					120						240						
2	20	40	plate	CCI-SFP-065125	3	0					120						240						
3	40	60	plate	CCI-SFP-060100	3	0					120						240						
4	60	75.7	plate	CCI-CFP-060100 24in L	3	0					120						240						
5	0	4.38	plate	TS 6.5x1.25	3								139			221							349
6																							
7																							
8																							
9																							
10																							

Reinforcement Details

	B (in)	H (in)	Gross Area (in ²)	Pole Face to Centroid (in)	Bottom Termination Type	Bottom Termination Length (in)	Top Termination Type	Top Termination Length (in)	Lu (in)	Net Area (in ²)	Bolt Hole Size (in)	Reinforcement Material
1	8.5	1.25	10.625	0.625	PC 8.8 - M20 (100)	45	PC 8.8 - M20 (100)	45.000	24.000	9.063	1.1875	A572-65
2	6.5	1.25	8.125	0.625	PC 8.8 - M20 (100)	33	PC 8.8 - M20 (100)	33.000	19.000	6.563	1.1875	A572-65
3	6	1	6	0.5	PC 8.8 - M20 (100)	24	PC 8.8 - M20 (100)	24.000	16.000	4.750	1.1875	A572-65
4	6	1	6	0.5	PC 8.8 - M20 (100)	24	PC 8.8 - M20 (100)	24.000	24.000	4.750	1.1875	A572-65
5	1.25	6.5	8.125	3.25	Welded	n/a	Welded	n/a	0.000	8.125	0.0000	A572-65

Connection Details for Custom Reinforcements

Reinforcement	End	# Bolts	N or X	Bolt Spacing (in)	Edge Dist (in)	Weld Grade (ksi)	Transverse (Horiz.) Weld Type	Horiz. Weld Length (in)	Horiz. Groove Depth (in)	Horiz. Groove Angle (deg)	Horiz. Fillet Size (in)	Vertical Weld Length (in)	Vertical Fillet Size (in)	Rev H Connection Capacity (kip)
TS 6.5x1.25	Top	-	-	-	-	80	None	-	-	-	-	48	0.375	-
	Bottom	-	-	-	-	80	CJP Groove	6	0.5	45	0.5	12	0.375	-
CCI-CFP-060100 24in Lu	Top	8	N	3	3	-	-	-	-	-	-	-	-	-
	Bottom	8	N	3	3	-	-	-	-	-	-	-	-	-
CCI-CFP-085125	Top	15	N	3	3	-	-	-	-	-	-	-	-	-
	Bottom	15	N	3	3	-	-	-	-	-	-	-	-	-

TNX Geometry Input

Increment (ft): [Export to TNX](#)

	Section Height (ft)	Section Length (ft)	Lap Splice Length (ft)	Number of Sides	Top Diameter (in)	Bottom Diameter (in)	Wall Thickness (in)	Tapered Pole Grade	Weight Multiplier
1	125 - 120	5		0	24.000	24.000	0.375	A53-B-42	1.000
2	120 - 115	5		0	24.000	24.000	0.375	A53-B-42	1.000
3	115 - 110	5		0	24.000	24.000	0.375	A53-B-42	1.000
4	110 - 105	5		0	24.000	24.000	0.375	A53-B-42	1.000
5	105 - 100	5	0	0	24.000	24.000	0.375	A53-B-42	1.000
6	100 - 95	5		0	30.000	30.000	0.375	A53-B-42	1.000
7	95 - 90	5		0	30.000	30.000	0.375	A53-B-42	1.000
8	90 - 85	5		0	30.000	30.000	0.375	A53-B-42	1.000
9	85 - 80	5	0	0	30.000	30.000	0.375	A53-B-42	1.000
10	80 - 75.7	4.3		0	36.000	36.000	0.375	A53-B-42	1.000
11	75.7 - 75.45	0.25		0	36.000	36.000	0.5625	A53-B-42	0.958
12	75.45 - 70.45	5		0	36.000	36.000	0.5625	A53-B-42	0.958
13	70.45 - 65.45	5		0	36.000	36.000	0.5625	A53-B-42	0.958
14	65.45 - 60.45	5		0	36.000	36.000	0.5625	A53-B-42	0.958
15	60.45 - 60	0.45	0	0	36.000	36.000	0.5625	A53-B-42	0.958
16	60 - 59.75	0.25		0	42.000	42.000	0.525	A53-B-42	0.980
17	59.75 - 54.75	5		0	42.000	42.000	0.525	A53-B-42	0.980
18	54.75 - 49.75	5		0	42.000	42.000	0.525	A53-B-42	0.980
19	49.75 - 44.75	5		0	42.000	42.000	0.525	A53-B-42	0.980
20	44.75 - 40	4.75	0	0	42.000	42.000	0.525	A53-B-42	0.980
21	40 - 39.75	0.25		0	48.000	48.000	0.55625	A53-B-42	0.971
22	39.75 - 34.75	5		0	48.000	48.000	0.55625	A53-B-42	0.971
23	34.75 - 29.75	5		0	48.000	48.000	0.55625	A53-B-42	0.971
24	29.75 - 24.75	5		0	48.000	48.000	0.55625	A53-B-42	0.971
25	24.75 - 20	4.75	0	0	48.000	48.000	0.55625	A53-B-42	0.971
26	20 - 19.75	0.25		0	54.000	54.000	0.5875	A53-B-42	0.964
27	19.75 - 14.75	5		0	54.000	54.000	0.5875	A53-B-42	0.964
28	14.75 - 9.75	5		0	54.000	54.000	0.5875	A53-B-42	0.964
29	9.75 - 4.75	5		0	54.000	54.000	0.5875	A53-B-42	0.964
30	4.75 - 4.38	0.37		0	54.000	54.000	0.5875	A53-B-42	0.964
31	4.38 - 4.13	0.25		0	54.000	54.000	0.4875	A53-B-42	1.068
32	4.13 - 0	4.13		0	54.000	54.000	0.4875	A53-B-42	1.068

TNX Section Forces

Increment (ft):		TNX Output			
	5	Section Height (ft)	P _u (K)	M _{ux} (kip-ft)	V _u (K)
1	125 - 120	4.88	6.53	3.59	
2	120 - 115	5.48	25.14	3.85	
3	115 - 110	9.79	54.00	7.60	
4	110 - 105	10.42	92.62	7.85	
5	105 - 100	11.05	132.45	8.08	
6	100 - 95	15.89	195.40	12.66	
7	95 - 90	16.73	259.42	12.94	
8	90 - 85	21.29	339.31	16.25	
9	85 - 80	22.18	421.12	16.49	
10	80 - 75.7	25.96	501.37	18.89	
11	75.7 - 75.45	26.03	506.09	18.90	
12	75.45 - 70.45	27.41	601.36	19.50	
13	70.45 - 65.45	28.81	700.32	20.08	
14	65.45 - 60.45	30.21	802.15	20.65	
15	60.45 - 60	30.34	811.45	20.69	
16	60 - 59.75	30.42	816.63	20.71	
17	59.75 - 54.75	31.97	920.99	21.03	
18	54.75 - 49.75	33.52	1026.88	21.32	
19	49.75 - 44.75	35.08	1134.20	21.60	
20	44.75 - 40	36.56	1237.39	21.85	
21	40 - 39.75	36.66	1242.85	21.85	
22	39.75 - 34.75	38.48	1352.92	22.16	
23	34.75 - 29.75	40.30	1464.46	22.45	
24	29.75 - 24.75	42.14	1577.37	22.71	
25	24.75 - 20	43.88	1685.83	22.96	
26	20 - 19.75	43.99	1691.57	22.96	
27	19.75 - 14.75	46.11	1807.21	23.28	
28	14.75 - 9.75	48.23	1924.38	23.58	
29	9.75 - 4.75	50.36	2043.04	23.88	
30	4.75 - 4.38	50.52	2051.88	23.89	
31	4.38 - 4.13	50.62	2057.86	23.91	
32	4.13 - 0	52.25	2157.07	24.13	

Analysis Results

Elevation (ft)	Component Type	Size	Critical Element	% Capacity	Pass / Fail
125 - 120	Pole	TP24x24x0.375	Pole	1.5%	Pass
120 - 115	Pole	TP24x24x0.375	Pole	4.3%	Pass
115 - 110	Pole	TP24x24x0.375	Pole	9.2%	Pass
110 - 105	Pole	TP24x24x0.375	Pole	15.1%	Pass
105 - 100	Pole	TP24x24x0.375	Pole	21.3%	Pass
100 - 95	Pole	TP30x30x0.375	Pole	20.9%	Pass
95 - 90	Pole	TP30x30x0.375	Pole	27.4%	Pass
90 - 85	Pole	TP30x30x0.375	Pole	35.8%	Pass
85 - 80	Pole	TP30x30x0.375	Pole	44.1%	Pass
80 - 75.7	Pole	TP36x36x0.375	Pole	37.5%	Pass
75.7 - 75.45	Pole + Reinf.	TP36x36x0.5625	Reinf. 4 Compression	29.7%	Pass
75.45 - 70.45	Pole + Reinf.	TP36x36x0.5625	Reinf. 4 Compression	35.1%	Pass
70.45 - 65.45	Pole + Reinf.	TP36x36x0.5625	Reinf. 4 Compression	40.7%	Pass
65.45 - 60.45	Pole + Reinf.	TP36x36x0.5625	Reinf. 4 Compression	46.5%	Pass
60.45 - 60	Pole + Reinf.	TP36x36x0.5625	Reinf. 4 Compression	47.0%	Pass
60 - 59.75	Pole + Reinf.	TP42x42x0.525	Pole	32.2%	Pass
59.75 - 54.75	Pole + Reinf.	TP42x42x0.525	Pole	36.2%	Pass
54.75 - 49.75	Pole + Reinf.	TP42x42x0.525	Pole	40.3%	Pass
49.75 - 44.75	Pole + Reinf.	TP42x42x0.525	Pole	44.5%	Pass
44.75 - 40	Pole + Reinf.	TP42x42x0.525	Pole	48.5%	Pass
40 - 39.75	Pole + Reinf.	TP48x48x0.5563	Pole	35.9%	Pass
39.75 - 34.75	Pole + Reinf.	TP48x48x0.5563	Pole	39.1%	Pass
34.75 - 29.75	Pole + Reinf.	TP48x48x0.5563	Pole	42.2%	Pass
29.75 - 24.75	Pole + Reinf.	TP48x48x0.5563	Pole	45.4%	Pass
24.75 - 20	Pole + Reinf.	TP48x48x0.5563	Pole	48.5%	Pass
20 - 19.75	Pole + Reinf.	TP54x54x0.5875	Pole	37.2%	Pass
19.75 - 14.75	Pole + Reinf.	TP54x54x0.5875	Pole	39.7%	Pass
14.75 - 9.75	Pole + Reinf.	TP54x54x0.5875	Pole	42.2%	Pass
9.75 - 4.75	Pole + Reinf.	TP54x54x0.5875	Pole	44.8%	Pass
4.75 - 4.38	Pole + Reinf.	TP54x54x0.5875	Pole	45.0%	Pass
4.38 - 4.13	Pole + Reinf.	TP54x54x0.4875	Pole	56.4%	Pass
4.13 - 0	Pole + Reinf.	TP54x54x0.4875	Pole	59.1%	Pass
				Summary	
			Pole	59.1%	Pass
			Reinforcement	47.0%	Pass
			Overall	59.1%	Pass

Additional Calculations

Section Elevation (ft)	Moment of Inertia (in ⁴)			Area (in ²)			% Capacity* (100% Max. Allowable)					
	Pole	Reinf.	Total	Pole	Reinf.	Total	Pole	R1	R2	R3	R4	R5
125 - 120	1942	n/a	1942	27.83	n/a	27.83	1.5%					
120 - 115	1942	n/a	1942	27.83	n/a	27.83	4.3%					
115 - 110	1942	n/a	1942	27.83	n/a	27.83	9.2%					
110 - 105	1942	n/a	1942	27.83	n/a	27.83	15.1%					
105 - 100	1942	n/a	1942	27.83	n/a	27.83	21.3%					
100 - 95	3829	n/a	3829	34.90	n/a	34.90	20.9%					
95 - 90	3829	n/a	3829	34.90	n/a	34.90	27.4%					
90 - 85	3829	n/a	3829	34.90	n/a	34.90	35.8%					
85 - 80	3829	n/a	3829	34.90	n/a	34.90	44.1%					
80 - 75.7	6659	n/a	6659	41.97	n/a	41.97	37.5%					
75.7 - 75.45	6659	3108	9767	41.97	18.00	59.97	25.7%				29.7%	
75.45 - 70.45	6659	3108	9767	41.97	18.00	59.97	30.4%				35.1%	
70.45 - 65.45	6659	3108	9767	41.97	18.00	59.97	35.3%				40.7%	
65.45 - 60.45	6659	3108	9767	41.97	18.00	59.97	40.3%				46.5%	
60.45 - 60	6659	3108	9767	41.97	18.00	59.97	40.7%				47.0%	
60 - 59.75	10622	4188	14810	49.04	18.00	67.04	32.2%			29.7%		
59.75 - 54.75	10622	4188	14810	49.04	18.00	67.04	36.2%			33.4%		
54.75 - 49.75	10622	4188	14810	49.04	18.00	67.04	40.3%			37.2%		
49.75 - 44.75	10622	4188	14810	49.04	18.00	67.04	44.5%			41.0%		
44.75 - 40	10622	4188	14810	49.04	18.00	67.04	48.5%			44.6%		
40 - 39.75	15908	7435	23343	56.11	24.38	80.48	35.9%		32.1%			
39.75 - 34.75	15908	7435	23343	56.11	24.38	80.48	39.1%		34.9%			
34.75 - 29.75	15908	7435	23343	56.11	24.38	80.48	42.2%		37.7%			
29.75 - 24.75	15908	7435	23343	56.11	24.38	80.48	45.4%		40.6%			
24.75 - 20	15908	7435	23343	56.11	24.38	80.48	48.5%		43.3%			
20 - 19.75	22710	12261	34970	63.18	31.88	95.05	37.2%	35.4%				
19.75 - 14.75	22710	12261	34970	63.18	31.88	95.05	39.7%	37.8%				
14.75 - 9.75	22710	12261	34970	63.18	31.88	95.05	42.2%	40.2%				
9.75 - 4.75	22710	12261	34970	63.18	31.88	95.05	44.8%	42.7%				
4.75 - 4.38	22710	12261	34970	63.18	31.88	95.05	45.0%	42.8%				
4.38 - 4.13	22761	6480	29241	63.18	24.38	87.55	56.4%					38.9%
4.13 - 0	22761	6480	29241	63.18	24.38	87.55	59.1%					45.7%

Note: Section capacity checked using 5 degree increments.

*Rating per TIA-222-H Section 15.5.

Monopole Flange Plate Connection

Elevation = 100 ft.



BU #	822765
Site Name	Branford (I-95/X55)
Order #	654626 Rev. 0
TIA-222 Revision	H

Applied Loads	
Moment (kip-ft)	132.45
Axial Force (kips)	11.05
Shear Force (kips)	8.08

*TIA-222-H Section 15.5 Applied

Top Plate - External

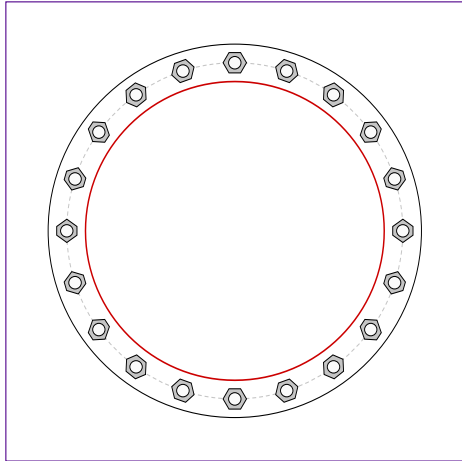

Bottom Plate - Internal

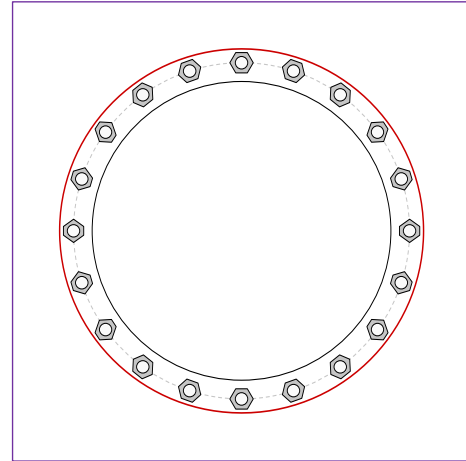

Connection Properties

Bolt Data

(20) 1" \emptyset bolts (A325 N; Fy=92 ksi, Fu=120 ksi) on 27" BC

Top Plate Data

30" OD x 1" Plate (A36; Fy=36 ksi, Fu=58 ksi)

Bottom Plate Data

24" ID x 1" Plate (A36; Fy=36 ksi, Fu=58 ksi)

Top Stiffener Data

N/A

Bottom Stiffener Data

N/A

Top Pole Data

24" x 0.375" round pole (A53-B-42; Fy=42 ksi, Fu=63 ksi)

Bottom Pole Data

30" x 0.375" round pole (A53-B-42; Fy=42 ksi, Fu=63 ksi)

Analysis Results

Bolt Capacity

Max Load (kips)	11.21
Allowable (kips)	54.54
Stress Rating:	19.6% Pass

Top Plate Capacity

Max Stress (ksi):	-
Allowable Stress (ksi):	-
Stress Rating:	Pirod OK
Tension Side Stress Rating:	Pirod OK

Bottom Plate Capacity

Max Stress (ksi):	-
Allowable Stress (ksi):	-
Stress Rating:	Pirod OK
Tension Side Stress Rating:	Pirod OK

Monopole Flange Plate Connection

Elevation = 80 ft.



BU #	822765
Site Name	Branford (I-95/X55)
Order #	654626 Rev. 0
TIA-222 Revision	H

Applied Loads to Flange Connections		Applied Loads to Bridge Stiffeners	
Moment (kip-ft)	194.34	Moment (kip-ft)	226.78
Axial Force (kips)	22.18	Axial Force (kips)	0.00
Shear Force (kips)	16.49	Shear Force (kips)	0.00

*TIA-222-H Section 15.5 Applied

Top Plate - External

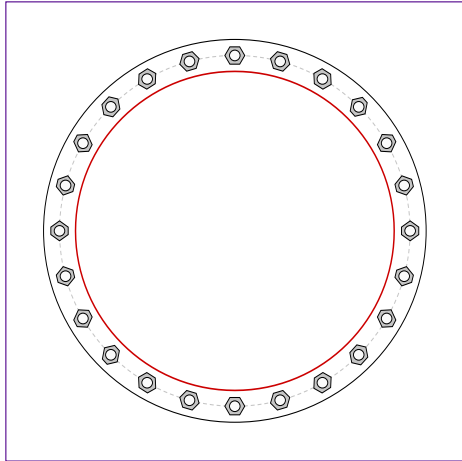

Bottom Plate - Internal

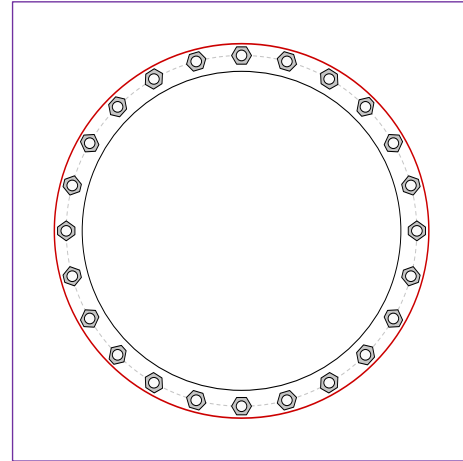

Connection Properties

Bolt Data

(24) 1" \emptyset bolts (A325 N; Fy=92 ksi, Fu=120 ksi) on 33" BC

Top Plate Data

36" OD x 1" Plate (A36; Fy=36 ksi, Fu=58 ksi)

Top Stiffener Data

N/A

Top Pole Data

30" x 0.375" round pole (A53-B-42; Fy=42 ksi, Fu=63 ksi)

Bridge Stiffener Group 1 Data

(3) Bolted, 4.5"x1", A572-65, Lu=16", Neglect Flange in MOI: No

Bottom Plate Data

30" ID x 1" Plate (A36; Fy=36 ksi, Fu=58 ksi)

Bottom Stiffener Data

N/A

Bottom Pole Data

36" x 0.375" round pole (A53-B-42; Fy=42 ksi, Fu=63 ksi)

Analysis Results

Bolt Capacity

Max Load (kips)	10.85
Allowable (kips)	54.53
Stress Rating:	19.0% Pass

Top Plate Capacity

Max Stress (ksi):	12.25	(Flexural)
Allowable Stress (ksi):	32.40	
Stress Rating:	36.0%	Pass
Tension Side Stress Rating:	11.6%	Pass

Bottom Plate Capacity

Max Stress (ksi):	12.38	(Flexural)
Allowable Stress (ksi):	32.40	
Stress Rating:	36.4%	Pass
Tension Side Stress Rating:	N/A	

Bridge Stiffener Group 1 Analysis Capacity

Max Compression (kip):	98.07
Max Tension (kip):	98.07
Comp. Capacity (kip):	196.59
Tens. Capacity (kip):	195.00 (Rupture)
Comp. Stress Rating:	47.5% Pass
Tens. Stress Rating:	47.9% Pass

Monopole Flange Plate Connection

Elevation = 60 ft.



BU #	822765
Site Name	Branford (I-95/X55)
Order #	654626 Rev. 0
TIA-222 Revision	H

Applied Loads to Flange Connections		Applied Loads to Bridge Stiffeners	
Moment (kip-ft)	354.41	Moment (kip-ft)	457.04
Axial Force (kips)	30.34	Axial Force (kips)	0.00
Shear Force (kips)	20.69	Shear Force (kips)	0.00

*TIA-222-H Section 15.5 Applied

Top Plate - External

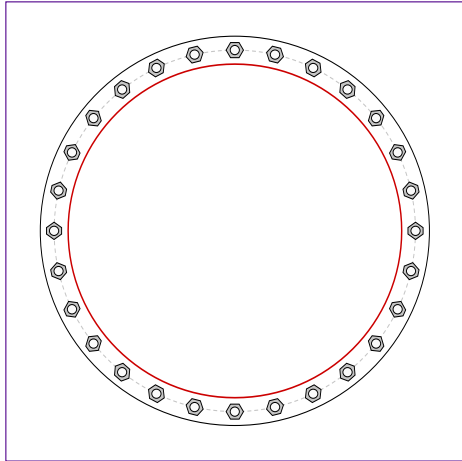

Bottom Plate - Internal

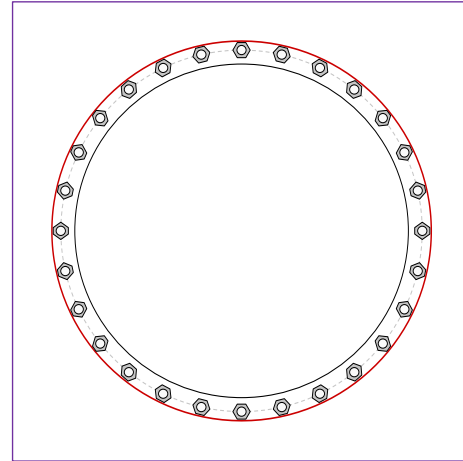

Connection Properties

Bolt Data

(28) 1" \emptyset bolts (A325 N; Fy=92 ksi, Fu=120 ksi) on 39" BC

Top Plate Data

42" OD x 1" Plate (A36; Fy=36 ksi, Fu=58 ksi)

Top Stiffener Data

N/A

Top Pole Data

36" x 0.5625" round pole (A53-B-42; Fy=42 ksi, Fu=63 ksi)

Bridge Stiffener Group 1 Data

(3) Bolted, 6"x1", A572-65, Lu=16", Neglect Flange in MOI: No

Bottom Plate Data

36" ID x 1.25" Plate (A36; Fy=36 ksi, Fu=58 ksi)

Bottom Stiffener Data

N/A

Bottom Pole Data

42" x 0.525" round pole (A53-B-42; Fy=42 ksi, Fu=63 ksi)

Analysis Results

Bolt Capacity

Max Load (kips)	14.49
Allowable (kips)	54.53
Stress Rating:	25.3% Pass

Top Plate Capacity

Max Stress (ksi):	15.58	(Flexural)
Allowable Stress (ksi):	32.40	
Stress Rating:	45.8%	Pass
Tension Side Stress Rating:	15.1%	Pass

Bottom Plate Capacity

Max Stress (ksi):	9.05	(Flexural)
Allowable Stress (ksi):	32.40	
Stress Rating:	26.6%	Pass
Tension Side Stress Rating:	N/A	

Bridge Stiffener Group 1 Analysis Capacity

Max Compression (kip):	170.06	
Max Tension (kip):	170.06	
Comp. Capacity (kip):	262.12	
Tens. Capacity (kip):	285.00	(Rupture)
Comp. Stress Rating:	61.8%	Pass
Tens. Stress Rating:	56.8%	Pass

Monopole Flange Plate Connection

Elevation = 40 ft.



BU #	822765
Site Name	Branford (I-95/X55)
Order #	654626 Rev. 0
TIA-222 Revision	H

Applied Loads to Flange Connections		Applied Loads to Bridge Stiffeners	
Moment (kip-ft)	564.43	Moment (kip-ft)	672.96
Axial Force (kips)	36.56	Axial Force (kips)	0.00
Shear Force (kips)	21.85	Shear Force (kips)	0.00

*TIA-222-H Section 15.5 Applied

Top Plate - External

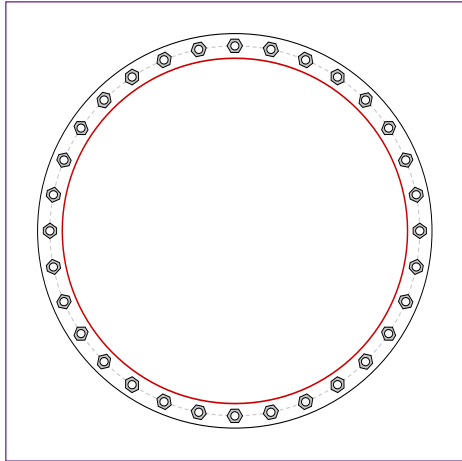

Bottom Plate - Internal

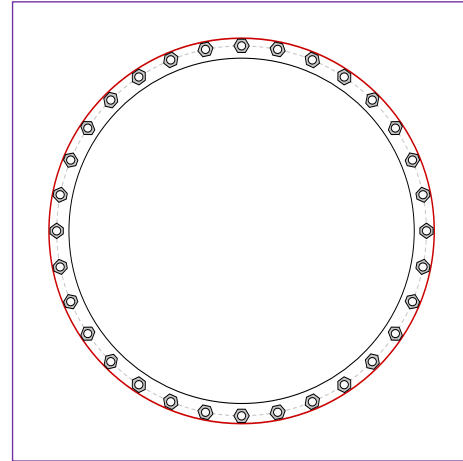

Connection Properties

Bolt Data

(32) 1" \emptyset bolts (A325 N; Fy=92 ksi, Fu=120 ksi) on 45" BC

Top Plate Data

48" OD x 1" Plate (A36; Fy=36 ksi, Fu=58 ksi)

Top Stiffener Data

N/A

Top Pole Data

42" x 0.525" round pole (A53-B-42; Fy=42 ksi, Fu=63 ksi)

Bridge Stiffener Group 1 Data

(3) Bolted, 6.5"x1", A572-65, Lu=16", Neglect Flange in MOI: No

Bottom Plate Data

42" ID x 1.25" Plate (A36; Fy=36 ksi, Fu=58 ksi)

Bottom Stiffener Data

N/A

Bottom Pole Data

48" x 0.55625" round pole (A53-B-42; Fy=42 ksi, Fu=63 ksi)

Analysis Results

Bolt Capacity

Max Load (kips)	17.67
Allowable (kips)	54.53
Stress Rating:	30.9% Pass

Top Plate Capacity

Max Stress (ksi):	18.72	(Flexural)
Allowable Stress (ksi):	32.40	
Stress Rating:	55.0%	Pass
Tension Side Stress Rating:	17.9%	Pass

Bottom Plate Capacity

Max Stress (ksi):	10.47	(Flexural)
Allowable Stress (ksi):	32.40	
Stress Rating:	30.8%	Pass
Tension Side Stress Rating:	N/A	

Bridge Stiffener Group 1 Analysis Capacity

Max Compression (kip):	219.74	
Max Tension (kip):	219.74	
Comp. Capacity (kip):	283.96	
Tens. Capacity (kip):	315.00	(Rupture)
Comp. Stress Rating:	73.7%	Pass
Tens. Stress Rating:	66.4%	Pass

Monopole Flange Plate Connection

Elevation = 20 ft.



BU #	822765
Site Name	Branford (I-95/X55)
Order #	654626 Rev. 0
TIA-222 Revision	H

Applied Loads to Flange Connections		Applied Loads to Bridge Stiffeners	
Moment (kip-ft)	620.99	Moment (kip-ft)	1064.84
Axial Force (kips)	43.88	Axial Force (kips)	0.00
Shear Force (kips)	22.96	Shear Force (kips)	0.00

*TIA-222-H Section 15.5 Applied

Top Plate - External

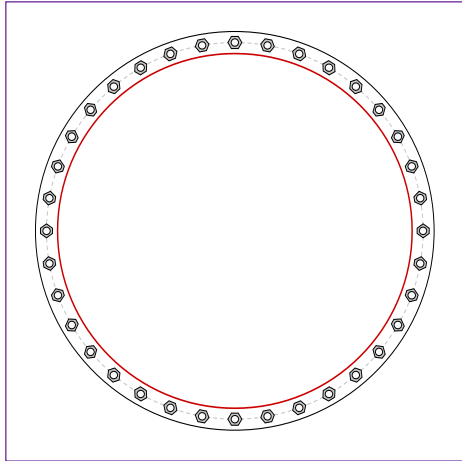

Bottom Plate - Internal

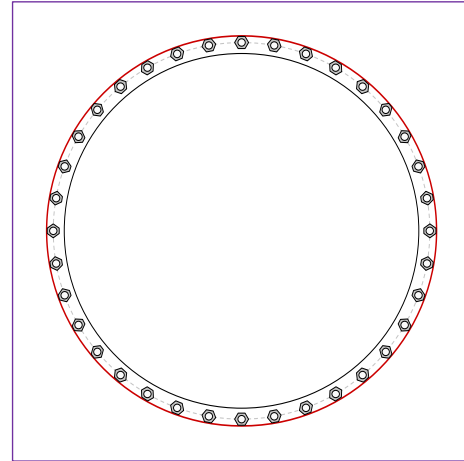

Connection Properties

Bolt Data

(36) 1" \emptyset bolts (A325 N; Fy=92 ksi, Fu=120 ksi) on 51" BC

Top Plate Data

54" OD x 1" Plate (A36; Fy=36 ksi, Fu=58 ksi)

Top Stiffener Data

N/A

Top Pole Data

48" x 0.55625" round pole (A53-B-42; Fy=42 ksi, Fu=63 ksi)

Bridge Stiffener Group 1 Data

(3) Bolted, 8.5"x1.25", A572-65, Lu=16", Neglect Flange in MOI: No

Bottom Plate Data

48" ID x 1.25" Plate (A36; Fy=36 ksi, Fu=58 ksi)

Bottom Stiffener Data

N/A

Bottom Pole Data

54" x 0.5875" round pole (A53-B-42; Fy=42 ksi, Fu=63 ksi)

Analysis Results

Bolt Capacity

Max Load (kips)	15.01
Allowable (kips)	54.53
Stress Rating:	26.2% Pass

Top Plate Capacity

Max Stress (ksi):	16.28	(Flexural)
Allowable Stress (ksi):	32.40	
Stress Rating:	47.8%	Pass
Tension Side Stress Rating:	15.0%	Pass

Bottom Plate Capacity

Max Stress (ksi):	8.84	(Flexural)
Allowable Stress (ksi):	32.40	
Stress Rating:	26.0%	Pass
Tension Side Stress Rating:	N/A	

Bridge Stiffener Group 1 Analysis Capacity

Max Compression (kip):	308.37
Max Tension (kip):	308.37
Comp. Capacity (kip):	515.61
Tens. Capacity (kip):	543.75 (Rupture)
Comp. Stress Rating:	57.0% Pass
Tens. Stress Rating:	54.0% Pass

Monopole Base Plate Connection



Site Info	
BU #	822765
Site Name	Branford (I-95/X55)
Order #	654626 Rev. 0

Analysis Considerations	
TIA-222 Revision	H
Grout Considered:	See Custom Sheet
I_{ar} (in)	See Custom Sheet

Applied Loads	
Moment (kip-ft)	2157.07
Axial Force (kips)	52.25
Shear Force (kips)	24.13

*TIA-222-H Section 15.5 Applied

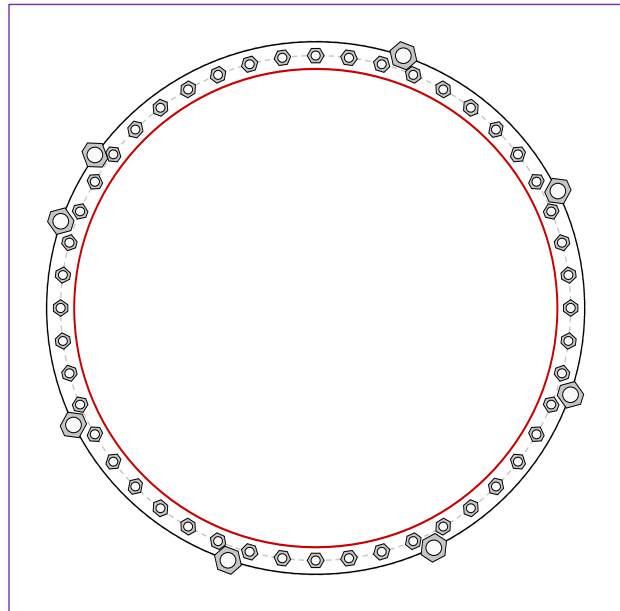

Connection Properties	Analysis Results										
Anchor Rod Data <hr/> GROUP 1: (48) 1" ϕ bolts (A687 N; $F_y=105$ ksi, $F_u=125$ ksi) on 57" BC GROUP 2: (8) 1-3/4" ϕ bolts (A193 Gr. B7 N; $F_y=105$ ksi, $F_u=125$ ksi) on 60.25" BC <i>pos. (deg): 26, 71, 145, 161, 206, 251, 296, 341</i>	Anchor Rod Summary <i>(units of kips, kip-in)</i> <hr/> GROUP 1: <table style="width: 100%; border-collapse: collapse;"> <tr> <td style="width: 33%;">Pu_t = 24.33</td> <td style="width: 33%;">$\phi Pn_t = 56.81$</td> <td style="width: 33%; text-align: right;">Stress Rating</td> </tr> <tr> <td>Vu = 0.5</td> <td>$\phi Vn = 36.82$</td> <td style="text-align: right;">40.8%</td> </tr> <tr> <td>Mu = n/a</td> <td>$\phi Mn = n/a$</td> <td style="text-align: right; color: green;">Pass</td> </tr> </table>		Pu_t = 24.33	$\phi Pn_t = 56.81$	Stress Rating	Vu = 0.5	$\phi Vn = 36.82$	40.8%	Mu = n/a	$\phi Mn = n/a$	Pass
Pu_t = 24.33	$\phi Pn_t = 56.81$	Stress Rating									
Vu = 0.5	$\phi Vn = 36.82$	40.8%									
Mu = n/a	$\phi Mn = n/a$	Pass									
Base Plate Data <hr/> 60.125" OD x 1" Plate (A36; $F_y=36$ ksi, $F_u=58$ ksi)	GROUP 2: <table style="width: 100%; border-collapse: collapse;"> <tr> <td style="width: 33%;">Pu_t = 83.93</td> <td style="width: 33%;">$\phi Pn_t = 178.13$</td> <td style="width: 33%; text-align: right;">Stress Rating</td> </tr> <tr> <td>Vu = 0</td> <td>$\phi Vn = 112.75$</td> <td style="text-align: right;">44.9%</td> </tr> <tr> <td>Mu = n/a</td> <td>$\phi Mn = n/a$</td> <td style="text-align: right; color: green;">Pass</td> </tr> </table>		Pu_t = 83.93	$\phi Pn_t = 178.13$	Stress Rating	Vu = 0	$\phi Vn = 112.75$	44.9%	Mu = n/a	$\phi Mn = n/a$	Pass
Pu_t = 83.93	$\phi Pn_t = 178.13$	Stress Rating									
Vu = 0	$\phi Vn = 112.75$	44.9%									
Mu = n/a	$\phi Mn = n/a$	Pass									
Stiffener Data <hr/> N/A	Base Plate Summary <hr/> <table style="width: 100%; border-collapse: collapse;"> <tr> <td style="width: 33%;">Max Stress (ksi):</td> <td style="width: 33%;">29.14</td> <td style="width: 33%; text-align: right;">(Flexural)</td> </tr> <tr> <td>Allowable Stress (ksi):</td> <td>32.4</td> <td></td> </tr> <tr> <td>Stress Rating:</td> <td>85.7%</td> <td style="text-align: right; color: green;">Pass</td> </tr> </table>		Max Stress (ksi):	29.14	(Flexural)	Allowable Stress (ksi):	32.4		Stress Rating:	85.7%	Pass
Max Stress (ksi):	29.14	(Flexural)									
Allowable Stress (ksi):	32.4										
Stress Rating:	85.7%	Pass									
Pole Data <hr/> 54" x 0.4875" round pole (A53-B-42; $F_y=42$ ksi, $F_u=63$ ksi)											

CCIplate

Elevation (ft) | 0 (Base)

note: Bending interaction not considered when Grout Considered = "Yes"

Bolt Group	Resist Axial	Resist Shear	Induce Plate Bending	Grout Considered	Apply at BARB Elevation	BARB CL Elevation (ft)
1	Yes	Yes	Yes	Yes	No	
2	No	No	No	Yes	No	

Custom Bolt Connection										
Bolt	Bolt Group ID	Location (deg.)	Diameter (in)	Material	Bolt Circle (in)	Eta Factor, η :	I_{ar} (in):	Thread Type	Area Override, in ²	Tension Only
1	1	0	1	A687	57	0.5	2.5	N-Included		No
2	1	7.5	1	A687	57	0.5	2.5	N-Included		No
3	1	15	1	A687	57	0.5	2.5	N-Included		No
4	1	22.5	1	A687	57	0.5	2.5	N-Included		No
5	1	30	1	A687	57	0.5	2.5	N-Included		No
6	1	37.5	1	A687	57	0.5	2.5	N-Included		No
7	1	45	1	A687	57	0.5	2.5	N-Included		No
8	1	52.5	1	A687	57	0.5	2.5	N-Included		No
9	1	60	1	A687	57	0.5	2.5	N-Included		No
10	1	67.5	1	A687	57	0.5	2.5	N-Included		No
11	1	75	1	A687	57	0.5	2.5	N-Included		No
12	1	82.5	1	A687	57	0.5	2.5	N-Included		No
13	1	90	1	A687	57	0.5	2.5	N-Included		No
14	1	97.5	1	A687	57	0.5	2.5	N-Included		No
15	1	105	1	A687	57	0.5	2.5	N-Included		No
16	1	112.5	1	A687	57	0.5	2.5	N-Included		No
17	1	120	1	A687	57	0.5	2.5	N-Included		No
18	1	127.5	1	A687	57	0.5	2.5	N-Included		No
19	1	135	1	A687	57	0.5	2.5	N-Included		No
20	1	142.5	1	A687	57	0.5	2.5	N-Included		No
21	1	150	1	A687	57	0.5	2.5	N-Included		No
22	1	157.5	1	A687	57	0.5	2.5	N-Included		No
23	1	165	1	A687	57	0.5	2.5	N-Included		No
24	1	172.5	1	A687	57	0.5	2.5	N-Included		No
25	1	180	1	A687	57	0.5	2.5	N-Included		No
26	1	187.5	1	A687	57	0.5	2.5	N-Included		No
27	1	195	1	A687	57	0.5	2.5	N-Included		No
28	1	202.5	1	A687	57	0.5	2.5	N-Included		No
29	1	210	1	A687	57	0.5	2.5	N-Included		No
30	1	217.5	1	A687	57	0.5	2.5	N-Included		No
31	1	225	1	A687	57	0.5	2.5	N-Included		No
32	1	232.5	1	A687	57	0.5	2.5	N-Included		No
33	1	240	1	A687	57	0.5	2.5	N-Included		No
34	1	247.5	1	A687	57	0.5	2.5	N-Included		No
35	1	255	1	A687	57	0.5	2.5	N-Included		No
36	1	262.5	1	A687	57	0.5	2.5	N-Included		No
37	1	270	1	A687	57	0.5	2.5	N-Included		No
38	1	277.5	1	A687	57	0.5	2.5	N-Included		No
39	1	285	1	A687	57	0.5	2.5	N-Included		No
40	1	292.5	1	A687	57	0.5	2.5	N-Included		No
41	1	300	1	A687	57	0.5	2.5	N-Included		No
42	1	307.5	1	A687	57	0.5	2.5	N-Included		No
43	1	315	1	A687	57	0.5	2.5	N-Included		No
44	1	322.5	1	A687	57	0.5	2.5	N-Included		No
45	1	330	1	A687	57	0.5	2.5	N-Included		No
46	1	337.5	1	A687	57	0.5	2.5	N-Included		No
47	1	345	1	A687	57	0.5	2.5	N-Included		No
48	1	352.5	1	A687	57	0.5	2.5	N-Included		No
49	2	26	1.75	A193 Gr. B7	60.25	0.5	1.75	N-Included		No
50	2	71	1.75	A193 Gr. B7	60.25	0.5	1.75	N-Included		No
51	2	145	1.75	A193 Gr. B7	60.25	0.5	1.75	N-Included		No
52	2	161	1.75	A193 Gr. B7	60.25	0.5	1.75	N-Included		No
53	2	206	1.75	A193 Gr. B7	60.25	0.5	1.75	N-Included		No
54	2	251	1.75	A193 Gr. B7	60.25	0.5	1.75	N-Included		No
55	2	296	1.75	A193 Gr. B7	60.25	0.5	1.75	N-Included		No
56	2	341	1.75	A193 Gr. B7	60.25	0.5	1.75	N-Included		No

Plot Graphic

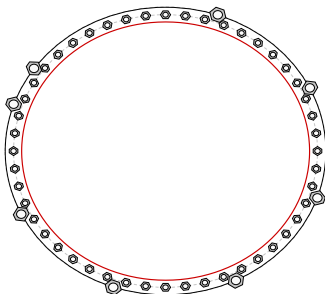

Drilled Pier Foundation

BU # :	822765
Site Name:	Branford / I-95 / X55
Order Number:	654626 Rev. 0
TIA-222 Revison:	H
Tower Type:	Monopole



Applied Loads		
	Comp.	Uplift
Moment (kip-ft)	2157.07	
Axial Force (kips)	52.26	
Shear Force (kips)	24.12	

Material Properties	
Concrete Strength, f _c :	4 ksi
Rebar Strength, F _y :	60 ksi
Tie Yield Strength, F _y :	60 ksi

Pier Design Data	
Depth	21 ft
Ext. Above Grade	0.5 ft
Pier Section 1	
<i>From 0.5' above grade to 21' below grade</i>	
Pier Diameter	6 ft
Rebar Quantity	24
Rebar Size	9
Clear Cover to Ties	3 in
Tie Size	5
Tie Spacing	18 in

Rebar & Pier Options

Embedded Pole Inputs

Belled Pier Inputs

Analysis Results

Soil Lateral Check	Compression	Uplift
D _{v=0} (ft from TOC)	5.69	-
Soil Safety Factor	2.51	-
Max Moment (kip-ft)	2323.16	-
Rating*	50.4%	-

Soil Vertical Check	Compression	Uplift
Skin Friction (kips)	387.07	-
End Bearing (kips)	254.47	-
Weight of Concrete (kips)	109.42	-
Total Capacity (kips)	641.54	-
Axial (kips)	161.68	-
Rating*	24.0%	-

Reinforced Concrete Flexure	Compression	Uplift
Critical Depth (ft from TOC)	5.67	-
Critical Moment (kip-ft)	2323.16	-
Critical Moment Capacity	3403.00	-
Rating*	65.0%	-

Reinforced Concrete Shear	Compression	Uplift
Critical Depth (ft from TOC)	15.97	-
Critical Shear (kip)	322.80	-
Critical Shear Capacity	489.91	-
Rating*	62.8%	-

Structural Foundation Rating*	65.0%
Soil Interaction Rating*	50.4%

*Rating per TIA-222-H Section 15.5

Check Limitation	
Apply TIA-222-H Section 15.5:	<input checked="" type="checkbox"/>
N/A	<input type="checkbox"/>
Additional Longitudinal Rebar	
Input Effective Depths (else Actual):	<input type="checkbox"/>
Shear Design Options	
Check Shear along Depth of Pier:	<input checked="" type="checkbox"/>
Utilize Shear-Friction Methodology:	<input type="checkbox"/>
Override Critical Depth:	<input type="checkbox"/>

[Go to Soil Calculations](#)

Soil Profile

Groundwater Depth	N/A	# of Layers	3
-------------------	-----	-------------	---

Layer	Top (ft)	Bottom (ft)	Thickness (ft)	Y _{soil} (pcf)	Y _{concrete} (pcf)	Cohesion (ksf)	Angle of Friction (degrees)	Calculated Ultimate Skin Friction Comp (ksf)	Calculated Ultimate Skin Friction Uplift (ksf)	Ultimate Skin Friction Comp Override (ksf)	Ultimate Skin Friction Uplift Override (ksf)	Ult. Gross Bearing Capacity (ksf)	SPT Blow Count	Soil Type
1	0	3.333	3.333	120	150	0	0	0.000	0.000	0.00	0.00			Cohesionless
2	3.333	11	7.667	120	150	0	34	0.979	0.979				65	Cohesionless
3	11	21	10	150	150	0	33	1.987	1.987			12	100	Cohesionless

ASCE 7 Hazards Report

Address:
No Address at This Location

Standard: ASCE/SEI 7-16
Risk Category: II
Soil Class: D - Default (see Section 11.4.3)

Elevation: 56.16 ft (NAVD 88)
Latitude: 41.293933
Longitude: -72.785706

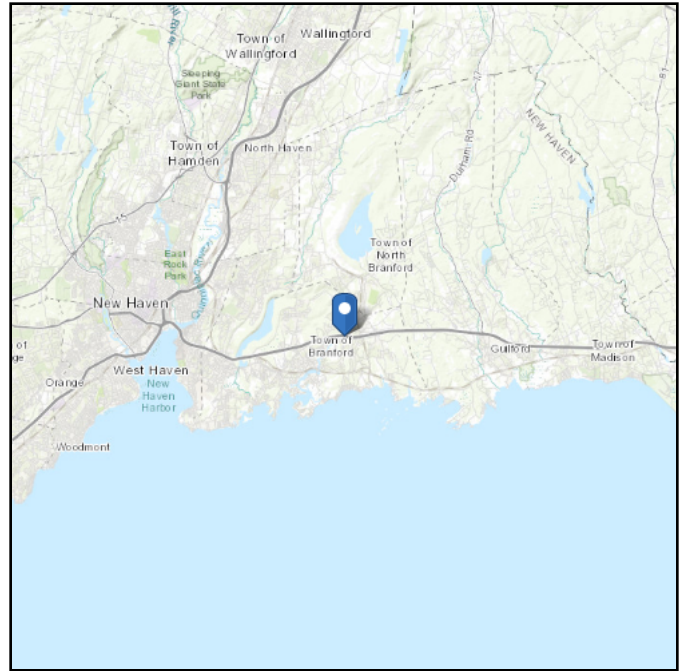
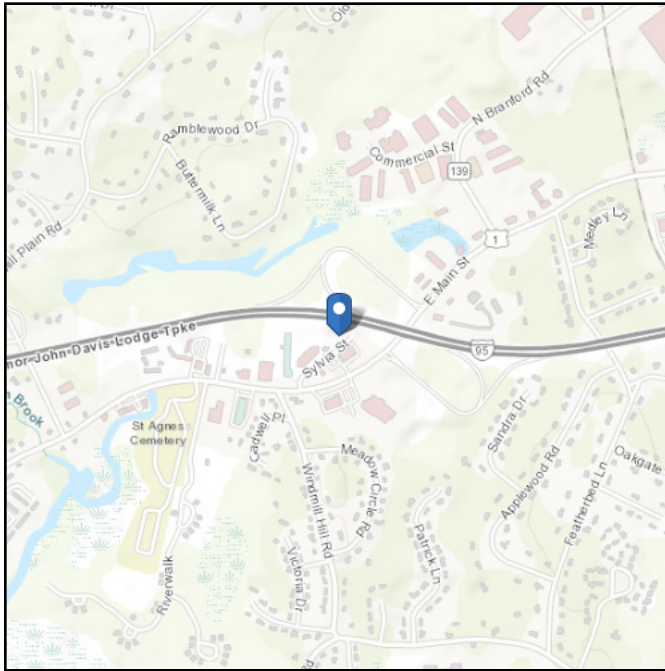

Wind

Results:

Wind Speed	122 Vmph
10-year MRI	75 Vmph
25-year MRI	85 Vmph
50-year MRI	93 Vmph
100-year MRI	99 Vmph

Data Source: ASCE/SEI 7-16, Fig. 26.5-1B and Figs. CC.2-1–CC.2-4, and Section 26.5.2
Date Accessed: Mon Apr 25 2022

Value provided is 3-second gust wind speeds at 33 ft above ground for Exposure C Category, based on linear interpolation between contours. Wind speeds are interpolated in accordance with the 7-16 Standard. Wind speeds correspond to approximately a 7% probability of exceedance in 50 years (annual exceedance probability = 0.00143, MRI = 700 years).

Site is in a hurricane-prone region as defined in ASCE/SEI 7-16 Section 26.2. Glazed openings need not be protected against wind-borne debris.

Site Soil Class: D - Default (see Section 11.4.3)

Results:

S_s :	0.202	S_{D1} :	0.086
S_1 :	0.054	T_L :	6
F_a :	1.6	PGA :	0.113
F_v :	2.4	PGA _M :	0.178
S_{MS} :	0.324	F_{PGA} :	1.574
S_{M1} :	0.129	I_e :	1
S_{DS} :	0.216	C_v :	0.704

Seismic Design Category B

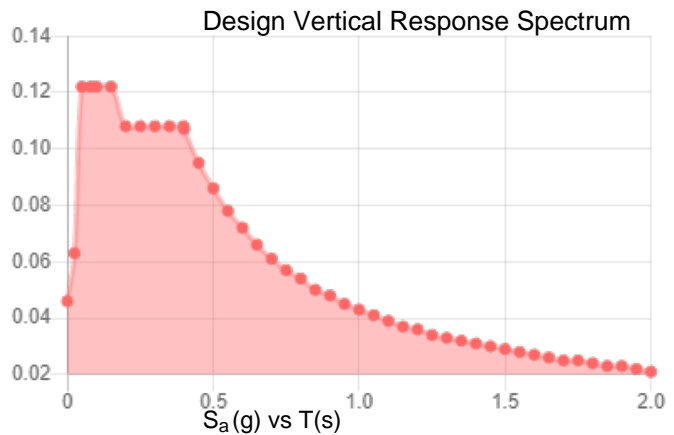
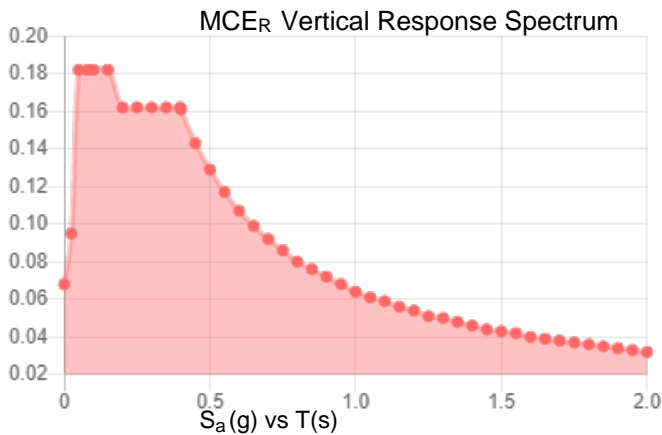
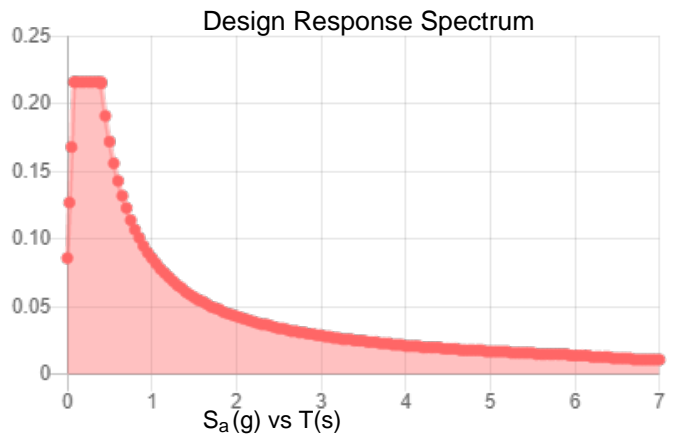
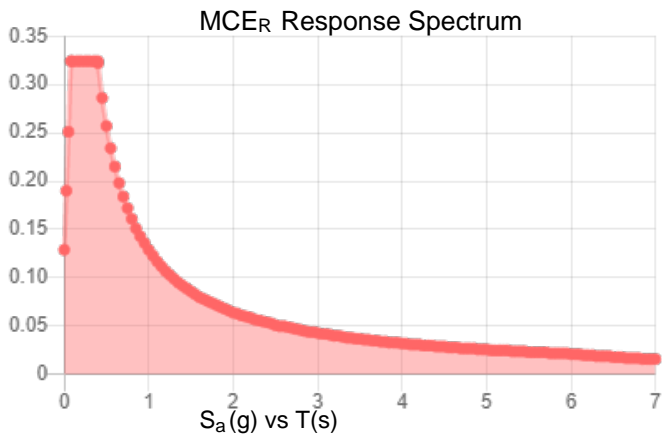

Data Accessed: Mon Apr 25 2022

Date Source:

USGS Seismic Design Maps based on ASCE/SEI 7-16 and ASCE/SEI 7-16 Table 1.5-2. Additional data for site-specific ground motion procedures in accordance with ASCE/SEI 7-16 Ch. 21 are available from USGS.

Ice

Results:

Ice Thickness: 1.00 in.
Concurrent Temperature: 15 F
Gust Speed 50 mph

Data Source: Standard ASCE/SEI 7-16, Figs. 10-2 through 10-8

Date Accessed: Mon Apr 25 2022

Ice thicknesses on structures in exposed locations at elevations higher than the surrounding terrain and in valleys and gorges may exceed the mapped values.

Values provided are equivalent radial ice thicknesses due to freezing rain with concurrent 3-second gust speeds, for a 500-year mean recurrence interval, and temperatures concurrent with ice thicknesses due to freezing rain. Thicknesses for ice accretions caused by other sources shall be obtained from local meteorological studies. Ice thicknesses in exposed locations at elevations higher than the surrounding terrain and in valleys and gorges may exceed the mapped values.

The ASCE 7 Hazard Tool is provided for your convenience, for informational purposes only, and is provided “as is” and without warranties of any kind. The location data included herein has been obtained from information developed, produced, and maintained by third party providers; or has been extrapolated from maps incorporated in the ASCE 7 standard. While ASCE has made every effort to use data obtained from reliable sources or methodologies, ASCE does not make any representations or warranties as to the accuracy, completeness, reliability, currency, or quality of any data provided herein. Any third-party links provided by this Tool should not be construed as an endorsement, affiliation, relationship, or sponsorship of such third-party content by or from ASCE.

ASCE does not intend, nor should anyone interpret, the results provided by this Tool to replace the sound judgment of a competent professional, having knowledge and experience in the appropriate field(s) of practice, nor to substitute for the standard of care required of such professionals in interpreting and applying the contents of this Tool or the ASCE 7 standard.

In using this Tool, you expressly assume all risks associated with your use. Under no circumstances shall ASCE or its officers, directors, employees, members, affiliates, or agents be liable to you or any other person for any direct, indirect, special, incidental, or consequential damages arising from or related to your use of, or reliance on, the Tool or any information obtained therein. To the fullest extent permitted by law, you agree to release and hold harmless ASCE from any and all liability of any nature arising out of or resulting from any use of data provided by the ASCE 7 Hazard Tool.