



STATE OF CONNECTICUT

CONNECTICUT SITING COUNCIL

Ten Franklin Square
New Britain, Connecticut 06051
Phone: (860) 827-2935
Fax: (860) 827-2950

February 4, 2000

Sandy M. Carter, Manager - Regulatory
Bell Atlantic Mobile
20 Alexander Drive
P.O. Box 5029
Wallingford, CT 06492

RE: TS-BAM-013-000114 - Bell Atlantic Mobile request for an order to approve tower sharing at an existing telecommunications facility located at 3 Polly Lane in Bozrah, Connecticut.

Dear Ms. Carter:

At a public meeting held February 2, 2000, the Connecticut Siting Council (Council) ruled that the shared use of this existing tower site is technically, legally, environmentally, and economically feasible and meets public safety concerns, and therefore, in compliance with General Statutes § 16-50aa, the Council has ordered the shared use of this facility to avoid the unnecessary proliferation of tower structures.

This facility has been carefully modeled to ensure that radio frequency emissions are conservatively below State and federal standards applicable to the frequencies now used on this tower. Any additional change to this facility will require an explicit request to this agency pursuant to § 16-50aa or notice pursuant to Regulations of Connecticut State Agencies Section 16-50j-73, as applicable. Such request or notice shall include all relevant information regarding the proposed change with cumulative worst-case modeling of radio frequency exposure at the closest point uncontrolled access to the tower base, consistent with Federal Communications Commission, Office of Engineering and Technology, Bulletin 65. Any deviation from this format may result in the Council implementing enforcement proceedings pursuant to General Statutes § 16-50u including, without limitation, imposition of expenses resulting from such failure and of civil penalties in an amount not less than one thousand dollars per day for each day of construction or operation in material violation.

This decision applies only to this request for tower sharing and is not applicable to any other request or construction.

The proposed shared use is to be implemented as specified in your letter dated January 14, 2000.

Thank you for your attention and cooperation.

Very truly yours,

Mortimer A. Gelston
Chairman

MAG/SLL/sll

- c: Honorable Keith J. Robbins, First Selectman, Town of Bozrah
- Steve Kotfila, Site Development Manager, Sprint PCS
- Ronald C. Clark, Manager – Real Estate, Nextel Communications
- J. Brendan Sharkey, Esq., Omnipoint Communications
- Peter W. van Wilgen, Director of Real Estate Operations, SNET Wireless, Inc.



STATE OF CONNECTICUT
CONNECTICUT SITING COUNCIL

Ten Franklin Square
New Britain, Connecticut 06051
Phone: (860) 827-2935
Fax: (860) 827-2950

January 20, 2000

Honorable Keith J. Robbins
First Selectman
Town of Bozrah
Town Hall
1 River Road
Bozrah, CT 06334-0158

RE: TS-BAM-013-000114 – Bell Atlantic Mobile request for an order to approve tower sharing at an existing telecommunications facility located at 3 Polly Lane in Bozrah, Connecticut.

Dear Mr. Robbins:

The Connecticut Siting Council (Council) received this request for tower sharing, pursuant to Connecticut General Statutes § 16-50aa.

The Council will consider this item at the next meeting scheduled for Wednesday, February 2, 2000, at 1:30 p.m. in Hearing Room One, Ten Franklin Square, New Britain, Connecticut.

Please call me or inform the Council if you have any questions or comments regarding this proposal.

Thank you for your cooperation and consideration.

Very truly yours,

A handwritten signature in black ink, appearing to read "Joel M. Rinebold".

Joel M. Rinebold
Executive Director

JMR/jlh

Enclosure: Notice of Tower Sharing

Bell Atlantic Mobile

20 Alexander Drive
P.O. Box 5029
Wallingford, CT 06492-2430
203-269-8858

RECEIVED

JAN 14 2000

CONNECTICUT
SITING COUNCIL



January 14, 2000

Mr. Mortimer A. Gelston, Chairman
Connecticut Siting Council
10 Franklin Square
New Britain, Connecticut 06051

Re: Request by Cellco Partnership d/b/a Bell Atlantic Mobile for an Order to Approve the Shared Use of a Tower Facility located at 3 Polly Lane, Bozrah, Connecticut.

Dear Chairman Gelston:

Pursuant to Connecticut General Statutes (C.G.S.) Sec. 16-50aa, Cellco Partnership d/b/a Bell Atlantic Mobile ("BAM") hereby requests an order from the Connecticut Siting Council ("Council") to approve the proposed shared use by BAM of an existing tower located at 3 Polly Lane, Bozrah, Connecticut. The property is owned by Mrs. Alice Maynard of Colchester, Connecticut and managed by Cordless Data Transfer, Inc. of Marlborough, Connecticut. As shown on the attached drawing and as further described below, BAM proposes to install antennas on the existing tower and to locate an equipment shelter at the base of the tower. BAM requests that the Council finds that the proposed shared use of the tower facility satisfy the criteria stated in C.G.S. Sec. 16-50aa, and to issue an order approving the proposed shared use.

Background

BAM is licensed by the Federal Communications Commission to provide cellular telephone service in the New London County New England County Metropolitan Area (NECMA), which includes the area to be served by the proposed Bozrah installation.

The facility at 3 Polly Lane in Bozrah, consists of a 180 foot AGL guyed tower built by Cordless Data Transfer, Inc. and located on a leased parcel. The guyed tower supports the antennas of Nextel Communications, Omnipoint Communications, Sprint Spectrum PCS, and the proposed antennas of Springwich Cellular Limited Partnership which provide mobile communications service to the public pursuant to their FCC licenses. BAM and Cordless Data Transfer, Inc. have agreed to the proposed shared use of this tower pursuant to mutually acceptable terms and conditions. Cordless Data Transfer, Inc. has authorized BAM to apply for all necessary permits, approvals and authorizations which may be required for the proposed shared use of this facility.

BAM proposes to install twelve (12) Decibel Model DB844H90N antennas, approximately 48 inches in height, on a platform with their center of radiation at approximately 138 feet above ground level (“AGL”). BAM will also install one (1) GPS antenna on their building. Equipment associated with these antennas, as well as a 40 KW diesel-fueled emergency stand-by generator, would be located in a new approximately 12-foot x 30-foot equipment building located at the base of the tower.

C.G.S. Sec. 16-50aa provides that, upon written request for approval of a proposed shared use, “if the Council finds that the proposed shared use of the facility is technically, legally, environmentally and economically feasible and meets public safety concerns, the Council shall issue an order approving such shared use” (C.G.S. Sec. 16-50aa(c)(1).)

Discussion

A. Technical Feasibility. The existing tower is structurally sound and capable of supporting the proposed BAM antennas. The tower will not require any structural modification to support the proposed attachments. A copy of the structural design is attached to this application. BAM engineers have determined that the proposed antenna installations present minimal potential for interference to or from existing radio transmissions from this location. In addition, the applicant is unaware of any occasion where its operations have caused interference with AM, FM or television reception. The proposed shared use of this tower therefore is technically feasible.

B. Legal Feasibility. Under C.G.S. Sec. 16-50aa, the Council has been authorized to issue an order approving the proposed shared use of an existing communications tower facility such as the facility at 3 Polly Lane. (C.G.S. Sec. 16-50aa(c)(1).) This authority complements the Council’s prior-existing authority under C.G.S. Sec. 16-50p to issue orders approving the construction of new towers that are subject to the Council’s jurisdiction. C.G.S. Sec. 16-50x(a) directs the Council to “give consideration to other state laws and municipal regulations as it shall deem appropriate” in ruling on requests for the shared use of existing tower facilities. Under the authority vested in the Council by C.G.S. Sec. 16-50aa, an order by the Council approving the shared use would permit the applicant to obtain a building permit for the proposed installations.

C. Environmental Feasibility. The proposed shared use would have a minimal environmental effect, for the following reasons:

1. The proposed installations would have an insignificant incremental visual impact, and would not cause any significant change or alteration in the physical or environmental characteristics of the existing site. The addition of the proposed antennas would not increase the height of the tower, and would not extend the boundaries of the tower site, including the placement of the equipment building near the base of the existing tower.

2. The proposed installation would not increase the noise levels at the existing facility by six decibels or more. The only additional noise will occur during emergency use or periodic exercising of the generator.

3. Operation of the additional antennas will not increase the total radio frequency electromagnetic radiation power density, measured at the tower base to a level at or above the applicable standard. "Worst-case" exposure calculations for a point at the base of the tower in relation to operation of each of the various carriers' antenna arrays are as follows:

	<u>Applicable ANSI Stnd</u>	<u>Calculated "Worst-Case"</u>	<u>Percentage of Stnd.</u>
BAM	0.583 mW/cm2	0.0359 mW/cm2	6.15%
Nextel	0.5673 mW/cm2	0.0228 mW/cm2	4.02%
Omnipoint	1.000 mW/cm2	.0111 mW/cm2	1.11%
SCLP	0.5867 mW/cm2	0.0290 mW/cm2	3.32%
Sprint	1.000 mW/cm2	0.0245 mW/cm2	<u>2.45%</u>
		Total	17.05%

The collective "worst-case" exposure would be only 17.05% of the ANSI standard, as calculated for mixed frequency sites. Power density levels from shared use of the tower facility would thus be well below applicable ANSI standards.

4. The proposed installations would not require any water or sanitary facilities, or generate discharges to water bodies. Operation of the emergency back-up generator will result in limited air emissions; pursuant to R.C.S.A. Section 22a-174-3, the generator will require the issuance of a permit from the Department of Environmental Protection Bureau of Air Management. After construction is complete, the proposed installation would not generate any traffic other than periodic maintenance visits.

The proposed use of this facility would therefore have a minimal environmental effect, and is environmentally feasible.

D. Economic Feasibility. As previously mentioned, the tower owner and the applicant have entered into a mutual agreement to share use of the existing tower on terms agreeable to the parties, and the proposed tower sharing is thus economically feasible.

E. Public Safety Concerns. As stated above, the existing tower is structurally capable of supporting the proposed BAM antennas. The Applicant is not aware of any other public safety concerns relative to the proposed tower sharing of the existing tower. In fact, the provision of new or improved cellular phone service in the Bozrah area, especially along the heavily traveled Routes 2 and 87 and surrounding area, through shared use of the tower is expected to enhance the safety and welfare of area residents and travelers. The public safety benefits of wireless service are further illustrated by the decision of local authorities elsewhere in Connecticut to provide cellular phones to residents to improve local public safety and emergency communications. The proposed shared use of this facility would likewise improve public safety in the Bozrah area.

Conclusion

For the reasons discussed above, the proposed shared use of the existing telecommunications tower facility at 3 Polly Lane satisfies the criteria stated in C.G.S. Sec. 16-50aa, and advances the General Assembly's and the Council's goal of preventing the proliferation of towers in Connecticut. The Applicant therefore requests that the Council issue an order approving the proposed shared use.

Mr. Mortimer A. Gelston
January 14, 2000
Page 5

Thank you for your consideration of this matter.

Pursuant to Connecticut General Statutes Sec. 16-50v and Section 16-50v-1(a) of the Regulations of Connecticut State Agencies, BAM has enclosed a check in the amount of \$500.00 for the required filing fee.

Respectfully yours,

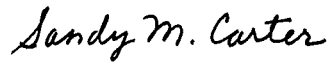

Sandy M. Carter
Manager – Regulatory
Bell Atlantic Mobile

Attachments

cc: Keith J. Robbins, First Selectman

© Bell Atlantic Mobile

20 Alexander Drive
P.O. Box 5029
Wallingford, CT 06492-2430
203-269-8858



January 14, 2000

Honorable Keith J. Robbins
First Selectman
Town Hall
1 River Road
Bozrah, Connecticut 06334

Dear Mr. Barber:

This letter is to inform you that Cellco Partnership d/b/a Bell Atlantic Mobile plans to install antennas and associated equipment at the existing tower facility located at 3 Polly Lane, Bozrah, Connecticut. I am enclosing a copy of Bell Atlantic Mobile's tower sharing application to the Connecticut Siting Council.

The application fully sets forth the Company's proposal. However, if you have any questions or require further information on our plans or the Siting Council's procedures, please contact me at (203) 294-8519 or Mr. Joel Rinebold, Executive Director of the Connecticut Siting Council at (860) 827-2935.

Sincerely,

Sandy M. Carter
Sandy M. Carter
Manager - Regulatory

Enclosure



Ideal for cellular and trunking/ESMR applications, these high quality log periodics are now available from Decibel in four new models with 80 or 90 degree horizontal apertures. They're compact, lightweight, and provide an **unmatched front-to-back ratio of 40 dB**.

- **Less Wind Loading** - They measure only 24 or 48 inches (610 or 1219 mm) tall, 8.5 inches deep (216 mm), and 6 inches wide (152 mm). They weigh only 5 or 10 pounds.
- **Downtilt** - Electrical downtilt is available on all 4-foot models, 6°, 8°, 11°, 13°, or for mechanical downtilt, order DB5083 bracket.
- **Null-Fill** - Four-foot models provide null-fill and upper lobe suppression.
- **Most Stringent IM Test** - Each antenna is tested for the absence of IM with 16 carriers at 500 watts of composite power.
- **Sturdy Construction** - Made in the U.S. of high-strength aluminum alloy backs, brass elements and UV resistant ABS plastic radomes. No rivets are used!
- **Lightning Resistant** - All metal parts are grounded.
- **Terminations and Mounts** - All models are available with N-Female or 7/16 DIN connectors. DB380 pipe mount is included.

Ordering information - See table for models to fit your requirements.

**UPS
Shippable**

Models Available

Model*	DB842H80N-XY	DB844H80N-XY	DB842H90N-XY	DB844H90N-XY
Gain - dBd/dBi	10/12.1	13/15.1	9/11.1	12/14.1
F/B Ratio - dB	40	40	40	40
Horizontal beamwidth**	80°	80°	90°	90°
Vertical beamwidth**	30°	15°	30°	15°
Height - in. (mm)	24 (610)	48 (1219)	24 (610)	48 (1219)
Weight - lbs. (kg)	5 (2.3)	10 (4.6)	5 (2.3)	10 (4.6)
Shipping weight - lbs. (kg)	8 (3.6)	15 (6.8)	8 (3.6)	15 (6.8)

* For 7/16 DIN connectors substitute "E" for "N" in the model numbers. Example: DB842H80E-XY.

** 3 dB from maximum.

Side offset mounting bracket is included. For electrical downtilt of 6°, 8°, 11° or 13° add T6, T8, T11 or T13 before the "N" or "E" in any 4-foot model number. Example: DB844H80T6N-XY. Note: Electrical downtilt causes a gain loss of .05 dB, or, at the horizon, a reduction of 3, 6, 9 or 12 dB on downtilts of 6°, 8°, 11° or 13° respectively. For mechanical downtilt order DB5083 bracket.

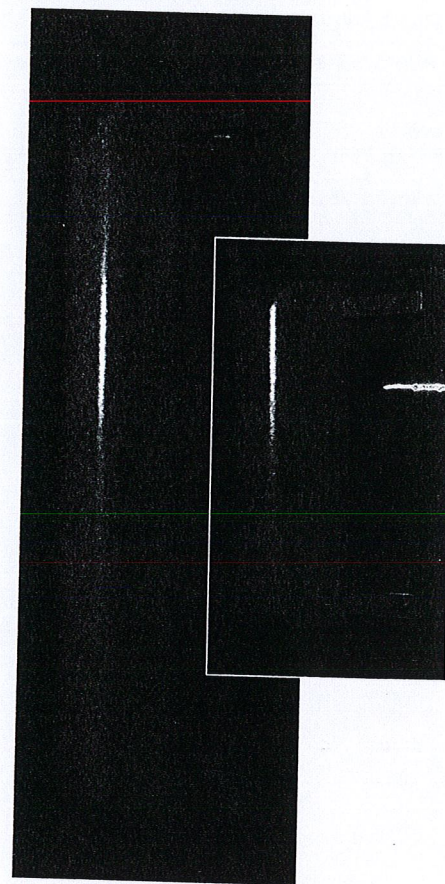

**Base Station
Antennas.**

4-Foot and 2-Foot dB DIRECTORS

**Typical DB842H90N-XY, DB844H90N-XY
Horizontal Pattern**

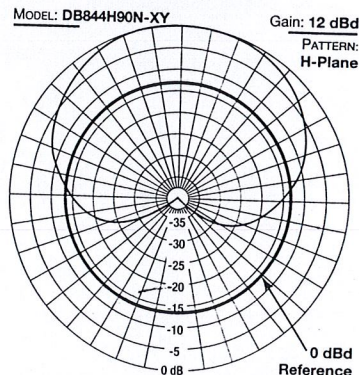

Typical DB844H90N-XY Vertical Pattern

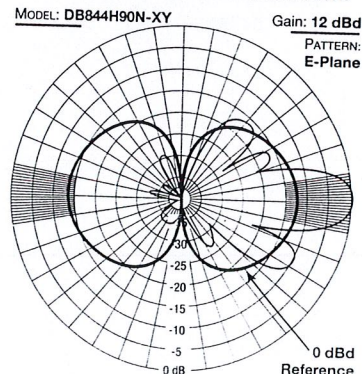

Typical DB842H80-XY Vertical Pattern

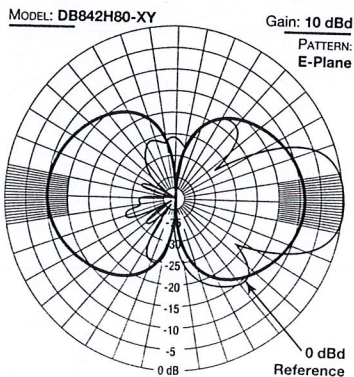

Mechanical Data

Width - in. (mm)	6 (152)
Depth - in. (mm)	8.5 (216)
Height	See table above
Maximum wind speed - mph (km/h)	125 (200)
Wind area - ft² (m²)	
24" (610 mm) antenna	1 (.093)
48" (1219 mm) antenna	2 (.186)
Wind load (at 100 mph/161 km/h) - lbf (N) / sq ft (m²)	
24" (610 mm) antenna	40 (178) 18
48" (1219 mm) antenna	80 (356) 36
Radome	Gray ABS
Backplate	Passivated aluminum
Radiators	Brass
Mounting hardware	Galvanized steel
Weight	See table above

Electrical Data

Frequency Range - MHz	806-960
Gain - dBd	See table above
Front-to-back ratio - dB	>40
Beamwidths	See table above
VSWR	<1.5:1
Null-fill and secondary lobe suppression	On 48" (1219 mm) models only
Maximum power input - watts	500
Nominal impedance - ohms	50
Lightning protection	All metal parts grounded
Termination	N-Female or 7/16 DIN





simulated
pipe mount
front eather
lower shaming
application

TS-BAM-013-000114
3 Polly Lane
Bozrah, CT
November 18, 1999 S. Levine

townno\013scip.jpg

**Cordless Data Transfer, Inc.
17 Ridgewood Drive
Marlborough, CT 06447**

November 17, 1999

Ms. Sandy Carter
Bell Atlantic Mobile
20 Alexander Drive
Wallingford, CT 06492

**RE: Existing Tower Facility
12 Polly Lane
Bozrah, CT**

Dear Ms. Carter:

Please be advised that Bell Atlantic Mobile is authorized to proceed in seeking Connecticut Council approval for the above referenced tower site owned by Cordless Data Transfer (CDT) located at Polly Lane, in Bozrah, Connecticut.

Sincerely,

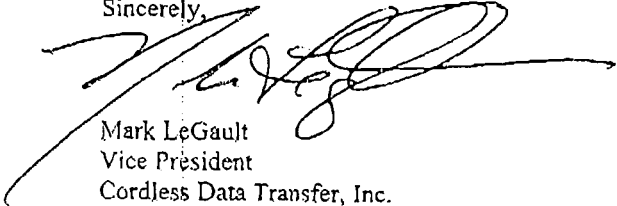

Mark LeGault
Vice President
Cordless Data Transfer, Inc.

Building Permit 900

TOWN OF BOZRAH

To CORDLESS DATA TRANSFER
MARLBOROUGH, CT
 For RADIO TOWER

11-22-97

Date

Dave Atkins

Building Official



FRED A. NUDD CORPORATION

1743 ROUTE 104, BOX 577
ONTARIO, NY 14519
(315) 524-2531 FAX (315) 524-4249

www.nuddtowers.com

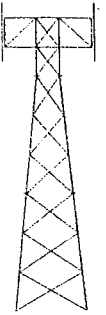

October 12, 1999

Wayne Lukachek
BELL ATLANTIC MOBILE
20 Alexander Dr.
Wallingford, CT 06492

RECEIVED

JAN 14 2000

CONNECTICUT
SITING COUNCIL

Wayne,

We have completed the analysis of the CDT - Bozrah tower and have found it adequate within the scope of this analysis to support the proposed antenna loading. The analysis was performed using 85-mph wind speed with 1/2" radial ice per EIA/TIA 222-F recommended standard.

The tower we analyzed is a 180' Nudd G42WPAR guyed supporting tower consisting of pipe legs and angle/rod bracing. Tower sections are all-welded with a face dimension of 42". Foundation capacities were predicated on original design criteria.

The antenna loading used in the analysis consisted of the existing antennas as well as the following antenna configuration:

QTY	Antenna	Elev.	T-Line	Status
12	DB844, (3) 12' Booms	138	1-5/8" Heliax	BAM Proposed

The results of the analysis showed all tower and foundation elements to be loaded within allowable limits.

If you have any questions concerning this analysis, please contact me.

Sincerely,

FRED A. NUDD CORPORATION

Patrick Botimer
Engineer

SYNOPSIS OF TOWER ANALYSIS

1. Wind loading conditions considered:

75% wind load with concurrent 1/2" ice.

100% wind with no ice.

Worst wind load case is wind with ice.

- | | |
|----------------------|------------|
| 2. Maximum Leg Load: | 80% loaded |
| 3. Tower Bracing: | 92% loaded |
| 4. Foundations: | 94% loaded |
| 5. Guy Cables: | 94% loaded |

PRIMARY ASSUMPTIONS USED IN THE ANALYSIS

1. Allowable steel stresses are defined by AISC-ASD 9th Edition.
2. All tower members adequately galvanized to prevent corrosion of steel members.
3. All proposed antenna mounts are modeled as Nudd manufactured.
4. No residual stresses due to incorrect tower erection.
5. All bolts are appropriately tightened providing the necessary connection continuity.
6. All welds conform to the requirements of AWS D1.1.
7. We have assumed an allowable wind speed of 85 mph per EIA/TIA 222-F standard for analysis purposes.
8. The acceptability of the analyzed antenna loading is the responsibility of BAM to confirm with the other carriers and tower owner.
9. Any deviation from the analyzed antenna loading will require a tower analysis for verification of structural integrity.
10. This analysis has been commissioned by Wayne Lukachek of Bell Atlantic Mobile who has provided information about the proposed antennas and location.

TOWER ANCHOR CONDITIONS
 This tower has been analyzed to conform to the requirements of ANSI/EIA/ITA 222-F recommended standard for 85 mph wind speed with 1/2" radiol ice. Worst case load condition is wind with ice with load reduction. Allowable steel stresses per AISC ASD 9th Edition. Allowable concrete stresses per ACI 318-89.

MATERIAL ASSUMPTIONS
 Tower Legs: ASTM A500-C, Fy > 60 ksi.
 All other Steel: ASTM A36, Fy > 36 ksi.
 Hardware: ASTM A325 Hot Dipped Galvanized Bolts with Anco Nuts.
 Galvanizing: ASTM A123.
 Guy Anchor Shaft: ASTM A36M, Fy > 45 ksi.
 ***Results of tower mast analysis: Pass
 ***Results of foundation analysis: Pass
 ***Results of cable analysis: Pass

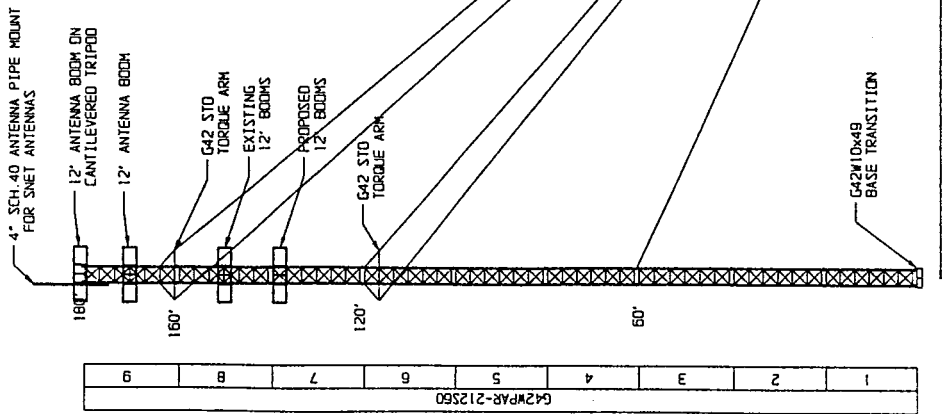

TOWER LOADING ASSUMPTIONS

QTY	Antenna	Windload	Deadload
3	ANSI E350-14	107	18
3	12' Cellular Boom	115	20
3	12' Cellular Boom	287	170
3	12' Cellular Boom	114	20
3	12' Cellular Boom	283	170
3	12' Cellular Boom	529	262
3	12' Cellular Boom	148	175
3	12' Cellular Boom	467	262
12	12' Cellular Boom	95	10
3	12' Cellular Boom	265	170

Elevation	Start	Stop	Windload	Deadload	K/ft
102	160	192	5.4	1.9	1.9
183	160	192	5.4	1.9	1.9
173	160	183	6.2	2.4	2.4
160	160	173	5.8	2.4	2.4
148	160	148	5.7	2.4	2.4
138	160	138	45.6	55.8	55.8
120	160	120	234.7	172.0	172.0
60	120	60	207.1	172.0	172.0
0	60	0	155.0	172.0	172.0

NOTE: Any deviation from the proposed design antenna loading will require a tower analysis for verification of structural integrity.

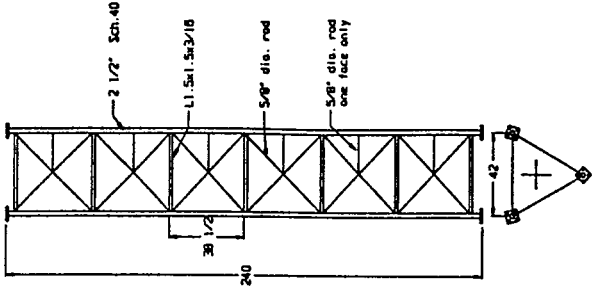

G42WPAR TOWER SECTION

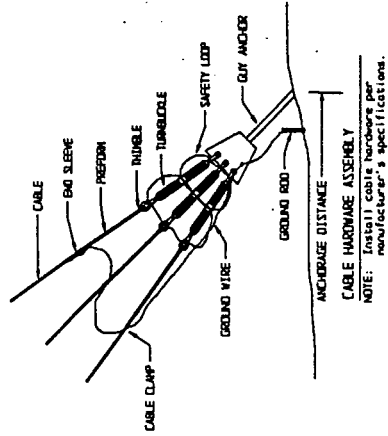

CABLE HARDWARE ASSEMBLY
 NOTE: Install cable hardware per manufacturer's specifications.

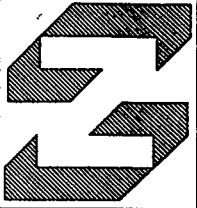

FRED A. NUDD CORPORATION
 Route 104-Danbury, New York 14519-315/524-2531
 SCALE: N/S
 DRAWING NO: 12/20/99
 PCB
 ANALYSIS OF 180' G42WPAR
 BLM
 GILMAN/BOZRAH, CT
 99-7358-1

GUY CABLE SCHEDULE

Cable	QTY/Type	Length	Turnbuckle	Preform	Thblt	Endsive Shckl
Cable 3	2 # 5/8x7 EHS	220'	1"x18" J-J	5/8" BG	3/4"	65268 3/4"
Cable 2	2 # 9/16x7 EHS	192'	7/8"x12" J-J	9/16" BG	3/4"	65267 3/4"
Cable 1	1 # 9/16x7 EHS	161'	7/8"x12" J-J	9/16" BG	3/4"	65267 3/4"

NOTE: Cable lengths assume anchors at elevation 0'. Cable lengths and anchor layout must compensate for site topography.

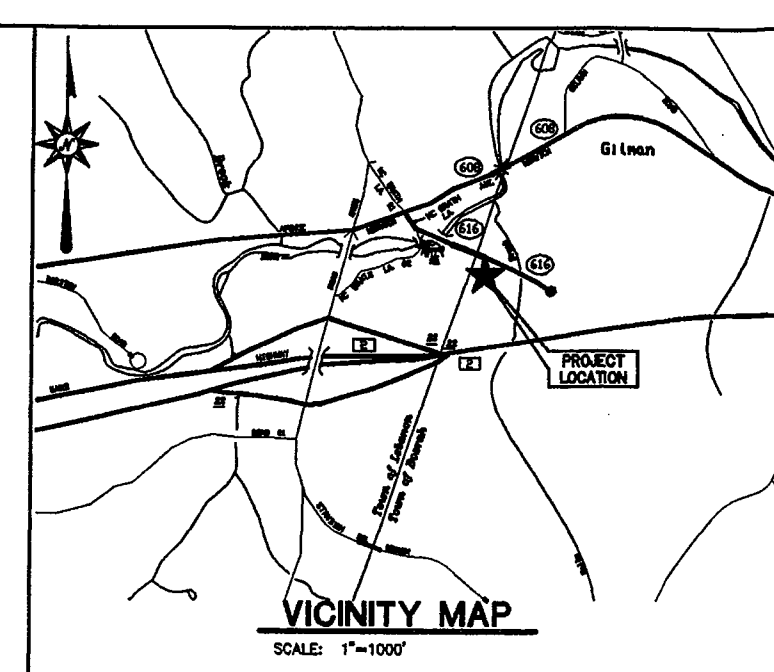
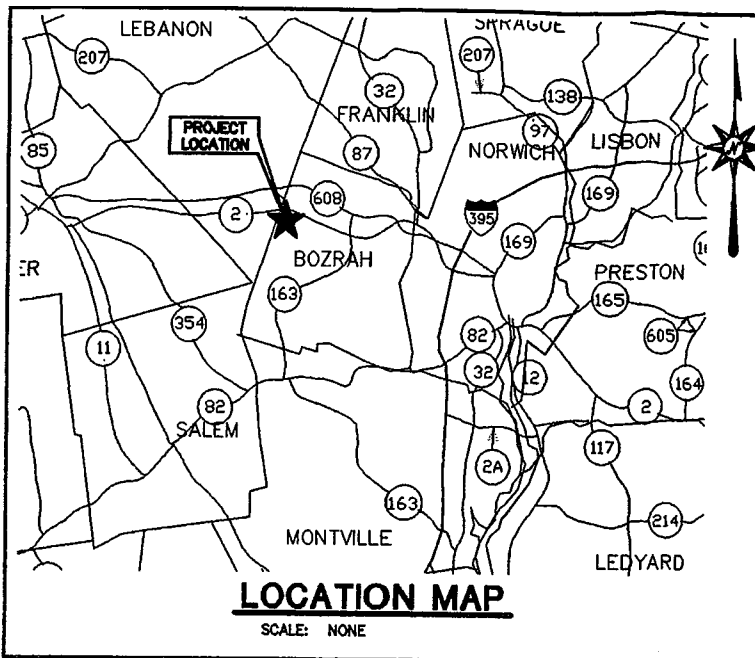

SITING COUNCIL SUBMISSION

GILMAN

TELECOMMUNICATION FACILITY

3 POLLY ROAD
BOZRAH, CONNECTICUT

PREPARED FOR:
BELL ATLANTIC MOBILE
20 ALEXANDER DRIVE
WALLINGFORD, CONNECTICUT 06492

CONTENTS

TITLE SHEET
SC-1 SITE PLAN AND ELEVATION

PREPARED BY:



ARCHITECTURE ENGINEERING PLANNING LANDSCAPE ARCHITECTURE
LAND SURVEYING ENVIRONMENTAL SCIENCES ANALYTICAL SERVICES

355 RESEARCH PARKWAY
MERIDEN, CONNECTICUT 06450
(203) 630-1406
(203) 630-2615 Fax

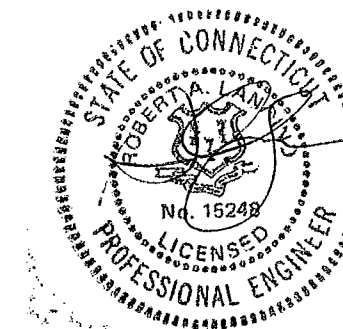

DATES

ISSUE DATE: JANUARY 12, 2000
REVISION:



Companies

ARCHITECTURE
ENGINEERING
PLANNING
LANDSCAPE ARCHITECTURE
LAND SURVEYING
ENVIRONMENTAL SCIENCES
ANALYTICAL SERVICES

335 Research Parkway
Meriden, CT 06450
(203) 630-1408
(203) 630-2816 Fax

SITE PLAN AND ELEVATION
GILMAN TELECOMMUNICATION FACILITY
3 POLLY ROAD
BOZRAH, NEW LONDON COUNTY, CONNECTICUT

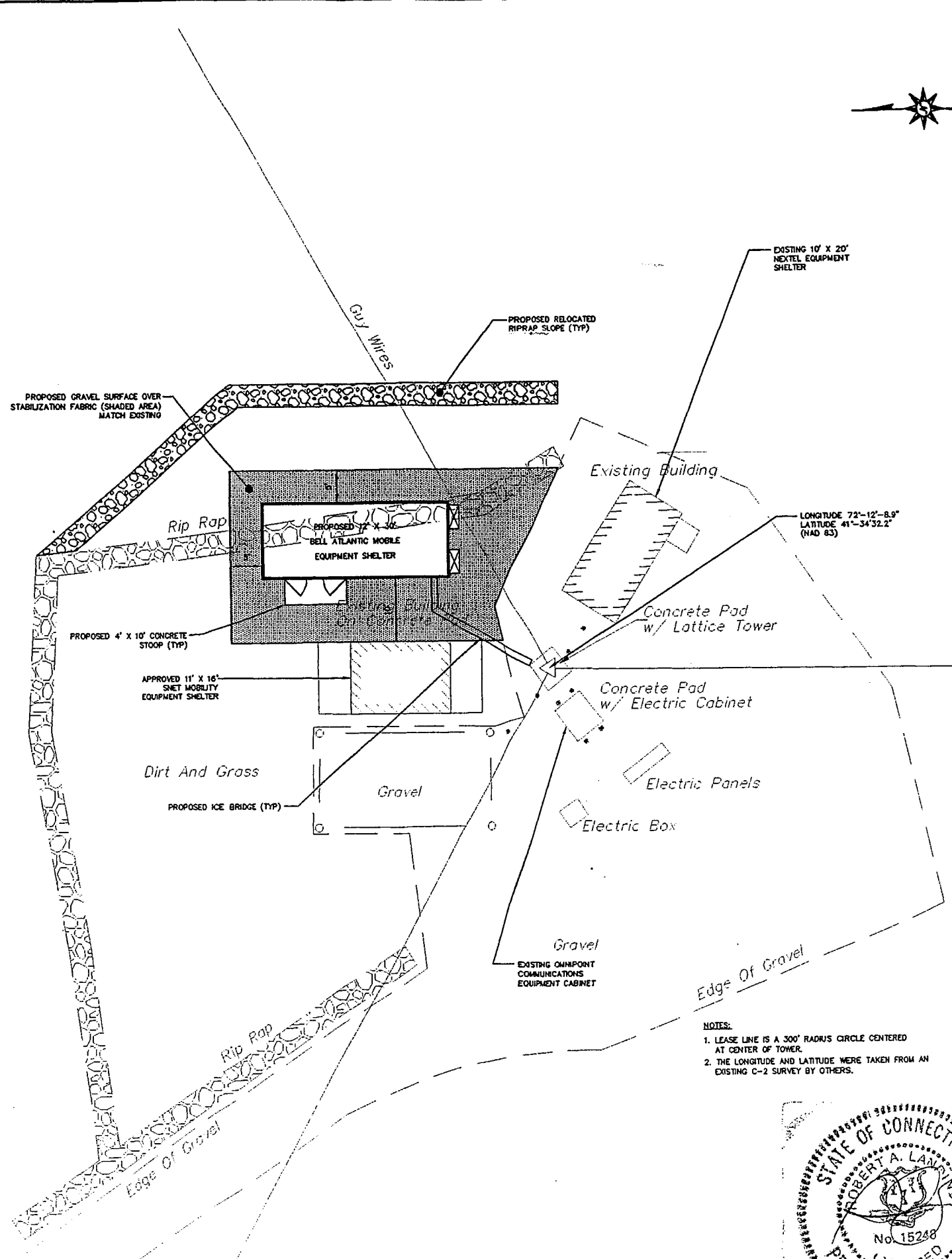

EXISTING 10' X 20' NEXTEL EQUIPMENT SHELTER

LONGITUDE 72°-12'-8.9"
LATITUDE 41°-34'-32.2"
(NAD 83)

- NOTES:
1. LEASE LINE IS A 300' RADIUS CIRCLE CENTERED AT CENTER OF TOWER.
 2. THE LONGITUDE AND LATITUDE WERE TAKEN FROM AN EXISTING C-2 SURVEY BY OTHERS.

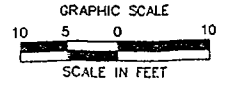
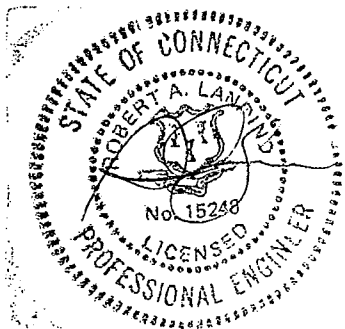

SITE PLAN
SCALE: 1"=10'

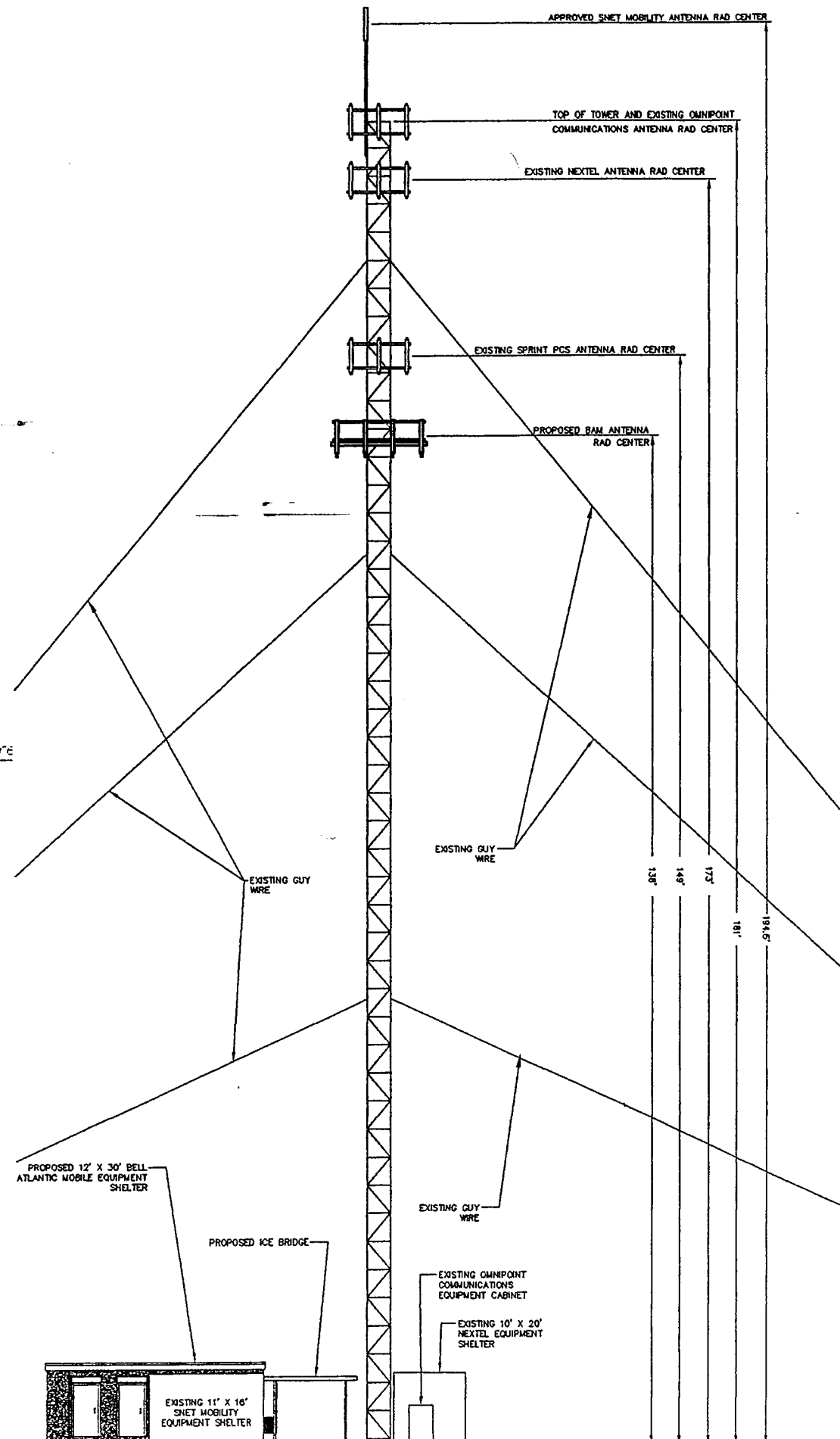

APPROVED SNET MOBILITY ANTENNA RAD CENTER

TOP OF TOWER AND EXISTING OMNIPPOINT COMMUNICATIONS ANTENNA RAD CENTER

EXISTING NEXTEL ANTENNA RAD CENTER

EXISTING SPRINT PCS ANTENNA RAD CENTER

PROPOSED BAM ANTENNA RAD CENTER

EXISTING GUY WIRE

EXISTING GUY WIRE

EXISTING GUY WIRE

EXISTING OMNIPPOINT COMMUNICATIONS EQUIPMENT CABINET

EXISTING 10' X 20' NEXTEL EQUIPMENT SHELTER

PROPOSED 12' X 30' BELL ATLANTIC MOBILE EQUIPMENT SHELTER

PROPOSED ICE BRIDGE

EXISTING 11' X 16' SNET MOBILITY EQUIPMENT SHELTER

138'
148'
175'
181'
194.5'

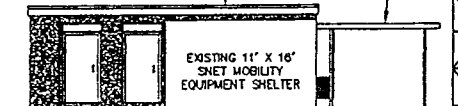

TOWER ELEVATION
SCALE: 1"=10'

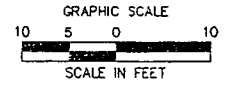

REVISIONS	Date	Desc.
No.		

Designed	R.C.B.
Drawn	R.C.B.
Checked	S.N.
Approved	R.A.L.
Scale	AS SHOWN
Project No.	99C541
Date	01/12/00
CAD File	SCC54101

Sheet No. **SC-1**

Ref (s): XTC54101, 99C54110

12/20/99

11:36:53 AM

BellAtlantic Mobile

Gilman/Bozrah, CT

Project #: 7358

GUY CABLE DATA	ft, lbf				Wind	Total	Cable
	Elev	Horiz	Length	Angle	Length	Length	Type
Cable 3:	160	150	220	47.02	734	1320	EHS
Cable 2:	120	150	193	38.89	595	1156	EHS
Cable 1:	60	150	162	22.13	204	486	EHS

CABLE LOADS	-lbf					
	Shear	Download	Cable Load	Cable Size	%Loaded	
Cable 3:	20998	26025	35569	2 - 5/8x7	83.9	
Cable 2:	11511	10722	17077	2 - 9/16x7	48.8	
Cable 1:	13195	6196	16448	1 - 9/16x7	94.0	

Cable Safety Factor: 2.00

Shear at 0': 3441 lbf

Shear on Guy Anchors: 389 lbf

ACCUMULATED DOWN LOADS

Elevation	Down load (lbf)
180	39
170	1744
160	30272
140	34357
120	50187
90	55347
60	67029
30	72189
0	77349

GUY ANCHOR REACTIONS

Anchor Radius (ft):	150
Vertical Reaction (lbf):	42942
Horizontal Reaction (lbf):	52774
Resultant (lbf):	68037
Horizontal Angle (°):	39.13

TOWER PLOT DIMENSIONS

A=	225 ft
B=	150 ft
C=	75 ft
D=	260 ft
E=	130 ft

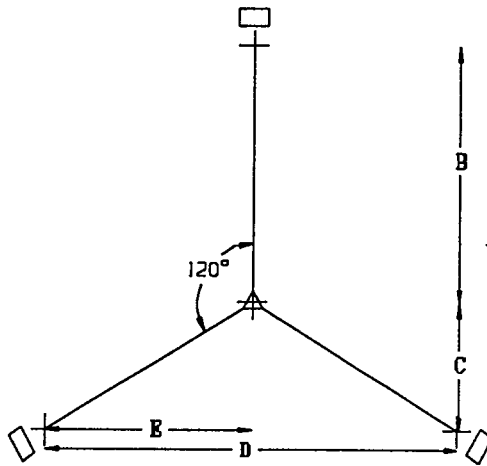

TOWER PLOT PLAN

12/20/99

11:37:20 AM

BellAtlantic Mobile

Gilman/Bozrah, CT

Project #: 7358

MOMENT DISTRIBUTION OUTPUT

Beam Configuration:

4 Spans

SPAN	FEMB	FEMT	VB	VT	dfB	dft
1	-46502	46501	4650	4650	1.0000	0.5000
2	-62134	62133	6213	6700	0.5000	0.4000
3	-46823	51423	6351	7462	0.6000	1.0000
4	-137419	0	8734	0	0.0000	0.0000

10 Iterations

SPAN #	DISTRIBUTED MOMENTS (ft-lb)			SHEARS (lb)		REACTIONS (lb)
	MOM B	MOM T	VB	VT		
1	0	72555	3441	5859		3441
2	-72555	35684	6828	6086		12687
3	-35684	137419	3808	10006		9894
4	-137419	0	8735	0		18740
						0

Maximum_Download = 77348.5

Maximum_Load = 2186.5

Top := 200 ft High

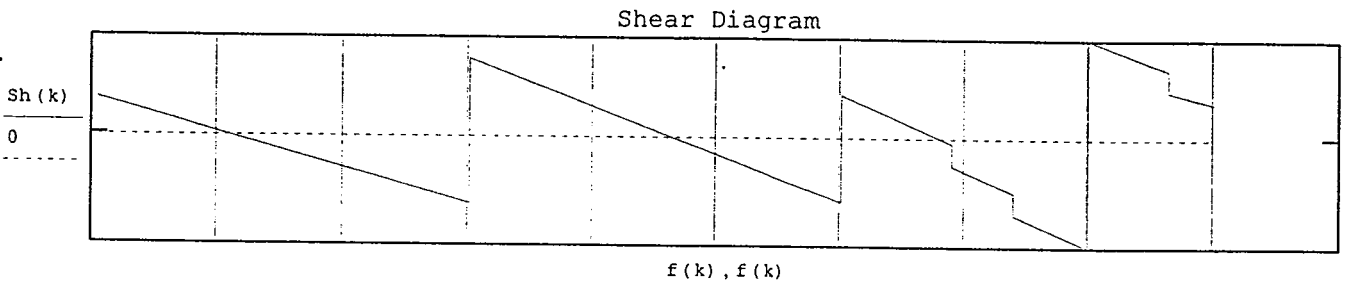
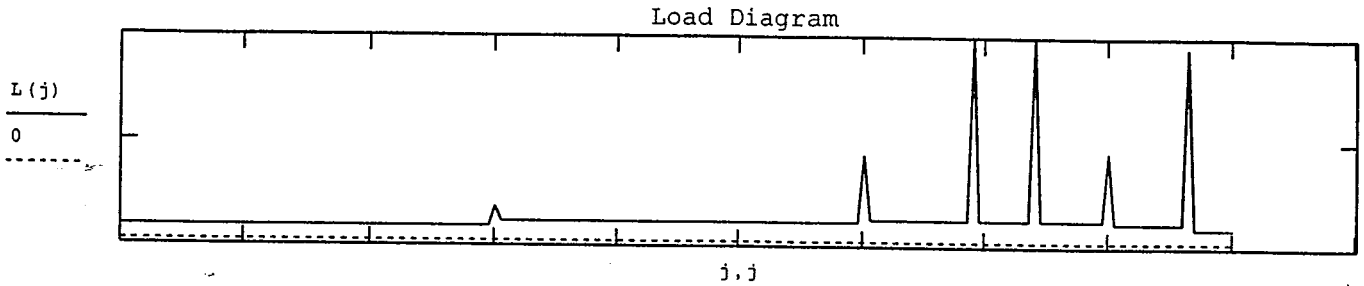

SMax = 8734.7 SMin = -9477

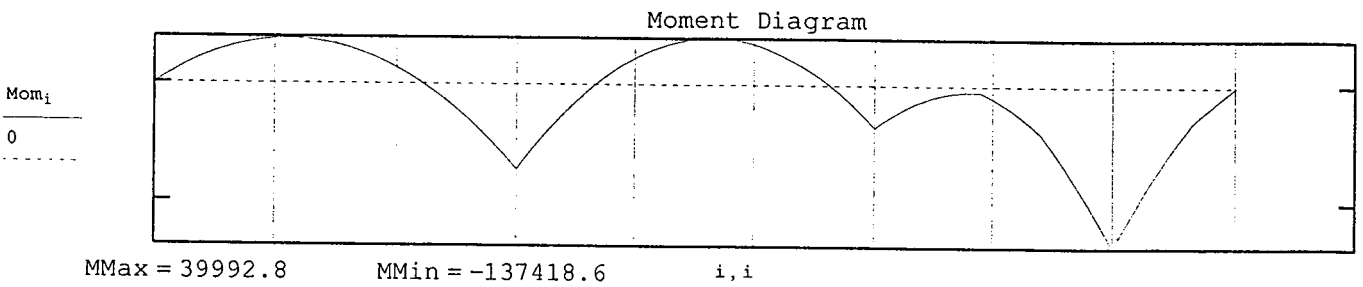

MMax = 39992.8 MMin = -137418.6

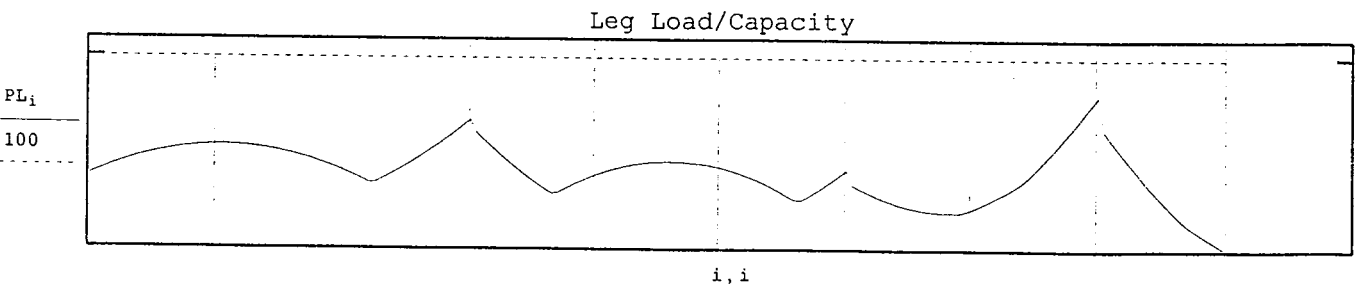

$PL_1 = \% \text{ Loaded}$
 $Mom_1 = \text{Moment}$

Elevation = 160

Moment = -137418.6
 DownLoad = 30272

Leg_Load = 55427.1

Percent_Loaded₁ = 80.5%

max(PL) = 80.5

Check Girts at Guy Pulls:

Tensile capacity of (1) L1.5x1.5x3/16:

$$\text{Area} := [1.5^2 - (1.5 - .1875)^2 - .4375 \cdot .1875] \cdot \text{in}^2$$

$$\text{Capacity} := .6 \cdot \text{FY}_{\text{girt}} \cdot \frac{4}{3} \cdot \text{Area} \cdot 1 \cdot \text{bars}$$

Maximum Single cable shear is 13500 lb, resolved into each brace.

$$\text{Percent_Loaded}_2 := \frac{\frac{13500 \cdot \text{lbF}}{2 \cdot \text{girt} \cdot \cos(30 \cdot \text{deg})}}{\text{Capacity}}$$

Steel Properties:

$$E := 29 \cdot 10^6 \cdot \text{psi}$$

$$\text{FY}_{\text{girt}} := 36000 \cdot \text{psi}$$

$$\text{FY}_{\text{diag}} := 36000 \cdot \text{psi}$$

$$\text{Capacity} = 12825 \text{ lbF}$$

$$\text{Percent_Loaded}_2 = 60.8\%$$

Check compression capacity of girts against maximum shear:

$$l := (42 - 2.875) \cdot \text{in}$$

$$\text{Area} := [1.5^2 - (1.5 - .1875)^2] \cdot \text{in}^2$$

$$r := .293 \cdot \text{in} \quad \text{L1.5x1.5x.1875"}$$

$$K := .65 \quad \text{All welded}$$

$$klr := \frac{K \cdot l}{r}$$

$$Cc := \sqrt{\frac{2 \cdot \pi^2 \cdot E}{\text{FY}_{\text{girt}}}}$$

$$klr = 86.8$$

$$Cc = 126.1$$

$$\text{Fa}(klr, Cc, \text{FY}) := \frac{\left[1 - \frac{\left(\frac{klr}{Cc} \right)^2}{2} \right] \cdot \text{FY}}{\frac{5}{3} + \frac{3}{8} \cdot \frac{klr}{Cc} - \left(\frac{klr}{2 \cdot Cc} \right)^3} \cdot (klr < Cc) + \frac{12 \cdot \pi^2 \cdot E}{23 \cdot klr^2} \cdot (klr \geq Cc)$$

$$\text{Fal} := \text{Fa}(klr, Cc, \text{FY}_{\text{girt}})$$

$$\text{Fal} = 14581.6 \text{ psi}$$

Maximum allowable compression load:

$$\text{Pmax} := \text{Fal} \cdot \frac{4}{3} \cdot \text{Area}$$

$$\text{Pmax} = 10252.7 \text{ lbF}$$

$$\text{MaxShear} = 9477$$

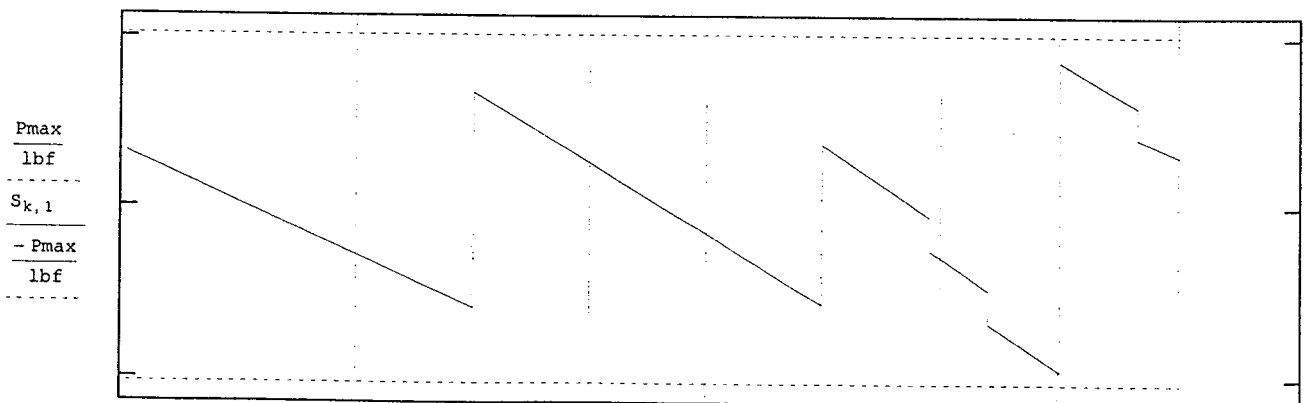

$$\text{Percent_Loaded}_3 := \frac{\text{MaxShear}}{\text{Pmax}} \cdot \text{lbF}$$

$$\text{Percent_Loaded}_3 = 92.4\%$$

Check tension capacity of diagonals:

$$S(k) := \frac{Sh(k)}{2 \cdot \text{braces} \cdot \cos(45 \cdot \text{deg})}$$

$$P_{\max} := \frac{\pi}{4} \cdot \left(\frac{5}{8} \cdot \text{in}\right)^2 \cdot .6 \cdot F_{Y_{\text{diag}}} \cdot \frac{4}{3}$$

$$P_{\max} = 8835.7 \text{ lbf}$$

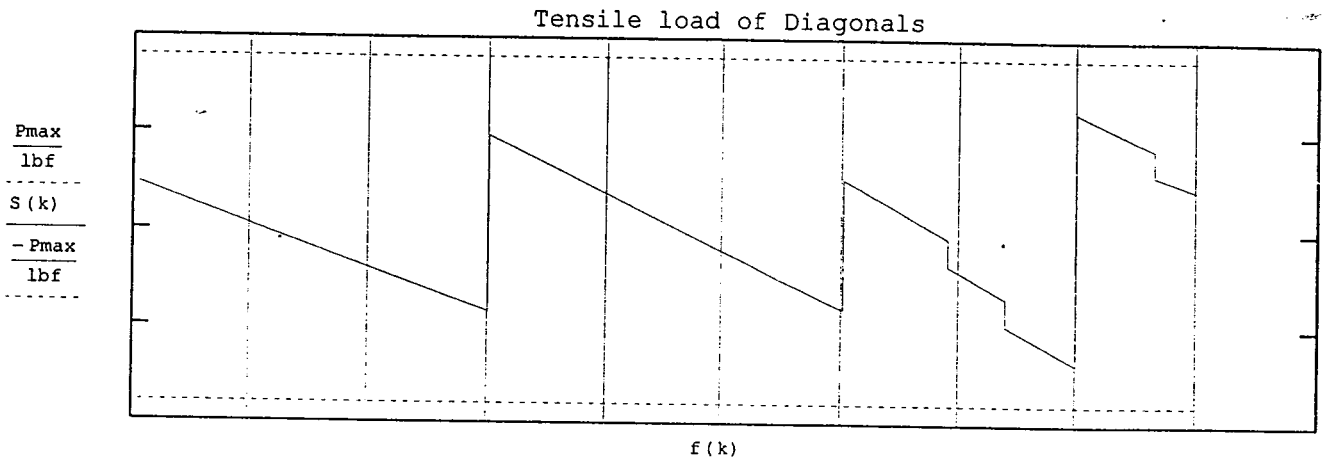
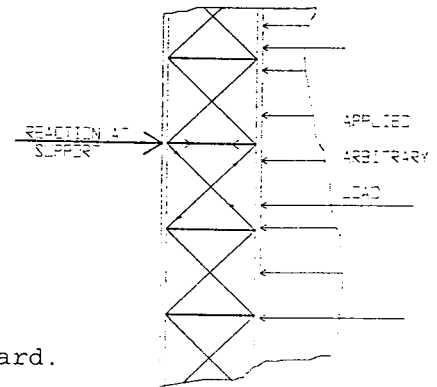

Diagram of force resolution:



Bracing:
 Use 5/8" diagonals throughout tower,
 3/4" at guypull panels.
 L1.5x1.5x.1875".
 Legs: 2-1/2" pipe

All allowable stresses per
 American Institute of Steel Construction 9th edition and
 Electronics Industry Association 222-F recommended standard.

Check Foundation Reactions:

$$\text{Original_Capacity} := \begin{pmatrix} 54.9 & 117.7 \\ 61.1 & 3.6 \\ 82.1 & 1 \end{pmatrix} \cdot \text{kip}$$

$$\text{Current_Reactions} := \begin{pmatrix} 42.9 & 77.3 \\ 52.8 & 3.4 \\ 68.1 & 0 \end{pmatrix} \cdot \text{kip}$$

$$\text{PercentLoaded} = \begin{pmatrix} 78.1 & 65.7 \\ 86.4 & 94.4 \\ 82.9 & 0 \end{pmatrix} \%$$

TOWER LOADS

Point Loads

QTY	Antenna	Elevation (ft)	Windload (lb)	Deadload (lb)	
3	EMS RS90-14	192	167	18	SNET Existing
9	ALP 9011	183	115	20	Omnipoint Existing
3	12' Cellular Boom	183	287	170	
9	ALP 9011	173	114	20	Nextel Existing
3	12' Cellular Boom	173	283	170	
1	G42 Torque Arm	160	529	262	
9	DB980H90N	148	126	15	Sprint Design
3	12' Cellular Boom	148	271	170	
1	G42 Torque Arm	120	487	262	
12	DB844	138	96	10	BAM Proposed
3	12' Cellular Boom	138	265	170	

Uniform Loads

QTY	Type	Elevation		#/ft	
		Start	Stop	Windload	Deadload
3	LDF6-50 1-1/4	160	192	5.4	1.9
6	LDF6-50 1-1/4	160	192	5.4	1.9
9	LDF7-50A 1-5/8	160	183	6.2	2.4
9	LDF7-50A 1-5/8	160	173	6.1	2.4
9	LDF7-50A 1-5/8	160	148	5.8	2.4
12	LDF7-50A 1-5/8	160	138	5.7	2.4
1	Tower Span 4	160	180	45.6	55.8
1	Tower Span 3	120	160	234.7	172.0
1	Tower Span 2	60	120	207.1	172.0
1	Tower Span 1	0	60	155.0	172.0

TRIANGULAR TOWER SECTION DATA

Client: BellAtlantic Mobile

=====

Project: Gilman/Bozrah, CT

Guyed Tower

12/20/99 11:59 AM

Wind Angle 0,60,90 90 °

Span: 1

Elevation of Foundation: 1 ft Elev@Top

40 feet

Wind Speed 85 mph

Elev@Base 20 feet

Gh 1.12 EIA 2.3.4

Tower Ht. 180 feet

Wind Pres. 20.7 psf EIA 2.3.3

Top Face 42.00 inches 3.50

Radial Ice 0.5 inch

Bot Face 42.00 inches 3.50

EIA 2.3.15 Wind/Ice Reductn? Yes

Taper/Se 0.00 in.

ANSI/EIA Overstress Factor: Yes

Ave Face 42.00 inches

Length 240 inches

LEGS OD,L1 ID,L2 wall

FL.to BR 6 inches

2.5" Sch40 2.875 2.469 0.203

Panel 6 panels

DIAGONALS

Panel 38.00 inches

5/8" Rod 0.625 0.000 0.313

Br/Panel 2 |x|

HORIZONTALS

Br Lngth 54.54 inches

L1.5x1.5x3 1.500 1.500 0.188

Horiz 7 7

Density 0.283 lb/in^3

Dbl Angle Gap: 0 in

Bracing Type: 1 |x|

Galvanizing? Yes

WaveGuide hole reduction? Yes

SECTION GEOMETRY »

Section Ixx,Iyy » 1508 in^4

Face Vert. Angle 0.000 °

Leg Angle in face 0.000 °

Leg/Axis Angle 0.000 °

Brace Angle 42.138 °

ITEM DL WL

Ladder: 60 10

Misc. 68 0

Total lbf: 128 10

SECTION 1 WIND LOAD / WEIGHT CALCULATIONS:

	Pro OD	X-Area	Weight	Ice Wt
Legs	3.875	1.704	347.2	123.7 lbs
Diagonals	1.625	0.307	170.5	112.4 lbs
Horizontals	2.500	0.527	131.6	100.0 lbs

Total Weig 682 336 lbs

Ag: 11010

Af: 411 Df: 0.850

Ar: 3197 Rr: 0.625

SR(e): 0.328 Dr: 1.000

Cf: 2.225

Legs: K 1.00

Fy 40.1 OK

EIA 3.1.1, Cc 60000 psi

AISC E2 Fa 97.7

Max.Compresn.Force 40428 psi

68891 lbs

Area: 16.30 ft^2

Shear: 574 28.7 lbf,lbf/ft

CnMoment: 5736 ft-lbf

Deadload: 1146 57.3 lbf,lbf/ft

K 1.00

Solid Area Windloads:

Diagonals: K 142.2 OK

Shear: 3100 155.0 lbf,lbf/ft

Fy 36000 psi

Cc 126.1

inches^2 feet^2

EIA 3.1.1 Fa 9848 psi

Ae 0° 2408.5 16.73

Max.Compresn.Force 3021 lbs

Ae 45° 2890.2 20.07

Max.Tension.Force* 8836 lbs

Ae 60° 2326.3 16.16

*Verify Net Section on member.

Ae 90° 2346.9 16.30

K 1

Horizontals: K 133.4 OK

Span Length 60 ft

Cc 126.1

Span Capacity 68087 lbf/leg

EIA 3.1.1 Fa 11193 psi

Max.Compresn.Force 5903 lbs

TRIANGULAR TOWER SECTION DATA

Client: BellAtlantic Mobile

=====

Project: Gilman/Bozrah, CT

Guyed Tower

12/20/99 11:59 AM

Wind Angle 0,60,90 90 °

Span: 2

Elevation of Foundation: 1 ft Elev@Top 100 feet

Wind Speed 85 mph Elev@Base 80 feet

Gh 1.12 EIA 2.3.4 Tower Ht. 180 feet

Wind Pres. 27.7 psf EIA 2.3.3 Top Face 42.00 inches 3.50

Radial Ice 0.5 inch Bot Face 42.00 inches 3.50

EIA 2.3.15 Wind/Ice Reductn? Yes Taper/Se 0.00 in.

ANSI/EIA Overstress Factor: Yes Ave Face 42.00 inches

Length 240 inches

LEGS OD,L1 ID,L2 wall FL.to BR 6 inches

2.5" Sch40 2.875 2.469 0.203 # Panel 6 panels

DIAGONALS Panel 38.00 inches

5/8" Rod 0.625 0.000 0.313 Br/Panel 2 |x|

HORIZONTALS Br Lngth 54.54 inches

L1.5x1.5x3 1.500 1.500 0.188 # Horiz 7 7

Density 0.283 lb/in^3

Dbl Angle Gap: 0 in Bracing Type: 1 |x|

Galvanizing? Yes

WaveGuide hole reduction? Yes

SECTION GEOMETRY »

Section Ixx,Iyy » 1508 in^4

Face Vert. Angle 0.000 °

Leg Angle in face 0.000 °

Leg/Axis Angle 0.000 °

Brace Angle 42.138 °

ITEM	DL	WL
Ladder:	60	10
Misc.	38	0
Total lbf:	98	10

SECTION 2 WIND LOAD / WEIGHT CALCULATIONS:

	Pro OD	X-Area	Weight	Ice Wt
Legs	3.875	1.704	347.2	123.7 lbs
Diagonals	1.625	0.307	170.5	112.4 lbs
Horizontals	2.500	0.527	131.6	100.0 lbs

 Ag: 11010 Total Weig 682 336 lbs

Af: 411 Df: 0.850

Ar: 3197 Rr: 0.625 K 1.00

SR(e): 0.328 Dr: 1.000 Legs: KL/r 40.1 OK

Cf: 2.225 Fy 60000 psi

EIA 3.1.1, Cc 97.7

Area: 16.30 ft^2 AISC E2 Fa 40428 psi

Shear: 763 38.2 lbf,lbf/ Max.Compresn.Force 68891 lbs

CnMoment: 7631 ft-lbf

Deadload: 1116 55.8 lbf,lbf/ft K 1.00

Solid Area Windloads: Diagonals : KL/r 142.2 OK

Shear: 4142 207.1 lbf,lbf/ft Fy 36000 psi

Cc 126.1

inches^2 feet^2 EIA 3.1.1 Fa 9848 psi

Ae 0° 2408.5 16.73 Max.Compresn.Force 3021 lbs

Ae 45° 2890.2 20.07 Max.Tension.Force* 8836 lbs

Ae 60° 2326.3 16.16 *Verify Net Section on member.

Ae 90° 2346.9 16.30 K 1

Horizontals: KL/r 133.4 OK

Cc 126.1

Span Length 60 ft

Span Capacity 68087 lbf/leg EIA 3.1.1 Fa 11193 psi

Max.Compresn.Force 5903 lbs

TRIANGULAR TOWER SECTION DATA

Client: BellAtlantic Mobile

Project: Gilman/Bozrah, CT

12/20/99 11:59 AM

Guyed Tower

Wind Angle 0,60,90 90 °

Span: 3

Elevation of Foundation: 1 ft

Elev@Top 150 feet

Wind Speed 85 mph

Elev@Base 130 feet

Gh 1.12 EIA 2.3.4

Tower Ht. 180 feet

Wind Pres. 31.4 psf EIA 2.3.3

Top Face 42.00 inches 3.50

Radial Ice 0.5 inch

Bot Face 42.00 inches 3.50

EIA 2.3.15 Wind/Ice Reductn? Yes

Taper/Se 0.00 in.

ANSI/EIA Overstress Factor: Yes

Ave Face 42.00 inches

Length 240 inches

LEGS OD,L1 ID,L2 wall

FL.to BR 6 inches

2.5" Sch40 2.875 2.469 0.203

Panel 6 panels

DIAGONALS

Panel 38.00 inches

5/8" Rod 0.625 0.000 0.313

Br/Panel 2 |x|

HORIZONTALS

Br Lngth 54.54 inches

L1.5x1.5x3 1.500 1.500 0.188

Horiz 7 7

Density 0.283 lb/in³

Db1 Angle Gap: 0 in

Bracing Type: 1 |x|

Galvanizing? Yes

WaveGuide hole reduction? Yes

SECTION GEOMETRY »

Section Ixx,Iyy » 1508 in⁴

Face Vert. Angle 0.000 °

Leg Angle in face 0.000 °

Leg/Axis Angle 0.000 °

Brace Angle 42.138 °

ITEM

DL WL

Ladder: 60 10

Misc. 38 0

Total lbf: 98 10

SECTION 3 WIND LOAD / WEIGHT CALCULATIONS:

	Pro OD	X-Area	Weight	Ice Wt
Legs	3.875	1.704	347.2	123.7 lbs
Diagonals	1.625	0.307	170.5	112.4 lbs
Horizontals	2.500	0.527	131.6	100.0 lbs

 Ag: 11010 Total Weig 682 336 lbs

Af: 411 Df: 0.850

Ar: 3197 Rr: 0.625

SR(e): 0.328 Dr: 1.000

Cf: 2.225

K 1.00

Legs: KL/r 40.1 OK

Fy 60000 psi

EIA 3.1.1, Cc 97.7

Area: 16.30 ft² AISC E2 Fa 40428 psi

Shear: 863 43.2 lbf,lbf/ Max.Compresn.Force 68891 lbs

CnMoment: 8635 ft-lbf

Deadload: 1116 55.8 lbf,lbf/ft K 1.00

Solid Area Windloads: Diagonals : KL/r 142.2 OK

Shear: 4694 234.7 lbf,lbf/ft Fy 36000 psi

Cc 126.1

inches² feet² EIA 3.1.1 Fa 9848 psi

Ae 0° 2408.5 16.73 Max.Compresn.Force 3021 lbs

Ae 45° 2890.2 20.07 Max.Tension.Force* 8836 lbs

Ae 60° 2326.3 16.16 *Verify Net Section on member.

Ae 90° 2346.9 16.30 K 1

Horizontals: KL/r 133.4 OK

Cc 126.1

Span Length 40 ft

Span Capacity 73822 lbf/leg

EIA 3.1.1 Fa 11193 psi

Max.Compresn.Force 5903 lbs

TRIANGULAR TOWER SECTION DATA

Client: BellAtlantic Mobile

=====

Project: Gilman/Bozrah, CT

Guyed Tower

12/20/99 11:59 AM

Wind Angle 0,60,90 90 °

Span: 4

Elevation of Foundation: 1 ft Elev@Top

180 feet

Wind Speed 85 mph Elev@Base

160 feet

Gh 1.12 EIA 2.3.4 Tower Ht. 180 feet

Wind Pres. 33.2 psf EIA 2.3.3 Top Face 42.00 inches 3.50

Radial Ice 0.5 inch Bot Face 42.00 inches 3.50

EIA 2.3.15 Wind/Ice Reductn? Yes Taper/Se 0.00 in.

ANSI/EIA Overstress Factor: Yes Ave Face 42.00 inches

Length 240 inches

LEGS OD,L1 ID,L2 wall FL.to BR 6 inches

2.5" Sch40 2.875 2.469 0.203 # Panel 6 panels

DIAGONALS Panel 38.00 inches

5/8" Rod 0.625 0.000 0.313 Br/Panel 2 |x|

HORIZONTALS Br Lngth 54.54 inches

L1.5x1.5x3 1.500 1.500 0.188 # Horiz 7 7

Density 0.283 lb/in^3

Dbl Angle Gap: 0 in Bracing Type: 1 |x|

Galvanizing? Yes

WaveGuide hole reduction? Yes

SECTION GEOMETRY »

Section Ixx,Iyy » 1508 in^4

Face Vert. Angle 0.000 °

Leg Angle in face 0.000 °

Leg/Axis Angle 0.000 °

Brace Angle 42.138 °

ITEM DL WL

Ladder: 60 10

Misc. 38 0

Total lbf: 98 10

SECTION 4 WIND LOAD / WEIGHT CALCULATIONS:

	Pro OD	X-Area	Weight	Ice Wt
Legs	3.875	1.704	347.2	123.7 lbs
Diagonals	1.625	0.307	170.5	112.4 lbs
Horizontals	2.500	0.527	131.6	100.0 lbs

Total Weig 682 336 lbs

Ag: 11010

Af: 411 Df: 0.850

Ar: 3197 Rr: 0.625 K 1.00

SR(e): 0.328 Dr: 1.000 Legs: KL/r 40.1 OK

Cf: 2.225 Fy 60000 psi

EIA 3.1.1, Cc 97.7

Area: 16.30 ft^2 AISC E2 Fa 40428 psi

Shear: 912 45.6 lbf,lbf/ Max.Compresn.Force 68891 lbs

CnMoment: 9118 ft-lbf

Deadload: 1116 55.8 lbf,lbf/ft K 1.00

Solid Area Windloads: Diagonals: KL/r 142.2 OK

Shear: 4960 248.0 lbf,lbf/ft Fy 36000 psi

Cc 126.1

inches^2 feet^2 EIA 3.1.1 Fa 9848 psi

Ae 0° 2408.5 16.73 Max.Compresn.Force 3021 lbs

Ae 45° 2890.2 20.07 Max.Tension.Force* 8836 lbs

Ae 60° 2326.3 16.16 *Verify Net Section on member.

Ae 90° 2346.9 16.30 K 1

Horizontals: KL/r 133.4 OK

Cc 126.1

Span Length 40 ft

pan Capacity 73822 lbf/leg EIA 3.1.1 Fa 11193 psi

Max.Compresn.Force 5903 lbs

Elevation	Moment	Accum. Download	Resolved Legload	Panel / Span Capacity		% Loaded
0	0	77349	25783	68891	68891	37.4
1	3363	77177	26835	68891	68891	39.0
2	6572	77005	27836	68891	68891	40.4
3	9625	76833	28786	68891	68891	41.8
4	12523	76661	29685	68891	68891	43.1
5	15267	76489	30533	68891	68891	44.3
6	17955	76317	31330	68891	68891	45.5
7	20288	76145	32075	68891	68891	46.6
8	22567	75973	32769	68891	68891	47.6
9	24690	75801	33412	68891	68891	48.5
10	26658	75629	34005	68891	68891	49.4
11	28472	75457	34545	68891	68891	50.1
12	30130	75285	35035	68891	68891	50.9
13	31633	75113	35474	68891	68891	51.5
14	32982	74941	35861	68891	68891	52.1
15	34175	74769	36198	68891	68891	52.5
16	35213	74597	36483	68891	68891	53.0
17	36097	74425	36717	68891	68891	53.3
18	36825	74253	36900	68891	68891	53.6
19	37398	74081	37032	68891	68891	53.8
20	37816	73909	37112	68891	68891	53.9
21	38080	73737	37142	68891	68891	53.9
22	38188	73565	37120	68891	68891	53.9
23	38141	73393	37048	68891	68891	53.8
24	37940	73221	36924	68891	68891	53.6
25	37583	73049	36749	68891	68891	53.3
26	37071	72877	36522	68891	68891	53.0
27	36404	72705	36245	68891	68891	52.6
28	35583	72533	35917	68891	68891	52.1
29	34606	72361	35537	68891	68891	51.6
30	33474	72189	35106	68891	68891	51.0
31	32187	72017	34625	68891	68891	50.3
32	30746	71845	34092	68891	68891	49.5
33	29149	71673	33507	68891	68891	48.6
34	27397	71501	32872	68891	68891	47.7
35	25490	71329	32186	68891	68891	46.7
36	23429	71157	31448	68891	68891	45.6
37	21212	70985	30660	68891	68891	44.5
38	18840	70813	29820	68891	68891	43.3
39	16313	70641	28929	68891	68891	42.0
40	13631	70469	27987	68891	68891	40.6
41	10795	70297	26994	68891	68891	39.2
42	7803	70125	25949	68891	68891	37.7
43	4656	69953	24854	68891	68891	36.1
44	1354	69781	23707	68891	68891	34.4
45	-2103	69609	23897	68891	68891	34.7
46	-5714	69437	25031	68891	68891	36.3
47	-9481	69265	26216	68891	68891	38.1
48	-13403	69093	27453	68891	68891	39.8
49	-17480	68921	28740	68891	68891	41.7

Eleva- tion	Moment	Accum. Download	Resolved Legload	Panel / Span Capacity		% Loaded
50	-21712	68749	30079	68891	68891	43.7
51	-26099	68577	31469	68891	68891	45.7
52	-30640	68405	32910	68891	68891	47.8
53	-35337	68233	34402	68891	68891	49.9
54	-40189	68061	35946	68891	68891	52.2
55	-45196	67889	37540	68891	68891	54.5
56	-50358	67717	39186	68891	68891	56.9
57	-55675	67545	40883	68891	68891	59.3
58	-61146	67373	42631	68891	68891	61.9
59	-66773	67201	44430	68891	68891	64.5
60	-72555	67029	46280	68891	68891	67.2
61	-65831	60335	41830	68891	68891	60.7
62	-59314	60163	39623	68891	68891	57.5
63	-53003	59991	37483	68891	68891	54.4
64	-46900	59819	35413	68891	68891	51.4
65	-41005	59647	33410	68891	68891	48.5
66	-35316	59475	31476	68891	68891	45.7
67	-29834	59303	29610	68891	68891	43.0
68	-24560	59131	27813	68891	68891	40.4
69	-19492	58959	26084	68891	68891	37.9
70	-14632	58787	24423	68891	68891	35.5
71	-9979	58615	22830	68891	68891	33.1
72	-5532	58443	21306	68891	68891	30.9
73	-1293	58271	19850	68891	68891	28.8
74	2739	58099	20270	68891	68891	29.4
75	6563	57927	21474	68891	68891	31.2
76	10181	57755	22610	68891	68891	32.8
77	13591	57583	23678	68891	68891	34.4
78	16795	57411	24678	68891	68891	35.8
79	19791	57239	25609	68891	68891	37.2
80	22580	57067	26472	68891	68891	38.4
81	25163	56895	27266	68891	68891	39.6
82	27537	56723	27993	68891	68891	40.6
83	29705	56551	28650	68891	68891	41.6
84	31666	56379	29240	68891	68891	42.4
85	33420	56207	29761	68891	68891	43.2
86	34966	56035	30214	68891	68891	43.9
87	36306	55863	30599	68891	68891	44.4
88	37438	55691	30915	68891	68891	44.9
89	38363	55519	31163	68891	68891	45.2
90	39081	55347	31342	68891	68891	45.5
91	39592	55175	31454	68891	68891	45.7
92	39896	55003	31497	68891	68891	45.7
93	39993	54831	31471	68891	68891	45.7
94	39882	54659	31377	68891	68891	45.5
95	39565	54487	31215	68891	68891	45.3
96	39040	54315	30985	68891	68891	45.0
97	38309	54143	30686	68891	68891	44.5
98	37370	53971	30319	68891	68891	44.0
99	36224	53799	29884	68891	68891	43.4

Elevation	Moment	Accum. Download	Resolved Legload	Panel / Span Capacity		% Loaded
100	34871	53627	29380	68891	68891	42.6
101	33311	53455	28808	68891	68891	41.8
102	31543	53283	28168	68891	68891	40.9
103	29569	53111	27459	68891	68891	39.9
104	27387	52939	26682	68891	68891	38.7
105	24999	52767	25836	68891	68891	37.5
106	22403	52595	24923	68891	68891	36.2
107	19600	52423	23941	68891	68891	34.8
108	16590	52251	22890	68891	68891	33.2
109	13373	52079	21772	68891	68891	31.6
110	9949	51907	20585	68891	68891	29.9
111	6318	51735	19329	68891	68891	28.1
112	2479	51563	18006	68891	68891	26.1
113	-1566	51391	17647	68891	68891	25.6
114	-5819	51219	18993	68891	68891	27.6
115	-10279	51047	20407	68891	68891	29.6
116	-14945	50875	21889	68891	68891	31.8
117	-19819	50703	23440	68891	68891	34.0
118	-24900	50531	25059	68891	68891	36.4
119	-30189	50359	26746	68891	68891	38.8
120	-35684	50187	28502	68891	68891	41.4
121	-31994	38255	23307	68891	68891	33.8
122	-28538	38083	22109	68891	68891	32.1
123	-25317	37911	20990	68891	68891	30.5
124	-22331	37739	19947	68891	68891	29.0
125	-19579	37567	18982	68891	68891	27.6
126	-17063	37395	18094	68891	68891	26.3
127	-14781	37223	17284	68891	68891	25.1
128	-12733	37051	16551	68891	68891	24.0
129	-10921	36879	15896	68891	68891	23.1
130	-9343	36707	15318	68891	68891	22.2
131	-7999	36535	14818	68891	68891	21.5
132	-6891	36363	14394	68891	68891	20.9
133	-6017	36191	14049	68891	68891	20.4
134	-5378	36019	13781	68891	68891	20.0
135	-4974	35847	13590	68891	68891	19.7
136	-4804	35675	13477	68891	68891	19.6
137	-4869	35503	13441	68891	68891	19.5
138	-5169	35331	13482	68891	68891	19.6
139	-7655	34529	14035	68891	68891	20.4
140	-10376	34357	14876	68891	68891	21.6
141	-13332	34185	15794	68891	68891	22.9
142	-16523	34013	16789	68891	68891	24.4
143	-19948	33841	17861	68891	68891	25.9
144	-23608	33669	19012	68891	68891	27.6
145	-27502	33497	20239	68891	68891	29.4
146	-31631	33325	21544	68891	68891	31.3
147	-35995	33153	22926	68891	68891	33.3
148	-40594	32981	24386	68891	68891	35.4
149	-47372	32164	26350	68891	68891	38.2

Eleva- tion	Moment	Accum. Download	Resolved Legload	Panel / Span Capacity		% Loaded
150	-54384	31992	28606	68891	68891	41.5
151	-61632	31820	30940	68891	68891	44.9
152	-69114	31648	33351	68891	68891	48.4
153	-76830	31476	35839	68891	68891	52.0
154	-84782	31304	38405	68891	68891	55.7
155	-92968	31132	41049	68891	68891	59.6
156	-101388	30960	43770	68891	68891	63.5
157	-110044	30788	46568	68891	68891	67.6
158	-118934	30616	49443	68891	68891	71.8
159	-128059	30444	52397	68891	68891	76.1
160	-137419	30272	55427	68891	68891	80.5
161	-128014	2795	43165	68891	68891	62.7
162	-118814	2678	40091	68891	68891	58.2
163	-109818	2562	37085	68891	68891	53.8
164	-101028	2445	34146	68891	68891	49.6
165	-92443	2328	31274	68891	68891	45.4
166	-84063	2211	28471	68891	68891	41.3
167	-75887	2094	25734	68891	68891	37.4
168	-67917	1978	23066	68891	68891	33.5
169	-60151	1861	20465	68891	68891	29.7
170	-52591	1744	17932	68891	68891	26.0
171	-45235	1627	15466	68891	68891	22.4
172	-38084	1510	13068	68891	68891	19.0
173	-31138	1393	10737	68891	68891	15.6
174	-26240	609	8860	68891	68891	12.9
175	-21492	514	7262	68891	68891	10.5
176	-16894	419	5713	68891	68891	8.3
177	-12445	324	4214	68891	68891	6.1
178	-8147	229	2764	68891	68891	4.0
179	-3999	134	1364	68891	68891	2.0
180	0	39	13	68891	68891	0.0