

# STATE OF CONNECTICUT

## CONNECTICUT SITING COUNCIL

Ten Franklin Square, New Britain, CT 06051

Phone: (860) 827-2935 Fax: (860) 827-2950

E-Mail: [siting.council@po.state.ct.us](mailto:siting.council@po.state.ct.us)

Web Site: [www.state.ct.us/csc/index.htm](http://www.state.ct.us/csc/index.htm)

October 20, 2003

Scott T. Penner, Esq.  
Hurwitz & Sagarin LLC  
147 North Broad Street  
P.O. Box 112  
Milford, CT 06460-0112

RE: **EM-SPRINT-011-030929** - Sprint Sites USA notice of intent to modify an existing telecommunications facility located at 28 Brewer Drive, Bloomfield, Connecticut.

Dear Attorney Penner:

At a public meeting held on October 14, 2003, the Connecticut Siting Council (Council) acknowledged your notice to modify this existing telecommunications facility, pursuant to Section 16-50j-73 of the Regulations of Connecticut State Agencies.

The proposed modifications are to be implemented as specified here and in your notice dated September 26, 2003. The modifications are in compliance with the exception criteria in Section 16-50j-72 (b) of the Regulations of Connecticut State Agencies as changes to an existing facility site that would not increase tower height, extend the boundaries of the tower site, increase noise levels at the tower site boundary by six decibels, and increase the total radio frequencies electromagnetic radiation power density measured at the tower site boundary to or above the standard adopted by the State Department of Environmental Protection pursuant to General Statutes § 22a-162. This facility has also been carefully modeled to ensure that radio frequency emissions are conservatively below State and federal standards applicable to the frequencies now used on this tower.

This decision is under the exclusive jurisdiction of the Council. Any additional change to this facility will require explicit notice to this agency pursuant to Regulations of Connecticut State Agencies Section 16-50j-73. Such notice shall include all relevant information regarding the proposed change with cumulative worst-case modeling of radio frequency exposure at the closest point of uncontrolled access to the tower base, consistent with Federal Communications Commission, Office of Engineering and Technology, Bulletin 65. Any deviation from this format may result in the Council implementing enforcement proceedings pursuant to General Statutes § 16-50u including, without limitation, imposition of expenses resulting from such failure and of civil penalties in an amount not less than one thousand dollars per day for each day of construction or operation in material violation.

Thank you for your attention and cooperation.

Very truly yours,

Pamela B. Katz, P.E.  
Chairman

PBK/laf

c: Honorable Faith McMahon, Mayor, Town of Bloomfield  
Thomas B. Hooper, Director of Planning, Town of Bloomfield  
Michele G. Briggs, Southwestern Bell Mobile Systems  
Thomas F. Flynn III, Nextel Communications

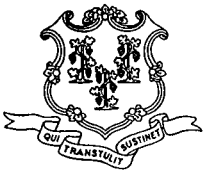

# STATE OF CONNECTICUT

## CONNECTICUT SITING COUNCIL

Ten Franklin Square, New Britain, CT 06051

Phone: (860) 827-2935 Fax: (860) 827-2950

E-Mail: [siting.council@po.state.ct.us](mailto:siting.council@po.state.ct.us)

Web Site: [www.state.ct.us/csc/index.htm](http://www.state.ct.us/csc/index.htm)

October 1, 2003

Honorable Faith McMahon  
Mayor  
Town of Bloomfield  
Town Hall  
800 Bloomfield Avenue  
P. O. Box 337  
Bloomfield, CT 06002-0337

RE: **EM-SPRINT-011-030929** - Sprint Sites USA notice of intent to modify an existing telecommunications facility located at 28 Brewer Drive, Bloomfield, Connecticut.

Dear Ms. McMahon:

The Connecticut Siting Council (Council) received this request to modify an existing telecommunications facility, pursuant to Regulations of Connecticut State Agencies Section 16-50j-72.

The Council will consider this item at the next meeting scheduled for October 14, 2003, at 1:30 p.m. in Hearing Room One, Ten Franklin Square, New Britain, Connecticut.

Please call me or inform the Council if you have any questions or comments regarding this proposal.

Thank you for your cooperation and consideration.

Very truly yours,

S. Derek Phelps  
Executive Director

SDP/lid

Enclosure: Notice of Intent

c: Thomas B. Hooper, Director of Planning, Town of Bloomfield

# HURWITZ & SAGARIN LLC

September 26, 2003

Mr. S. Derek Phelps  
Executive Director  
Connecticut Siting Council  
10 Franklin Square  
New Britain, CT 06051



**Re: Notice of Exempt Modification  
Sprint Sites USA  
28 Brewer Drive  
Bloomfield, Connecticut 06002**

**EM-SPRINT-011-030929**

Dear Mr. Phelps:

Sprint Sites USA ("SSUSA") respectfully requests acknowledgement that its proposed modification of the SSUSA telecommunications facility located at 28 Brewer Drive in Bloomfield, Connecticut (the "Facility") constitutes an exempt modification pursuant to R.C.S.A. § 16-50j-72(b)(2). SSUSA intends to reinforce the existing Facility and allow Southwestern Bell Mobile Systems, LLC, d/b/a Cingular Wireless ("Cingular") to replace its existing antennas on the Facility. Please accept this letter as notification, pursuant to R.C.S.A. § 16-50j-73, of construction which constitutes an exempt modification pursuant to R.C.S.A. § 16-50j-72(b)(2). In accordance with R.C.S.A. § 16-50j-73, a copy of this letter is being sent to the Town Manager of Bloomfield, Louie Chapman, Jr.

The existing Bloomfield Facility consists of a 120-foot self-supporting monopole tower and related equipment located on Brewer Road in Bloomfield. The facility was originally approved by the Town of Bloomfield, and the Council subsequently reviewed and approved the location of T-Mobile's equipment on the Facility (EM-VOICESTREAM-011-020304).

Cingular plans to replace nine of its existing panel-type antennas at the Facility with nine panel-type antennas and six tower mount amplifiers (mounted behind the antennas) at a centerline height of 97 feet above ground level ("AGL"). (See the tower elevation and compound layout attached hereto as Exhibit A). Cingular will continue to utilize its existing equipment shelter near the base of the tower. The existing tower is not structurally capable of supporting Cingular's use, however, and will be structurally reinforced in accordance with the structural analysis dated August 27, 2003, attached hereto as Exhibit B.

The planned modifications to the Bloomfield Facility fall squarely within those activities explicitly provided for in R.C.S.A. § 16-50j-72(b)(2).

1. The proposed modification will not increase the height of the tower. Cingular's antennas will be installed at a centerline height of 97 feet AGL. The enclosed tower elevation confirms that the proposed modifications will not increase the height of the tower.

2. Cingular will continue to utilize its existing equipment shelter, and no expansion of the compound will be necessary.

3. The proposed modification to the facility will not increase the noise levels at the existing facility by six decibels or more.

4. The operation of the additional antennas will not increase the total radio frequency (RF) power density, measured at the base of the tower, to a level at or above the applicable standard. Cingular's GSM 1900 antennas would add .0568 mW/cm<sup>2</sup> or 5.676% of the FCC Standard and Cingular's GSM 850 antennas would add .0568 mW/cm<sup>2</sup> or 9.8% of the FCC Standard, for a combined total of 15.476% of the FCC Standard. Therefore, the calculated "worst case" power density for the planned combined operation at the site including Cingular's antennas would be 25.256% of the FCC Standard as calculated for a mixed frequency site, as evidenced by the RF emissions report attached hereto as Exhibit C.

For the foregoing reasons, SSUSA respectfully submits that the proposed addition of antennas and equipment at the Bloomfield facility constitutes an exempt modification under R.C.S.A. § 16-50j-72(b)(2).

Sincerely,

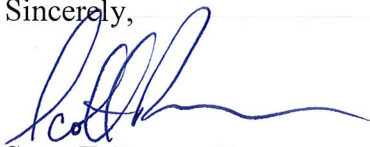

Scott T. Penner, Esq.

cc: Louie Chapman, Jr., Bloomfield Town Manager  
Michael Jones, Sprint Sites, USA  
Debra Perry, Sprint Sites, USA  
Robert Illes, On Air Utilities  
Steven Levine, Cingular Wireless



# HURWITZ & SAGARIN LLC

September 29, 2003

*Federal Express*

Connecticut Siting Council  
10 Franklin Square  
New Britain, CT 06051

Attention: LISA

**Re: Notice of Exempt Modification  
Sprint Sites USA  
28 Brewer Drive  
Bloomfield, Connecticut 06002**

Dear Lisa:

Enclosed please find \$500.00 filing fee in regard to the above.

Very truly yours,



SCOTT T. PENNER  
dsw/enc.

RECEIVED  
SEP 30 2003

CONNECTICUT  
SITING COUNCIL

1047 N. 204<sup>th</sup> Avenue  
Elkhorn, NE 68022  
Ph: 402-289-1888  
Fax: 402-289-1861

**SEMAAN ENGINEERING SOLUTIONS**

**120 ft Rohn Monopole  
Structural Analysis and Modification Package  
ISSUE FOR PERMITS**

**Prepared for:  
Sprint Sites USA  
535 East Crescent Ave  
Ramsey, NJ 07446**

**Site: CT03XC076  
Hartford County, Bloomfield, CT**

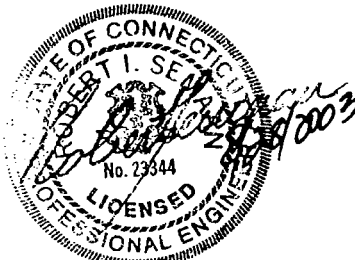

**August 27, 2003**

Ms. Kim Cordes  
Sprint Sites USA  
535 East Crescent Ave  
Ramsey, NJ 07446

**Re: Site Number CT03XC076 – Hartford County, Bloomfield, CT 06002.**

Dear Ms. Kim Cordes:

We have completed the structural analysis for the existing monopole, located at the above referenced site. The purpose of this analysis is to determine that the existing monopole design is in conformance with the EIA/TIA-222-F standard and local building codes for the proposed antennae loads installation. Refer to the Review and Recommendations section at the end of this report for the analysis results.

**Description of Structure:**

The structure is a 120 ft Rohn Monopole.

Refer to Rohn drawing A963248 & A963207 dated October 17, 1996 for a detailed description of the structure.

**Method of analysis:**

The tower was analyzed using Semaan Engineering Solutions' software suite for communication structures. The structural analysis is performed using the SAPS finite element engine. The method is 3D, non-linear, which accounts for the second order geometric effects due to the displacements. It also treats guys as exact cable elements and therefore is ideal for guyed towers. The analysis was performed in conformance with **EIA/TIA-222-F and local building codes for a basic wind speed of 80 mph and 1/2" radial ice with reduced wind speed.** Wind is applied to the structure, accessories and antennas.

**Structure loading:**

Per the loading sheet supplied, the analysis was performed using the following loading: (Proposed loading in bold)

Elev. (ft)	Qty.	Antennas and Mounts	Coax	Owner
120.0	3	DB980H90 (future) Mounted On a Platform w/rail	(3) 1-5/8	Sprint
120.0	6	DB980H90 Mounted On the same Platform w/rail	(6) 1-5/8	Sprint
107.0	12	DR65-18-XX Mounted On a LP Platform	(12) 1-5/8	T-Mobile
<b>97.0</b>	<b>9</b>	<b>DUO4-8670 Mounted On a Platform w/rail</b>	<b>(9) 7/8</b>	<b>Cingular</b>
<b>87.0</b>	<b>12</b>	<b>DB848H90 Mounted On a Platform w/Rail</b>	<b>(12) 1-5/8</b>	<b>Nextel</b>
59.0	1	DB536 Mounted On a STANDOFF	(1) 1/2	Municipality

All new access holes shall be reinforced with welded rims that are compatible with the pole and to be sized and supplied by pole manufacturer.

All transmission lines are assumed running inside of pole shaft.

**Results of Analysis:**

Refer to the attached Computer Summary sheets for detailed analysis results.

**Structure:**

The existing pole shaft is significantly overstressed from 0 ft to 70 ft (by up to 152%). Additional reinforcing and anchors will be required per the attached drawings.

The maximum structure usage is: 99.9% (after modifications)

**Foundation:**

Pole Reactions	Original Design Reactions	Current Analysis Reactions	% Of Design
Moment (ft-kips)	1,074.00	1,545.54	143.9
Shear (kips)	11.70	17.23	147.3

The reactions calculated from the analysis slightly exceed the ones indicated on the original structural design. However, upon reviewing the foundation documents, they were found to be adequate.



**Review and Recommendations:**

Based on the analysis results, the existing structure does not meet the requirements per the EIA/TIA-222-F standards for a basic wind speed of 80 mph and 1/2" radial ice with reduced wind speed. Only after the modifications are made and approved per the attached drawings.

**Attachments:**

1. Sheet S-01, Revision A, dated 08/27/03.
2. Sheet S-01, Revision A, dated 08/27/03.

Job Information	
Pole :	CT03XC076
Description :	
Client :	Sprint Sites USA - NJ
Location :	Hartford County, Bloomfield, CT 06002
Type :	Round Base Elev (ft): 0.00
Height :(ft)	120.00 Taper: 0.000000 (in/ft)

Sections Properties							
Shaft Section	Length (ft)	Diameter (In)		Thick (In)	Joint Type	Overlap Length (In)	Steel Taper (In/ft) Grade (ksi)
		Across Top	Flats Bottom				
1	30.000	36.00	36.00	0.375		0.000	0.000000 42
2	30.000	30.00	30.00	0.375	Butt Joint	0.000	0.000000 42
3	30.000	24.00	24.00	0.375	Butt Joint	0.000	0.000000 42
4	30.000	24.00	24.00	0.250	Butt Joint	0.000	0.000000 42

Discrete Appurtenance					
Attach Elev (ft)	Force Elev (ft)	Type	Qty	Description	
115.500	117.750	Platform	1	Platform, Mini w/rail	
115.500	120.000	Panel	6	DB980H90	
115.500	120.000	Panel	3	DB980H90 (future)	
107.000	107.000	Panel	12	DR65-18-XX	
107.000	107.000	Platform	1	Platform, Mini w/o rails	
97.000	97.000	Panel	9	DUO4-8670	
97.000	97.000	Platform	1	Platform, Mini w/rail	
87.000	87.000	Panel	12	DB848H90	
87.000	88.500	Platform	1	Platform w/Rail	
59.000	59.000	Straight	1	STANDOFF	
59.000	66.280	Whip	1	DB536	

Load Cases / Deflections			
Load Case	Attach Elev (ft)	Translation (In)	Rotation (deg)
<b>No Ice</b>	<b>No Ice Wind Speed = 80.00 mph w/ No Ice</b>		
	115.500	50.38	-3.680
	107.000	43.86	-3.645
	97.000	36.34	-3.515
	87.000	29.20	-3.297
	59.000	13.30	-2.151
<b>Ice</b>	<b>Ice Wind Speed = 69.28 mph w/ Ice 0.50 in Thick</b>		
	115.500	43.89	-3.217
	107.000	38.19	-3.185
	97.000	31.62	-3.069
	87.000	25.38	-2.876
	59.000	11.54	-1.869

Reactions			
Load Case	Moment (Kip-ft)	Shear (Kips)	Axial (Kips)
No Ice	1,545.542	17.233	-24.253
Ice	1,333.659	14.539	-31.351

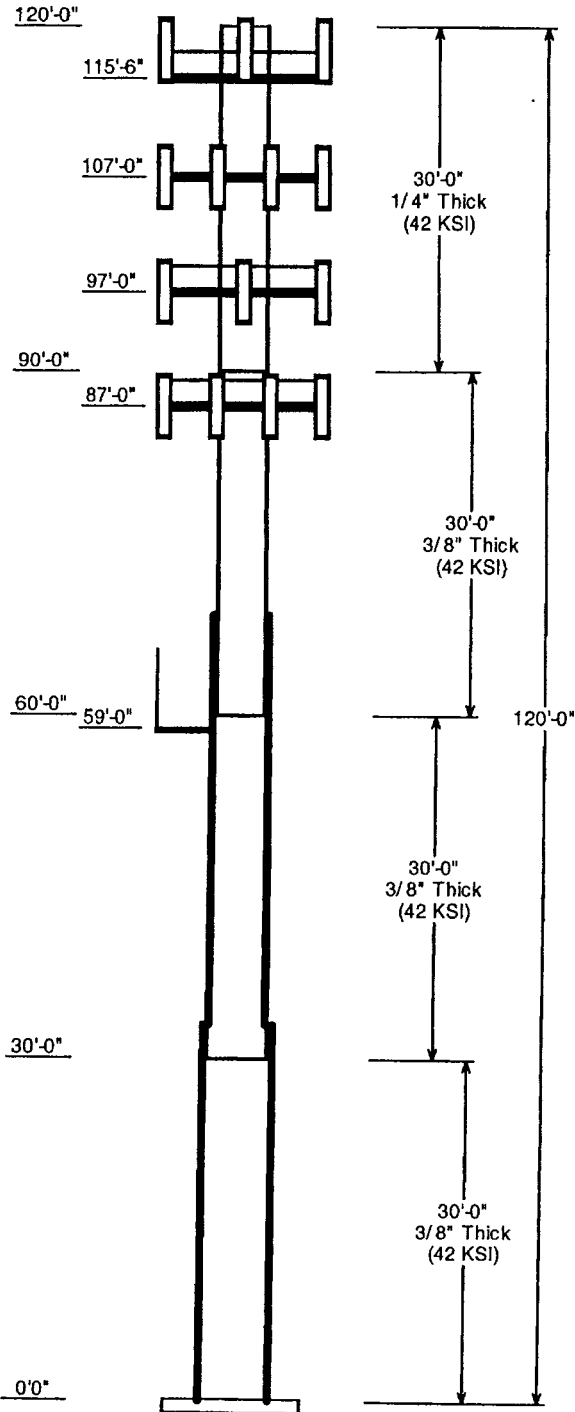

**Load Case : No Ice**

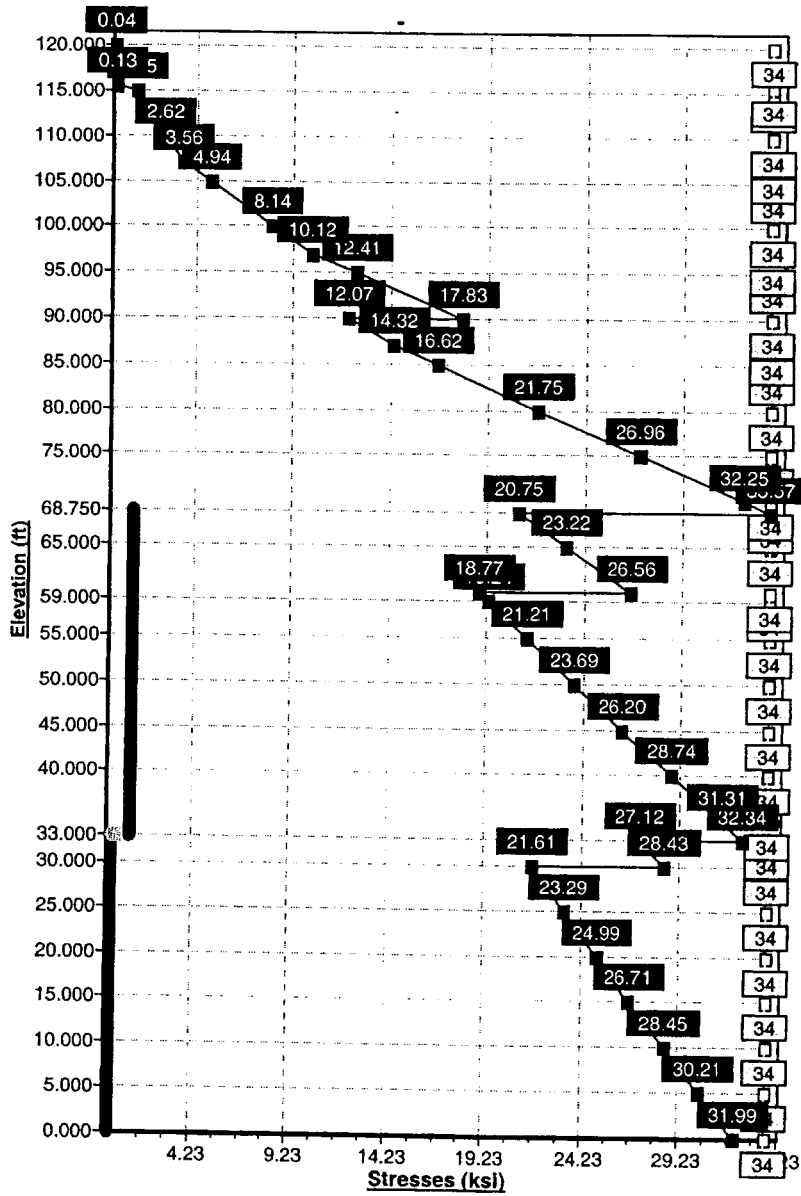

Pole : CT03XC076  
 Location : Hartford County, Bloomfield, CT 06002  
 Height : 120.0 (ft)  
 Shape : Round  
 Base Dia : 36.00 (in)  
 Taper : 0.000000 (in/ft)

Sprint Sites USA - NJ

Base Elev : 0.000 (ft)  
 Top Dia : 24.00 (in)

Copyright Semaan Engineering Solutions, Inc

8/27/2003 4:30:41 PM

Page: 1

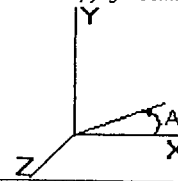

**Shaft Section Properties**

Sect Num	Length (ft)	Thick (in)	Fy (ksi)	Joint Type	Slip Joint Len (in)	Weight (lb)	Bottom				Top				Taper (in/ft)				
							Dia (in)	Elev (ft)	Area (sqin)	Ix (in^4)	W/t Ratio	D/t Ratio	Dia (in)	Elev (ft)		Area (sqin)	Ix (in^4)	W/t Ratio	D/t Ratio
1	30.000	0.3750	42		0.00	4,284	36.00	0.000	41.97	6663.3	0.00	96.00	36.00	30.00	41.97	6663.3	0.00	96.00	0.00000
2	30.000	0.3750	42	Butt Joint	0.00	3,563	30.00	30.00	34.90	3831.8	0.00	80.00	30.00	60.00	34.90	3831.8	0.00	80.00	0.00000
3	30.000	0.3750	42	Butt Joint	0.00	2,841	24.00	60.00	27.83	1943.3	0.00	64.00	24.00	90.00	27.83	1943.3	0.00	64.00	0.00000
4	30.000	0.2500	42	Butt Joint	0.00	1,904	24.00	90.00	18.65	1316.2	0.00	96.00	24.00	120.00	18.65	1316.2	0.00	96.00	0.00000
Shaft Weight						12,593													

**Discrete Appurtenance Properties**

Attach Elev (ft)	Description	Qty	Weight (lb)	No Ice CaAa (sf)	CaAa Factor	Weight (lb)	Ice CaAa (sf)	CaAa Factor	Distance From Face (ft)	X Angle (deg)	Vert Ecc (ft)
115.5	Platform, Mini w/rail	1	1500.00	33.500	1.00	2500.00	41.800	1.00	0.000	0.00	2.250
115.5	DB980H90	6	9.00	3.280	0.67	28.00	3.850	0.67	0.000	0.00	4.500
115.5	DB980H90 (future)	3	9.00	3.280	0.67	28.00	3.850	0.67	0.000	0.00	4.500
107.0	DR65-18-XX	12	24.00	6.300	0.67	56.00	7.000	0.67	0.000	0.00	0.000
107.0	Platform, Mini w/o rails	1	1000.00	16.690	1.00	1500.00	18.510	1.00	0.000	0.00	0.000
97.00	DUO4-8670	9	30.80	6.533	1.00	73.00	7.150	1.00	0.000	0.00	0.000
97.00	Platform, Mini w/rail	1	1500.00	33.500	1.00	2500.00	41.800	1.00	0.000	0.00	0.000
87.00	DB848H90	12	28.00	6.800	0.67	68.00	8.000	0.67	0.000	0.00	0.000
87.00	Platform w/Rail	1	2500.00	35.850	1.00	3500.00	40.460	1.00	0.000	0.00	1.500
59.00	STANDOFF	1	70.00	5.150	1.00	100.00	7.100	1.00	0.000	0.00	0.000
59.00	DB536	1	20.00	2.250	1.00	40.00	4.500	1.00	0.000	0.00	7.280
Totals		48	7572.20			12537.00			Number of Loadings : 11		

**Additional Steel**

Elev From (ft)	Elev To (ft)	Qty	Description	Fy (ksi)	Offset (in)	Hole Dia (in)	Linear Weight (lb/ft)	Thick (in)	Weight (lb)	Len (ft)
0.00	33.00	4	CH C8 x 18.75	50	0.00	1.50	18.75	0.48	2475.00	132.00
33.00	68.75	4	CH C8 x 11.5	50	0.00	1.50	11.50	0.22	1644.50	143.00
									4119.50	

Pole : CT03XC076  
 Location: Hartford County, Bloomfield, CT 06002  
 Height : 120.0 (ft)  
 Shape : Round  
 Base Dia : 36.00 (in)  
 Taper : 0.000000 (in/ft)

Sprint Sites USA - NJ

Base Elev : 0.000 (ft)

Top Dia : 24.00 (in)

Copyright Semaan Engineering Solutions, Inc

8/27/2003 4:30:41 PM

Page: 2

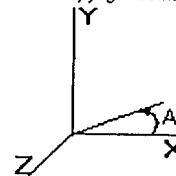

**Segment Properties** (Max Len : 5 ft)

Seg Elev (ft)	Description	Thick (in)	Dia (in)	Area (in^2)	Ix (in^4)	W/t Ratio	D/t Ratio	Fy (ksi)	Fb (ksi)	Fa (ksi)	Weight (lb)	Additional Reinforcing		
												Area (in^2)	Ix (in^4)	Weight (lb)
0.00		0.3750	36.000	41.970	6,663.3	0.00	96.00	42	34	33	0.0	19.11	3,914	0.0
5.00		0.3750	36.000	41.970	6,663.3	0.00	96.00	42	34	33	714.1	19.11	3,914	375.0
10.00		0.3750	36.000	41.970	6,663.3	0.00	96.00	42	34	33	714.1	19.11	3,914	375.0
15.00		0.3750	36.000	41.970	6,663.3	0.00	96.00	42	34	33	714.1	19.11	3,914	375.0
20.00		0.3750	36.000	41.970	6,663.3	0.00	96.00	42	34	33	714.1	19.11	3,914	375.0
25.00		0.3750	36.000	41.970	6,663.3	0.00	96.00	42	34	33	714.1	19.11	3,914	375.0
30.00	Top - Section 1	0.3750	36.000	41.970	6,663.3	0.00	96.00	42	34	33	714.1	19.11	3,914	375.0
30.00	Bot - Section 2	0.3750	30.000	34.901	3,831.8	0.00	80.00	42	34	34		19.11	2,853	
33.00	Reinf. Top Reinf	0.3750	30.000	34.901	3,831.8	0.00	80.00	42	34	34	356.3	19.11	2,853	225.0
35.00		0.3750	30.000	34.901	3,831.8	0.00	80.00	42	34	34	237.5	12.20	1,769	92.0
40.00		0.3750	30.000	34.901	3,831.8	0.00	80.00	42	34	34	593.8	12.20	1,769	230.0
45.00		0.3750	30.000	34.901	3,831.8	0.00	80.00	42	34	34	593.8	12.20	1,769	230.0
50.00		0.3750	30.000	34.901	3,831.8	0.00	80.00	42	34	34	593.8	12.20	1,769	230.0
55.00		0.3750	30.000	34.901	3,831.8	0.00	80.00	42	34	34	593.8	12.20	1,769	230.0
59.00		0.3750	30.000	34.901	3,831.8	0.00	80.00	42	34	34	475.0	12.20	1,769	184.0
60.00	Top - Section 2	0.3750	30.000	34.901	3,831.8	0.00	80.00	42	34	34	118.8	12.20	1,769	46.0
60.00	Bot - Section 3	0.3750	24.000	27.833	1,943.3	0.00	64.00	42	34	34		12.20	1,213	
65.00		0.3750	24.000	27.833	1,943.3	0.00	64.00	42	34	34	473.5	12.20	1,213	230.0
68.75	Reinf. Top	0.3750	24.000	27.833	1,943.3	0.00	64.00	42	34	34	355.2	12.20	1,213	172.5
70.00		0.3750	24.000	27.833	1,943.3	0.00	64.00	42	34	34	118.4			
75.00		0.3750	24.000	27.833	1,943.3	0.00	64.00	42	34	34	473.5			
80.00		0.3750	24.000	27.833	1,943.3	0.00	64.00	42	34	34	473.5			
85.00		0.3750	24.000	27.833	1,943.3	0.00	64.00	42	34	34	473.5			
87.00		0.3750	24.000	27.833	1,943.3	0.00	64.00	42	34	34	189.4			
90.00	Top - Section 3	0.3750	24.000	27.833	1,943.3	0.00	64.00	42	34	34	284.1			
90.00	Bot - Section 4	0.2500	24.000	18.653	1,316.2	0.00	96.00	42	34	33				
95.00		0.2500	24.000	18.653	1,316.2	0.00	96.00	42	34	33	317.4			
97.00		0.2500	24.000	18.653	1,316.2	0.00	96.00	42	34	33	126.9			
100.00		0.2500	24.000	18.653	1,316.2	0.00	96.00	42	34	33	190.4			
105.00		0.2500	24.000	18.653	1,316.2	0.00	96.00	42	34	33	317.4			
107.00		0.2500	24.000	18.653	1,316.2	0.00	96.00	42	34	33	126.9			
110.00		0.2500	24.000	18.653	1,316.2	0.00	96.00	42	34	33	190.4			
115.00		0.2500	24.000	18.653	1,316.2	0.00	96.00	42	34	33	317.4			
115.50		0.2500	24.000	18.653	1,316.2	0.00	96.00	42	34	33	31.7			
120.00		0.2500	24.000	18.653	1,316.2	0.00	96.00	42	34	33	285.6			
											12,592.7	4,119.5		

Pole : CT03XC076  
 Location: Hartford County, Bloomfield, CT 06002  
 Height : 120.0 (ft)  
 Shape : Round  
 Base Dia : 36.00 (in)  
 Taper : 0.000000 (in/ft)

Sprint Sites USA - NJ  
 Base Elev : 0.000 (ft)  
 Top Dia : 24.00 (in)

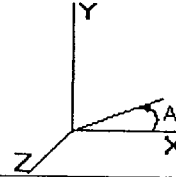

<b>Load Case:</b> No Ice	80 mph - No Ice	23 Iterations
Gust Response Factor : 1.69	Effective Wind Speed : 80.00 (mph)	
Dead Load Factor : 1.00		
Wind Load Factor : 1.00		

**Shaft Forces**

Seg Top Elev (ft)	Description	Kz	qz (psf)	qzGh (psf)	C (mph-ft)	Cf	Tributary (ft)	Aa (sf)	CfAa (sf)	Wind Force X (lb)	Wind Force Z (lb)	Weight (lb)
0.00		1.00	16.38	27.68	240.00	0.590	0.00	0.000	0.000	0.00	0.00	0.0
5.00		1.00	16.38	27.68	240.00	0.590	5.00	15.000	8.850	245.05	0.00	1,089.1
10.00		1.00	16.38	27.68	240.00	0.590	5.00	15.000	8.850	245.05	0.00	1,089.1
15.00		1.00	16.38	27.68	240.00	0.590	5.00	15.000	8.850	245.05	0.00	1,089.1
20.00		1.00	16.38	27.68	240.00	0.590	5.00	15.000	8.850	245.05	0.00	1,089.1
25.00		1.00	16.38	27.68	240.00	0.590	5.00	15.000	8.850	245.05	0.00	1,089.1
30.00	Top - Section 1	1.00	16.38	27.68	240.00	0.590	5.00	15.000	8.850	245.05	0.00	1,089.1
33.00	Reinf. Top Reinf Bottom	1.00	16.38	27.68	200.00	0.590	3.00	7.500	4.425	122.52	0.00	581.3
35.00		1.01	16.66	28.15	201.69	0.590	2.00	5.000	2.950	83.07	0.00	329.5
40.00		1.05	17.31	29.25	205.57	0.590	5.00	12.500	7.375	215.74	0.00	823.8
45.00		1.09	17.90	30.25	209.06	0.590	5.00	12.500	7.375	223.13	0.00	823.8
50.00		1.12	18.44	31.17	212.23	0.590	5.00	12.500	7.375	229.95	0.00	823.8
55.00		1.15	18.95	32.04	215.14	0.590	5.00	12.500	7.375	236.29	0.00	823.8
59.00	Appertunance(s)	1.18	19.34	32.68	217.31	0.590	4.00	10.000	5.900	192.87	0.00	659.0
60.00	Top - Section 2	1.18	19.43	32.84	217.83	0.590	1.00	2.500	1.475	48.45	0.00	164.8
65.00		1.21	19.88	33.60	176.27	0.590	5.00	10.000	5.900	198.28	0.00	703.5
68.75	Reinf. Top	1.23	20.20	34.14	177.69	0.590	3.75	7.500	4.425	151.11	0.00	527.7
70.00		1.24	20.31	34.32	178.15	0.590	1.25	2.500	1.475	50.63	0.00	118.4
75.00		1.26	20.71	35.00	179.91	0.590	5.00	10.000	5.900	206.55	0.00	473.5
80.00		1.28	21.10	35.66	181.58	0.590	5.00	10.000	5.900	210.40	0.00	473.5
85.00		1.31	21.46	36.28	183.16	0.590	5.00	10.000	5.900	214.07	0.00	473.5
87.00	Appertunance(s)	1.31	21.61	36.52	183.77	0.590	2.00	4.000	2.360	86.20	0.00	189.4
90.00	Top - Section 3	1.33	21.82	36.88	184.66	0.590	3.00	6.000	3.540	130.56	0.00	284.1
95.00		1.35	22.16	37.45	186.09	0.590	5.00	10.000	5.900	220.98	0.00	317.4
97.00	Appertunance(s)	1.36	22.29	37.67	186.64	0.590	2.00	4.000	2.360	88.92	0.00	126.9
100.00		1.37	22.49	38.00	187.46	0.590	3.00	6.000	3.540	134.55	0.00	190.4
105.00		1.39	22.80	38.54	188.77	0.590	5.00	10.000	5.900	227.39	0.00	317.4
107.00	Appertunance(s)	1.39	22.92	38.75	189.28	0.590	2.00	4.000	2.360	91.45	0.00	126.9
110.00		1.41	23.11	39.05	190.03	0.590	3.00	6.000	3.540	138.26	0.00	190.4
115.00		1.42	23.40	39.55	191.24	0.590	5.00	10.000	5.900	233.38	0.00	317.4
115.50	Appertunance(s)	1.43	23.43	39.60	191.36	0.590	0.50	1.000	0.590	23.37	0.00	31.7
120.00		1.44	23.69	40.04	192.40	0.590	4.50	9.000	5.310	212.61	0.00	285.6
<b>Totals:</b>							120.00			5,441.02	0.00	16,712.2



Pole : CT03XC076  
 Location: Hartford County, Bloomfield, CT 06002  
 Height : 120.0 (ft)  
 Shape : Round  
 Base Dia : 36.00 (in)  
 Taper : 0.000000 (in/ft)

Sprint Sites USA - NJ

Base Elev : 0.000 (ft)  
 Top Dia : 24.00 (in)

Copyright Semaan Engineering Solutions, Inc

8/27/2003 4:30:42 PM

Page: 4

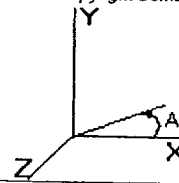

**Load Case:** No Ice      80 mph - No Ice      23 Iterations  
 Gust Response Factor : 1.69      Effective Wind Speed : 80.00 (mph)  
 Dead Load Factor : 1.00  
 Wind Load Factor : 1.00

**Discrete Appurtenance Forces**

Elev (ft)	Description	Qty	qz (psf)	qzGh (psf)	Total CaAa (sf)	CaAa Factor	Horiz Ecc (ft)	Vert Ecc (ft)	X Angle (deg)	Wind Force X (lb)	Wind Force Z (lb)	Mom X (lb-ft)	Mom Y (lb-ft)	Mom Z (lb-ft)	Weight (lb)
59.00	STANDOFF	1	19.34	32.68	5.150	1.000	0.000	0.0	0.0	168.35	0.00	0.00	0.00	0.00	70.0
59.00	DB536	1	19.99	33.79	2.250	1.000	0.000	7.3	0.0	76.04	0.00	0.00	0.00	553.55	20.0
87.00	DB848H90	12	21.61	36.52	54.419	0.667	0.000	0.0	0.0	1987.67	0.00	0.00	0.00	0.00	336.0
87.00	Platform w/Rail	1	21.71	36.70	35.850	1.000	0.000	1.5	0.0	1315.84	0.00	0.00	0.00	1973.76	2500.0
97.00	DUO4-8670	9	22.29	37.67	58.797	1.000	0.000	0.0	0.0	2215.39	0.00	0.00	0.00	0.00	277.2
97.00	Platform, Mini w/rail	1	22.29	37.67	33.500	1.000	0.000	0.0	0.0	1262.23	0.00	0.00	0.00	0.00	1500.0
107.00	DR65-18-XX	12	22.92	38.75	50.425	0.667	0.000	0.0	0.0	1953.97	0.00	0.00	0.00	0.00	288.0
107.00	Platform, Mini w/o rails	1	22.92	38.75	16.690	1.000	0.000	0.0	0.0	646.73	0.00	0.00	0.00	0.00	1000.0
115.50	Platform, Mini w/rail	1	23.56	39.82	33.500	1.000	0.000	2.3	0.0	1334.12	0.00	0.00	0.00	3001.76	1500.0
115.50	DB980H90	6	23.69	40.04	13.127	0.667	0.000	4.5	0.0	525.59	0.00	0.00	0.00	2365.16	54.0
115.50	DB980H90 (future)	3	23.69	40.04	6.562	0.667	0.000	4.5	0.0	262.75	0.00	0.00	0.00	1182.37	27.0
										11,748.6	0.00			7,572.2	

Pole : CT03XC076  
 Location: Hartford County, Bloomfield, CT 06002  
 Height : 120.0 (ft)  
 Shape : Round  
 Base Dia : 36.00 (in)  
 Taper : 0.000000 (in/ft)

Sprint Sites USA - NJ

Base Elev : 0.000 (ft)  
 Top Dia : 24.00 (in)

Copyright Semaan Engineering Solutions, Inc

8/27/2003 4:30:42 PM

Page: 5

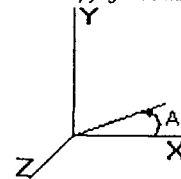

**Load Case:** No Ice      80 mph - No Ice      23 Iterations

Gust Response Factor : 1.69      Effective Wind Speed : 80.00 (mph)

Dead Load Factor : 1.00

Wind Load Factor : 1.00

**Applied Forces Summary**

Seg Elev (ft)	X Coord (ft)	Z Coord (ft)	Lateral FX (-) (lb)	Axial FY (-) (lb)	Lateral FZ (lb)	Moment MX (lb-ft)	Torsion MY (lb-ft)	Moment MZ (lb-ft)
0.00	0.00	0.00	0.00	0.00	0.00	0.00	0.00	0.00
5.00	0.00	0.00	245.05	1,089.07	0.00	0.00	0.00	0.00
10.00	0.00	0.00	245.05	1,089.07	0.00	0.00	0.00	0.00
15.00	0.00	0.00	245.05	1,089.07	0.00	0.00	0.00	0.00
20.00	0.00	0.00	245.05	1,089.07	0.00	0.00	0.00	0.00
25.00	0.00	0.00	245.05	1,089.07	0.00	0.00	0.00	0.00
30.00	0.00	0.00	245.05	1,089.07	0.00	0.00	0.00	0.00
33.00	0.00	0.00	122.52	581.28	0.00	0.00	0.00	0.00
35.00	0.00	0.00	83.07	329.52	0.00	0.00	0.00	0.00
40.00	0.00	0.00	215.74	823.80	0.00	0.00	0.00	0.00
45.00	0.00	0.00	223.13	823.80	0.00	0.00	0.00	0.00
50.00	0.00	0.00	229.95	823.80	0.00	0.00	0.00	0.00
55.00	0.00	0.00	236.29	823.80	0.00	0.00	0.00	0.00
59.00	0.00	0.00	437.25	749.04	0.00	0.00	0.00	0.00
60.00	0.00	0.00	48.45	164.76	0.00	0.00	0.00	553.55
65.00	0.00	0.00	198.28	703.54	0.00	0.00	0.00	0.00
68.75	0.00	0.00	151.11	527.65	0.00	0.00	0.00	0.00
70.00	0.00	0.00	50.63	118.38	0.00	0.00	0.00	0.00
75.00	0.00	0.00	206.55	473.54	0.00	0.00	0.00	0.00
80.00	0.00	0.00	210.40	473.54	0.00	0.00	0.00	0.00
85.00	0.00	0.00	214.07	473.54	0.00	0.00	0.00	0.00
87.00	0.00	0.00	3,389.72	3,025.42	0.00	0.00	0.00	0.00
90.00	0.00	0.00	130.56	284.12	0.00	0.00	0.00	1,973.76
95.00	0.00	0.00	220.98	317.36	0.00	0.00	0.00	0.00
97.00	0.00	0.00	3,566.54	1,904.15	0.00	0.00	0.00	0.00
100.00	0.00	0.00	134.55	190.42	0.00	0.00	0.00	0.00
105.00	0.00	0.00	227.39	317.36	0.00	0.00	0.00	0.00
107.00	0.00	0.00	2,692.15	1,414.95	0.00	0.00	0.00	0.00
110.00	0.00	0.00	138.26	190.42	0.00	0.00	0.00	0.00
115.00	0.00	0.00	233.38	317.36	0.00	0.00	0.00	0.00
115.50	0.00	0.00	2,145.82	1,612.74	0.00	0.00	0.00	0.00
120.00	0.00	0.00	212.61	285.63	0.00	0.00	0.00	6,549.29
<b>Totals:</b>			<b>17,189.70</b>	<b>24,284.35</b>	<b>0.00</b>	<b>0.00</b>	<b>0.00</b>	<b>9,076.60</b>

Pole : CT03XC076  
 Location: Hartford County, Bloomfield, CT 06002  
 Height : 120.0 (ft)  
 Shape : Round  
 Base Dia : 36.00 (in)  
 Taper : 0.000000 (in/ft)

Sprint Sites USA - NJ

Base Elev : 0.000 (ft)

Top Dia : 24.00 (in)

Copyright Semaan Engineering Solutions, Inc

8/27/2003 4:30:42 PM

Page: 6

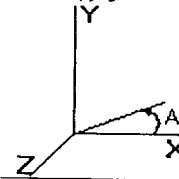

**Load Case:** No Ice      80 mph - No Ice      23 Iterations

Gust Response Factor : 1.69      Effective Wind Speed : 80.00 (mph)

Dead Load Factor : 1.00

Wind Load Factor : 1.00

**Calculated Forces and Deflections**

Seg Elev (ft)	Lateral FX (-) (kips)	Axial FY (-) (kips)	Lateral FZ (kips)	Moment MX (ft-kips)	Torsion MY (ft-kips)	Moment MZ (ft-kips)	X Deflect (in)	Z Deflect (in)	Total Deflect (in)	Rotation (deg)
0.00	17.233	24.253	0.000	0.000	0.000	1,545.542	0.000	0.000	0.000	0.000
5.00	17.065	23.106	0.000	0.000	0.000	1,459.377	-0.109	0.000	0.109	-0.202
10.00	16.886	21.964	0.000	0.000	0.000	1,374.051	-0.423	0.000	0.423	-0.393
15.00	16.695	20.827	0.000	0.000	0.000	1,289.623	-0.930	0.000	0.930	-0.572
20.00	16.493	19.694	0.000	0.000	0.000	1,206.152	-1.619	0.000	1.619	-0.739
25.00	16.281	18.566	0.000	0.000	0.000	1,123.689	-2.478	0.000	2.478	-0.896
30.00	16.052	17.449	0.000	0.000	0.000	1,042.284	-3.495	0.000	3.495	-1.042
33.00	15.943	16.847	0.000	0.000	0.000	994.127	-4.177	0.000	4.177	-1.124
35.00	15.900	16.475	0.000	0.000	0.000	962.241	-4.666	0.000	4.666	-1.207
40.00	15.726	15.595	0.000	0.000	0.000	882.745	-6.056	0.000	6.056	-1.441
45.00	15.533	14.722	0.000	0.000	0.000	804.116	-7.681	0.000	7.681	-1.656
50.00	15.323	13.857	0.000	0.000	0.000	726.451	-9.520	0.000	9.520	-1.850
55.00	15.093	13.002	0.000	0.000	0.000	649.838	-11.552	0.000	11.552	-2.025
59.00	14.645	12.250	0.000	0.000	0.000	588.914	-13.303	0.000	13.303	-2.151
60.00	14.608	12.066	0.000	0.000	0.000	574.270	-13.757	0.000	13.757	-2.180
65.00	14.412	11.333	0.000	0.000	0.000	501.230	-16.114	0.000	16.114	-2.317
68.75	14.258	10.786	0.000	0.000	0.000	447.186	-17.999	0.000	17.999	-2.477
70.00	14.235	10.627	0.000	0.000	0.000	429.364	-18.654	0.000	18.654	-2.526
75.00	14.053	10.100	0.000	0.000	0.000	358.192	-21.457	0.000	21.457	-2.815
80.00	13.854	9.587	0.000	0.000	0.000	287.930	-24.533	0.000	24.533	-3.051
85.00	13.633	9.097	0.000	0.000	0.000	218.663	-27.830	0.000	27.830	-3.237
87.00	10.083	6.258	0.000	0.000	0.000	189.424	-29.199	0.000	29.199	-3.297
90.00	9.946	5.967	0.000	0.000	0.000	159.174	-31.295	0.000	31.295	-3.373
95.00	9.713	5.651	0.000	0.000	0.000	109.445	-34.881	0.000	34.881	-3.472
97.00	6.040	3.963	0.000	0.000	0.000	90.019	-36.344	0.000	36.344	-3.515
100.00	5.898	3.775	0.000	0.000	0.000	71.898	-38.569	0.000	38.569	-3.567
105.00	5.654	3.469	0.000	0.000	0.000	42.406	-42.339	0.000	42.339	-3.629
107.00	2.878	2.227	0.000	0.000	0.000	31.099	-43.862	0.000	43.862	-3.645
110.00	2.728	2.045	0.000	0.000	0.000	22.466	-46.156	0.000	46.156	-3.662
115.00	2.475	1.743	0.000	0.000	0.000	8.824	-50.000	0.000	50.000	-3.679
115.50	0.230	0.271	0.000	0.000	0.000	1.037	-50.385	0.000	50.385	-3.680
120.00	0.213	0.000	0.000	0.000	0.000	0.000	-53.851	0.000	53.851	-3.680

Pole : CT03XC076  
 Location: Hartford County, Bloomfield, CT 06002  
 Height : 120.0 (ft)  
 Shape : Round  
 Base Dia : 36.00 (in)  
 Taper : 0.000000 (in/ft)

Sprint Sites USA - NJ  
 Base Elev : 0.000 (ft)  
 Top Dia : 24.00 (in)

Copyright Semaan Engineering Solutions, Inc  
 8/27/2003 4:30:42 PM  
 Page: 7

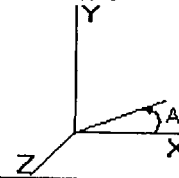

**Load Case:** No Ice      80 mph - No Ice      23 Iterations

Gust Response Factor : 1.69      Effective Wind Speed : 80.00 (mph)

Dead Load Factor : 1.00

Wind Load Factor : 1.00

**Calculated Stresses**

Seg Elev (ft)	Applied Stresses							Combined (ksi)	Allowable Stress (Fb) (ksi)	Allowable Stress (Fa) (ksi)	Stress Ratio
	Axial (Y) (ksi)	Shear (X) (ksi)	Shear (Z) (ksi)	Torsion (ksi)	Bending (X) (ksi)	Bending (Z) (ksi)					
0.00	0.397	0.822	0.000	0.000	0.000	31.560	31.988	33.6	33.1	0.952	
5.00	0.378	0.814	0.000	0.000	0.000	29.800	30.211	33.6	33.1	0.899	
10.00	0.360	0.805	0.000	0.000	0.000	28.058	28.452	33.6	33.1	0.847	
15.00	0.341	0.796	0.000	0.000	0.000	26.334	26.710	33.6	33.1	0.795	
20.00	0.322	0.786	0.000	0.000	0.000	24.629	24.989	33.6	33.1	0.744	
25.00	0.304	0.776	0.000	0.000	0.000	22.945	23.288	33.6	33.1	0.693	
30.00	0.286	0.765	0.000	0.000	0.000	21.283	21.610	33.6	33.1	0.643	
33.00	0.312	0.914	0.000	0.000	0.000	28.062	28.430	33.6	33.6	0.846	
35.00	0.350	0.912	0.000	0.000	0.000	26.766	27.124	33.6	33.6	0.807	
40.00	0.331	0.902	0.000	0.000	0.000	30.923	31.312	33.6	33.6	0.932	
45.00	0.313	0.891	0.000	0.000	0.000	28.368	28.742	33.6	33.6	0.855	
50.00	0.294	0.879	0.000	0.000	0.000	25.841	26.199	33.6	33.6	0.780	
55.00	0.276	0.865	0.000	0.000	0.000	23.345	23.688	33.6	33.6	0.705	
59.00	0.260	0.840	0.000	0.000	0.000	20.883	21.212	33.6	33.6	0.631	
60.00	0.256	0.838	0.000	0.000	0.000	18.925	19.241	33.6	33.6	0.573	
60.00	0.301	1.050	0.000	0.000	0.000	18.455	18.767	33.6	33.6	0.559	
65.00	0.283	1.036	0.000	0.000	0.000	26.200	26.563	33.6	33.6	0.791	
68.75	0.269	1.025	0.000	0.000	0.000	22.867	23.220	33.6	33.6	0.691	
70.00	0.382	1.023	0.000	0.000	0.000	20.402	20.747	33.6	33.6	0.618	
75.00	0.363	1.010	0.000	0.000	0.000	31.816	32.247	33.6	33.6	0.960	
80.00	0.344	0.996	0.000	0.000	0.000	26.542	26.962	33.6	33.6	0.803	
85.00	0.327	0.980	0.000	0.000	0.000	21.336	21.749	33.6	33.6	0.647	
87.00	0.225	0.725	0.000	0.000	0.000	16.203	16.617	33.6	33.6	0.495	
90.00	0.214	0.715	0.000	0.000	0.000	14.037	14.317	33.6	33.6	0.426	
90.00	0.320	1.067	0.000	0.000	0.000	11.795	12.073	33.6	33.6	0.359	
95.00	0.303	1.042	0.000	0.000	0.000	17.415	17.830	33.6	33.1	0.531	
97.00	0.212	0.648	0.000	0.000	0.000	11.974	12.409	33.6	33.1	0.369	
100.00	0.202	0.633	0.000	0.000	0.000	9.849	10.123	33.6	33.1	0.301	
105.00	0.186	0.607	0.000	0.000	0.000	7.866	8.142	33.6	33.1	0.242	
107.00	0.119	0.309	0.000	0.000	0.000	4.639	4.939	33.6	33.1	0.147	
110.00	0.110	0.293	0.000	0.000	0.000	3.402	3.562	33.6	33.1	0.106	
115.00	0.093	0.266	0.000	0.000	0.000	2.458	2.617	33.6	33.1	0.078	
115.50	0.015	0.025	0.000	0.000	0.000	0.965	1.154	33.6	33.1	0.034	
120.00	0.000	0.023	0.000	0.000	0.000	0.113	0.135	33.6	33.1	0.004	
						0.000	0.040	33.6	33.1	0.001	

Pole : CT03XC076  
 Location: Hartford County, Bloomfield, CT 06002  
 Height : 120.0 (ft)  
 Shape : Round  
 Base Dia : 36.00 (in)  
 Taper : 0.000000 (in/ft)

Sprint Sites USA - NJ  
 Base Elev : 0.000 (ft)  
 Top Dia : 24.00 (in)

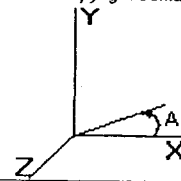

<b>Load Case:</b> Ice	80 mph - With Ice - Ice Thickness = 0.5 in	23 Iterations
Gust Response Factor : 1.69	Effective Wind Speed : 69.28 (mph)	
Dead Load Factor : 1.00		
Wind Load Factor : 1.00		

**Shaft Forces**

Seg Top Elev (ft)	Description	Kz	qz (psf)	qzGh (psf)	C (mph-ft)	Cf	Tributary (ft)	Aa (sf)	CfAa (sf)	Wind Force X (lb)	Wind Force Z (lb)	Weight (lb)
0.00		1.00	12.28	20.76	207.84	0.590	0.00	0.000	0.000	0.00	0.00	0.0
5.00		1.00	12.28	20.76	207.84	0.590	5.00	15.417	9.096	188.88	0.00	1,200.5
10.00		1.00	12.28	20.76	207.84	0.590	5.00	15.417	9.096	188.88	0.00	1,200.5
15.00		1.00	12.28	20.76	207.84	0.590	5.00	15.417	9.096	188.88	0.00	1,200.5
20.00		1.00	12.28	20.76	207.84	0.590	5.00	15.417	9.096	188.88	0.00	1,200.5
25.00		1.00	12.28	20.76	207.84	0.590	5.00	15.417	9.096	188.88	0.00	1,200.5
30.00	Top - Section 1	1.00	12.28	20.76	207.84	0.590	5.00	15.417	9.096	188.88	0.00	1,200.5
33.00	Reinf. Top Reinf Bottom	1.00	12.28	20.76	173.20	0.590	3.00	7.750	4.572	94.95	0.00	637.1
35.00		1.01	12.49	21.11	174.66	0.590	2.00	5.167	3.048	64.37	0.00	366.8
40.00		1.05	12.98	21.93	178.03	0.590	5.00	12.917	7.621	167.19	0.00	916.9
45.00		1.09	13.42	22.69	181.05	0.590	5.00	12.917	7.621	172.91	0.00	916.9
50.00		1.12	13.83	23.38	183.79	0.590	5.00	12.917	7.621	178.20	0.00	916.9
55.00		1.15	14.21	24.02	186.31	0.590	5.00	12.917	7.621	183.12	0.00	916.9
59.00	Appertunance(s)	1.18	14.50	24.51	188.19	0.590	4.00	10.333	6.097	149.46	0.00	733.5
60.00	Top - Section 2	1.18	14.57	24.63	188.64	0.590	1.00	2.583	1.524	37.55	0.00	183.4
65.00		1.21	14.91	25.20	152.65	0.590	5.00	10.417	6.146	154.89	0.00	778.3
68.75	Reinf. Top	1.23	15.15	25.61	153.88	0.590	3.75	7.813	4.609	118.05	0.00	583.7
70.00		1.24	15.23	25.74	154.27	0.590	1.25	2.604	1.536	39.55	0.00	137.1
75.00		1.26	15.53	26.25	155.80	0.590	5.00	10.417	6.146	161.36	0.00	548.3
80.00		1.28	15.82	26.74	157.25	0.590	5.00	10.417	6.146	164.36	0.00	548.3
85.00		1.31	16.10	27.21	158.61	0.590	5.00	10.417	6.146	167.23	0.00	548.3
87.00	Appertunance(s)	1.31	16.20	27.39	159.14	0.590	2.00	4.167	2.458	67.34	0.00	219.3
90.00	Top - Section 3	1.33	16.36	27.65	159.91	0.590	3.00	6.250	3.687	101.99	0.00	329.0
95.00		1.35	16.62	28.09	161.15	0.590	5.00	10.417	6.146	172.63	0.00	392.2
97.00	Appertunance(s)	1.36	16.72	28.25	161.63	0.590	2.00	4.167	2.458	69.47	0.00	156.9
100.00		1.37	16.86	28.50	162.34	0.590	3.00	6.250	3.687	105.11	0.00	235.3
105.00		1.39	17.10	28.90	163.47	0.590	5.00	10.417	6.146	177.64	0.00	392.2
107.00	Appertunance(s)	1.39	17.19	29.06	163.92	0.590	2.00	4.167	2.458	71.44	0.00	156.9
110.00		1.41	17.33	29.29	164.56	0.590	3.00	6.250	3.687	108.01	0.00	235.3
115.00		1.42	17.55	29.66	165.61	0.590	5.00	10.417	6.146	182.32	0.00	392.2
115.50	Appertunance(s)	1.43	17.57	29.70	165.72	0.590	0.50	1.042	0.615	18.25	0.00	39.2
120.00		1.44	17.76	30.02	166.62	0.590	4.50	9.375	5.531	166.09	0.00	352.9
<b>Totals:</b>							<b>120.00</b>			<b>4,226.78</b>	<b>0.00</b>	<b>18,836.9</b>

Pole : CT03XC076      Sprint Sites USA - NJ  
 Location: Hartford County, Bloomfield, CT 06002  
 Height : 120.0 (ft)      Base Elev : 0.000 (ft)  
 Shape : Round      Top Dia : 24.00 (in)  
 Base Dia : 36.00 (in)  
 Taper : 0.000000 (in/ft)

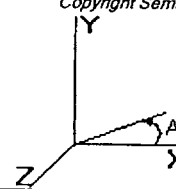

**Load Case:** Ice      80 mph - With Ice - Ice Thickness = 0.5 in      23 Iterations  
 Gust Response Factor : 1.69      Effective Wind Speed : 69.28 (mph)  
 Dead Load Factor : 1.00  
 Wind Load Factor : 1.00

**Discrete Appurtenance Forces**

Elev (ft)	Description	Qty	qz (psf)	qzGh (psf)	Total CaAa (sf)	CaAa Factor	Horiz Ecc (ft)	Vert Ecc (ft)	X Angle (deg)	Wind Force X (lb)	Wind Force Z (lb)	Mom X (lb-ft)	Mom Y (lb-ft)	Mom Z (lb-ft)	Weight (lb)
59.00	STANDOFF	1	14.50	24.51	7.100	1.000	0.000	0.0	0.0	174.06	0.00	0.00	0.00	0.00	100.0
59.00	DB536	1	14.99	25.34	4.500	1.000	0.000	7.3	0.0	114.05	0.00	0.00	0.00	830.27	40.0
87.00	DB848H90	12	16.20	27.39	64.022	0.667	0.000	0.0	0.0	1753.73	0.00	0.00	0.00	0.00	816.0
87.00	Platform w/Rail	1	16.28	27.52	40.460	1.000	0.000	1.5	0.0	1113.72	0.00	0.00	0.00	1670.58	3500.0
97.00	DUO4-8670	9	16.72	28.25	64.350	1.000	0.000	0.0	0.0	1818.36	0.00	0.00	0.00	0.00	657.0
97.00	Platform, Mini w/rail	1	16.72	28.25	41.800	1.000	0.000	0.0	0.0	1181.15	0.00	0.00	0.00	0.00	2500.0
107.00	DR65-18-XX	12	17.19	29.06	56.028	0.667	0.000	0.0	0.0	1628.21	0.00	0.00	0.00	0.00	672.0
107.00	Platform, Mini w/o rails	1	17.19	29.06	18.510	1.000	0.000	0.0	0.0	537.91	0.00	0.00	0.00	0.00	1500.0
115.50	Platform, Mini w/rail	1	17.67	29.86	41.800	1.000	0.000	2.3	0.0	1248.42	0.00	0.00	0.00	2808.94	2500.0
115.50	DB980H90	6	17.76	30.02	15.408	0.667	0.000	4.5	0.0	462.67	0.00	0.00	0.00	2082.01	168.0
115.50	DB980H90 (future)	3	17.76	30.02	7.702	0.667	0.000	4.5	0.0	231.29	0.00	0.00	0.00	1040.82	84.0
										10,263.5	0.00				12,537.0



Pole : CT03XC076  
 Location: Hartford County, Bloomfield, CT 06002  
 Height : 120.0 (ft)  
 Shape : Round  
 Base Dia : 36.00 (in)  
 Taper : 0.000000 (in/ft)

Sprint Sites USA - NJ

Base Elev : 0.000 (ft)  
 Top Dia : 24.00 (in)

Copyright Semaan Engineering Solutions, Inc

8/27/2003 4:30:42 PM

Page: 10

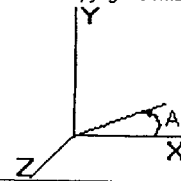

<b>Load Case:</b> Ice	80 mph - With Ice - Ice Thickness = 0.5 in	23 Iterations
Gust Response Factor : 1.69	Effective Wind Speed : 69.28 (mph)	
Dead Load Factor : 1.00		
Wind Load Factor : 1.00		

**Applied Forces Summary**

Seg Elev (ft)	X Coord (ft)	Z Coord (ft)	Lateral FX (-) (lb)	Axial FY (-) (lb)	Lateral FZ (lb)	Moment MX (lb-ft)	Torsion MY (lb-ft)	Moment MZ (lb-ft)
0.00	0.00	0.00	0.00	0.00	0.00	0.00	0.00	0.00
5.00	0.00	0.00	188.88	1,200.49	0.00	0.00	0.00	0.00
10.00	0.00	0.00	188.88	1,200.49	0.00	0.00	0.00	0.00
15.00	0.00	0.00	188.88	1,200.49	0.00	0.00	0.00	0.00
20.00	0.00	0.00	188.88	1,200.49	0.00	0.00	0.00	0.00
25.00	0.00	0.00	188.88	1,200.49	0.00	0.00	0.00	0.00
30.00	0.00	0.00	188.88	1,200.49	0.00	0.00	0.00	0.00
33.00	0.00	0.00	94.95	637.15	0.00	0.00	0.00	0.00
35.00	0.00	0.00	64.37	366.77	0.00	0.00	0.00	0.00
40.00	0.00	0.00	167.19	916.91	0.00	0.00	0.00	0.00
45.00	0.00	0.00	172.91	916.91	0.00	0.00	0.00	0.00
50.00	0.00	0.00	178.20	916.91	0.00	0.00	0.00	0.00
55.00	0.00	0.00	183.12	916.91	0.00	0.00	0.00	0.00
59.00	0.00	0.00	437.57	873.53	0.00	0.00	0.00	0.00
60.00	0.00	0.00	37.55	183.38	0.00	0.00	0.00	830.27
65.00	0.00	0.00	154.89	778.33	0.00	0.00	0.00	0.00
68.75	0.00	0.00	118.05	583.75	0.00	0.00	0.00	0.00
70.00	0.00	0.00	39.55	137.08	0.00	0.00	0.00	0.00
75.00	0.00	0.00	161.36	548.33	0.00	0.00	0.00	0.00
80.00	0.00	0.00	164.36	548.33	0.00	0.00	0.00	0.00
85.00	0.00	0.00	167.23	548.33	0.00	0.00	0.00	0.00
87.00	0.00	0.00	2,934.79	4,535.33	0.00	0.00	0.00	0.00
90.00	0.00	0.00	101.99	329.00	0.00	0.00	0.00	1,670.58
95.00	0.00	0.00	172.63	392.16	0.00	0.00	0.00	0.00
97.00	0.00	0.00	3,068.97	3,313.86	0.00	0.00	0.00	0.00
100.00	0.00	0.00	105.11	235.29	0.00	0.00	0.00	0.00
105.00	0.00	0.00	177.64	392.16	0.00	0.00	0.00	0.00
107.00	0.00	0.00	2,237.56	2,328.86	0.00	0.00	0.00	0.00
110.00	0.00	0.00	108.01	235.29	0.00	0.00	0.00	0.00
115.00	0.00	0.00	182.32	392.16	0.00	0.00	0.00	0.00
115.50	0.00	0.00	1,960.64	2,791.22	0.00	0.00	0.00	0.00
120.00	0.00	0.00	166.09	352.94	0.00	0.00	0.00	5,931.77
<b>Totals:</b>			14,490.35	31,373.89	0.00	0.00	0.00	8,432.63

Pole : CT03XC076  
 Location : Hartford County, Bloomfield, CT 06002  
 Height : 120.0 (ft)  
 Shape : Round  
 Base Dia : 36.00 (in)  
 Taper : 0.000000 (in/ft)

Sprint Sites USA - NJ  
 Base Elev : 0.000 (ft)  
 Top Dia : 24.00 (in)

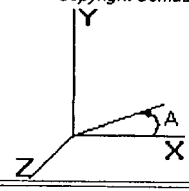

**Load Case:** Ice      80 mph - With Ice - Ice Thickness = 0.5 in      23 Iterations  
 Gust Response Factor : 1.69      Effective Wind Speed : 69.28 (mph)  
 Dead Load Factor : 1.00  
 Wind Load Factor : 1.00

**Calculated Forces and Deflections**

Seg Elev (ft)	Lateral FX (-) (kips)	Axial FY (-) (kips)	Lateral FZ (kips)	Moment MX (ft-kips)	Torsion MY (ft-kips)	Moment MZ (ft-kips)	X Deflect (in)	Z Deflect (in)	Total Deflect (in)	Rotation (deg)
0.00	14.539	31.351	0.000	0.000	0.000	1,333.659	0.000	0.000	0.000	0.000
5.00	14.437	30.108	0.000	0.000	0.000	1,260.966	-0.094	0.000	0.094	-0.174
10.00	14.324	28.869	0.000	0.000	0.000	1,188.780	-0.365	0.000	0.365	-0.339
15.00	14.199	27.633	0.000	0.000	0.000	1,117.163	-0.803	0.000	0.803	-0.494
20.00	14.063	26.400	0.000	0.000	0.000	1,046.171	-1.399	0.000	1.399	-0.640
25.00	13.917	25.170	0.000	0.000	0.000	975.860	-2.143	0.000	2.143	-0.776
30.00	13.751	23.949	0.000	0.000	0.000	906.278	-3.023	0.000	3.023	-0.902
33.00	13.675	23.296	0.000	0.000	0.000	865.024	-3.614	0.000	3.614	-0.974
35.00	13.660	22.897	0.000	0.000	0.000	837.674	-4.037	0.000	4.037	-1.046
40.00	13.550	21.938	0.000	0.000	0.000	769.375	-5.243	0.000	5.243	-1.250
45.00	13.420	20.983	0.000	0.000	0.000	701.628	-6.653	0.000	6.653	-1.437
50.00	13.274	20.034	0.000	0.000	0.000	634.527	-8.249	0.000	8.249	-1.607
55.00	13.108	19.093	0.000	0.000	0.000	568.157	-10.014	0.000	10.014	-1.759
59.00	12.664	18.219	0.000	0.000	0.000	514.895	-11.536	0.000	11.536	-1.869
60.00	12.644	18.021	0.000	0.000	0.000	502.231	-11.931	0.000	11.931	-1.895
65.00	12.502	17.220	0.000	0.000	0.000	439.012	-13.980	0.000	13.980	-2.015
68.75	12.389	16.621	0.000	0.000	0.000	392.131	-15.620	0.000	15.620	-2.155
70.00	12.388	16.453	0.000	0.000	0.000	376.645	-16.190	0.000	16.190	-2.199
75.00	12.268	15.863	0.000	0.000	0.000	314.708	-18.630	0.000	18.630	-2.452
80.00	12.129	15.283	0.000	0.000	0.000	253.368	-21.311	0.000	21.311	-2.660
85.00	11.963	14.721	0.000	0.000	0.000	192.724	-24.187	0.000	24.187	-2.823
87.00	8.817	10.328	0.000	0.000	0.000	167.128	-25.380	0.000	25.380	-2.876
90.00	8.712	9.993	0.000	0.000	0.000	140.678	-27.209	0.000	27.209	-2.943
95.00	8.529	9.601	0.000	0.000	0.000	97.119	-30.340	0.000	30.340	-3.030
97.00	5.293	6.452	0.000	0.000	0.000	80.060	-31.617	0.000	31.617	-3.069
100.00	5.181	6.218	0.000	0.000	0.000	64.181	-33.561	0.000	33.561	-3.115
105.00	4.986	5.833	0.000	0.000	0.000	38.275	-36.854	0.000	36.854	-3.171
107.00	2.623	3.631	0.000	0.000	0.000	28.304	-38.185	0.000	38.185	-3.185
110.00	2.503	3.401	0.000	0.000	0.000	20.434	-40.191	0.000	40.191	-3.201
115.00	2.300	3.020	0.000	0.000	0.000	7.917	-43.551	0.000	43.551	-3.216
115.50	0.186	0.343	0.000	0.000	0.000	0.835	-43.888	0.000	43.888	-3.217
120.00	0.166	0.000	0.000	0.000	0.000	0.000	-46.919	0.000	46.919	-3.218

Pole : CT03XC076                      Sprint Sites USA - NJ  
 Location : Hartford County, Bloomfield, CT 06002  
 Height : 120.0 (ft)                      Base Elev : 0.000 (ft)  
 Shape : Round  
 Base Dia : 36.00 (in)                      Top Dia : 24.00 (in)  
 Taper : 0.000000 (in/ft)

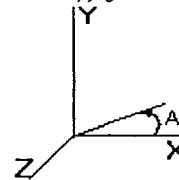

<b>Load Case:</b> Ice	80 mph - With Ice - Ice Thickness = 0.5 in	23 Iterations
Gust Response Factor : 1.69	Effective Wind Speed : 69.28 (mph)	
Dead Load Factor : 1.00		
Wind Load Factor : 1.00		

**Calculated Stresses**

Seg Elev (ft)	Applied Stresses							Allowable Stress (Fb) (ksi)	Allowable Stress (Fa) (ksi)	Stress Ratio
	Axial (Y) (ksi)	Shear (X) (ksi)	Shear (Z) (ksi)	Torsion (ksi)	Bending (X) (ksi)	Bending (Z) (ksi)	Combined (ksi)			
0.00	0.513	0.693	0.000	0.000	0.000	27.233	27.772	33.6	33.1	0.827
5.00	0.493	0.688	0.000	0.000	0.000	25.749	26.269	33.6	33.1	0.782
10.00	0.473	0.683	0.000	0.000	0.000	24.275	24.775	33.6	33.1	0.737
15.00	0.452	0.677	0.000	0.000	0.000	22.812	23.294	33.6	33.1	0.693
20.00	0.432	0.671	0.000	0.000	0.000	21.363	21.826	33.6	33.1	0.650
25.00	0.412	0.664	0.000	0.000	0.000	19.927	20.371	33.6	33.1	0.606
30.00	0.392	0.656	0.000	0.000	0.000	18.506	18.932	33.6	33.1	0.564
30.00	0.443	0.788	0.000	0.000	0.000	24.401	24.882	33.6	33.6	0.741
33.00	0.431	0.784	0.000	0.000	0.000	23.290	23.760	33.6	33.6	0.707
35.00	0.486	0.783	0.000	0.000	0.000	26.920	27.439	33.6	33.6	0.817
40.00	0.466	0.777	0.000	0.000	0.000	24.725	25.226	33.6	33.6	0.751
45.00	0.445	0.770	0.000	0.000	0.000	22.548	23.032	33.6	33.6	0.686
50.00	0.425	0.761	0.000	0.000	0.000	20.391	20.858	33.6	33.6	0.621
55.00	0.405	0.752	0.000	0.000	0.000	18.258	18.709	33.6	33.6	0.557
59.00	0.387	0.726	0.000	0.000	0.000	16.547	16.980	33.6	33.6	0.505
60.00	0.383	0.725	0.000	0.000	0.000	16.140	16.570	33.6	33.6	0.493
60.00	0.450	0.909	0.000	0.000	0.000	22.913	23.416	33.6	33.6	0.697
65.00	0.430	0.899	0.000	0.000	0.000	20.029	20.518	33.6	33.6	0.611
68.75	0.415	0.891	0.000	0.000	0.000	17.890	18.370	33.6	33.6	0.547
70.00	0.591	0.891	0.000	0.000	0.000	27.910	28.543	33.6	33.6	0.850
75.00	0.570	0.882	0.000	0.000	0.000	23.320	23.939	33.6	33.6	0.713
80.00	0.549	0.872	0.000	0.000	0.000	18.775	19.383	33.6	33.6	0.577
85.00	0.529	0.860	0.000	0.000	0.000	14.281	14.885	33.6	33.6	0.443
87.00	0.371	0.634	0.000	0.000	0.000	12.384	12.803	33.6	33.6	0.381
90.00	0.359	0.626	0.000	0.000	0.000	10.424	10.838	33.6	33.6	0.323
90.00	0.536	0.935	0.000	0.000	0.000	15.391	16.009	33.6	33.1	0.476
95.00	0.515	0.915	0.000	0.000	0.000	10.625	11.252	33.6	33.1	0.335
97.00	0.346	0.568	0.000	0.000	0.000	8.759	9.158	33.6	33.1	0.273
100.00	0.333	0.556	0.000	0.000	0.000	7.022	7.418	33.6	33.1	0.221
105.00	0.313	0.535	0.000	0.000	0.000	4.188	4.595	33.6	33.1	0.137
107.00	0.195	0.281	0.000	0.000	0.000	3.097	3.327	33.6	33.1	0.099
110.00	0.182	0.269	0.000	0.000	0.000	2.236	2.462	33.6	33.1	0.073
115.00	0.162	0.247	0.000	0.000	0.000	0.866	1.113	33.6	33.1	0.033
115.50	0.018	0.020	0.000	0.000	0.000	0.091	0.115	33.6	33.1	0.003
120.00	0.000	0.018	0.000	0.000	0.000	0.000	0.031	33.6	33.1	0.001

Pole : CT03XC076 Sprint Sites USA - NJ  
 Location: Hartford County, Bloomfield, CT 06002  
 Height : 120.0 (ft) Base Elev : 0.000 (ft)  
 Shape : Round Top Dia : 24.00 (in)  
 Base Dia : 36.00 (in) Taper : 0.000000 (in/ft)

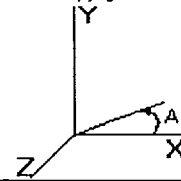

<b>Load Case:</b> No Ice	80 mph - No Ice	23 Iterations
Gust Response Factor : 1.69	Effective Wind Speed : 80.00 (mph)	
Dead Load Factor : 1.00		
Wind Load Factor : 1.00		

**Analysis Summary**

Load Case	Reactions						Max Stresses			
	Shear FX (kips)	Shear FZ (kips)	Axial FY (kips)	Moment MX (ft-kips)	Moment MY (ft-kips)	Moment MZ (ft-kips)	Combined Stress (ksi)	Allowable Stress (ksi)	Elev (ft)	Stress Ratio
No Ice	17.233	0.000	24.253	0.000	0.000	1,545.542	33.571	33.6	68.750	0.999
Ice	14.539	0.000	31.351	0.000	0.000	1,333.659	29.695	33.6	68.750	0.884

**Additional Steel Summary**

Elev From (ft)	Elev To (ft)	Description	Stitch Weld				Upper Terminal Weld				Lower Terminal Weld				Max Stresses		
			Len (in)	Spacing (in)	Size (in)	Fu (ksi)	Moment (ft-kips)	Q (in^3)	Tot I (in^4)	Len (in)	Moment (ft-kips)	Q (in^3)	Tot I (in^4)	Len (in)	fb (ksi)	Fb (ksi)	Ratio
0.00	33.0	(4) CHN-C8 x 18.75	3.00	24.00	0.188	70	994.13	93.5	6,685.5	22.4	1,545.54	110.0	10,578.0	25.9	37.1	38.1	97.4
33.0	68.7	(4) CHN-C8 x 11.5	3.00	24.00	0.188	70	447.19	46.3	3,156.3	16.0	994.13	56.4	5,601.2	16.1	38.1	38.2	99.8

NI

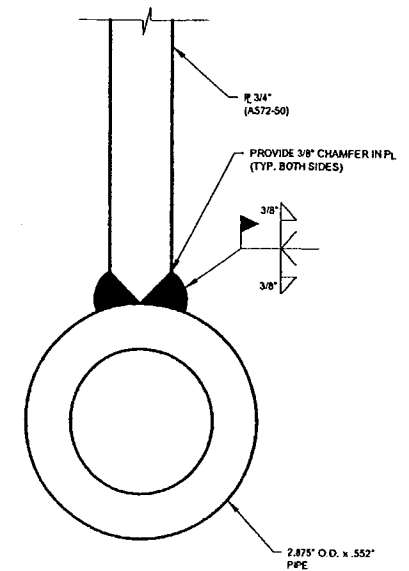
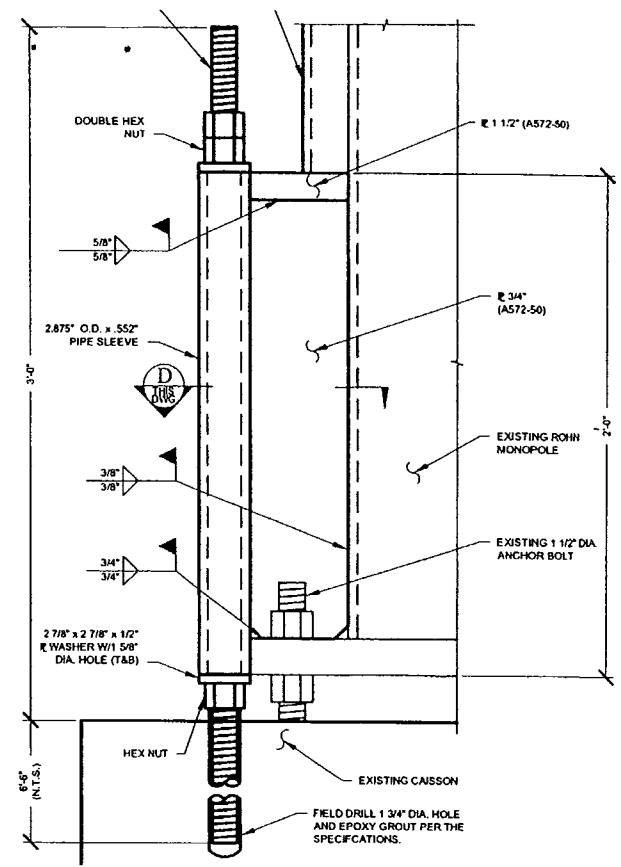
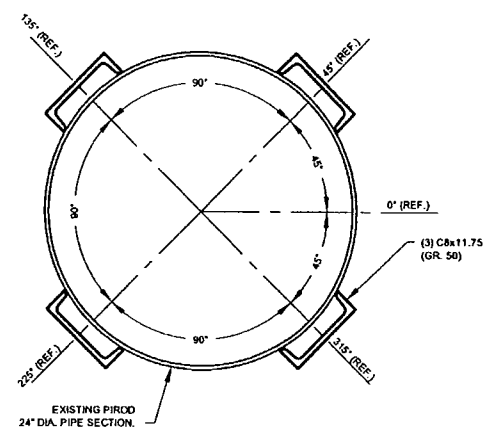
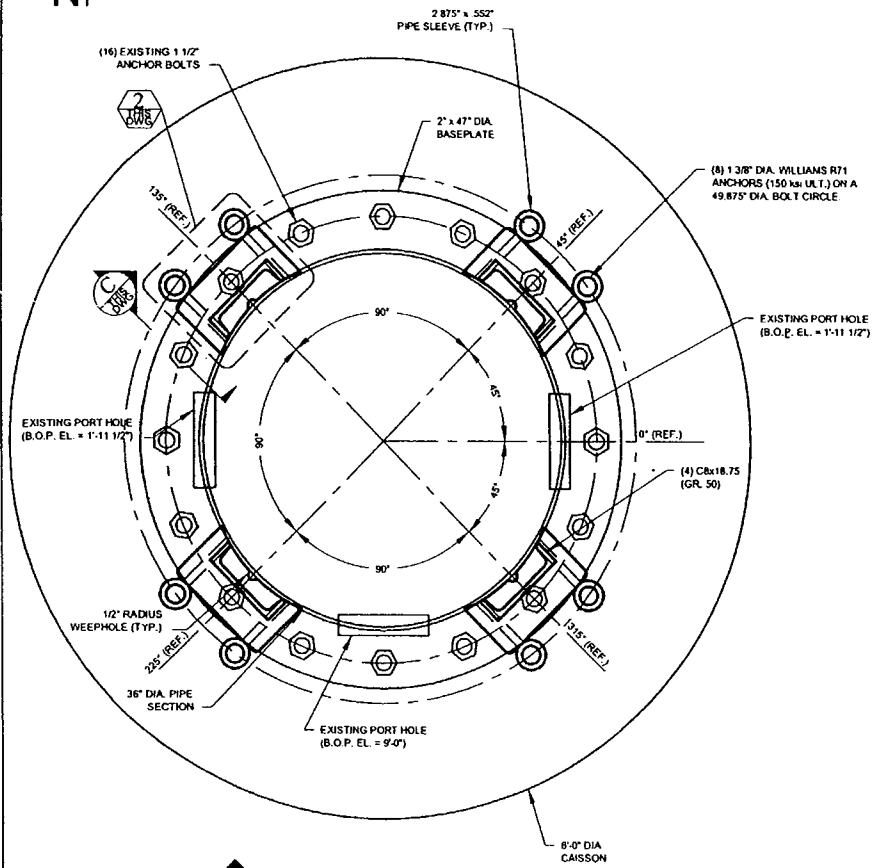

**A** SECTION  
S-01  
NOT TO SCALE

**B** SECTION  
S-01  
NOT TO SCALE

**C** SECTION  
S-01  
NOT TO SCALE

**D** SECTION  
S-01  
NOT TO SCALE

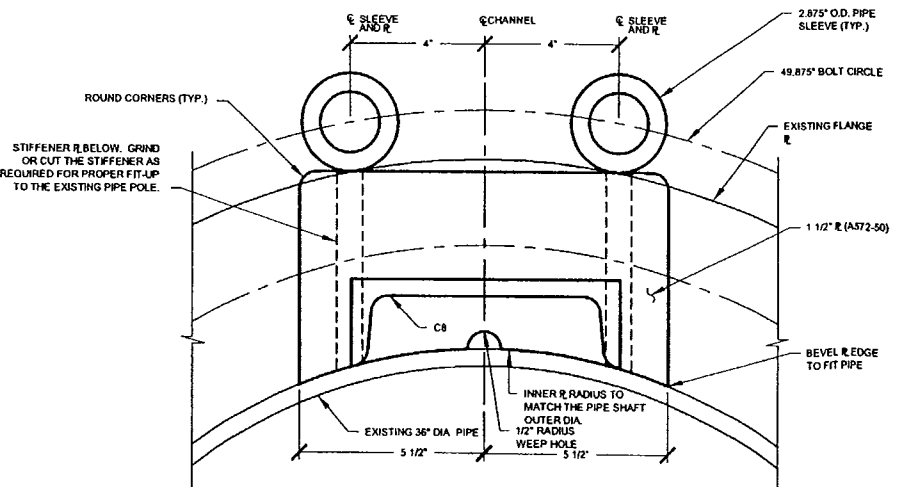
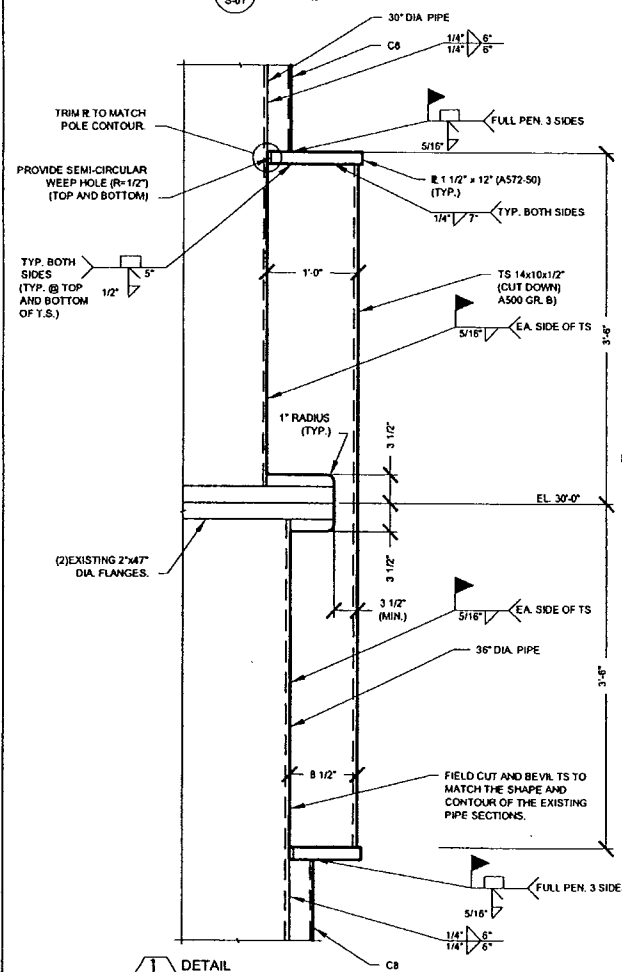

**1** DETAIL  
S-01  
NOT TO SCALE

**2** DETAIL  
S-01  
NOT TO SCALE

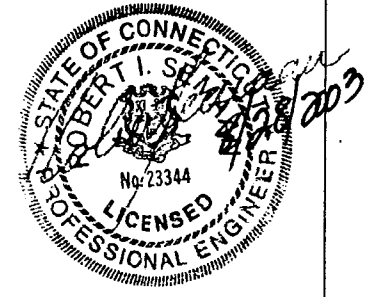

-N.T.S. DENOTES NOT TO SCALE

**Semaan Engineering Solutions, Inc.**

Phone Number: (402)285-1858 Fax Number: (402)289-1861 Address: 1047 N. 204th Avenue, Elkhorn Nebraska 68022		PROJECT NUMBER CT03X0078
DRAWN BY: KRC	DATE: 08/23/03	REFERENCE DRAWING S-01
SITE LOCATION BLOOMFIELD, CT		TLT
REV #	DATE	REVISION DESCRIPTION
A	08/27/03	ISSUE FOR PERMITS
CLIENT SSUSA	DRAWING DESCRIPTION REINFORCING DETAILS	BY C/K
SHEET NUMBER S-02		

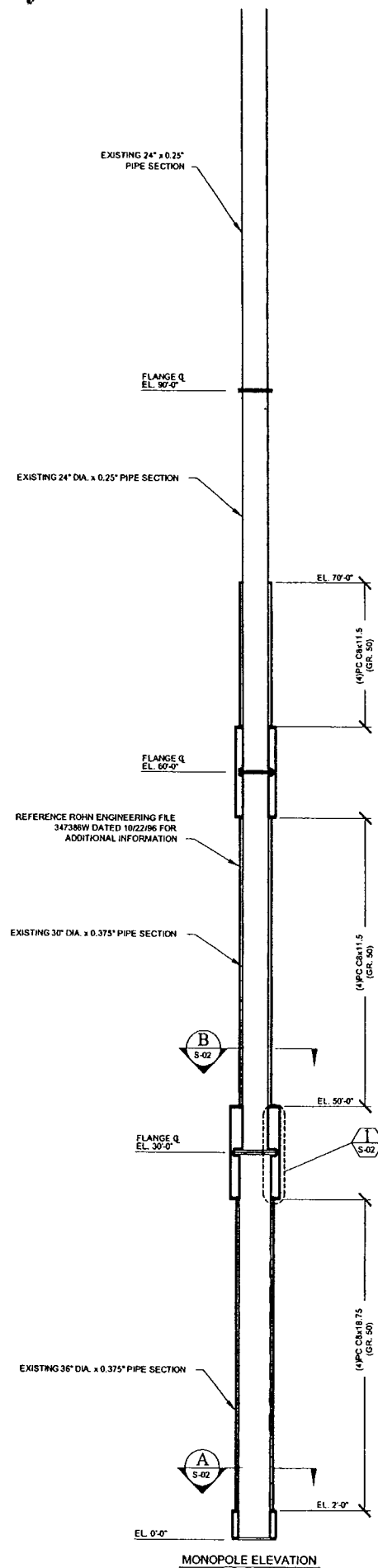

MONOPOLE ELEVATION  
NOT TO SCALE

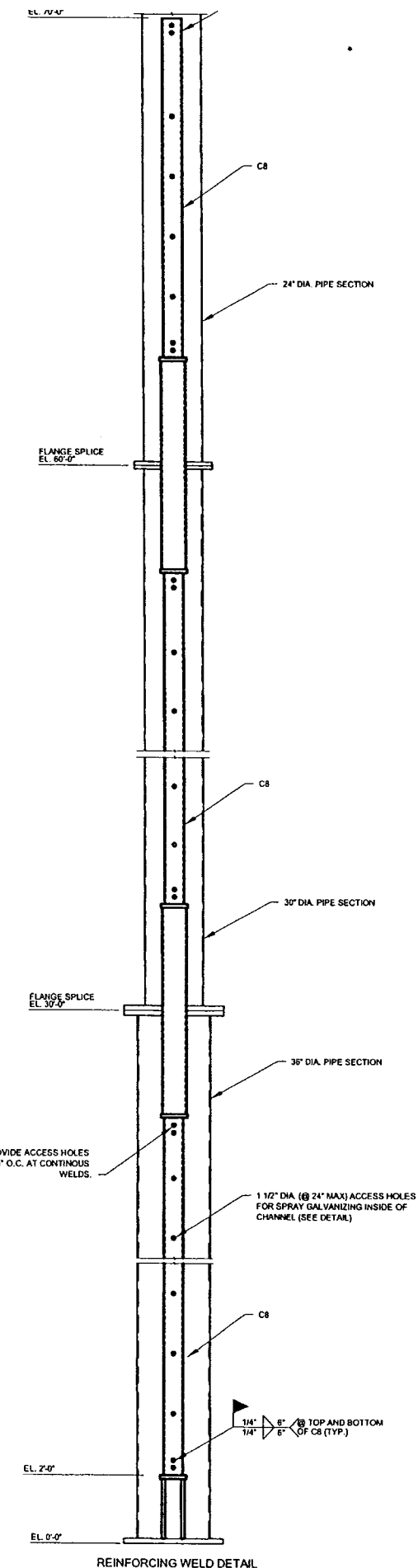

REINFORCING WELD DETAIL  
NOT TO SCALE

- CODE
- THE CONTRACTOR SHALL FIELD VERIFY ALL EXISTING DIMENSIONS, ELEVATIONS, AND CONDITIONS PRIOR TO FABRICATION.
  - REFERENCE THE SEMAAN ENGINEERING SOLUTIONS ANALYSIS FOR THIS SITE DATED 08/27/03 FOR THE PROPOSED AND EXISTING LOADS CONSIDERED. THIS DRAWING IS NOT VALID IF LOADS OTHER THAN THOSE CONSIDERED IN THE ANALYSIS ARE ADDED TO OR REMOVED FROM THE TOWER UNLESS APPROVED IN WRITING BY SES, INC.
  - THE PROPOSED LOADS SHALL NOT BE ADDED TO THE STRUCTURE UNTIL ALL MODIFICATIONS ARE MADE AND APPROVED BY THE WELDING INSPECTOR.
  - WORK ON THIS STRUCTURE SHALL ONLY TAKE PLACE IF THE WIND SPEED DOES NOT EXCEED 20 MPH.
  - THIS DRAWING DOES NOT INDICATE THE METHOD OF CONSTRUCTION THE CONTRACTOR SHALL SUPERVISE AND DETECT THE WORK AND HE SHALL BE SOLELY RESPONSIBLE FOR ALL THE CONSTRUCTION MEANS, TECHNIQUES, SEQUENCES AND PROCEDURES.
  - CONTRACTOR SHALL FIELD VERIFY ALL DIMENSIONS PRIOR TO ANY FABRICATION. CONTACT SEMAAN ENGINEERING IF ANY DISCREPANCIES EXIST.

- STEEL CONSTRUCTION
- STRUCTURAL STEEL SHALL CONFORM TO THE AISC MANUAL OF STEEL CONSTRUCTION, NINTH EDITION, FOR THE DESIGN AND FABRICATION OF STEEL COMPONENTS.
  - SHOP DRAWINGS SHALL BE SUBMITTED TO SES FOR APPROVAL PRIOR TO FABRICATION. SHOP DRAWINGS SHALL INCLUDE ALL FABRICATED STEEL ASSEMBLIES INCLUDING MONOPOLE/TOWER EXTENSIONS.
  - ALL EXTERIOR STEEL WORK SHALL BE GALVANIZED IN ACCORDANCE WITH ASTM A123 AND AS FOLLOWS, UNLESS OTHERWISE NOTED.
    - GALVANIZING SHALL BE PERFORMED AFTER SHOP FABRICATION AND WELDING TO THE GREATEST EXTENT POSSIBLE.
    - ALL DIMS, SCRAPES, MARKS AND WELDS IN THE GALVANIZED AREA SHALL BE COATED WITH A ZINC-RICH PAINT, APPLIED IN STRICT ACCORDANCE WITH MANUFACTURER'S RECOMMENDATIONS.
    - IF THE STRUCTURE WAS ORIGINALLY PAINTED, AFTER ZINC-RICH PAINT IS DRY, OVERCOAT WITH AN APPROPRIATE PAINT WITH THE SAME COLOR AS THE EXISTING.
  - DO NOT PLACE HOLES THROUGH STRUCTURAL STEEL MEMBERS EXCEPT AS SHOWN AND DETAILED ON DRAWINGS.
  - CONNECTIONS SHALL BE CONSTRUCTED AS FOLLOWS:
    - ALL WELDING SHALL BE DONE USING E70XX ELECTRODES.
    - ALL WELDING SHALL CONFORM TO AISC AND AWS D1.1 LATEST EDITION.
    - THE WELDER(S) SHOULD BE QUALIFIED FOR THE METHODS AND POSITIONS TO BE USED AND SHOULD HAVE EXPERIENCE WELDING GALVANIZED MATERIALS.
    - WHERE FILLET WELD SIZES ARE NOT SHOWN, PROVIDE THE MINIMUM SIZE PER TABLE J2.4 IN THE AISC MANUAL OF STEEL CONSTRUCTION, NINTH EDITION.
    - ALL EXISTING GALVANIZING IN WELD AREAS SHALL GROUND OFF PRIOR TO WELDING.
    - ALL WELDS SHALL BE INSPECTED VISUALLY 25 % OF WELDS SHALL BE INSPECTED WITH DYE PENETRATE OR MAGNETIC PARTICLE (100 %) IF REJECTABLE DEFECTS ARE FOUND TO MEET THE ACCEPTANCE CRITERIA OF AWS D1.1 REPAIR ALL WELDS AS NECESSARY.
    - INSPECTION SHALL BE PERFORMED BY AN AWS CERTIFIED WELD INSPECTOR.
    - BOLTS SHALL BE TIGHTENED TO A "SNUG TIGHT" CONDITION AS DEFINED BY AISC.

- ANCHOR INSTALLATION IN CONCRETE
- CONTRACTOR SHALL VERIFY THAT DRILLING CLEARANCE IS ADEQUATE PRIOR TO CONSTRUCTION NOTIFY THE ENGINEER IF A CLEARANCE PROBLEM EXISTS.
  - THE NEW ANCHOR BOLTS SHALL BE INSTALLED PER THE MANUFACTURER'S INSTALLATION PROCEDURE.
  - ANY NEW HOLES IN BASEPLATE SHALL BE DRILLED ONLY. NO TORCH CUTTING SHALL BE PERMITTED.
  - USE COMPRESSED AIR TO BLOW ANY REMAINING DEBRIS OUT OF THE NEWLY DRILLED HOLES.
  - EPOXY THE NEW ANCHOR BOLTS IN PLACE PER THE MANUFACTURER'S INSTRUCTIONS. ULTRA BOND 1100 BY US ANCHOR SHALL BE USED IF THE AMBIENT TEMPERATURE IS BELOW 70°. WILLIAMS W1-BOND 200 EPOXY MAY BE USED IF THE AMBIENT TEMPERATURE IS ABOVE 70°.
  - THE NEW ANCHOR BOLTS SHALL BE PROOF-LOADED TO 140 kips. THE CONTRACTOR MAY USE THE TORQUE-TENSION METHOD TO VERIFY ANCHOR CAPACITY. IF THE TORQUE-TENSION METHOD IS USED TO VERIFY THE ANCHOR CAPACITY, TORQUE THE NUTS TO 4500 ft-lb. THE ANCHOR THREADS SHALL BE LUBRICATED WITH MOLY-KOTE G HIGH LUBE GREASE BEFORE APPLYING TORQUE.
  - REMOVE PROOF-LOAD AND SHIMS IF USED ONCE TEST LOAD HAS BEEN OBTAINED. SNUG TIGHT THE NUTS.

NOTE: COLD SPRAY GALVANIZE THE CHANNEL WELDS ONLY AFTER THEY HAVE BEEN INSPECTED AND APPROVED.

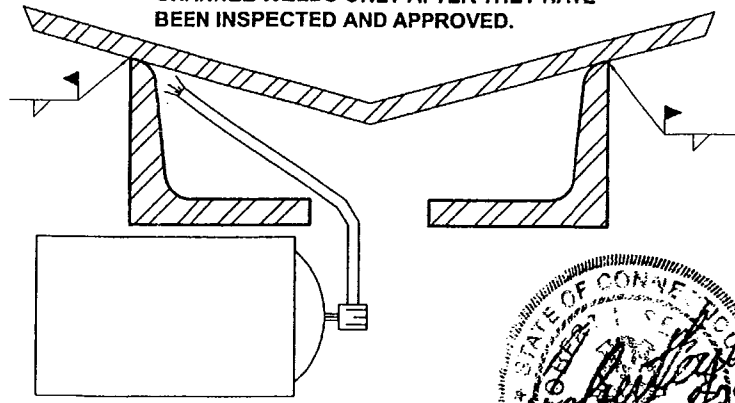

GALVANIZING DETAIL  
NOT TO SCALE

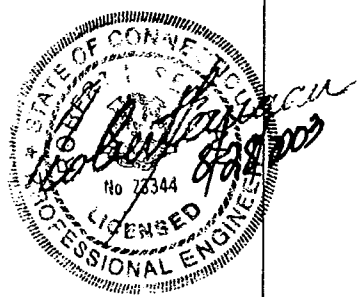

Semaan Engineering Solutions, Inc.			
Phone Number: (402)289-1888 Fax Number: (402)289-1861		PROJECT NUMBER	
Address: 1047 N. 204th Avenue, Elkhorn Nebraska 68022		CT03XC076	
DRAWN BY:	DATE:	REFERENCE DRAWING	SITE LOCATION
KRC	08/25/03	NONE	BLOOMFIELD, CT.
REV #	DATE	REVISION DESCRIPTION	BY
A	08/27/03	ISSUE FOR PERMITS	TLT
REV #	DATE	REVISION DESCRIPTION	BY
CLIENT	SSUSA	DRAWING DESCRIPTION	SHEET NUMBER
		REINFORCING DETAILS	S-01



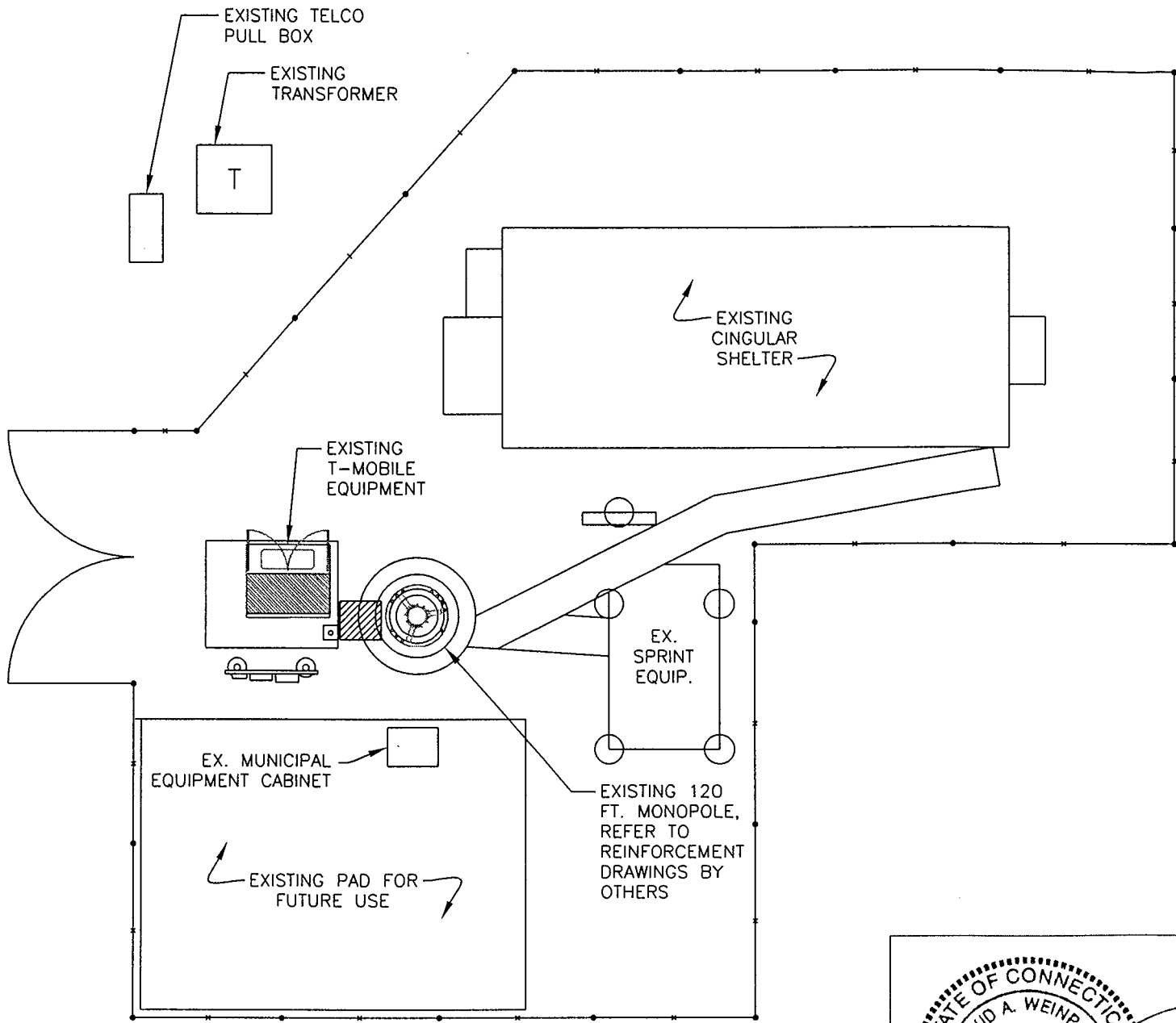

1  
A-1 COMPOUND PLAN  
SCALE: 1/8"=1'-0"

STATE OF CONNECTICUT  
DAVID A. WEINPAHL  
NO. 2214  
LICENSED  
PROFESSIONAL ENGINEER  
DAVID A. WEINPAHL  
CT LIC. NO.: 22144

Project: MOUNTAIN VIEW CEMETARY  
Address: 26 BREWER DRIVE  
BLOOMFIELD, CT  
Coscode No.: CT03XC076

Client: **Sprint Sites USA**  
**On Air Engineering**  
201 WALNUT STREET, TWP. OF WASHINGTON, NJ 07676

Approved By: IMP ENGINEER: DATE:  
Approved By: IMP MANAGER: DATE:

Exhibit No. **A-1** Drawing Name: **COMPOUND PLAN**

IMP MANAGER: MJo IMP ENGINEER: RVa Date: 9.20.03

**ON-AIR TOWER COMPANY**  
224 752-4425  
FAX 752-24-1511

CENTERLINE OF T-MOBILE ANTENNAS  
107'-0" ± A.G.L.

TOP OF MONOPOLE AND SPRINT ANTENNAS  
120'-0" ± A.G.L.

EXISTING CINGULAR ANTENNAS TO BE REPLACED

CENTERLINE OF CINGULAR ANTENNAS  
97'-0" ± A.G.L.

POTENTIAL FUTURE NEXTEL ANTENNAS  
87'-0" ± A.G.L.

EXISTING 120 FT. MONOPOLE, REFER TO REINFORCEMENT DRAWINGS BY OTHERS

BASE OF TOWN OF BLOOMFIELD WHIP  
59'-0" ± A.G.L.

GROUND EQUIPMENT AND GPS ANTENNAS NOT SHOWN

GRADE

1 ELEVATION  
A-2 SCALE: 1/16" = 1'-0"

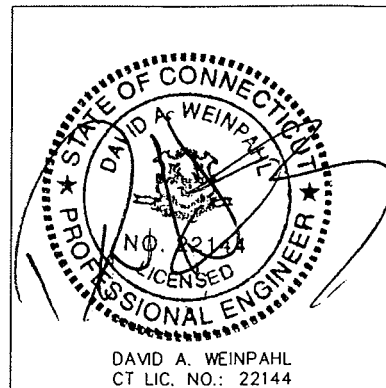

Project: MOUNTAIN VIEW CEMETARY  
Address: 26 BREWER DRIVE  
BLOOMFIELD, CT  
Coscode No.: CT03XC076

Client: **Sprint Sites USA**

Approved By: \_\_\_\_\_ DATE: \_\_\_\_\_  
IMP ENGINEER:

**On Air Engineering**  
201 WALNUT STREET, TWP. OF WASHINGTON, NJ 07676

Approved By: \_\_\_\_\_ DATE: \_\_\_\_\_  
IMP MANAGER:

Exhibit No. **A-2**

Drawing Name: **ELEVATION**

IMP. MANAGER: **MJo**

IMP. ENGINEER: **RVa**

Date: **9-20-03**





Engineers  
Architects  
Planners  
Constructors

George Burylo  
Director  
Engineering Services

September 22, 2003

Raymond Santhouse  
Implementation Engineer - NY Metro  
Sprint Sites USA  
535 East Crescent Avenue  
Ramsey, New Jersey 07446

**Subject: RF Exposure Compliance Analysis – Bloomfield, CT (CT03XC076)**

Dear Mr. Santhouse:

At your request, Edwards and Kelcey, Inc. has performed a RF exposure compliance analysis of Sprint Sites USA's wireless communications facility at 28 Brewer Drive, Bloomfield, CT. The report of site compliance is attached.

The calculations presented in the attached report demonstrate that the worst-case, maximum potential exposure level in publicly accessible ground level areas around the monopole from all antennas is only 25.256% of the FCC limit for continuous exposure of the general population. Please note that the calculations were performed based on the Connecticut Siting Council's preference of not incorporating vertical discrimination data.

Based on the RF analysis performed, the Sprint Sites USA wireless facility will be in full compliance with the FCC regulations concerning RF exposure control, and poses no RF health hazard to the surrounding community.

If you have any questions or require any additional information, please call me at 973-267-8830, extension 1250.

Regards,

George Burylo  
Director – Engineering Services

**Attachments**

299 Madison Avenue, PO Box 1936  
Morristown, New Jersey 07962-1936

Tel 973.267.8830 x1250  
Fax 973.267.3555  
Email gburylo@ekmail.com  
Web www.ekcorp.com



**RF Emissions Experts**

**AN EDWARDS AND KELCEY SERVICE**

***Analysis and Report  
of RF Exposure Levels  
and Compliance with  
FCC Regulations***

***Bloomfield Site  
28 Brewer Drive  
Bloomfield, CT  
CT03XC076***

***Prepared for  
Sprint Sites USA***

***September 22, 2003***

**EDWARDS AND KELCEY**  
299 Madison Avenue - PO Box 1936  
Morristown, NJ 07962-1936

Tel: 973-267-8830 Fax: 973-267-3555  
Email: gburylo@ekmail.com  
Internet: <http://www.ekcorp.com>

**PROPRIETARY – SPRINT SITES USA AND EDWARDS AND KELCEY**

This document has been prepared for Sprint Sites USA for its use in demonstrating RF compliance, as necessary, to federal, state and/or local authorities, and/or site landlords. Distribution beyond that described is prohibited without the express written consent of Edwards and Kelcey.



<b>FCC RF COMPLIANCE ANALYSIS FOR</b>  <b>Sprint Sites USA</b>  <b>Bloomfield, CT Monopole</b>
--

This site compliance report is organized as follows:

- Site Technical Data (supplied by client and from FCC license data)
- Analysis Method and Assumptions
- The FCC RF Radiation Exposure Regulations
- Applicable Formulas
- Analysis Results
- Conclusion
- 

**SITE TECHNICAL DATA (For Sprint PCS)**

Facility type	Existing 120 ft. Monopole
Frequency band (transmit)	1900 MHz
Antenna types	DB980H90
Antenna major dimension (length)	5 ft
Maximum antenna gain	17.1 dBi
Antenna mounting height (above ground level)	120 ft.
Total number of antennas	9 (3 per sector)
Other transmitting facilities on monopole	T-Mobile, Cingular and Town of Bloomfield

**ANALYSIS METHOD AND ASSUMPTIONS**

Type of analysis	Maximum / ground at base
Area analyzed	0' to 500' from monopole
Classification of area	Uncontrolled (gen. pop.)
FCC Maximum Permissible Exposure (MPE) limit	See Report
Mathematical model	Point source, far field
Assumed ground reflection factor	100%
Assumed human height	6'0"
Vertical antenna discrimination	(not used in CT)

## **THE FCC RF RADIATION EXPOSURE REGULATIONS**

This RF exposure analysis is based on the current FCC guidelines for human exposure to RF fields, which represent the consensus of federal agencies responsible for RF safety matters. Those agencies include the National Council on Radiation Protection and Measurements (NCRP), the Occupational Health and Safety Administration (OSHA), the National Institute for Occupational Safety and Health (NIOSH), the American National Standards Institute (ANSI), the Environmental Protection Agency (EPA), and the Food and Drug Administration (FDA). In formulating its guidelines, the FCC also considered input from the public and technical community – notably the Institute of Electrical and Electronics Engineers (IEEE).

The FCC's RF exposure guidelines are incorporated in Section 1.1301 *et seq* of its Rules and Regulations. Those guidelines specify maximum permissible exposure (MPE) levels for both occupational and general population exposure on a continuous basis, as well as averaging times for each of those categories when and if exposure exceeds the specified continuous exposure limits. (The concept of averaging time will be ignored in this analysis, as the results show the potential exposure levels are far below those permitted even for continuous exposure.)

The specified continuous exposure MPE limits are based on known variation of human body susceptibility in different frequency ranges, and a Specific Absorption Rate (SAR) of 4 watts per kilogram, which is universally considered to accurately represent human capacity to dissipate incident RF energy (in the form of heat). The occupational MPE guidelines incorporate a safety factor of 10 or greater with respect to RF levels known to represent a health hazard, and an additional safety factor of five is applied to the MPE limits for general population exposure. Thus the general population MPE limit has a built-in safety factor of more than 50. Continuous exposure at levels equal to or below the applicable MPE limits is considered to result in no adverse health effects on humans.

The reason for *two* tiers of MPE limits is based on an understanding and assumption that members of the general public are unlikely to have had appropriate RF safety training and may not be aware of the exposures they receive; occupational exposure in controlled environments, on the other hand, is assumed to involve individuals who have had such training, are aware of the exposures, and know how to maintain a safe personal work environment.

The FCC's RF exposure limits are expressed in two equivalent forms, using alternative units of field strength (expressed in volts per meter, or V/m), and power density (expressed in milliwatts per square centimeter, or mW/cm<sup>2</sup>). The more popularly used reference unit is power density, as it is more easily understood. One milliwatt per square centimeter is approximately the energy impinging on an area roughly one-fourth the size of a dime from a light bulb emitting ten thousand times less than the energy of a common 100-watt bulb. The table below lists the FCC limits for both occupational and general population exposure to different radio frequencies.



Frequency Range (F) (MHz)	Occupational Exposure (mW/cm <sup>2</sup> )	General Public Exposure (mW/cm <sup>2</sup> )
0.3 - 1.34	100	100
1.34 - 3.0	100	180 / F <sup>2</sup>
3.0 - 30	900 / F <sup>2</sup>	180 / F <sup>2</sup>
30 - 300	1.0	0.2
300 - 1,500	F / 300	F / 1500
1,500 - 100,000	5.0	1.0

The figure below provides a graphical illustration of both the FCC's occupational and general population MPE limits.

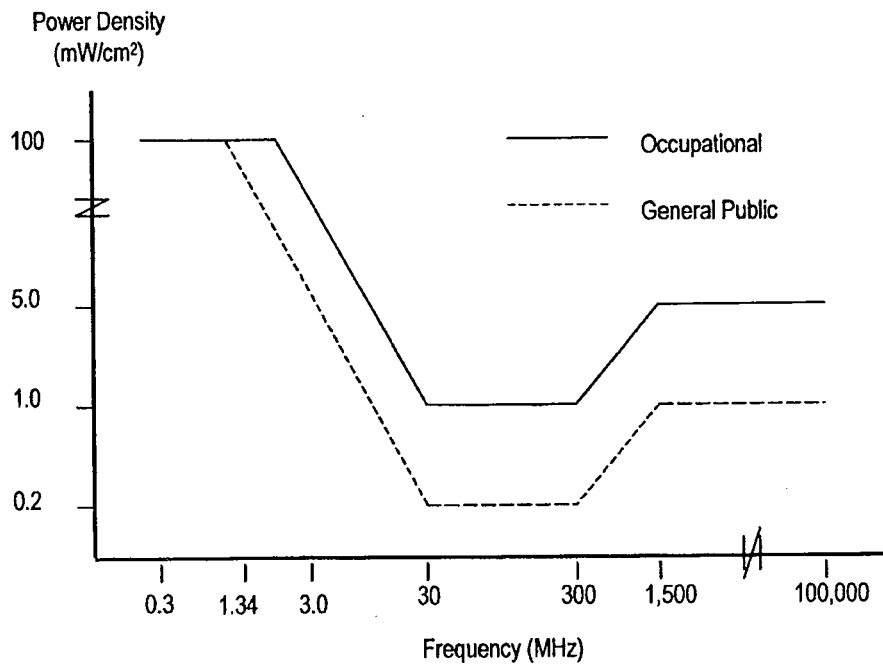

FCC MPE limits – graphical representation

The FCC makes it clear that the MPE limits apply only in accessible areas. Fundamentally, in areas that are considered normally inaccessible, the exposure issue is moot.

## APPLICABLE FORMULAS

According to FCC Bulletin OET65, different mathematical models apply to different distances around an antenna. At the height of the antenna, the breakpoint is the "far-field distance", calculated as the ratio of the square of the major dimension of the antenna divided by the signal wavelength. Beyond the far-field distance at the height of the antenna, as well as at ground-level underneath the antenna, a "far-field point source" model applies; within that distance, a "near-field" cylindrical model applies. The subsection below provides background on the applicable model in the 1900 MHz band.

### Far-Field Point Source Model

- (1)  $S \text{ [mW/cm}^2\text{]} = (4 * \text{EIRP}_{\text{max}} * \text{VertAntDisc}(\phi)) / (4 * \pi * R_{\text{cm}}^2)$
- (2) FCC MPE limit = 1.000 mW/cm<sup>2</sup>
- (3) MPE% = 100 \* (S / 1.000)

where:

- |                       |   |  |
|-----------------------|---|--|
| S                     | = | Calculated power density   |
| 4 (in numerator)      | = | 100% field ground reflection effect<br>(has $[1 + 1]^2 = 4$ effect on power density)   |
| EIRP <sub>max</sub>   | = | Maximum effective isotropically radiated power<br>(Note: EIRP is 64% higher than ERP, which is referenced to a half-wave dipole)   |
| VertAntDisc( $\phi$ ) | = | Numeric factor for antenna discrimination (EIRP reduction) in the vertical plane, applicable at downward angle $\phi$ to a 6' human standing on ground, calculated at distances from 0' to 500' away from the antenna<br><b>(not used in Connecticut sites – as requested by the Connecticut Siting Council)</b> |
| R                     | = | Straight-line distance from antenna to 6' human  |
| MPE%                  | = | Calculated exposure level, as a percentage of the FCC MPE limit for continuous exposure of the general population  |

## ANALYSIS RESULTS – GROUND-LEVEL

The tables on the following pages summarize the ground level results of the calculations using the site data, method and models described above. Please note that while the tabular distances are listed in feet, the calculations translate these units into centimeters, to match the FCC specification of MPE units. Also note that the G dist value represents the distance in feet from the monopole at ground level.

1900 MHz Antenna Array (Ground Level – Sprint PCS)					
G dist	R dist	V angle	V disc	mW/cm <sup>2</sup>	GPMPE%
0	111.5	90.0	1.000	0.0272	2.716
20	113.3	79.8	1.000	0.0263	2.631
40	118.5	70.3	1.000	0.0241	2.406
60	126.6	61.7	1.000	0.0211	2.106
80	137.2	54.3	1.000	0.0179	1.793
100	149.8	48.1	1.000	0.0151	1.505
120	163.8	42.9	1.000	0.0126	1.258
140	179.0	38.5	1.000	0.0105	1.054
160	195.0	34.9	1.000	0.0089	0.888
180	211.7	31.8	1.000	0.0075	0.753
200	229.0	29.1	1.000	0.0064	0.644
220	246.6	26.9	1.000	0.0055	0.555
240	264.6	24.9	1.000	0.0048	0.482
260	282.9	23.2	1.000	0.0042	0.422
280	301.4	21.7	1.000	0.0037	0.372
300	320.1	20.4	1.000	0.0033	0.330
320	338.9	19.2	1.000	0.0029	0.294
340	357.8	18.2	1.000	0.0026	0.264
360	376.9	17.2	1.000	0.0024	0.238
380	396.0	16.4	1.000	0.0022	0.215
400	415.2	15.6	1.000	0.0020	0.196
420	434.5	14.9	1.000	0.0018	0.179
440	453.9	14.2	1.000	0.0016	0.164
460	473.3	13.6	1.000	0.0015	0.151
480	492.8	13.1	1.000	0.0014	0.139
500	512.3	12.6	1.000	0.0013	0.129

Table 1. 1900 MHz Ground level RF power density and percent-of-MPE calculations.

1900 MHz Antenna Array (Ground Level – T-Mobile)					
G dist	R dist	V angle	V disc	mW/cm <sup>2</sup>	GPMPE%
0	96.0	90.0	1.000	0.0365	3.654
20	98.1	78.2	1.000	0.0350	3.502
40	104.0	67.4	1.000	0.0311	3.114
60	113.2	58.0	1.000	0.0263	2.628
80	125.0	50.2	1.000	0.0216	2.157
100	138.6	43.8	1.000	0.0175	1.753
120	153.7	38.7	1.000	0.0143	1.426
140	169.8	34.4	1.000	0.0117	1.169
160	186.6	31.0	1.000	0.0097	0.967
180	204.0	28.1	1.000	0.0081	0.809
200	221.8	25.6	1.000	0.0068	0.684
220	240.0	23.6	1.000	0.0058	0.585
240	258.5	21.8	1.000	0.0050	0.504
260	277.2	20.3	1.000	0.0044	0.438
280	296.0	18.9	1.000	0.0038	0.384
300	315.0	17.7	1.000	0.0034	0.339
320	334.1	16.7	1.000	0.0030	0.302
340	353.3	15.8	1.000	0.0027	0.270
360	372.6	14.9	1.000	0.0024	0.243
380	391.9	14.2	1.000	0.0022	0.219
400	411.4	13.5	1.000	0.0020	0.199
420	430.8	12.9	1.000	0.0018	0.181
440	450.4	12.3	1.000	0.0017	0.166
460	469.9	11.8	1.000	0.0015	0.153
480	489.5	11.3	1.000	0.0014	0.141
500	509.1	10.9	1.000	0.0013	0.130

Table 2. 1900 MHz Ground level RF power density and percent-of-MPE calculations.

1900 MHz Antenna Array (Ground Level – Cingular)					
G dist	R dist	V angle	V disc	mW/cm <sup>2</sup>	GPMP%
0	89.0	90.0	1.000	0.0568	5.676
20	91.2	77.3	1.000	0.0540	5.403
40	97.6	65.8	1.000	0.0472	4.722
60	107.3	56.0	1.000	0.0390	3.902
80	119.7	48.0	1.000	0.0314	3.139
100	133.9	41.7	1.000	0.0251	2.509
120	149.4	36.6	1.000	0.0201	2.014
140	165.9	32.4	1.000	0.0163	1.634
160	183.1	29.1	1.000	0.0134	1.341
180	200.8	26.3	1.000	0.0111	1.115
200	218.9	24.0	1.000	0.0094	0.938
220	237.3	22.0	1.000	0.0080	0.798
240	256.0	20.3	1.000	0.0069	0.686
260	274.8	18.9	1.000	0.0060	0.595
280	293.8	17.6	1.000	0.0052	0.521
300	312.9	16.5	1.000	0.0046	0.459
320	332.1	15.5	1.000	0.0041	0.407
340	351.5	14.7	1.000	0.0036	0.364
360	370.8	13.9	1.000	0.0033	0.327
380	390.3	13.2	1.000	0.0030	0.295
400	409.8	12.5	1.000	0.0027	0.268
420	429.3	12.0	1.000	0.0024	0.244
440	448.9	11.4	1.000	0.0022	0.223
460	468.5	11.0	1.000	0.0020	0.205
480	488.2	10.5	1.000	0.0019	0.189
500	507.9	10.1	1.000	0.0017	0.174

Table 3. 1900 MHz Ground level RF power density and percent-of-MPE calculations.

869 MHz Antenna Array (Ground Level - Cingular)					
G dist	R dist	V angle	V disc	mW/cm <sup>2</sup>	GPMPE%
0	89.0	90.0	1.000	0.0568	9.800
20	91.2	77.3	1.000	0.0540	9.329
40	97.6	65.8	1.000	0.0472	8.154
60	107.3	56.0	1.000	0.0390	6.738
80	119.7	48.0	1.000	0.0314	5.421
100	133.9	41.7	1.000	0.0251	4.332
120	149.4	36.6	1.000	0.0201	3.478
140	165.9	32.4	1.000	0.0163	2.821
160	183.1	29.1	1.000	0.0134	2.316
180	200.8	26.3	1.000	0.0112	1.925
200	218.9	24.0	1.000	0.0094	1.620
220	237.3	22.0	1.000	0.0080	1.378
240	256.0	20.3	1.000	0.0069	1.185
260	274.8	18.9	1.000	0.0060	1.028
280	293.8	17.6	1.000	0.0052	0.899
300	312.9	16.5	1.000	0.0046	0.793
320	332.1	15.5	1.000	0.0041	0.704
340	351.5	14.7	1.000	0.0036	0.628
360	370.8	13.9	1.000	0.0033	0.564
380	390.3	13.2	1.000	0.0030	0.510
400	409.8	12.5	1.000	0.0027	0.462
420	429.3	12.0	1.000	0.0024	0.421
440	448.9	11.4	1.000	0.0022	0.385
460	468.5	11.0	1.000	0.0020	0.354
480	488.2	10.5	1.000	0.0019	0.326
500	507.9	10.1	1.000	0.0017	0.301

Table 4. 869 MHz Ground level RF power density and percent-of-MPE calculations.

453 MHz Antenna (Ground Level – Town of Bloomfield)					
G dist	R dist	V angle	V disc	mW/cm <sup>2</sup>	GPMPE%
0	44.0	90.0	1.000	0.0103	3.410
20	48.3	65.6	1.000	0.0085	2.826
40	59.5	47.7	1.000	0.0056	1.867
60	74.4	36.3	1.000	0.0036	1.193
80	91.3	28.8	1.000	0.0024	0.792
100	109.3	23.7	1.000	0.0017	0.553
120	127.8	20.1	1.000	0.0012	0.404
140	146.8	17.4	1.000	0.0009	0.307
160	165.9	15.4	1.000	0.0007	0.240
180	185.3	13.7	1.000	0.0006	0.192
200	204.8	12.4	1.000	0.0005	0.157
220	224.4	11.3	1.000	0.0004	0.131
240	244.0	10.4	1.000	0.0003	0.111
260	263.7	9.6	1.000	0.0003	0.095
280	283.4	8.9	1.000	0.0002	0.082
300	303.2	8.3	1.000	0.0002	0.072
320	323.0	7.8	1.000	0.0002	0.063
340	342.8	7.4	1.000	0.0002	0.056
360	362.7	7.0	1.000	0.0002	0.050
380	382.5	6.6	1.000	0.0001	0.045
400	402.4	6.3	1.000	0.0001	0.041
420	422.3	6.0	1.000	0.0001	0.037
440	442.2	5.7	1.000	0.0001	0.034
460	462.1	5.5	1.000	0.0001	0.031
480	482.0	5.2	1.000	0.0001	0.028
500	501.9	5.0	1.000	0.0001	0.026

Table 5. 453 MHz Ground level RF power density and percent-of-MPE calculations.

## **CONCLUSION**

The calculations demonstrate that the maximum potential exposure to radio frequency emissions is well below the FCC recommended levels for safety. The total worst case ground level emissions around the monopole from all antennas is 25.256% of the maximum permissible exposure (MPE) level, and is safe for continuous exposure of the general population based on FCC requirements.

The results are summarized as follows:

<b>Carrier</b>	<b>Height above ground (feet)</b>	<b>Power Density (mW/cm<sup>2</sup>)</b>	<b>FCC Maximum (mW/cm<sup>2</sup>)</b>	<b>MPE% of Standard</b>
Sprint PCS	120	0.0272	1.000	2.716
T-Mobile	107	0.0365	1.000	3.654
Cingular GSM 1900	97	0.0568	1.000	5.676
Cingular GSM 850	97	0.0568	0.579	9.800
Bloomfield	59	0.0103	0.302	3.410
<b>Total</b>	-	-	-	<b>25.256</b>

**Therefore, this Sprint Sites USA facility should not create a significant risk of exposure to cumulative RF emissions to the general population. And, according to the calculations, the Sprint Sites USA wireless facility is in compliance with the FCC regulations concerning the control of potential RF exposure.**



**CERTIFICATION**

This report was prepared by George Burylo, Director – Engineering Services. The undersigned certifies that the analysis provided herein is consistent with the applicable FCC Rules and Regulations and accepted industry practice.

  
\_\_\_\_\_  
George Burylo  
Director – Engineering Services  
Edwards and Kelcey, Inc.

September 22, 2003

## **REFERENCES**

47 CFR, FCC Rules and Regulations, Section 1.1301 et seq.

FCC Second Memorandum Opinion and Order and Notice of Proposed Rulemaking (FCC 97-303), *In the Matter of Procedures for Reviewing Requests for Relief From State and Local Regulations Pursuant to Section 332(c)(7)(B)(v) of the Communications Act of 1934 (WT Docket 97-192), Guidelines for Evaluating the Environmental Effects of Radiofrequency Radiation (ET Docket 93-62), and Petition for Rulemaking of the Cellular Telecommunications Industry Association Concerning Amendment of the Commission's Rules to Preempt State and Local Regulation of Commercial Mobile Radio Service Transmitting Facilities*, released August 25, 1997.

FCC First Memorandum Opinion and Order, ET Docket 93-62, *In the Matter of Guidelines for Evaluating the Environmental Effects of Radiofrequency Radiation*, released December 24, 1996.

FCC Report and Order, ET Docket 93-62, *In the Matter of Guidelines for Evaluating the Environmental Effects of Radiofrequency Radiation*, released August 1, 1996.

FCC Office of Engineering and Technology (OET) Bulletin 65, "Evaluating Compliance with FCC Guidelines for Human Exposure to Radiofrequency Electromagnetic Fields", Edition 97-01, August 1997.

FCC Office of Engineering and Technology (OET) Bulletin 56, "Questions and Answers About Biological Effects and Potential Hazards of Radiofrequency Electromagnetic Fields", Fourth Edition, August 1999.

Richard Tell, "CTIA's EME Design and Operation Considerations for Wireless Antenna Sites", November 15, 1996.

**ATTACHMENT A**

***Site Data***



## Tower Loading Form

### Site Reference Information:

Cascade #: CT03xc076  % of Structural Capacity at last analysis  
 Site Address: 28 Brewer Drive Bloomfield, CT Lease Area 100x100  
 Structure Height: 120 Compound Size: odd shaped  
 Tower Manufacturer: Rohn Structure Type: Monopole  
 Tower Contact #: 309-697-4400 File #: 34738/SW  
 Original Design Load for Structure:  1 Carrier  2 Carrier  3 Carrier  4 Carrier  \_\_\_Carrier

Prepared By: Russ Van Date: 3/18/03 MPE:  INTERFERENCE:  Structural:  Carrier Requested: Name

### Sprint Antenna Information:

ACL	# of Ant.	Frequency	Model #	Type	Orientation	Mounting Type	# of Cables	Cable Size
120	9	B Block	DB980H90	Panel	30-150-270	Platform	9	1-5/8"
	*	*		*		*	*	*
	*	*		*		*	*	*

### Co-location Information:

ID	Carrier	ACL	# Of Ant.	Frequency	TX Output	Model #	Antenna Type	Orientation	Mounting Type	# of Cables	Cable Size	Tenant Status	Cable Loc
1	Cingular	97	9	850&1900		CSS DU04-8670	Panel	23-143-263	Platform	9	7/8"	EXT	Ins
1	Cingular	97	6	*	*	ADC MHA's	*		*	*	*	*	*
*	*		*	*	*		*		*	*	*	*	*
2	Voicestream	107	3	* 1900	12 Watts	EMS DR65-18-DPL	Panel	100-220-340	Platform	12	1-5/8"	EXT	Ins
3	*	59	1	*	*	DB536	Whip		Stand-off arm	1	1/2"	EXT	Ins
*	*		*	*	*		*		*	*	*	*	*
*	*		*	*	*		*		*	*	*	*	*
*	*		*	*	*		*		*	*	*	*	*
*	*		*	*	*		*		*	*	*	*	*
*	*		*	*	*		*		*	*	*	*	*

Comments: Colo #3 is the municipality

### Contact Information:

Co Id	Contact Person	Phone Number	E-Mail Address