

August 18, 2015

Members of the Siting Council
Connecticut Siting Council
Ten Franklin Square
New Britain, CT 06051

RE: Notice of Exempt Modification
10 Redwood Lane
Avon, CT 06001
N 41° 46' 20"
W 72° 52' 48"
T-Mobile Site #: CT11380C_L700

Members of the Siting Council:

On behalf of T-Mobile, SBA Communications is submitting an exempt modification application to the Connecticut Siting council for modification of existing equipment at a tower facility located at 10 Redwood Lane, Avon, CT.

The 10 Redwood Lane facility consists of a 105' Monopole Tower owned and operated by SBA Towers, LLC. In order to accommodate technological changes and enhance system performance in the state of Connecticut, T-Mobile plans to modify the equipment configurations at many of its existing cell sites. Please accept this letter and attachments as notification, pursuant to R.C.S.A. Section 16-50j-73, of construction which constitutes an exempt modification pursuant to R.C.S.A. Section 16-50j-72(b)(2). In compliance with R.C.S.A. Section 16-50j-73, a copy of this letter and attachments is being sent to the elected official of the municipality in which the affected cell site is located and the property owner (Town Manager Brandon Robertson and Farmington Woods Master Association, respectively.)

As part of T-Mobile's L700 project, T-Mobile desires to upgrade their equipment to meet the new standards of 4G technology. The new equipment will allow customers to download files and browse the internet at a high rate of speed while also allowing their phones to be compatible with the latest 4G technology.

Attached is a summary of the planned modifications, including power density calculations reflecting the change in T-Mobile's operations at the site along with the required fee of \$625.

The changes to the facility do not constitute modifications as defined in Connecticut General Statutes (“C.G.S.”) Section 16-50i(d) because the general physical characteristics of the facility will not be significantly changed or altered. Rather, the planned changes to the facility fall squarely within those activities explicitly provided for in R.C.S.A. Section 16-50j-72(b)(2).

1. The overall height of the structure will be unaffected.
2. The proposed changes will not extend the site boundaries. There will be no effect on the site compound other than the new equipment cabinets.
3. The proposed changes will not increase the noise level at the existing facility by six decibels or more.
4. The changes in radio frequency power density will not increase the calculated “worst case” power density for the combined operations at the site to a level at or above the applicable standard for uncontrolled environments as calculated for a mixed frequency site.

For the foregoing reasons, SBA Communications on behalf of T-Mobile, respectfully submits that the proposed changes at the referenced site constitute exempt modifications under R.C.S.A. Section 16-50j-72(b)(2).

Please feel free to call me at 508.251.0720 x 3804 with any questions you may have concerning this matter.

Thank you,



Kri Pelletier
SBA Communications Corporation
33 Boston Post Road West Suite 320
Marlborough, MA 01752
508-251-0720 x 3804 + T
508-251-1755 + F
203-446-7700 + C
kpelletier@sbsite.com



**T-Mobile
Equipment Modification**

10 Redwood Lane, Avon, CT
Site number CT11380C_L700

Tower Owner: SBA Towers, LLC

Equipment Configuration: Monopole

Current and/or approved:

- (3) Ericsson AIR B2A B4P – Panel
- (3) Ericsson AIR B4A B2P – Panel
- (3) Ericsson KRY 112 144 – TMA
- (12) 1 5/8" lines
- (1) 1 5/8" Fiber

Planned Modifications:

- (3) Ericsson AIR B2A B4P - Panel
- (3) Ericsson AIR B4A B2P - Panel
- (3) Ericsson S11B12 – RRU
- (3) Ericsson KRY 112 144 - TMA
- (3) Commscope LNX-6515DS - Panel
- (12) 1 5/8" lines
- (1) 1 5/8" Fiber

Structural Information:

The attached structural analysis demonstrates that the tower and foundation will have adequate structural capacity to accommodate the proposed modifications.

Power Density:

The anticipated Maximum Composite contributions from the T-Mobile facility are 11.16% of the allowable FCC established general public limit. The anticipated composite MPE value for this site assuming all carriers present is 82.65% of the allowable FCC established general public limit sampled at the ground level.

Site Composite MPE%	
Carrier	MPE%
T-Mobile	11.16
AT&T	37.56 %
MetroPCS	20.50 %
Clearwire	2.24 %
Sprint	0.41 %
Farm. Woods	10.78 %
Site Total MPE %:	82.65 %

August 18, 2015

Mr. Brandon Robertson
Town Manager
Town of Avon
60 West Main Street
Avon, CT 06001

RE: Telecommunications Facility @ 10 Redwood Lane, Avon, CT

Dear Mr. Robertson,

In order to accommodate technological changes and enhance system performance in the State of Connecticut, T-Mobile will be changing its equipment configuration at certain cell sites.

As required by Regulations of Connecticut State Agencies (R.C.S.A.) Section 16-50j-73, the Connecticut Siting Council has been notified of the changes and will review T-Mobile's proposal. Please accept this letter as notification under Section 16-50j-73 of construction which constitutes an exempt modification pursuant to R.C.S.A. Section 16-50j-72(b)(2).

The accompanying letter to the Siting Council fully describes T-Mobile's proposal for the referenced cell site. However, if you have any questions or require any further information on our plans or the Siting Council's procedures, please call me at 508.251.0720 x 3804.

Thank you,



Kri Pelletier
SBA Communications Company
33 Boston Post Road West Suite 320
Marlborough, MA 01752
508-251-0720 x 3804 + T
508-251-1755 + F
203-446-7700 + C
kpelletier@sbsite.com

August 18, 2015

Farmington Woods Master Association
200 Byron Drive
Avon, CT 06001

RE: Telecommunications Facility @ 10 Redwood Lane, Avon, CT

To Whom It May Concern:

In order to accommodate technological changes and enhance system performance in the State of Connecticut, T-Mobile will be changing its equipment configuration at certain cell sites.

As required by Regulations of Connecticut State Agencies (R.C.S.A.) Section 16-50j-73, the Connecticut Siting Council has been notified of the changes and will review T-Mobile's proposal. Please accept this letter as notification under Section 16-50j-73 of construction which constitutes an exempt modification pursuant to R.C.S.A. Section 16-50j-72(b)(2).

The accompanying letter to the Siting Council fully describes T-Mobile's proposal for the referenced cell site. However, if you have any questions or require any further information on our plans or the Siting Council's procedures, please call me at 508.251.0720 x 3804.

Thank you,



Kri Pelletier
SBA Communications Company
33 Boston Post Road West Suite 320
Marlborough, MA 01752
508-251-0720 x 3804 + T
508-251-1755 + F
203-446-7700 + C
kpelletier@sbsite.com

SBA Network Services, LLC

Acn

To: CONNECTICUT SITING COUNCIL 129986

Check Number: 2097390
Date: 07/07/2015

Invoice Number	Invoice Date	Description	Gross Amount	Taxes Withheld	Net Amount
PRSF07061503	07/08/2015	CSC Fee CT11380C_L700	\$625.00	\$0.00	\$625.00

\$625.00	\$0.00	\$625.00
----------	--------	----------

SBA Network Services, LLC
8051 Congress Avenue
Boca Raton, FL 33487-1307
(561) 995-7670

Wells Fargo Bank

2097390

061209756

129986

DATE

AMOUNT

07/07/2015

\$625.00

Six Hundred Twenty Five Dollars And 00 Cents

Void After 120 Days

Pay to the Order of:

CONNECTICUT SITING COUNCIL
ACCOUNTS RECEIVABLE
TEN FRANKLIN SQUARE

NEW BRITAIN, CT 06051

Prue Logan

⑈ 2097390⑈ ⑆ 06 ⑆ 209756⑆ 2079900424566⑈



Tower Engineering Solutions

Phone (972) 483-0607, Fax (972) 975-9615
8445 Freeport Parkway, Suite 375, Irving, Texas 75063

Structural Analysis Report

Existing 105 ft PIROD Monopole

Customer Name: SBA Communications Corp

Customer Site Number: CT01498-S

Customer Site Name: Avon

Carrier Name: T-Mobile

Carrier Site Number: CT11380C

Carrier Site Name: N/A

Site Location: 10 Redwood Lane

Avon, Connecticut

Hartford County

Latitude: 41.772499

Longitude: -72.879999

Analysis Result:

Max Structural Usage: 60.4% [Pass]

Max Foundation Usage: 62.0% [Pass]

Report Prepared By : Fabiaye Arinyedokiari



Introduction

The purpose of this report is to summarize the analysis results on the 105 ft PIROD Monopole to support the proposed antennas and transmission lines in addition to those currently installed. Any modification listed under Sources of Information was assumed completed and was included in this analysis.

Sources of Information

Tower Drawings	Pirod, Inc., Eng. File #A-117586 dated September 26, 2000
Foundation Drawing	Pirod, Inc., Eng. File #A-117586 dated September 26, 2000
Geotechnical Report	Jaworski Geotech, Inc., Project #00301G dated August 31, 2000
Modification Drawings	N/A

Analysis Criteria

The analysis was performed in accordance with the requirements and stipulations of the ANSI/TIA/EIA 222-F. In accordance with this standard, the structure was analyzed using **TESPoles**, a proprietary analysis software. The program considers the structure as an elastic 3-D model with second-order effects and temperature effects incorporated in the analysis. The analysis was performed using multiple wind directions.

Basic Wind Speed Used in the Analysis:	80 mph (fastest mile)
Basic Wind Speed with Ice:	69 mph (fastest mile) with 1/2" radial ice concurrent
Operational Wind Speed:	50 mph + 0" Radial ice
Standard/Codes:	ANSI/TIA/EIA 222-F / 2003 IBC / 2005 Connecticut State Building Code

Existing Antennas, Mounts and Transmission Lines

The table below summarizes the antennas, mounts and transmission lines that were considered in the analysis as existing on the tower.

Items	Elevation (ft)	Qty.	Antenna Descriptions	Mount Type & Qty.	Transmission Lines	Owner
1	116.0	1	20' Omni	Low Profile Platform	(1) 7/8"	Farmington Woods
-	106.0	3	Ericsson AIR B2A B4P - Panel		(12) 1 5/8" (1) 1 5/8" Fiber	T-Mobile
-		3	Ericsson AIR B4A B2P - Panel			
-		3	Ericsson KRY 112 144 - TMA			
7	98.0	1	Raycap DC2-48-60-18-8F – Surge Arrestor	(3) Standoffs	(12) 1 5/8" (1) 10 mm Fiber (1) 3" (2) DC Power	AT&T
8		6	Ericsson RRUS-11 - RRU			
9	97.0	6	Kathrein 782-10250 - Diplexers	Low Profile Platform		
10		3	Kathrein Scala - 800-10121 - Panel			
11		6	Kathrein 860-10035 – RET			
12		9	KMW - AM-X-CD-16-65-00T-RET - Panel			
13		6	Powerwave LGP21401 - TMA			
14	91.0	3	Horizon DUO Radios	Low Profile Platform	(3) 1/2" (6) 5/16"	Clearwire
15		3	Samsung RRU Radios			
16		3	Andrew Microwaves - VHL P2.5 - Dish			
17	87.0	3	Alcatel Lucent 800MHz Filter	Low Profile Platform	(4) 1-1/4" Hybrid	Sprint
18		4	RFS ACU-A20-N – RET			
19		3	RFS APXVSP18-C-A20 - Panel			
20		3	RFS APXVTM14-C-120 - Panel			
21		3	Alcatel Lucent 1900 MHz – RRH			
22		3	Alcatel Lucent 800 MHz – RRH			
23		3	Alcatel Lucent TD-RRH8x20-25 - RRH			

Proposed Carrier’s Final Configuration of Antennas, Mounts and Transmission Lines

Information pertaining to the proposed carrier’s final configuration of antennas and transmission lines was provided by SBA Communications Corp. The proposed antennas and lines are listed below.

Items	Elevation (ft)	Qty.	Antenna Descriptions	Mount Type & Qty.	Transmission Lines	Owner
2	110.0	3	Ericsson AIR B2A B4P - Panel	Low Profile Platform	(12) 1 5/8" (1) 1 5/8" Fiber	T-Mobile
3		3	Ericsson AIR B4A B2P - Panel			
4		3	Ericsson S11B12 – RRU			
5		3	Ericsson KRY 112 144 - TMA			
6		3	Commscope LNX-6515DS - Panel			

All transmission lines are considered running inside of the pole shaft.

Analysis Results

The results of the structural analysis, performed for the wind and ice loading and antenna equipment as defined above, are summarized as the following:

	Pole shafts	Anchor Bolts	Base Plate
Max. Usage:	59.8%	53.0%	60.4%
Pass/Fail	Pass	Pass	Pass

Foundations

	Moment (Kip-Ft)	Shear (Kips)	Axial (Kips)
Original Design Reactions	2555.3	31.1	40.6
Analysis Reactions	1648.1	20.3	37.2
% of Design Reactions	64.5%	65.3%	91.6%

The foundation has been investigated using the supplied documents and soils report and was found adequate. Therefore, no modification to the foundation will be required.

Operational Condition (Rigidity):

Operational characteristics of the tower are found to be within the limits prescribed by ANSI/TIA/EIA 222-F for the installed antennas. Maximum twist/sway at the elevation of the proposed equipment is 0.403 degrees under the operational wind speed as specified in the Analysis Criteria.

Maximum twist and sway of the microwave dishes under the operational wind speed as specified in the Analysis Criteria are listed in the table below:

Elevation (ft)	Dish	Carrier	Twist (deg)	Sway (deg)
91.0	Andrew Microwaves - VHLP2.5 - Dish	Clearwire	0.000	0.391

Conclusions

Based on the analysis results, the existing structure and its foundation were found to be adequate to safely support the existing and proposed equipment and meet the minimum requirements per the ANSI/TIA/EIA 222-F Standard under the design basic wind speed as specified in the Analysis Criteria.

Standard Conditions

1. This analysis was performed based on the information supplied to **(TES) Tower Engineering Solutions, LLC**. Verification of the information provided was not included in the Scope of Work for **TES**. The accuracy of the analysis is dependent on the accuracy of the information provided.
2. The analysis is based on the presumption that the tower members and components along with any existing reinforcement items have been correctly and properly designed, manufactured, installed and maintained.
3. All the existing structural members were assumed to be in good condition with no physical damage or deterioration associated with corrosion.
4. An initial tension of 10% of the break strength on all the existing guy wires was assumed in all the structural analyses of guyed towers unless different values were provided by the client. **TES** cannot take responsibility for the deviations in the analysis results because of differences in the initial tension forces of the existing guy wires.
5. Secondary component or connection secondary components, welds and bolts are assumed to be able to carry their intended original design loads. **TES** cannot take responsibility for verification of the adequacy on the connections, bolts and welds present in the structure.
6. The analyses will be performed based on the codes as specified by the client or based on the best knowledge of the engineering staff of **TES**. In the absence of information to the contrary, all work will be performed in accordance with the latest relevant revision of ANSI/TIA-222. If wind speed or/and ice loads are different from the minimum values recommended by the EIA/TIA-222 standard or other codes, **TES** should be notified in writing and the applicable minimum values provided by the client.
7. The configuration of the existing mounts, antennas, coax and other appurtenances were supplied by the customer for the current structural analysis. **TES** has not visited the tower site to verify the adequacy of the information provided. If there is any discrepancy found in the report regarding the existing conditions, **TES** should be notified immediately to evaluate the effect of the discrepancy on the analysis results.
8. The client will assume responsibility for rework associated with the differences in initially provided information, including tower and foundation information, existing and/or proposed equipment and transmission lines.
9. If a feasibility analysis was performed, final acceptance of changed conditions shall be based upon a rigorous structural analysis.

Usage Diagram - Max Stress 59.8% at 0.0ft

Structure: CT01498-S-SBA
Site Name: Avon
Height: 105.00 (ft)
Base Elev: 0.000 (ft)

Code: EIA/TIA-222-F
Exposure: C
Gh: 1.69

7/29/2015



Page: 1

Dead Load Factor: 1.00
Wind Load Factor: 1.00

Load Case : 80 mph Wind with 0 in Ice

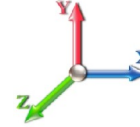

Iterations: 16

33 Allowable Stress
19 Resulting Stress

Copyright © 2015 by Tower Engineering Solutions, LLC. All rights reserved.

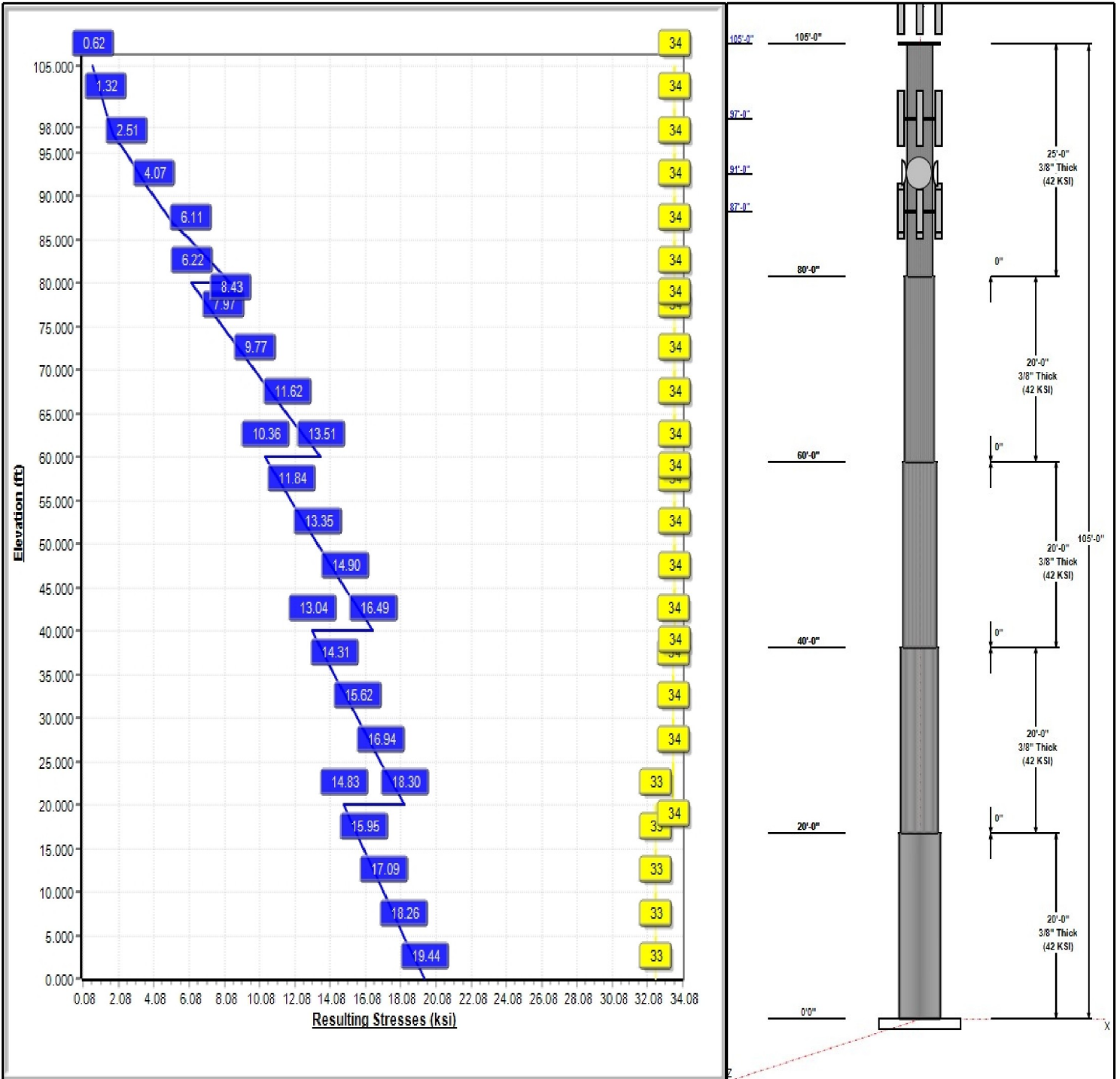

Structure: CT01498-S-SBA

Type: Stepped
Site Name: Avon
Height: 105.00 (ft)
Base Elev: 0.00 (ft)

Base Shape: Round
Taper: 0.00000

7/29/2015

Page: 2



Shaft Properties

Seq	Length (ft)	Top (in)	Bottom (in)	Thick (in)	Joint Type	Taper	Grade (ksi)
1	20.00	60.00	60.00	0.375		0.00000	42
2	20.00	54.00	54.00	0.375		0.00000	42
3	20.00	48.00	48.00	0.375		0.00000	42
4	20.00	42.00	42.00	0.375		0.00000	42
5	25.00	36.00	36.00	0.375		0.00000	42

Discrete Appurtenances

Attach Elev (ft)	Force Elev (ft)	Qty	Description	Carrier
105.00	116.00	1	20' Omni	Farmington Woods
105.00	110.00	3	AIR 21, 1.3M, B2A B4P	T-Mobile
105.00	110.00	3	AIR 21, 1.3M, B4A B2P	T-Mobile
105.00	110.00	3	Ericsson S11B12	T-Mobile
105.00	110.00	3	KRY 112 144/1	T-Mobile
105.00	110.00	3	LNX-6515DS	T-Mobile
105.00	105.00	1	Low Profile	T-Mobile
98.00	98.00	1	DC6-48-60-18-8F	AT&T
98.00	98.00	1	Flush Mount	AT&T
98.00	98.00	6	RRUS-11	AT&T
97.00	97.00	6	782 10250	AT&T
97.00	97.00	3	800-10121	AT&T
97.00	97.00	6	860 10035	AT&T
97.00	97.00	9	AM-X-CD-16-65-00T-RET	AT&T
97.00	97.00	6	LGP21401	AT&T
97.00	97.00	1	Low Profile	AT&T
91.00	91.00	3	Horizon DUO Radios	Clearwire
91.00	91.00	3	RRU	Clearwire
91.00	91.00	3	VHLP2.5	Clearwire
87.00	87.00	3	800MHz Filter	Sprint
87.00	87.00	4	ACU-A20-N	Sprint
87.00	87.00	3	APXVSP18-C-A20	Sprint
87.00	87.00	3	APXVTM14-C-120	Sprint
87.00	87.00	1	Low Profile	Sprint
87.00	87.00	3	RRUS-11 1900 MHz	Sprint
87.00	87.00	3	RRUS-11 800 MHz	Sprint
87.00	87.00	3	TD-RRH8x20-25	Sprint
75.00	75.00	1	GPS	T-Mobile
75.00	75.00	1	Standoff Mount	T-Mobile

Linear Appurtenances

Elev From (ft)	Elev To (ft)	Placement	Description	Carrier
0.00	105.00	Inside	1 5/8" Coax	T-Mobile
0.00	105.00	Inside	1 5/8" Fiber	T-Mobile
0.00	105.00	Inside	7/8" Coax	Farmington Woods
0.00	97.00	Inside	1 5/8" Coax	AT&T
0.00	97.00	Inside	10 mm Fiber	AT&T
0.00	97.00	Inside	3" Coax	AT&T
0.00	97.00	Inside	3/4" DC	AT&T
0.00	91.00	Inside	1/2" Coax	Sprint
0.00	91.00	Inside	5/16" Coax	Clearwire
0.00	87.00	Inside	1-1/4" Hybrid	Sprint

Anchor Bolts

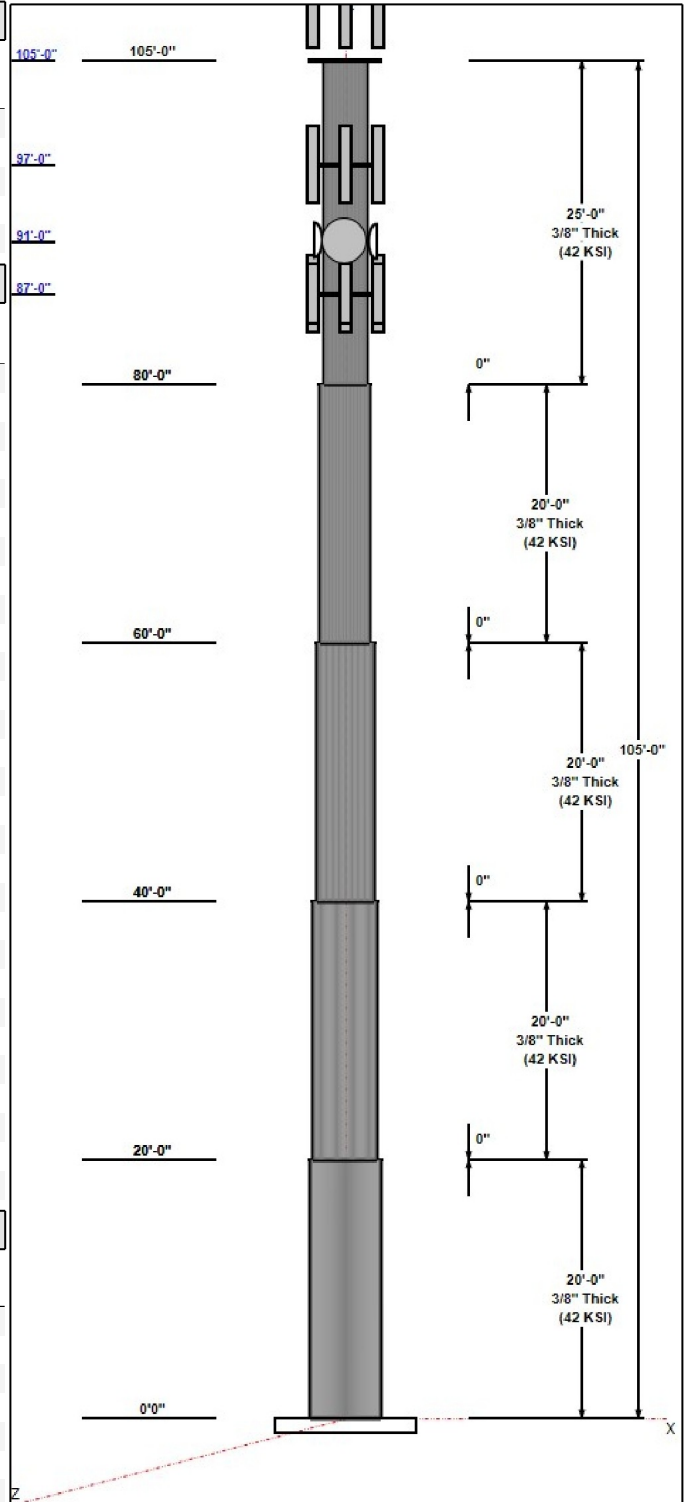

Structure: CT01498-S-SBA

Type: Stepped
Site Name: Avon
Height: 105.00 (ft)
Base Elev: 0.00 (ft)

Base Shape: Round
Taper: 0.00000

7/29/2015

Page: 3



Qty	Specifications	Grade (ksi)	Arrangement
48	1.00" A687	105.0	Radial

Base Plate

Thickness (in)	Specifications (in)	Grade (ksi)	Geometry
1.2500	66.1	36.0	Round

Reactions

Load Case	Moment	Shear	Axial
80 mph Wind with 0" Ice	1646.4	20.2	31.2
69.28 mph Wind with 0.5" Ice	1364.9	16.5	37.2
50 mph Wind with 0" Ice	643.1	7.9	31.2

Shaft Properties

Structure: CT01498-S-SBA
Site Name: Avon
Height: 105.00 (ft)
Base Elev: 0.000 (ft)

Code: EIA/TIA-222-F
Exposure: C
Gh: 1.69
Struct Class: II

7/29/2015
 Page: 4



Sec. No.	Shape	Length (ft)	Thick (in)	Fy (ksi)	Joint Type	Overlap (in)	Weight (lb)
1	R	20.000	0.3750	42		0.00	4,780
2	R	20.000	0.3750	42		0.00	4,299
3	R	20.000	0.3750	42		0.00	3,818
4	R	20.000	0.3750	42		0.00	3,337
5	R	25.000	0.3750	42		0.00	3,570
Total Shaft Weight:							19,806

Bottom

Top

Sec. No.	Dia (in)	Elev (ft)	Area (sqin)	Ix (in^4)	W/t Ratio	D/t Ratio	Dia (in)	Elev (ft)	Area (sqin)	Ix (in^4)	W/t Ratio	D/t Ratio	Taper
1	60.00	0.00	70.24	31239.85	0	160	60.00	20.00	70.24	31239.8	0	160	0.000000
2	54.00	20.00	63.18	22726.14	0	144	54.00	40.00	63.18	22726.1	0	144	0.000000
3	48.00	40.00	56.11	15919.48	0	128	48.00	60.00	56.11	15919.4	0	128	0.000000
4	42.00	60.00	49.04	10628.86	0	112	42.00	80.00	49.04	10628.8	0	112	0.000000
5	36.00	80.00	41.97	6663.29	0	96	36.00	105.0	41.97	6663.29	0	96	0.000000

Loading Summary

Structure: CT01498-S-SBA
Site Name: Avon
Height: 105.00 (ft)
Base Elev: 0.000 (ft)

Code: EIA/TIA-222-F
Exposure: C
Gh: 1.69
Struct Class: II

7/29/2015
 Page: 5



Discrete Appurtenances

No.	Elev (ft)	Description	Qty	No Ice			Ice			Hor. Ecc. (ft)	Vert Ecc (ft)
				Weight (lb)	CaAa (sf)	CaAa Factor	Weight (lb)	CaAa (sf)	CaAa Factor		
1	105.0	20' Omni	1	55.00	6.00	1.00	98.10	8.030	1.00	0.00	11.00
2	105.0	AIR 21, 1.3M, B2A B4P	3	91.50	6.58	0.86	129.20	6.970	0.86	0.00	5.00
3	105.0	AIR 21, 1.3M, B4A B2P	3	90.40	6.58	0.86	128.10	6.970	0.86	0.00	5.00
4	105.0	Ericsson S11B12	3	51.00	3.31	0.71	67.10	3.520	0.72	0.00	5.00
5	105.0	KRY 112 144/1	3	11.00	0.41	0.67	14.10	0.550	0.67	0.00	5.00
6	105.0	LNx-6515DS	3	49.80	11.41	0.80	115.60	12.34	0.80	0.00	5.00
7	105.0	Low Profile Platform-Round	1	1500.00	22.00	1.00	1800.00	27.00	1.00	0.00	0.00
8	98.00	DC6-48-60-18-8F	1	31.80	1.47	1.00	49.50	1.670	1.00	0.00	0.00
9	98.00	Flush Mount	1	350.00	5.00	1.00	450.00	6.000	1.00	0.00	0.00
10	98.00	RRUS-11	6	44.00	2.94	0.70	63.30	3.290	0.70	0.00	0.00
11	97.00	782 10250	6	6.40	0.52	0.76	10.00	0.690	0.76	0.00	0.00
12	97.00	800-10121	3	44.10	5.45	0.79	77.00	6.090	0.79	0.00	0.00
13	97.00	860 10035	6	1.20	0.18	0.92	2.80	0.280	0.92	0.00	0.00
14	97.00	AM-X-CD-16-65-00T-RET	9	48.50	8.26	0.75	95.00	9.080	0.75	0.00	0.00
15	97.00	LGP21401	6	14.10	1.29	0.67	21.20	1.530	0.67	0.00	0.00
16	97.00	Low Profile Platform-Round	1	1500.00	22.00	1.00	1800.00	27.00	1.00	0.00	0.00
17	91.00	Horizon DUO Radios	3	11.50	0.84	0.76	17.90	1.030	0.76	0.00	0.00
18	91.00	RRU	3	42.00	1.92	0.88	57.70	2.210	0.88	0.00	0.00
19	91.00	VHLP2.5	3	47.60	8.43	1.00	97.00	8.920	1.00	0.00	0.00
20	87.00	800MHz Filter	3	10.00	0.49	0.70	14.60	0.650	0.70	0.00	0.00
21	87.00	ACU-A20-N	4	1.00	0.14	0.79	2.30	0.220	0.79	0.00	0.00
22	87.00	APXVSP18-C-A20	3	57.00	8.26	0.83	106.50	9.080	0.83	0.00	0.00
23	87.00	APXVTM14-C-120	3	56.00	6.90	0.79	91.90	7.290	0.79	0.00	0.00
24	87.00	Low Profile Platform-Round	1	1500.00	22.00	1.00	1800.00	27.00	1.00	0.00	0.00
25	87.00	RRUS-11 1900 MHz	3	44.00	2.94	0.70	63.30	3.290	0.70	0.00	0.00
26	87.00	RRUS-11 800 MHz	3	54.00	2.94	0.75	75.60	3.290	0.75	0.00	0.00
27	87.00	TD-RRH8x20-25	3	70.00	4.72	0.69	92.00	4.970	0.69	0.00	0.00
28	75.00	GPS	1	10.00	1.00	1.00	18.00	1.250	1.00	0.00	0.00
29	75.00	Standoff Mount	1	50.00	0.50	1.00	60.00	0.700	1.00	0.00	0.00
Totals:			90	8,021.20			10,966.40				

Linear Appurtenances

Bottom Elev. (ft)	Top Elev. (ft)	Description	No Ice		Ice		Exposed
			Weight (lb/ft)	CaAa (sf/ft)	Weight (lb/ft)	CaAa (sf/ft)	
0.00	105.0	(12) 1 5/8" Coax	12.48	0.00	12.48	0.00	Inside
0.00	105.0	(1) 1 5/8" Fiber	1.10	0.00	1.10	0.00	Inside
0.00	105.0	(1) 7/8" Coax	0.52	0.00	0.52	0.00	Inside
0.00	97.00	(12) 1 5/8" Coax	12.48	0.00	12.48	0.00	Inside
0.00	97.00	(1) 10 mm Fiber	0.06	0.00	0.06	0.00	Inside
0.00	97.00	(1) 3" Coax	1.78	0.00	1.78	0.00	Inside
0.00	97.00	(2) 3/4" DC	0.80	0.00	0.80	0.00	Inside
0.00	91.00	(3) 1/2" Coax	0.48	0.00	0.48	0.00	Inside
0.00	91.00	(6) 5/16" Coax	0.48	0.00	0.48	0.00	Inside
0.00	87.00	(4) 1-1/4" Hybrid	3.82	0.00	3.82	0.00	Inside

Discrete Appurtenances

No.	Elev (ft)	Description	Qty	No Ice			Ice			Hor. Ecc. (ft)	Vert Ecc (ft)
				Weight (lb)	CaAa (sf)	CaAa Factor	Weight (lb)	CaAa (sf)	CaAa Factor		
Totals:				3,366.49			3,366.84				

Shaft Section Properties

Structure: CT01498-S-SBA
Site Name: Avon
Height: 105.00 (ft)
Base Elev: 0.000 (ft)

Code: EIA/TIA-222-F
Exposure: C
Gh: 1.69
Struct Class: II

7/29/2015
 Page: 7



Increment Length: 5 (ft)

Elev (ft)	Description	Thick (in)	Dia (in)	Area (in^2)	Ix (in^4)	W/t Ratio	D/t Ratio	Fy (ksi)	Fb (ksi)	Weight (lb)
0.00		0.3750	60.000	70.244	31239.9	0.00	160.00	42	33	0.0
5.00		0.3750	60.000	70.244	31239.9	0.00	160.00	42	33	1195.1
10.00		0.3750	60.000	70.244	31239.9	0.00	160.00	42	33	1195.1
15.00		0.3750	60.000	70.244	31239.9	0.00	160.00	42	33	1195.1
20.00	Top - Section 1	0.0000	0.000	0.000	0.0	NAN	NAN	0	0	1195.1
20.00	Bot - Section 2	0.3750	60.000	70.244	31239.9	0.00	160.00	42	33	
25.00		0.3750	54.000	63.175	22726.1	0.00	144.00	42	34	1074.9
30.00		0.3750	54.000	63.175	22726.1	0.00	144.00	42	34	1074.9
35.00		0.3750	54.000	63.175	22726.1	0.00	144.00	42	34	1074.9
40.00	Top - Section 2	0.0000	0.000	0.000	0.0	NAN	NAN	0	0	1074.9
40.00	Bot - Section 3	0.3750	54.000	63.175	22726.1	0.00	144.00	42	34	
45.00		0.3750	48.000	56.107	15919.5	0.00	128.00	42	34	954.6
50.00		0.3750	48.000	56.107	15919.5	0.00	128.00	42	34	954.6
55.00		0.3750	48.000	56.107	15919.5	0.00	128.00	42	34	954.6
60.00	Top - Section 3	0.0000	0.000	0.000	0.0	NAN	NAN	0	0	954.6
60.00	Bot - Section 4	0.3750	48.000	56.107	15919.5	0.00	128.00	42	34	
65.00		0.3750	42.000	49.038	10628.9	0.00	112.00	42	34	834.3
70.00		0.3750	42.000	49.038	10628.9	0.00	112.00	42	34	834.3
75.00		0.3750	42.000	49.038	10628.9	0.00	112.00	42	34	834.3
80.00	Top - Section 4	0.0000	0.000	0.000	0.0	NAN	NAN	0	0	834.3
80.00	Bot - Section 5	0.3750	42.000	49.038	10628.9	0.00	112.00	42	34	
85.00		0.3750	36.000	41.970	6663.3	0.00	96.00	42	34	714.1
87.00		0.3750	36.000	41.970	6663.3	0.00	96.00	42	34	285.6
90.00		0.3750	36.000	41.970	6663.3	0.00	96.00	42	34	428.4
91.00		0.3750	36.000	41.970	6663.3	0.00	96.00	42	34	142.8
95.00		0.3750	36.000	41.970	6663.3	0.00	96.00	42	34	571.3
97.00		0.3750	36.000	41.970	6663.3	0.00	96.00	42	34	285.6
98.00		0.3750	36.000	41.970	6663.3	0.00	96.00	42	34	142.8
100.00		0.3750	36.000	41.970	6663.3	0.00	96.00	42	34	285.6
105.00		0.3750	36.000	41.970	6663.3	0.00	96.00	42	34	714.1
										19806.0

Wind Loading - Shaft

Structure: CT01498-S-SBA
Site Name: Avon
Height: 105.00 (ft)
Base Elev: 0.000 (ft)

Code: EIA/TIA-222-F
Exposure: C
Gh: 1.69
Struct Class: II

7/29/2015
 Page: 8



Load Case: 80 mph Wind with 0" Ice

Dead Load Factor 1.00
Wind Load Factor 1.00

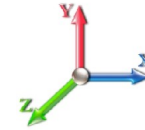

Iterations: 16

Elev (ft)	Description	Kzt	Kz	qz (psf)	qzGh (psf)	C (mph-ft)	Cf	Ice Thick (in)	Tributary (ft)	Aa (sf)	CfAa (sf)	Wind Force X (lb)	Dead Load Ice (lb)	Tot Dead Load (lb)
0.00		0.00	1.00	16.384	27.69	400.00	0.590	0.000	0.00	0.000	0.00	0.0	0.0	0.0
5.00		0.00	1.00	16.384	27.69	400.00	0.590	0.000	5.00	25.000	14.75	408.4	0.0	1195.1
10.00		0.00	1.00	16.384	27.69	400.00	0.590	0.000	5.00	25.000	14.75	408.4	0.0	1195.1
15.00		0.00	1.00	16.384	27.69	400.00	0.590	0.000	5.00	25.000	14.75	408.4	0.0	1195.1
20.00	Top - Section 1	0.00	1.00	16.384	27.69	400.00	0.590	0.000	5.00	25.000	14.75	408.4	0.0	1195.1
25.00		0.00	1.00	16.384	27.69	360.00	0.590	0.000	5.00	22.500	13.27	367.6	0.0	1074.9
30.00		0.00	1.00	16.384	27.69	360.00	0.590	0.000	5.00	22.500	13.27	367.6	0.0	1074.9
35.00		0.00	1.02	16.662	28.16	363.04	0.590	0.000	5.00	22.500	13.27	373.8	0.0	1074.9
40.00	Top - Section 2	0.00	1.06	17.310	29.25	370.03	0.590	0.000	5.00	22.500	13.27	388.3	0.0	1074.9
45.00		0.00	1.09	17.902	30.25	334.50	0.590	0.000	5.00	20.000	11.80	357.0	0.0	954.6
50.00		0.00	1.13	18.449	31.18	339.57	0.590	0.000	5.00	20.000	11.80	367.9	0.0	954.6
55.00		0.00	1.16	18.959	32.04	344.23	0.590	0.000	5.00	20.000	11.80	378.1	0.0	954.6
60.00	Top - Section 3	0.00	1.19	19.436	32.85	348.53	0.590	0.000	5.00	20.000	11.80	387.6	0.0	954.6
65.00		0.00	1.21	19.885	33.61	308.47	0.590	0.000	5.00	17.500	10.32	347.0	0.0	834.3
70.00		0.00	1.24	20.311	34.33	311.75	0.590	0.000	5.00	17.500	10.32	354.4	0.0	834.3
75.00	Appurtenance(s)	0.00	1.26	20.715	35.01	314.84	0.590	0.000	5.00	17.500	10.32	361.5	0.0	834.3
80.00	Top - Section 4	0.00	1.29	21.101	35.66	317.76	0.590	0.000	5.00	17.500	10.32	368.2	0.0	834.3
85.00		0.00	1.31	21.469	36.28	274.73	0.590	0.000	5.00	15.000	8.85	321.1	0.0	714.1
87.00	Appurtenance(s)	0.00	1.32	21.613	36.53	275.65	0.590	0.000	2.00	6.000	3.54	129.3	0.0	285.6
90.00		0.00	1.33	21.823	36.88	276.99	0.590	0.000	3.00	9.000	5.31	195.8	0.0	428.4
91.00	Appurtenance(s)	0.00	1.34	21.892	37.00	277.42	0.590	0.000	1.00	3.000	1.77	65.5	0.0	142.8
95.00		0.00	1.35	22.163	37.45	279.13	0.590	0.000	4.00	12.000	7.08	265.2	0.0	571.3
97.00	Appurtenance(s)	0.00	1.36	22.295	37.68	279.97	0.590	0.000	2.00	6.000	3.54	133.4	0.0	285.6
98.00	Appurtenance(s)	0.00	1.36	22.360	37.79	280.38	0.590	0.000	1.00	3.000	1.77	66.9	0.0	142.8
100.00		0.00	1.37	22.490	38.01	281.19	0.590	0.000	2.00	6.000	3.54	134.5	0.0	285.6
105.00	Appurtenance(s)	0.00	1.39	22.806	38.54	283.15	0.590	0.000	5.00	15.000	8.85	341.1	0.0	714.1
Totals:									105.00			7,705.4		19,806.0

Discrete Appurtenance Forces

Structure: CT01498-S-SB
Site Name: Avon
Height: 105.00 (ft)
Base Elev: 0.000 (ft)

Code: EIA/TIA-222-F
Exposure: C
Gh: 1.69
Struct Class: II

7/29/2015
 Page: 9



Load Case: 80 mph Wind with 0" Ice

Dead Load Factor 1.00
Wind Load Factor 1.00

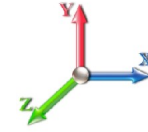

Iterations: 16

No.	Elev (ft)	Description	Qty	qz (psf)	qzGh (psf)	CaAa Factor	Total CaAa (sf)	Dead Load (lb)	Horiz Ecc (ft)	Vert Ecc (ft)	Wind FX (lb)	Mom Y (lb-ft)	Mom Z (lb-ft)
1	105.00	AIR 21, 1.3M, B4A B2P	3	23.111	39.057	0.86	16.98	271.20	0.000	5.000	663.05	0.00	3315.25
2	105.00	20' Omni	1	23.464	39.654	1.00	6.00	55.00	0.000	11.000	237.93	0.00	2617.19
3	105.00	AIR 21, 1.3M, B2A B4P	3	23.111	39.057	0.86	16.98	274.50	0.000	5.000	663.05	0.00	3315.25
4	105.00	Low Profile Platform-Round	1	22.806	38.541	1.00	22.00	1500.00	0.000	0.000	847.91	0.00	0.00
5	105.00	Ericsson S11B12	3	23.111	39.057	0.71	7.05	153.00	0.000	5.000	275.36	0.00	1376.82
6	105.00	KRY 112 144/1	3	23.111	39.057	0.67	0.82	33.00	0.000	5.000	32.19	0.00	160.93
7	105.00	LNx-6515DS	3	23.111	39.057	0.80	27.38	149.40	0.000	5.000	1069.54	0.00	5347.71
8	98.00	RRUS-11	6	22.360	37.789	0.70	12.35	264.00	0.000	0.000	466.62	0.00	0.00
9	98.00	Flush Mount	1	22.360	37.789	1.00	5.00	350.00	0.000	0.000	188.95	0.00	0.00
10	98.00	DC6-48-60-18-8F	1	22.360	37.789	1.00	1.47	31.80	0.000	0.000	55.55	0.00	0.00
11	97.00	Low Profile Platform-Round	1	22.295	37.679	1.00	22.00	1500.00	0.000	0.000	828.93	0.00	0.00
12	97.00	LGP21401	6	22.295	37.679	0.67	5.19	84.60	0.000	0.000	195.39	0.00	0.00
13	97.00	AM-X-CD-16-65-00T-RET	9	22.295	37.679	0.75	55.76	436.50	0.000	0.000	2100.77	0.00	0.00
14	97.00	860 10035	6	22.295	37.679	0.92	0.99	7.20	0.000	0.000	37.44	0.00	0.00
15	97.00	800-10121	3	22.295	37.679	0.79	12.92	132.30	0.000	0.000	486.68	0.00	0.00
16	97.00	782 10250	6	22.295	37.679	0.76	2.37	38.40	0.000	0.000	89.34	0.00	0.00
17	91.00	VHLP2.5	3	21.892	36.997	1.00	25.29	142.80	0.000	0.000	935.67	0.00	0.00
18	91.00	RRU	3	21.892	36.997	0.88	5.07	126.00	0.000	0.000	187.53	0.00	0.00
19	91.00	Horizon DUO Radios	3	21.892	36.997	0.76	1.92	34.50	0.000	0.000	70.86	0.00	0.00
20	87.00	APXVTM14-C-120	3	21.613	36.525	0.79	16.35	168.00	0.000	0.000	597.30	0.00	0.00
21	87.00	800MHz Filter	3	21.613	36.525	0.70	1.03	30.00	0.000	0.000	37.58	0.00	0.00
22	87.00	ACU-A20-N	4	21.613	36.525	0.79	0.44	4.00	0.000	0.000	16.16	0.00	0.00
23	87.00	APXVSP18-C-A20	3	21.613	36.525	0.83	20.57	171.00	0.000	0.000	751.23	0.00	0.00
24	87.00	RRUS-11 1900 MHz	3	21.613	36.525	0.70	6.17	132.00	0.000	0.000	225.51	0.00	0.00
25	87.00	Low Profile Platform-Round	1	21.613	36.525	1.00	22.00	1500.00	0.000	0.000	803.56	0.00	0.00
26	87.00	RRUS-11 800 MHz	3	21.613	36.525	0.75	6.62	162.00	0.000	0.000	241.61	0.00	0.00
27	87.00	TD-RRH8x20-25	3	21.613	36.525	0.69	9.77	210.00	0.000	0.000	356.87	0.00	0.00
28	75.00	Standoff Mount	1	20.715	35.009	1.00	0.50	50.00	0.000	0.000	17.50	0.00	0.00
29	75.00	GPS	1	20.715	35.009	1.00	1.00	10.00	0.000	0.000	35.01	0.00	0.00
Totals:							8,021.20				12,515.08		

Total Applied Force Summary

Structure: CT01498-S-SB
Site Name: Avon
Height: 105.00 (ft)
Base Elev: 0.000 (ft)

Code: EIA/TIA-222-F
Exposure: C
Gh: 1.69
Struct Class: II

7/29/2015
 Page: 10



Load Case: 80 mph Wind with 0" Ice

Dead Load Factor 1.00
Wind Load Factor 1.00

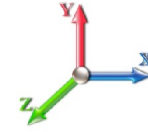

Iterations: 16

Elev (ft)	Description	Lateral FX (-) (lb)	Axial FY (-) (lb)	Torsion MY (lb-ft)	Moment MZ (lb-ft)
0.00		0.00	0.00	0.00	0.00
5.00		408.41	1365.10	0.00	0.00
10.00		408.41	1365.10	0.00	0.00
15.00		408.41	1365.10	0.00	0.00
20.00		408.41	1365.10	0.00	0.00
25.00		367.57	1244.84	0.00	0.00
30.00		367.57	1244.84	0.00	0.00
35.00		373.80	1244.84	0.00	0.00
40.00		388.34	1244.84	0.00	0.00
45.00		357.00	1124.58	0.00	0.00
50.00		367.92	1124.58	0.00	0.00
55.00		378.07	1124.58	0.00	0.00
60.00		387.59	1124.58	0.00	0.00
65.00		346.99	1004.31	0.00	0.00
70.00		354.41	1004.31	0.00	0.00
75.00	(2) appurtenances	413.98	1064.31	0.00	0.00
80.00		368.19	1004.31	0.00	0.00
85.00		321.11	884.05	0.00	0.00
87.00	(23) appurtenances	3159.12	2730.62	0.00	0.00
90.00		195.84	518.98	0.00	0.00
91.00	(9) appurtenances	1259.54	476.29	0.00	0.00
95.00		265.18	688.13	0.00	0.00
97.00	(31) appurtenances	3871.93	2543.07	0.00	0.00
98.00	(8) appurtenances	778.00	802.71	0.00	0.00
100.00		134.55	313.83	0.00	0.00
105.00	(17) appurtenances	<u>4130.12</u>	<u>3220.67</u>	<u>0.00</u>	<u>16133.15</u>
	Totals:	20,220.47	31,193.68	0.00	16,133.15

Resulting Forces and Deflections

Structure: CT01498-S-SB
Site Name: Avon
Height: 105.00 (ft)
Base Elev: 0.000 (ft)

Code: EIA/TIA-222-F
Exposure: C
Gh: 1.69
Struct Class: II

7/29/2015
 Page: 11



Load Case: 80 mph Wind with 0" Ice

Dead Load Factor 1.00
Wind Load Factor 1.00

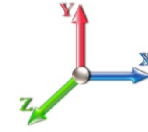

Iterations: 16

Elev (ft)	Lateral FX (-) (kips)	Axial FY (-) (kips)	Lateral FZ (kips)	Moment MX (ft-kips)	Torsion MY (ft-kips)	Moment MZ (ft-kips)	Deflect X (in)	Deflect Z (in)	Deflect Resultant (in)	Rotation Sway (deg)	Rotation Twist (deg)
0.00	-20.241	-31.180	0.000	0.000	0.000	-1646.4	0.000	0.000	0.000	0.000	0.000
5.00	-19.868	-29.791	0.000	0.000	0.000	-1545.2	-0.040	0.000	0.040	-0.073	0.000
10.00	-19.490	-28.404	0.000	0.000	0.000	-1445.9	-0.153	0.000	0.153	-0.141	0.000
15.00	-19.106	-27.020	0.000	0.000	0.000	-1348.4	-0.335	0.000	0.335	-0.204	0.000
20.00	-18.718	-25.638	0.000	0.000	0.000	-1252.9	-0.582	0.000	0.582	-0.264	0.000
25.00	-18.370	-24.375	0.000	0.000	0.000	-1159.3	-0.888	0.000	0.888	-0.319	0.000
30.00	-18.022	-23.112	0.000	0.000	0.000	-1067.4	-1.260	0.000	1.260	-0.388	0.000
35.00	-17.662	-21.851	0.000	0.000	0.000	-977.38	-1.702	0.000	1.702	-0.452	0.000
40.00	-17.283	-20.592	0.000	0.000	0.000	-889.07	-2.207	0.000	2.207	-0.511	0.000
45.00	-16.937	-19.453	0.000	0.000	0.000	-802.65	-2.771	0.000	2.771	-0.564	0.000
50.00	-16.577	-18.314	0.000	0.000	0.000	-717.97	-3.399	0.000	3.399	-0.632	0.000
55.00	-16.203	-17.178	0.000	0.000	0.000	-635.08	-4.094	0.000	4.094	-0.692	0.000
60.00	-15.816	-16.045	0.000	0.000	0.000	-554.07	-4.848	0.000	4.848	-0.745	0.000
65.00	-15.469	-15.031	0.000	0.000	0.000	-474.99	-5.654	0.000	5.654	-0.791	0.000
70.00	-15.113	-14.018	0.000	0.000	0.000	-397.65	-6.515	0.000	6.515	-0.849	0.000
75.00	-14.693	-12.949	0.000	0.000	0.000	-322.08	-7.432	0.000	7.432	-0.898	0.000
80.00	-14.316	-11.942	0.000	0.000	0.000	-248.62	-8.394	0.000	8.394	-0.936	0.000
85.00	-13.984	-11.058	0.000	0.000	0.000	-177.04	-9.391	0.000	9.391	-0.964	0.000
87.00	-10.781	-8.379	0.000	0.000	0.000	-149.07	-9.799	0.000	9.799	-0.978	0.000
90.00	-10.578	-7.862	0.000	0.000	0.000	-116.73	-10.420	0.000	10.420	-0.995	0.000
91.00	-9.311	-7.406	0.000	0.000	0.000	-106.15	-10.629	0.000	10.629	-1.000	0.000
95.00	-9.035	-6.721	0.000	0.000	0.000	-68.913	-11.474	0.000	11.474	-1.015	0.000
97.00	-5.119	-4.247	0.000	0.000	0.000	-50.843	-11.901	0.000	11.901	-1.020	0.000
98.00	-4.327	-3.458	0.000	0.000	0.000	-45.724	-12.114	0.000	12.114	-1.022	0.000
100.00	-4.187	-3.146	0.000	0.000	0.000	-37.069	-12.544	0.000	12.544	-1.026	0.000
105.00	-4.130	0.000	0.000	0.000	0.000	-16.133	0.000	0.000	13.621	-1.031	0.000

Resulting Stresses

Structure: CT01498-S-SBA
Site Name: Avon
Height: 105.00 (ft)
Base Elev: 0.000 (ft)

Code: EIA/TIA-222-F
Exposure: C
Gh: 1.69
Struct Class: II

7/29/2015
 Page: 12



Load Case: 80 mph Wind with 0" Ice

Dead Load Factor 1.00
Wind Load Factor 1.00

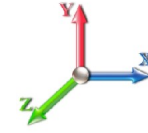

Iterations: 16

Applied Stresses

Elev (ft)	fa Axial (Y) (ksi)	fvx Shear (X) (ksi)	fvz Shear (Z) (ksi)	fvT Torsion (ksi)	fbx Bending (X) (ksi)	fbz Bending (Z) (ksi)	fb Combined (ksi)	Allow Stress (ksi)	Fa Allow Stress (ksi)	f/Fb Stress Ratio
0.00	0.44	0.58	0.00	0.00	0.00	18.97	19.44	32.5	29.9	0.598
5.00	0.42	0.57	0.00	0.00	0.00	17.81	18.26	32.5	29.9	0.561
10.00	0.40	0.56	0.00	0.00	0.00	16.66	17.09	32.5	29.9	0.526
15.00	0.38	0.54	0.00	0.00	0.00	15.54	15.95	32.5	29.9	0.491
20.00	0.36	0.53	0.00	0.00	0.00	14.44	14.83	32.5	29.9	0.456
20.00	0.36	0.53	0.00	0.00	0.00	14.44	14.83	32.5	29.9	0.563
25.00	0.39	0.58	0.00	0.00	0.00	16.53	16.94	33.5	30.5	0.506
30.00	0.37	0.57	0.00	0.00	0.00	15.22	15.62	33.5	30.5	0.466
35.00	0.35	0.56	0.00	0.00	0.00	13.93	14.31	33.5	30.5	0.427
40.00	0.33	0.55	0.00	0.00	0.00	12.68	13.04	33.5	30.5	0.389
40.00	0.33	0.55	0.00	0.00	0.00	12.68	13.04	33.5	30.5	0.492
45.00	0.35	0.60	0.00	0.00	0.00	14.52	14.90	33.6	31.1	0.444
50.00	0.33	0.59	0.00	0.00	0.00	12.99	13.35	33.6	31.1	0.397
55.00	0.31	0.58	0.00	0.00	0.00	11.49	11.84	33.6	31.1	0.352
60.00	0.29	0.56	0.00	0.00	0.00	10.02	10.36	33.6	31.1	0.308
60.00	0.29	0.56	0.00	0.00	0.00	10.02	10.36	33.6	31.1	0.402
65.00	0.31	0.63	0.00	0.00	0.00	11.26	11.62	33.6	32.0	0.346
70.00	0.29	0.62	0.00	0.00	0.00	9.43	9.77	33.6	32.0	0.291
75.00	0.26	0.60	0.00	0.00	0.00	7.64	7.97	33.6	32.0	0.237
80.00	0.24	0.58	0.00	0.00	0.00	5.89	6.22	33.6	32.0	0.185
80.00	0.24	0.58	0.00	0.00	0.00	5.89	6.22	33.6	32.0	0.251
85.00	0.26	0.67	0.00	0.00	0.00	5.74	6.11	33.6	33.1	0.182
87.00	0.20	0.51	0.00	0.00	0.00	4.83	5.11	33.6	33.1	0.152
90.00	0.19	0.50	0.00	0.00	0.00	3.78	4.07	33.6	33.1	0.121
91.00	0.18	0.44	0.00	0.00	0.00	3.44	3.70	33.6	33.1	0.110
95.00	0.16	0.43	0.00	0.00	0.00	2.23	2.51	33.6	33.1	0.075
97.00	0.10	0.24	0.00	0.00	0.00	1.65	1.80	33.6	33.1	0.054
98.00	0.08	0.21	0.00	0.00	0.00	1.48	1.60	33.6	33.1	0.048
100.00	0.07	0.20	0.00	0.00	0.00	1.20	1.32	33.6	33.1	0.039
105.00	0.00	0.20	0.00	0.00	0.00	0.52	0.62	33.6	33.1	0.019

Wind Loading - Shaft

Structure: CT01498-S-SBA
Site Name: Avon
Height: 105.00 (ft)
Base Elev: 0.000 (ft)

Code: EIA/TIA-222-F
Exposure: C
Gh: 1.69
Struct Class: II

7/29/2015
 Page: 13



Load Case: 69.28 mph Wind with 0.5" Ice

Dead Load Factor 1.00
Wind Load Factor 1.00



Iterations: 16

Elev (ft)	Description	Kzt	Kz	qz (psf)	qzGh (psf)	C (mph-ft)	Cf	Ice Thick (in)	Tributary (ft)	Aa (sf)	CfAa (sf)	Wind Force X (lb)	Dead Load Ice (lb)	Tot Dead Load (lb)
0.00		0.00	1.00	12.287	20.77	346.40	0.590	0.500	0.00	0.000	0.00	0.0	0.0	0.0
5.00		0.00	1.00	12.287	20.77	346.40	0.590	0.500	5.00	25.417	15.00	311.4	184.8	1379.9
10.00		0.00	1.00	12.287	20.77	346.40	0.590	0.500	5.00	25.417	15.00	311.4	184.8	1379.9
15.00		0.00	1.00	12.287	20.77	346.40	0.590	0.500	5.00	25.417	15.00	311.4	184.8	1379.9
20.00	Top - Section 1	0.00	1.00	12.287	20.77	346.40	0.590	0.500	5.00	25.417	15.00	311.4	184.8	1379.9
25.00		0.00	1.00	12.287	20.77	311.76	0.590	0.500	5.00	22.917	13.52	280.8	166.5	1241.3
30.00		0.00	1.00	12.287	20.77	311.76	0.590	0.500	5.00	22.917	13.52	280.8	166.5	1241.3
35.00		0.00	1.02	12.496	21.12	314.39	0.590	0.500	5.00	22.917	13.52	285.5	166.5	1241.3
40.00	Top - Section 2	0.00	1.06	12.982	21.94	320.45	0.590	0.500	5.00	22.917	13.52	296.6	166.5	1241.3
45.00		0.00	1.09	13.426	22.69	289.67	0.590	0.500	5.00	20.417	12.05	273.3	148.1	1102.7
50.00		0.00	1.13	13.836	23.38	294.07	0.590	0.500	5.00	20.417	12.05	281.7	148.1	1102.7
55.00		0.00	1.16	14.218	24.03	298.10	0.590	0.500	5.00	20.417	12.05	289.4	148.1	1102.7
60.00	Top - Section 3	0.00	1.19	14.576	24.63	301.83	0.590	0.500	5.00	20.417	12.05	296.7	148.1	1102.7
65.00		0.00	1.21	14.913	25.20	267.14	0.590	0.500	5.00	17.917	10.57	266.4	129.8	964.1
70.00		0.00	1.24	15.232	25.74	269.98	0.590	0.500	5.00	17.917	10.57	272.1	129.8	964.1
75.00	Appurtenance(s)	0.00	1.26	15.536	26.26	272.65	0.590	0.500	5.00	17.917	10.57	277.5	129.8	964.1
80.00	Top - Section 4	0.00	1.29	15.825	26.74	275.18	0.590	0.500	5.00	17.917	10.57	282.7	129.8	964.1
85.00		0.00	1.31	16.101	27.21	237.92	0.590	0.500	5.00	15.417	9.10	247.5	111.5	825.6
87.00	Appurtenance(s)	0.00	1.32	16.209	27.39	238.71	0.590	0.500	2.00	6.167	3.64	99.7	44.6	330.2
90.00		0.00	1.33	16.366	27.66	239.87	0.590	0.500	3.00	9.250	5.46	150.9	66.9	495.3
91.00	Appurtenance(s)	0.00	1.34	16.418	27.75	240.25	0.590	0.500	1.00	3.083	1.82	50.5	22.3	165.1
95.00		0.00	1.35	16.621	28.09	241.73	0.590	0.500	4.00	12.333	7.28	204.4	89.2	660.4
97.00	Appurtenance(s)	0.00	1.36	16.720	28.26	242.45	0.590	0.500	2.00	6.167	3.64	102.8	44.6	330.2
98.00	Appurtenance(s)	0.00	1.36	16.769	28.34	242.81	0.590	0.500	1.00	3.083	1.82	51.6	22.3	165.1
100.00		0.00	1.37	16.866	28.50	243.51	0.590	0.500	2.00	6.167	3.64	103.7	44.6	330.2
105.00	Appurtenance(s)	0.00	1.39	17.103	28.90	245.21	0.590	0.500	5.00	15.417	9.10	262.9	111.5	825.6
Totals:									105.00			5,903.2		22,880.2

Discrete Appurtenance Forces

Structure: CT01498-S-SB
Site Name: Avon
Height: 105.00 (ft)
Base Elev: 0.000 (ft)

Code: EIA/TIA-222-F
Exposure: C
Gh: 1.69
Struct Class: II

7/29/2015
 Page: 14



Load Case: 69.28 mph Wind with 0.5" Ice

Dead Load Factor 1.00
Wind Load Factor 1.00

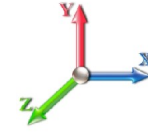

Iterations: 16

No.	Elev (ft)	Description	Qty	qz (psf)	qzGh (psf)	CaAa Factor	Total CaAa (sf)	Dead Load (lb)	Horiz Ecc (ft)	Vert Ecc (ft)	Wind FX (lb)	Mom Y (lb-ft)	Mom Z (lb-ft)
1	105.00	AIR 21, 1.3M, B4A B2P	3	17.332	29.291	0.86	17.98	384.30	0.000	5.000	526.73	0.00	2633.65
2	105.00	20' Omni	1	17.597	29.739	1.00	8.03	98.10	0.000	11.000	238.80	0.00	2626.85
3	105.00	AIR 21, 1.3M, B2A B4P	3	17.332	29.291	0.86	17.98	387.60	0.000	5.000	526.73	0.00	2633.65
4	105.00	Low Profile Platform-Round	1	17.103	28.904	1.00	27.00	1800.00	0.000	0.000	780.42	0.00	0.00
5	105.00	Ericsson S11B12	3	17.332	29.291	0.72	7.60	201.30	0.000	5.000	222.71	0.00	1113.53
6	105.00	KRY 112 144/1	3	17.332	29.291	0.67	1.11	42.30	0.000	5.000	32.38	0.00	161.91
7	105.00	LNx-6515DS	3	17.332	29.291	0.80	29.62	346.80	0.000	5.000	867.49	0.00	4337.43
8	98.00	RRUS-11	6	16.769	28.340	0.70	13.82	379.80	0.000	0.000	391.60	0.00	0.00
9	98.00	Flush Mount	1	16.769	28.340	1.00	6.00	450.00	0.000	0.000	170.04	0.00	0.00
10	98.00	DC6-48-60-18-8F	1	16.769	28.340	1.00	1.67	49.50	0.000	0.000	47.33	0.00	0.00
11	97.00	Low Profile Platform-Round	1	16.720	28.257	1.00	27.00	1800.00	0.000	0.000	762.95	0.00	0.00
12	97.00	LGP21401	6	16.720	28.257	0.67	6.15	127.20	0.000	0.000	173.80	0.00	0.00
13	97.00	AM-X-CD-16-65-00T-RET	9	16.720	28.257	0.75	61.29	855.00	0.000	0.000	1731.89	0.00	0.00
14	97.00	860 10035	6	16.720	28.257	0.92	1.55	16.80	0.000	0.000	43.67	0.00	0.00
15	97.00	800-10121	3	16.720	28.257	0.79	14.43	231.00	0.000	0.000	407.85	0.00	0.00
16	97.00	782 10250	6	16.720	28.257	0.76	3.15	60.00	0.000	0.000	88.91	0.00	0.00
17	91.00	VHLP2.5	3	16.418	27.746	1.00	26.76	291.00	0.000	0.000	742.49	0.00	0.00
18	91.00	RRU	3	16.418	27.746	0.88	5.83	173.10	0.000	0.000	161.88	0.00	0.00
19	91.00	Horizon DUO Radios	3	16.418	27.746	0.76	2.35	53.70	0.000	0.000	65.16	0.00	0.00
20	87.00	APXVTM14-C-120	3	16.209	27.392	0.79	17.28	275.70	0.000	0.000	473.27	0.00	0.00
21	87.00	800MHz Filter	3	16.209	27.392	0.70	1.36	43.80	0.000	0.000	37.39	0.00	0.00
22	87.00	ACU-A20-N	4	16.209	27.392	0.79	0.70	9.20	0.000	0.000	19.04	0.00	0.00
23	87.00	APXVSP18-C-A20	3	16.209	27.392	0.83	22.61	319.50	0.000	0.000	619.32	0.00	0.00
24	87.00	RRUS-11 1900 MHz	3	16.209	27.392	0.70	6.91	189.90	0.000	0.000	189.25	0.00	0.00
25	87.00	Low Profile Platform-Round	1	16.209	27.392	1.00	27.00	1800.00	0.000	0.000	739.59	0.00	0.00
26	87.00	RRUS-11 800 MHz	3	16.209	27.392	0.75	7.40	226.80	0.000	0.000	202.77	0.00	0.00
27	87.00	TD-RRH8x20-25	3	16.209	27.392	0.69	10.29	276.00	0.000	0.000	281.81	0.00	0.00
28	75.00	Standoff Mount	1	15.536	26.255	1.00	0.70	60.00	0.000	0.000	18.38	0.00	0.00
29	75.00	GPS	1	15.536	26.255	1.00	1.25	18.00	0.000	0.000	32.82	0.00	0.00
Totals:							10,966.40				10,596.48		

Total Applied Force Summary

Structure: CT01498-S-SB
Site Name: Avon
Height: 105.00 (ft)
Base Elev: 0.000 (ft)

Code: EIA/TIA-222-F
Exposure: C
Gh: 1.69
Struct Class: II

7/29/2015
 Page: 15



Load Case: 69.28 mph Wind with 0.5" Ice

Dead Load Factor 1.00
Wind Load Factor 1.00

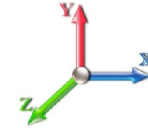

Iterations: 16

Elev (ft)	Description	Lateral FX (-) (lb)	Axial FY (-) (lb)	Torsion MY (lb-ft)	Moment MZ (lb-ft)
0.00		0.00	0.00	0.00	0.00
5.00		311.40	1549.89	0.00	0.00
10.00		311.40	1549.89	0.00	0.00
15.00		311.40	1549.89	0.00	0.00
20.00		311.40	1549.89	0.00	0.00
25.00		280.77	1411.30	0.00	0.00
30.00		280.77	1411.30	0.00	0.00
35.00		285.53	1411.30	0.00	0.00
40.00		296.63	1411.30	0.00	0.00
45.00		273.32	1272.71	0.00	0.00
50.00		281.67	1272.71	0.00	0.00
55.00		289.44	1272.71	0.00	0.00
60.00		296.73	1272.71	0.00	0.00
65.00		266.42	1134.12	0.00	0.00
70.00		272.12	1134.12	0.00	0.00
75.00	(2) appurtenances	328.74	1212.12	0.00	0.00
80.00		282.70	1134.12	0.00	0.00
85.00		247.51	995.53	0.00	0.00
87.00	(23) appurtenances	2662.11	3539.11	0.00	0.00
90.00		150.95	585.87	0.00	0.00
91.00	(9) appurtenances	1020.01	713.09	0.00	0.00
95.00		204.40	777.32	0.00	0.00
97.00	(31) appurtenances	3311.87	3478.66	0.00	0.00
98.00	(8) appurtenances	660.53	1058.51	0.00	0.00
100.00		103.71	358.42	0.00	0.00
105.00	(17) appurtenances	<u>3458.17</u>	<u>4156.45</u>	<u>0.00</u>	<u>13507.03</u>
	Totals:	16,499.67	37,213.06	0.00	13,507.03

Resulting Forces and Deflections

Structure: CT01498-S-SB
Site Name: Avon
Height: 105.00 (ft)
Base Elev: 0.000 (ft)

Code: EIA/TIA-222-F
Exposure: C
Gh: 1.69
Struct Class: II

7/29/2015
 Page: 16



Load Case: 69.28 mph Wind with 0.5" Ice

Dead Load Factor 1.00
Wind Load Factor 1.00

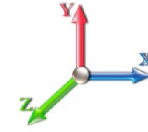

Iterations: 16

Elev (ft)	Lateral FX (-) (kips)	Axial FY (-) (kips)	Lateral FZ (kips)	Moment MX (ft-kips)	Torsion MY (ft-kips)	Moment MZ (ft-kips)	Deflect X (in)	Deflect Z (in)	Deflect Resultant (in)	Rotation Sway (deg)	Rotation Twist (deg)
0.00	-16.520	-37.204	0.000	0.000	0.000	-1364.8	0.000	0.000	0.000	0.000	0.000
5.00	-16.244	-35.638	0.000	0.000	0.000	-1282.2	-0.033	0.000	0.033	-0.060	0.000
10.00	-15.962	-34.073	0.000	0.000	0.000	-1201.0	-0.127	0.000	0.127	-0.117	0.000
15.00	-15.676	-32.510	0.000	0.000	0.000	-1121.2	-0.278	0.000	0.278	-0.170	0.000
20.00	-15.385	-30.949	0.000	0.000	0.000	-1042.8	-0.483	0.000	0.483	-0.219	0.000
25.00	-15.125	-29.525	0.000	0.000	0.000	-965.94	-0.737	0.000	0.737	-0.265	0.000
30.00	-14.865	-28.100	0.000	0.000	0.000	-890.32	-1.046	0.000	1.046	-0.323	0.000
35.00	-14.594	-26.678	0.000	0.000	0.000	-816.00	-1.414	0.000	1.414	-0.376	0.000
40.00	-14.308	-25.257	0.000	0.000	0.000	-743.03	-1.834	0.000	1.834	-0.425	0.000
45.00	-14.046	-23.974	0.000	0.000	0.000	-671.49	-2.304	0.000	2.304	-0.469	0.000
50.00	-13.775	-22.691	0.000	0.000	0.000	-601.26	-2.827	0.000	2.827	-0.526	0.000
55.00	-13.491	-21.410	0.000	0.000	0.000	-532.38	-3.406	0.000	3.406	-0.577	0.000
60.00	-13.195	-20.131	0.000	0.000	0.000	-464.93	-4.035	0.000	4.035	-0.621	0.000
65.00	-12.931	-18.990	0.000	0.000	0.000	-398.96	-4.707	0.000	4.707	-0.660	0.000
70.00	-12.659	-17.849	0.000	0.000	0.000	-334.30	-5.425	0.000	5.425	-0.709	0.000
75.00	-12.326	-16.634	0.000	0.000	0.000	-271.01	-6.191	0.000	6.191	-0.749	0.000
80.00	-12.035	-15.497	0.000	0.000	0.000	-209.38	-6.994	0.000	6.994	-0.782	0.000
85.00	-11.778	-14.502	0.000	0.000	0.000	-149.20	-7.827	0.000	7.827	-0.806	0.000
87.00	-9.069	-10.999	0.000	0.000	0.000	-125.65	-8.168	0.000	8.168	-0.817	0.000
90.00	-8.911	-10.414	0.000	0.000	0.000	-98.446	-8.686	0.000	8.686	-0.832	0.000
91.00	-7.882	-9.714	0.000	0.000	0.000	-89.535	-8.861	0.000	8.861	-0.836	0.000
95.00	-7.668	-8.939	0.000	0.000	0.000	-58.006	-9.568	0.000	9.568	-0.848	0.000
97.00	-4.305	-5.510	0.000	0.000	0.000	-42.670	-9.924	0.000	9.924	-0.853	0.000
98.00	-3.629	-4.461	0.000	0.000	0.000	-38.365	-10.103	0.000	10.103	-0.854	0.000
100.00	-3.520	-4.104	0.000	0.000	0.000	-31.108	-10.462	0.000	10.462	-0.857	0.000
105.00	-3.458	0.000	0.000	0.000	0.000	-13.507	0.000	0.000	11.363	-0.862	0.000

Resulting Stresses

Structure: CT01498-S-SBA
Site Name: Avon
Height: 105.00 (ft)
Base Elev: 0.000 (ft)

Code: EIA/TIA-222-F
Exposure: C
Gh: 1.69
Struct Class: II

7/29/2015
 Page: 17



Load Case: 69.28 mph Wind with 0.5" Ice

Dead Load Factor 1.00
Wind Load Factor 1.00

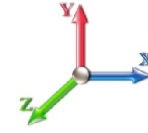

Iterations: 16

Applied Stresses

Elev (ft)	fa Axial (Y) (ksi)	fvx Shear (X) (ksi)	fvz Shear (Z) (ksi)	fvT Torsion (ksi)	fbx Bending (X) (ksi)	fbz Bending (Z) (ksi)	fb Combined (ksi)	Allow Stress (ksi)	Fa Allow Stress (ksi)	f/Fb Stress Ratio
0.00	0.53	0.47	0.00	0.00	0.00	15.73	16.28	32.5	29.9	0.501
5.00	0.51	0.46	0.00	0.00	0.00	14.78	15.30	32.5	29.9	0.471
10.00	0.49	0.45	0.00	0.00	0.00	13.84	14.35	32.5	29.9	0.441
15.00	0.46	0.45	0.00	0.00	0.00	12.92	13.41	32.5	29.9	0.412
20.00	0.44	0.44	0.00	0.00	0.00	12.02	12.48	32.5	29.9	0.384
20.00	0.44	0.44	0.00	0.00	0.00	12.02	12.48	32.5	29.9	0.473
25.00	0.47	0.48	0.00	0.00	0.00	13.77	14.26	33.5	30.5	0.426
30.00	0.44	0.47	0.00	0.00	0.00	12.69	13.16	33.5	30.5	0.393
35.00	0.42	0.46	0.00	0.00	0.00	11.63	12.08	33.5	30.5	0.360
40.00	0.40	0.45	0.00	0.00	0.00	10.59	11.02	33.5	30.5	0.329
40.00	0.40	0.45	0.00	0.00	0.00	10.59	11.02	33.5	30.5	0.415
45.00	0.43	0.50	0.00	0.00	0.00	12.15	12.61	33.6	31.1	0.375
50.00	0.40	0.49	0.00	0.00	0.00	10.88	11.31	33.6	31.1	0.337
55.00	0.38	0.48	0.00	0.00	0.00	9.63	10.05	33.6	31.1	0.299
60.00	0.36	0.47	0.00	0.00	0.00	8.41	8.81	33.6	31.1	0.262
60.00	0.36	0.47	0.00	0.00	0.00	8.41	8.81	33.6	31.1	0.341
65.00	0.39	0.53	0.00	0.00	0.00	9.46	9.89	33.6	32.0	0.294
70.00	0.36	0.52	0.00	0.00	0.00	7.93	8.34	33.6	32.0	0.248
75.00	0.34	0.50	0.00	0.00	0.00	6.43	6.82	33.6	32.0	0.203
80.00	0.32	0.49	0.00	0.00	0.00	4.96	5.35	33.6	32.0	0.159
80.00	0.32	0.49	0.00	0.00	0.00	4.96	5.35	33.6	32.0	0.215
85.00	0.35	0.56	0.00	0.00	0.00	4.84	5.27	33.6	33.1	0.157
87.00	0.26	0.43	0.00	0.00	0.00	4.07	4.40	33.6	33.1	0.131
90.00	0.25	0.42	0.00	0.00	0.00	3.19	3.52	33.6	33.1	0.105
91.00	0.23	0.38	0.00	0.00	0.00	2.90	3.20	33.6	33.1	0.095
95.00	0.21	0.37	0.00	0.00	0.00	1.88	2.19	33.6	33.1	0.065
97.00	0.13	0.21	0.00	0.00	0.00	1.38	1.56	33.6	33.1	0.046
98.00	0.11	0.17	0.00	0.00	0.00	1.24	1.38	33.6	33.1	0.041
100.00	0.10	0.17	0.00	0.00	0.00	1.01	1.14	33.6	33.1	0.034
105.00	0.00	0.16	0.00	0.00	0.00	0.44	0.52	33.6	33.1	0.016

Wind Loading - Shaft

Structure: CT01498-S-SBA
Site Name: Avon
Height: 105.00 (ft)
Base Elev: 0.000 (ft)

Code: EIA/TIA-222-F
Exposure: C
Gh: 1.69
Struct Class: II

7/29/2015
 Page: 18



Load Case: 50 mph Wind with 0" Ice

Dead Load Factor 1.00
Wind Load Factor 1.00



Iterations: 15

Elev (ft)	Description	Kzt	Kz	qz (psf)	qzGh (psf)	C (mph-ft)	Cf	Ice Thick (in)	Tributary (ft)	Aa (sf)	CfAa (sf)	Wind Force X (lb)	Dead Load Ice (lb)	Tot Dead Load (lb)
0.00		0.00	1.00	6.400	10.82	250.00	0.590	0.000	0.00	0.000	0.00	0.0	0.0	0.0
5.00		0.00	1.00	6.400	10.82	250.00	0.590	0.000	5.00	25.000	14.75	159.5	0.0	1195.1
10.00		0.00	1.00	6.400	10.82	250.00	0.590	0.000	5.00	25.000	14.75	159.5	0.0	1195.1
15.00		0.00	1.00	6.400	10.82	250.00	0.590	0.000	5.00	25.000	14.75	159.5	0.0	1195.1
20.00	Top - Section 1	0.00	1.00	6.400	10.82	250.00	0.590	0.000	5.00	25.000	14.75	159.5	0.0	1195.1
25.00		0.00	1.00	6.400	10.82	225.00	0.590	0.000	5.00	22.500	13.27	143.6	0.0	1074.9
30.00		0.00	1.00	6.400	10.82	225.00	0.590	0.000	5.00	22.500	13.27	143.6	0.0	1074.9
35.00		0.00	1.02	6.509	11.00	226.90	0.590	0.000	5.00	22.500	13.27	146.0	0.0	1074.9
40.00	Top - Section 2	0.00	1.06	6.762	11.43	231.27	0.590	0.000	5.00	22.500	13.27	151.7	0.0	1074.9
45.00		0.00	1.09	6.993	11.82	209.06	0.590	0.000	5.00	20.000	11.80	139.5	0.0	954.6
50.00		0.00	1.13	7.207	12.18	212.23	0.590	0.000	5.00	20.000	11.80	143.7	0.0	954.6
55.00		0.00	1.16	7.406	12.52	215.14	0.590	0.000	5.00	20.000	11.80	147.7	0.0	954.6
60.00	Top - Section 3	0.00	1.19	7.592	12.83	217.83	0.590	0.000	5.00	20.000	11.80	151.4	0.0	954.6
65.00		0.00	1.21	7.768	13.13	192.79	0.590	0.000	5.00	17.500	10.32	135.5	0.0	834.3
70.00		0.00	1.24	7.934	13.41	194.85	0.590	0.000	5.00	17.500	10.32	138.4	0.0	834.3
75.00	Appurtenance(s)	0.00	1.26	8.092	13.68	196.78	0.590	0.000	5.00	17.500	10.32	141.2	0.0	834.3
80.00	Top - Section 4	0.00	1.29	8.242	13.93	198.60	0.590	0.000	5.00	17.500	10.32	143.8	0.0	834.3
85.00		0.00	1.31	8.387	14.17	171.71	0.590	0.000	5.00	15.000	8.85	125.4	0.0	714.1
87.00	Appurtenance(s)	0.00	1.32	8.442	14.27	172.28	0.590	0.000	2.00	6.000	3.54	50.5	0.0	285.6
90.00		0.00	1.33	8.525	14.41	173.12	0.590	0.000	3.00	9.000	5.31	76.5	0.0	428.4
91.00	Appurtenance(s)	0.00	1.34	8.552	14.45	173.39	0.590	0.000	1.00	3.000	1.77	25.6	0.0	142.8
95.00		0.00	1.35	8.657	14.63	174.46	0.590	0.000	4.00	12.000	7.08	103.6	0.0	571.3
97.00	Appurtenance(s)	0.00	1.36	8.709	14.72	174.98	0.590	0.000	2.00	6.000	3.54	52.1	0.0	285.6
98.00	Appurtenance(s)	0.00	1.36	8.735	14.76	175.24	0.590	0.000	1.00	3.000	1.77	26.1	0.0	142.8
100.00		0.00	1.37	8.785	14.85	175.74	0.590	0.000	2.00	6.000	3.54	52.6	0.0	285.6
105.00	Appurtenance(s)	0.00	1.39	8.908	15.06	176.97	0.590	0.000	5.00	15.000	8.85	133.2	0.0	714.1
Totals:									105.00			3,009.9		19,806.0

Discrete Appurtenance Forces

Structure: CT01498-S-SB
Site Name: Avon
Height: 105.00 (ft)
Base Elev: 0.000 (ft)

Code: EIA/TIA-222-F
Exposure: C
Gh: 1.69
Struct Class: II

7/29/2015
 Page: 19



Load Case: 50 mph Wind with 0" Ice

Dead Load Factor 1.00
Wind Load Factor 1.00

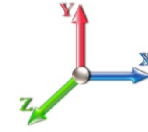

Iterations: 15

No.	Elev (ft)	Description	Qty	qz (psf)	qzGh (psf)	CaAa Factor	Total CaAa (sf)	Dead Load (lb)	Horiz Ecc (ft)	Vert Ecc (ft)	Wind FX (lb)	Mom Y (lb-ft)	Mom Z (lb-ft)
1	105.00	AIR 21, 1.3M, B4A B2P	3	9.028	15.257	0.86	16.98	271.20	0.000	5.000	259.00	0.00	1295.02
2	105.00	20' Omni	1	9.166	15.490	1.00	6.00	55.00	0.000	11.000	92.94	0.00	1022.34
3	105.00	AIR 21, 1.3M, B2A B4P	3	9.028	15.257	0.86	16.98	274.50	0.000	5.000	259.00	0.00	1295.02
4	105.00	Low Profile Platform-Round	1	8.908	15.055	1.00	22.00	1500.00	0.000	0.000	331.22	0.00	0.00
5	105.00	Ericsson S11B12	3	9.028	15.257	0.71	7.05	153.00	0.000	5.000	107.56	0.00	537.82
6	105.00	KRY 112 144/1	3	9.028	15.257	0.67	0.82	33.00	0.000	5.000	12.57	0.00	62.87
7	105.00	LNx-6515DS	3	9.028	15.257	0.80	27.38	149.40	0.000	5.000	417.79	0.00	2088.95
8	98.00	RRUS-11	6	8.735	14.761	0.70	12.35	264.00	0.000	0.000	182.27	0.00	0.00
9	98.00	Flush Mount	1	8.735	14.761	1.00	5.00	350.00	0.000	0.000	73.81	0.00	0.00
10	98.00	DC6-48-60-18-8F	1	8.735	14.761	1.00	1.47	31.80	0.000	0.000	21.70	0.00	0.00
11	97.00	Low Profile Platform-Round	1	8.709	14.718	1.00	22.00	1500.00	0.000	0.000	323.80	0.00	0.00
12	97.00	LGP21401	6	8.709	14.718	0.67	5.19	84.60	0.000	0.000	76.33	0.00	0.00
13	97.00	AM-X-CD-16-65-00T-RET	9	8.709	14.718	0.75	55.76	436.50	0.000	0.000	820.61	0.00	0.00
14	97.00	860 10035	6	8.709	14.718	0.92	0.99	7.20	0.000	0.000	14.62	0.00	0.00
15	97.00	800-10121	3	8.709	14.718	0.79	12.92	132.30	0.000	0.000	190.11	0.00	0.00
16	97.00	782 10250	6	8.709	14.718	0.76	2.37	38.40	0.000	0.000	34.90	0.00	0.00
17	91.00	VHLP2.5	3	8.552	14.452	1.00	25.29	142.80	0.000	0.000	365.49	0.00	0.00
18	91.00	RRU	3	8.552	14.452	0.88	5.07	126.00	0.000	0.000	73.25	0.00	0.00
19	91.00	Horizon DUO Radios	3	8.552	14.452	0.76	1.92	34.50	0.000	0.000	27.68	0.00	0.00
20	87.00	APXVTM14-C-120	3	8.442	14.268	0.79	16.35	168.00	0.000	0.000	233.32	0.00	0.00
21	87.00	800MHz Filter	3	8.442	14.268	0.70	1.03	30.00	0.000	0.000	14.68	0.00	0.00
22	87.00	ACU-A20-N	4	8.442	14.268	0.79	0.44	4.00	0.000	0.000	6.31	0.00	0.00
23	87.00	APXVSP18-C-A20	3	8.442	14.268	0.83	20.57	171.00	0.000	0.000	293.45	0.00	0.00
24	87.00	RRUS-11 1900 MHz	3	8.442	14.268	0.70	6.17	132.00	0.000	0.000	88.09	0.00	0.00
25	87.00	Low Profile Platform-Round	1	8.442	14.268	1.00	22.00	1500.00	0.000	0.000	313.89	0.00	0.00
26	87.00	RRUS-11 800 MHz	3	8.442	14.268	0.75	6.62	162.00	0.000	0.000	94.38	0.00	0.00
27	87.00	TD-RRH8x20-25	3	8.442	14.268	0.69	9.77	210.00	0.000	0.000	139.40	0.00	0.00
28	75.00	Standoff Mount	1	8.092	13.675	1.00	0.50	50.00	0.000	0.000	6.84	0.00	0.00
29	75.00	GPS	1	8.092	13.675	1.00	1.00	10.00	0.000	0.000	13.68	0.00	0.00
Totals:								8,021.20			4,888.70		

Total Applied Force Summary

Structure: CT01498-S-SB
Site Name: Avon
Height: 105.00 (ft)
Base Elev: 0.000 (ft)

Code: EIA/TIA-222-F
Exposure: C
Gh: 1.69
Struct Class: II

7/29/2015
 Page: 20



Load Case: 50 mph Wind with 0" Ice

Dead Load Factor 1.00
Wind Load Factor 1.00

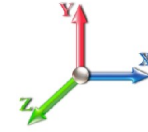

Iterations: 15

Elev (ft)	Description	Lateral FX (-) (lb)	Axial FY (-) (lb)	Torsion MY (lb-ft)	Moment MZ (lb-ft)
0.00		0.00	0.00	0.00	0.00
5.00		159.54	1365.10	0.00	0.00
10.00		159.54	1365.10	0.00	0.00
15.00		159.54	1365.10	0.00	0.00
20.00		159.54	1365.10	0.00	0.00
25.00		143.58	1244.84	0.00	0.00
30.00		143.58	1244.84	0.00	0.00
35.00		146.02	1244.84	0.00	0.00
40.00		151.70	1244.84	0.00	0.00
45.00		139.45	1124.58	0.00	0.00
50.00		143.72	1124.58	0.00	0.00
55.00		147.68	1124.58	0.00	0.00
60.00		151.40	1124.58	0.00	0.00
65.00		135.54	1004.31	0.00	0.00
70.00		138.44	1004.31	0.00	0.00
75.00	(2) appurtenances	161.71	1064.31	0.00	0.00
80.00		143.83	1004.31	0.00	0.00
85.00		125.43	884.05	0.00	0.00
87.00	(23) appurtenances	1234.03	2730.62	0.00	0.00
90.00		76.50	518.98	0.00	0.00
91.00	(9) appurtenances	492.01	476.29	0.00	0.00
95.00		103.59	688.13	0.00	0.00
97.00	(31) appurtenances	1512.47	2543.07	0.00	0.00
98.00	(8) appurtenances	303.91	802.71	0.00	0.00
100.00		52.56	313.83	0.00	0.00
105.00	(17) appurtenances	1613.33	3220.67	0.00	6302.01
	Totals:	7,898.62	31,193.68	0.00	6,302.01

Resulting Forces and Deflections

Structure: CT01498-S-SB
Site Name: Avon
Height: 105.00 (ft)
Base Elev: 0.000 (ft)

Code: EIA/TIA-222-F
Exposure: C
Gh: 1.69
Struct Class: II

7/29/2015
 Page: 21



Load Case: 50 mph Wind with 0" Ice

Dead Load Factor 1.00
Wind Load Factor 1.00

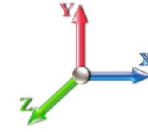

Iterations: 15

Elev (ft)	Lateral FX (-) (kips)	Axial FY (-) (kips)	Lateral FZ (kips)	Moment MX (ft-kips)	Torsion MY (ft-kips)	Moment MZ (ft-kips)	Deflect X (in)	Deflect Z (in)	Deflect Resultant (in)	Rotation Sway (deg)	Rotation Twist (deg)
0.00	-7.906	-31.192	0.000	0.000	0.000	-643.10	0.000	0.000	0.000	0.000	0.000
5.00	-7.760	-29.823	0.000	0.000	0.000	-603.57	-0.015	0.000	0.015	-0.028	0.000
10.00	-7.612	-28.454	0.000	0.000	0.000	-564.77	-0.060	0.000	0.060	-0.055	0.000
15.00	-7.462	-27.086	0.000	0.000	0.000	-526.71	-0.131	0.000	0.131	-0.080	0.000
20.00	-7.311	-25.719	0.000	0.000	0.000	-489.40	-0.227	0.000	0.227	-0.103	0.000
25.00	-7.175	-24.471	0.000	0.000	0.000	-452.84	-0.347	0.000	0.347	-0.124	0.000
30.00	-7.039	-23.223	0.000	0.000	0.000	-416.97	-0.492	0.000	0.492	-0.152	0.000
35.00	-6.899	-21.976	0.000	0.000	0.000	-381.77	-0.665	0.000	0.665	-0.177	0.000
40.00	-6.751	-20.729	0.000	0.000	0.000	-347.28	-0.862	0.000	0.862	-0.199	0.000
45.00	-6.615	-19.602	0.000	0.000	0.000	-313.53	-1.083	0.000	1.083	-0.220	0.000
50.00	-6.475	-18.476	0.000	0.000	0.000	-280.45	-1.328	0.000	1.328	-0.247	0.000
55.00	-6.329	-17.349	0.000	0.000	0.000	-248.07	-1.599	0.000	1.599	-0.270	0.000
60.00	-6.178	-16.223	0.000	0.000	0.000	-216.43	-1.894	0.000	1.894	-0.291	0.000
65.00	-6.042	-15.218	0.000	0.000	0.000	-185.54	-2.209	0.000	2.209	-0.309	0.000
70.00	-5.904	-14.212	0.000	0.000	0.000	-155.33	-2.545	0.000	2.545	-0.332	0.000
75.00	-5.739	-13.147	0.000	0.000	0.000	-125.81	-2.903	0.000	2.903	-0.351	0.000
80.00	-5.592	-12.142	0.000	0.000	0.000	-97.121	-3.279	0.000	3.279	-0.366	0.000
85.00	-5.463	-11.258	0.000	0.000	0.000	-69.161	-3.668	0.000	3.668	-0.377	0.000
87.00	-4.211	-8.536	0.000	0.000	0.000	-58.236	-3.828	0.000	3.828	-0.382	0.000
90.00	-4.132	-8.017	0.000	0.000	0.000	-45.602	-4.070	0.000	4.070	-0.389	0.000
91.00	-3.637	-7.544	0.000	0.000	0.000	-41.470	-4.152	0.000	4.152	-0.391	0.000
95.00	-3.530	-6.856	0.000	0.000	0.000	-26.920	-4.482	0.000	4.482	-0.396	0.000
97.00	-2.000	-4.323	0.000	0.000	0.000	-19.861	-4.649	0.000	4.649	-0.398	0.000
98.00	-1.690	-3.523	0.000	0.000	0.000	-17.862	-4.732	0.000	4.732	-0.399	0.000
100.00	-1.636	-3.209	0.000	0.000	0.000	-14.481	-4.900	0.000	4.900	-0.401	0.000
105.00	-1.613	0.000	0.000	0.000	0.000	-6.302	0.000	0.000	5.321	-0.403	0.000

Resulting Stresses

Structure: CT01498-S-SBA
Site Name: Avon
Height: 105.00 (ft)
Base Elev: 0.000 (ft)

Code: EIA/TIA-222-F
Exposure: C
Gh: 1.69
Struct Class: II

7/29/2015
 Page: 22



Load Case: 50 mph Wind with 0" Ice

Dead Load Factor 1.00
Wind Load Factor 1.00

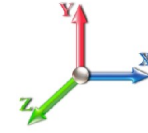

Iterations: 15

Applied Stresses

Elev (ft)	fa Axial (Y) (ksi)	fvx Shear (X) (ksi)	fvz Shear (Z) (ksi)	fvT Torsion (ksi)	fbx Bending (X) (ksi)	fbz Bending (Z) (ksi)	fb Combined (ksi)	Allow Stress (ksi)	Fa Allow Stress (ksi)	f/Fb Stress Ratio
0.00	0.44	0.23	0.00	0.00	0.00	7.41	7.86	32.5	29.9	0.242
5.00	0.42	0.22	0.00	0.00	0.00	6.96	7.39	32.5	29.9	0.227
10.00	0.41	0.22	0.00	0.00	0.00	6.51	6.92	32.5	29.9	0.213
15.00	0.39	0.21	0.00	0.00	0.00	6.07	6.47	32.5	29.9	0.199
20.00	0.37	0.21	0.00	0.00	0.00	5.64	6.02	32.5	29.9	0.185
20.00	0.37	0.21	0.00	0.00	0.00	5.64	6.02	32.5	29.9	0.227
25.00	0.39	0.23	0.00	0.00	0.00	6.46	6.85	33.5	30.5	0.205
30.00	0.37	0.22	0.00	0.00	0.00	5.94	6.32	33.5	30.5	0.189
35.00	0.35	0.22	0.00	0.00	0.00	5.44	5.80	33.5	30.5	0.173
40.00	0.33	0.21	0.00	0.00	0.00	4.95	5.29	33.5	30.5	0.158
40.00	0.33	0.21	0.00	0.00	0.00	4.95	5.29	33.5	30.5	0.199
45.00	0.35	0.24	0.00	0.00	0.00	5.67	6.04	33.6	31.1	0.180
50.00	0.33	0.23	0.00	0.00	0.00	5.07	5.42	33.6	31.1	0.161
55.00	0.31	0.23	0.00	0.00	0.00	4.49	4.81	33.6	31.1	0.143
60.00	0.29	0.22	0.00	0.00	0.00	3.92	4.22	33.6	31.1	0.126
60.00	0.29	0.22	0.00	0.00	0.00	3.92	4.22	33.6	31.1	0.163
65.00	0.31	0.25	0.00	0.00	0.00	4.40	4.73	33.6	32.0	0.141
70.00	0.29	0.24	0.00	0.00	0.00	3.68	3.99	33.6	32.0	0.119
75.00	0.27	0.23	0.00	0.00	0.00	2.98	3.28	33.6	32.0	0.098
80.00	0.25	0.23	0.00	0.00	0.00	2.30	2.58	33.6	32.0	0.077
80.00	0.25	0.23	0.00	0.00	0.00	2.30	2.58	33.6	32.0	0.103
85.00	0.27	0.26	0.00	0.00	0.00	2.24	2.55	33.6	33.1	0.076
87.00	0.20	0.20	0.00	0.00	0.00	1.89	2.12	33.6	33.1	0.063
90.00	0.19	0.20	0.00	0.00	0.00	1.48	1.70	33.6	33.1	0.051
91.00	0.18	0.17	0.00	0.00	0.00	1.34	1.55	33.6	33.1	0.046
95.00	0.16	0.17	0.00	0.00	0.00	0.87	1.08	33.6	33.1	0.032
97.00	0.10	0.10	0.00	0.00	0.00	0.64	0.76	33.6	33.1	0.023
98.00	0.08	0.08	0.00	0.00	0.00	0.58	0.68	33.6	33.1	0.020
100.00	0.08	0.08	0.00	0.00	0.00	0.47	0.56	33.6	33.1	0.017
105.00	0.00	0.08	0.00	0.00	0.00	0.20	0.24	33.6	33.1	0.007

Final Analysis Summary

Structure: CT01498-S-SBA
Site Name: Avon
Height: 105.00 (ft)
Base Elev: 0.000 (ft)

Code: EIA/TIA-222-F
Exposure: C
Gh: 1.69
Struct Class: II

7/29/2015
 Page: 23



Reactions

Load Case	Shear FX (kips)	Shear FZ (kips)	Axial FY (kips)	Moment MX (ft-kips)	Moment MY (ft-kips)	t MZ (ft-kips)
80 mph Wind with 0" Ice	20.2	0.00	31.18	0.00	0.00	1646.44
69.28 mph Wind with 0.5" Ice	16.5	0.00	37.20	0.00	0.00	1364.88
50 mph Wind with 0" Ice	7.9	0.00	31.19	0.00	0.00	643.10

Max Stresses

Load Case	fa Axial (Y) (ksi)	fvx Shear (X) (ksi)	fvz Shear (Z) (ksi)	fvT Torsion (ksi)	fbx Bending (X) (ksi)	fbz Bending (Z) (ksi)	Combined Stress (ksi)	Allowable Stress (ksi)	Elev (ft)	Stress Ratio
80 mph Wind with 0" Ice	0.44	0.58	0.00	0.00	0.00	18.97	19.44	32.5	0.00	0.598
69.28 mph Wind with 0.5" Ice	0.53	0.47	0.00	0.00	0.00	15.73	16.28	32.5	0.00	0.501
50 mph Wind with 0" Ice	0.44	0.23	0.00	0.00	0.00	7.41	7.86	32.5	0.00	0.242

Coax Layout

CT01498-S

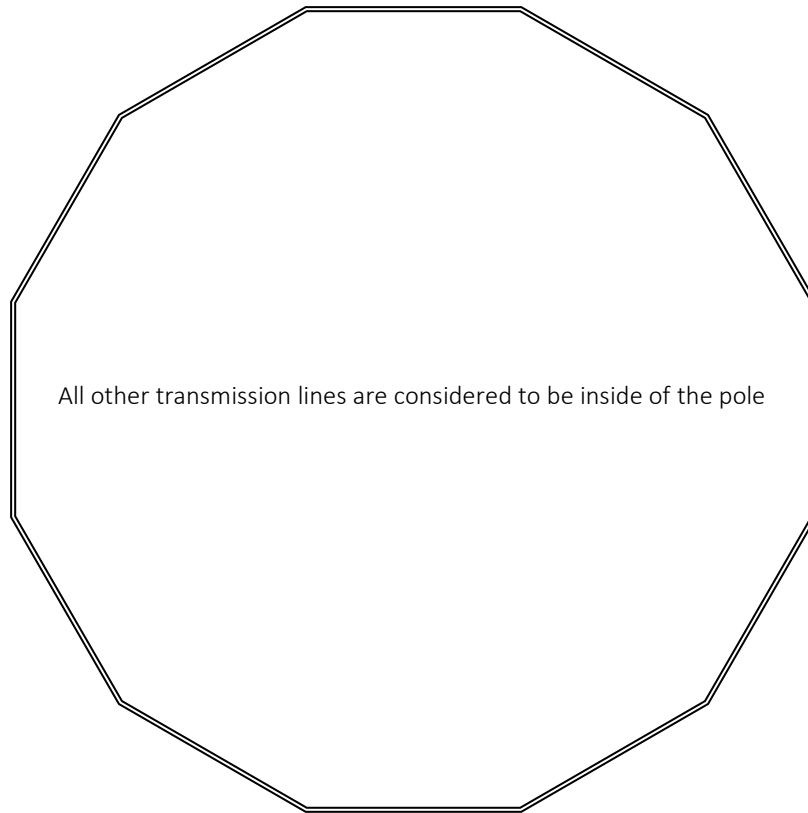



Monopole Mat Foundation Design

Date
7/28/2015

Customer Name:	T-Mobile	EIA/TIA Standard:	EIA-222-F
Site Name:	Avon	Structure Height (Ft.):	105
Site Number:	CT01498-S-SBA	Engineer Name:	. Arinyedokia
Engr. Number:	16672	Engineer Login ID:	

Foundation Info Obtained from:

Drawings/Calculations
Monopole
Analysis

Structure Type:

Analysis or Design?

Base Reactions (Unfactored)

Axial Load (Kips):	37.2	Shear Force (Kips):	20.2
Uplift Force (Kips):	0.0	Moment (Kips-ft):	1646.0

Allowable overstress %: 5.0%

Foundation Geometries:

Mod's required -Yes/No ?:	No		
Diameter of Pier (ft.):	5.8	Depth of Base BG (ft.):	2.8
Pier Height A. G. (ft.):	0.00	Thickness of Pad (ft):	6.50
Length of Pad (ft.):	20	Width of Pad (ft.):	20
Final Length of pad (ft)	20.0	Final width of pad (ft):	20.0
Control Value for Cell D18:	0	Control Value for Cell F18:	0

Material Properties and Rebar Info:

Concrete Strength (psi):	4000	Steel Elastic Modulus:	29000	ksi
Vertical bar yield (ksi)	60	Tie steel yield (ksi):	60	
Vertical Rebar Size #:		Tie / Stirrup Size #:	5	
Qty. of Vertical Rebars:		Tie Spacing (in):	6.0	
Pad Rebar Yield (Ksi):	60	Pad Steel Rebar Size (#):	7	
Concrete Cover (in.):	3	Unit Weight of Concrete:	150.0	pcf
Rebar at the bottom of the concrete pad:				
Qty. of Rebar in Pad (L):	27	Qty. of Rebar in Pad (W):	27	
Rebar at the top of the concrete pad:				
Qty. of Rebar in Pad (L):	27	Qty. of Rebar in Pad (W):	27	

Apply 1.35 factor for e/w Per G: 1.35

Soil Design Parameters:

Soil Unit Weight (pcf):	125.0	Soil Buoyant Weight:	63.0	Pcf	Angle from Top of Pad:	30
Water Table B.G.S. (ft):	99.0	Unit Weight of Water:	62.4	pcf	Angle from Bottm of Pad:	30
Allowable Net Soil Bearing (psf):	30000	Allowable Skin Friction:	0	Psf	Angle from Bottm of Pad:	25
Consider Friction for O.T.M. (Y/N):	No	Consider Friction for bearing (Y/N):	No		Reduction factor on the maximum soil bearing pressure:	1.00
Consider soil hori. force for O.T.M.:	No					

Foundation Analysis and Design:

Total Dry Soil Volume (cu. Ft.):	0.75	Total Dry Soil Weight (Kips):	0.09
Total Buoyant Soil Volume (cu. Ft.):	0.00	Total Buoyant Soil Weight (Kips):	0.00
Total Effective Soil Weight (Kips):	0.09	Weight from the Concrete Block at Top (K):	0.00
Total Dry Concrete Volume (cu. Ft.):	2600.18	Total Dry Concrete Weight (Kips):	390.03
Total Buoyant Concrete Volume (cu. Ft.):	0.00	Total Buoyant Concrete Weight (Kips):	0.00
Total Effective Concrete Weight (Kips):	390.03	Total Vertical Load on Base (Kips):	427.32

Check Soil Capacities:

Calculated Maxium Net Soil Pressure under the base (psf):	2269	<	Allowable Soil Bearing (psf):	30000	0.08	OK!
Allowable Foundation Overturning Resistance (SF=1.5, kips-ft.):	2848.8	>	Applied Momont (kips-ft):	1777	0.62	OK!
Factor of Safety Against Overturning (O. R. Moment/Design Moment):	2.40					OK!

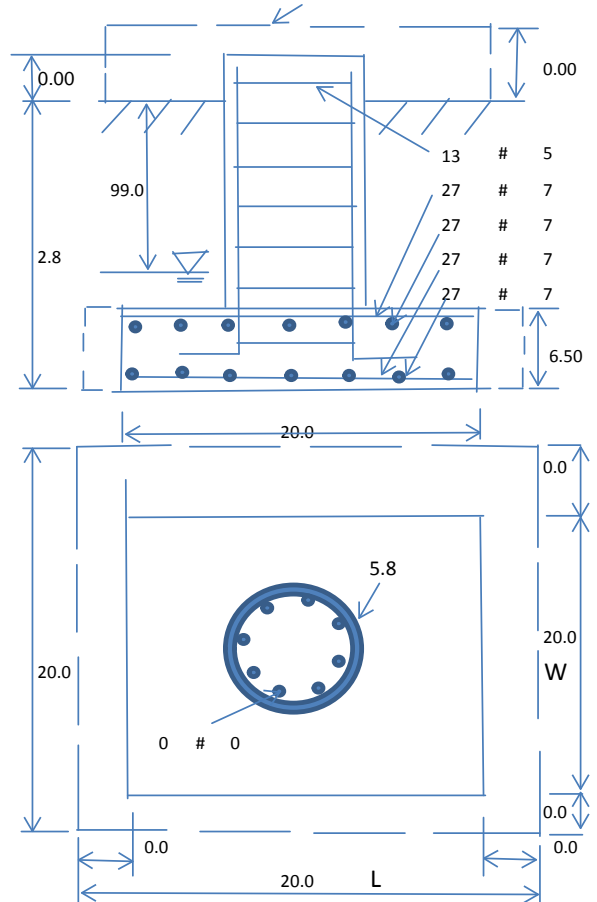

Check the capacities of Reinforcing Concrete:

Strength reduction factor (Flexure and axial tension): 0.90 Strength reduction factor (Shear): 0.75
 Strength reduction factor (Axial compression): 0.65 Wind Load Factor on Concrete Design: 1.30

Load/
Capacity
Ratio

(1) Concrete Pier:

Vertical Steel Rebar Area (sq. in./each):	#N/A	Tie / Stirrup Area (sq. in./each):	0.31		
Calculated Moment Capacity (Mn,Kips-Ft):	#DIV/0!	Design Factored Moment (Mu, Kips-Ft)	2140.0	#####	####
Calculated Shear Capacity (Kips):	697.0	> Design Factored Shear (Kips):	26.3	0.04	OK!
Calculated Tension Capacity (Tn, Kips):	#N/A	Design Factored Tension (Tu Kips):	0.0	#N/A	####
Calculated Compression Capacity (Pn, Kips):	#N/A	Design Factored Axial Load (Pu Kips):	48.4	#N/A	####
Moment & Axial Strength Combination(Pu/Pn+Mu/Mn):	#DIV/0!	Check Tie Spacing (Design/Required):		#####	####
Pier Reinforcement Ratio:	#N/A	#N/A			

(2).Concrete Pad:

One-Way Design Shear Capacity (L-Direction, Kips):	1697.7	>	One-Way Factored Shear (L-D. Kips):	36.5	0.02	OK!
One-Way Design Shear Capacity (W-Direction, Kips):	1697.7	>	One-Way Factored Shear (W-D., Kips)	36.5	0.02	OK!
One-Way Design Shear Capacity (Corner-Corner. Kips):	1912.8	>	One-Way Factored Shear (C-C, Kips):	353.9	0.19	OK!
Lower Steel Pad Reinforcement Ratio (L-Direct.):	0.0009	OK!	Lower Steel Pad Reinf. Ratio (W-Direc	0.0009		
Lower Steel Pad Moment Capacity (L-Direction. Kips-ft):	5392.2	>	Moment at Bottom (L-Direct. K-Ft):	12.8	0.00	OK!
Lower Steel Pad Moment Capacity (W-Direction. Kips-ft):	5392.2	>	Moment at Bottom (W-Direct. K-Ft):	12.8	0.00	OK!
Lower Steel Pad Moment Capacity (Corner-Corner,K-ft):	7610.0	>	Moment at Bottom (C-C Dir. K-Ft):	18.1	0.00	OK!
Upper Steel Pad Reinforcement Ratio (L-Direct.):	0.0009	OK!	Upper Steel Reinf. Ratio (W-Direct.):	0.0009		
Upper Steel Pad Moment Capacity (L-Direction. Kips-ft):	5392.2	>	Moment at the top (L-Dir Kips-Ft):	48.7	0.01	OK!
Upper Steel Pad Moment Capacity (W-Direction. Kips-ft):	5392.2	>	Moment at the top (W-Dir Kips-Ft):	48.7	0.01	OK!
Upper Steel Pad Moment Capacity (Corner-Corner. K-ft):	7610.0	>	Moment at the top (C-C Direc. K-Ft):	377.1	0.05	OK!

RADIO FREQUENCY EMISSIONS ANALYSIS REPORT
EVALUATION OF HUMAN EXPOSURE POTENTIAL
TO NON-IONIZING EMISSIONS

T-Mobile Existing Facility

Site ID: CT11380C

Avon
10 Redwood Lane
Avon, CT 06001

August 11, 2015

EBI Project Number: 6215004252

Site Compliance Summary	
Compliance Status:	COMPLIANT
Site total MPE% of FCC general public allowable limit:	82.65 %

August 11, 2015

T-Mobile USA
Attn: Jason Overbey, RF Manager
35 Griffin Road South
Bloomfield, CT 06002

Emissions Analysis for Site: **CT11380C – Avon**

EBI Consulting was directed to analyze the proposed T-Mobile facility located at **10 Redwood Lane, Avon, CT**, for the purpose of determining whether the emissions from the Proposed T-Mobile Antenna Installation located on this property are within specified federal limits.

All information used in this report was analyzed as a percentage of current Maximum Permissible Exposure (% MPE) as listed in the FCC OET Bulletin 65 Edition 97-01 and ANSI/IEEE Std C95.1. The FCC regulates Maximum Permissible Exposure in units of microwatts per square centimeter ($\mu\text{W}/\text{cm}^2$). The number of $\mu\text{W}/\text{cm}^2$ calculated at each sample point is called the power density. The exposure limit for power density varies depending upon the frequencies being utilized. Wireless Carriers and Paging Services use different frequency bands each with different exposure limits, therefore it is necessary to report results and limits in terms of percent MPE rather than power density.

All results were compared to the FCC (Federal Communications Commission) radio frequency exposure rules, 47 CFR 1.1307(b)(1) – (b)(3), to determine compliance with the Maximum Permissible Exposure (MPE) limits for General Population/Uncontrolled environments as defined below.

General population/uncontrolled exposure limits apply to situations in which the general public may be exposed or in which persons who are exposed as a consequence of their employment may not be made fully aware of the potential for exposure or cannot exercise control over their exposure. Therefore, members of the general public would always be considered under this category when exposure is not employment related, for example, in the case of a telecommunications tower that exposes persons in a nearby residential area.

Public exposure to radio frequencies is regulated and enforced in units of microwatts per square centimeter ($\mu\text{W}/\text{cm}^2$). The general population exposure limit for the 700 MHz Band is approximately 467 $\mu\text{W}/\text{cm}^2$, and the general population exposure limit for the PCS and AWS bands is 1000 $\mu\text{W}/\text{cm}^2$. Because each carrier will be using different frequency bands, and each frequency band has different exposure limits, it is necessary to report percent of MPE rather than power density.

Occupational/controlled exposure limits apply to situations in which persons are exposed as a consequence of their employment and in which those persons who are exposed have been made fully aware of the potential for exposure and can exercise control over their exposure. Occupational/controlled exposure limits also apply where exposure is of a transient nature as a result of incidental passage through a location where exposure levels may be above general population/uncontrolled limits (see below), as long as the exposed person has been made fully aware of the potential for exposure and can exercise control over his or her exposure by leaving the area or by some other appropriate means.

Additional details can be found in FCC OET 65.

CALCULATIONS

Calculations were done for the proposed T-Mobile Wireless antenna facility located at **10 Redwood Lane, Avon, CT**, using the equipment information listed below. All calculations were performed per the specifications under FCC OET 65. Since T-Mobile is proposing highly focused directional panel antennas, which project most of the emitted energy out toward the horizon, all calculations were performed assuming a lobe representing the maximum gain of the antenna per the antenna manufactures supplied specifications, minus 10 dB, was focused at the base of the tower. For this report the sample point is the top of a 6 foot person standing at the base of the tower.

For all calculations, all equipment was calculated using the following assumptions:

- 1) 2 GSM channels (PCS Band - 1900 MHz) were considered for each sector of the proposed installation. These Channels have a transmit power of 30 Watts per Channel
- 2) 2 UMTS channels (AWS Band – 2100 MHz) were considered for each sector of the proposed installation. These Channels have a transmit power of 30 Watts per Channel.
- 3) 2 LTE channels (AWS Band – 2100 MHz) were considered for each sector of the proposed installation. These Channels have a transmit power of 60 Watts per Channel.
- 4) 1 LTE channel (700 MHz Band) was considered for each sector of the proposed installation. This channel has a transmit power of 30 Watts.
- 5) All radios at the proposed installation were considered to be running at full power and were uncombined in their RF transmissions paths per carrier prescribed configuration. Per FCC OET Bulletin No. 65 - Edition 97-01 recommendations to achieve the maximum anticipated value at each sample point, all power levels emitting from the proposed antenna installation are increased by a factor of 2.56 to account for possible in-phase reflections from the surrounding environment. This is rarely the case, and if so, is never continuous.

- 6) For the following calculations the sample point was the top of a six foot person standing at the base of the tower. The maximum gain of the antenna per the antenna manufactures supplied specifications minus 10 dB was used in this direction. This value is a very conservative estimate as gain reductions for these particular antennas are typically much higher in this direction.
- 7) The antennas used in this modeling are the **Ericsson AIR21 B4A/B2P & B2A/B4P** for 1900 MHz (PCS) and 2100 MHz (AWS) channels and the **Commscope LNX-6515DS-VTM** for 700 MHz channels. This is based on feedback from the carrier with regards to anticipated antenna selection. The **Ericsson AIR21 B4A/B2P & B2A/B4P** have a maximum gain of **15.9 dBd** at their main lobe. The **Commscope LNX-6515DS-VTM** has a maximum gain of **14.6 dBd** at its main lobe. The maximum gain of the antenna per the antenna manufactures supplied specifications, minus 10 dB, was used for all calculations. This value is a very conservative estimate as gain reductions for these particular antennas are typically much higher in this direction.
- 8) The antenna mounting height centerline of the proposed antennas is **110 feet** above ground level (AGL).
- 9) Emissions values for additional carriers were taken from the Connecticut Siting Council active database. Values in this database are provided by the individual carriers themselves.

All calculations were done with respect to uncontrolled / general public threshold limits.

T-Mobile Site Inventory and Power Data

Sector:	A	Sector:	B	Sector:	C
Antenna #:	1	Antenna #:	1	Antenna #:	1
Make / Model:	Ericsson AIR21 B4A/B2P	Make / Model:	Ericsson AIR21 B4A/B2P	Make / Model:	Ericsson AIR21 B4A/B2P
Gain:	15.9 dBd	Gain:	15.9 dBd	Gain:	15.9 dBd
Height (AGL):	110	Height (AGL):	110	Height (AGL):	110
Frequency Bands	1900 MHz(PCS) / 2100 MHz (AWS)	Frequency Bands	1900 MHz(PCS) / 2100 MHz (AWS)	Frequency Bands	1900 MHz(PCS) / 2100 MHz (AWS)
Channel Count	2	Channel Count	2	# PCS Channels:	2
Total TX Power:	120	Total TX Power:	120	# AWS Channels:	120
ERP (W):	4,668.54	ERP (W):	4,668.54	ERP (W):	4,668.54
Antenna A1 MPE%	1.55	Antenna B1 MPE%	1.55	Antenna C1 MPE%	1.55
Antenna #:	2	Antenna #:	2	Antenna #:	2
Make / Model:	Ericsson AIR21 B2A/B4P	Make / Model:	Ericsson AIR21 B2A/B4P	Make / Model:	Ericsson AIR21 B2A/B4P
Gain:	15.9 dBd	Gain:	15.9 dBd	Gain:	15.9 dBd
Height (AGL):	110	Height (AGL):	110	Height (AGL):	110
Frequency Bands	1900 MHz(PCS) / 2100 MHz (AWS)	Frequency Bands	1900 MHz(PCS) / 2100 MHz (AWS)	Frequency Bands	1900 MHz(PCS) / 2100 MHz (AWS)
Channel Count	4	Channel Count	4	Channel Count	4
Total TX Power:	120	Total TX Power:	120	Total TX Power:	120
ERP (W):	4,668.54	ERP (W):	4,668.54	ERP (W):	4,668.54
Antenna A2 MPE%	1.55	Antenna B2 MPE%	1.55	Antenna C2 MPE%	1.55
Antenna #:	3	Antenna #:	3	Antenna #:	3
Make / Model:	Commscope LNX-6515DS-VTM	Make / Model:	Commscope LNX-6515DS-VTM	Make / Model:	Commscope LNX-6515DS-VTM
Gain:	14.6 dBd	Gain:	14.6 dBd	Gain:	14.6 dBd
Height (AGL):	110	Height (AGL):	110	Height (AGL):	110
Frequency Bands	700 MHz	Frequency Bands	700 MHz	Frequency Bands	700 MHz
Channel Count	1	Channel Count	1	Channel Count	1
Total TX Power:	30	Total TX Power:	30	Total TX Power:	30
ERP (W):	865.21	ERP (W):	865.21	ERP (W):	865.21
Antenna A3 MPE%	0.62	Antenna B3 MPE%	0.62	Antenna C3 MPE%	0.62

Site Composite MPE%	
Carrier	MPE%
T-Mobile	11.16
AT&T	37.56 %
MetroPCS	20.50 %
Clearwire	2.24 %
Sprint	0.41 %
Farm. Woods	10.78 %
Site Total MPE %:	82.65 %

T-Mobile Sector 1 Total:	3.72 %
T-Mobile Sector 2 Total:	3.72 %
T-Mobile Sector 3 Total:	3.72 %
Site Total:	82.65 %

Summary

All calculations performed for this analysis yielded results that were **within** the allowable limits for general public exposure to RF Emissions.

The anticipated maximum composite contributions from the T-Mobile facility as well as the site composite emissions value with regards to compliance with FCC's allowable limits for general public exposure to RF Emissions are shown here:

T-Mobile Sector	Power Density Value (%)
Sector 1:	3.72 %
Sector 2:	3.72 %
Sector 3 :	3.72 %
T-Mobile Total:	11.16 %
Site Total:	82.65 %
Site Compliance Status:	COMPLIANT

The anticipated composite MPE value for this site assuming all carriers present is **82.65%** of the allowable FCC established general public limit sampled at the ground level. This is based upon values listed in the Connecticut Siting Council database for existing carrier emissions.

FCC guidelines state that if a site is found to be out of compliance (over allowable thresholds), that carriers over a 5% contribution to the composite value will require measures to bring the site into compliance. For this facility, the composite values calculated were well within the allowable 100% threshold standard per the federal government.



Scott Heffernan
RF Engineering Director

EBI Consulting
21 B Street
Burlington, MA 01803

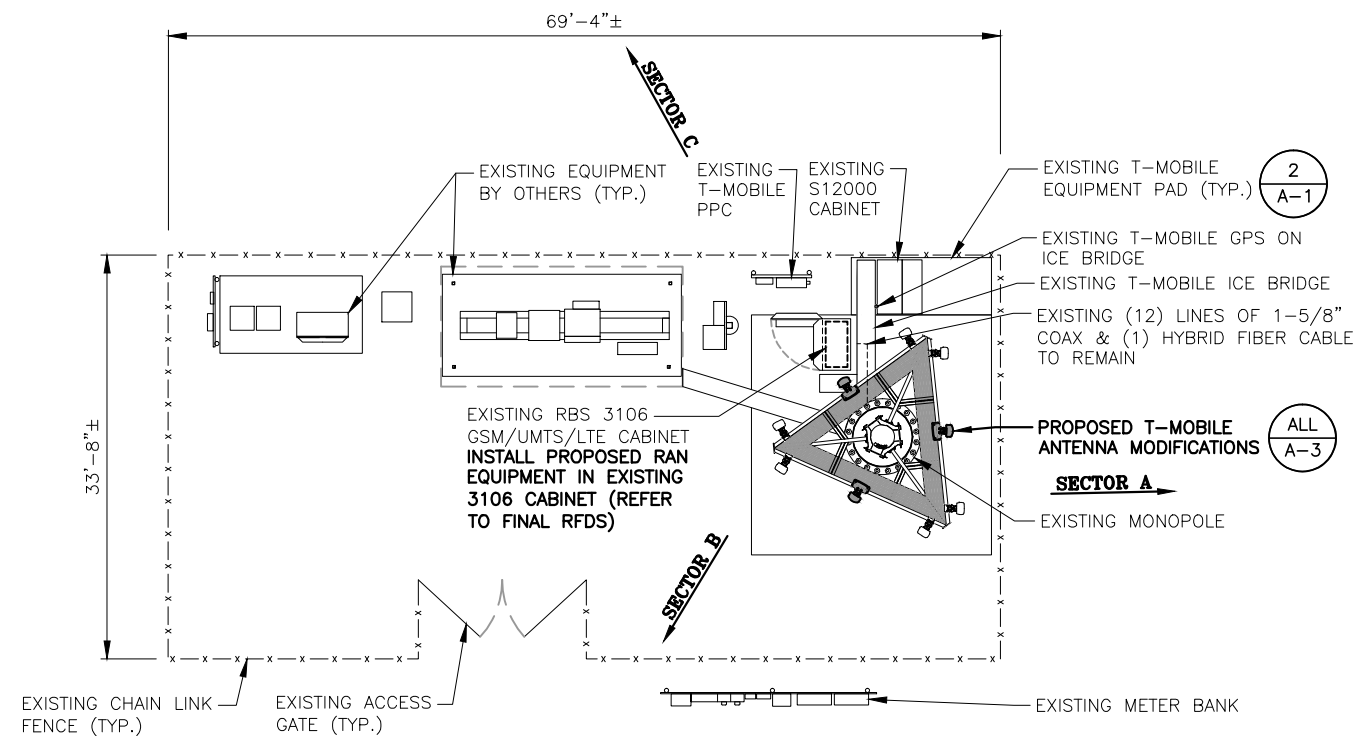

2 A-2 ALL A-3 T-MOBILE PLATFORM
ELEV. = 110.0'± A.G.L. (SBA*)

EXISTING (12) LINES OF 1-5/8" COAX AND (1) HYBRID FIBER CABLE TO REMAIN
(REFER TO SBA PROVIDED STRUCTURAL ANALYSIS FOR SPECIAL CABLE INSTALLATION REQUIREMENTS, BUNDLING, SHIELDING, MOUNTING AND RELOCATION OF EXISTING CABLES)

EXISTING MONOPOLE

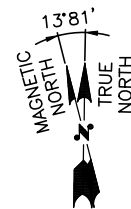

COMPOUND PLAN 1 A-1
22x34 SCALE: 1/8"=1'-0"
11x17 SCALE: 1/16"=1'-0"



STRUCTURAL NOTES:
PRIOR TO COMMENCING CONSTRUCTION, GC SHALL REFER TO TOWER STRUCTURAL ANALYSIS PROVIDED BY SBA TO DETERMINE IF THERE ANY SUPPLEMENTAL OR SPECIAL INSTALLATION REQUIREMENTS FOR TOWER TOP EQUIPMENT AND FOR CABLE BUNDLING, SHIELDING, MOUNTING, OR RELOCATION ARRANGEMENTS.

SPECIAL WORK NOTE:
CONTRACTOR TO VERIFY EXISTING ANTENNA PIPE MAST TO HAVE (2) POINTS OF CONNECTION. IF THERE IS ONLY (1) POINT OF CONNECTION THE CONTRACTOR WILL ADD A SECOND TO EACH EXISTING ANTENNAS OR CENTER ANTENNAS VERTICALLY ON THE ANTENNA MAST SUPPORT ASSEMBLY.

ANTENNA MOUNT STRUCTURAL ASSESSMENT REQUIREMENT:
ENGINEER OF RECORD HAS MADE A VISUAL ASSESSMENT ONLY AND DETERMINED THAT THE EXISTING ANTENNA MOUNT IS ADEQUATE TO ACCOMMODATE ADDITIONAL EQUIPMENT LOADS. STRUCTURAL DESIGNS AND DETAILS AS SHOWN HEREIN FOR STRUCTURAL MODIFICATIONS OF THE EXISTING ANTENNA MOUNT ARE PRELIMINARY ONLY AND FINAL CONSTRUCTION DETAILS ARE SUBJECT TO CHANGE PENDING THE COMPLETION OF AN ANTENNA MOUNT STRUCTURAL ASSESSMENT.

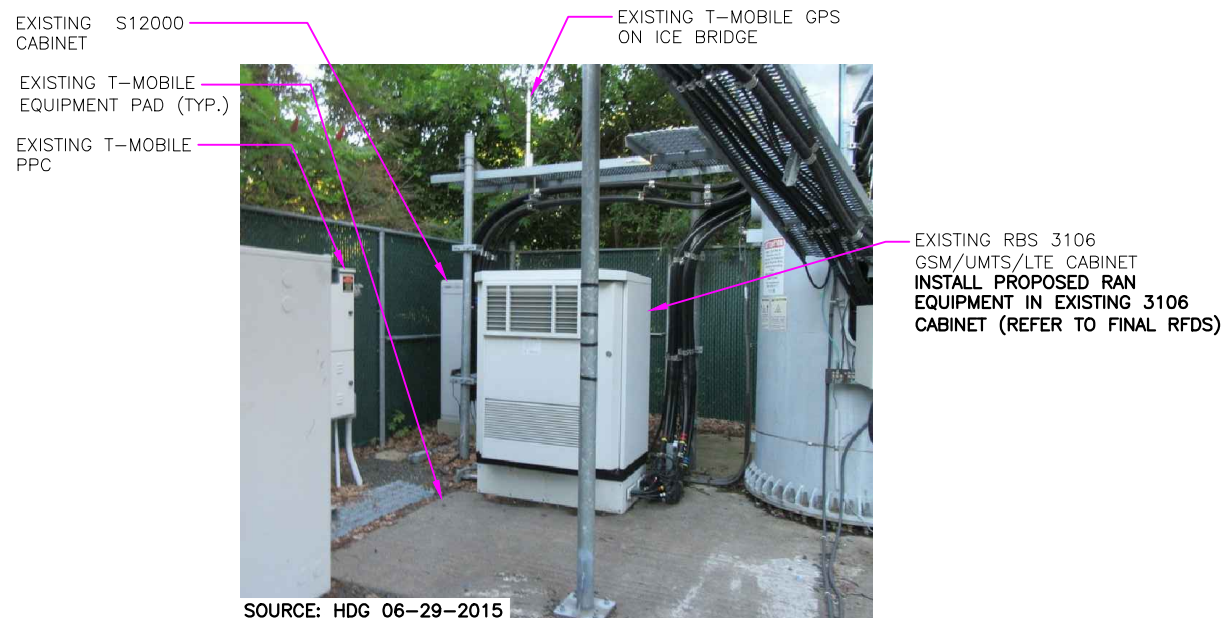

EQUIPMENT PHOTO DETAIL 2 A-1
SCALE: N.T.S

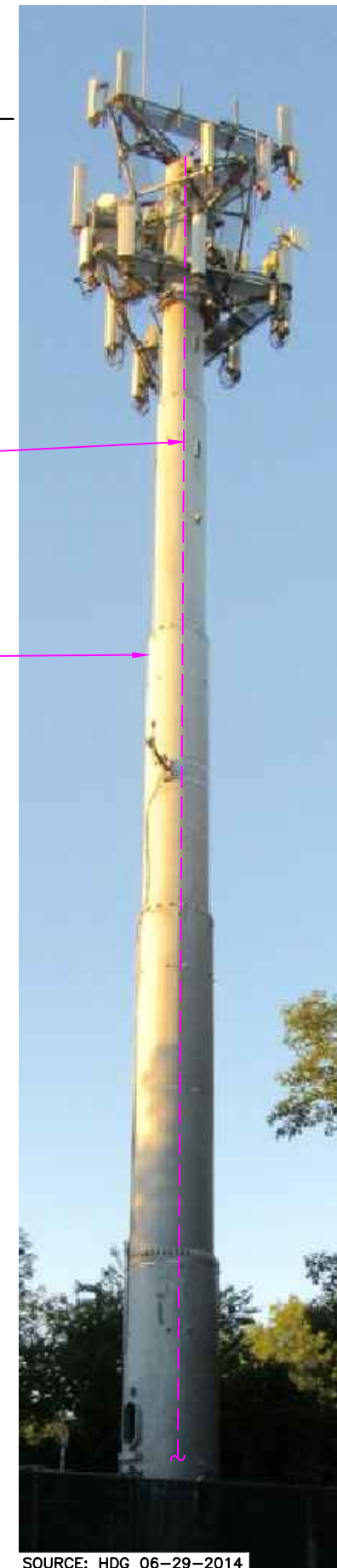

ELEVATION PHOTO DETAIL 3 A-1
SCALE: N.T.S

T-MOBILE NORTHEAST LLC
35 GRIFFIN ROAD SOUTH
BLOOMFIELD, CT 06002
OFFICE: (860) 448-1116

SBA

SBA COMMUNICATIONS CORP.
33 BOSTON POST ROAD WEST, SUITE 320 TEL: (508) 251-0720
MARLBOROUGH, MA 01752 FAX: (508) 251-1753

Hudson Design Group

1600 OSGOOD STREET
BUILDING 20 NORTH, SUITE 3090 TEL: (978) 557-5553
N. ANDOVER, MA 01845 FAX: (978) 336-5586

STATE OF CONNECTICUT
DANIEL P. HAMM
No. 24178
LICENSED PROFESSIONAL ENGINEER

Daniel P. Hamm

CHECKED BY: BB
APPROVED BY: DPH

SUBMITTALS

REV.	DATE	DESCRIPTION	BY
1	07/22/15	ISSUED FOR CONSTRUCTION	JA
0	07/17/15	ISSUED FOR CONSTRUCTION	VP

SITE NUMBER:
CT11380C
SITE NAME:
SBA AVON/RT. 177
SITE ADDRESS:
10 REDWOOD LANE
AVON, CT 06001
HARTFORD COUNTY

SHEET TITLE
COMPOUND & ELEVATION PLAN

SHEET NUMBER
A-1

ANTENNA MOUNT STRUCTURAL ASSESSMENT REQUIREMENT:
 ENGINEER OF RECORD HAS MADE A VISUAL ASSESSMENT ONLY AND DETERMINED THAT THE EXISTING ANTENNA MOUNT IS ADEQUATE TO ACCOMMODATE ADDITIONAL EQUIPMENT LOADS. STRUCTURAL DESIGNS AND DETAILS AS SHOWN HEREIN FOR STRUCTURAL MODIFICATIONS OF THE EXISTING ANTENNA MOUNT ARE PRELIMINARY ONLY AND FINAL CONSTRUCTION DETAILS ARE SUBJECT TO CHANGE PENDING THE COMPLETION OF AN ANTENNA MOUNT STRUCTURAL ASSESSMENT.

STRUCTURAL NOTES:
 PRIOR TO COMMENCING CONSTRUCTION, GC SHALL REFER TO TOWER STRUCTURAL ANALYSIS PROVIDED BY SBA TO DETERMINE IF THERE ANY SUPPLEMENTAL OR SPECIAL INSTALLATION REQUIREMENTS FOR TOWER TOP EQUIPMENT AND FOR CABLE BUNDLING, SHIELDING, MOUNTING, OR RELOCATION ARRANGEMENTS.

SPECIAL WORK NOTE:
 CONTRACTOR TO VERIFY EXISTING ANTENNA PIPE MAST TO HAVE (2) POINTS OF CONNECTION. IF THERE IS ONLY (1) POINT OF CONNECTION THE CONTRACTOR WILL ADD A SECOND TO EACH EXISTING ANTENNAS OR CENTER ANTENNAS VERTICALLY ON THE ANTENNA MAST SUPPORT ASSEMBLY.

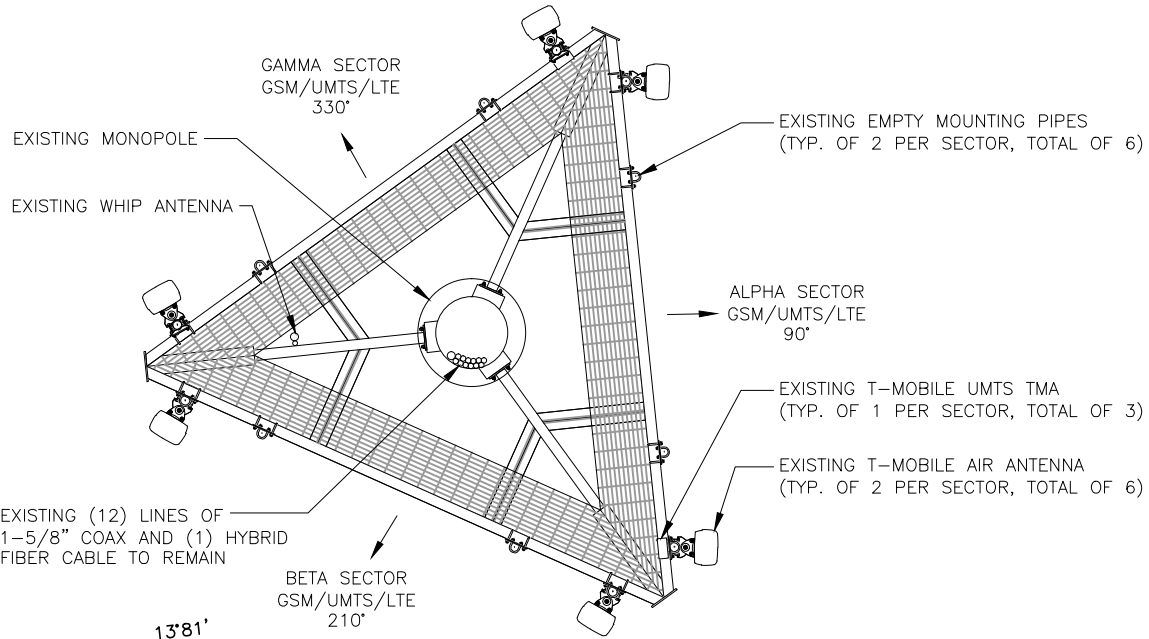

EXISTING ANTENNA PLAN 1
 SCALE: N.T.S. A-2

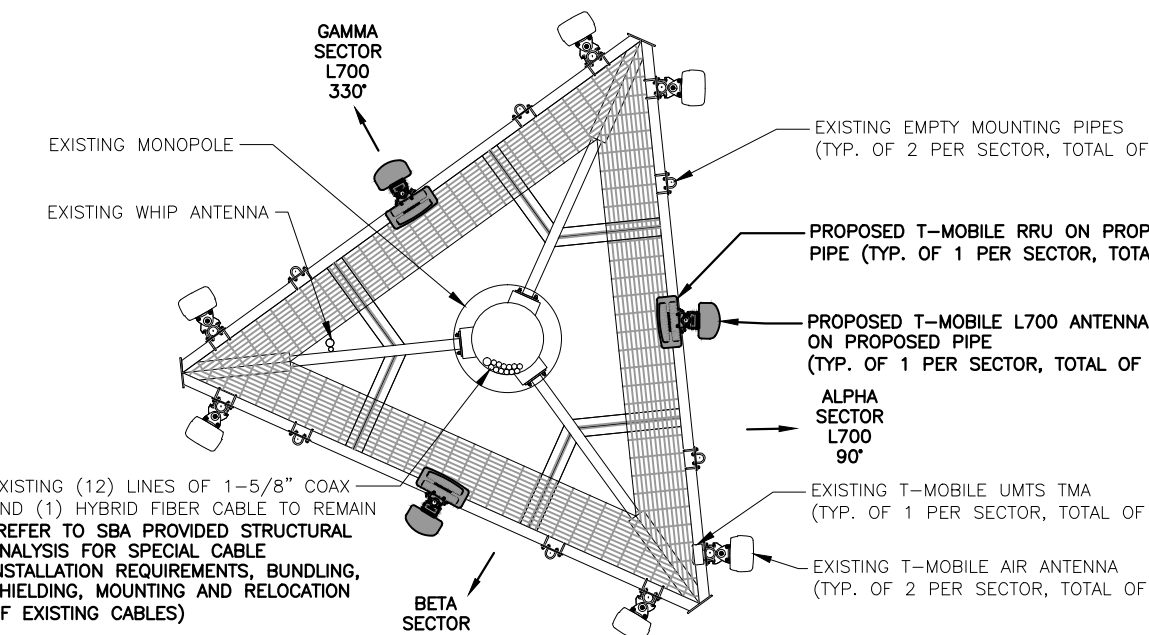

PROPOSED ANTENNA PLAN 2
 SCALE: N.T.S. A-2

ANTENNA INSTALLATION SPECIAL WORK NOTE:
 ANTENNA INSTALLATION WORKING POINT IS THE STRUCTURAL FACE FRAME VERTICAL CENTERLINE OF THE EXISTING ANTENNA SUPPORT ASSEMBLY. UNLESS NOTED OTHERWISE, VERTICALLY CENTER ALL PIPE MASTS AND ANTENNAS ON THIS WORKING POINT.



SOURCE: HDG 06-29-2015

PROPOSED ANTENNA PHOTO DETAIL 3
 SCALE: N.T.S. A-2

T-MOBILE NORTHEAST LLC
 35 GRIFFIN ROAD SOUTH
 BLOOMFIELD, CT 06002
 OFFICE: (860) 448-1116

SBA

SBA COMMUNICATIONS CORP.
 33 BOSTON POST ROAD WEST, SUITE 320 TEL: (508) 251-0720
 MARLBOROUGH, MA 01752 FAX: (508) 251-1753

Hudson Design Group

1600 OSGOOD STREET TEL: (978) 557-5553
 BUILDING 20 NORTH, SUITE 3090 N. ANDOVER, MA 01845 FAX: (978) 336-5586

STATE OF CONNECTICUT
 DANIEL P. HAMM
 No. 24178
 LICENSED PROFESSIONAL ENGINEER

CHECKED BY: BB

APPROVED BY: DPH

SUBMITTALS

REV.	DATE	DESCRIPTION	BY
1	07/22/15	ISSUED FOR CONSTRUCTION	JA
0	07/17/15	ISSUED FOR CONSTRUCTION	VP

SITE NUMBER:
 CT11380C
 SITE NAME:
 SBA AVON/RT. 177
 SITE ADDRESS:
 10 REDWOOD LANE
 AVON, CT 06001
 HARTFORD COUNTY

SHEET TITLE
 EXISTING &
 PROPOSED ANTENNA
 PLANS

SHEET NUMBER
A-2

**T-MOBILE
NORTHEAST LLC**

35 GRIFFIN ROAD SOUTH
BLOOMFIELD, CT 06002
OFFICE: (860) 448-1116



SBA COMMUNICATIONS CORP.
33 BOSTON POST ROAD WEST, SUITE 320 TEL: (508) 251-0720
MARLBOROUGH, MA 01752 FAX: (508) 251-1753



1600 OSGOOD STREET
BUILDING 20 NORTH, SUITE 3090 TEL: (978) 557-5553
N. ANDOVER, MA 01845 FAX: (978) 336-5586



Daniel P. Hamm

CHECKED BY: BB

APPROVED BY: DPH

SUBMITTALS

REV.	DATE	DESCRIPTION	BY
1	07/22/15	ISSUED FOR CONSTRUCTION	JA
0	07/17/15	ISSUED FOR CONSTRUCTION	VP

SITE NUMBER:
CT11380C
SITE NAME:
SBA AVON/RT. 177
SITE ADDRESS:
10 REDWOOD LANE
AVON, CT 06001
HARTFORD COUNTY

SHEET TITLE
EQUIPMENT DETAILS

SHEET NUMBER
A-3

ANTENNA MOUNT STRUCTURAL ASSESSMENT REQUIREMENT:
ENGINEER OF RECORD HAS MADE A VISUAL ASSESSMENT ONLY AND DETERMINED THAT THE EXISTING ANTENNA MOUNT IS ADEQUATE TO ACCOMMODATE ADDITIONAL EQUIPMENT LOADS. STRUCTURAL DESIGNS AND DETAILS AS SHOWN HEREIN FOR STRUCTURAL MODIFICATIONS OF THE EXISTING ANTENNA MOUNT ARE PRELIMINARY ONLY AND FINAL CONSTRUCTION DETAILS ARE SUBJECT TO CHANGE PENDING THE COMPLETION OF AN ANTENNA MOUNT STRUCTURAL ASSESSMENT.

STRUCTURAL NOTES:
PRIOR TO COMMENCING CONSTRUCTION, GC SHALL REFER TO TOWER STRUCTURAL ANALYSIS PROVIDED BY SBA TO DETERMINE IF THERE ANY SUPPLEMENTAL OR SPECIAL INSTALLATION REQUIREMENTS FOR TOWER TOP EQUIPMENT AND FOR CABLE BUNDLING, SHIELDING, MOUNTING, OR RELOCATION ARRANGEMENTS.

SPECIAL WORK NOTE:
CONTRACTOR TO VERIFY EXISTING ANTENNA PIPE MUST TO HAVE (2) POINTS OF CONNECTION. IF THERE IS ONLY (1) POINT OF CONNECTION THE CONTRACTOR WILL ADD A SECOND TO EACH EXISTING ANTENNAS OR CENTER ANTENNAS VERTICALLY ON THE ANTENNA MAST SUPPORT ASSEMBLY.

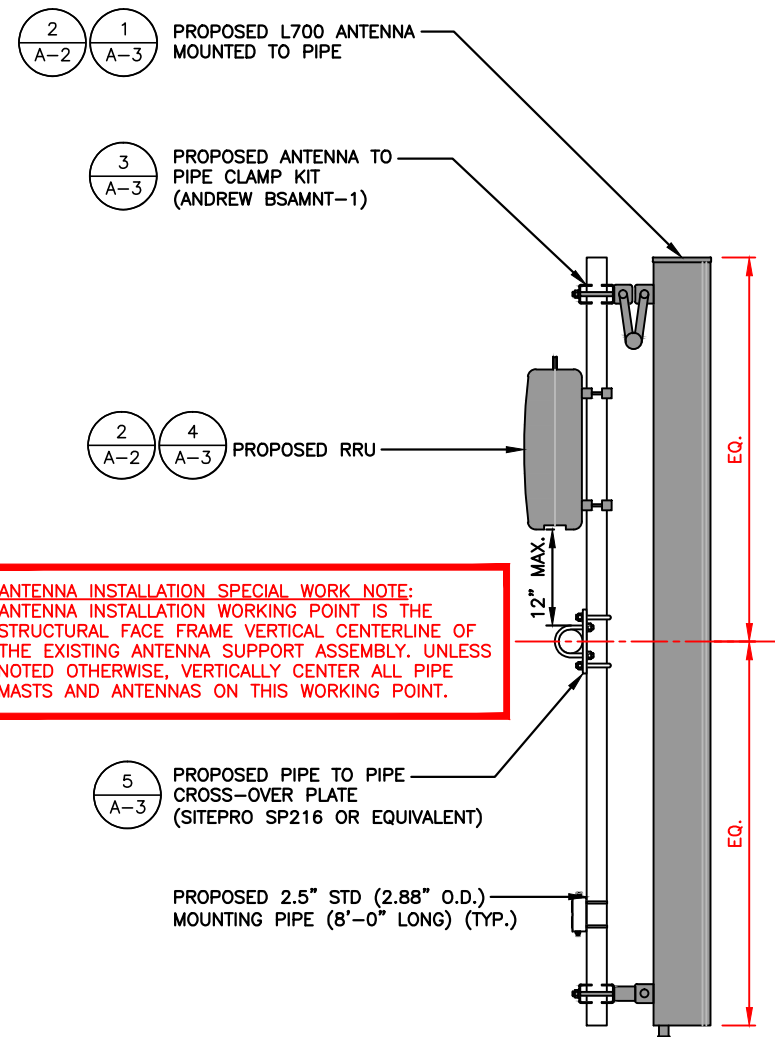

ANTENNA INSTALLATION SPECIAL WORK NOTE:
ANTENNA INSTALLATION WORKING POINT IS THE STRUCTURAL FACE FRAME VERTICAL CENTERLINE OF THE EXISTING ANTENNA SUPPORT ASSEMBLY. UNLESS NOTED OTHERWISE, VERTICALLY CENTER ALL PIPE MASTS AND ANTENNAS ON THIS WORKING POINT.

PROPOSED L700 ANTENNA & RRU MOUNTING DETAIL 2
A-3
SCALE: N.T.S

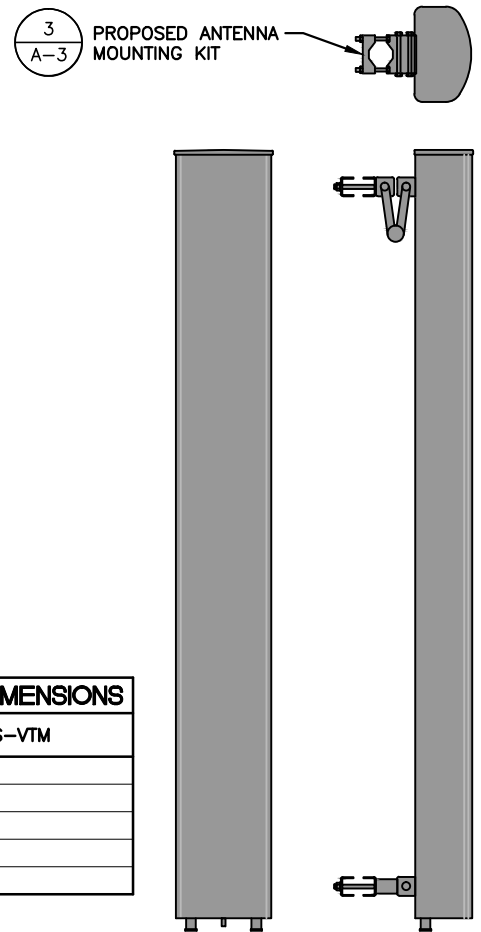

L700 ANTENNA DIMENSIONS

MODEL #	LNX-6515DS-VTM
MANUF.	COMMSCOPE
WIDTH	11.9"
DEPTH	7.1"
HEIGHT	96.4"
WEIGHT	50.3 LBS

L700 ANTENNA DETAIL 1
A-3
SCALE: N.T.S

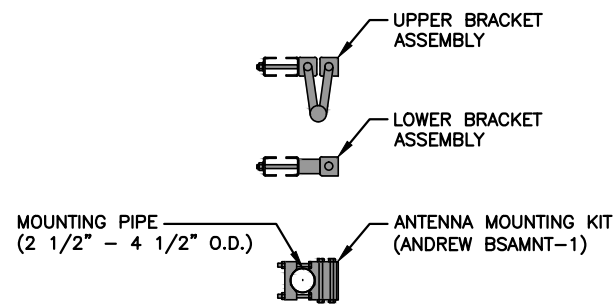

ANTENNA MOUNTING BRACKET 3
A-3
SCALE: N.T.S

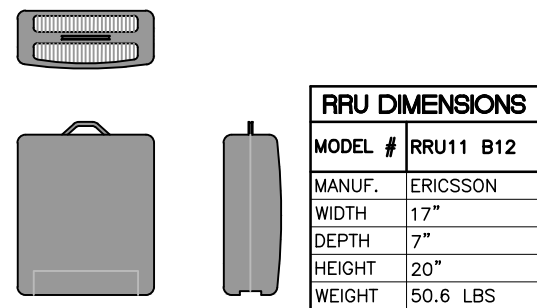

PROPOSED RRU DETAIL 4
A-3
SCALE: N.T.S

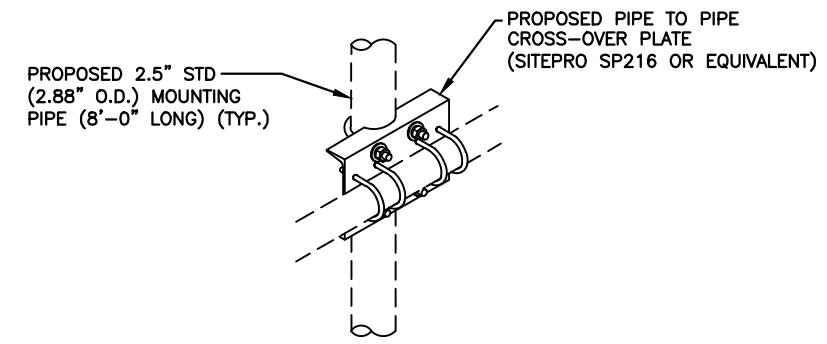

PIPE TO PIPE CROSS-OVER PLATE 5
A-3
SCALE: N.T.S