



10 Industrial Avenue, Suite 3
Mahwah NJ, 07430
Phone: (201)-951-3869
Tom Kincaid
Real Estate Consultant

August 8, 2014

Hand Delivered

Ms. Melanie A. Bachman
Acting Executive Director
Connecticut Siting Council
10 Franklin Square
New Britain, CT 06051

CC Property Owner:
CITY OF ANSONIA CT
253 Main St.
Ansonia, CT 06401

RE: Sprint Spectrum L.P. notice of intent to modify an existing telecommunications facility located at 401 Wakalee Avenue, Ansonia, CT 06401. Known to Sprint Spectrum L.P. as site CT03XC005.

Dear Ms. Bachman:

In order to accommodate technological changes, implement Code Division Multiple Access ("CDMA") and/or Long Term Evolution ("LTE") capabilities, and enhance system performance in the state of Connecticut, Sprint Spectrum L.P. plans to modify the equipment configurations at many of its existing cell sites. Please accept this letter and attachments as notification, pursuant to R.C.S.A. Section 16-50j-73, of construction which constitutes an exempt modification pursuant to R.C.S.A. Section 16-50j-72(b)(2). In compliance with R.C.S.A. Section 16-50j-73, a copy of this letter and its attachments is being sent to the chief elected official of the municipality in which affected cell site is located.

CDMA employs Spread-Spectrum technology and special coding scheme to allow multiple users to be multiplexed over the same physical channel.

LTE is a new high-performance air interface for cellular mobile communications. It is designed to increase the capacity and speed of mobile telephone networks.

Attached is a summary of the planned modifications, including power density calculations reflecting the change in Sprint's operations at the site. Also included is documentation of the structural sufficiency of the tower to accommodate the revised antenna configuration.

The changes to the facility do not constitute modification as defined Connecticut General Statutes ("C.G.S.") Section 16-50i(d) because the general physical characteristics of the facility will not be significantly changed or altered. Rather, the planned changes to the facility fall squarely within those activities explicitly provided for the R.C.S.A. Section 16-50j-72(b)(2).

1. The height of the overall structure will not be affected.
2. The proposed changes will not extend the site boundaries. There will be no effect on the site compound.
3. The proposed changes will not increase the noise level at the existing facility by 6 decibels or more.
4. Radio Frequency power density may increase due to the use of one or more CDMA transmissions. Moreover, LTE will utilize additional radio frequencies newly licensed by the FCC for cellular mobile communications. However, the changes will not increase the calculated "worst case" power density for the combined operations at the site to a level at or above the applicable standard for uncontrolled environments as calculated for a mixed frequency site.

For the foregoing reasons Sprint Spectrum L.P. respectfully submits that the proposed changes at the referenced site constitute exempt modifications under R.C.S.A. Section 16-50j-72(b)(2).

Please feel free to call me at (845) 499-4712 or email JNotaro@Transcendwireless.com with questions concerning this matter. Thank you for your consideration.

Sincerely,

Jennifer Notaro
Real Estate Consultant

RADIO FREQUENCY FCC REGULATORY COMPLIANCE
MAXIMUM PERMISSIBLE EXPOSURE (MPE) ASSESSMENT

Sprint Existing Facility

Site ID: CT03XC005

Ansonia Wakalee

401 Wakalee Avenue
Ansonia, CT 06401

July 16, 2014

EBI Project Number: 62143792

July 16, 2014

Sprint
Attn: RF Engineering Manager
1 International Boulevard, Suite 800
Mahwah, NJ 07495

Re: Radio Frequency Maximum Permissible Exposure (MPE) Assessment for Site:
CT03XC005 - Ansonia Wakalee

Site Total: 29.70% - MPE% in full compliance

EBI Consulting was directed to analyze the proposed upgrades to the existing Sprint facility located at 401 Wakalee Avenue, Ansonia, CT, for the purpose of determining whether the radio frequency (RF) exposure levels from the proposed Sprint equipment upgrades on this property are within specified federal limits.

All information used in this report was analyzed as a percentage of current Maximum Permissible Exposure (% MPE) as listed in the FCC OET Bulletin 65 Edition 97-01 and ANSI/IEEE Std C95.1. The FCC regulates Maximum Permissible Exposure in units of microwatts per square centimeter ($\mu\text{W}/\text{cm}^2$). The number of $\mu\text{W}/\text{cm}^2$ calculated at each sample point is called the power density. The exposure limit for power density varies depending upon the frequencies being utilized. Wireless Carriers and Paging Services use different frequency bands each with different exposure limits, therefore it is necessary to report results and limits in terms of percent MPE rather than power density.

All results were compared to the FCC (Federal Communications Commission) radio frequency exposure rules, 47 CFR 1.1307(b)(1) – (b)(3), to determine compliance with the Maximum Permissible Exposure (MPE) limits for General Population/Uncontrolled environments as defined below.

General population/uncontrolled exposure limits apply to situations in which the general public may be exposed or in which persons who are exposed as a consequence of their employment may not be made fully aware of the potential for exposure or cannot exercise control over their exposure. Therefore, members of the general public would always be considered under this category when exposure is not employment related, for example, in the case of a telecommunications tower that exposes persons in a nearby residential area.

Public exposure to radio frequencies is regulated and enforced in units of microwatts per square centimeter ($\mu\text{W}/\text{cm}^2$). The general population exposure limit for the cellular band (850 MHz Band) is approximately $567 \mu\text{W}/\text{cm}^2$, and the general population exposure limit for the 1900 MHz and 2500 MHz bands is $1000 \mu\text{W}/\text{cm}^2$. Because each carrier will be using different frequency bands, and each frequency band has different exposure limits, it is necessary to report percent of MPE rather than power density.

Occupational/controlled exposure limits apply to situations in which persons are exposed as a consequence of their employment and in which those persons who are exposed have been made fully aware of the potential for exposure and can exercise control over their exposure. Occupational/controlled exposure limits also apply where exposure is of a transient nature as a result of incidental passage through a location where exposure levels may be above general population/uncontrolled limits (see below), as long as the exposed person has been made fully aware of the potential for exposure and can exercise control over his or her exposure by leaving the area or by some other appropriate means.

Additional details can be found in FCC OET 65.

CALCULATIONS

Calculations were done for the proposed upgrades to the existing Sprint Wireless antenna facility located at 401 Wakalee Avenue, Ansonia, CT, using the equipment information listed below. All calculations were performed per the specifications under FCC OET 65. All calculations were performed assuming a lobe representing the maximum gain of the antenna per the antenna manufactures supplied specifications, minus 10 dB, was focused at the base of the tower. For this report the sample point is the top of a 6 foot person standing at the base of the tower.

For all calculations, all emissions were calculated using the following assumptions:

- 1) 4 channels in the 1900 MHz Band were considered for each sector of the proposed installation.
- 2) 1 channel in the 800 MHz Band was considered for each sector of the proposed installation
- 3) 2 channels in the 2500 MHz Band were considered for each sector of the proposed installation.
- 4) All radios at the proposed installation were considered to be running at full power and were uncombined in their RF transmissions paths per carrier prescribed configuration. Per FCC OET Bulletin No. 65 - Edition 97-01 recommendations to achieve the maximum anticipated value at each sample point, all power levels emitting from the proposed antenna installation are increased by a factor of 2.56 to account for possible in-phase reflections from the surrounding environment. This is rarely the case, and if so, is never continuous.
- 5) For the following calculations the sample point was the top of a six foot person standing at the base of the tower. The maximum gain of the antenna per the antenna manufactures supplied specifications minus 10 dB was used in this direction. This value is a very conservative estimate as gain reductions for these particular antennas are typically much higher in this direction.

- 6) The antennas used in this modeling are the RFS APXVSPP18-C-A20, POWERWAVE P40-16-XLPP-RR-A and the RFS APXVTM14-C-I20. This is based on feedback from the carrier with regards to anticipated antenna selection. The RFS APXVSPP18-C-A20 has a 15.9 dBd gain value at its main lobe at 1900 MHz and 13.4 dBd at its main lobe for 850 MHz. The POWERWAVE P40-16-XLPP-RR-A has a 15.9 dBd gain value at its main lobe at 1900 MHz and 13.4 dBd at its main lobe for 850 MHz. The RFS APXVTM14-C-I20 has a 15.9 dBd gain value at its main lobe at 2500 MHz. The maximum gain of the antenna per the antenna manufactures supplied specifications, minus 10 dB, was used for all calculations. This value is a very conservative estimate as gain reductions for these particular antennas are typically much higher in this direction.
- 7) The antenna mounting height centerline for the proposed antennas is **185 feet** above ground level (AGL).
- 8) Emissions values for additional carriers were taken from the Connecticut Siting Council active database. Values in this database are provided by the individual carriers themselves.

All calculation were done with respect to uncontrolled / general public threshold limits

Site ID	CT03XC005 - Ansonia Wakalee
Site Address	401 Wakalee Avenue, Ansonia, CT, 06401
Site Type	Self Support Tower

Sector 1

Antenna Number	Antenna Make	Antenna Model	Radio Type	Frequency Band	Technology	Power Out Per Channel (Watts)	Number of Channels	Composite Power	Antenna Gain (10 db reduction)	Antenna Height (ft)	analysis height	Cable Size	Cable Loss (dB)	Additional Loss (dB)	ERP	Power Density Percentage
1a	Powerwave	P40-16-XLPP-RR	RRH	1900 MHz	CDMA / LTE	20	4	80	5.9	185	179	1/2 "	0.5	0	277.39	0.31%
1a	Powerwave	P40-16-XLPP-RR	RRH	850 MHz	CDMA / LTE	20	1	20	3.4	185	179	1/2 "	0.5	0	39.00	0.08%
1B	RFS	APXVTMM14-C-120	RRH	2500 MHz	CDMA / LTE	20	2	40	5.9	185	179	1/2 "	0.5	0	138.69	0.27%
Sector total Power Density Value:																0.66%

Sector 2

Antenna Number	Antenna Make	Antenna Model	Radio Type	Frequency Band	Technology	Power Out Per Channel (Watts)	Number of Channels	Composite Power	Antenna Gain (10 db reduction)	Antenna Height (ft)	analysis height	Cable Size	Cable Loss (dB)	Additional Loss (dB)	ERP	Power Density Percentage
2a	Powerwave	P40-16-XLPP-RR	RRH	1900 MHz	CDMA / LTE	20	4	80	5.9	185	179	1/2 "	0.5	0	277.39	0.31%
2a	Powerwave	P40-16-XLPP-RR	RRH	850 MHz	CDMA / LTE	20	1	20	3.4	185	179	1/2 "	0.5	0	39.00	0.08%
2B	RFS	APXVTMM14-C-120	RRH	2500 MHz	CDMA / LTE	20	2	40	5.9	185	179	1/2 "	0.5	0	138.69	0.27%
Sector total Power Density Value:																0.66%

Sector 3

Antenna Number	Antenna Make	Antenna Model	Radio Type	Frequency Band	Technology	Power Out Per Channel (Watts)	Number of Channels	Composite Power	Antenna Gain (10 db reduction)	Antenna Height (ft)	analysis height	Cable Size	Cable Loss (dB)	Additional Loss (dB)	ERP	Power Density Percentage
3a	RFS	APXVSP18-C-A20	RRH	1900 MHz	CDMA / LTE	20	4	80	5.9	185	179	1/2 "	0.5	0	277.39	0.31%
3a	RFS	APXVSP18-C-A20	RRH	850 MHz	CDMA / LTE	20	1	20	3.4	185	179	1/2 "	0.5	0	39.00	0.08%
3B	RFS	APXVTMM14-C-120	RRH	2500 MHz	CDMA / LTE	20	2	40	5.9	185	179	1/2 "	0.5	0	138.69	0.27%
Sector total Power Density Value:																0.66%

Site Composite MPE %	
Carrier	MPE %
Sprint	1.99%
AT&T	14.61%
MetroPCS	2.76%
Clearwire	0.49%
Verizon Wireless	9.69%
T-Mobile	0.16%
Total Site MPE %	29.70%

Summary

All calculations performed for this analysis yielded results that were well within the allowable limits for general public Maximum Permissible Exposure (MPE) to radio frequency energy.

The anticipated Maximum Composite contributions from the Sprint facility are **1.99% (0.66% from sector 1, 0.66% from sector 2 and 0.66% from sector 3)** of the allowable FCC established general public limit considering all three sectors simultaneously sampled at the ground level.

The anticipated composite MPE value for this site assuming all carriers present is **29.70%** of the allowable FCC established general public limit sampled at 6 feet above ground level. This total composite site value is based upon MPE values listed in the Connecticut Siting Council database for existing carrier emissions.

FCC guidelines state that if a site is found to be out of compliance (over allowable thresholds), that carriers over a 5% contribution to the composite value will require measures to bring the site into compliance. For this facility, the composite values calculated were well within the allowable 100% threshold standard per the federal government.



Scott Heffernan
RF Engineering Director

EBI Consulting
21 B Street
Burlington, MA 01803



AMERICAN TOWER®
CORPORATION

Structural Analysis Report

Structure : 196 ft Self Supported Tower
ATC Site Name : Ansonia Wakelee, CT
ATC Site Number : 302470
Engineering Number : 58995121
Proposed Carrier : Sprint Nextel
Carrier Site Name : Ansoania Wakelee
Carrier Site Number : CT03XC005
Site Location : 401 Wakelee Ave
Ansonia, CT 06401-1226
41.356069,-73.092000
County : New Haven
Date : June 4, 2014
Max Usage : 90%
Result : Pass

Najaf Ali



Jun 4 2014 4:57 PM



Table of Contents

Introduction	1
Supporting Documents	1
Analysis	1
Conclusion.....	1
Existing and Reserved Equipment.....	2
Equipment to be Removed.....	2
Proposed Equipment	3
Structure Usages	3
Foundations	3
Deflection, Twist, and Sway.....	3
Standard Conditions	4
Calculations	Attached



Introduction

The purpose of this report is to summarize results of a structural analysis performed on the 196 ft self supported tower to reflect the change in loading by Sprint Nextel.

Supporting Documents

Tower Drawings	Rohn Drawing #A991899, dated July 7, 1999
Foundation Drawing	Rohn Drawing #A992523-1, dated September 22, 1999
Geotechnical Report	Tectonic Engineering Consultants W.O. #1170.C754, dated May 20, 1999

Analysis

The tower was analyzed using American Tower Corporation's tower analysis software. This program considers an elastic three-dimensional model and second-order effects per ANSI/TIA-222.

Basic Wind Speed:	105 mph (3-Second Gust)
Basic Wind Speed w/ Ice:	50 mph (3-Second Gust) w/ 3/4" radial ice concurrent
Code:	ANSI/TIA-222-G / 2003 IBC w/ 2005 CT Supplement & 2009 CT Amendment
Structure Class:	II
Exposure Category:	B
Topographic Category:	1

Conclusion

Based on the analysis results, the structure meets the requirements per the applicable codes listed above. The tower and foundation can support the equipment as described in this report.

If you have any questions or require additional information, please contact American Tower via email at Engineering@americantower.com. Please include the American Tower site name, site number, and engineering number in the subject line for any questions.



Existing and Reserved Equipment

Elevation ¹ (ft)		Qty	Antenna	Mount Type	Lines	Carrier	
Mount	RAD						
194.0	194.0	3	Argus LLPX310R	Sector Frames	(6) 5/16" Coax (2) 1/2" Coax (1) 2" Conduit	Clearwire	
		2	DragonWave A-ANT-18G-2-C				
		3	NextNet BTS-2500				
		2	DragonWave Horizon Compact			(6) 1 5/8" Coax (10) 1 1/4" Coax	Sprint Nextel
		3	KMW TTA (HB-X-WM-17-65-00T)				
		3	72" x 12" Panels				
		9	48" x 12" Panels				
183.0	185.0	2	Powerwave P40-16-XLPP-RRR	Sector Frames	(3) 1 1/4" Hybriflex	Sprint Nextel	
		1	RFS APXVSP18-C-A20				
		3	Alcatel-Lucent 800MHz RRH				
		3	Alcatel-Lucent 1900MHz 4x45 RRH				
175.0	177.0	1	Swedcom SLCP 2x6014	Sector Frames	(12) 1 5/8" Coax	Verizon	
		1	Antel BXA-70063-6BF-EDIN-X				
		3	Ryma MGD3-800TX				
		1	Powerwave P65-16-XL-2				
		12	RFS FD9R6004/2C-3L				
		3	Antel BXA-80080/4CF				
		3	Antel BXA-171063-8CF-EDIN-X				
167.0	167.0	9	72" x 12" Panel	Sector Frames	(2) 0.78" 8 AWG 6 (12) 1 5/8" Coax (1) 3" Conduit (1) 0.39" Cable	AT&T Mobility	
		3	36" x 8" x 6" Panel				
		6	Ericsson RRUS 11				
		1	Raycap DC6-48-60-18-8F				
		9	14" x 9" TTA				
157.0	157.0	3	Kathrein 742 213	Leg	(6) 1 5/8" Coax	Metro PCS	
148.0	148.0	3	Ericsson KRY 112 144/1	Sector Frames	(12) 1 5/8" Coax (1) 1 1/4" Hybriflex	T-Mobile	
		3	Ericsson AIR 21, 1.3M, B4A B2P				
		3	Ericsson AIR 21, 1.3M, B2A B4P				
125.0	125.0	2	Motorola PTP54600	Leg	(2) 1/4" Coax	City Of Ansonia	
104.0	104.0	2	2" x 8" GPS	Side Arms	(2) 1/2" Coax	Sprint Nextel	
79.0	84.0	1	10' Omni	Leg	(1) 1/2" Coax	Ansonia Fire Dept.	
76.0	76.0	1	PCTEL GPS-TMG-HR-26N	Side Arm	(1) 1/2" Coax	Sprint Nextel	

Equipment to be Removed

Elevation ¹ (ft)		Qty	Antenna	Mount Type	Lines	Carrier
Mount	RAD					
183.0	185.0	6	Andrew DB980H90E-M	-	(6) 7/8" Coax	Sprint Nextel

¹Mount elevation is defined as height above bottom of steel structure to the bottom of mount, RAD elevation is defined as center of antenna above ground level (AGL).



Proposed Equipment

Elevation ¹ (ft)		Qty	Antenna	Mount Type	Lines	Carrier
Mount	RAD					
183.0	185.0	3	RFS APXV9TM14-ALU-I20	Sector Frames	(1) 1 1/4" Hybriflex	Sprint Nextel
		3	Alcatel-Lucent TD-RRH8x20-25 w			

¹Mount elevation is defined as height above bottom of steel structure to the bottom of mount, RAD elevation is defined as center of antenna above ground level (AGL).

Install proposed coax stacked on top of existing Sprint Nextel coax.



Structure Usages

Structural Component	Controlling Usage	Pass/Fail
Legs	90%	Pass
Diagonals	89%	Pass
Horizontals	15%	Pass
Anchor Bolts	57%	Pass
Leg Bolts	73%	Pass

Foundations

Reaction Component	Original Design Reactions	Factored Design Reactions*	Analysis Reactions	% of Design
Uplift (Kips)	301.1	406.5	345.8	85%
Axial (Kips)	343.0	463.1	396.8	86%
Shear (Kips)	36.3	49.0	40.2	82%

* The design reactions are factored by 1.35 per ANSI/TIA-222-G, Sec. 15.5.1

The structure base reactions resulting from this analysis are acceptable when compared to those shown on the original structure drawings, therefore no modification or reinforcement of the foundation will be required.

Deflection, Twist and Sway*

Antenna Elevation (ft)	Deflection (ft)	Twist (°)	Sway (Rotation) (°)
183.0	0.389	0.013	0.264

*Deflection, Twist and Sway was evaluated considering a design wind speed of 60 mph (3-Second Gust) per ANSI/TIA-222-G



Standard Conditions

All engineering services are performed on the basis that the information used is current and correct. This information may consist of, but is not necessary limited, to:

- Information supplied by the client regarding the structure itself, antenna, mounts and feed line loading on the structure and its components, or other relevant information.
- Information from drawings in the possession of American Tower Corporation, or generated by field inspections or measurements of the structure.

It is the responsibility of the client to ensure that the information provided to ATC Tower Services, Inc. and used in the performance of our engineering services is correct and complete. In the absence of information to the contrary, we assume that all structures were constructed in accordance with the drawings and specifications and that their capacity has not significantly changed from the "as new" condition.

Unless explicitly agreed by both the client and American Tower Corporation, all services will be performed in accordance with the current revision of ANSI/TIA -222. The design basic wind speed will be determined based on the minimum basic wind speed as prescribed in ANSI/TIA-222. Although every effort is taken to ensure that the loading considered is adequate to meet the requirements of all applicable regulatory entities, we can provide no assurance to meet any other local and state codes or requirements. If wind and ice loads or other relevant parameters are to be different from the minimum values recommended by the codes, the client shall specify the exact requirement.

All services are performed, results obtained, and recommendations made in accordance with generally accepted engineering principles and practices. ATC Tower Services, Inc. is not responsible for the conclusions, opinions and recommendations made by others based on the information we supply.

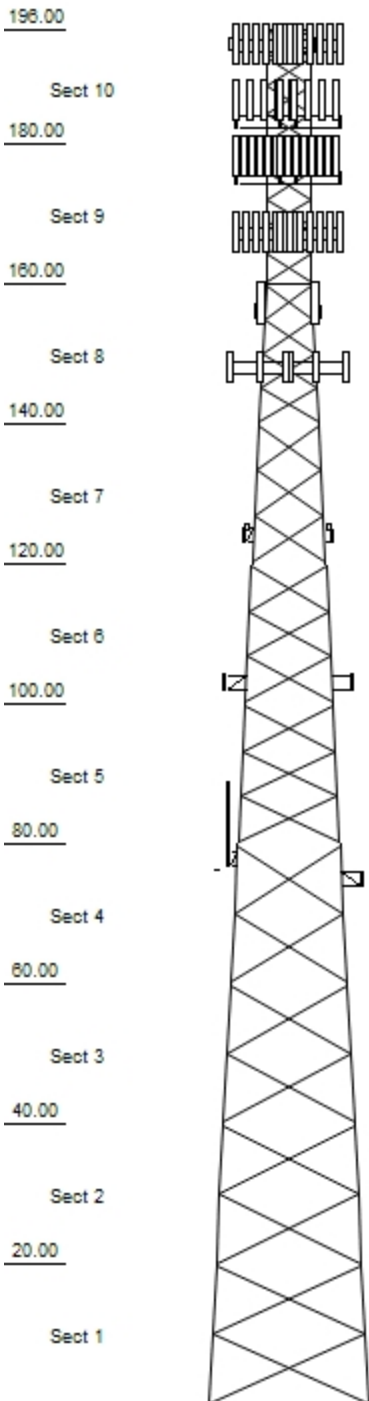

© 2007 - 2014 by ATC IP LLC. All rights reserved.

Loads: 105 mph no ice
 50 mph w / 3/4" radial ice
 60 mph Serviceability

Uplift 345.82 k Moment 7,498.13 k Moment Ice 2,140.99 k-ft
 Vert 395.84 k Tot Down 61.20 k Tot Down Ice 169.81 k
 Horiz 40.24 k Tot Shear 65.90 k Tot Shear Ice 19.21 k

Job Information

Tower : 302470 Location : Ansonia Wakelee, CT
 Code : ANSI/TIA-222 Rev G Shape : Triangle Base Width : 23.00 ft
 Client : Verizon Wireless Top Width : 6.65 ft

Sections Properties

Section	Leg Members	Diagonal Members	Horizontal Members
1	PX 50 ksi 8" DIA PIPE	SAE 50 ksi 4X4X0.25	
2	PSP 50 ksi ROHN 8 EHS	SAE 50 ksi 4X4X0.25	
3	PSP 50 ksi ROHN 8 EHS	SAE 50 ksi 3.5X3.5X0.25	
4	PX 50 ksi 6" DIA PIPE	SAE 50 ksi 3.5X3.5X0.25	
5	PSP 50 ksi ROHN 6 EHS	SAE 50 ksi 3X3X0.25	
6 - 7	PX 50 ksi 5" DIA PIPE	SAE 36 ksi 2.5X2.5X0.25	
8	PX 50 ksi 4" DIA PIPE	SAE 36 ksi 2X2X0.25	SAE 36 ksi 2X2X0.125
9	PX 50 ksi 3" DIA PIPE	SAE 36 ksi 2X2X0.1875	
10	PST 50 ksi 2-1/2" DIA PIPE	SAE 36 ksi 1.75X1.75X0.1875	SAE 36 ksi 2X2X0.125

Discrete Appurtenance

Elev (ft)	Type	Qty	Description
194.00	Panel	3	Argus LLPX310R
194.00	Dish	2	DragonWave A-ANT-18G-2-C
194.00	Panel	3	NextNet BTS-2500
194.00	Panel	2	DragonWave Horizon Compact
194.00	Panel	3	KMW TTA (HB-X-WM-17-65-00T)
194.00	Mounting Frame	3	Round Sector Frames
194.00	Panel	3	72" x 12" Panels
194.00	Panel	9	48" x 12" Panels
183.00	Panel	3	RFS APXV9TM14-ALU-I20
183.00	Panel	3	Acatel-Lucent TD-RRH8x20-25 w
183.00	Panel	2	Powerwave P40-16-XLPP-RRR
183.00	Panel	1	RFS APXVSP18-C-A20
183.00	Panel	3	Acatel-Lucent 800 MHz RRH
183.00	Panel	3	Acatel-Lucent 1900 MHz 4x45 R
183.00	Mounting Frame	3	Round Sector Frames
175.00	Panel	1	Swedcom SLCP 2x6014
175.00	Panel	1	Antel BXA-70063-6BF-EDIN-X
175.00	Panel	3	Ryma MGD3-800TX
175.00	Panel	1	Powerwave P65-16-XL-2
175.00	Mounting Frame	3	Flat Light Sector Frames
175.00	Panel	12	RFS FD9R6004/2C-3L
175.00	Panel	3	Antel BXA-80080/4CF
175.00	Panel	3	Antel BXA-171063-8CF-EDIN-X
167.00	Panel	9	72" x 12" Panel
167.00	Panel	3	36" x 8" x 6" Panel
167.00	Panel	6	Ericsson RRUS 11
167.00	Panel	1	Raycap DC6-48-60-18-8F
167.00	Mounting Frame	3	Round Sector Frames
167.00	Panel	9	14" x 9" TTA
157.00	Panel	3	Kathrein 742 213
148.00	Panel	3	Ericsson KRY 112 144/1
148.00	Panel	3	Ericsson AIR 21, 1.3M, B4A B2P
148.00	Panel	3	Ericsson AIR 21, 1.3M, B2A B4P
148.00	Mounting Frame	3	Round Sector Frame
125.00	Panel	2	Motorola PTP54600
104.00	Straight Arm	2	Side Arms
104.00	Whip	2	2" x 8" GPS
79.00	Whip	1	10' Omni
76.00	Straight Arm	1	Side Arm
76.00	Panel	1	PCTEL GPS-TMG-HR-26N

Linear Appurtenance

Elev (ft)		Qty	Description
From	To		
8.000	194.00	2	Wave Guide
8.000	194.00	6	5/16" Coax
8.000	194.00	1	2" Conduit
8.000	194.00	2	1/2" Coax

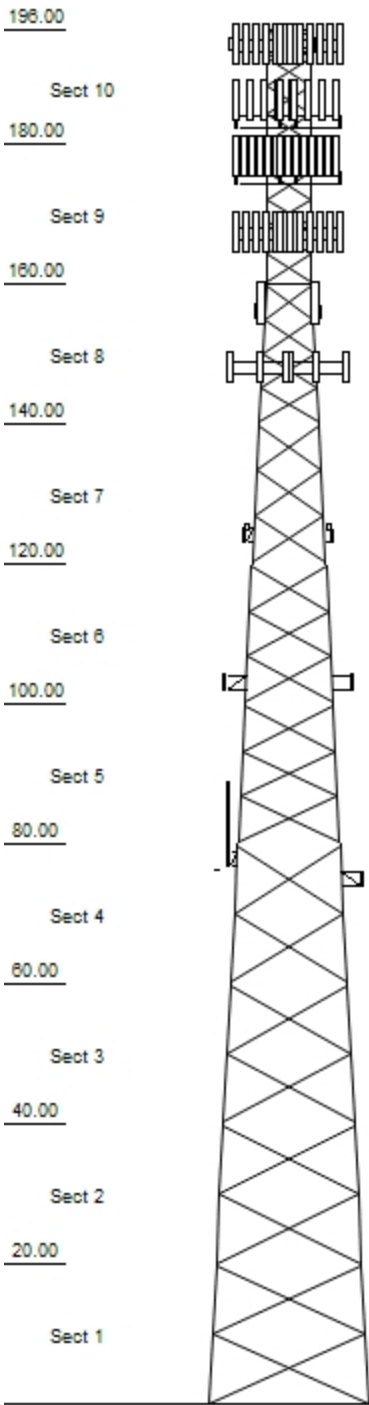

© 2007 - 2014 by ATC IP LLC. All rights reserved.

Job Information

Tower : 302470 Location : Ansonia Wakelee, CT
 Code : ANSI/TIA-222 Rev G Shape : Triangle Base Width : 23.00 ft
 Client : Verizon Wireless Top Width : 6.65 ft

8.000	194.00	6	1 5/8" Coax
8.000	194.00	10	1 1/4" Coax
5.000	194.00	1	Climbing Ladder
8.000	183.00	1	Wave Guide
8.000	183.00	1	1 1/4" Hybriflex
8.000	183.00	3	1 1/4" Hybriflex
8.000	175.00	6	1 5/8" Coax
8.000	175.00	6	1 5/8" Coax
8.000	167.00	1	Wave Guide
8.000	167.00	1	3" Conduit
8.000	167.00	12	1 5/8" Coax
8.000	167.00	2	0.78" 8 AWG 6
8.000	167.00	1	0.39" Cable
8.000	157.00	1	Waveguide
8.000	157.00	6	1 5/8" Coax
8.000	148.00	1	Wave Guide
8.000	148.00	12	1 5/8" Coax
8.000	148.00	1	1 1/4" Hybriflex
8.000	125.00	2	1/4" Coax
8.000	104.00	2	1/2" Coax
8.000	79.000	1	1/2" Coax
8.000	76.000	1	1/2" Coax

Uplift 345.82 k Moment 7,498.13 k Moment Ice 2,140.99 k-ft
 Vert 395.84 k Tot Down 61.20 k Tot Down Ice 169.81 k
 Horiz 40.24 k Tot Shear 65.90 k Tot Shear Ice 19.21 k

Site Number : 302470
Location : Ansonia Wakelee, CT
Code : ANSI/TIA-222 Rev G
Struct Class : II
Exposure : B
Topo : 1

© 2007 - 2014 by ATC IP LLC. All rights reserved.

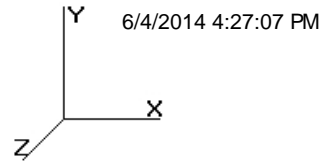

Section Forces

LoadCase 1.2D + 1.6W Normal

105.00 mph Normal to Face with No Ic

Gust Response Factor : 0.85
Dead Load Factor : 1.20
Wind Load Factor : 1.60

Wind Importance Factor : 1.00

Sect Seq	Wind Height (ft)	Wind qz (psf)	Total Area			Ice Sol Ratio	Cf	Df	Dr	Ice Thick (in)	Eff Area (sqft)	Linear Area (sqft)	Ice Linear Area (sqft)	Total Weight (lb)	Weight Ice (lb)	Struct Force (lb)	Linear Force (lb)	Total Force (lb)
			Flat (sqft)	Round (sqft)	Round (sqft)													
10	188.0	28.39	9.82	7.67	0.00	0.16	2.74	1.00	1.00	0.00	14.18	29.14	0.00	1,421.5	0.0	1,501.15	1,037.3	2,538.51
9	170.0	27.59	12.47	11.67	0.00	0.17	2.69	1.00	1.00	0.00	17.49	85.56	0.00	2,788.9	0.0	1,766.70	2,300.8	4,067.56
8	150.0	26.62	12.83	15.03	0.00	0.17	2.70	1.00	1.00	0.00	19.28	142.16	0.00	4,137.1	0.0	1,883.38	3,690.3	5,573.75
7	130.0	25.55	14.16	18.57	0.00	0.16	2.74	1.00	1.00	0.00	22.02	159.84	0.00	4,982.2	0.0	2,096.22	3,942.6	6,038.84
6	110.0	24.36	16.35	18.58	0.00	0.14	2.80	1.00	1.00	0.00	24.05	160.70	0.00	5,141.0	0.0	2,233.19	3,779.4	6,012.61
5	90.00	23.01	22.17	22.12	0.00	0.15	2.76	1.00	1.00	0.00	31.47	160.70	0.00	5,718.4	0.0	2,716.49	3,568.8	6,285.32
4	70.00	21.41	21.08	22.12	0.00	0.13	2.84	1.00	1.00	0.00	30.14	162.54	0.00	6,070.9	0.0	2,493.12	3,360.0	5,853.19
3	50.00	19.45	22.98	28.80	0.00	0.14	2.81	1.00	1.00	0.00	34.88	162.80	0.00	6,546.8	0.0	2,595.59	3,057.0	5,652.68
2	30.00	16.81	28.71	28.80	0.00	0.14	2.81	1.00	1.00	0.00	40.61	162.80	0.00	6,955.7	0.0	2,611.27	2,641.9	5,253.21
1	10.00	16.79	31.13	28.80	0.00	0.13	2.84	1.00	1.00	0.00	42.93	98.18	0.00	6,914.9	0.0	2,783.75	1,597.5	4,381.28
														50,677.4	0.0			51,656.95

LoadCase 1.2D + 1.6W 60 deg

105.00 mph 60 deg with No Ic

Gust Response Factor : 0.85
Dead Load Factor : 1.20
Wind Load Factor : 1.60

Wind Importance Factor : 1.00

Sect Seq	Wind Height (ft)	Wind qz (psf)	Total Area			Ice Sol Ratio	Cf	Df	Dr	Ice Thick (in)	Eff Area (sqft)	Linear Area (sqft)	Ice Linear Area (sqft)	Total Weight (lb)	Weight Ice (lb)	Struct Force (lb)	Linear Force (lb)	Total Force (lb)
			Flat (sqft)	Round (sqft)	Round (sqft)													
10	188.0	28.39	9.82	7.67	0.00	0.16	2.74	0.80	1.00	0.00	12.22	29.14	0.00	1,421.5	0.0	1,293.19	1,037.3	2,330.55
9	170.0	27.59	12.47	11.67	0.00	0.17	2.69	0.80	1.00	0.00	15.00	85.56	0.00	2,788.9	0.0	1,514.76	2,300.8	3,815.62
8	150.0	26.62	12.83	15.03	0.00	0.17	2.70	0.80	1.00	0.00	16.72	142.16	0.00	4,137.1	0.0	1,632.73	3,690.3	5,323.11
7	130.0	25.55	14.16	18.57	0.00	0.16	2.74	0.80	1.00	0.00	19.19	159.84	0.00	4,982.2	0.0	1,826.65	3,942.6	5,769.27
6	110.0	24.36	16.35	18.58	0.00	0.14	2.80	0.80	1.00	0.00	20.78	160.70	0.00	5,141.0	0.0	1,929.55	3,779.4	5,708.98
5	90.00	23.01	22.17	22.12	0.00	0.15	2.76	0.80	1.00	0.00	27.04	160.70	0.00	5,718.4	0.0	2,333.73	3,568.8	5,902.56
4	70.00	21.41	21.08	22.12	0.00	0.13	2.84	0.80	1.00	0.00	25.93	162.54	0.00	6,070.9	0.0	2,144.37	3,360.0	5,504.44
3	50.00	19.45	22.98	28.80	0.00	0.14	2.81	0.80	1.00	0.00	30.29	162.80	0.00	6,546.8	0.0	2,253.54	3,057.0	5,310.63
2	30.00	16.81	28.71	28.80	0.00	0.14	2.81	0.80	1.00	0.00	34.87	162.80	0.00	6,955.7	0.0	2,242.01	2,641.9	4,883.95
1	10.00	16.79	31.13	28.80	0.00	0.13	2.84	0.80	1.00	0.00	36.70	98.18	0.00	6,914.9	0.0	2,380.02	1,597.5	3,977.55
														50,677.4	0.0			48,526.66

LoadCase 1.2D + 1.6W 90 deg

105.00 mph 90 deg with No Ic

Gust Response Factor : 0.85
Dead Load Factor : 1.20
Wind Load Factor : 1.60

Wind Importance Factor : 1.00

Sect Seq	Wind Height (ft)	Wind qz (psf)	Total Area			Ice Sol Ratio	Cf	Df	Dr	Ice Thick (in)	Eff Area (sqft)	Linear Area (sqft)	Ice Linear Area (sqft)	Total Weight (lb)	Weight Ice (lb)	Struct Force (lb)	Linear Force (lb)	Total Force (lb)
			Flat (sqft)	Round (sqft)	Round (sqft)													
10	188.0	28.39	9.82	7.67	0.00	0.16	2.74	0.85	1.00	0.00	12.71	29.14	0.00	1,421.5	0.0	1,345.18	1,037.3	2,382.54

Site Number : 302470
 Location : Ansonia Wakelee, CT
 Code : ANSI/TIA-222 Rev G
 Struct Class : II
 Exposure : B
 Topo : 1

© 2007 - 2014 by ATC IP LLC. All rights reserved.

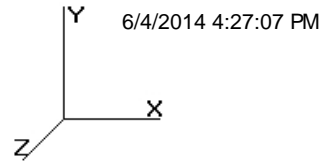

Section Forces

9	170.0	27.59	12.47	11.67	0.00	0.17	2.69	0.85	1.00	0.00	15.62	85.56	0.00	2,788.9	0.0	1,577.75	2,300.8	3,878.60
8	150.0	26.62	12.83	15.03	0.00	0.17	2.70	0.85	1.00	0.00	17.36	142.16	0.00	4,137.1	0.0	1,695.39	3,690.3	5,385.77
7	130.0	25.55	14.16	18.57	0.00	0.16	2.74	0.85	1.00	0.00	19.90	159.84	0.00	4,982.2	0.0	1,894.05	3,942.6	5,836.66
6	110.0	24.36	16.35	18.58	0.00	0.14	2.80	0.85	1.00	0.00	21.59	160.70	0.00	5,141.0	0.0	2,005.46	3,779.4	5,784.89
5	90.00	23.01	22.17	22.12	0.00	0.15	2.76	0.85	1.00	0.00	28.14	160.70	0.00	5,718.4	0.0	2,429.42	3,568.8	5,998.25
4	70.00	21.41	21.08	22.12	0.00	0.13	2.84	0.85	1.00	0.00	26.98	162.54	0.00	6,070.9	0.0	2,231.56	3,360.0	5,591.63
3	50.00	19.45	22.98	28.80	0.00	0.14	2.81	0.85	1.00	0.00	31.44	162.80	0.00	6,546.8	0.0	2,339.05	3,057.0	5,396.15
2	30.00	16.81	28.71	28.80	0.00	0.14	2.81	0.85	1.00	0.00	36.30	162.80	0.00	6,955.7	0.0	2,334.33	2,641.9	4,976.27
1	10.00	16.79	31.13	28.80	0.00	0.13	2.84	0.85	1.00	0.00	38.26	98.18	0.00	6,914.9	0.0	2,480.95	1,597.5	4,078.48
														50,677.4	0.0	49,309.23		

LoadCase 0.9D + 1.6W Normal

105.00 mph Normal to Face with No Ice (Reduced DL)

Gust Response Factor : 0.85
 Dead Load Factor : 0.90
 Wind Load Factor : 1.60

Wind Importance Factor : 1.00

Wind Sect Seq	Height (ft)	qz (psf)	Total Flat Area (sqft)	Total Round Area (sqft)	Ice Round Area (sqft)	Sol Ratio	Cf	Df	Dr	Ice Thick (in)	Eff Area (sqft)	Linear Area (sqft)	Ice Linear Area (sqft)	Total Weight (lb)	Weight Ice (lb)	Struct Force (lb)	Linear Force (lb)	Total Force (lb)
10	188.0	28.39	9.82	7.67	0.00	0.16	2.74	1.00	1.00	0.00	14.18	29.14	0.00	1,066.1	0.0	1,501.15	1,037.3	2,538.51
9	170.0	27.59	12.47	11.67	0.00	0.17	2.69	1.00	1.00	0.00	17.49	85.56	0.00	2,091.7	0.0	1,766.70	2,300.8	4,067.56
8	150.0	26.62	12.83	15.03	0.00	0.17	2.70	1.00	1.00	0.00	19.28	142.16	0.00	3,102.8	0.0	1,883.38	3,690.3	5,573.75
7	130.0	25.55	14.16	18.57	0.00	0.16	2.74	1.00	1.00	0.00	22.02	159.84	0.00	3,736.7	0.0	2,096.22	3,942.6	6,038.84
6	110.0	24.36	16.35	18.58	0.00	0.14	2.80	1.00	1.00	0.00	24.05	160.70	0.00	3,855.7	0.0	2,233.19	3,779.4	6,012.61
5	90.00	23.01	22.17	22.12	0.00	0.15	2.76	1.00	1.00	0.00	31.47	160.70	0.00	4,288.8	0.0	2,716.49	3,568.8	6,285.32
4	70.00	21.41	21.08	22.12	0.00	0.13	2.84	1.00	1.00	0.00	30.14	162.54	0.00	4,553.2	0.0	2,493.12	3,360.0	5,853.19
3	50.00	19.45	22.98	28.80	0.00	0.14	2.81	1.00	1.00	0.00	34.88	162.80	0.00	4,910.1	0.0	2,595.59	3,057.0	5,652.68
2	30.00	16.81	28.71	28.80	0.00	0.14	2.81	1.00	1.00	0.00	40.61	162.80	0.00	5,216.8	0.0	2,611.27	2,641.9	5,253.21
1	10.00	16.79	31.13	28.80	0.00	0.13	2.84	1.00	1.00	0.00	42.93	98.18	0.00	5,186.1	0.0	2,783.75	1,597.5	4,381.28
														38,008.1	0.0	51,656.95		

LoadCase 0.9D + 1.6W 60 deg

105.00 mph 60 deg with No Ice (Reduced DL)

Gust Response Factor : 0.85
 Dead Load Factor : 0.90
 Wind Load Factor : 1.60

Wind Importance Factor : 1.00

Wind Sect Seq	Height (ft)	qz (psf)	Total Flat Area (sqft)	Total Round Area (sqft)	Ice Round Area (sqft)	Sol Ratio	Cf	Df	Dr	Ice Thick (in)	Eff Area (sqft)	Linear Area (sqft)	Ice Linear Area (sqft)	Total Weight (lb)	Weight Ice (lb)	Struct Force (lb)	Linear Force (lb)	Total Force (lb)
10	188.0	28.39	9.82	7.67	0.00	0.16	2.74	0.80	1.00	0.00	12.22	29.14	0.00	1,066.1	0.0	1,293.19	1,037.3	2,330.55
9	170.0	27.59	12.47	11.67	0.00	0.17	2.69	0.80	1.00	0.00	15.00	85.56	0.00	2,091.7	0.0	1,514.76	2,300.8	3,815.62
8	150.0	26.62	12.83	15.03	0.00	0.17	2.70	0.80	1.00	0.00	16.72	142.16	0.00	3,102.8	0.0	1,632.73	3,690.3	5,323.11
7	130.0	25.55	14.16	18.57	0.00	0.16	2.74	0.80	1.00	0.00	19.19	159.84	0.00	3,736.7	0.0	1,826.65	3,942.6	5,769.27
6	110.0	24.36	16.35	18.58	0.00	0.14	2.80	0.80	1.00	0.00	20.78	160.70	0.00	3,855.7	0.0	1,929.55	3,779.4	5,708.98
5	90.00	23.01	22.17	22.12	0.00	0.15	2.76	0.80	1.00	0.00	27.04	160.70	0.00	4,288.8	0.0	2,333.73	3,568.8	5,902.56
4	70.00	21.41	21.08	22.12	0.00	0.13	2.84	0.80	1.00	0.00	25.93	162.54	0.00	4,553.2	0.0	2,144.37	3,360.0	5,504.44
3	50.00	19.45	22.98	28.80	0.00	0.14	2.81	0.80	1.00	0.00	30.29	162.80	0.00	4,910.1	0.0	2,253.54	3,057.0	5,310.63
2	30.00	16.81	28.71	28.80	0.00	0.14	2.81	0.80	1.00	0.00	34.87	162.80	0.00	5,216.8	0.0	2,242.01	2,641.9	4,883.95
1	10.00	16.79	31.13	28.80	0.00	0.13	2.84	0.80	1.00	0.00	36.70	98.18	0.00	5,186.1	0.0	2,380.02	1,597.5	3,977.55
														38,008.1	0.0	48,526.66		

Site Number : 302470
 Location : Ansonia Wakelee, CT
 Code : ANSI/TIA-222 Rev G
 Struct Class : II
 Exposure : B
 Topo : 1

© 2007 - 2014 by ATC IP LLC. All rights reserved.

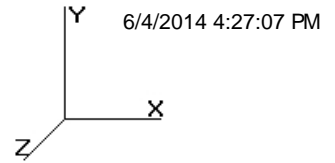

Section Forces

LoadCase 0.9D + 1.6W 90 deg

105.00 mph 90 deg with No Ice (Reduced DL)

Gust Response Factor : 0.85
 Dead Load Factor : 0.90
 Wind Load Factor : 1.60

Wind Importance Factor : 1.00

Sect Seq	Height (ft)	Wind qz (psf)	Total Area (sqft)			Sol Ratio	Cf	Df	Dr	Ice Thick (in)	Eff Area (sqft)	Ice Linear Area (sqft)		Total Weight (lb)	Ice Weight (lb)	Struct Force (lb)	Linear Force (lb)	Total Force (lb)
			Flat	Round	Ice Round							Linear	Linear					
10	188.0	28.39	9.82	7.67	0.00	0.16	2.74	0.85	1.00	0.00	12.71	29.14	0.00	1,066.1	0.0	1,345.18	1,037.3	2,382.54
9	170.0	27.59	12.47	11.67	0.00	0.17	2.69	0.85	1.00	0.00	15.62	85.56	0.00	2,091.7	0.0	1,577.75	2,300.8	3,878.60
8	150.0	26.62	12.83	15.03	0.00	0.17	2.70	0.85	1.00	0.00	17.36	142.16	0.00	3,102.8	0.0	1,695.39	3,690.3	5,385.77
7	130.0	25.55	14.16	18.57	0.00	0.16	2.74	0.85	1.00	0.00	19.90	159.84	0.00	3,736.7	0.0	1,894.05	3,942.6	5,836.66
6	110.0	24.36	16.35	18.58	0.00	0.14	2.80	0.85	1.00	0.00	21.59	160.70	0.00	3,855.7	0.0	2,005.46	3,779.4	5,784.89
5	90.00	23.01	22.17	22.12	0.00	0.15	2.76	0.85	1.00	0.00	28.14	160.70	0.00	4,288.8	0.0	2,429.42	3,568.8	5,998.25
4	70.00	21.41	21.08	22.12	0.00	0.13	2.84	0.85	1.00	0.00	26.98	162.54	0.00	4,553.2	0.0	2,231.56	3,360.0	5,591.63
3	50.00	19.45	22.98	28.80	0.00	0.14	2.81	0.85	1.00	0.00	31.44	162.80	0.00	4,910.1	0.0	2,339.05	3,057.0	5,396.15
2	30.00	16.81	28.71	28.80	0.00	0.14	2.81	0.85	1.00	0.00	36.30	162.80	0.00	5,216.8	0.0	2,334.33	2,641.9	4,976.27
1	10.00	16.79	31.13	28.80	0.00	0.13	2.84	0.85	1.00	0.00	38.26	98.18	0.00	5,186.1	0.0	2,480.95	1,597.5	4,078.48
														38,008.1	0.0			49,309.23

LoadCase 1.2D + 1.0Di + 1.0Wi Normal

105.00 mph Normal with 0.75 in Radial Ic

Gust Response Factor : 0.85
 Dead Load Factor : 1.20
 Wind Load Factor : 1.00

Ice Dead Load Factor : 1.00

Wind Importance Factor : 1.00
 Ice Importance Factor : 1.00

Sect Seq	Height (ft)	Wind qz (psf)	Total Area (sqft)			Sol Ratio	Cf	Df	Dr	Ice Thick (in)	Eff Area (sqft)	Ice Linear Area (sqft)		Total Weight (lb)	Ice Weight (lb)	Struct Force (lb)	Linear Force (lb)	Total Force (lb)
			Flat	Round	Ice Round							Linear	Linear					
10	188.0	6.44	7.86	30.08	29.93	0.33	2.22	1.00	1.00	1.79	30.73	46.69	41.06	4,983.9	3,562.5	373.67	323.21	696.88
9	170.0	6.26	9.98	37.08	34.68	0.32	2.24	1.00	1.00	1.77	38.06	117.07	147.05	10,006.8	7,217.9	453.30	866.34	1,319.65
8	150.0	6.04	12.83	50.06	35.03	0.37	2.12	1.00	1.00	1.75	44.09	186.66	226.93	14,332.4	10,195.	480.26	1,318.5	1,798.79
7	130.0	5.79	14.16	50.35	31.78	0.30	2.28	1.00	1.00	1.72	44.39	211.45	235.47	15,883.8	10,901.	499.25	1,472.4	1,971.74
6	110.0	5.52	16.35	52.79	34.21	0.27	2.37	1.00	1.00	1.69	47.56	211.46	242.62	16,237.3	11,096.	528.76	1,470.6	1,999.44
5	90.00	5.22	22.17	58.62	36.50	0.27	2.37	1.00	1.00	1.66	56.84	210.45	247.05	17,395.2	11,676.	596.25	1,405.7	2,001.98
4	70.00	4.86	21.08	53.00	30.88	0.22	2.52	1.00	1.00	1.62	51.75	211.05	250.86	17,306.1	11,235.	539.09	1,385.3	1,924.42
3	50.00	4.41	22.98	60.53	31.73	0.22	2.53	1.00	1.00	1.56	58.00	209.71	244.54	17,779.6	11,232.	549.65	1,239.7	1,789.42
2	30.00	3.81	28.71	60.76	31.96	0.21	2.55	1.00	1.00	1.49	63.77	207.37	233.38	18,006.9	11,051.	527.18	1,045.2	1,572.43
1	10.00	3.81	31.13	59.05	30.25	0.20	2.61	1.00	1.00	1.33	65.01	122.81	126.73	14,352.0	7,437.1	548.74	600.21	1,148.96
														146,284.0	95,606.6			16,223.70

LoadCase 1.2D + 1.0Di + 1.0Wi 60 deg

105.00 mph 60 deg with 0.75 in Radial Ic

Gust Response Factor : 0.85
 Dead Load Factor : 1.20
 Wind Load Factor : 1.00

Ice Dead Load Factor : 1.00

Wind Importance Factor : 1.00
 Ice Importance Factor : 1.00

Sect Seq	Height (ft)	Wind qz (psf)	Total Area (sqft)			Sol Ratio	Cf	Df	Dr	Ice Thick (in)	Eff Area (sqft)	Ice Linear Area (sqft)		Total Weight (lb)	Ice Weight (lb)	Struct Force (lb)	Linear Force (lb)	Total Force (lb)
			Flat	Round	Ice Round							Linear	Linear					
10	188.0	6.44	7.86	30.08	29.93	0.33	2.22	0.80	1.00	1.79	29.16	46.69	41.06	4,983.9	3,562.5	354.57	323.21	677.77

Site Number : 302470
Location : Ansonia Wakelee, CT
Code : ANSI/TIA-222 Rev G
Struct Class : II
Exposure : B
Topo : 1

© 2007 - 2014 by ATC IP LLC. All rights reserved.

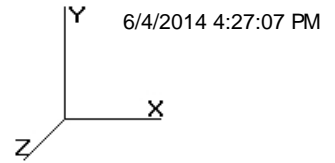

Section Forces

9	170.0	6.26	9.98	37.08	34.68	0.32	2.24	0.85	1.00	1.77	36.07	117.07	147.05	10,006.8	7,217.9	429.54	866.34	1,295.88	
8	150.0	6.04	12.83	50.06	35.03	0.37	2.12	0.85	1.00	1.75	41.52	186.66	226.93	14,332.4	10,195.	452.30	1,318.5	1,770.84	
7	130.0	5.79	14.16	50.35	31.78	0.30	2.28	0.85	1.00	1.72	41.56	211.45	235.47	15,883.8	10,901.	467.40	1,472.4	1,939.89	
6	110.0	5.52	16.35	52.79	34.21	0.27	2.37	0.85	1.00	1.69	44.29	211.46	242.62	16,237.3	11,096.	492.41	1,470.6	1,963.09	
5	90.00	5.22	22.17	58.62	36.50	0.27	2.37	0.85	1.00	1.66	52.40	210.45	247.05	17,395.2	11,676.	549.73	1,405.7	1,955.46	
4	70.00	4.86	21.08	53.00	30.88	0.22	2.52	0.85	1.00	1.62	47.54	211.05	250.86	17,306.1	11,235.	495.16	1,385.3	1,880.50	
3	50.00	4.41	22.98	60.53	31.73	0.22	2.53	0.85	1.00	1.56	53.40	209.71	244.54	17,779.6	11,232.	506.09	1,239.7	1,745.85	
2	30.00	3.81	28.71	60.76	31.96	0.21	2.55	0.85	1.00	1.49	58.03	207.37	233.38	18,006.9	11,051.	479.71	1,045.2	1,524.95	
1	10.00	3.81	31.13	59.05	30.25	0.20	2.61	0.85	1.00	1.33	58.79	122.81	126.73	14,352.0	7,437.1	496.19	600.21	1,096.41	
															146,284.0	95,606.6			15,850.65

LoadCase 1.2D + 1.0Di + 1.0Wi 90 deg

105.00 mph 90 deg with 0.75 in Radial Ic

Gust Response Factor : 0.85

Dead Load Factor : 1.20

Wind Importance Factor : 1.00

Wind Load Factor : 1.00

Ice Dead Load Factor : 1.00

Ice Importance Factor : 1.00

Wind Sect Seq	Height (ft)	qz (psf)	Total Flat Area (sqft)	Total Round Area (sqft)	Ice Round Area (sqft)	Sol Ratio	Cf	Df	Dr	Ice Thick (in)	Eff Area (sqft)	Linear Area (sqft)	Linear Area (sqft)	Total Weight (lb)	Weight Ice (lb)	Struct Force (lb)	Linear Force (lb)	Total Force (lb)	
10	188.0	6.44	7.86	30.08	29.93	0.33	2.22	0.85	1.00	1.79	29.56	46.69	41.06	4,983.9	3,562.5	359.34	323.21	682.55	
9	170.0	6.26	9.98	37.08	34.68	0.32	2.24	0.85	1.00	1.77	36.57	117.07	147.05	10,006.8	7,217.9	435.48	866.34	1,301.82	
8	150.0	6.04	12.83	50.06	35.03	0.37	2.12	0.85	1.00	1.75	42.17	186.66	226.93	14,332.4	10,195.	459.29	1,318.5	1,777.83	
7	130.0	5.79	14.16	50.35	31.78	0.30	2.28	0.85	1.00	1.72	42.27	211.45	235.47	15,883.8	10,901.	475.36	1,472.4	1,947.85	
6	110.0	5.52	16.35	52.79	34.21	0.27	2.37	0.85	1.00	1.69	45.11	211.46	242.62	16,237.3	11,096.	501.50	1,470.6	1,972.18	
5	90.00	5.22	22.17	58.62	36.50	0.27	2.37	0.85	1.00	1.66	53.51	210.45	247.05	17,395.2	11,676.	561.36	1,405.7	1,967.09	
4	70.00	4.86	21.08	53.00	30.88	0.22	2.52	0.85	1.00	1.62	48.59	211.05	250.86	17,306.1	11,235.	506.14	1,385.3	1,891.48	
3	50.00	4.41	22.98	60.53	31.73	0.22	2.53	0.85	1.00	1.56	54.55	209.71	244.54	17,779.6	11,232.	516.98	1,239.7	1,756.75	
2	30.00	3.81	28.71	60.76	31.96	0.21	2.55	0.85	1.00	1.49	59.46	207.37	233.38	18,006.9	11,051.	491.57	1,045.2	1,536.82	
1	10.00	3.81	31.13	59.05	30.25	0.20	2.61	0.85	1.00	1.33	60.35	122.81	126.73	14,352.0	7,437.1	509.33	600.21	1,109.54	
															146,284.0	95,606.6			15,943.91

LoadCase 1.0D + 1.0W Service Normal

Serviceability - 60.00 Wind Normal

Gust Response Factor : 0.85

Dead Load Factor : 1.00

Wind Importance Factor : 1.00

Wind Load Factor : 1.00

Wind Sect Seq	Height (ft)	qz (psf)	Total Flat Area (sqft)	Total Round Area (sqft)	Ice Round Area (sqft)	Sol Ratio	Cf	Df	Dr	Ice Thick (in)	Eff Area (sqft)	Linear Area (sqft)	Linear Area (sqft)	Total Weight (lb)	Weight Ice (lb)	Struct Force (lb)	Linear Force (lb)	Total Force (lb)	
10	188.0	9.27	9.82	7.67	0.00	0.16	2.74	1.00	1.00	0.00	14.18	29.14	0.00	1,184.5	0.0	306.36	211.71	518.06	
9	170.0	9.01	12.47	11.67	0.00	0.17	2.69	1.00	1.00	0.00	19.12	85.56	0.00	2,324.1	0.0	394.21	462.54	856.74	
8	150.0	8.69	12.83	15.03	0.00	0.17	2.70	1.00	1.00	0.00	21.40	142.16	0.00	3,447.6	0.0	426.46	732.87	1,159.32	
7	130.0	8.34	14.16	18.57	0.00	0.16	2.74	1.00	1.00	0.00	24.72	159.84	0.00	4,151.9	0.0	480.19	804.62	1,284.80	
6	110.0	7.96	16.35	18.58	0.00	0.14	2.80	1.00	1.00	0.00	26.88	160.70	0.00	4,284.1	0.0	509.37	771.31	1,280.68	
5	90.00	7.51	22.17	22.12	0.00	0.15	2.76	1.00	1.00	0.00	31.47	160.70	0.00	4,765.4	0.0	554.39	728.33	1,282.72	
4	70.00	6.99	21.08	22.12	0.00	0.13	2.84	1.00	1.00	0.00	33.60	162.54	0.00	5,059.1	0.0	567.18	685.73	1,252.91	
3	50.00	6.35	22.98	28.80	0.00	0.14	2.81	1.00	1.00	0.00	34.88	162.80	0.00	5,455.7	0.0	529.71	623.90	1,153.61	
2	30.00	5.49	28.71	28.80	0.00	0.14	2.81	1.00	1.00	0.00	40.61	162.80	0.00	5,796.4	0.0	532.91	539.17	1,072.08	
1	10.00	5.48	31.13	28.80	0.00	0.13	2.84	1.00	1.00	0.00	42.93	98.18	0.00	5,762.4	0.0	568.11	326.03	894.14	
															42,231.2	0.0			10,755.07

Site Number : 302470
 Location : Ansonia Wakelee, CT
 Code : ANSI/TIA-222 Rev G
 Struct Class : II
 Exposure : B
 Topo : 1

© 2007 - 2014 by ATC IP LLC. All rights reserved.

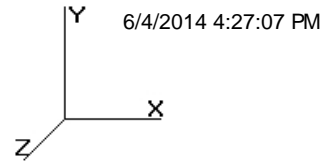

Section Forces

LoadCase 1.0D + 1.0W Service 60 deg

Serviceability - 60.00 Wind 60 deg

Gust Response Factor : 0.85
 Dead Load Factor : 1.00
 Wind Load Factor : 1.00

Wind Importance Factor : 1.00

Seq	Wind Sect	Height (ft)	qz (psf)	Total	Total	Ice	Sol Ratio	Cf	Df	Dr	Ice	Eff	Linear	Ice	Total Weight (lb)	Weight Ice (lb)	Struct Force (lb)	Linear Force (lb)	Total Force (lb)	
				Flat Area (sqft)	Round Area (sqft)	Round Area (sqft)					Thick (in)	Area (sqft)	Area (sqft)	Area (sqft)						
10	188.0	9.27	9.82	7.67	0.00	0.16	2.74	0.80	1.00	0.00	12.22	29.14	0.00	1,184.5	0.0	263.92	211.71	475.62		
9	170.0	9.01	12.47	11.67	0.00	0.17	2.69	0.80	1.00	0.00	16.63	85.56	0.00	2,324.1	0.0	342.79	462.54	805.33		
8	150.0	8.69	12.83	15.03	0.00	0.17	2.70	0.80	1.00	0.00	18.83	142.16	0.00	3,447.6	0.0	375.30	732.87	1,108.17		
7	130.0	8.34	14.16	18.57	0.00	0.16	2.74	0.80	1.00	0.00	21.89	159.84	0.00	4,151.9	0.0	425.18	804.62	1,229.79		
6	110.0	7.96	16.35	18.58	0.00	0.14	2.80	0.80	1.00	0.00	23.61	160.70	0.00	4,284.1	0.0	447.41	771.31	1,218.72		
5	90.00	7.51	22.17	22.12	0.00	0.15	2.76	0.80	1.00	0.00	27.04	160.70	0.00	4,765.4	0.0	476.27	728.33	1,204.60		
4	70.00	6.99	21.08	22.12	0.00	0.13	2.84	0.80	1.00	0.00	29.39	162.54	0.00	5,059.1	0.0	496.00	685.73	1,181.73		
3	50.00	6.35	22.98	28.80	0.00	0.14	2.81	0.80	1.00	0.00	30.29	162.80	0.00	5,455.7	0.0	459.91	623.90	1,083.80		
2	30.00	5.49	28.71	28.80	0.00	0.14	2.81	0.80	1.00	0.00	34.87	162.80	0.00	5,796.4	0.0	457.55	539.17	996.72		
1	10.00	5.48	31.13	28.80	0.00	0.13	2.84	0.80	1.00	0.00	36.70	98.18	0.00	5,762.4	0.0	485.72	326.03	811.74		
															42,231.2	0.0				10,116.24

LoadCase 1.0D + 1.0W Service 90 deg

Serviceability - 60.00 Wind 90 deg

Gust Response Factor : 0.85
 Dead Load Factor : 1.00
 Wind Load Factor : 1.00

Wind Importance Factor : 1.00

Seq	Wind Sect	Height (ft)	qz (psf)	Total	Total	Ice	Sol Ratio	Cf	Df	Dr	Ice	Eff	Linear	Ice	Total Weight (lb)	Weight Ice (lb)	Struct Force (lb)	Linear Force (lb)	Total Force (lb)	
				Flat Area (sqft)	Round Area (sqft)	Round Area (sqft)					Thick (in)	Area (sqft)	Area (sqft)	Area (sqft)						
10	188.0	9.27	9.82	7.67	0.00	0.16	2.74	0.85	1.00	0.00	12.71	29.14	0.00	1,184.5	0.0	274.53	211.71	486.23		
9	170.0	9.01	12.47	11.67	0.00	0.17	2.69	0.85	1.00	0.00	17.25	85.56	0.00	2,324.1	0.0	355.64	462.54	818.18		
8	150.0	8.69	12.83	15.03	0.00	0.17	2.70	0.85	1.00	0.00	19.47	142.16	0.00	3,447.6	0.0	388.09	732.87	1,120.96		
7	130.0	8.34	14.16	18.57	0.00	0.16	2.74	0.85	1.00	0.00	22.60	159.84	0.00	4,151.9	0.0	438.93	804.62	1,243.54		
6	110.0	7.96	16.35	18.58	0.00	0.14	2.80	0.85	1.00	0.00	24.42	160.70	0.00	4,284.1	0.0	462.90	771.31	1,234.21		
5	90.00	7.51	22.17	22.12	0.00	0.15	2.76	0.85	1.00	0.00	28.14	160.70	0.00	4,765.4	0.0	495.80	728.33	1,224.13		
4	70.00	6.99	21.08	22.12	0.00	0.13	2.84	0.85	1.00	0.00	30.44	162.54	0.00	5,059.1	0.0	513.80	685.73	1,199.53		
3	50.00	6.35	22.98	28.80	0.00	0.14	2.81	0.85	1.00	0.00	31.44	162.80	0.00	5,455.7	0.0	477.36	623.90	1,101.25		
2	30.00	5.49	28.71	28.80	0.00	0.14	2.81	0.85	1.00	0.00	36.30	162.80	0.00	5,796.4	0.0	476.39	539.17	1,015.56		
1	10.00	5.48	31.13	28.80	0.00	0.13	2.84	0.85	1.00	0.00	38.26	98.18	0.00	5,762.4	0.0	506.32	326.03	832.34		
															42,231.2	0.0				10,275.95

Site Number: 302470
 Location: Ansonia Wakelee, CT
 Code: ANSI/TIA-222 Rev G
 Struct Class : II
 Exposure : B
 Topo : 1

© 2007 - 2014 by ATC IP LLC. All rights reserved.

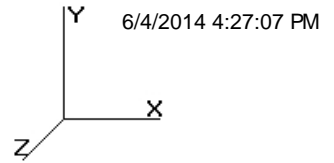

Tower Loading

Discrete Appurtenance Properties

Attach Elev (ft)	Description	Qty	No Ice		Ice		Len (ft)	Width (in)	Depth (in)	Ka	Orientation Factor	Vert Ecc (ft)
			Weight (lb)	CaAa (sf)	Weight (lb)	CaAa (sf)						
194.0	Argus LLPX310R	3	28.60	4.290	38.81	5.822	3.500	11.80	4.500	0.80	0.73	0.000
194.0	DragonWave A-ANT-18G-2-C	2	27.10	4.690	127.12	6.364	2.170	0.000	0.000	0.80	0.95	0.000
194.0	NextNet BTS-2500	3	35.00	1.820	47.50	2.470	1.583	11.30	5.100	0.80	0.50	0.000
194.0	DragonWave Horizon	2	10.60	0.430	14.38	0.584	0.392	9.300	9.300	0.80	0.50	0.000
194.0	KMW TTA (HB-X-WM-17-65-	3	15.90	0.650	21.58	0.882	1.325	7.300	3.700	0.80	0.50	0.000
194.0	Round Sector Frames	3	300.00	14.400	677.01	31.365	0.000	0.000	0.000	0.75	0.75	0.000
194.0	72" x 12" Panels	3	40.00	8.130	54.28	11.033	6.000	12.00	6.000	0.80	0.67	0.000
194.0	48" x 12" Panels	9	30.00	5.070	40.71	6.880	4.000	12.00	6.000	0.80	0.67	0.000
183.0	RFS APXV9TM14-ALU-I20	3	52.90	6.340	194.02	8.572	4.690	12.60	6.300	0.80	0.78	2.000
183.0	Alcatel-Lucent TD-RRH8x20-	3	60.00	4.050	141.10	5.791	3.080	11.00	5.000	0.80	0.67	2.000
183.0	Powerwave P40-16-XLPP-	2	64.00	9.070	279.33	10.346	4.500	20.00	6.500	0.80	0.69	2.000
183.0	RFS APXVSP18-C-A20	1	57.00	8.020	262.15	9.346	6.000	11.80	7.000	0.80	0.83	2.000
183.0	Alcatel-Lucent 800 MHz RRH	3	53.00	2.130	142.87	2.761	1.640	13.00	10.80	0.80	0.67	2.000
183.0	Alcatel-Lucent 1900 MHz	3	60.00	2.320	157.84	3.010	2.090	11.10	10.70	0.80	0.67	2.000
183.0	Round Sector Frames	3	300.00	14.400	621.31	24.682	0.000	0.000	0.000	0.75	0.75	0.000
175.0	Swedcom SLCP 2x6014	1	20.00	6.480	222.54	7.595	4.420	14.00	11.00	0.80	1.00	2.000
175.0	Antel BXA-70063-6BF-EDIN-X	1	19.20	7.260	191.62	8.517	5.720	11.20	5.300	0.80	1.00	2.000
175.0	Rymasa MGD3-800TX	3	15.40	3.340	20.84	4.521	4.530	6.300	3.500	0.80	0.82	2.000
175.0	Powerwave P65-16-XL-2	1	33.00	8.130	217.53	9.447	6.000	12.00	5.000	0.80	1.00	2.000
175.0	Flat Light Sector Frames	3	400.00	17.900	705.37	33.210	0.000	0.000	0.000	0.75	0.75	0.000
175.0	RFS FD9R6004/2C-3L	12	3.10	0.370	16.54	0.586	0.483	6.500	1.500	0.80	0.50	2.000
175.0	Antel BXA-80080/4CF	3	14.30	4.800	143.95	5.773	4.010	11.20	5.900	0.80	0.80	2.000
175.0	Antel BXA-171063-8CF-EDIN-X	3	10.50	2.940	95.19	3.819	4.040	6.100	4.100	0.80	0.87	2.000
167.0	72" x 12" Panel	9	45.00	8.130	239.56	9.447	6.000	12.00	6.000	0.80	0.79	0.000
167.0	36" x 8" x 6" Panel	3	25.00	2.580	109.90	3.323	3.000	8.000	6.000	0.80	0.89	0.000
167.0	Ericsson RRUS 11	6	55.00	2.520	136.67	3.174	1.480	17.00	7.200	0.80	0.67	0.000
167.0	Raycap DC6-48-60-18-8F	1	31.80	1.280	126.19	2.862	2.000	11.00	11.00	0.80	1.00	0.000
167.0	Round Sector Frames	3	300.00	14.400	618.10	24.579	0.000	0.000	0.000	0.75	0.75	0.000
167.0	14" x 9" TTA	9	10.00	1.050	13.53	1.198	1.167	9.000	6.000	0.80	0.50	0.000
157.0	Kathrein 742 213	3	22.00	5.140	134.99	6.407	6.370	6.100	2.700	1.00	0.78	0.000
148.0	Ericsson KRY 112 144/1	3	11.00	0.410	27.39	0.635	0.580	6.100	2.700	0.80	0.50	0.000
148.0	Ericsson AIR 21, 1.3M, B4A	3	81.50	6.090	250.49	7.193	4.670	12.10	7.900	0.80	0.85	0.000
148.0	Ericsson AIR 21, 1.3M, B2A	3	83.00	6.050	252.04	7.148	4.670	12.00	8.000	0.80	0.86	0.000
148.0	Round Sector Frame	3	300.00	14.400	668.59	30.986	0.000	0.000	0.000	0.75	0.75	0.000
125.0	Motorola PTP54600	2	12.10	1.750	16.26	2.352	1.210	14.50	3.800	1.00	0.64	0.000
104.0	Side Arms	2	200.00	2.000	267.68	2.271	0.000	0.000	0.000	1.00	0.85	0.000
104.0	2" x 8" GPS	2	0.26	0.160	0.40	0.532	0.670	2.000	2.000	0.90	1.00	0.000
79.00	10' Omni	1	25.00	3.760	33.09	4.976	10.00	3.000	3.000	1.00	1.00	5.000
76.00	Side Arm	1	200.00	2.000	264.69	2.259	0.000	0.000	0.000	1.00	1.00	0.000
76.00	PCTEL GPS-TMG-HR-26N	1	0.60	0.090	9.99	0.313	0.417	3.200	3.200	1.00	1.00	0.000
Totals		128	8771.22		21770.36					Number of Appurtenances : 40		

Linear Appurtenance Properties

Elev From (ft)	Elev To (ft)	Description	Qty	Width (in)	Weight (lb/ft)	Pct In Block	Spread On Faces	Bundling Arrangement	Cluster Dia (in)	Out Of Zone	Spacing (in)	Orientation Factor	Ka Override
5.00	194.0	Climbing Ladder	1	2.00	6.90	0	Lin App	Individual	0.00	N	1.00	1.00	0.00

Site Number: 302470
Location: Ansonia Wakelee, CT
Code: ANSI/TIA-222 Rev G
Struct Class: II
Exposure: B
Topo: 1

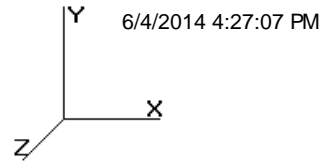

Tower Loading

8.00	194.0	1 1/4" Coax	10	1.55	0.63	70	3	Block	0.00	N	0.00	1.00	0.00
8.00	194.0	1 5/8" Coax	6	1.98	0.82	50	3	Block	0.00	N	0.00	1.00	0.00
8.00	194.0	1/2" Coax	2	0.63	0.15	0	2	Individual	0.00	N	1.00	1.00	0.00
8.00	194.0	2" Conduit	1	2.38	3.65	0	Lin App	Individual	0.00	N	1.00	1.00	0.00
8.00	194.0	5/16" Coax	6	0.00	0.04	0	2	Individual	0.00	N	0.00	1.00	0.01
8.00	194.0	Wave Guide	2	1.00	5.00	50	3	Block	0.00	N	0.00	1.00	0.00
8.00	183.0	1 1/4" Hybriflex	3	0.00	1.00	0	Lin App	Individual	0.00	N	0.00	1.00	0.00
8.00	183.0	1 1/4" Hybriflex	1	1.54	1.00	0	Lin App	Individual	0.00	N	1.00	1.00	0.00
8.00	183.0	Wave Guide	1	1.00	5.00	0	2	Individual	0.00	N	0.00	1.00	0.00
8.00	175.0	1 5/8" Coax	6	1.98	0.82	0	3	Individual	0.00	N	0.00	1.00	0.01
8.00	175.0	1 5/8" Coax	6	1.98	0.82	0	Lin App	Individual	0.00	N	1.00	1.00	0.00
8.00	167.0	0.39" Cable	1	0.39	0.07	0	Lin App	Individual	0.00	N	0.00	1.00	0.00
8.00	167.0	0.78" 8 AWG 6	2	0.78	0.59	0	Lin App	Individual	0.00	N	0.00	1.00	0.00
8.00	167.0	1 5/8" Coax	12	1.98	0.82	0	1	Cluster	12.25	N	0.00	1.00	0.00
8.00	167.0	3" Conduit	1	3.50	7.58	0	Lin App	Individual	0.00	N	1.00	1.00	0.00
8.00	167.0	Wave Guide	1	1.00	5.00	0	1	Individual	0.00	N	0.00	1.00	0.00
8.00	157.0	1 5/8" Coax	6	1.98	0.82	0	1	Individual	0.00	N	0.00	1.00	0.00
8.00	157.0	Waveguide	1	0.00	6.00	0	Lin App	Individual	0.00	N	1.00	1.00	0.00
8.00	148.0	1 1/4" Hybriflex	1	1.54	1.00	0	Lin App	Individual	0.00	N	1.00	1.00	0.01
8.00	148.0	1 5/8" Coax	12	1.98	0.82	50	3	Block	0.00	N	0.00	1.00	0.00
8.00	148.0	Wave Guide	1	1.00	5.00	0	3	Individual	0.00	N	0.00	1.00	0.00
8.00	125.0	1/4" Coax	2	0.34	0.06	0	1	Individual	0.00	N	0.00	1.00	0.00
8.00	104.0	1/2" Coax	2	0.00	0.15	0	3	Individual	0.00	N	0.00	1.00	0.00
8.00	79.00	1/2" Coax	1	0.63	0.15	0	1	Individual	0.00	N	0.00	1.00	0.00
8.00	76.00	1/2" Coax	1	0.63	0.15	0	2	Individual	0.00	N	0.00	1.00	0.00

Site Number: 302470
 Location: Ansonia Wakelee, CT
 Code: ANSI/TIA-222 Rev G
 Struct Class : II
 Exposure : B
 Topo : 1

© 2007 - 2014 by ATC IP LLC. All rights reserved.

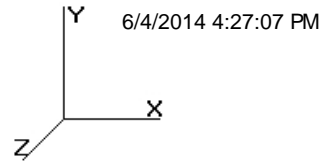

Force/Stress Summary

Section: 1		15N25		Bot Elev (ft): 0.00				Height (ft): 20.000							
		Force	Len	Bracing %			Fy	phi	Num	Num	Shear	Bear	Use		
Max Compression Member		(kip)	(ft)	X	Y	Z	(ksi)	Pn	Bolts	Holes	phiRnv	phiRn	%	Controls	
LEG	PX - 8" DIA PIPE	-388.19	9.77	100	100	100	50.0	510.32	0	0	0.00	0.00	76	Member X	
HORIZ		0.00	0.000	0	0	0	0.0	0.00	0	0	0.00	0.00	0		
DIAG	SAE - 4X4X0.25	-12.08	23.62	50	50	50	43.5	13.79	1	1	17.89	23.40	87	Member Z	
Max Tension Member		Force	Fy	Fu	phi	Pn	Num	Num	Shear	Bear	Use				
		(kip)	(ksi)	(ksi)	(kip)	Bolts	Holes	(kip)	(kip)	%	Controls				
LEG	PX - 8" DIA PIPE	347.68	50	65	576.00	0	0	0.00	0.00	60	Member				
HORIZ		0.00	0	0	0.00	0	0	0.00	0.00	0					
DIAG	SAE - 4X4X0.25	11.86	50	65	62.93	1	1	17.89	14.14	83	Bolt Bear				
Max Splice Forces		Force	Capacity	Use	Num										
		(kip)	(kip)	%	Bolts	Bolt Type									
Top Tension		317.07	0.00	0	0										
Top Compression		363.09	0.00	0											
Bot Tension		347.68	605.70	57	10	1" A354-BC									
Bot Compression		398.02	0.00	0											

Section: 2		14N46		Bot Elev (ft): 20.00				Height (ft): 20.000							
		Force	Len	Bracing %			Fy	phi	Num	Num	Shear	Bear	Use		
Max Compression Member		(kip)	(ft)	X	Y	Z	(ksi)	Pn	Bolts	Holes	phiRnv	phiRn	%	Controls	
LEG	PSP - ROHN 8 EHS	-351.85	9.77	100	100	100	50.0	388.80	0	0	0.00	0.00	90	Member X	
HORIZ		0.00	0.000	0	0	0	0.0	0.00	0	0	0.00	0.00	0		
DIAG	SAE - 4X4X0.25	-11.65	22.69	50	50	50	43.5	14.94	1	1	17.89	23.40	77	Member Z	
Max Tension Member		Force	Fy	Fu	phi	Pn	Num	Num	Shear	Bear	Use				
		(kip)	(ksi)	(ksi)	(kip)	Bolts	Holes	(kip)	(kip)	%	Controls				
LEG	PSP - ROHN 8 EHS	317.40	50	65	437.40	0	0	0.00	0.00	72	Member				
HORIZ		0.00	0	0	0.00	0	0	0.00	0.00	0					
DIAG	SAE - 4X4X0.25	11.45	50	65	62.93	1	1	17.89	14.14	81	Bolt Bear				
Max Splice Forces		Force	Capacity	Use	Num										
		(kip)	(kip)	%	Bolts	Bolt Type									
Top Tension		284.02	0.00	0	0										
Top Compression		324.33	0.00	0											
Bot Tension		317.07	436.16	73	8	1 A325									
Bot Compression		363.09	0.00	0											

Site Number: 302470
 Location: Ansonia Wakelee, CT
 Code: ANSI/TIA-222 Rev G
 Struct Class : II
 Exposure : B
 Topo : 1

© 2007 - 2014 by ATC IP LLC. All rights reserved.

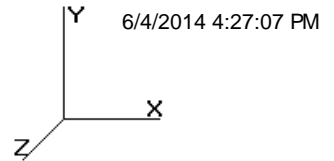

Force/Stress Summary

Section: 3 13N88 Bot Elev (ft): 40.00 Height (ft): 20.000

		Force	Len	Bracing %			Fy	phi	Num	Num	Shear	Bear	Use		
		(kip)	(ft)	X	Y	Z	(ksi)	Pn	Bolts	Holes	phiRnv	phiRn	%	Controls	
Max Compression Member															
LEG	PSP - ROHN 8 EHS	-313.60	9.77	100	100	100	40.1	50.0	388.78	0	0	0.00	0.00	80	Member X
HORIZ		0.00	0.000	0	0	0	0.0	0.0	0.00	0	0	0.00	0.00	0	
DIAG	SAE - 3.5X3.5X0.25	-10.52	20.87	50	50	50	180.5	42.0	11.72	1	1	17.89	23.40	89	Member Z
Max Tension Member															
LEG	PSP - ROHN 8 EHS	284.48	60	50	65	437.40	0	0	0.00	0	0.00	65	Member		
HORIZ		0.00	0	0	0	0.00	0	0	0.00	0	0.00	0			
DIAG	SAE - 3.5X3.5X0.25	10.36	90	50	65	53.79	1	1	17.89	14.14	73	Bolt Bear			
Max Splice Forces															
		Force	Capacity	Use	Num										
		(kip)	(kip)	%	Bolts	Bolt Type									
Top Tension		251.41	0.00	0	0										
Top Compression		286.15	0.00	0											
Bot Tension		284.02	436.16	65	8	1 A325									
Bot Compression		324.33	0.00	0											

Section: 4 12N50 Bot Elev (ft): 60.00 Height (ft): 20.000

		Force	Len	Bracing %			Fy	phi	Num	Num	Shear	Bear	Use		
		(kip)	(ft)	X	Y	Z	(ksi)	Pn	Bolts	Holes	phiRnv	phiRn	%	Controls	
Max Compression Member															
LEG	PX - 6" DIA PIPE	-274.86	9.77	100	100	100	53.4	50.0	306.88	0	0	0.00	0.00	89	Member X
HORIZ		0.00	0.000	0	0	0	0.0	0.0	0.00	0	0	0.00	0.00	0	
DIAG	SAE - 3.5X3.5X0.25	-10.29	19.04	50	50	50	164.6	42.0	14.08	1	1	17.89	23.40	73	Member Z
Max Tension Member															
LEG	PX - 6" DIA PIPE	251.76	60	50	65	378.00	0	0	0.00	0	0.00	66	Member		
HORIZ		0.00	0	0	0	0.00	0	0	0.00	0	0.00	0			
DIAG	SAE - 3.5X3.5X0.25	10.22	90	50	65	53.79	1	1	17.89	14.14	72	Bolt Bear			
Max Splice Forces															
		Force	Capacity	Use	Num										
		(kip)	(kip)	%	Bolts	Bolt Type									
Top Tension		215.99	0.00	0	0										
Top Compression		245.23	0.00	0											
Bot Tension		251.41	436.16	58	8	1 A325									
Bot Compression		286.15	0.00	0											

Site Number: 302470
 Location: Ansonia Wakelee, CT
 Code: ANSI/TIA-222 Rev G
 Struct Class: II
 Exposure: B
 Topo: 1

© 2007 - 2014 by ATC IP LLC. All rights reserved.

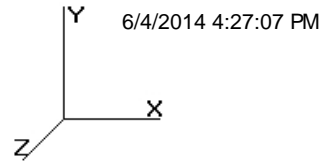

Force/Stress Summary

Section: 5 11N223 Bot Elev (ft): 80.00 Height (ft): 20.000

		Force	Len	Bracing %			Fy	phi	Num	Num	Shear	Bear	Use		
		(kip)	(ft)	X	Y	Z	(ksi)	Pn	Bolts	Holes	phiRnv	phiRn	%	Controls	
Max Compression Member															
LEG	PSP - ROHN 6 EHS	-236.60	6.51	100	100	100	35.1	50.0	275.92	0	0	0.00	0.00	85	Member X
HORIZ		0.00	0.000	0	0	0	0.0	0.0	0.00	0	0	0.00	0.00	0	
DIAG	SAE - 3X3X0.25	-9.37	15.90	50	50	50	161.2	50.0	12.52	1	1	17.89	23.40	74	Member Z
Max Tension Member															
LEG	PSP - ROHN 6 EHS	216.30	50	65	301.95	0	0	0.00	0.00	71	Member				
HORIZ		0.00	0	0	0.00	0	0	0.00	0.00	0					
DIAG	SAE - 3X3X0.25	9.22	50	65	44.65	1	1	17.89	14.14	65	Bolt Bear				
Max Splice Forces															
		Force	Capacity	Use	Num										
		(kip)	(kip)	%	Bolts	Bolt Type									
Top Tension		177.86	0.00	0	0										
Top Compression		201.88	0.00	0											
Bot Tension		215.99	327.12	66	6	1 A325									
Bot Compression		245.23	0.00	0											

Section: 6 10N152 Bot Elev (ft): 100.0 Height (ft): 20.000

		Force	Len	Bracing %			Fy	phi	Num	Num	Shear	Bear	Use		
		(kip)	(ft)	X	Y	Z	(ksi)	Pn	Bolts	Holes	phiRnv	phiRn	%	Controls	
Max Compression Member															
LEG	PX - 5" DIA PIPE	-193.91	6.51	100	100	100	42.5	50.0	240.98	0	0	0.00	0.00	80	Member X
HORIZ		0.00	0.000	0	0	0	0.0	0.0	0.00	0	0	0.00	0.00	0	
DIAG	SAE - 2.5X2.5X0.25	-7.98	14.13	50	50	50	172.8	36.0	9.01	1	1	12.43	17.40	88	Member Z
Max Tension Member															
LEG	PX - 5" DIA PIPE	176.25	50	65	274.95	0	0	0.00	0.00	64	Member				
HORIZ		0.00	0	0	0.00	0	0	0.00	0.00	0					
DIAG	SAE - 2.5X2.5X0.25	8.03	36	58	32.71	1	1	12.43	10.44	76	Bolt Bear				
Max Splice Forces															
		Force	Capacity	Use	Num										
		(kip)	(kip)	%	Bolts	Bolt Type									
Top Tension		140.46	0.00	0	0										
Top Compression		159.78	0.00	0											
Bot Tension		177.86	327.12	54	6	1 A325									
Bot Compression		201.88	0.00	0											

Site Number: 302470
 Location: Ansonia Wakelee, CT
 Code: ANSI/TIA-222 Rev G
 Struct Class: II
 Exposure: B
 Topo: 1

© 2007 - 2014 by ATC IP LLC. All rights reserved.

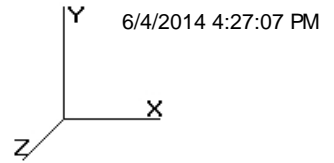

Force/Stress Summary

Section: 7		9N216		Bot Elev (ft): 120.0				Height (ft): 20.000							
		Force	Len	Bracing %			Fy	phi	Num	Num	Shear	Bear	Use		
Max Compression Member		(kip)	(ft)	X	Y	Z	(ksi)	(kip)	Bolts	Holes	(kip)	(kip)	%	Controls	
LEG	PX - 5" DIA PIPE	-151.10	6.51	100	100	100	42.5	50.0	240.99	0	0	0.00	0.00	62	Member X
HORIZ		0.00	0.000	0	0	0	0.0	0.0	0.00	0	0	0.00	0.00	0	
DIAG	SAE - 2.5X2.5X0.25	-7.71	12.33	50	50	50	150.7	36.0	11.83	1	1	12.43	17.40	65	Member Z
Max Tension Member		Force	Fy	Fu	phi	Pn	Num	Num	Shear	Bear	Use				
		(kip)	(ksi)	(ksi)	(kip)	Bolts	Holes	(kip)	(kip)	%	Controls				
LEG	PX - 5" DIA PIPE	140.66	50	65	274.95	0	0	0.00	0.00	51	Member				
HORIZ		0.00	0	0	0.00	0	0	0.00	0.00	0					
DIAG	SAE - 2.5X2.5X0.25	7.87	36	58	32.71	1	1	12.43	10.44	75	Bolt Bear				
Max Splice Forces		Force	Capacity	Use	Num										
		(kip)	(kip)	%	Bolts	Bolt Type									
Top Tension		98.45	0.00	0	0										
Top Compression		113.60	0.00	0											
Bot Tension		140.46	218.08	64	4	1 A325									
Bot Compression		159.78	0.00	0											

Section: 8		A780252		Bot Elev (ft): 140.0				Height (ft): 20.000							
		Force	Len	Bracing %			Fy	phi	Num	Num	Shear	Bear	Use		
Max Compression Member		(kip)	(ft)	X	Y	Z	(ksi)	(kip)	Bolts	Holes	(kip)	(kip)	%	Controls	
LEG	PX - 4" DIA PIPE	-106.92	4.88	100	100	100	39.6	50.0	176.95	0	0	0.00	0.00	60	Member X
HORIZ		-0.35	6.760	100	100	100	203.8	36.0	2.61	1	1	12.43	8.70	13	Member Z
DIAG	SAE - 2X2X0.25	-6.52	9.847	50	50	50	151.1	36.0	9.30	1	1	12.43	17.40	70	Member Z
Max Tension Member		Force	Fy	Fu	phi	Pn	Num	Num	Shear	Bear	Use				
		(kip)	(ksi)	(ksi)	(kip)	Bolts	Holes	(kip)	(kip)	%	Controls				
LEG	PX - 4" DIA PIPE	97.50	50	65	198.45	0	0	0.00	0.00	49	Member				
HORIZ		0.26	36	58	12.60	1	1	12.43	5.22	5	Bolt Bear				
DIAG	SAE - 2X2X0.25	6.50	36	58	24.55	1	1	12.43	10.44	62	Bolt Bear				
Max Splice Forces		Force	Capacity	Use	Num										
		(kip)	(kip)	%	Bolts	Bolt Type									
Top Tension		54.95	0.00	0	0										
Top Compression		65.51	0.00	0											
Bot Tension		98.45	218.08	45	4	1 A325									
Bot Compression		113.60	0.00	0											

Site Number: 302470
 Location: Ansonia Wakelee, CT
 Code: ANSI/TIA-222 Rev G
 Struct Class : II
 Exposure : B
 Topo : 1

© 2007 - 2014 by ATC IP LLC. All rights reserved.

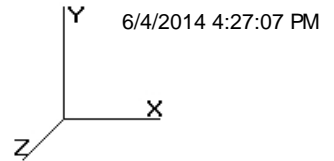

Force/Stress Summary

Section: 9 A780178 Bot Elev (ft): 160.0 Height (ft): 20.000

		Force	Len	Bracing %			Fy	phi	Num	Num	Shear	Bear	Use	
		(kip)	(ft)	X	Y	Z	(ksi)	Pn	Bolts	Holes	phiRnv	phiRn	%	Controls
Max Compression Member														
LEG	PX - 3" DIA PIPE	-58.32	3.90	100	100	100	41.1	50.0	120.14	0	0	0.00	0.00	48 Member X
HORIZ		0.00	0.000	0	0	0	0.0	0.0	0.00	0	0	0.00	0.00	0
DIAG	SAE - 2X2X0.1875	-7.09	7.798	50	50	50	119.1	36.0	10.98	2	1	24.86	26.10	64 Member Z

		Force	Fy	Fu	phi	Pn	Num	Num	Shear	Bear	Use	Controls
		(kip)	(ksi)	(ksi)	(kip)	Bolts	Holes		phiRnv	phiRn	%	
Max Tension Member												
LEG	PX - 3" DIA PIPE	54.66	50	65	135.90	0	0		0.00	0.00	40	Member
HORIZ		0.00	0	0	0.00	0	0		0.00	0.00	0	
DIAG	SAE - 2X2X0.1875	7.00	36	58	18.74	2	1		24.86	20.88	37	Member

		Force	Capacity	Use	Num	
		(kip)	(kip)	%	Bolts	Bolt Type
Max Splice Forces						
Top Tension		9.80	0.00	0	0	
Top Compression		14.30	0.00	0		
Bot Tension		54.95	166.24	33	4	7/8 A325
Bot Compression		65.51	0.00	0		

Section: 10 A780178 Bot Elev (ft): 180.0 Height (ft): 16.000

		Force	Len	Bracing %			Fy	phi	Num	Num	Shear	Bear	Use	
		(kip)	(ft)	X	Y	Z	(ksi)	Pn	Bolts	Holes	phiRnv	phiRn	%	Controls
Max Compression Member														
LEG	PST - 2-1/2" DIA PIP	-14.17	0.25	100	100	100	3.2	50.0	76.62	0	0	0.00	0.00	18 Member X
HORIZ	SAE - 2X2X0.125	-0.43	6.646	100	100	100	200.4	36.0	2.70	1	1	12.43	8.70	15 Member Z
DIAG	SAE - 1.75X1.75X0.18	-2.92	7.757	50	50	50	135.7	36.0	7.62	1	1	12.43	13.05	38 Member Z

		Force	Fy	Fu	phi	Pn	Num	Num	Shear	Bear	Use	Controls
		(kip)	(ksi)	(ksi)	(kip)	Bolts	Holes		phiRnv	phiRn	%	
Max Tension Member												
LEG	PST - 2-1/2" DIA PIP	9.48	50	65	76.68	0	0		0.00	0.00	12	Member
HORIZ	SAE - 2X2X0.125	0.45	36	58	12.60	1	1		12.43	5.22	8	Bolt Bear
DIAG	SAE - 1.75X1.75X0.18	2.82	36	58	15.67	1	1		12.43	7.83	36	Bolt Bear

		Force	Capacity	Use	Num	
		(kip)	(kip)	%	Bolts	Bolt Type
Max Splice Forces						
Top Tension		0.00	0.00	0	0	
Top Compression		0.33	0.00	0		
Bot Tension		9.80	120.40	8	4	3/4 A325
Bot Compression		14.30	0.00	0		

Site Number: 302470
Location: Ansonia Wakelee, CT
Code: ANSI/TIA-222 Rev G
Struct Class : II
Exposure : B
Topo : 1

© 2007 - 2014 by ATC IP LLC. All rights reserved.

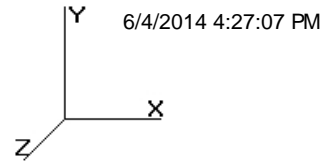

Support Forces Summary

Load Case	Node	FX (kip)	FY (kip)	FZ (kip)	(-) = Uplift (+) = Down
1.0D + 1.0W Service 90 deg	1b	-5.18	-48.50	-2.44	
	1a	-7.05	82.50	3.53	
	1	-0.94	17.00	-1.08	
1.0D + 1.0W Service 60 deg	1b	-5.78	-57.97	-3.34	
	1a	-4.69	54.43	1.79	
	1	-0.80	54.54	-4.96	
1.0D + 1.0W Service Normal	1b	-2.14	-21.88	-2.23	
	1a	2.14	-21.88	-2.23	
	1	0.00	94.75	-9.18	
1.2D + 1.0Di + 1.0Wi 90 deg	1b	-8.66	-35.38	-4.19	
	1a	-8.90	148.58	4.34	
	1	-1.38	56.60	-0.15	
1.2D + 1.0Di + 1.0Wi 60 deg	1b	-9.57	-49.24	-5.52	
	1a	-5.56	109.48	1.84	
	1	-1.19	109.57	-5.74	
1.2D + 1.0Di + 1.0Wi Normal	1b	-4.19	2.86	-3.84	
	1a	4.19	2.86	-3.84	
	1	0.00	164.09	-11.53	
0.9D + 1.6W 90 deg	1b	-28.83	-300.37	-13.94	
	1a	-30.16	330.97	14.85	
	1	-4.57	15.31	-0.91	
0.9D + 1.6W 60 deg	1b	-31.69	-345.82	-18.29	
	1a	-18.85	195.60	6.47	
	1	-3.83	196.12	-19.57	
0.9D + 1.6W Normal	1b	-14.09	-172.65	-13.00	
	1a	14.09	-172.65	-13.00	
	1	0.00	391.20	-39.91	
1.2D + 1.6W 90 deg	1b	-28.55	-295.73	-13.78	
	1a	-30.45	336.52	15.02	
	1	-4.56	20.41	-1.24	
1.2D + 1.6W 60 deg	1b	-31.41	-341.24	-18.13	
	1a	-19.13	200.96	6.64	
	1	-3.82	201.48	-19.90	
1.2D + 1.6W Normal	1b	-13.82	-167.82	-12.83	
	1a	13.82	-167.82	-12.83	
	1	0.00	396.84	-40.24	

Max Uplift: 345.82 (kip)	Moment: 7,498.13 (kip-ft)	1.2D + 1.6W Normal
Max Down: 396.84 (kip)	Total Down: 61.20 (kip)	
Max Shear: 40.24 (kip)	Total Shear: 65.90 (kip)	

Site Number: 302470
Location: Ansonia Wakelee, CT
Code: ANSI/TIA-222 Rev G
Struct Class : II
Exposure : B
Topo : 1

© 2007 - 2014 by ATC IP LLC. All rights reserved.

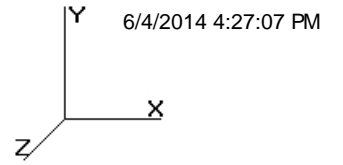

Site Number: 302470
Location: Ansonia Wakelee, CT
Code: ANSI/TIA-222 Rev G
Struct Class : II
Exposure : B
Topo : 1

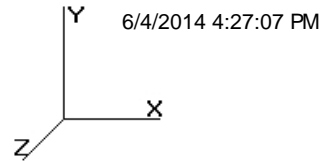

Deflections and Rotations

Load Case	Elevation (ft)	Deflection (ft)	Twist (deg)	Sway (deg)
Serviceability - 60.00 Wind 60 deg	79.75	0.0642	0.0050	0.1036
	106.75	0.1178	0.0065	0.1319
	126.75	0.1699	0.0078	0.1611
	150.00	0.2432	0.0093	0.2005
	154.88	0.2603	0.0095	0.2024
	168.05	0.3105	0.0115	0.2282
	175.85	0.3418	0.0124	0.2249
	184.19	0.3761	0.0133	0.2205
Serviceability - 60.00 Wind 90 deg	192.06	0.4083	0.0133	0.2349
	79.75	0.0648	0.0031	0.1030
	106.75	0.1187	0.0039	0.1331
	126.75	0.1712	0.0045	0.1621
	150.00	0.2448	0.0050	0.2012
	154.88	0.2622	0.0050	0.2046
	168.05	0.3126	0.0057	0.2288
	175.85	0.3440	0.0059	0.2215
Serviceability - 60.00 Wind Normal	184.19	0.3785	0.0061	0.2090
	192.06	0.4108	0.0061	0.2360
	79.75	0.0666	0.0035	0.1061
	106.75	0.1220	0.0044	0.1363
	126.75	0.1757	0.0051	0.1661
	150.00	0.2512	0.0055	0.2072
	154.88	0.2691	0.0053	0.2093
	168.05	0.3208	0.0053	0.2365
105.00 mph 60 deg with 0.75 in Radial Ic	175.85	0.3532	0.0048	0.2485
	184.19	0.3887	0.0043	0.2638
	192.06	0.4221	0.0042	0.2458
	79.75	0.0918	0.0071	0.1471
	106.75	0.1655	0.0091	0.1805
	126.75	0.2362	0.0109	0.2181
	150.00	0.3346	0.0129	0.2674
	154.88	0.3573	0.0131	0.2695
105.00 mph 60 deg with No Ic	168.05	0.4239	0.0156	0.3027
	175.85	0.4652	0.0167	0.2989
	184.19	0.5103	0.0178	0.2947
	192.06	0.5528	0.0179	0.3096
	79.75	0.3102	0.0366	0.4959
	106.75	0.5693	0.0536	0.6390
	126.75	0.8213	0.0698	0.7811
	150.00	1.1763	0.0944	0.9727
105.00 mph 60 deg with No Ice (Reduced DL)	154.88	1.2598	0.1002	0.9847
	168.05	1.5030	0.1375	1.1059
	175.85	1.6550	0.1625	1.0928
	184.19	1.8210	0.1861	1.0719
	192.06	1.9775	0.1878	1.1418
	79.75	0.3098	0.0365	0.4947
	106.75	0.5683	0.0535	0.6377
	126.75	0.8197	0.0696	0.7792

Site Number: 302470
Location: Ansonia Wakelee, CT
Code: ANSI/TIA-222 Rev G
Struct Class : II
Exposure : B
Topo : 1

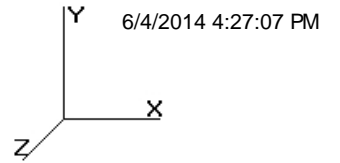

	150.00	1.1739	0.0941	0.9704
	154.88	1.2572	0.0999	0.9823
	168.05	1.4998	0.1371	1.1032
	175.85	1.6513	0.1620	1.0899
	184.19	1.8170	0.1856	1.0690
	192.06	1.9730	0.1873	1.1388
105.00 mph 90 deg with 0.75 in Radial Ic	79.75	0.0918	0.0042	0.1454
	106.75	0.1657	0.0052	0.1813
	126.75	0.2366	0.0060	0.2184
	150.00	0.3353	0.0067	0.2679
	154.88	0.3580	0.0067	0.2716
	168.05	0.4248	0.0075	0.3026
	175.85	0.4661	0.0077	0.2963
	184.19	0.5113	0.0079	0.2850
	192.06	0.5538	0.0079	0.3103
105.00 mph 90 deg with No Ic	79.75	0.3125	0.0158	0.4941
	106.75	0.5734	0.0196	0.6435
	126.75	0.8272	0.0227	0.7850
	150.00	1.1846	0.0261	0.9753
	154.88	1.2683	0.0260	0.9924
	168.05	1.5133	0.0304	1.1098
	175.85	1.6658	0.0317	1.0756
	184.19	1.8330	0.0327	1.0144
	192.06	1.9900	0.0326	1.1468
105.00 mph 90 deg with No Ice (Reduced DL	79.75	0.3121	0.0158	0.4934
	106.75	0.5724	0.0195	0.6421
	126.75	0.8256	0.0226	0.7832
	150.00	1.1822	0.0260	0.9728
	154.88	1.2657	0.0259	0.9899
	168.05	1.5100	0.0303	1.1069
	175.85	1.6622	0.0316	1.0726
	184.19	1.8289	0.0326	1.0114
	192.06	1.9855	0.0325	1.1438
105.00 mph Normal to Face with No Ic	79.75	0.3221	0.0170	0.5178
	106.75	0.5902	0.0219	0.6613
	126.75	0.8509	0.0254	0.8074
	150.00	1.2187	0.0277	1.0080
	154.88	1.3048	0.0274	1.0185
	168.05	1.5580	0.0280	1.1515
	175.85	1.7160	0.0262	1.2107
	184.19	1.8890	0.0245	1.2859
	192.06	2.0519	0.0242	1.1981
105.00 mph Normal to Face with No Ice (Reduced DL	79.75	0.3215	0.0170	0.5171
	106.75	0.5891	0.0219	0.6599
	126.75	0.8493	0.0254	0.8056
	150.00	1.2162	0.0276	1.0055
	154.88	1.3021	0.0273	1.0159
	168.05	1.5546	0.0279	1.1487
	175.85	1.7122	0.0261	1.2077
	184.19	1.8848	0.0243	1.2828
	192.06	2.0473	0.0240	1.1949
105.00 mph Normal with 0.75 in Radial Ic	79.75	0.0922	0.0055	0.1440
	106.75	0.1670	0.0068	0.1833
	126.75	0.2388	0.0078	0.2208

Site Number: 302470
Location: Ansonia Wakelee, CT
Code: ANSI/TIA-222 Rev G
Struct Class : II
Exposure : B
Topo : 1

© 2007 - 2014 by ATC IP LLC. All rights reserved.

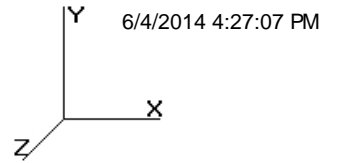

150.00	0.3388	0.0085	0.2722
154.88	0.3618	0.0084	0.2745
168.05	0.4297	0.0086	0.3075
175.85	0.4717	0.0082	0.3183
184.19	0.5176	0.0078	0.3322
192.06	0.5609	0.0077	0.3173
192.06	0.0000	0.0000	0.0000

Sprint



AMERICAN TOWER CORPORATION

PROJECT: 2.5 EQUIPMENT DEPLOYMENT
 SITE NAME: ANSONIA WAKELEE
 SITE CASCADE: CT03XC005
 SITE NUMBER: 302470
 SITE ADDRESS: 401 WAKELEE AVENUE
 ANSONIA, CT 06401
 SITE TYPE: SELF SUPPORT TOWER
 MARKET: SOUTHERN CONNECTICUT

PLANS PREPARED FOR:
Sprint
 6580 Sprint Parkway
 Overland Park, Kansas 66251

PLANS PREPARED BY:
INFINIGY Design. Build. Deliver.
 1033 Watervliet Shaker Rd
 Albany, NY 12205
 Office # (518) 690-0790
 Fax # (518) 690-0793
 JOB NUMBER 340-000

MLA PARTNER:
AMERICAN TOWER CORPORATION
 10 PRESIDENTIAL WAY
 WOBURN, MA 01801

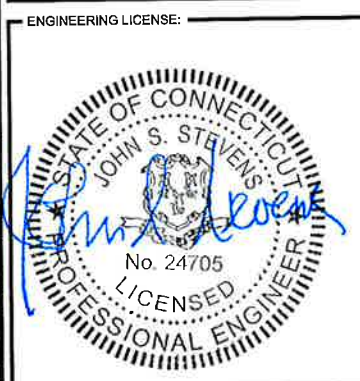

DRAWING NOTICE:
 THESE DOCUMENTS ARE CONFIDENTIAL AND ARE THE SOLE PROPERTY OF SPRINT AND MAY NOT BE REPRODUCED, DISSEMINATED OR REDISTRIBUTED WITHOUT THE EXPRESS WRITTEN CONSENT OF SPRINT.

REVISIONS:	DESCRIPTION	DATE	BY	REV
ISSUED FOR PERMIT		07/16/14	AHS	2
ISSUED FOR PERMIT		07/11/14	AHS	1
ISSUED FOR PERMIT		06/10/14	DJG	0
ISSUED FOR REVIEW		05/28/14	MAP	A

SITE NAME:
ANSONIA WAKELEE

SITE CASCADE:
CT03XC005

SITE ADDRESS:
**401 WAKELEE AVENUE
 ANSONIA, CT 06401**

SHEET DESCRIPTION:
TITLE SHEET & PROJECT DATA

SHEET NUMBER:
T-1

SITE INFORMATION

TOWER OWNER:
 AMERICAN TOWER CORPORATION
 10 PRESIDENTIAL WAY
 WOBURN, MA 01801

LATITUDE (NAD83):
 41° 21' 22.64" N
 41.356289°

LONGITUDE (NAD83):
 73° 5' 31.36" W
 -73.092044°

COUNTY:
 NEW HAVEN

ZONING JURISDICTION:
 CITY OF ANSONIA

ZONING DISTRICT:
 RESIDENCE B

POWER COMPANY:
 UNITED ILLUMINATING
 (800) 722-5584

AAV PROVIDER:
 AT&T
 (800) 288-2020

SPRINT CM:
 GARY WOOD
 (860) 940-9168
 GARY.WOOD@SPRINT.COM

AMERICAN TOWER PM:
 JOE SHANAHAN
 (781) 926-4521
 JOSEPH.SHANAHAN@AMERICANTOWER.COM

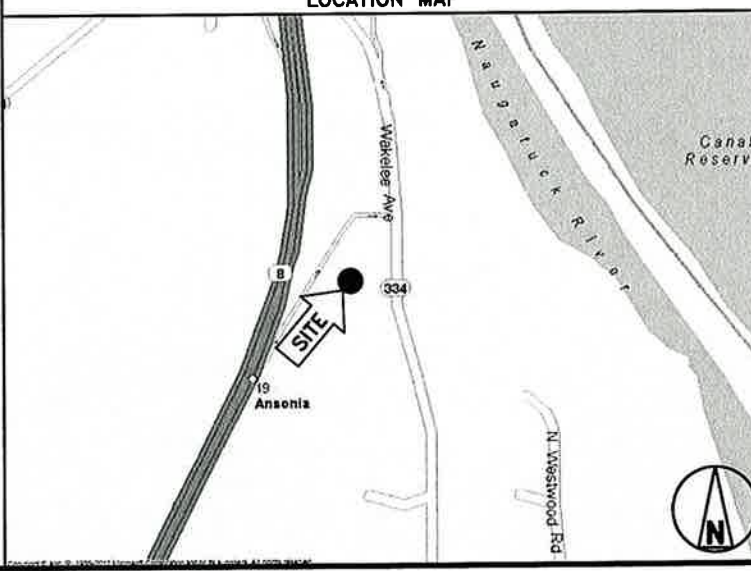
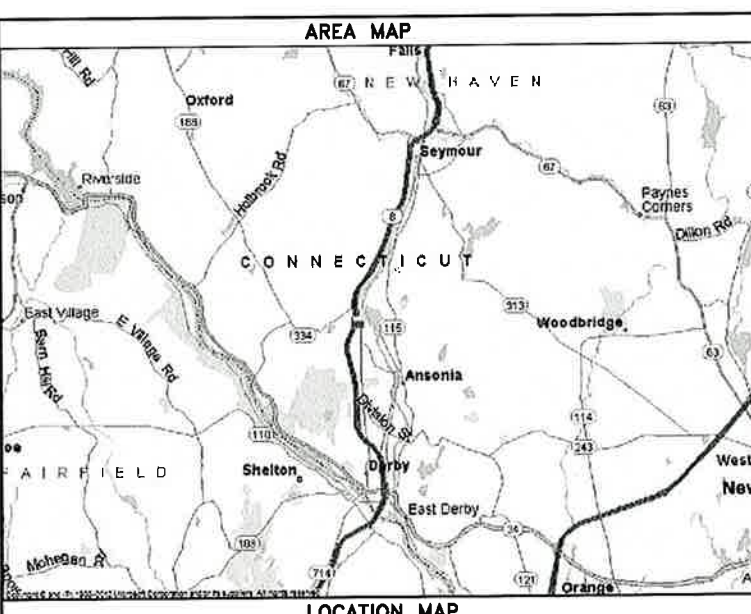

PROJECT DESCRIPTION

SPRINT PROPOSES TO MODIFY AN EXISTING UNMANNED TELECOMMUNICATIONS FACILITY.

- INSTALL 2.5 EQUIPMENT IN EXISTING NV MMBS CABINET
- INSTALL (3) PANEL ANTENNAS
- INSTALL (3) RRU'S TO TOWER
- INSTALL (27) JUMPER CABLES
- INSTALL (1) HYBRID CABLE
- INSTALL (4) BATTERIES IN EXISTING BATTERY CABINET

THESE PLANS HAVE BEEN DEVELOPED FOR THE MODIFICATION OF AN EXISTING UNMANNED TELECOMMUNICATIONS FACILITY OWNED OR LEASED BY SPRINT IN ACCORDANCE WITH THE SCOPE OF WORK PROVIDED BY SPRINT. INFINIGY HAS INCORPORATED THIS SCOPE OF WORK IN THE PLANS. THESE PLANS ARE NOT FOR CONSTRUCTION UNLESS ACCOMPANIED BY A PASSING STRUCTURAL STABILITY ANALYSIS PREPARED BY A LICENSED STRUCTURAL ENGINEER. STRUCTURAL ANALYSIS MUST INCLUDE BOTH TOWER AND MOUNT.

APPLICABLE CODES

ALL WORK SHALL BE PERFORMED AND MATERIALS INSTALL IN ACCORDANCE WITH THE CURRENT EDITIONS OF THE FOLLOWING CODES AS ADOPTED BY THE LOCAL GOVERNING AUTHORITIES. NOTHING IN THESE PLANS IS TO BE CONSTRUED TO PERMIT WORK NOT CONFORMING TO THESE CODES.

- INTERNATIONAL BUILDING CODE (2012 IBC)
- TIA-EIA-222-G OR LATEST EDITION
- NFPA 780 - LIGHTNING PROTECTION CODE
- 2011 NATIONAL ELECTRIC CODE OR LATEST EDITION
- ANY OTHER NATIONAL OR LOCAL APPLICABLE CODES, MOST RECENT EDITIONS
- CT BUILDING CODE
- LOCAL BUILDING CODE
- CITY/COUNTY ORDINANCES

DRAWING INDEX

SHEET NO.	SHEET TITLE	REV.
T-1	TITLE SHEET & PROJECT DATA	2
SP-1	SPRINT SPECIFICATIONS	2
SP-2	SPRINT SPECIFICATIONS	2
SP-3	SPRINT SPECIFICATIONS	2
A-1	SITE PLAN	2
A-1A	EXISTING EQUIPMENT DETAILS	2
A-2	TOWER ELEVATION & CABLE PLAN	2
A-3	ANTENNA LAYOUT & MOUNTING DETAILS	2
A-4	COLOR CODING & NOTES	2
A-5	EQUIPMENT & MOUNTING DETAILS	2
A-6	CIVIL DETAILS	2
A-7	PLUMBING DIAGRAM	2
E-1	ELECTRICAL & GROUNDING PLAN	2
E-2	ELECTRICAL & GROUNDING DETAILS	2



THESE OUTLINE SPECIFICATIONS IN CONJUNCTION WITH THE SPRINT STANDARD CONSTRUCTION SPECIFICATIONS, INCLUDING CONTRACT DOCUMENTS AND THE CONSTRUCTION DRAWINGS DESCRIBE THE WORK TO BE PERFORMED BY THE CONTRACTOR.

SECTION 01 100 - SCOPE OF WORK

PART 1 - GENERAL

- 1.1 THE WORK: THESE STANDARD CONSTRUCTION SPECIFICATIONS IN CONJUNCTION WITH THE SPRINT CONSTRUCTION STANDARDS FOR WIRELESS SITES, CONTRACT DOCUMENTS AND THE CONSTRUCTION DRAWINGS DESCRIBE THE WORK TO BE PERFORMED BY THE CONTRACTOR.
- 1.2 RELATED DOCUMENTS:
 - A. THE REQUIREMENTS OF THIS SECTION APPLY TO ALL SECTIONS IN THIS SPECIFICATION.
 - B. SPRINT "STANDARD CONSTRUCTION DETAILS FOR WIRELESS SITES" ARE INCLUDED IN AND MADE A PART OF THESE SPECIFICATIONS HEREWITH.
- 1.3 PRECEDENCE: SHOULD CONFLICTS OCCUR BETWEEN THE STANDARD CONSTRUCTION SPECIFICATIONS FOR WIRELESS SITES INCLUDING THE STANDARD CONSTRUCTION DETAILS FOR WIRELESS SITES AND THE CONSTRUCTION DRAWINGS, INFORMATION ON THE CONSTRUCTION DRAWINGS SHALL TAKE PRECEDENCE. NOTIFY SPRINT CONSTRUCTION MANAGER IF THIS OCCURS.
- 1.4 NATIONALLY RECOGNIZED CODES AND STANDARDS:
 - A. THE WORK SHALL COMPLY WITH APPLICABLE NATIONAL AND LOCAL CODES AND STANDARDS, LATEST EDITION, AND PORTIONS THEREOF, INCLUDED BUT NOT LIMITED TO THE FOLLOWING:
 - 1. GR-63-CORE NEBS REQUIREMENTS: PHYSICAL PROTECTION
 - 5. GR-78-CORE GENERIC REQUIREMENTS FOR THE PHYSICAL DESIGN AND MANUFACTURE OF TELECOMMUNICATIONS EQUIPMENT.
 - 3. GR-1089 CORE, ELECTROMAGNETIC COMPATIBILITY AND ELECTRICAL SAFETY -GENERIC CRITERIA FOR NETWORK TELECOMMUNICATIONS EQUIPMENT.
 - 4. NATIONAL FIRE PROTECTION ASSOCIATION CODES AND STANDARDS (NFPA) INCLUDING NFPA 70 (NATIONAL ELECTRICAL CODE - "NEC") AND NFPA 101 (LIFE SAFETY CODE).
 - 5. AMERICAN SOCIETY FOR TESTING OF MATERIALS (ASTM)
 - 6. INSTITUTE OF ELECTRONIC AND ELECTRICAL ENGINEERS (IEEE)
 - 7. AMERICAN CONCRETE INSTITUTE (ACI)
 - 8. AMERICAN WIRE PRODUCERS ASSOCIATION (AWPA)
 - 9. CONCRETE REINFORCING STEEL INSTITUTE (CRSI)
 - 10. AMERICAN ASSOCIATION OF STATE HIGHWAY AND TRANSPORTATION OFFICIALS (AASHTO)
 - 11. PORTLAND CEMENT ASSOCIATION (PCA)
 - 12. NATIONAL CONCRETE MASONRY ASSOCIATION (NCMA)
 - 13. BRICK INDUSTRY ASSOCIATION (BIA)
 - 14. AMERICAN WELDING SOCIETY (AWS)
 - 15. NATIONAL ROOFING CONTRACTORS ASSOCIATION (NRCA)
 - 16. SHEET METAL AND AIR CONDITIONING CONTRACTORS' NATIONAL ASSOCIATION (SMACNA)
 - 17. DOOR AND HARDWARE INSTITUTE (DHI)
 - 18. OCCUPATIONAL SAFETY AND HEALTH ACT (OSHA)
 - 19. APPLICABLE BUILDING CODES INCLUDING UNIFORM BUILDING CODE, SOUTHERN BUILDING CODE, BOCA, AND THE INTERNATIONAL BUILDING CODE.

1.5 DEFINITIONS:

- A. WORK: THE SUM OF TASKS AND RESPONSIBILITIES IDENTIFIED IN THE CONTRACT DOCUMENTS.
- B. COMPANY: SPRINT CORPORATION
- C. ENGINEER: SYNONYMOUS WITH ARCHITECT & ENGINEER AND "A&E". THE DESIGN PROFESSIONAL HAVING PROFESSIONAL RESPONSIBILITY FOR DESIGN OF THE PROJECT.
- D. CONTRACTOR: CONSTRUCTION CONTRACTOR; CONSTRUCTION VENDOR; INDIVIDUAL OR ENTITY WHO AFTER EXECUTION OF A CONTRACT IS BOUND TO ACCOMPLISH THE WORK.
- E. THIRD PARTY VENDOR OR AGENCY: A VENDOR OR AGENCY ENGAGED SEPARATELY BY THE COMPANY, A&E, OR CONTRACTOR TO PROVIDE MATERIALS OR TO ACCOMPLISH SPECIFIC TASKS RELATED TO BUT NOT INCLUDED IN THE WORK.
- F. OFCI: OWNER FURNISHED, CONTRACTOR INSTALLED EQUIPMENT.
- G. CONSTRUCTION MANAGER - ALL PROJECTS RELATED COMMUNICATION TO FLOW THROUGH SPRINT REPRESENTATIVE IN CHARGE OF PROJECT...

- 1.6 SITE FAMILIARITY: CONTRACTOR SHALL BE RESPONSIBLE FOR FAMILIARIZING HIMSELF WITH ALL CONTRACT DOCUMENTS, FIELD CONDITIONS AND DIMENSIONS PRIOR TO PROCEEDING WITH CONSTRUCTION. ANY DISCREPANCIES SHALL BE BROUGHT TO THE ATTENTION OF THE SPRINT CONSTRUCTION MANAGER PRIOR TO THE COMMENCEMENT OF WORK. NO COMPENSATION WILL BE AWARDED BASED ON CLAIM OF LACK OF KNOWLEDGE OR FIELD CONDITIONS.
- 1.7 POINT OF CONTACT: COMMUNICATION BETWEEN SPRINT AND THE CONTRACTOR SHALL FLOW THROUGH THE SINGLE SPRINT CONSTRUCTION MANAGER APPOINTED TO MANAGE THE PROJECT FOR SPRINT.
- 1.8 ON-SITE SUPERVISION: THE CONTRACTOR SHALL SUPERVISE AND DIRECT THE WORK AND SHALL BE RESPONSIBLE FOR CONSTRUCTION MEANS, METHODS, TECHNIQUES, SEQUENCES, AND PROCEDURES IN ACCORDANCE WITH THE CONTRACT DOCUMENTS. THE CONTRACTOR SHALL EMPLOY A COMPETENT SUPERINTENDENT WHO SHALL BE IN ATTENDANCE AT THE SITE AT ALL TIMES DURING PERFORMANCE OF THE WORK.
- 1.9 DRAWINGS, SPECIFICATIONS AND DETAILS REQUIRED AT JOBSITE: THE CONSTRUCTION CONTRACTOR SHALL MAINTAIN A FULL SET OF THE CONSTRUCTION DRAWINGS, STANDARD CONSTRUCTION DETAILS FOR WIRELESS SITES AND THE STANDARD CONSTRUCTION SPECIFICATIONS FOR WIRELESS SITES AT THE JOBSITE FROM MOBILIZATION THROUGH CONSTRUCTION COMPLETION.
 - A. THE JOBSITE DRAWINGS, SPECIFICATIONS AND DETAILS SHALL BE CLEARLY MARKED DAILY IN RED PENCIL WITH ANY CHANGES IN CONSTRUCTION OVER WHAT IS DEPICTED IN THE DOCUMENTS. AT CONSTRUCTION COMPLETION, THIS JOBSITE MARKUP SET SHALL BE DELIVERED TO THE COMPANY OR COMPANY'S DESIGNATED REPRESENTATIVE TO BE FORWARDED TO THE COMPANY'S A&E VENDOR FOR PRODUCTION OF "AS-BUILT" DRAWINGS.
 - B. DETAILS ARE INTENDED TO SHOW DESIGN INTENT. MODIFICATIONS MAY BE REQUIRED TO SUIT JOB DIMENSIONS OR CONDITIONS, AND SUCH MODIFICATIONS SHALL BE INCLUDED AS PART OF THE WORK. CONTRACTOR SHALL NOTIFY SPRINT CONSTRUCTION MANAGER OF ANY VARIATIONS PRIOR TO PROCEEDING WITH THE WORK.
 - C. DIMENSIONS SHOWN ARE TO FINISH SURFACES UNLESS NOTED OTHERWISE. SPACING BETWEEN EQUIPMENT IS THE REQUIRED CLEARANCE. SHOULD THERE BE ANY QUESTIONS REGARDING THE CONTRACT DOCUMENTS, EXISTING CONDITIONS AND/OR DESIGN INTENT, THE CONTRACTOR SHALL BE RESPONSIBLE FOR OBTAINING A CLARIFICATION FROM THE SPRINT CONSTRUCTION MANAGER PRIOR TO PROCEEDING WITH THE WORK.
- 1.10 USE OF JOB SITE: THE CONTRACTOR SHALL CONFINE ALL CONSTRUCTION AND RELATED OPERATIONS INCLUDING STAGING AND STORAGE OF MATERIALS AND EQUIPMENT, PARKING, TEMPORARY FACILITIES, AND WASTE STORAGE TO THE LEASE PARCEL UNLESS OTHERWISE PERMITTED BY THE CONTRACT DOCUMENTS.
- 1.11 UTILITIES SERVICES: WHERE NECESSARY TO CUT EXISTING PIPES, ELECTRICAL WIRES, CONDUITS, CABLES, ETC., OF UTILITY SERVICES, OR OF FIRE PROTECTION OR COMMUNICATIONS SYSTEMS, THEY SHALL BE CUT AND CAPPED AT SUITABLE PLACES OR WHERE SHOWN. ALL SUCH ACTIONS SHALL BE COORDINATED WITH THE UTILITY COMPANY INVOLVED:
- 1.12 PERMITS / FEES: WHEN REQUIRED THAT A PERMIT OR CONNECTION FEE BE PAID TO A PUBLIC UTILITY PROVIDER FOR NEW SERVICE TO THE CONSTRUCTION PROJECT, PAYMENT OF SUCH FEE SHALL BE THE RESPONSIBILITY OF THE CONTRACTOR.
- 1.13 CONTRACTOR SHALL TAKE ALL MEASURES AND PROVIDE ALL MATERIAL NECESSARY FOR PROTECTING EXISTING EQUIPMENT AND PROPERTY.
- 1.14 METHODS OF PROCEDURE (MOPS) FOR CONSTRUCTION: CONTRACTOR SHALL PERFORM WORK AS DESCRIBED IN THE FOLLOWING INSTALLATION AND COMMISSIONING MOPS.

NOTE: IN SHORT-FORM SPECIFICATIONS ON THE DRAWINGS, A/E TO INSERT LIST OF APPLICABLE MOPS INCLUDING EN-2012-001, EN-2013-002, EL-0568, AND TS-0193
- 1.15 USE OF ELECTRONIC PROJECT MANAGEMENT SYSTEMS:

PART 2 - PRODUCTS (NOT USED)

PART 3 - EXECUTION

- 3.1 TEMPORARY UTILITIES AND FACILITIES: THE CONTRACTOR SHALL BE RESPONSIBLE FOR ALL TEMPORARY UTILITIES AND FACILITIES NECESSARY EXCEPT AS OTHERWISE INDICATED IN THE CONSTRUCTION DOCUMENTS. TEMPORARY UTILITIES AND FACILITIES INCLUDE POTABLE WATER, HEAT, HVAC, ELECTRICITY, SANITARY FACILITIES, WASTE DISPOSAL FACILITIES, AND TELEPHONE/COMMUNICATION SERVICES. PROVIDE TEMPORARY UTILITIES AND FACILITIES IN ACCORDANCE WITH OSHA AND THE AUTHORITY HAVING JURISDICTION. CONTRACTOR MAY UTILIZE THE COMPANY ELECTRICAL SERVICE IN THE COMPLETION OF THE WORK WHEN IT BECOMES AVAILABLE. USE OF THE LESSORS OR SITE OWNER'S UTILITIES OR FACILITIES IS EXPRESSLY FORBIDDEN EXCEPT AS OTHERWISE ALLOWED IN THE CONTRACT DOCUMENTS.
- 3.2 ACCESS TO WORK: THE CONTRACTOR SHALL PROVIDE ACCESS TO THE JOB SITE FOR AUTHORIZED COMPANY PERSONNEL AND AUTHORIZED REPRESENTATIVES OF THE ARCHITECT/ENGINEER DURING ALL PHASES OF THE WORK.
- 3.3 TESTING: REQUIREMENTS FOR TESTING BY THIS CONTRACTOR SHALL BE AS INDICATED HEREWITH, ON THE CONSTRUCTION DRAWINGS, AND IN THE INDIVIDUAL SECTIONS OF THESE SPECIFICATIONS. SHOULD COMPANY CHOOSE TO ENGAGE ANY THIRD-PARTY TO CONDUCT ADDITIONAL TESTING, THE CONTRACTOR SHALL COOPERATE WITH AND PROVIDE A WORK AREA FOR COMPANY'S TEST AGENCY.
- 3.4 DIMENSIONS: VERIFY DIMENSIONS INDICATED ON DRAWINGS WITH FIELD DIMENSIONS BEFORE FABRICATION OR ORDERING OF MATERIALS. DO NOT SCALE DRAWINGS.

3.5 EXISTING CONDITIONS: NOTIFY THE SPRINT CONSTRUCTION MANAGER OF EXISTING CONDITIONS DIFFERING FROM THOSE INDICATED ON THE DRAWINGS. DO NOT REMOVE OR ALTER STRUCTURAL COMPONENTS WITHOUT PRIOR WRITTEN APPROVAL FROM THE ARCHITECT AND ENGINEER.

SECTION 01 200 - COMPANY FURNISHED MATERIAL AND EQUIPMENT

PART 1 - GENERAL

- 1.1 THE WORK: THESE STANDARD CONSTRUCTION SPECIFICATIONS IN CONJUNCTION WITH THE OTHER CONTRACT DOCUMENTS AND THE CONSTRUCTION DRAWINGS DESCRIBE THE WORK TO BE PERFORMED BY THE CONTRACTOR.
- 1.2 RELATED DOCUMENTS:
 - A. THE REQUIREMENTS OF THIS SECTION APPLY TO ALL SECTIONS IN THIS SPECIFICATION.
 - B. SPRINT "STANDARD CONSTRUCTION DETAILS FOR WIRELESS SITES" ARE INCLUDED IN AND MADE A PART OF THESE SPECIFICATIONS HEREWITH.

PART 2 - PRODUCTS (NOT USED)

PART 3 - EXECUTION

3.1 RECEIPT OF MATERIAL AND EQUIPMENT:

- A. A COMPANY FURNISHED MATERIAL AND EQUIPMENT IS IDENTIFIED ON THE RF DATA SHEET IN THE CONSTRUCTION DOCUMENTS.
- B. THE CONTRACTOR IS RESPONSIBLE FOR SPRINT PROVIDED MATERIAL AND EQUIPMENT AND UPON RECEIPT SHALL:
 - 1. ACCEPT DELIVERIES AS SHIPPED AND TAKE RECEIPT.
 - 2. VERIFY COMPLETENESS AND CONDITION OF ALL DELIVERIES.
 - 3. TAKE RESPONSIBILITY FOR EQUIPMENT AND PROVIDE INSURANCE PROTECTION AS REQUIRED IN AGREEMENT.
 - 4. RECORD ANY DEFECTS OR DAMAGES AND WITHIN TWENTY-FOUR HOURS AFTER RECEIPT, REPORT TO SPRINT OR ITS DESIGNATED PROJECT REPRESENTATIVE OF SUCH.
 - 5. PROVIDE SECURE AND NECESSARY WEATHER PROTECTED WAREHOUSING.
 - 6. COORDINATE SAFE AND SECURE TRANSPORTATION OF MATERIAL AND EQUIPMENT, DELIVERING AND OFF-LOADING FROM CONTRACTOR'S WAREHOUSE TO SITE.

3.2 DELIVERABLES:

- A. COMPLETE SHIPPING AND RECEIPT DOCUMENTATION IN ACCORDANCE WITH COMPANY PRACTICE.
- B. IF APPLICABLE, COMPLETE LOST/STOLEN/DAMAGED DOCUMENTATION REPORT AS NECESSARY IN ACCORDANCE WITH COMPANY PRACTICE, AND AS DIRECTED BY COMPANY.
- C. UPLOAD DOCUMENTATION INTO SPRINT SITE MANAGEMENT SYSTEM (SMS) AND/OR PROVIDE HARD COPY DOCUMENTATION AS REQUESTED.

SECTION 01 300 - CELL SITE CONSTRUCTION CO.

PART 1 - GENERAL

1.1 THE WORK: THESE STANDARD CONSTRUCTION SPECIFICATIONS IN CONJUNCTION WITH THE OTHER CONTRACT DOCUMENTS AND THE CONSTRUCTION DRAWINGS DESCRIBE THE WORK TO BE PERFORMED BY THE CONTRACTOR.

1.2 RELATED DOCUMENTS:

- A. THE REQUIREMENTS OF THIS SECTION APPLY TO ALL SECTIONS IN THIS SPECIFICATION.
- B. SPRINT "STANDARD CONSTRUCTION DETAILS FOR WIRELESS SITES" ARE INCLUDED IN AND MADE A PART OF THESE SPECIFICATIONS HEREWITH.

1.3 NOTICE TO PROCEED

- A. NO WORK SHALL COMMENCE PRIOR TO COMPANY'S WRITTEN NOTICE TO PROCEED AND THE ISSUANCE OF THE WORK ORDER.
- B. UPON RECEIVING NOTICE TO PROCEED, CONTRACTOR SHALL FULLY PERFORM ALL WORK NECESSARY TO PROVIDE SPRINT WITH AN OPERATIONAL WIRELESS FACILITY.

PART 2 - PRODUCTS (NOT USED)

PART 3 - EXECUTION

3.1 FUNCTIONAL REQUIREMENTS:

- A. THE ACTIVITIES DESCRIBED IN THIS PARAGRAPH REPRESENT MINIMUM ACTIONS AND PROCESSES REQUIRED TO SUCCESSFULLY COMPLETE THE WORK. THE ACTIVITIES DESCRIBED ARE NOT EXHAUSTIVE, AND CONTRACTOR SHALL TAKE ANY AND ALL ACTIONS AS NECESSARY TO SUCCESSFULLY COMPLETE THE CONSTRUCTION OF A FULLY FUNCTIONING WIRELESS FACILITY AT THE SITE IN ACCORDANCE WITH COMPANY PROCESSES.
- B. SUBMIT SPECIFIC DOCUMENTATION AS INDICATED HEREIN, AND OBTAIN REQUIRED APPROVALS WHILE THE WORK IS BEING PERFORMED.
- C. MANAGE AND CONDUCT ALL FIELD CONSTRUCTION SERVICE RELATED ACTIVITIES
- D. PROVIDE CONSTRUCTION ACTIVITIES TO THE EXTENT REQUIRED BY THE CONTRACT DOCUMENTS, INCLUDING BUT NOT LIMITED TO THE FOLLOWING:

PLANS PREPARED FOR:



PLANS PREPARED BY:



MLA PARTNER:



ENGINEERING LICENSE:

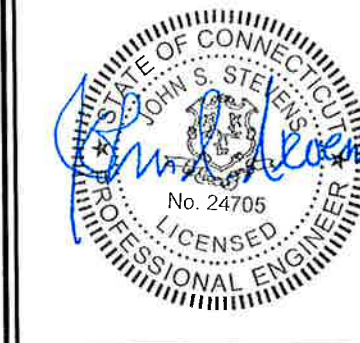

DRAWING NOTICE:

THESE DOCUMENTS ARE CONFIDENTIAL AND ARE THE SOLE PROPERTY OF SPRINT AND MAY NOT BE REPRODUCED, DISSEMINATED OR REDISTRIBUTED WITHOUT THE EXPRESS WRITTEN CONSENT OF SPRINT.

REVISIONS:

DESCRIPTION	DATE	BY	REV
ISSUED FOR PERMIT	07/16/14	AHS	2
ISSUED FOR PERMIT	07/11/14	AHS	1
ISSUED FOR PERMIT	06/10/14	DNJ	0
ISSUED FOR REVIEW	05/28/14	MAP	A

SITE NAME:

ANSONIA WAKELEE

SITE CASCADE:

CT03XC005

SITE ADDRESS:

**401 WAKELEE AVENUE
ANSONIA, CT 06401**

SHEET DESCRIPTION:

SPRINT SPECIFICATIONS

SHEET NUMBER:

SP-1

CONTINUE FROM SP-1

1. PERFORM ANY REQUIRED SITE ENVIRONMENTAL MITIGATION.
 2. PREPARE GROUND SITES; PROVIDE DE-GRUBBING; AND ROUGH AND FINAL GRADING, AND COMPOUND SURFACE TREATMENTS.
 3. MANAGE AND CONDUCT ALL ACTIVITIES FOR INSTALLATION OF UTILITIES INCLUDING ELECTRICAL AND TELCO BACKHAUL.
 4. INSTALL UNDERGROUND FACILITIES INCLUDING UNDERGROUND POWER AND COMMUNICATIONS CONDUITS, AND UNDERGROUND GROUNDING SYSTEM.
 5. INSTALL ABOVE GROUND GROUNDING SYSTEMS.
 6. PROVIDE NEW HVAC INSTALLATIONS AND MODIFICATIONS.
 7. INSTALL "H-FRAMES", CABINETS AND SHELTERS AS INDICATED.
 8. INSTALL ROADS, ACCESS WAYS, CURBS AND DRAINS AS INDICATED.
 9. ACCOMPLISH REQUIRED MODIFICATION OF EXISTING FACILITIES.
 10. PROVIDE ANTENNA SUPPORT STRUCTURE FOUNDATIONS.
 11. PROVIDE SLABS AND EQUIPMENT PLATFORMS.
 12. INSTALL COMPOUND FENCING, SIGHT SHIELDING, LANDSCAPING AND ACCESS BARRIERS.
 13. PERFORM INSPECTION AND MATERIAL TESTING AS REQUIRED HEREINAFTER.
 14. CONDUCT SITE RESISTANCE TO EARTH TESTING AS REQUIRED HEREINAFTER.
 15. INSTALL FIXED GENERATOR SETS AND OTHER STANDBY POWER SOLUTIONS.
 16. INSTALL TOWERS, ANTENNA SUPPORT STRUCTURES AND PLATFORMS ON EXISTING TOWERS AS REQUIRED.
 17. INSTALL CELL SITE RADIOS, MICROWAVE, GPS, COAXIAL MAINLINE, ANTENNAS, CROSS BAND COUPLERS, TOWER TOP AMPLIFIERS, LOW NOISE AMPLIFIERS AND RELATED EQUIPMENT.
 18. PERFORM, DOCUMENT, AND CLOSE OUT ANY CONSTRUCTION CONTROL DOCUMENTS THAT MAY BE REQUIRED BY GOVERNMENT AGENCIES AND LANDLORDS.
 19. PERFORM ANTENNA AND COAX SWEEP TESTING AND MAKE ANY AND ALL NECESSARY CORRECTIONS.
 20. REMAIN ON SITE MOBILIZED THROUGHOUT HAND-OFF AND INTEGRATION TO ASSIST AS NEEDED UNTIL SITE IS DEEMED SUBSTANTIALLY COMPLETE AND PLACED "ON AIR."
- 3.2 GENERAL REQUIREMENTS FOR CIVIL CONSTRUCTION:**
- A. CONTRACTOR SHALL KEEP THE SITE FREE FROM ACCUMULATING WASTE MATERIAL, DEBRIS, AND TRASH. AT THE COMPLETION OF THE WORK, CONTRACTOR SHALL REMOVE FROM THE SITE ALL REMAINING RUBBISH, IMPLEMENTS, TEMPORARY FACILITIES, AND SURPLUS MATERIALS.**
- B. EQUIPMENT ROOMS SHALL AT ALL TIMES BE MAINTAINED "BROOM CLEAN" AND CLEAR OF DEBRIS.**
- C. CONTRACTOR SHALL TAKE ALL REASONABLE PRECAUTIONS TO DISCOVER AND LOCATE ANY HAZARDOUS CONDITION.**
1. IN THE EVENT CONTRACTOR ENCOUNTERS ANY HAZARDOUS CONDITION WHICH HAS NOT BEEN ABATED OR OTHERWISE MITIGATED, CONTRACTOR AND ALL OTHER PERSONS SHALL IMMEDIATELY STOP WORK IN THE AFFECTED AREA AND NOTIFY COMPANY IN WRITING. THE WORK IN THE AFFECTED AREA SHALL NOT BE RESUMED EXCEPT BY WRITTEN NOTIFICATION BY COMPANY.
 2. CONTRACTOR AGREES TO USE CARE WHILE ON THE SITE AND SHALL NOT TAKE ANY ACTION THAT WILL OR MAY RESULT IN OR CAUSE THE HAZARDOUS CONDITION TO BE FURTHER RELEASED IN THE ENVIRONMENT, OR TO FURTHER EXPOSE INDIVIDUALS TO THE HAZARD.
- D. CONTRACTOR'S ACTIVITIES SHALL BE RESTRICTED TO THE PROJECT LIMITS. SHOULD AREAS OUTSIDE THE PROJECT LIMITS BE AFFECTED BY CONTRACTOR'S ACTIVITIES, CONTRACTOR SHALL IMMEDIATELY RETURN THEM TO ORIGINAL CONDITION**
- E. CONDUCT TESTING AS REQUIRED HEREIN.**
- 3.3 DELIVERABLES:**
- A. CONTRACTOR SHALL REVIEW, APPROVE, AND SUBMIT TO SPRINT SHOP DRAWINGS, PRODUCT DATA, SAMPLES, AND SIMILAR SUBMITTALS AS REQUIRED HEREINAFTER**
- B. PROVIDE DOCUMENTATION INCLUDING, BUT NOT LIMITED TO, THE FOLLOWING. DOCUMENTATION SHALL BE FORWARDED IN ORIGINAL FORMAT AND/OR UPLOADED INTO SMS.**
1. ALL CORRESPONDENCE AND PRELIMINARY CONSTRUCTION REPORTS.
 2. PROJECT PROGRESS REPORTS.
 3. CIVIL CONSTRUCTION START DATE (POPULATE FIELD IN SMS AND/OR FORWARD NOTIFICATION).
 4. ELECTRICAL SERVICE COMPLETION DATE (POPULATE FIELD IN SMS AND/OR FORWARD NOTIFICATION).

5. LINES AND ANTENNA INSTALL DATE (POPULATE FIELD IN SMS AND/OR FORWARD NOTIFICATION).
6. POWER INSTALL DATE (POPULATE FIELD IN SMS AND/OR FORWARD NOTIFICATION).
7. TELCO READY DATE (POPULATE FIELD IN SMS AND/OR FORWARD NOTIFICATION).
8. PPC (OR SHELTER) INSTALL DATE (POPULATE FIELD IN SMS AND/OR FORWARD NOTIFICATION).
9. TOWER CONSTRUCTION START DATE (POPULATE FIELD IN SMS AND/OR FORWARD NOTIFICATION).
10. TOWER CONSTRUCTION COMPLETE DATE (POPULATE FIELD IN SMS AND/OR FORWARD NOTIFICATION).
11. BTS AND RADIO EQUIPMENT DELIVERED AT SITE DATE (POPULATE FIELD IN SMS AND/OR FORWARD NOTIFICATION).
12. NETWORK OPERATIONS HANDOFF CHECKLIST (HOC WALK) COMPLETE (UPLOAD FORM IN SMS)
13. CIVIL CONSTRUCTION COMPLETE DATE (POPULATE FIELD IN SMS AND/OR FORWARD NOTIFICATION).
14. SITE CONSTRUCTION PROGRESS PHOTOS UNLOADED INTO SMS.

SECTION 01 400 - SUBMITTALS & TESTS

PART 1 - GENERAL

- 1.1 THE WORK: THESE STANDARD CONSTRUCTION SPECIFICATIONS IN CONJUNCTION WITH THE OTHER CONTRACT DOCUMENTS AND THE CONSTRUCTION DRAWINGS DESCRIBE THE WORK TO BE PERFORMED BY THE CONTRACTOR.**
- 1.2 RELATED DOCUMENTS:**
- A. THE REQUIREMENTS OF THIS SECTION APPLY TO ALL SECTIONS IN THIS SPECIFICATION.**
- B. SPRINT "STANDARD CONSTRUCTION DETAILS FOR WIRELESS SITES" ARE INCLUDED IN AND MADE A PART OF THESE SPECIFICATIONS HERewith.**
- 1.3 SUBMITTALS:**
- A. THE WORK IN ALL ASPECTS SHALL COMPLY WITH THE CONSTRUCTION DRAWINGS AND THESE SPECIFICATIONS.**
- B. SUBMIT THE FOLLOWING TO COMPANY REPRESENTATIVE FOR APPROVAL**
1. CONCRETE MIX-DESIGNS FOR TOWER FOUNDATIONS, ANCHORS PIERS, AND CONCRETE PAVING.
 2. CONCRETE BREAK TESTS AS SPECIFIED HEREIN.
 3. SPECIAL FINISHES FOR INTERIOR SPACES, IF ANY.
 4. ALL EQUIPMENT AND MATERIALS SO IDENTIFIED ON THE CONSTRUCTION DRAWINGS.
 5. CHEMICAL GROUNDING DESIGN
- D. ALTERNATES: AT THE COMPANY'S REQUEST, ANY ALTERNATIVES TO THE MATERIALS OR METHODS SPECIFIED SHALL BE SUBMITTED TO SPRINT'S CONSTRUCTION MANAGER FOR APPROVAL PRIOR TO BEING SHIPPED TO SITE. SPRINT WILL REVIEW AND APPROVE ONLY THOSE REQUESTS MADE IN WRITING. NO VERBAL APPROVALS WILL BE CONSIDERED. SUBMITTAL FOR APPROVAL SHALL INCLUDE A STATEMENT OF COST REDUCTION PROPOSED FOR USE OF ALTERNATE PRODUCT.**

1.4 TESTS AND INSPECTIONS:

- A. THE CONTRACTOR SHALL BE RESPONSIBLE FOR ALL CONSTRUCTION TESTS, INSPECTIONS AND PROJECT DOCUMENTATION.**
- B. CONTRACTOR SHALL ACCOMPLISH TESTING INCLUDING BUT NOT LIMITED TO THE FOLLOWING:**
1. COAX SWEEPS AND FIBER TESTS PER TS-0200 REV 4 ANTENNA LINE ACCEPTANCE STANDARDS.
 2. AGL, AZIMUTH AND DOWNTILT USING ELECTRONIC COMMERCIAL MADE-FOR-THE-PURPOSE ANTENNA ALIGNMENT TOOL.
 3. CONTRACTOR SHALL BE RESPONSIBLE FOR ANY AND ALL CORRECTIONS TO ANY WORK IDENTIFIED AS UNACCEPTABLE IN SITE INSPECTION ACTIVITIES AND/OR AS A RESULT OF TESTING.
- C. REQUIRED CLOSEOUT DOCUMENTATION INCLUDES, BUT IS NOT LIMITED TO THE FOLLOWING:**
1. AZIMUTH, DOWNTILT, AGL -- UPLOAD REPORT FROM ANTENNA ALIGNMENT TOOL TO SITERRA TASK 465. INSTALLED AZIMUTH, DOWNTILT, AND AGL MUST CONFORM TO THE RF DATA SHEETS. SWEEP AND FIBER TESTS
 2. SCANABLE BARCODE PHOTOGRAPHS OF TOWER TOP AND INACCESSIBLE SERIALIZED EQUIPMENT
 3. ALL AVAILABLE JURISDICTIONAL INFORMATION
 4. PDF SCAN OF REDLINES PRODUCED IN FIELD

5. ELECTRONIC AS-BUILT DRAWINGS IN AUTOCAD AND PDF FORMATS. ANY FIELD CHANGE MUST BE REFLECTED BY MODIFYING THE PLANS, ELEVATIONS, AND DETAILS IN THE DRAWING SETS. GENERAL NOTES INDICATING MODIFICATIONS WILL NOT BE ACCEPTED. CHANGES SHALL BE HIGHLIGHTED AS "CLOUDS" IDENTIFIED AS THE "AS-BUILT" CONDITION.
6. LIEN WAIVERS
7. FINAL PAYMENT APPLICATION
8. REQUIRED FINAL CONSTRUCTION PHOTOS
9. CONSTRUCTION AND COMMISSIONING CHECKLIST COMPLETE WITH NO DEFICIENT ITEMS
10. ALL POST NTP TASKS INCLUDING DOCUMENT UPLOADS COMPLETED IN SITERRA (SPRINTS DOCUMENT REPOSITORY OF RECORD).

- 1.5 COMMISSIONING: PERFORM ALL COMMISSIONING AS REQUIRED BY APPLICABLE MOPs**
- 1.6 INTEGRATION: PERFORM ALL INTEGRATION ACTIVITIES AS REQUIRED BY APPLICABLE MOPs**

PART 2 - PRODUCTS (NOT USED)

PART 3 - EXECUTION

3.1 REQUIREMENTS FOR TESTING:

A. THIRD PARTY TESTING AGENCY:

1. WHEN THE USE OF A THIRD PARTY INDEPENDENT TESTING AGENCY IS REQUIRED, THE AGENCY THAT IS SELECTED MUST PERFORM SUCH WORK ON A REGULAR BASIS IN THE STATE WHERE THE PROJECT IS LOCATED AND HAVE A THOROUGH UNDERSTANDING OF LOCAL AVAILABLE MATERIALS, INCLUDING THE SOIL, ROCK, AND GROUNDWATER CONDITIONS.
2. THE THIRD PARTY TESTING AGENCY IS TO BE FAMILIAR WITH THE APPLICABLE REQUIREMENTS FOR THE TESTS TO BE DONE, EQUIPMENT TO BE USED, AND ASSOCIATED HEALTH AND SAFETY ISSUES.
3. EXPERIENCE IN SOILS, CONCRETE, MASONRY, AGGREGATE, AND ASPHALT TESTING USING ASTM, AASJTO, AND OTHER METHODS IS NEEDED.
4. EXPERIENCE IN SOILS, CONCRETE, MASONRY, AGGREGATE, AND ASPHALT TESTING USING ASTM, AASJTO, AND OTHER METHODS IS NEEDED.

3.2 REQUIRED TESTS:

- A. CONTRACTOR SHALL ACCOMPLISH TESTING INCLUDING BUT NOT LIMITED TO THE FOLLOWING:**
1. CONCRETE CYLINDER BREAK TESTS FOR THE TOWER AND ANCHOR FOUNDATIONS AS SPECIFIED IN SECTION: PORTLAND CEMENT CONCRETE PAVING.
 2. ASPHALT ROADWAY COMPACTED THICKNESS, SURFACE SMOOTHNESS, AND COMPACTED DENSITY TESTING AS SPECIFIED IN SECTION: HOT MIX ASPHALT PAVING.
 3. FIELD QUALITY CONTROL TESTING AS SPECIFIED IN SECTION: PORTLAND CEMENT CONCRETE PAVING.
 4. TESTING REQUIRED UNDER SECTION: AGGREGATE BASE FOR ACCESS ROADS, PADS AND ANCHOR LOCATIONS
 5. STRUCTURAL BACKFILL COMPACTION TESTS FOR THE TOWER FOUNDATION.
 6. SITE RESISTANCE TO EARTH TESTING PER EXHIBIT: CELL SITE GROUNDING SYSTEM DESIGN.
 7. ANTENNA AND COAX SWEEP TESTS PER EXHIBIT: ANTENNA TRANSMISSION LINE ACCEPTANCE STANDARDS.
 8. GROUNDING AT ANTENNA MASTS FOR GPS AND ANTENNAS
 9. ALL OTHER TESTS REQUIRED BY COMPANY OR JURISDICTION.

3.3 REQUIRED INSPECTIONS

- A. SCHEDULE INSPECTIONS WITH COMPANY REPRESENTATIVE.**
- B. CONDUCT INSPECTIONS INCLUDING BUT NOT LIMITED TO THE FOLLOWING:**
1. GROUNDING SYSTEM INSTALLATION PRIOR TO EARTH CONCEALMENT DOCUMENTED WITH DIGITAL PHOTOGRAPHS BY CONTRACTOR, APPROVED BY A&E OR SPRINT REPRESENTATIVE.
 2. FORMING FOR CONCRETE AND REBAR PLACEMENT PRIOR TO POUR DOCUMENTED WITH DIGITAL PHOTOGRAPHS BY CONTRACTOR, APPROVED BY A&E OR SPRINT REPRESENTATIVE.
 3. COMPACTION OF BACKFILL MATERIALS; AGGREGATE BASE FOR ROADS, PADS, AND ANCHORS; ASPHALT PAVING; AND SHAFT BACKFILL FOR CONCRETE AND WOOD POLES, BY INDEPENDENT THIRD PARTY AGENCY.
 4. PRE- AND POST-CONSTRUCTION ROOFTOP AND STRUCTURAL INSPECTIONS ON EXISTING FACILITIES.
 5. TOWER ERECTION SECTION STACKING AND PLATFORM ATTACHMENT DOCUMENTED BY DIGITAL PHOTOGRAPHS BY THIRD PARTY AGENCY.
 6. ANTENNA AZIMUTH, DOWN TILT AND PER SUNLIGHT TOOL SUNSIGHT INSTRUMENTS - ANTENNA ALIGNMENT TOOL (AAT)

PLANS PREPARED FOR:



PLANS PREPARED BY:



MLA PARTNER:



ENGINEERING LICENSE:



DRAWING NOTICE:

THESE DOCUMENTS ARE CONFIDENTIAL AND ARE THE SOLE PROPERTY OF SPRINT AND MAY NOT BE REPRODUCED, DISSEMINATED OR REDISTRIBUTED WITHOUT THE EXPRESS WRITTEN CONSENT OF SPRINT.

REVISIONS:

DESCRIPTION	DATE	BY	REV
ISSUED FOR PERMIT	07/16/14	AHS	2
ISSUED FOR PERMIT	07/17/14	AHS	1
ISSUED FOR PERMIT	06/10/14	DJB	0
ISSUED FOR REVIEW	05/28/14	MAP	A

SITE NAME:

ANSONIA WAKELEE

SITE CASCADE:

CT03XC005

SITE ADDRESS:

**401 WAKELEE AVENUE
ANSONIA, CT 06401**

SHEET DESCRIPTION:

SPRINT SPECIFICATIONS

SHEET NUMBER:

SP-2

CONTINUE FROM SP-2

7. VERIFICATION DOCUMENTED WITH THE ANTENNA CHECKLIST REPORT, BY A&E, SITE DEVELOPMENT REP, OR RF REP.
 8. FINAL INSPECTION CHECKLIST AND HANDOFF WALK (HOC). SIGNED FORM SHOWING ACCEPTANCE BY FIELD OPS IS TO BE UPLOADED INTO SMS.
 9. COAX SWEEP AND FIBER TESTING DOCUMENTS SUBMITTED VIA SMS FOR RF APPROVAL.
 10. SCAN-ABLE BARCODE PHOTOGRAPHS OF TOWER TOP AND INACCESSIBLE SERIALIZED EQUIPMENT
 11. ALL AVAILABLE JURISDICTIONAL INFORMATION
 12. PDF SCAN OF REDLINES PRODUCED IN FIELD
- C. THE CONTRACTOR SHALL BE RESPONSIBLE FOR ANY AND ALL CORRECTIONS TO ANY WORK IDENTIFIED AS UNACCEPTABLE IN SITE INSPECTION ACTIVITIES AND/OR AS A RESULT OF TESTING.
- D. CONSTRUCTION INSPECTIONS AND CORRECTIVE MEASURES SHALL BE DOCUMENTED BY THE CONTRACTOR WITH WRITTEN REPORTS AND PHOTOGRAPHS. PHOTOGRAPHS MUST BE DIGITAL AND OF SUFFICIENT QUALITY TO CLEARLY SHOW THE SITE CONSTRUCTION. PHOTOGRAPHS MUST CLEARLY IDENTIFY THE PHOTOGRAPHED ITEM AND BE LABELED WITH THE SITE CASCADE NUMBER, SITE NAME, DESCRIPTION, AND DATE.
- 3.4 DELIVERABLES: TEST AND INSPECTION REPORTS AND CLOSEOUT DOCUMENTATION SHALL BE UPLOADED TO THE SMS AND/OR FORWARDED TO SPRINT FOR INCLUSION INTO THE PERMANENT SITE FILES.
- A. THE FOLLOWING TEST AND INSPECTION REPORTS SHALL BE PROVIDED AS APPLICABLE.
1. CONCRETE MIX AND CYLINDER BREAK REPORTS.
 2. STRUCTURAL BACKFILL COMPACTION REPORTS.
 3. SITE RESISTANCE TO EARTH TEST.
 4. ANTENNA AZIMUTH AND DOWN TILT VERIFICATION
 5. TOWER ERECTION INSPECTIONS AND MEASUREMENTS DOCUMENTING TOWER INSTALLED PER SUPPLIER'S REQUIREMENTS AND THE APPLICABLE SECTIONS HEREIN.
 6. COAX CABLE SWEEP TESTS PER COMPANY'S "ANTENNA LINE ACCEPTANCE STANDARDS".
- B. REQUIRED CLOSEOUT DOCUMENTATION INCLUDES THE FOLLOWING;
1. TEST WELLS AND TRENCHES: PHOTOGRAPHS OF ALL TEST WELLS; PHOTOGRAPHS SHOWING ALL OPEN EXCAVATIONS AND TRENCHING PRIOR TO BACKFILLING SHOWING A TAPE MEASURE VISIBLE IN THE EXCAVATIONS INDICATING DEPTH.
 2. CONDUITS, CONDUCTORS AND GROUNDING: PHOTOGRAPHS SHOWING TYPICAL INSTALLATION OF CONDUCTORS AND CONNECTORS; PHOTOGRAPHS SHOWING TYPICAL BEND RADIUS OF INSTALLED GROUND WIRES AND GROUND ROD SPACING;
 3. CONCRETE FORMS AND REINFORCING: CONCRETE FORMING AT TOWER AND EQUIPMENT/SHELTER PAD/FOUNDATIONS - PHOTOGRAPHS SHOWING ALL REINFORCING STEEL, UTILITY AND CONDUIT STUB OUTS; PHOTOGRAPHS SHOWING CONCRETE POUR OF SHELTER SLAB/FOUNDATION, TOWER FOUNDATION AND GUY ANCHORS WITH VIBRATOR IN USE; PHOTOGRAPHS SHOWING EACH ANCHOR ON GUYED TOWERS, BEFORE CONCRETE POUR.
 4. TOWER, ANTENNAS AND MAINLINE: INSPECTION AND PHOTOGRAPHS OF SECTION STACKING; INSPECTION AND PHOTOGRAPHS OF PLATFORM COMPONENT ATTACHMENT POINTS; PHOTOGRAPHS OF TOWER TOP GROUNDING; PHOTOS OF TOWER COAX LINE COLOR CODING AT THE TOP AND AT GROUND LEVEL; INSPECTION AND PHOTOGRAPHS OF OPERATIONAL OF TOWER LIGHTING, AND PLACEMENT OF FAA REGISTRATION SIGN; PHOTOGRAPHS SHOWING ADDITIONAL GROUNDING POINTS FOR TOWERS GREATER THAN 200 FEET.; PHOTOS OF ANTENNA GROUND BAR, EQUIPMENT GROUND BAR, AND MASTER GROUND BAR; PHOTOS OF GPS ANTENNA(S); PHOTOS OF EACH SECTOR OF ANTENNAS; ONE PHOTOGRAPH LOOKING AT THE SECTOR AND ONE FROM BEHIND SHOWING THE PROJECTED COVERAGE AREA; PHOTOS OF COAX WEATHERPROOFING - TOP AND BOTTOM; PHOTOS OF COAX GROUNDING--TOP AND BOTTOM; PHOTOS OF ANTENNA AND MAST GROUNDING; PHOTOS OF COAX CABLE ENTRY INTO SHELTER; PHOTOS OF PLATFORM MECHANICAL CONNECTIONS TO TOWER/MONOPOLE.
 5. ROOF TOPS: PRE-CONSTRUCTION AND POST-CONSTRUCTION VISUAL INSPECTION AND PHOTOGRAPHS OF THE ROOF AND INTERIOR TO DETERMINE AND DOCUMENT CONDITIONS; ROOF TOP CONSTRUCTION INSPECTIONS AS REQUIRED BY THE JURISDICTION; PHOTOGRAPHS OF CABLE TRAY AND/OR ICE BRIDGE; PHOTOGRAPHS OF DOGHOUSE/CABLE EXIT FROM ROOF;
 6. SITE LAYOUT - PHOTOGRAPHS OF THE OVERALL COMPOUND, INCLUDING EQUIPMENT PLATFORM FROM ALL FOUR CORNERS.
 7. FINISHED UTILITIES: CLOSE-UP PHOTOGRAPHS OF THE PPC BREAKER PANEL; CLOSE-UP PHOTOGRAPH OF THE INSIDE OF THE TELCO PANEL AND NIU; CLOSE-UP PHOTOGRAPH OF THE POWER METER AND DISCONNECT; PHOTOS OF POWER AND TELCO ENTRANCE TO COMPANY ENCLOSURE; PHOTOGRAPHS AT METER BOX AND/OR FACILITY DISTRIBUTION PANEL
 8. REQUIRED MATERIALS CERTIFICATIONS: CONCRETE MIX DESIGNS; MILL CERTIFICATION FOR ALL REINFORCING AND STRUCTURAL STEEL; AND ASPHALT PAVING MIX DESIGN.
 9. ANY AND ALL SUBMITTALS BY THE JURISDICTION OR COMPANY.

SECTION 01 400 - SUBMITTALS & TESTS

PART 1 - GENERAL

- 1.1 THE WORK: THESE STANDARD CONSTRUCTION SPECIFICATIONS IN CONJUNCTION WITH THE OTHER CONTRACT DOCUMENTS AND THE CONSTRUCTION DRAWINGS DESCRIBE THE WORK TO BE PERFORMED BY THE CONTRACTOR.
- 1.2 RELATED DOCUMENTS:
 - A. THE REQUIREMENTS OF THIS SECTION APPLY TO ALL SECTIONS IN THIS SPECIFICATION.
 - B. SPRINT "STANDARD CONSTRUCTION DETAILS FOR WIRELESS SITES" ARE INCLUDED IN AND MADE A PART OF THESE SPECIFICATIONS HERewith.

PART 2 - PRODUCTS (NOT USED)

PART 3 - EXECUTION

- 3.1 WEEKLY REPORTS:
 - A. CONTRACTOR SHALL PROVIDE SPRINT WITH WEEKLY REPORTS SHOWING PROJECT STATUS. THIS STATUS REPORT FORMAT WILL BE PROVIDED TO THE CONTRACTOR BY SPRINT. THE REPORT WILL CONTAIN SITE ID NUMBER, THE MILESTONES FOR EACH SITE, INCLUDING THE BASELINE DATE, ESTIMATED COMPLETION DATE AND ACTUAL COMPLETION DATE.
 - B. REPORT INFORMATION WILL BE TRANSMITTED TO SPRINT VIA ELECTRONIC MEANS AS REQUIRED. THIS INFORMATION WILL PROVIDE A BASIS FOR PROGRESS MONITORING AND PAYMENT.
- 3.2 PROJECT CONFERENCE CALLS:
 - A. SPRINT MAY HOLD WEEKLY PROJECT CONFERENCE CALLS. CONTRACTOR WILL BE REQUIRED TO COMMUNICATE SITE STATUS, MILESTONE COMPLETIONS AND UPCOMING MILESTONE PROJECTIONS, AND ANSWER ANY OTHER SITE STATUS QUESTIONS AS NECESSARY.
- 3.3 PROJECT TRACKING IN SMS:
 - A. CONTRACTOR SHALL PROVIDE SCHEDULE UPDATES AND PROJECTIONS IN THE SMS SYSTEM ON A WEEKLY BASIS.
- 3.4 ADDITIONAL REPORTING:
 - A. ADDITIONAL OR ALTERNATE REPORTING REQUIREMENTS MAY BE ADDED TO THE REPORT AS DETERMINED TO BE REASONABLY NECESSARY BY COMPANY.
- 3.5 PROJECT PHOTOGRAPHS:
 - A. FILE DIGITAL PHOTOGRAPHS OF COMPLETED SITE IN JPEG FORMAT IN THE SMS PHOTO LIBRARY FOR THE RESPECTIVE SITE. PHOTOGRAPHS SHALL BE CLEARLY LABELED WITH SITE NUMBER, NAME AND DESCRIPTION, AND SHALL INCLUDE AT A MINIMUM THE FOLLOWING AS APPLICABLE:
 1. SHELTER AND TOWER OVERVIEW.
 2. TOWER FOUNDATION(S) - FORMS AND STEEL BEFORE POUR (EACH ANCHOR ON GUYED TOWERS).
 3. TOWER FOUNDATION(S) POUR WITH VIBRATOR IN USE (EACH ANCHOR ON GUYED TOWERS).
 4. TOWER STEEL AS BEING INSTALLED INTO HOLE (SHOW ANCHOR STEEL ON GUYED TOWERS).
 5. PHOTOS OF TOWER SECTION STACKING.
 6. CONCRETE TESTING / SAMPLES.
 7. PLACING OF ANCHOR BOLTS IN TOWER FOUNDATION.
 8. BUILDING/WATER TANK FROM ROAD FOR TENANT IMPROVEMENTS OR COMMENTS.
 9. SHELTER FOUNDATION--FORMS AND STEEL BEFORE POURING.
 10. SHELTER FOUNDATION POUR WITH VIBRATOR IN USE.
 11. COAX CABLE ENTRY INTO SHELTER.
 12. PLATFORM MECHANICAL CONNECTIONS TO TOWER/MONOPOLE.
 13. ROOFTOP PRE AND POST CONSTRUCTION PHOTOS TO INCLUDE PENETRATIONS AND INTERIOR CEILING.
 14. PHOTOS OF TOWER TOP COAX LINE COLOR CODING AND COLOR CODING AT GROUND LEVEL.
 15. PHOTOS OF ALL APPROPRIATE COMPANY OR REGULATORY SIGNAGE.
 16. PHOTOS OF EQUIPMENT BOLT DOWN INSIDE SHELTER.
 17. POWER AND TELCO ENTRANCE TO COMPANY ENCLOSURE AND POWER AND TELCO SUPPLY LOCATIONS INCLUDING METER/DISCONNECT.
 18. ELECTRICAL TRENCH(S) WITH ELECTRICAL / CONDUIT BEFORE BACKFILL.
 19. ELECTRICAL TRENCH(S) WITH FOIL-BACKED TAPE BEFORE FURTHER BACKFILL.
 20. TELCO TRENCH WITH TELEPHONE / CONDUIT BEFORE BACKFILL.
 21. TELCO TRENCH WITH FOIL-BACKED TAPE BEFORE FURTHER BACKFILL.
 22. SHELTER GROUND-RING TRENCH WITH GROUND-WIRE BEFORE BACKFILL (SHOW ALL CAD WELDS AND BEND RADII).
 23. TOWER GROUND-RING TRENCH WITH GROUND-WIRE BEFORE BACKFILL (SHOW ALL CAD WELDS AND BEND RADII).

24. FENCE GROUND-RING TRENCH WITH GROUND-WIRE BEFORE BACKFILL (SHOW ALL CAD WELDS AND BEND RADII).
 25. ALL BTS GROUND CONNECTIONS.
 26. ALL GROUND TEST WELLS.
 27. ANTENNA GROUND BAR AND EQUIPMENT GROUND BAR.
 28. ADDITIONAL GROUNDING POINTS ON TOWERS ABOVE 200'.
 29. HVAC UNITS INCLUDING CONDENSERS ON SPLIT SYSTEMS.
 30. GPS ANTENNAS.
 31. CABLE TRAY AND/OR WAVEGUIDE BRIDGE.
 32. DOGHOUSE/CABLE EXIT FROM ROOF.
 33. EACH SECTOR OF ANTENNAS; ONE PHOTOGRAPH LOOKING AT THE SECTOR AND ONE FROM BEHIND SHOWING THE PROJECTED COVERAGE AREA.
 34. MASTER BUS BAR.
 35. TELCO BOARD AND NIU.
 36. ELECTRICAL DISTRIBUTION WALL.
 37. CABLE ENTRY WITH SURGE SUPPRESSION.
 38. ENTRANCE TO EQUIPMENT ROOM.
 39. COAX WEATHERPROOFING--TOP AND BOTTOM OF TOWER.
 40. COAX GROUNDING --TOP AND BOTTOM OF TOWER.
 41. ANTENNA AND MAST GROUNDING.
 42. LANDSCAPING - WHERE APPLICABLE.
- 3.6 FINAL PROJECT ACCEPTANCE: COMPLETE ALL REQUIRED REPORTING TASKS PER CONTRACT, CONTRACT DOCUMENTS OR THE SPRINT INTEGRATED CONSTRUCTION STANDARDS FOR WIRELESS SITES AND UPLOAD INTO SITERRA.

PLANS PREPARED FOR:



6580 Sprint Parkway
Overland Park, Kansas 66251

PLANS PREPARED BY:



Design. Build. Deliver.

1033 Walerviet Shaker Rd
Albany, NY 12205
Office # (518) 690-0790
Fax # (518) 690-0793

JOB NUMBER 340-000

MLA PARTNER:



10 PRESIDENTIAL WAY
WOBURN, MA 01801

ENGINEERING LICENSE:



DRAWING NOTICE:

THESE DOCUMENTS ARE CONFIDENTIAL AND ARE THE SOLE PROPERTY OF SPRINT AND MAY NOT BE REPRODUCED, DISSEMINATED OR REDISTRIBUTED WITHOUT THE EXPRESS WRITTEN CONSENT OF SPRINT.

REVISIONS:

DESCRIPTION	DATE	BY	REV
ISSUED FOR PERMIT	07/16/14	AHS	2
ISSUED FOR PERMIT	07/11/14	AHS	1
ISSUED FOR PERMIT	06/10/14	DJG	0
ISSUED FOR REVIEW	05/28/14	MAP	A

SITE NAME:

ANSONIA WAKELEE

SITE CASCADE:

CT03XC005

SITE ADDRESS:

**401 WAKELEE AVENUE
ANSONIA, CT 06401**

SHEET DESCRIPTION:

SPRINT SPECIFICATIONS

SHEET NUMBER:

SP-3

INFORMATION CONTAINED WITHIN DRAWINGS ARE BASED ON PROVIDED INFORMATION AND ARE NOT THE RESULT OF A FIELD SURVEY.

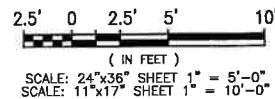
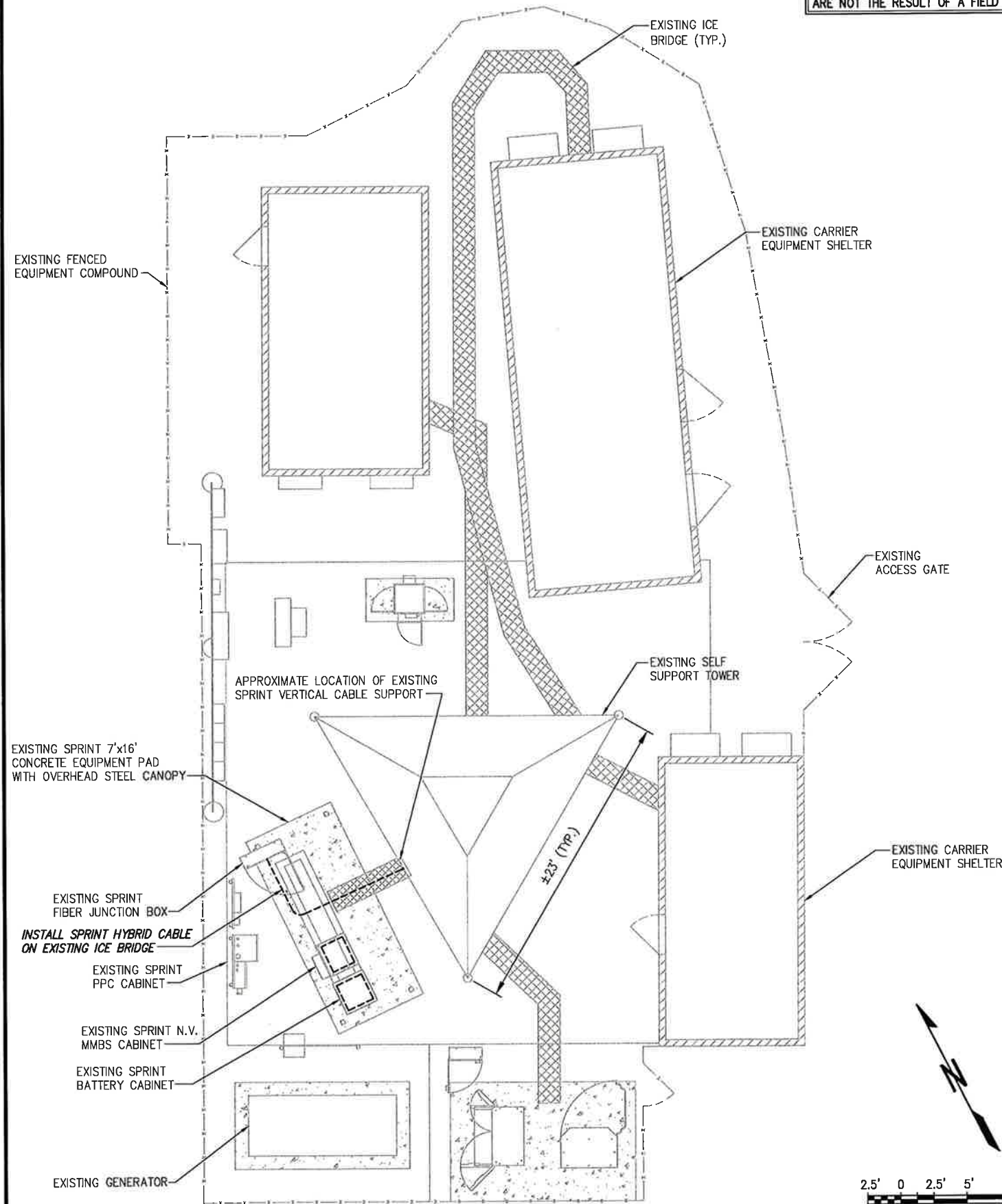

OVERALL SITE PLAN

SCALE: AS NOTED 1

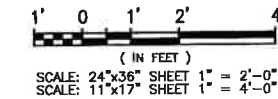
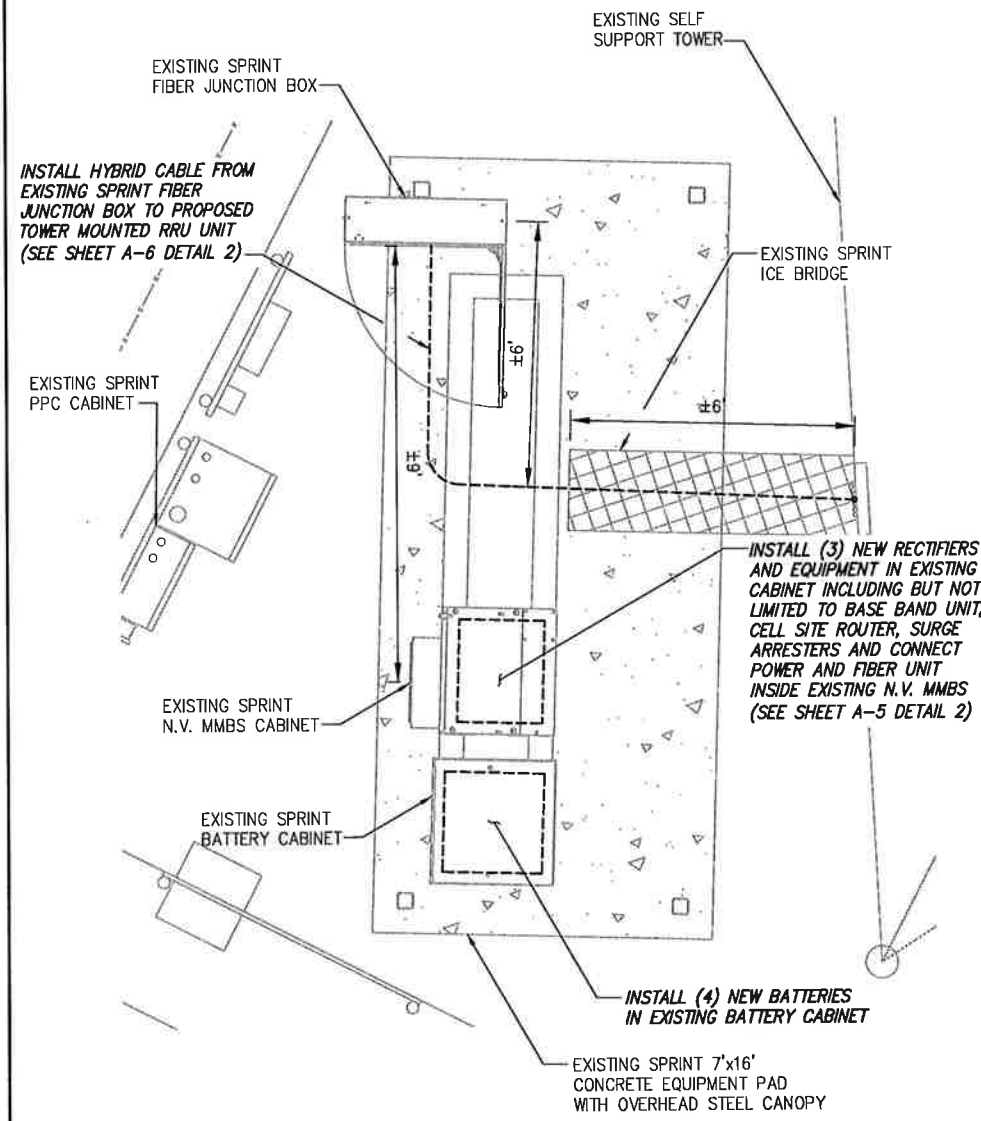

SPRINT EQUIPMENT PLAN

SCALE: AS NOTED 2

PLANS PREPARED FOR:

Sprint

6580 Sprint Parkway
Overland Park, Kansas 66251

PLANS PREPARED BY:

INFINIGY Design. Build. Deliver.

1033 Watervliet Shaker Rd
Albany, NY 12205
Office # (518) 690-0790
Fax # (518) 690-0793

JOB NUMBER 340-000

MLA PARTNER:

AMERICAN TOWER CORPORATION

10 PRESIDENTIAL WAY
WOBURN, MA 01801

ENGINEERING LICENSE:

STATE OF CONNECTICUT
JOHN S. STEVENS
No. 24705
LICENSED PROFESSIONAL ENGINEER

DRAWING NOTICE:

THESE DOCUMENTS ARE CONFIDENTIAL AND ARE THE SOLE PROPERTY OF SPRINT AND MAY NOT BE REPRODUCED, DISSEMINATED OR REDISTRIBUTED WITHOUT THE EXPRESS WRITTEN CONSENT OF SPRINT.

REVISIONS:	DESCRIPTION	DATE	BY	REV
ISSUED FOR PERMIT		07/16/14	AHS	2
ISSUED FOR PERMIT		07/11/14	AHS	1
ISSUED FOR PERMIT		06/10/14	DJG	0
ISSUED FOR REVIEW		05/28/14	MAP	A

SITE NAME:

ANSONIA WAKELEE

SITE CASCADE:

CT03XC005

SITE ADDRESS:

**401 WAKELEE AVENUE
ANSONIA, CT 06401**

SHEET DESCRIPTION:

SITE PLAN

SHEET NUMBER:

A-1

INFORMATION CONTAINED WITHIN DRAWINGS ARE BASED ON PROVIDED INFORMATION AND ARE NOT THE RESULT OF A FIELD SURVEY.

NO PHOTO OF EXISTING CABINET LINE-UP LOCATED WITHIN 2.5 AUDIT PACKAGE. LOCATION OF EXISTING LOCATION BASED ON N.V. CDS

EXISTING CABINET LINE-UP

SCALE: AS NOTED 1



INSTALL (4) NEW BATTERIES IN EXISTING BATTERY CABINET

EXISTING BATTERY (TYP. OF (4) PER STRING)

EXISTING SPRINT BATTERY CABINET

EXISTING BATTERY CABINET

SCALE: AS NOTED 2

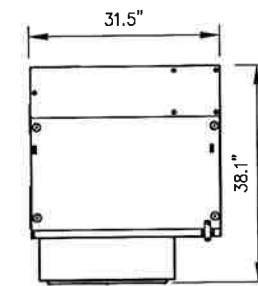

TOP VIEW

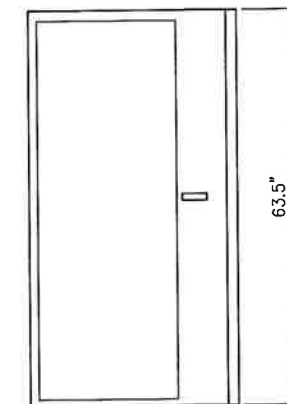

FRONT VIEW

MANUFACTURER: ALU
MODEL: 9927

N.V. MMBS CABINET

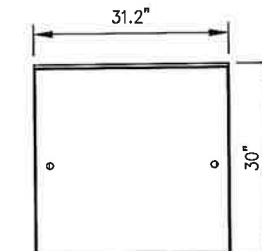

TOP VIEW

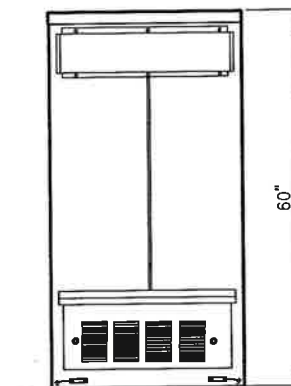

REAR VIEW

MANUFACTURER: TBD
MODEL: 60ECV2

BATTERY CABINET

INFORMATION SHOWN ABOVE BASED ON INFORMATION CONTAINED WITHIN SPRINT 2.5 AUDIT. CONTRACTOR TO VERIFY IN FIELD EXACT MAKE AND MODEL.

EXISTING CABINET DETAILS

SCALE: AS NOTED 3

PLANS PREPARED FOR:



PLANS PREPARED BY:



MLA PARTNER:



ENGINEERING LICENSE:



DRAWING NOTICE:

THESE DOCUMENTS ARE CONFIDENTIAL AND ARE THE SOLE PROPERTY OF SPRINT AND MAY NOT BE REPRODUCED, DISSEMINATED OR REDISTRIBUTED WITHOUT THE EXPRESS WRITTEN CONSENT OF SPRINT.

REVISIONS:

DESCRIPTION	DATE	BY	REV
ISSUED FOR PERMIT	07/16/14	AHS	2
ISSUED FOR PERMIT	07/11/14	AHS	1
ISSUED FOR PERMIT	06/10/14	DJG	0
ISSUED FOR REVIEW	05/28/14	MAP	A

SITE NAME:

ANSONIA WAKELEE

SITE CASCADE:

CT03XC005

SITE ADDRESS:

**401 WAKELEE AVENUE
ANSONIA, CT 06401**

SHEET DESCRIPTION:

**EXISTING
EQUIPMENT DETAILS**

SHEET NUMBER:

A-1A

NOTE:
 INFINIGY ENGINEERING HAS NOT EVALUATED THE EXISTING TOWER OR MOUNT FOR THIS SITE, AND ASSUMES NO RESPONSIBILITY FOR ITS STRUCTURAL INTEGRITY. REFER TO STRUCTURAL ANALYSIS BY OTHERS PRIOR TO ANY CONSTRUCTION.

NOTE:
 SPRINT TOWER TOP WORK CONTINGENT ON FOLLOWING: COMPLETION OF STRUCTURAL ANALYSIS PROVIDED BY AMERICAN TOWER CORP., COMPLETION OF ANTENNA/RRH MOUNTING ASSESSMENT (PROVIDED BY AE)

NOTE:
 SEE DETAIL 2 ON A-3 FOR ANTENNA LAYOUT

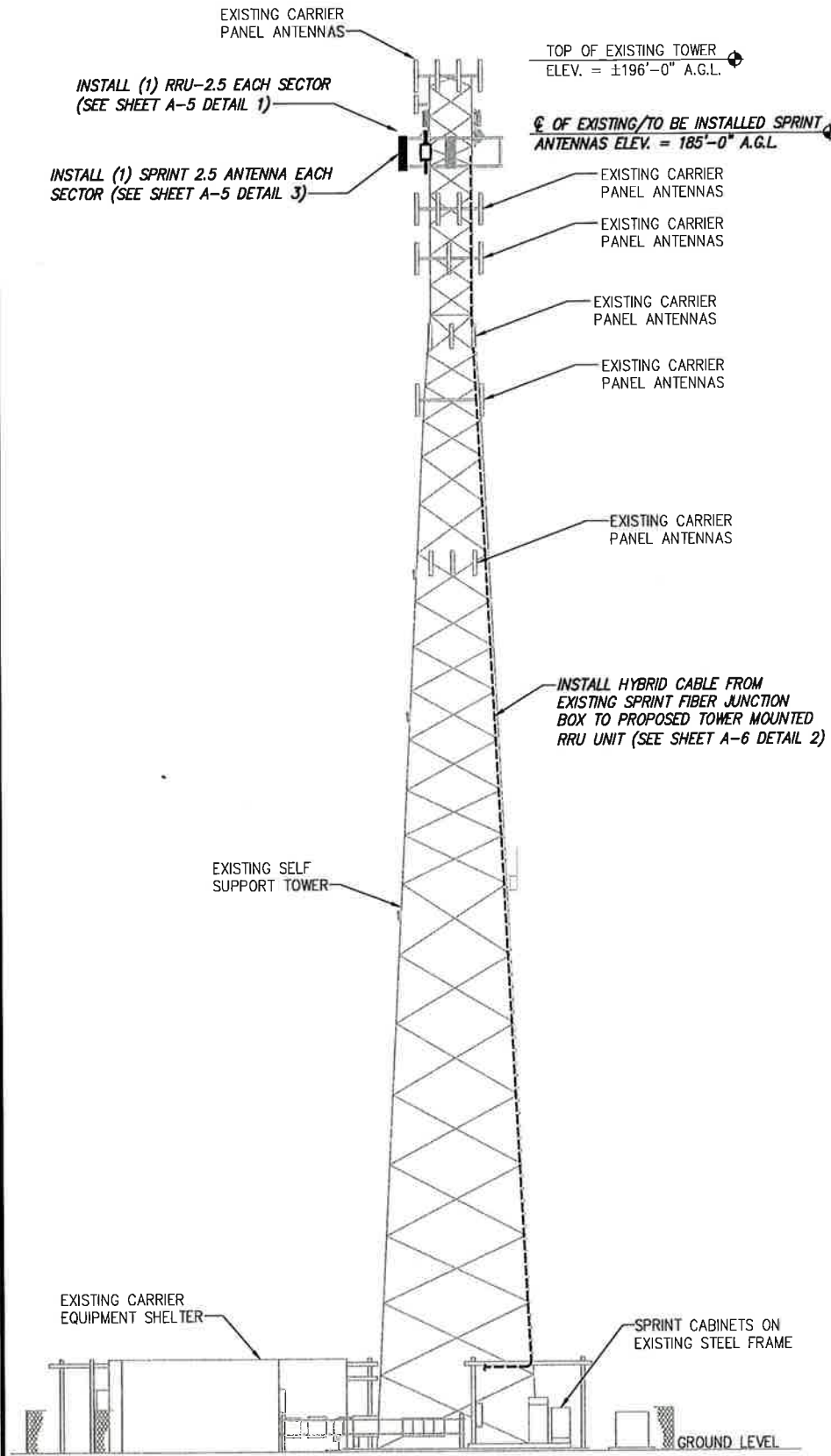

TOWER ELEVATION

NO SCALE

1

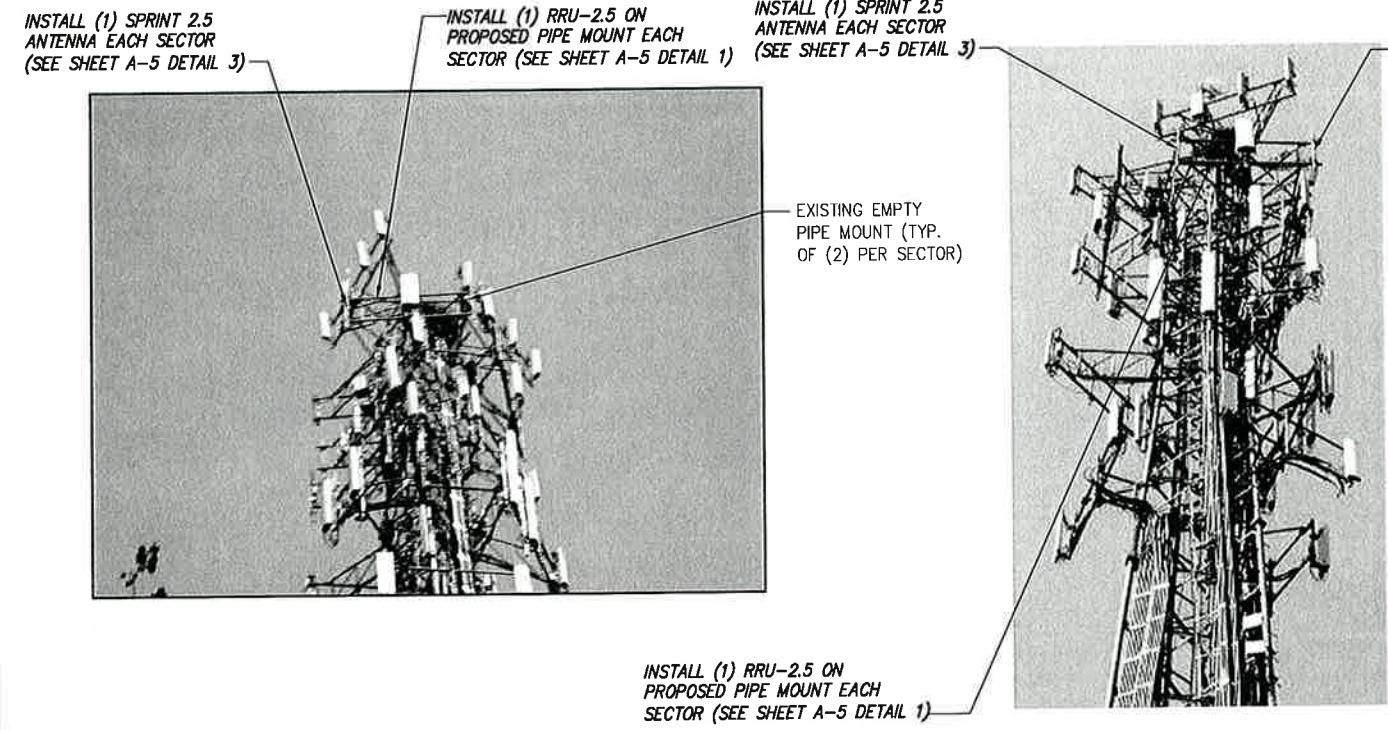

ALPHA

BETA

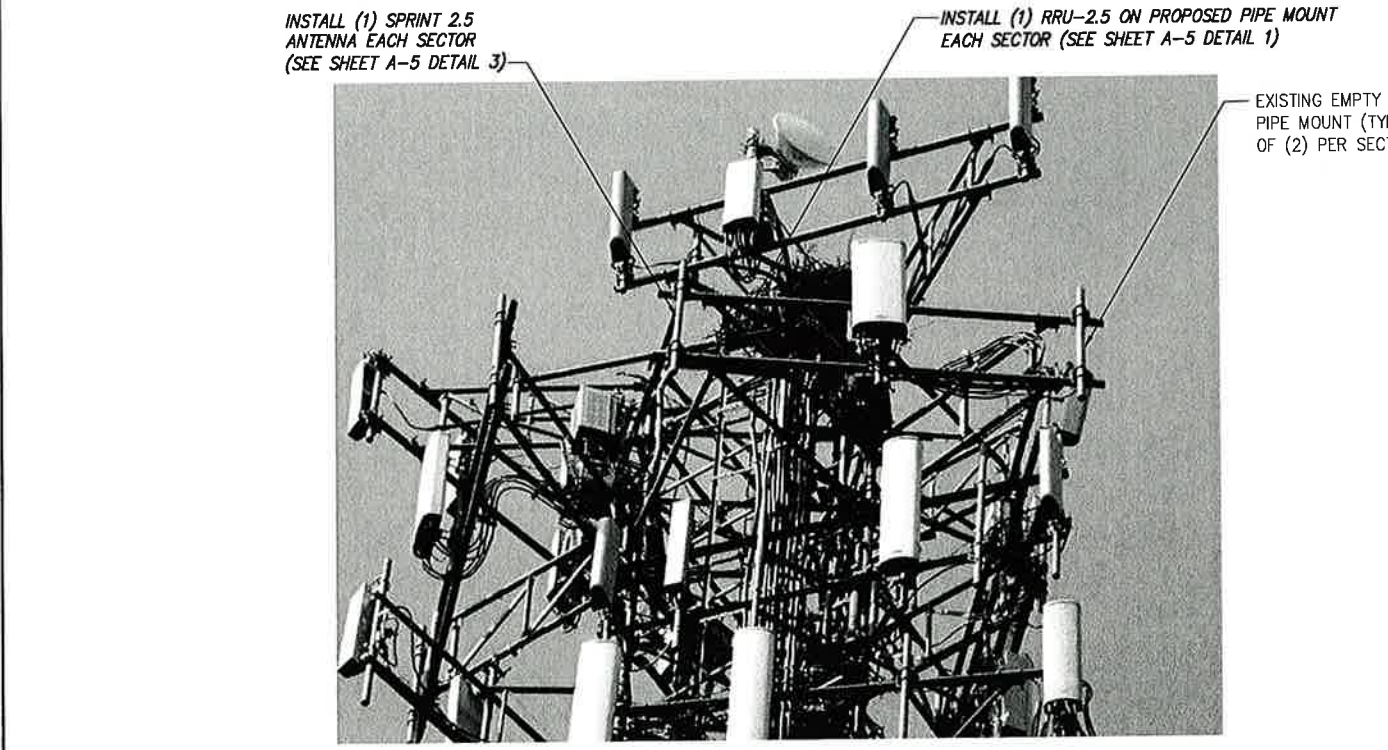

GAMMA

PHOTOS

NO SCALE

2

PLANS PREPARED FOR:

Sprint

6580 Sprint Parkway
 Overland Park, Kansas 66251

PLANS PREPARED BY:

INFINIGY Design. Build. Deliver.

1033 Watervliet Shaker Rd
 Albany, NY 12205
 Office # (518) 690-0780
 Fax # (518) 690-0793

JOB NUMBER 340-000

MLA PARTNER:

AMERICAN TOWER CORPORATION

10 PRESIDENTIAL WAY
 WOBURN, MA 01801

ENGINEERING LICENSE:

DRAWING NOTICE:

THESE DOCUMENTS ARE CONFIDENTIAL AND ARE THE SOLE PROPERTY OF SPRINT AND MAY NOT BE REPRODUCED, DISSEMINATED OR REDISTRIBUTED WITHOUT THE EXPRESS WRITTEN CONSENT OF SPRINT.

REVISIONS:

DESCRIPTION	DATE	BY	REV
ISSUED FOR PERMIT	07/16/14	AHS	2
ISSUED FOR PERMIT	07/11/14	AHS	1
ISSUED FOR PERMIT	06/10/14	DJG	0
ISSUED FOR REVIEW	05/28/14	MAP	A

SITE NAME:

ANSONIA WAKELEE

SITE CASCADE:

CT03XC005

SITE ADDRESS:

**401 WAKELEE AVENUE
 ANSONIA, CT 06401**

SHEET DESCRIPTION:

TOWER ELEVATION & CABLE PLAN

SHEET NUMBER:

A-2

NV CABLES				
BAND	INDICATOR		PORT	COLOR
800-1	YEL	GRN	NV-1	GRN
1900-1	YEL	RED	NV-2	BLU
1900-2	YEL	BRN	NV-3	BRN
1900-3	YEL	BLU	NV-4	WHT
1900-4	YEL	SLT	NV-5	RED
800-2	YEL	ORG	NV-6	SLT
SPARE	YEL	WHT	NV-7	PPL
2500	YEL	PPL	NV-8	ORG

HYBRID	
HYBRID	COLOR
1	GRN
2	BLU
3	BRN
4	WHT
5	RED
6	SLT
7	PPL
8	ORG

2.5 Band		
2500 Radio 1	COLOR	
YEL WHT	GRN	
YEL WHT	BLU	
YEL WHT	BRN	
YEL WHT	WHT	
YEL WHT	RED	
YEL WHT	SLT	
YEL WHT	PPL	
YEL WHT	ORG	

Figure 1: Antenna Orientation

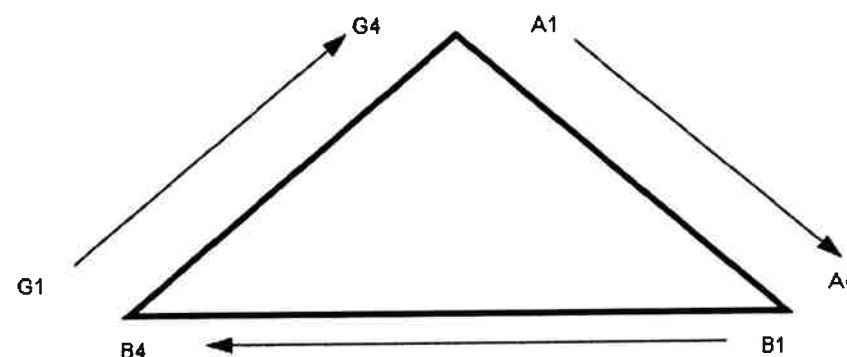

NOTES:

- ALL CABLES SHALL BE MARKED WITH 2" WIDE, UV STABILIZED, UL APPROVED TAPE.
- THE FIRST RING SHALL BE CLOSEST TO THE END OF THE CABLE AND SPACED APPROXIMATELY 2" FROM THE END CONNECTOR, WEATHERPROOFING, OR BREAK-OUT CYLINDER. THERE SHALL BE A 1" SPACE BETWEEN EACH RING FOR THE CABLE IDENTIFIER, AND NO SPACES BETWEEN THE FREQUENCY BANDS.
- A 2" GAP SHALL SEPARATE THE CABLE COLOR CODE FROM THE FREQUENCY COLOR CODE. THE 2" COLOR RINGS FOR THE FREQUENCY CODE SHALL BE PLACED NEXT TO EACH OTHER WITH NO SPACES.
- THE 2" COLORED TAPE(S) SHALL EACH BE WRAPPED A MINIMUM OF 3 TIMES AROUND THE INDIVIDUAL CABLES, AND THE TAPE SHALL BE KEPT IN THE SAME LOCATION AS MUCH AS POSSIBLE.
- SITES WITH MORE THAN FOUR (4) SECTORS WILL REQUIRE ADDITIONAL RINGS FOR EACH SECTOR, FOLLOWING THE PATTERN. HIGH CAPACITY SITES WILL USE THE NEXT COLOR IN THE SEQUENCE FOR ADDITIONAL CABLES IN EACH SECTOR.
- HYBRID FIBER CABLE SHALL BE SECTOR IDENTIFIED INSIDE THE CABINET ON FREQUENCY BUNDLES, ON THE SEALTITE, ON THE MAIN LINE UPON EXIT OF SEALTITE, AND BEFORE AND AFTER THE BREAKOUT UNIT (MEDUSA), AS WELL AS BEFORE AND AFTER ANY ENTRANCE OR EXIT.
- HFC "MAIN TRUNK" WILL NOT BE MARKED WITH THE FREQUENCY CODES, AS IT CONTAINS ALL FREQUENCIES.
- INDIVIDUAL POWER PAIRS AND FIBER BUNDLES SHALL BE LABELED WITH BOTH THE CABLE AND FREQUENCY.

Sector	Cable	First Ring	Second Ring	Third Ring
1 Alpha	1	Green	No Tape	No Tape
	2	Blue	No Tape	No Tape
	3	White	No Tape	No Tape
	4	White	No Tape	No Tape
	5	Red	No Tape	No Tape
	6	Grey	No Tape	No Tape
	7	Purple	No Tape	No Tape
	8	Orange	No Tape	No Tape
2 Beta	1	Green	Green	No Tape
	2	Blue	Blue	No Tape
	3	White	White	No Tape
	4	White	White	No Tape
	5	Red	Red	No Tape
	6	Grey	Grey	No Tape
	7	Purple	Purple	No Tape
	8	Orange	Orange	No Tape
3 Gamma	1	Green	Green	Green
	2	Blue	Blue	Blue
	3	White	White	White
	4	White	White	White
	5	Red	Red	Red
	6	Grey	Grey	Grey
	7	Purple	Purple	Purple
	8	Orange	Orange	Orange

NV FREQUENCY	INDICATOR	ID
800-1	YEL	GRN
1900-1	YEL	RED
1900-2	YEL	BRN
1900-3	YEL	BLU
1900-4	YEL	SLT
800-1	YEL	ORG
RESERVED	YEL	WHT
RESERVED	YEL	PPL

2.5 FREQUENCY	INDICATOR		ID
2500 -1	YEL	WHT	GRN
2500 -2	YEL	WHT	RED
2500 -3	YEL	WHT	BRN
2500 -4	YEL	WHT	BLU
2500 -5	YEL	WHT	SLT
2500 -6	YEL	WHT	ORG
2500 -7	YEL	WHT	WHT
2500 -8	YEL	WHT	PPL

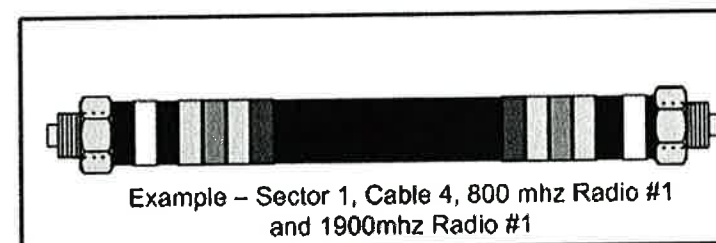
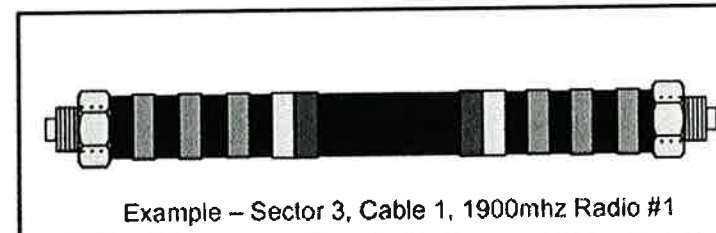
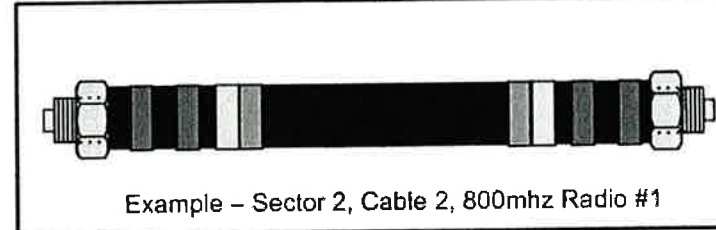

PLANS PREPARED FOR:

6580 Sprint Parkway
Overland Park, Kansas 66251

PLANS PREPARED BY:

Design. Build. Deliver.
1033 Watervliet Shaker Rd
Albany, NY 12205
Office # (518) 690-0790
Fax # (518) 690-0793
JOB NUMBER 340-000

MILA PARTNER:

10 PRESIDENTIAL WAY
WOBURN, MA 01801

ENGINEERING LICENSE:

DRAWING NOTICE:

THESE DOCUMENTS ARE CONFIDENTIAL AND ARE THE SOLE PROPERTY OF SPRINT AND MAY NOT BE REPRODUCED, DISSEMINATED OR REDISTRIBUTED WITHOUT THE EXPRESS WRITTEN CONSENT OF SPRINT.

REVISIONS:

DESCRIPTION	DATE	BY	REV
ISSUED FOR PERMIT	07/16/14	AHS	2
ISSUED FOR PERMIT	07/11/14	AHS	1
ISSUED FOR PERMIT	06/10/14	DJG	0
ISSUED FOR REVIEW	05/28/14	MAP	A

SITE NAME:
ANSONIA WAKELEE

SITE CASCADE:
CT03XC005

SITE ADDRESS:
401 WAKELEE AVENUE
ANSONIA, CT 06401

SHEET DESCRIPTION:
COLOR CODING AND NOTES

SHEET NUMBER:
A-4

RRU: ALCATEL LUCENT TD-RRH8X20

COLOR: LIGHT GREY
WEIGHT: 70 LBS.

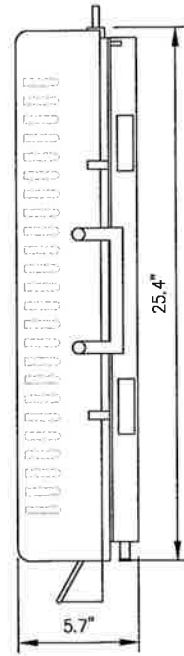

SIDE VIEW

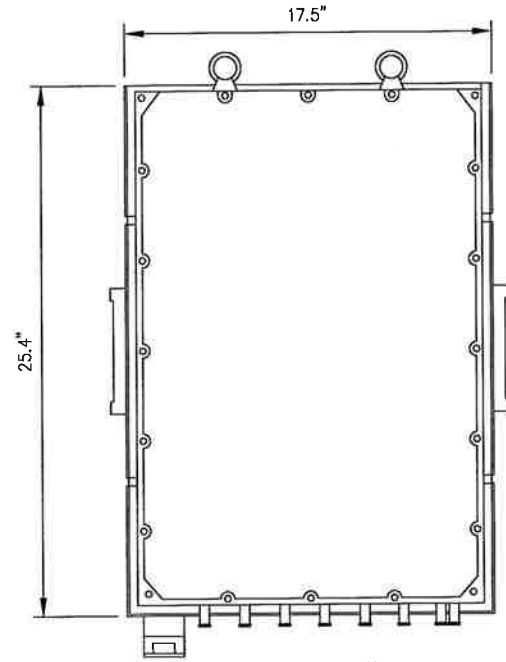

FRONT VIEW

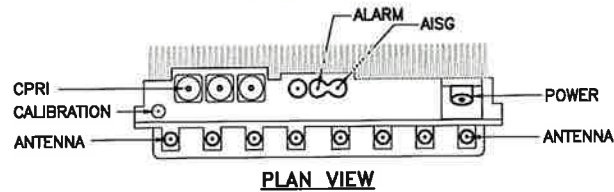

PLAN VIEW

NOTES

COMPLY WITH MANUFACTURERS INSTRUCTIONS TO ENSURE THAT ALL RRU'S RECEIVE ELECTRICAL POWER WITHIN 24 HOURS OF BEING REMOVED FROM THE MANUFACTURER'S PACKAGING. DO NOT OPEN RRU PACKAGES IN THE RAIN.

- DS3 SURGE PROTECTOR
- POWER INJECTOR 5-8
- POWER INJECTOR 1-4
- 7210 SAS-M 2
- 7210 SAS-M 1
- 7205 SAR-8
- LTE-BBU 2.5GHz
- LTE-BBU FDD
- CDMA MT-BBU GROWTH
- CDMA MT-BBU PRIMARY
- PDP1
- PDP2
- 15MHz SPLITTER
- ETHERNET HUB SEC-B
- PRIMARY PROTECTION T1
- SEC-B #1, #1 & #3
- RECTIFIER SHELF PRIMARY
- RECTIFIER SHELF 2.5GHz

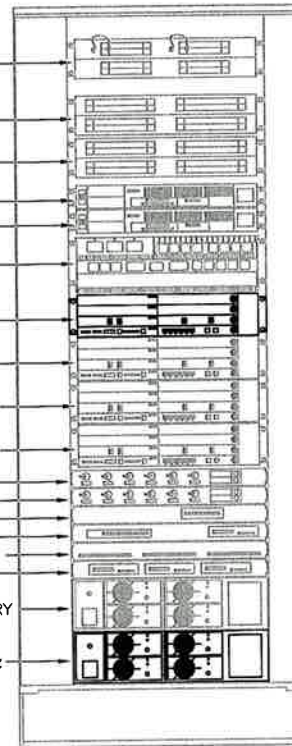

FRONT VIEW

PLANS PREPARED FOR:



PLANS PREPARED BY:



MLA PARTNER:



ENGINEERING LICENSE:



DRAWING NOTICE:

THESE DOCUMENTS ARE CONFIDENTIAL AND ARE THE SOLE PROPERTY OF SPRINT AND MAY NOT BE REPRODUCED, DISSEMINATED OR REDISTRIBUTED WITHOUT THE EXPRESS WRITTEN CONSENT OF SPRINT.

REVISIONS:

DESCRIPTION	DATE	BY	REV
ISSUED FOR PERMIT	07/16/14	AHS	2
ISSUED FOR PERMIT	07/11/14	AHS	1
ISSUED FOR PERMIT	06/10/14	DJG	0
ISSUED FOR REVIEW	05/28/14	MAP	A

SITE NAME:

ANSONIA WAKELEE

SITE CASCADE:

CT03XC005

SITE ADDRESS:

**401 WAKELEE AVENUE
ANSONIA, CT 06401**

SHEET DESCRIPTION:

**EQUIPMENT &
MOUNTING DETAILS**

SHEET NUMBER:

A-5

2.5 RRU

NO SCALE

1

NEW EQUIPMENT IN EXISTING CABINET

NO SCALE

2

ANTENNA: RFS APXVTM14-C-I20

RADOME MATERIAL: ASA
RADOME COLOR: LIGHT GREY
DIMENSIONS, HxWxD.in(mim): 56.3"x12.6"x6.3" (1430x320x160mm)
WEIGHT: 52.9 lbs
CONNECTORS: (8) 4.1/9.5 DIN FEMALE
(1) NF - CALIBRATION CONNECTOR

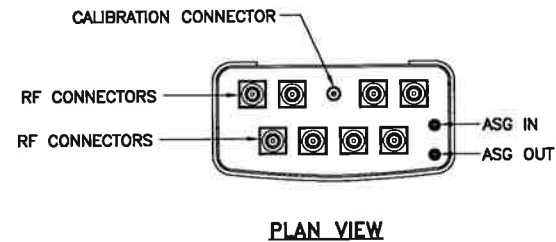

PLAN VIEW



SIDE VIEW

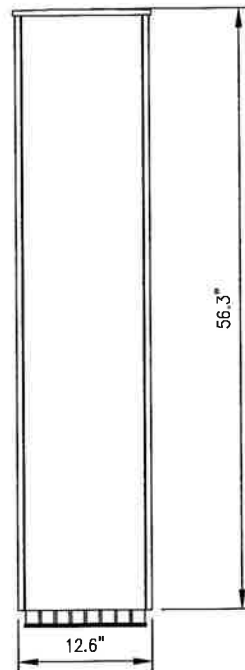

FRONT VIEW

2.5 ANTENNA

NO SCALE

3

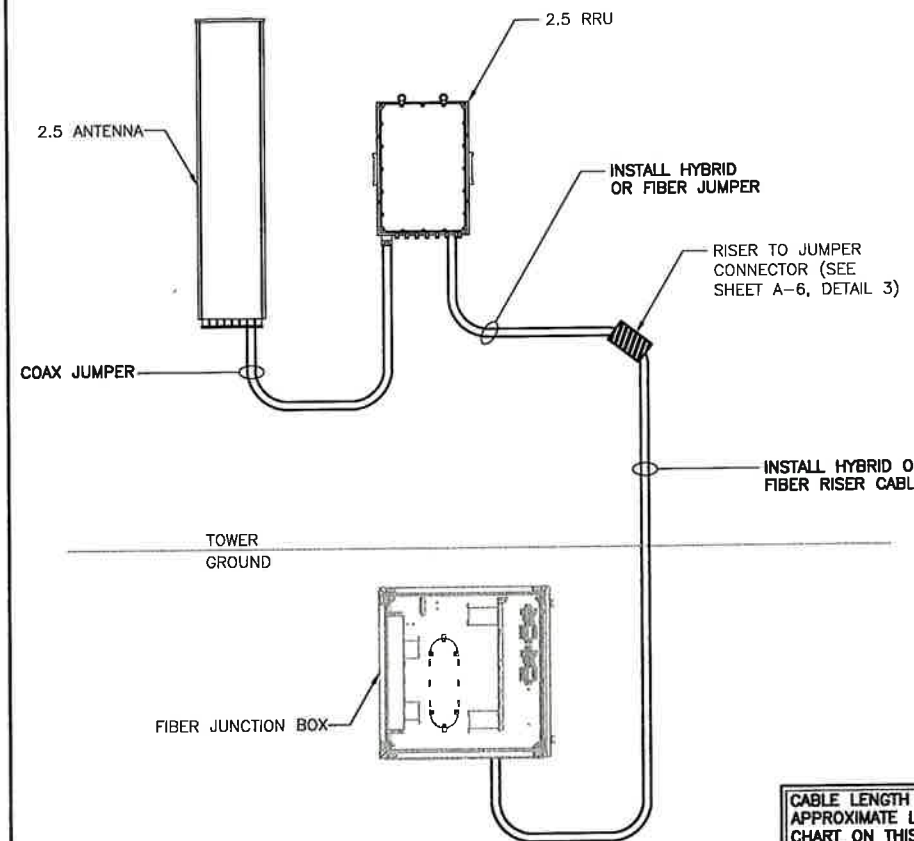

INFINIGY ESTIMATES

* Riser Cable Length Estimate

	Units
At Grade	12 Feet
Vertical Rise	185 Feet
At Sprint Centerline	0 Feet
Sub-Total	197 Feet
15% Buffer	30 Feet
Total	227 Feet

ABOVE LENGTH IS AN ESTIMATE AND SHOULD BE VERIFIED IN FIELD PRIOR TO ORDERING MATERIALS.

** Hybrid/Fiber Jumper Length Estimate

	Units
From Connector To RRU	15 Feet

ABOVE LENGTH IS AN ESTIMATE AND SHOULD BE VERIFIED IN FIELD PRIOR TO ORDERING MATERIALS.

Coax Jumper Length Estimate

	Units
From RRU to Antenna	10 Feet

ABOVE LENGTH IS AN ESTIMATE AND SHOULD BE VERIFIED IN FIELD PRIOR TO ORDERING MATERIALS.

NOTE:
* & **: REFERENCE SHEET A-6, DETAIL 1 FOR CORRESPONDING PART NUMBERS.

CABLE LENGTH NOTE:
APPROXIMATE LENGTH OF NEW CABLE IS SHOWN IN CHART ON THIS SHEET. CONTRACTOR TO CONFIRM EXACT CABLE LENGTH REQUIRED PRIOR TO ORDERING MATERIALS.

CABLEING NOT INCLUDED

NO SCALE

4

RFS HYBRIFLEX RISER CABLE SCHEDULE

Fiber Only (Existing DC Power)	Hybrid cable MN: HB058-M12-050F 12x multi-mode fiber pairs, Top: Outdoor protected connectors, Bottom: LC Connectors, 5/8 cable, 50 ft	50 ft
	MN: HB058-M12-075F	75 ft
	MN: HB058-M12-100F	100 ft
	MN: HB058-M12-125F	125 ft
	MN: HB058-M12-150F	150 ft
	MN: HB058-M12-175F	175 ft
MN: HB058-M12-200F	200 ft	
8 AWG Power	Hybrid cable MN: HB114-08U3M12-050F 3x 8 AWG power pairs, 12x multi-mode fiber pairs, Outdoor rated connectors & LC Connectors, 1 1/4 cable, 50 ft	50 ft
	MN: HB114-08U3M12-075F	75 ft
	MN: HB114-08U3M12-100F	100 ft
	MN: HB114-08U3M12-125F	125 ft
	MN: HB114-08U3M12-150F	150 ft
	MN: HB114-08U3M12-175F	175 ft
MN: HB114-08U3M12-200F	200 ft	
6 AWG Power	Hybrid cable MN: HB114-13U3M12-225F 3x 6 AWG power pair, 12x multi-mode fiber pairs, Outdoor rated connectors & LC Connectors, 1 3/4 cable, 225 ft	225 ft
	MN: HB114-13U3M12-250F	250 ft
	MN: HB114-13U3M12-300F	300 ft
4 AWG Power	Hybrid cable MN: HB114-21U3M12-325F 3x 4 AWG power pair, 12x multi-mode fiber pairs, Outdoor rated connectors & LC Connectors, 1 1/4 cable, 325 ft	325 ft
	MN: HB114-21U3M12-350F	350 ft
	MN: HB114-21U3M12-375F	375 ft

RFS HYBRIFLEX JUMPER CABLE SCHEDULE

Fiber Only	Hybrid Jumper cable MN: HBF012-M3-5F1 5 ft, 3x multi-mode fiber pairs, Outdoor & LC connectors, 1/2 cable	5 ft
	MN: HBF012-M3-10F1	10 ft
	MN: HBF012-M3-15F1	15 ft
	MN: HBF012-M3-20F1	20 ft
	MN: HBF012-M3-25F1	25 ft
	MN: HBF012-M3-30F1	30 ft
8 AWG Power	Hybrid Jumper cable MN: HBF058-08U1M3-5F1 5 ft, 1x 8 AWG power pair, 3x multi-mode fiber pairs, Outdoor & LC Connectors, 5/8 cable	5 ft
	MN: HBF058-08U1M3-10F1	10 ft
	MN: HBF058-08U1M3-15F1	15 ft
	MN: HBF058-08U1M3-20F1	20 ft
	MN: HBF058-08U1M3-25F1	25 ft
	MN: HBF058-08U1M3-30F1	30 ft
6 AWG Power	Hybrid Jumper cable MN: HBF058-13U1M3-5F1 5 ft, 1x 6 AWG power pair, 3x multi-mode fiber pairs, Outdoor & LC Connectors, 5/8 cable	5 ft
	MN: HBF058-13U1M3-10F1	10 ft
	MN: HBF058-13U1M3-15F1	15 ft
	MN: HBF058-13U1M3-20F1	20 ft
	MN: HBF058-13U1M3-25F1	25 ft
	MN: HBF058-13U1M3-30F1	30 ft
4 AWG Power	Hybrid Jumper cable MN: HBF078-21U1M3-5F1 5 ft, 1x 4 AWG power pair, 3x multi-mode fiber pairs, Outdoor & LC Connectors, 7/8 cable	5 ft
	MN: HBF078-21U1M3-10F1	10 ft
	MN: HBF078-21U1M3-15F1	15 ft
	MN: HBF078-21U1M3-20F1	20 ft
	MN: HBF078-21U1M3-25F1	25 ft
	MN: HBF078-21U1M3-30F1	30 ft

NOTE: SPRINT CM TO CONFIRM HYBRID OR FIBER RISER CABLE AND HYBRID OR FIBER JUMPER CABLE MODEL NUMBERS IF HYBRID CABLES ARE REQUIRED BEFORE PREPARING BOM.

2.5 CABLE CROSS SECTION DATA

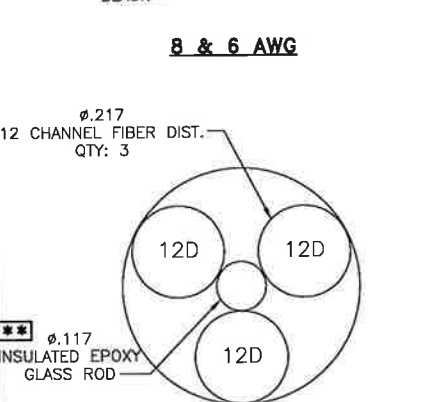
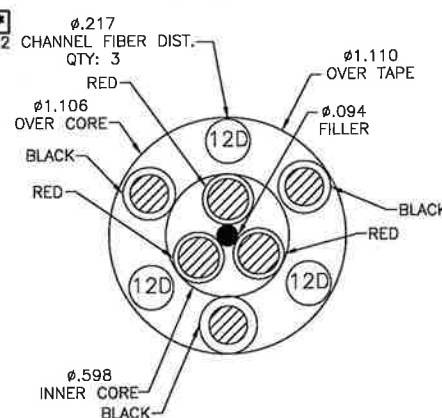
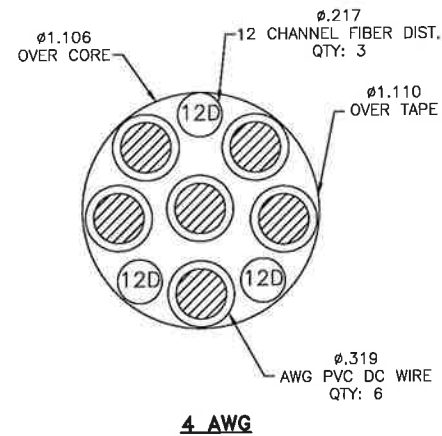

FIBER ONLY

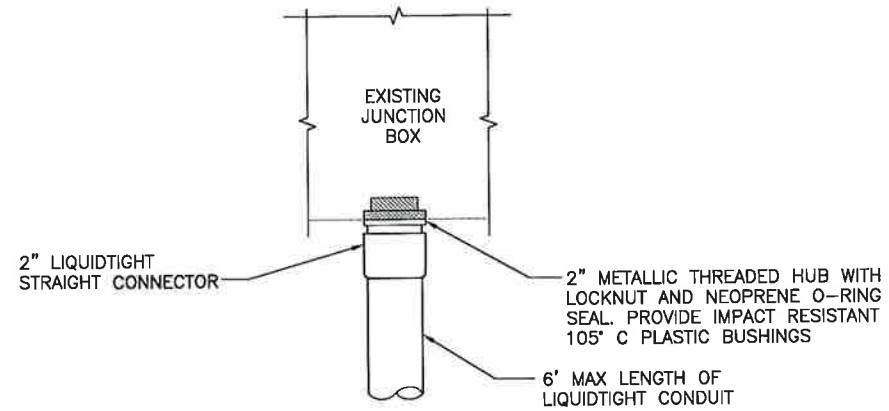

FIBER JUNCTION BOX PENETRATION

NO SCALE 2

IMPORTANT!! Line up white markings on jumper and riser IP-MPO connectors and slide the riser connector to the jumper connector. Push the white mark on the jumper connector flush again the red seal on the riser connector.

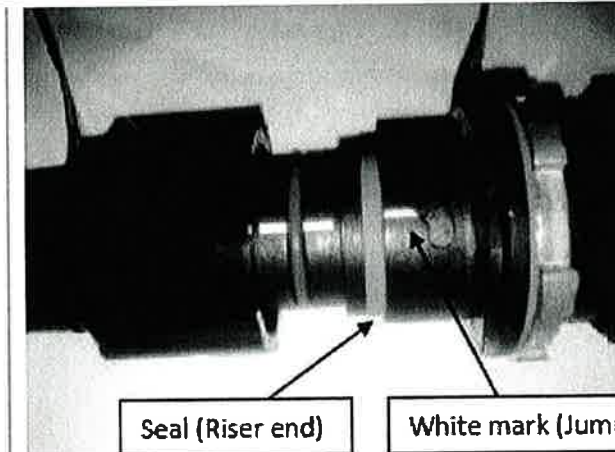

Seal (Riser end)

White mark (Jumper end)

IMPORTANT!! Rotate the bayonet housing clock wise until you hear a click sound (means a good connection is in place).

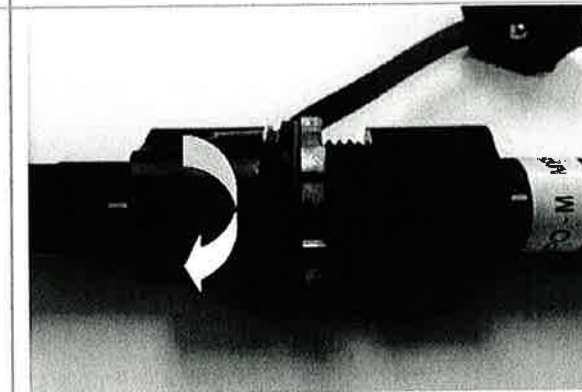

INFORMATION BASED ON PROVIDED INFORMATION FROM ALCATEL-LUCENT 2.5 GHz UPGRADE INSTALLATION GUIDE.

HYBRIFLEX RISER/JUMPER CONNECTION DETAIL

NO SCALE 3

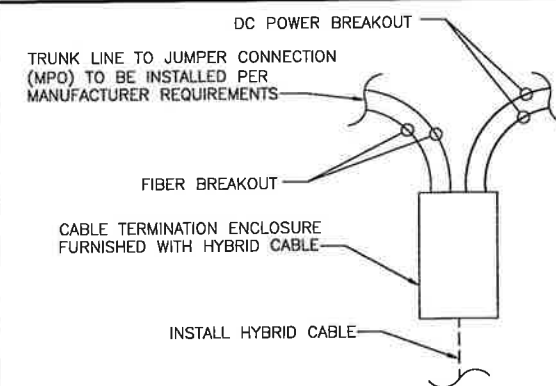

2.5 HYBRID RISER CABLE (FIBER AND DC FEEDERS)

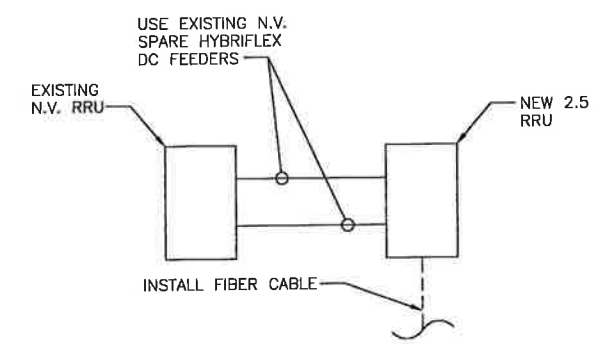

FIBER ONLY RISER CABLE

TRUNK LINE DETAIL (TYP.)

NO SCALE 4

PLANS PREPARED FOR:



PLANS PREPARED BY:



MLA PARTNER:



ENGINEERING LICENSE:



DRAWING NOTICE:

THESE DOCUMENTS ARE CONFIDENTIAL AND ARE THE SOLE PROPERTY OF SPRINT AND MAY NOT BE REPRODUCED, DISSEMINATED OR REDISTRIBUTED WITHOUT THE EXPRESS WRITTEN CONSENT OF SPRINT.

REVISIONS:

DESCRIPTION	DATE	BY	REV
ISSUED FOR PERMIT	07/16/14	AHS	2
ISSUED FOR PERMIT	07/11/14	AHS	1
ISSUED FOR PERMIT	06/10/14	DJG	0
ISSUED FOR REVIEW	05/28/14	MAP	A

SITE NAME:

ANSONIA WAKELEE

SITE CASCADE:

CT03XC005

SITE ADDRESS:

**401 WAKELEE AVENUE
ANSONIA, CT 06401**

SHEET DESCRIPTION:

CIVIL DETAILS

SHEET NUMBER:

A-6

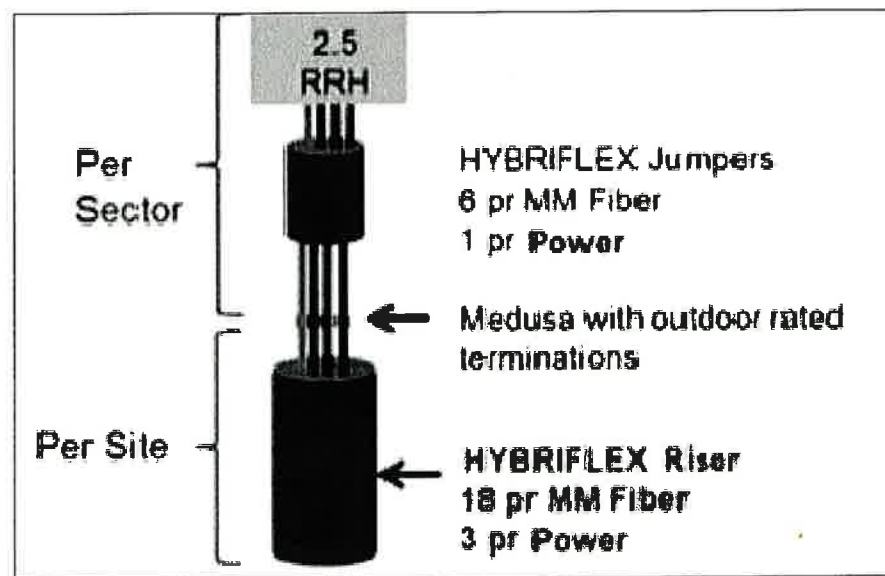
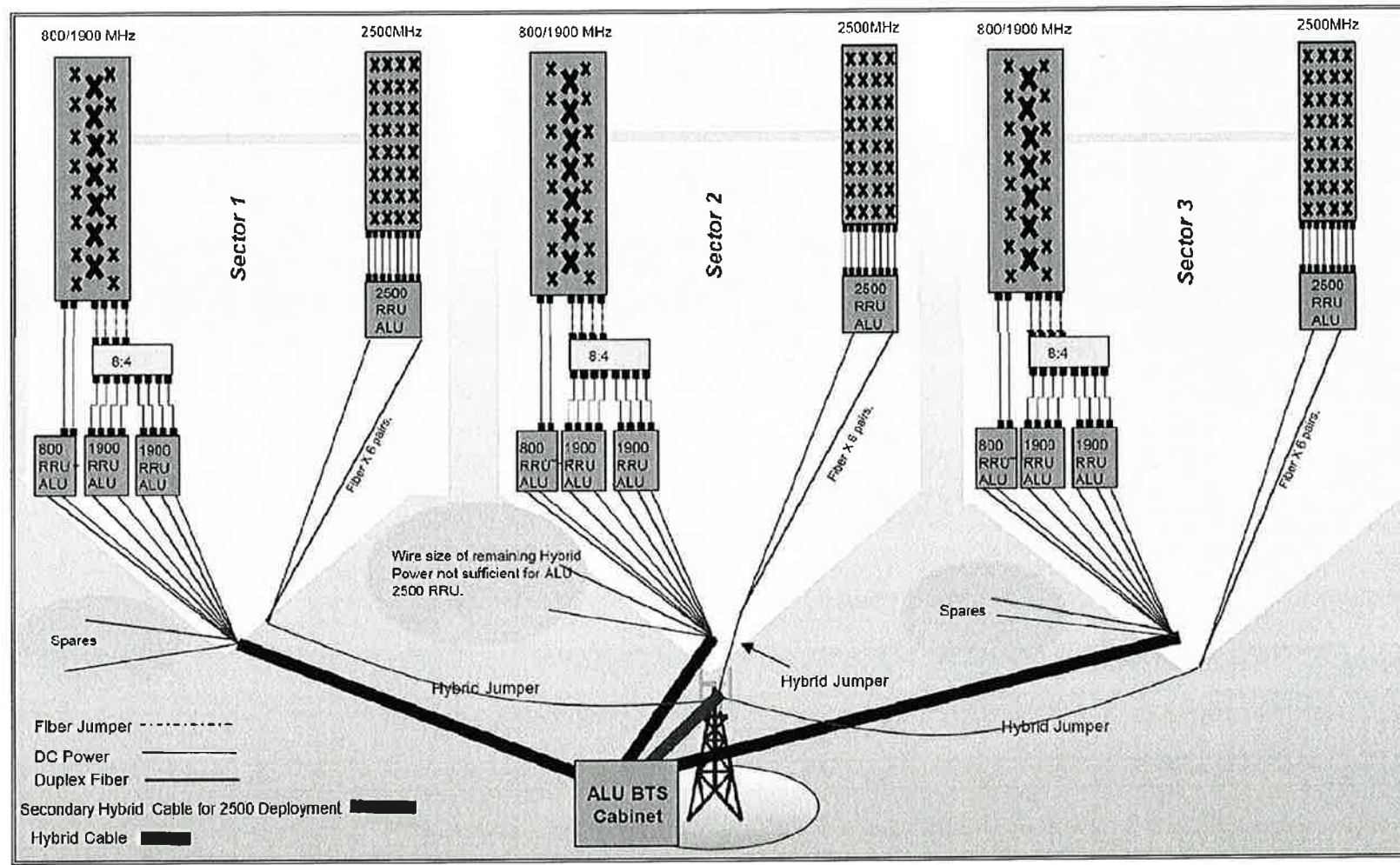
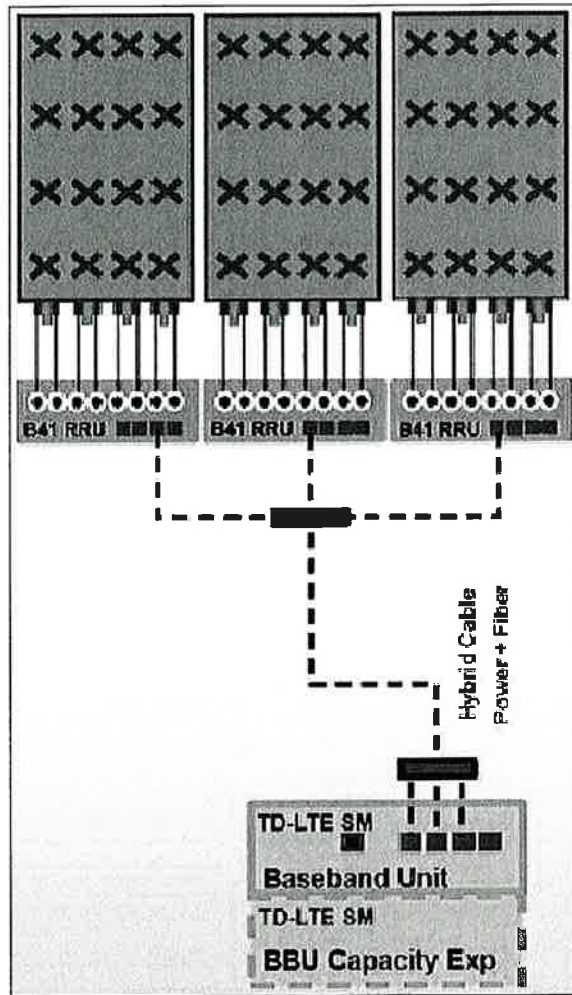

REVISIONS:

DESCRIPTION	DATE	BY	REV
ISSUED FOR PERMIT	07/16/14	AHS	2
ISSUED FOR PERMIT	07/11/14	AHS	1
ISSUED FOR PERMIT	06/10/14	DJG	0
ISSUED FOR REVIEW	05/28/14	MAP	A

SITE NAME:
ANSONIA WAKELEE

SITE CASCADE:
CT03XC005

SITE ADDRESS:
**401 WAKELEE AVENUE
 ANSONIA, CT 06401**

SHEET DESCRIPTION:
PLUMBING DIAGRAM

SHEET NUMBER:
A-7

PLAN NOT USED

NO SCALE

1

- LEGEND:**
- G — EXISTING GROUND RING
 - CADWELD CONNECTION (EXOTHERMIC WELD)
 - ▲ MECHANICAL CONNECTION
 - ⊗ GROUND ROD
 - CABLE GROUND KIT

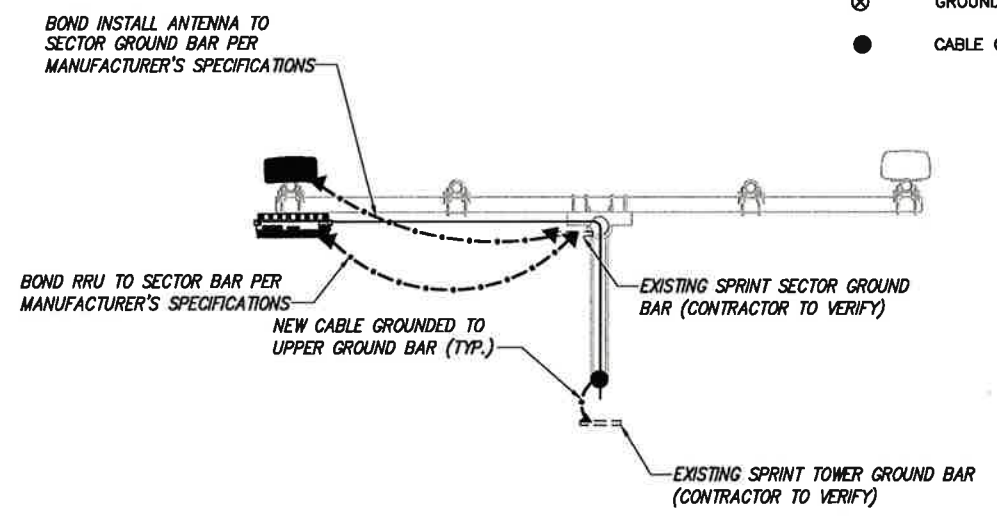

TYPICAL ANTENNA GROUNDING PLAN

NO SCALE

2

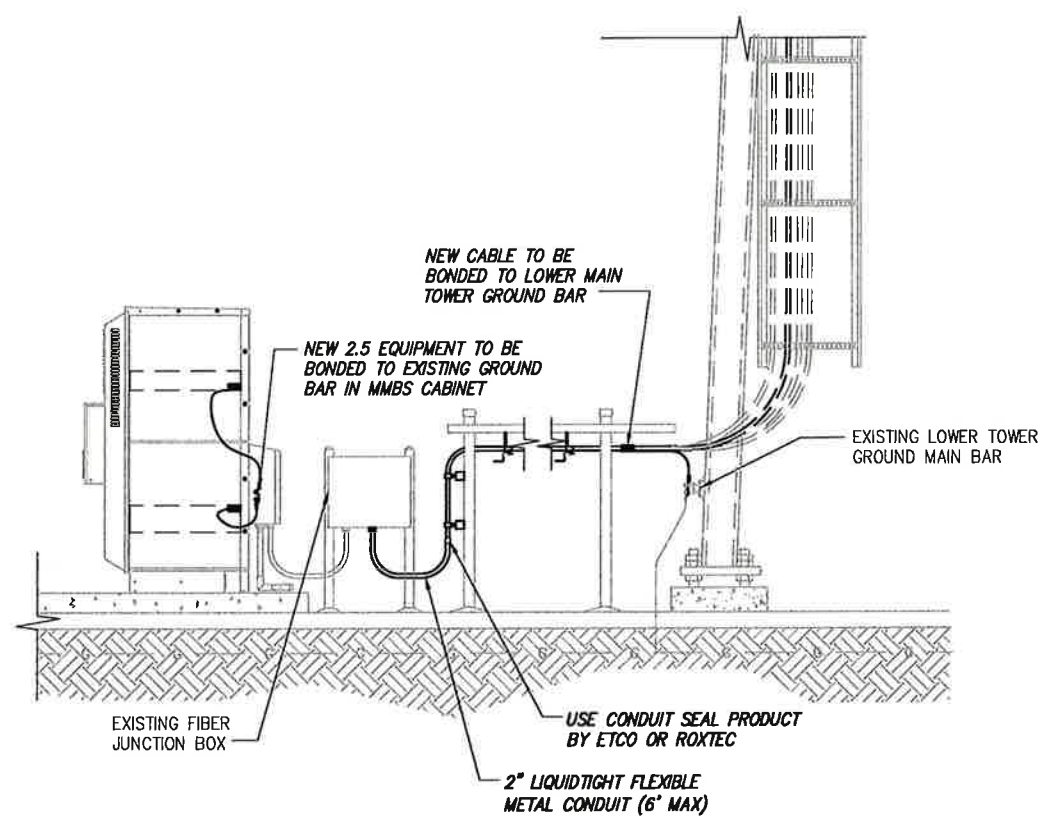

TYPICAL EQUIPMENT GROUNDING PLAN (ELEVATION)

NO SCALE

3

DRAWING NOTICE:

THESE DOCUMENTS ARE CONFIDENTIAL AND ARE THE SOLE PROPERTY OF SPRINT AND MAY NOT BE REPRODUCED, DISSEMINATED OR REDISTRIBUTED WITHOUT THE EXPRESS WRITTEN CONSENT OF SPRINT.

REVISIONS:

DESCRIPTION	DATE	BY	REV
ISSUED FOR PERMIT	07/16/14	AHS	2
ISSUED FOR PERMIT	07/11/14	AHS	1
ISSUED FOR PERMIT	06/10/14	DJG	0
ISSUED FOR REVIEW	05/28/14	MAP	A

SITE NAME:

ANSONIA WAKELEE

SITE CASCADE:

CT03XC005

SITE ADDRESS:

**401 WAKELEE AVENUE
ANSONIA, CT 06401**

SHEET DESCRIPTION:

ELECTRICAL & GROUNDING PLAN

SHEET NUMBER:

E-1

NOTES
 CG SHALL REFERENCE ALL SPECS FOR "CONNECTING THE POWER SUPPLY" OF THE NEW INSTALLATION DOCUMENTS, FOR ALL CONNECTION SPECIFICATIONS.

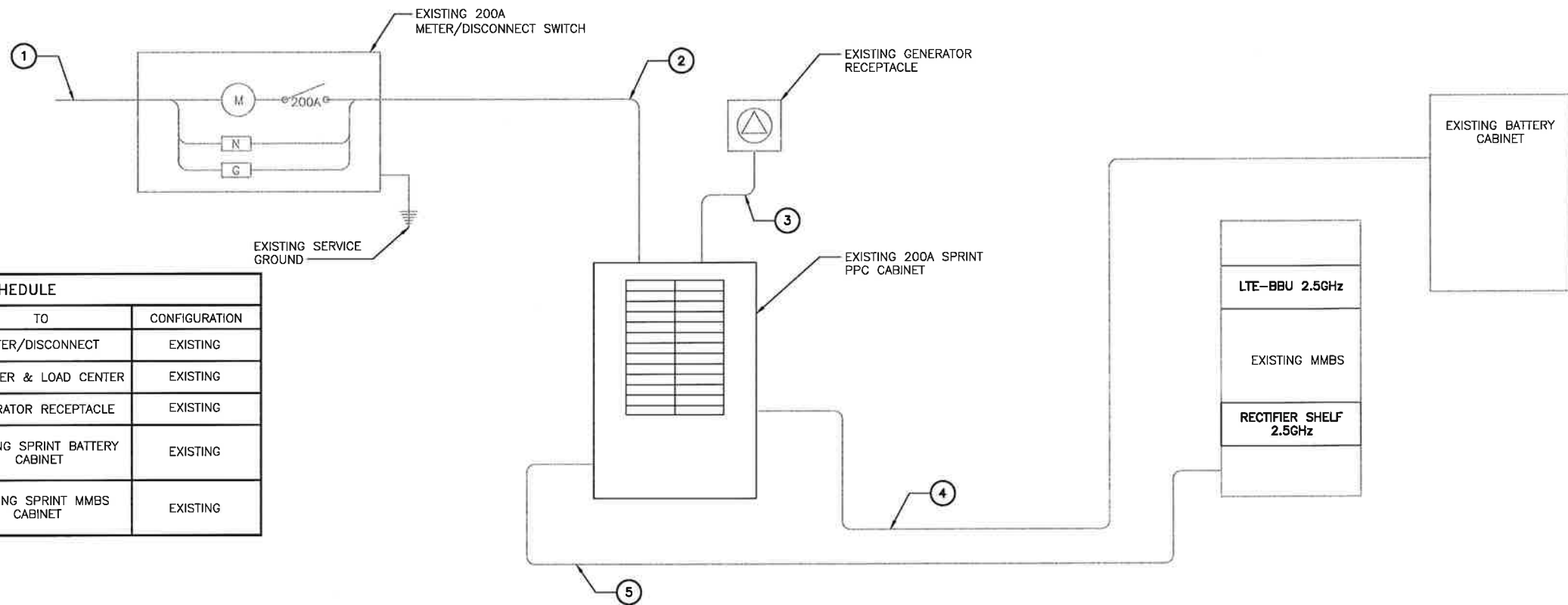

CIRCUIT SCHEDULE			
NO	FROM	TO	CONFIGURATION
①	UTILITY SOURCE	METER/DISCONNECT	EXISTING
②	METER/DISCONNECT	TRANSFER & LOAD CENTER	EXISTING
③	TRANSFER & LOAD CENTER	GENERATOR RECEPTACLE	EXISTING
④	TRANSFER & LOAD CENTER	EXISTING SPRINT BATTERY CABINET	EXISTING
⑤	TRANSFER & LOAD CENTER	EXISTING SPRINT MMBS CABINET	EXISTING

PLANS PREPARED FOR:
Sprint
 6580 Sprint Parkway
 Overland Park, Kansas 66251

PLANS PREPARED BY:
INFINIGY Design. Build. Deliver.
 1033 Watervliet Shaker Rd
 Albany, NY 12205
 Office # (518) 690-0790
 Fax # (518) 690-0793
 JOB NUMBER 340-000

MLA PARTNER:
AMERICAN TOWER CORPORATION
 10 PRESIDENTIAL WAY
 WOBURN, MA 01801

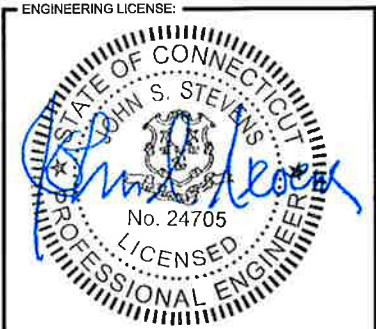

DRAWING NOTICE:
 THESE DOCUMENTS ARE CONFIDENTIAL AND ARE THE SOLE PROPERTY OF SPRINT AND MAY NOT BE REPRODUCED, DISSEMINATED OR REDISTRIBUTED WITHOUT THE EXPRESS WRITTEN CONSENT OF SPRINT.

REVISIONS:	DESCRIPTION	DATE	BY	REV
ISSUED FOR PERMIT		07/16/14	AHS	2
ISSUED FOR PERMIT		07/11/14	AHS	1
ISSUED FOR PERMIT		06/10/14	DJG	0
ISSUED FOR REVIEW		05/28/14	MAP	A

SITE NAME:
ANSONIA WAKELEE

SITE CASCADE:
CT03XC005

SITE ADDRESS:
 401 WAKELEE AVENUE
 ANSONIA, CT 06401

SHEET DESCRIPTION:
ELECTRICAL & GROUNDING DETAILS

SHEET NUMBER:
E-2

ELECTRICAL ONE-LINE DIAGRAM

NO SCALE 1

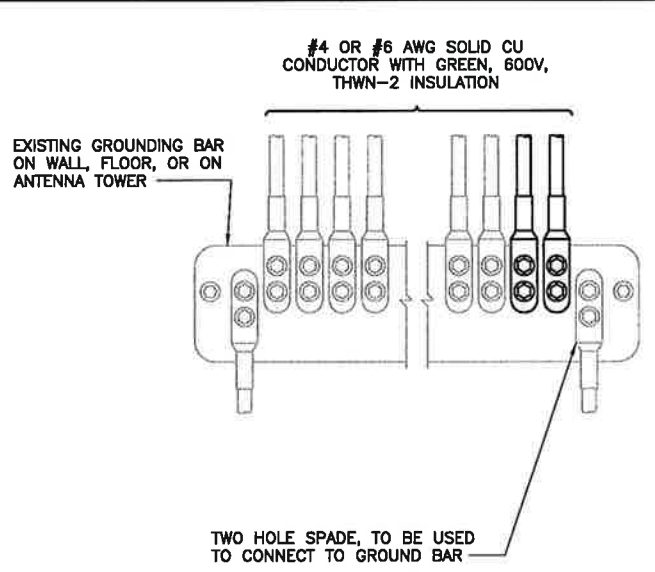

NOTES
 1. APPLY NO-OX TO LUG AND BAR CONTACT SURFACE. DO NOT COAT INLINE LUG.
 2. IF STOLEN GROUND BARS ARE ENCOUNTERED, CONTACT SPRINT CM FOR REPLACEMENT THREADED ROD KIT.

INSTALLATION OF GROUNDING CONDUCTOR TO GROUNDING BAR

NO SCALE

2

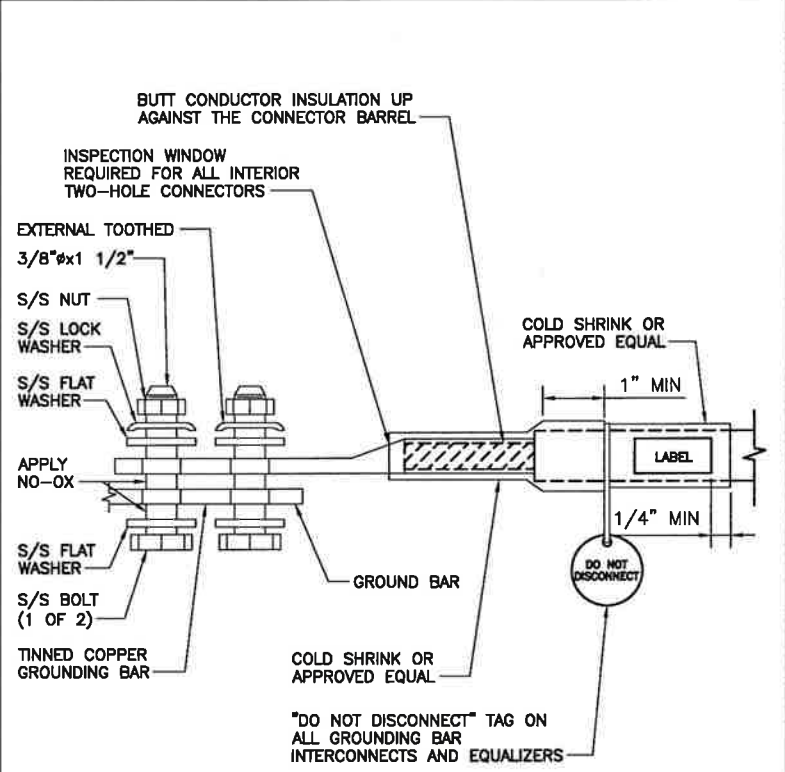

"DO NOT DISCONNECT" TAG ON ALL GROUNDING BAR INTERCONNECTS AND EQUALIZERS

TWO HOLE LUG

NO SCALE

3

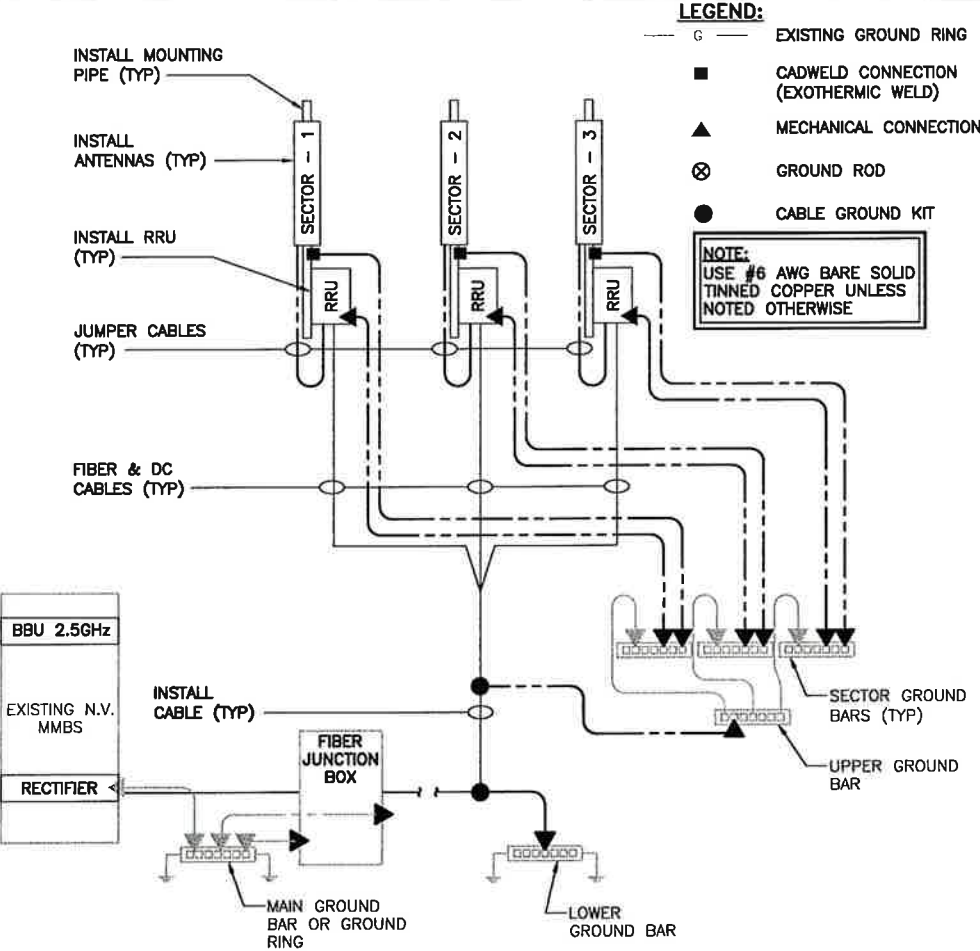

LEGEND:
 G EXISTING GROUND RING
 ■ CADWELD CONNECTION (EXOTHERMIC WELD)
 ▲ MECHANICAL CONNECTION
 ⊗ GROUND ROD
 ● CABLE GROUND KIT

NOTE:
 USE #6 AWG BARE SOLID TINNED COPPER UNLESS NOTED OTHERWISE

GROUNDING RISER DIAGRAM

NO SCALE

4