



**MUNICIPAL CONSULTATION FILING**

**GREATER HARTFORD CENTRAL CONNECTICUT RELIABILITY PROJECT**

**BY**

**THE CONNECTICUT LIGHT AND POWER COMPANY**

**DOING BUSINESS AS EVERSOURCE ENERGY**

**VOLUME 2: NATURAL RESOURCE  
REPORT, CULTURAL REPORT AND  
OUTREACH CORRESPONDENCE**

**December 2015**



# **VOLUME 2: INDEX TO NATURAL RESOURCE REPORT, CULTURAL REPORT AND OUTREACH CORRESPONDENCE**

## INTRODUCTION

EXHIBIT 2.A: WETLANDS AND WATERCOURSES REPORT (AECOM, September 15, 12015)

EXHIBIT 2.B: CULTURAL RESOURCES REVIEW (Heritage Consultants, LLC, May 19, 2015)

EXHIBIT 2.C: Municipal Outreach Information/Copies of Agency Correspondence

EXHIBIT 2.D: Planning Documentation

Exhibit 2.D.1 ISO-NE “Greater Hartford and Central Connecticut (GHCC) Area Transmission 2022 Needs Assessment,” May 2014, Redacted to secure Confidential Energy Infrastructure Information (CEII)

Exhibit 2.D.2 ISO-NE “Greater Hartford and Central Connecticut (GHCC) Area Transmission 2022 Solutions Study,” February 2015, Redacted to secure Confidential Energy Infrastructure Information (CEII)

Exhibit 2.D.3 ISO-NE “Transmission Planning Technical Guide,” December 2014

Exhibit 2.D.4 LEI Analysis of the Feasibility and Practicality of Non-Transmission Alternatives (“NTAs”) to the Greater Hartford/Central Connecticut Reliability Project (“GHCCRP”) August 31, 2015



# **INTRODUCTION**

This volume includes the Wetlands and Watercourses Report (Exhibit 2.A) prepared by AECOM, September 15, 2015; the Cultural Resources Review (Exhibit 2.B) prepared by Heritage Consultants, LLC, May 19, 2015; the Municipal Outreach Information and Copies of Agency Correspondence (Exhibit 2.C); and planning documentation (Exhibit 2.D) prepared in support of the Greater Hartford Central Connecticut Reliability Project (GHCCRP, Project), as proposed by The Connecticut Light and Power Company doing business as Eversource Energy (Eversource). The proposed GHCCRP includes the following components:

- A new approximately 3.8-mile 115-kilovolt (kV) underground cable system that would extend, beneath road rights-of-way (ROWs) or parking lots, between Eversource's existing Newington and Southwest Hartford substations, crossing portions of the Town of Newington (0.7 mile), Town of West Hartford (2.6 miles), and City of Hartford (0.5 mile);
- Modifications to the existing Newington, Southwest Hartford, and Berlin substations, located in the Town of Newington, City of Hartford, and Town of Berlin, respectively; and
- Modification of a 0.01-mile section of existing overhead 115-kV transmission line (referred to as the Newington Tap) that connects to Newington Substation.



## **Exhibit 2.A Wetlands and Watercourses Report**







## **Greater Hartford Central Connecticut Reliability Project**

### **WETLANDS AND WATERCOURSES REPORT**

**Prepared for:**

Eversource  
107 Selden Street  
Hartford, CT 06141

**Prepared by:**

AECOM  
9 Jonathan Bourne Drive  
Pocasset, MA 02459

September 15, 2015



***Note: This page intentionally left blank.***

# Table of Contents

<b>1.0</b>	<b>Introduction .....</b>	<b>1-1</b>
1.1	Project Background and Location .....	1-1
1.2	Project Area Geographic Overview.....	1-5
1.3	Physiographic and Geologic Overview .....	1-5
<b>2.0</b>	<b>Wetland and Watercourses Regulations.....</b>	<b>2-1</b>
2.1	Clean Water Act - Section 404.....	2-1
2.2	Connecticut Inland Wetlands and Watercourses Act.....	2-2
<b>3.0</b>	<b>Wetland Delineation Procedures .....</b>	<b>3-1</b>
3.1	Pre-Survey Desktop Investigations.....	3-1
3.2	Field Surveys .....	3-1
3.2.1	Soils .....	3-4
3.2.2	Vegetation.....	3-4
3.2.3	Hydrology.....	3-4
3.2.4	GPS Mapping.....	3-5
3.3	Wetland and Watercourse Classification .....	3-5
3.3.1	Palustrine Forested Wetlands (PFO).....	3-5
3.3.2	Palustrine Scrub-Shrub Wetlands (PSS) .....	3-5
3.3.3	Palustrine Emergent Wetlands (PEM) .....	3-5
3.3.4	Watercourses .....	3-5
3.4	Post-Survey Desktop Analysis.....	3-6
<b>4.0</b>	<b>Results .....</b>	<b>4-1</b>
4.1	Wetlands .....	4-1
4.1.1	Wetland Soils .....	4-2
4.1.2	Wetland Vegetation.....	4-2
4.1.3	Wetland Hydrology.....	4-2
4.2	Watercourses .....	4-4
4.2.1	Unnamed Tributary to the South Branch of the Park River .....	4-4
4.2.2	Trout Brook .....	4-4
4.2.3	Unnamed Tributary to Piper Brook .....	4-5
4.3	Flood Plains .....	4-5

## List of Tables

Table 4-1:	Wetlands and Watercourses in the Project Area .....	4-1
Table 4-2:	Wetlands Delineated in the Project Area .....	4-1
Table 4-3:	Soils and Soil Characteristics .....	4-3
Table 4-4:	Watercourses Identified in the Project Area .....	4-4

## List of Figures

Figure 1-1:	USGS Locus Map .....	1-2
Figure 1-2:	Locus Map – Proposed Route .....	1-3
Figure 1-3:	Locus Map - Berlin Substation .....	1-4
Figure 1-4:	Proposed Route Map .....	1-6
Figure 3-1:	Wetlands and Flood Plain Mapping – Proposed Route .....	3-2
Figure 3-2:	Wetlands and Flood Plain Mapping – Berlin Substation .....	3-3

## Appendices

Appendix A:	Route Plans (Sheets 1 through 4 of 4)
Appendix B:	2015 Wetlands and Watercourses Field Data Forms
Appendix C:	2015 Representative Site Photographs

## 1.0 Introduction

Eversource Energy (Eversource) proposes to construct a new 3.7 mile 115-kilovolt (kV) underground cable between its Newington Substation in the Town of Newington and its Southwest Hartford Substation in the City of Hartford, and to make electric transmission system improvements to these two substations in addition to the Berlin Substation located in the Town of Berlin, herein referred to as the Greater Hartford – Central Connecticut Reliability Project (GHCCRP or Project) as shown on Figure 1-1. The underground cable will be located within the Town of Newington and the Cities of West Hartford and Hartford all located in Hartford County between the Newington and Southwest Hartford Substations as shown on Figure 1-2. A close up locus map of the Berlin Substation is shown on Figure 1-3. This report provides a summary of wetland and watercourse inventories and delineations conducted by AECOM within the Project area. The Project area (as shown on Figure 1-1) is generally bounded by the following: Eversource overhead distribution corridors heading north and east from Newington Substation to the west and south respectively; Interstate 84 to the northwest; CTfastrak corridor to the east; and Kane Street and St. James Street to the north.

Wetland and watercourse delineations were conducted to identify both federal and Connecticut jurisdictional water resources. Desktop analyses, as well as on-site field delineations were employed to determine state and federal wetland boundaries in accordance with applicable state and federal regulations. The desktop and field wetland and watercourse investigations were conducted during the May and July of 2015. This report discusses the methods used to identify the wetlands and watercourses encountered in the Project area and summarizes the findings of the surveys.

Tables listing all wetlands and watercourses identified during the surveys are located in Section 4. Figures depicting the Project and Project area are provided in Appendix A. Wetland data forms are provided in Appendix B. Representative wetland photographs are provided in Appendix C.

### 1.1 Project Background and Location

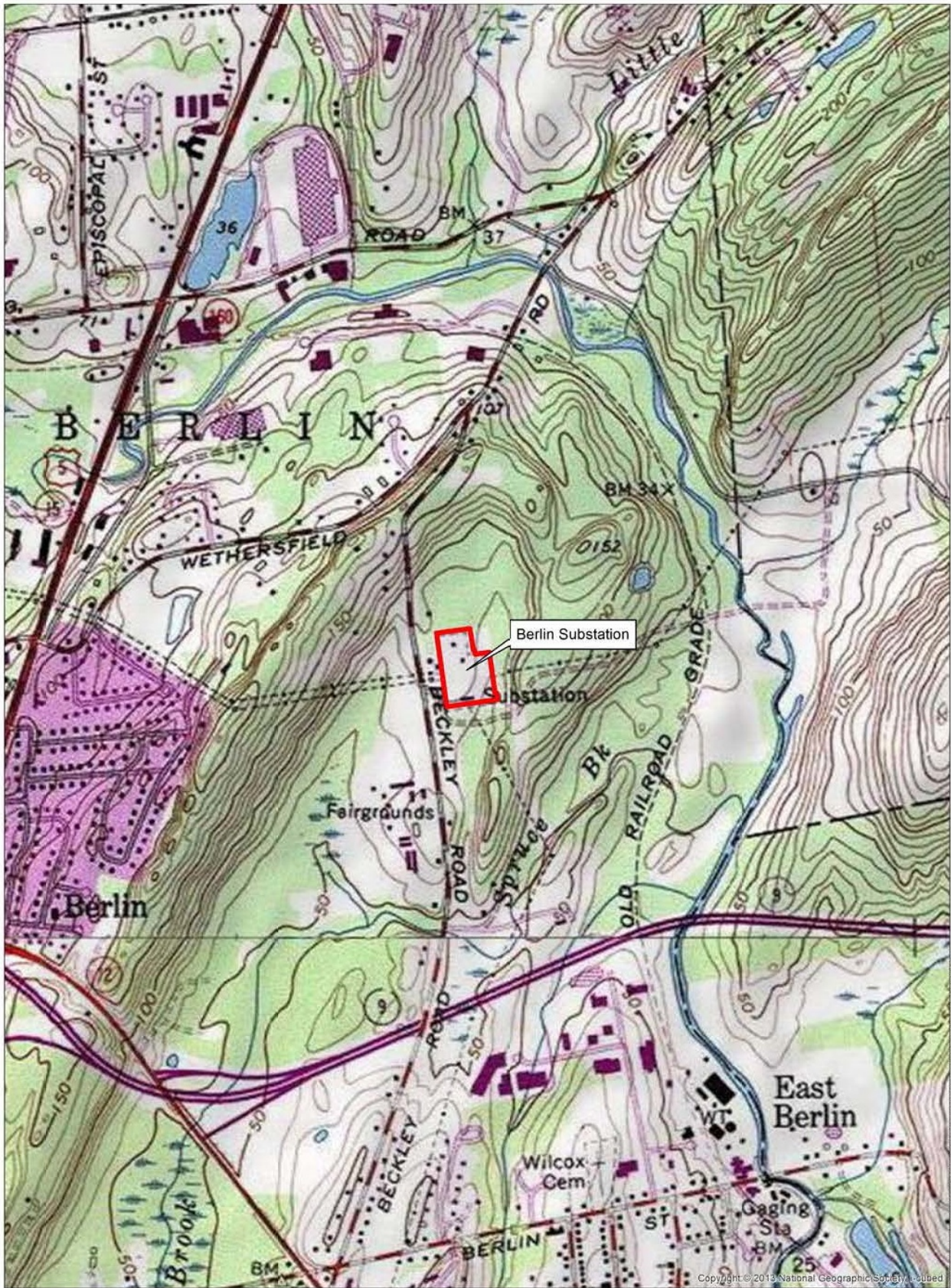
The proposed electric transmission system improvements associated with the Project are required to bring the electric supply system in the Greater Hartford area into compliance with applicable national and regional electric reliability standards and criteria. The new line would be located mainly within existing roadways and existing rights-of-way (ROWs) as shown on Figure 1-4. Proposed Project work activities include:

- **Newington Substation (185 Cherry Hill Road, Newington):** This substation occupies approximately 1.5 acres. Proposed improvements include a slight expansion south of the existing fence line.
- **Southwest Hartford Substation (271 New Park Avenue, Hartford):** This substation occupies approximately 2.0 acres. Proposed improvements are within existing fence boundaries.
- **Berlin Substation (300 Beckley Road, Berlin):** This substation occupies approximately 6.5 acres. Proposed improvements are within existing fence boundaries









LOCUS MAP- BERLIN SUBSTATION  
 GREATER HARTFORD CENTRAL CONNECTICUT RELIABILITY  
 PROJECT (GHCCRP)  
 NEWINGTON, WEST HARTFORD, HARTFORD

**EVERSOURCE**

**AECOM**

 Substation Location

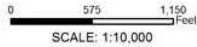


Fig. 1-3 Aug. 2015

## 1.2 Project Area Geographic Overview

The potential route under consideration at this time is depicted on Figure 1-4. For the purposes of this Project, wetlands and watercourses were assessed within the Project area to include a proposed route with variations and alternatives to the proposed. The Project area is predominantly residential, commercial and urban land. Proposed routes are located within existing streets. The proposed route will require crossing of Trout Brook.

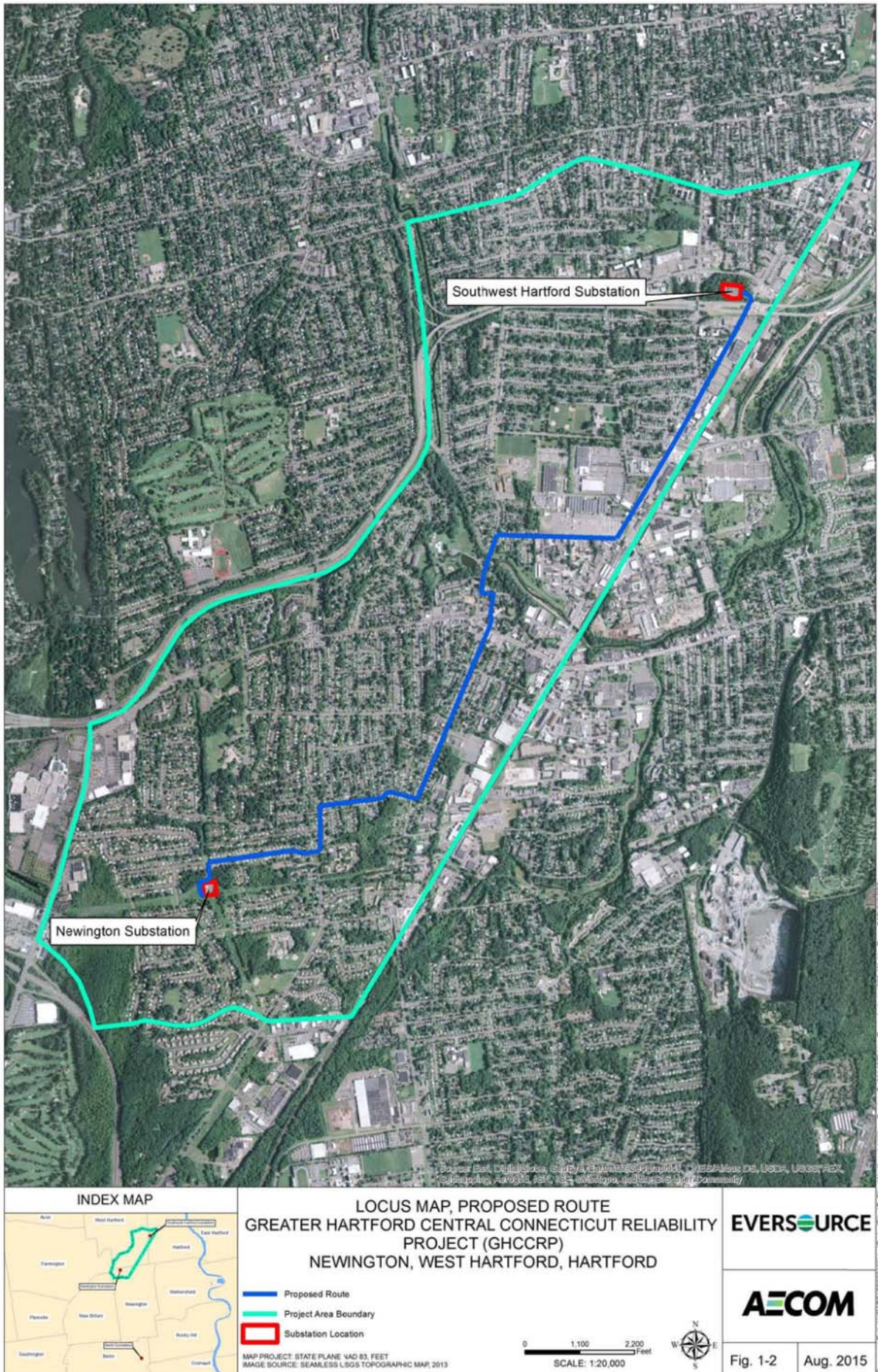
## 1.3 Physiographic and Geologic Overview

The Project area is situated within the Central Valley physiographic region of Connecticut<sup>1</sup>. This region is characterized by variably hilly terrain with local areas of considerable topographic relief and rugged hills. The area contains relatively younger bedrock (Triassic/Jurassic age), sedimentary brownstone, and shale with intrusive, erosion-resistant igneous basalts making up the Metacomet Ridge.

The glaciers and the associated outwash meltwaters have resulted in a flattened Connecticut River Valley. Bedrock is comprised of brownstone, a sedimentary rock that erodes easily; therefore, the Central Valley (located within the Connecticut River Valley) is almost totally free of boulders. The predominant surficial deposits along the Proposed Route are comprised of fine glacial meltwater deposits with flat to moderate topography. Bedrock depths generally exceed 30 feet beneath the sand, gravel, and fines deposits are often more than 100 feet below the ground surface. Floodplain deposits are post-glacial deposits comprised of alluviums of fine outwash associated with the Trout Brook. Bedrock is generally deep (greater than 30 feet) beneath these floodplain deposits.

---

<sup>1</sup> Connecticut Geologic Survey Department of Energy and Environmental Protection. 1990, revised 2013.



## 2.0 Wetland and Watercourses Regulations

AECOM soil and wetland scientists identified wetlands and watercourses subject to state and federal jurisdiction based upon the Connecticut Inland Wetlands and Watercourses Act (C.G.S. Section 22a-36 through 45) and the Federal Clean Water Act (33 U.S.C. 1344). The Project does not cross any Navigable Waters of the United States subject to Section 10 of the Rivers and Harbors Act (33 U.S.C. 403).

During the process of delineating the wetlands within the potential routes and substation properties, both state and federal methodologies were employed. In Connecticut, state and federal boundaries can differ due to the different delineation methodologies. Frequently, areas of alluvial and floodplain soils that qualify as wetlands in Connecticut may not exhibit a wetland plant community and evidence of wetland hydrology, as required by the U.S. Army Corps of Engineers (USACE) or federal methodology. As a result, some locations on the Connecticut landscape do require distinct state and federal wetland boundaries. However, all of the wetlands identified along the Proposed Route met both state and federal criteria.

### 2.1 Clean Water Act - Section 404

Wetlands, springs, and other waters of the United States are regulated under Section 404 of the Federal Clean Water Act (CWA) by the USACE. Federal jurisdictional wetlands include interstate wetlands, wetlands adjacent (i.e., bordering, contiguous, or neighboring) to waters of the United States, and intrastate wetlands whose degradation or destruction could affect interstate or foreign commerce as per the application of the CWA. According to the 1987 Corps of Engineers Wetland Delineation Manual<sup>2</sup>, areas must exhibit three distinct characteristics to be considered wetlands:

- **Hydrophytic Vegetation:** Plants growing in water or in a substrate that is at least periodically deficient in oxygen during a growing season as a result of excessive water content;
- **Hydric Soils:** Soils that, in an undrained condition, are saturated, flooded, or ponded long enough during a growing season to develop an anaerobic condition that supports the growth and regeneration of hydrophytic vegetation; and,
- **Wetland Hydrology:** Inundation or saturation by surface or groundwater at a frequency and duration during the growing season sufficient to support a prevalence of hydrophytic vegetation typically adapted for life in saturated soil conditions.

Wetlands satisfying these criteria are subject to federal jurisdiction under Section 404 of the CWA.

---

<sup>2</sup> Environmental Laboratory. 1987. Corps of Engineers Wetlands Delineation Manual. Technical Report Y-87-1, U.S. Army Engineer Waterways Experiment Station, Vicksburg, MS

In January 2012, the USACE issued a Regional Supplement to the Corps of Engineers Delineation Manual<sup>3</sup> (Regional Supplement), which provides further guidance for wetland delineations in the northeastern United States. The Regional Supplement provides wetland indicators, delineation guidance, and other information specific to the Northcentral and Northeast Regions, supplementing the 1987 USACE Manual. Indicators and procedures in the Regional Supplement are designed to identify wetlands as defined jointly by the USACE (33 CFR 328.2) and the U.S. Environmental Protection Agency (40 CFR 230.3) and subject to regulation under Section 404 of the CWA.

## **2.2 Connecticut Inland Wetlands and Watercourses Act**

Connecticut regulates work in and around inland wetlands under the Inland Wetlands and Watercourses Act (the Act). Typically, the state statutes are implemented through the Inland Wetlands and Watercourse Regulations as administered by the individual municipalities.

Under Section 2 of The Act, a wetland is defined as “land, including submerged land...which consists of poorly drained, very poorly drained, alluvial and floodplain soils as defined by the National Cooperative Soils Survey. Such areas may include filled, graded or excavated sites which possess an aquic (saturated) moisture regime as defined by the United States Department of Agriculture (USDA) Cooperative Soil Survey.” As written, the statute assigns no bearing to vegetation when performing wetland delineations. According to the Connecticut Department of Energy and Environmental Protection (CT DEEP) website, approximately 17 percent of the state’s land area is comprised of wetlands under the Connecticut wetland definition; however, “under the federal definition only roughly half of this same area would be classified as wetlands”.

Watercourses are defined in the Act as “rivers, streams, brooks, waterways, lakes, ponds, marshes, swamps, bogs and all other bodies of water, natural or artificial, vernal or intermittent, public or private, which are contained within, flow through or border upon the state or any portion thereof.” The Act defines Intermittent watercourses as having a defined permanent channel bed and bank and the occurrence of two of the following: a) evidence of scour or deposits of recent alluvium or detritus, b) the presence of standing or flowing water for a duration of longer than a particular storm incident, or c) the presence of hydrophytic vegetation.

---

<sup>3</sup> Wetlands Regulatory Assistance Program. 2012. Regional Supplement to the Corps of Engineers Wetlands Delineation Manual: Northcentral and Northeast, U.S. Army Engineer Research and Development Center, Vicksburg, MS

## 3.0 Wetland Delineation Procedures

Between May and July, 2015, AECOM soil and wetland scientists delineated wetlands and watercourses within the Project area. The methods of investigation and procedures used included both pre-survey desktop investigations and on-site field investigations to determine the wetland and watercourse resource areas within to the Project area.

### 3.1 Pre-Survey Desktop Investigations

Prior to the commencement of field surveys, AECOM reviewed information from multiple sources to determine the potential extent of state and federal wetlands within the Project area. Pre-survey information reviewed included:

- United States Geological Survey (USGS) topographical quadrangles;
- USGS National Hydrography Dataset (NHD);
- National Wetlands Inventory (NWI) maps;
- Federal Emergency Management Agency (FEMA) Flood Insurance Rate Maps (FIRM);
- U.S. Department of Agriculture (USDA) Natural Resource Conservation Service (NRCS) web soil surveys; and
- CT DEEP online wetland mapping services.

Mapping which shows the NWI and FEMA flood plain information are provided in Figures 3-1 and 3-2.

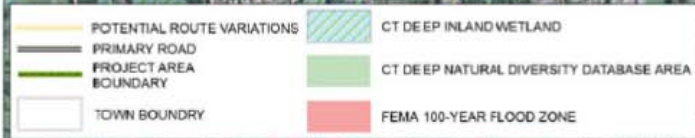
### 3.2 Field Surveys

Between May and July, 2015, AECOM soil and wetland scientists delineated wetlands within the Project area in accordance with USACE New England District guidance including the 1987 USACE Manual, the Regional Supplement, *Field Indicators for Identifying Hydric Soils in New England, Version 3<sup>rd</sup>* and the State of Connecticut Inland Wetlands and Watercourses Act. Vegetation, soils, and hydrology data were assessed during the field surveys to determine if the three wetland parameters described in Section 2.0 were satisfied for each potential wetland area.

During the field investigations, the soil and wetland scientists identified the boundary between the wetland and/or watercourse and the upland area, and delineated the boundary with survey flagging. Field data summary sheets provide documentation and confirm the boundaries at specific locations for each delineated wetland or watercourse (see Appendix B). Each wetland and watercourse was given a unique (Project-specific) alphanumeric designation and these assigned designations were used to identify the wetlands and watercourses on the associated Project mapping. Appendix C includes photographs taken during the delineations.

---

<sup>4</sup> New England Hydric Soils Technical Committee. 2004. *Field Indicators for Identifying Hydric Soils in New England, 3rd ed.* New England Interstate Water Pollution Control Commission, Lowell, MA.



**WETLANDS AND FLOOD PLAIN MAP- PREFERRED ROUTE  
GREATER HARTFORD CONNECTICUT RELIABILITY  
PROJECT (GHCCRP)  
NEWINGTON, WEST HARTFORD & HARTFORD, CT**

**DATA SOURCE:**  
CT DEEP GIS DATA  
FEMA NFHL GIS DATA  
CONNECTICUT 2012 ORTHO IMAGERY, CTECO  
COORDINATE SYSTEM  
NAD 1983, STATEPLANE CT FIPS 0006  
PROJECTION: LAMBERT CONFORMAL CONIC  
LINEAR UNITS: FOOT US

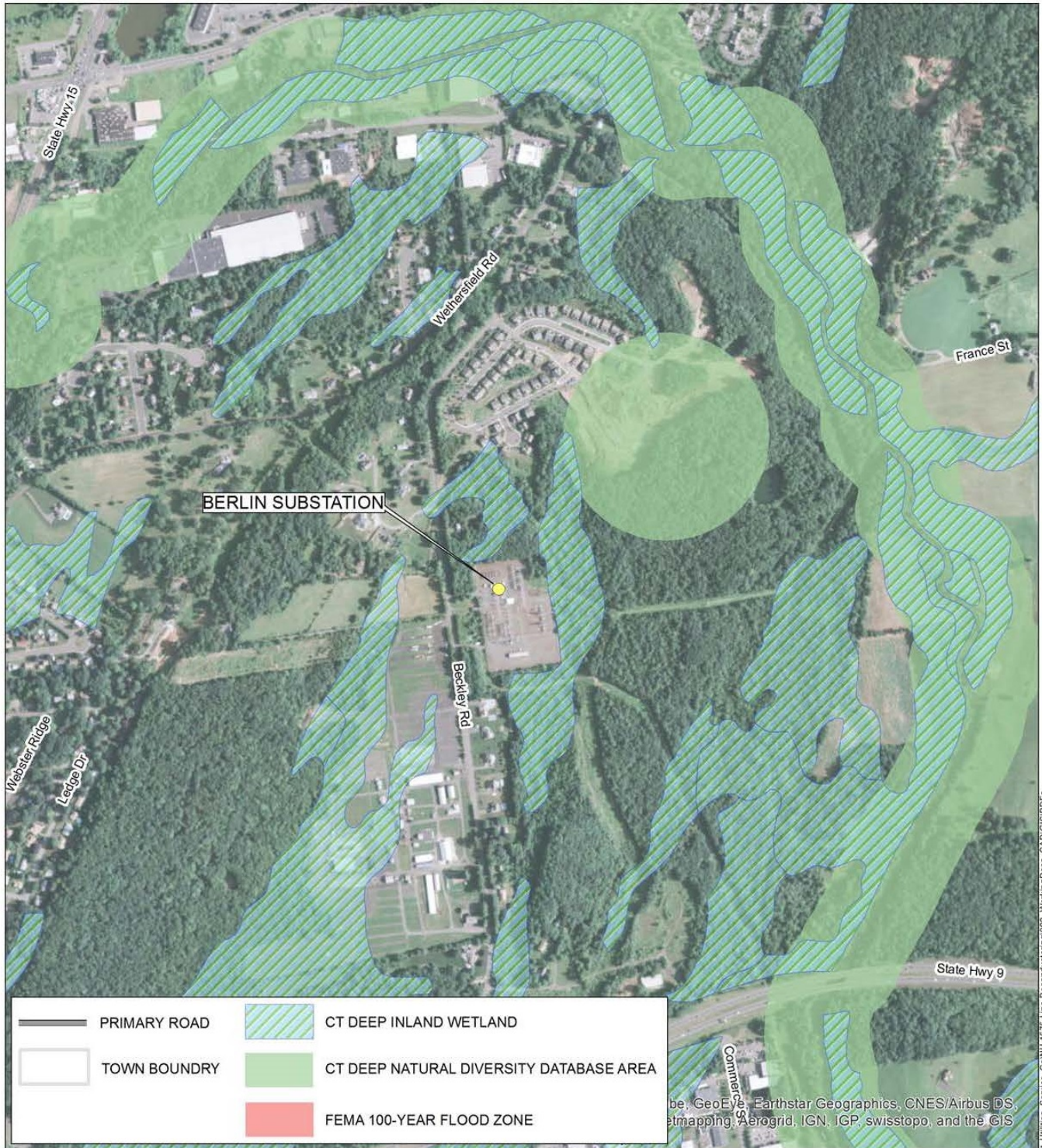
0 1,000 2,000 Feet  
SCALE: 1:20,000

**EVERSOURCE**

**AECOM**

Fig 3-1 Aug. 2015

Document Path: N:\SW\TR\PROJECT\Map\_Center\Mapset\_Utility\_Service\_Con\1273\_Line\_Rep\Manufacturing\000\_Work\MapDocs\_GIS\GSPR... 07/28/2015 10:56:41 AM



**WETLANDS AND FLOOD PLAIN MAP- BERLIN SUBSTATION**  
**GREATER HARTFORD CONNECTICUT RELIABILITY PROJECT (GHCCRP)**  
**BERLIN SUBSTATION, BERLIN, CT**

DATA SOURCE:  
 CTDEEP GIS DATA  
 FEMA NFHL GIS DATA  
 CONNECTICUT 2012 ORTHO IMAGERY, CTECO  
 COORDINATE SYSTEM:  
 NAD 1983 STATEPLANE CT FIPS 0600  
 PROJECTION: LAMBERT CONFORMAL CONIC  
 LINEAR UNITS: FOOT US

0 500 1,000 Feet

SCALE: 1:10,000

Fig. 3-2
Aug. 2015

\USWY\FTP0001\Water\ProjectFiles\...\_Client\Northwest\_Uilities\_Service\_Co\NU 1575 Line Reconducting\900\_WorkingDocx\_CAD\GIS\PDFs



The specific methods for characterizing and evaluating vegetation, hydrology, and soils for determination for the presence or absence of a wetland are described below.

### 3.2.1 Soils

At the center of each data plot, the soil and wetland scientists completed borings with a hand-held auger to determine a soil's hydric status (typically 18 to 24 inches below ground surface). The information collected for each soil profile included soil horizons, depth, texture, color, and the presence or absence of redoximorphic features (mottles and other features). Colors of the soil matrix and mottles were identified using Munsell Soil Color Charts. All hydric soil determinations in 2015 were based on criteria established in the 1987 USACE Manual, the Regional Supplement, and the *Field Indicators for Identifying Hydric Soils in New England-Version 3*. Additionally, the presence of any saturation and/or standing water encountered during the soil profile was noted.

Multiple soil types representing a wide variety of soil series designations were identified during the wetland and watercourse inventory. Information regarding the soils along the Proposed Route was obtained from on-line county soil surveys and maps published by the USDA NRCS<sup>5</sup>. These surveys and maps provide soil classifications and characteristics, including depth to bedrock, slope, drainage, and erosion potential. Field investigations of soils are required to identify Connecticut wetlands, which are defined based on the presence of poorly drained, very poorly drained, or floodplain soils.

### 3.2.2 Vegetation

Dominant trees and shrubs/saplings were recorded within a 30-foot and 15-foot radius, respectively, from the center of each documentation plot. Species abundance in both upland and wetland communities were visually estimated. Woody vines were recorded within a 30-foot radius of the plot. Dominant herbaceous vegetation was recorded within a 5-foot radius of the plot. The indicator status of each species was identified using the *National List of Plant Species That Occur in Wetlands, Region 1-Northeast*<sup>6</sup>. Hydrophytic vegetation was determined to be prevalent when greater than 50 percent of the dominant species were classified as having a wetland indicator status of facultative (FAC+ or FAC), facultative wetland (FACW) or obligate wetland (OBL).

### 3.2.3 Hydrology

Site hydrology was evaluated during field surveys by initially observing whether the soil at the surface was inundated or saturated. If the ground surface was dry, the depth to freestanding groundwater or saturated soil was measured, and the presence or absence of other indicators of wetland hydrology (e.g., drift lines, water-stained leaves, etc.) was noted. The wetland hydrology criterion was met if one or more primary or two or more secondary field indicators were present.

---

<sup>5</sup> Web Soil Survey, <http://websoilsurvey.sc.egov.usda.gov/App/HomePage.htm> accessed 2015.

<sup>6</sup> National Wetland Plant List. July 2013. U.S. Army Engineer Research and Development Center, Vicksburg, MS

### **3.2.4 GPS Mapping**

Wetland and watercourse flag positions and data point locations were field located by AECOM personnel using a Trimble global positioning system (GPS) data collection device capable of sub-meter accuracy. The collected GPS data points were then corrected, geo-referenced, and plotted on aerial photograph imagery.

### **3.3 Wetland and Watercourse Classification**

While in the field, AECOM soil and wetland scientists classified the various wetlands and watercourses according to the “Cowardin system”, which is a process discussed in *Classification of Wetlands and Deepwater Habitats of the United States*<sup>7</sup>. Identified wetlands were classified as Palustrine Forested (PFO), Palustrine Scrub-Shrub (PSS), or Palustrine Emergent (PEM), all of which are further described below. In some cases, a wetland complex contained more than one wetland classification type. In those situations, each wetland type is listed and the first classification type represents the more dominant characteristic. Wetland vegetation found in these habitats in the Project area are described in Section 4.1.1.

#### **3.3.1 Palustrine Forested Wetlands (PFO)**

Palustrine forested wetlands or PFO are characterized by woody vegetation that is six meters (approximately 20 feet) tall or taller. These areas normally contain an overstory of trees, an understory of young trees and/or shrubs, and an herbaceous layer. These wetland types are located predominantly in unmanaged or non-cleared areas of the existing ROWs or in adjacent off-ROW areas.

#### **3.3.2 Palustrine Scrub-Shrub Wetlands (PSS)**

Palustrine scrub-shrub wetlands or PSS are typically dominated by woody vegetation less than six meters (approximately 20 feet) tall. Areas classified as scrub-shrub cover types may represent a successional stage that through natural processes would transition to a forested wetland; or may contain trees or shrubs that are small and/or stunted due to environmental conditions.

#### **3.3.3 Palustrine Emergent Wetlands (PEM)**

Palustrine emergent wetlands or PEM are characterized by erect, rooted, herbaceous hydrophytes not including mosses and lichens. These wetlands maintain the same appearance year after year and are typically dominated by perennial plants that are present for the majority of the growing season.

#### **3.3.4 Watercourses**

“Rivers, streams, brooks, waterways, lakes, ponds, marshes, swamps, bogs and all other bodies of water, natural or artificial, vernal or intermittent, public or private, which are contained within, flow through or border upon the state or any portion thereof” are considered watercourses, according to The Act. The

---

<sup>7</sup> Cowardin, L.M., V. Carter, F.C. Golet and E.T. LaRoe. 1979. *Classification of Wetlands and Deepwater Habitats of the United States*. U.S. Fish and Wildlife Service. FWS/OBS-79/31. Washington, D.C.

“top of bank” was used to demarcate the limits of a watercourse when no wetlands were adjacent to the channel. Watercourses were investigated to determine if they are listed as a National Wild and Scenic River under the National Wild and Scenic Rivers Act (16 U.S.C. §§ 1271-1287) or rivers designated by the CT DEEP Protected Rivers Act (C.G.S. §§ 25-200 through 25-210). Water quality designations were determined using CT DEEP mapping resources.

### **3.4 Post-Survey Desktop Analysis**

The wetland and watercourse boundaries were plotted on aerial imagery and subsequently reviewed and confirmed by AECOM field personnel. The aerial-based maps show the locations of the delineated resources relative to the proposed limits of the Project. The results of the desk-top and field efforts are described in Section 4.0.

## 4.0 Results

A total of seven wetlands and three watercourses were identified in the Project area as identified in Table 4-1 and described in greater detail below in the appropriate sections.

**Table 4-1: Wetlands and Watercourses in the Project Area**

Municipality	Number of Wetlands	Number of Watercourses	Map Sheet No.
Newington	4	1	1
West Hartford	1	1	2
Hartford	0	1	3
Berlin	2	0	n/a
<b>Total Features</b>	<b>7</b>	<b>3</b>	

### 4.1 Wetlands

A total of seven wetlands were identified and delineated within the Project area as shown on the figures in Appendix A. As the Project area is heavily developed, the wetlands were primarily located in the undeveloped vegetated areas found adjacent to the Newington Substation and Newington ROW, the Southwest Hartford Substation, Trout Brook, and the Berlin Substation. Three of the seven wetlands are located along the Newington ROW associated with the Proposed Route. Three wetlands are associated with the Newington and Berlin Substations, and one wetland is located along Trout Brook located in West Hartford. A summary of the delineated wetlands is provided in Table 4-2 and shown on the route plans in Appendix A. Wetland delineation field forms are provided in Appendix B. Representative photographs are provided in Appendix C.

**Table 4-2: Wetlands Delineated in the Project Area**

Wetland No.	Location	Municipality	Dominant NWI Class <sup>1</sup>	Other NWI Classes	Map Sheet No.
N-1	Newington Substation	Newington	PSS	--	1
N-2	Newington ROW	Newington	PEM	PSS	1
N-3	Newington ROW	Newington	PEM	PSS	1
N-4	Newington ROW	Newington	PSS	PEM	1
WH-1	West Hartford ROW	West Hartford	PEM	--	2
B-1	Berlin Substation	Berlin	PFO	--	4
B-2	Berlin Substation	Berlin	PFO	PSS	4

<sup>1</sup> Cowardin 1979

#### 4.1.1 Wetland Soils

Wetlands along the Proposed Route and adjacent to substations were delineated by AECOM registered professional soil and/or wetland scientists. Table 4-3 summarizes the principal soil associations, as identified by the USDA NRCS, along and in the general vicinity of the Proposed Route.

Two soil types identified by the NRCS within the Project Area are considered hydric. These include the Scitico, Shaker, and Maybid series (9) and Bash (104). A portion of Trout Brook to the west of the Proposed Route is also identified as having hydric soils (Bash) although the portion of Trout Brook located within the Project area is identified as being comprised of Udorthents which are soils that have been cut and filled due to urban development and may include wetland inclusions. Soils identified adjacent to the Southwest Hartford Substation are also comprised of two types of Udorthents. Soils near to the Newington Substation are identified as the Scitico, Shaker, and Maybid soils. Soils with conditions to be wet enough for a long enough period of time and easily observed in the field (i.e., mottling, etc.) are considered hydric. These conditions were verified in the field by AECOM wetland and soil scientists during the 2015 field investigations.

#### 4.1.2 Wetland Vegetation

The three wetlands located along the Newington ROW are classified as PEM/PSS or PSS/PEM and are dominated by the following plant species: silky dogwood (*Cornus amomum*), southern arrowwood (*Viburnum dentatum*), common jewelweed (*Impatiens capensis*), sedges (*Carex* spp.), broadleaf cattail (*Typha latifolia*), reed canary grass (*Phalaris arundinacea*), elderberry (*Sambucus nigra*), and goldenrod species (*Solidago* spp.) as well as the invasive species common reed (*Phragmites australis*).

The wetland located adjacent to the Newington Substation is classified as PSS and is dominated by the following plant species: red-osier dogwood (*Cornus sericea*), sensitive fern (*Ocnoclea sensibilis*), cinnamon fern (*Osmunda cinnamomea*), common reed, silver maple (*Acer saccharinum*), moneywort (*Lysimachia nummularia*).

Dominant vegetation encountered in the two Berlin Substation wetlands, classified as PFO and PSS, included the following species: silky dogwood, red-osier dogwood, sensitive fern, broad-leaf cattails, silver maple, moneywort, rice cut grass (*Leersia oryzoides*), and jewelweed.

The wetland located along the alternate route adjacent to Trout Brook in West Hartford is classified as PEM and is dominated by the following plant species: sedges, broadleaf cattail, reed canary grass, goldenrod species, and dark-green bulrush (*Scirpus atrovirens*).

#### 4.1.3 Wetland Hydrology

Evidence of hydrology observed in the field was identified on the field data forms as provided in Appendix B. In addition, the depth to groundwater for the various soils types is provided in Table 4-3.

**Table 4-3: Soils and Soil Characteristics**

Unit No.	Name	Slope (%)	Parent Material	Hydric Soil	Depth to Restrictive Feature (inches)	Depth to Water Table (inches)	Bedrock	Proposed Route	Newington Substation	Southwest Hartford Substation	Berlin Substation
9	Scitico, Shaker, Maybid soils	0 to 5	very deep, poorly drained soils formed in silty and clayey sediments	Yes	>72	10-12	Very deep	yes			yes
26A	Berlin silt loam	0 to 3	moderately well drained and somewhat poorly drained soils formed in silty, clayey glaciolacustrine deposits	No	>72	12-30	Very deep				yes
30B	Branford silt loam	3 to 8	very deep, well drained soils formed in loamy over sandy, gravelly outwash	No	>72	>6 feet	Very deep	yes	yes		
40A	Ludlow silt loam	0 to 3	moderately well drained soils formed in loamy lodgment till	No	24-40	18-30	Very deep				yes
87B	Wethersfield loam	3 to 8	Coarse-loamy lodgment till derived from basalt and/or sandstone and shale	No	20-40 to Dense material	18-30	Very deep	yes			yes
104	Bash Silt Loam	3 to 8	very deep, somewhat poorly drained soils formed in recent alluvial deposit, in nearly level soils on floodplains	Yes	>72	6-18	Very deep	yes			
225B	Brancroft [Bancroft]-Urban land complex	0 to 8	very deep, moderately well drained soils formed in silty, clayey glacial lacustrine deposits	No	>72	18-30	Very deep	yes			
306	Udorthents-Urban land complex	varies	Urban land, variable	No	>72	54-72	Very deep	yes		yes	
307	Urban land	varies	Urban land, variable	No	Variable	Variable	Variable	yes			yes
308	Udorthents, smoothed	varies	Urban land, variable	No	>72	24-54	Very deep	yes		yes	
309	Udorthents, flood control	varies	Moderately well drained	Possible Inclusions	>72	24-54	Very deep	yes			

## 4.2 Watercourses

Three watercourses are located within the Project area as identified in Table 4-4 and include an unnamed tributary to the South Branch of the Park River adjacent to the Southwest Hartford Substation, Trout Brook in the approximate center of the Project area, and an unnamed tributary to Piper Brook which crosses under Newington Road. See Appendices A and B for additional details and site-specific information. The Proposed Route does not cross any rivers designated as a National Wild and Scenic River under the National Wild and Scenic Rivers Act or rivers designated by the CT DEEP Protected Rivers Act. As a central element of the state's clean water program, the CT DEEP has established Water Quality Standards and Classifications (2011), which identify the water quality management objectives for each waterbody which are identified below for the watercourse observed.

**Table 4-4: Watercourses Identified in the Project Area**

Wetland Classification	Municipality	Water Quality <sup>1</sup>	Watercourse Frequency <sup>2</sup>
Unnamed Tributary to the South Branch of Park River	Hartford	B	Perennial
Trout Brook	West Hartford	A	Perennial
Unnamed Tributary to Piper Brook	West Hartford	B	Perennial

<sup>1</sup> Connecticut Water Quality Standards, February 2011: A = potential drinking water supply, contact recreation, B = recreational use.

<sup>2</sup> Designated using the Connecticut Inland Wetland and Watercourses Act

### 4.2.1 Unnamed Tributary to the South Branch of the Park River

The unnamed tributary to the South Branch of Park River is a perennial watercourse and is located in the northern portion of the Project area near the Southwest Hartford Substation in Hartford. This tributary has been altered by human activity, including rerouting and channelization. Portions of the tributary flow through an underground pipe beneath New Park Avenue and aboveground portions are disturbed within the Project area. Park River has a water quality classification of B within the Project Area.

### 4.2.2 Trout Brook

Trout Brook is a large perennial stream that flows from northeast to southwest through the central portion of the Project area in West Hartford. While disturbed by urban land use, Trout Brook is an open stream system, with small undeveloped but previously disturbed buffers and recreational pedestrian paths on both the north and south banks. Trout Brook has a water quality classification of A and designated uses include potential drinking water supply, habitat for fish and other aquatic life and wildlife, recreation, and industrial and agricultural water supply. The Trout Brook watershed consists of 63% urban area and three segments of Trout Brook are listed as impaired waterbodies on the CT DEEP's 2010 303(d) list, which includes the segment the Project area crosses. These segments of the river are impaired due to elevated bacteria concentrations, affecting the designated use of recreation.

### **4.2.3 Unnamed Tributary to Piper Brook**

The unnamed perennial tributary to Piper Brook occurs in the southern portion of the Project area and crosses beneath Newington Road to the north of the intersection with Sampson Street in the City of West Hartford. This tributary has been altered by human activity, including rerouting and channelization. The unnamed tributary flows through an underground pipe through the entirety of its length within the Project area. Piper Brook has a water quality classification of B.

### **4.3 Flood Plains**

FEMA Flood plain mapping is provided in Figures 3-1 and Figure 3-2. A review of FEMA maps indicates that the Proposed Route extends across 100-year flood zones associated with two watercourses including the unnamed tributary to the South Branch of the Park River in Hartford by the Southwest Hartford Substation and Trout Brook where it crosses Quaker Lane. Southwest Hartford Substation is located in a Zone X (unshaded) 500-year floodplain. This is an area of minimal flood hazard, outside the Special Flood Hazard Area (SFHA), and higher than the elevation of the 0.2-percent-annual-chance floods. FEMA does not enforce floodplain management regulations in areas outside of the SFHA. There are no FEMA mapped flood plains in the vicinity of the Newington Substation. There are no FEMA mapped flood plains in the vicinity of the Berlin Substation.



***Note: This page intentionally left blank.***

**Appendix A**  
**Route Plans (Sheets 1 through 4 of 4)**

---

***Note: This page intentionally left blank.***

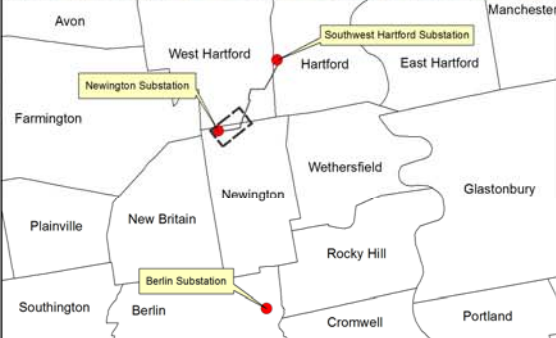


UNNAMED TRIBUTARY TO PIPER BROOK  
IDENTIFIED CULVERTED CROSSING BENEATH ROAD

UNNAMED TRIBUTARY TO PIPER BROOK  
ASSUMED CULVERTED CROSSING BENEATH ROAD

UNNAMED TRIBUTARY TO PIPER BROOK  
IDENTIFIED CULVERTED CROSSING BENEATH ROAD

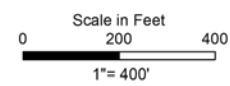
Path: C:\Users\brink\1\Documents\Sub\_01\Projects\Hartford\_115\K\K\Scale\_Route\_Fig\_WW.mxd



- Substation Fence Line
- Proposed Route
- Delineated Watercourse
- Delineated Wetland
- CTDEEP Inland Wetland Soils
- Town Boundry

**GREATER HARTFORD CENTRAL CONNECTICUT RELIABILITY PROJECT (GHCCRP)  
NEWINGTON, WEST HARTFORD, HARTFORD & BERLIN, CT**

Coordinate System:  
NAD 1983 StatePlane Connecticut FIPS 0600 Feet  
Projection: Lambert Conformal Conic  
Datum: North American 1983  
False Easting: 1,000,000.0000  
False Northing: 500,000.0000  
Central Meridian: -72.7500  
Standard Parallel 1: 41.2000  
Standard Parallel 2: 41.8667  
Latitude Of Origin: 40.8333  
Linear Units: Foot US  
2006 UCONN CLEAR LULC DATA, Reclassified by AECOM



**EVERSOURCE**

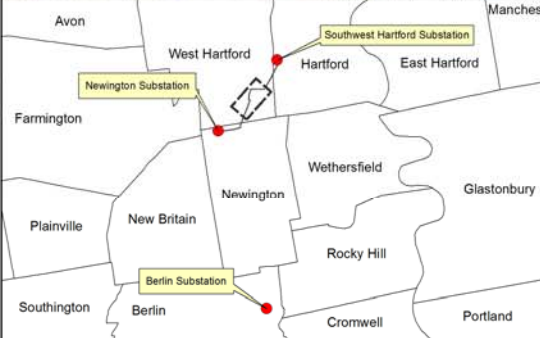
**AECOM**

Revised: 11/12/2015

Sheet 1 of 4

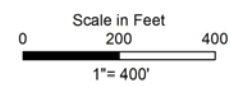


-  Substation Fence Line
-  Proposed Route
-  Delineated Watercourse
-  Delineated Wetland
-  CTDEEP Inland Wetland Soils
-  Town Boundry



GREATER HARTFORD CENTRAL CONNECTICUT RELIABILITY PROJECT (GHCRP)  
NEWINGTON, WEST HARTFORD, HARTFORD & BERLIN, CT

Coordinate System:  
NAD 1983 StatePlane Connecticut FIPS 0600 Feet  
Projection: Lambert Conformal Conic  
Datum: North American 1983  
False Easting: 1,000,000.0000  
False Northing: 500,000.0000  
Central Meridian: -72.7500  
Standard Parallel 1: 41.2000  
Standard Parallel 2: 41.8667  
Latitude Of Origin: 40.8333  
Linear Units: Foot US  
2006 UCONN CLEAR LULC DATA, Reclassified by AECOM



**EVERSOURCE**

**AECOM**

Revised: 11/12/2015

Sheet 2 of 4

Path: C:\Users\brink\Documents\Subn\_B\Projects\Hartford\_115\NM\XDC\7-14-15\06scale\_Route\_Fig\_WW.mxd



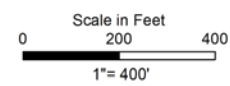
Path: C:\Users\brink1\Documents\Sub\_01\Project\Hartford\_115\AKM\XDC\7-14-15\400\Scale\_Route\_Fig\_WW.mxd



- - - Substation Fence Line
- Proposed Route
- Delineated Watercourse
- ▨ Delineated Wetland
- ▨ CTDEEP Inland Wetland Soils
- Town Boundry

**GREATER HARTFORD CENTRAL CONNECTICUT RELIABILITY PROJECT (GHCCRP)  
NEWINGTON, WEST HARTFORD, HARTFORD & BERLIN, CT**

**Coordinate System:**  
 NAD 1983 StatePlane Connecticut FIPS 0600 Feet  
 Projection: Lambert Conformal Conic  
 Datum: North American 1983  
 False Easting: 1,000,000.0000  
 False Northing: 500,000.0000  
 Central Meridian: -72.7500  
 Standard Parallel 1: 41.2000  
 Standard Parallel 2: 41.8667  
 Latitude Of Origin: 40.8333  
 Linear Units: Foot US  
 2006 UCONN CLEAR LULC DATA, Reclassified by AECOM



**EVERSOURCE**

**AECOM**

Revised: 11/12/2015

Sheet 3 of 4



- Substation Fence Line
- Proposed Route
- Delineated Watercourse
- Delineated Wetland
- CTDEEP Inland Wetland Soils
- Town Boundry

**GREATER HARTFORD CENTRAL CONNECTICUT RELIABILITY PROJECT (GHCCRP)**  
 NEWINGTON, WEST HARTFORD, HARTFORD & BERLIN, CT

**Coordinate System:**  
 NAD 1983 StatePlane Connecticut FIPS 0600 Feet  
 Projection: Lambert Conformal Conic  
 Datum: North American 1983  
 False Easting: 1,000,000.0000  
 False Northing: 500,000.0000  
 Central Meridian: -72.7500  
 Standard Parallel 1: 41.2000  
 Standard Parallel 2: 41.8667  
 Latitude Of Origin: 40.8333  
 Linear Units: Foot US  
 2006 UCONN CLEAR LULC DATA, Reclassified by AECOM

Scale in Feet  
 0 200 400  
 1" = 400'

Revised: 11/12/2015

**EVERSOURCE**

**AECOM**

Sheet 4 of 4

Path: C:\Users\brink\Documents\Job\_01\Projects\Hartford\_115\K\K\X\Scale\_Route\_Fig\_WW.mxd

**Appendix B**  
**2015 Wetlands and Watercourses Field Data Forms**

---



***Note: This page intentionally left blank.***

## WETLAND DETERMINATION DATA FORM – Northcentral and Northeast Region

Project/Site: GHCCRP City/County: Newington/Hartford Sampling Date: 6.23.15  
 Applicant/Owner: Eversource State: CT Sampling Point: W-ROW-1  
 Investigator(s): M. Notestine & K. Van Naerssen Section, Township, Range: \_\_\_\_\_  
 Landform (hillside, terrace, etc.): Slight hillside on ROW Local relief (concave, convex, none): concave Slope %: 5  
 Subregion (LRR or MLRA): LRR R, MLRA 145 Lat: 41.717788, Long: -72.747947 Datum: \_\_\_\_\_  
 Soil Map Unit Name: Branford silt loam, 3-8% slopes & Ellington silt loam, 0-5% slopes NWI classification: PEM/PSS  
 Are climatic / hydrologic conditions on the site typical for this time of year? Yes X No \_\_\_\_\_ (If no, explain in Remarks.)  
 Are Vegetation \_\_\_\_\_, Soil \_\_\_\_\_, or Hydrology \_\_\_\_\_ significantly disturbed? Are "Normal Circumstances" present? Yes X No \_\_\_\_\_  
 Are Vegetation \_\_\_\_\_, Soil \_\_\_\_\_, or Hydrology \_\_\_\_\_ naturally problematic? (If needed, explain any answers in Remarks.)

### SUMMARY OF FINDINGS – Attach site map showing sampling point locations, transects, important features, etc.

Hydrophytic Vegetation Present? Yes <u>X</u> No _____ Hydric Soil Present? Yes <u>X</u> No _____ Wetland Hydrology Present? Yes <u>X</u> No _____	<b>Is the Sampled Area within a Wetland?</b> Yes <u>X</u> No _____ If yes, optional Wetland Site ID: _____
Remarks: (Explain alternative procedures here or in a separate report.)	

### HYDROLOGY

<b>Wetland Hydrology Indicators:</b> <u>Primary Indicators (minimum of one is required; check all that apply)</u> _____ Surface Water (A1) <u>X</u> Water-Stained Leaves (B9) _____ High Water Table (A2) _____ Aquatic Fauna (B13) _____ Saturation (A3) _____ Marl Deposits (B15) _____ Water Marks (B1) _____ Hydrogen Sulfide Odor (C1) _____ Sediment Deposits (B2) _____ Oxidized Rhizospheres on Living Roots (C3) _____ Drift Deposits (B3) <u>X</u> Presence of Reduced Iron (C4) _____ Algal Mat or Crust (B4) _____ Recent Iron Reduction in Tilled Soils (C6) _____ Iron Deposits (B5) _____ Thin Muck Surface (C7) _____ Inundation Visible on Aerial Imagery (B7) _____ Other (Explain in Remarks) _____ Sparsely Vegetated Concave Surface (B8)	<u>Secondary Indicators (minimum of two required)</u> _____ Surface Soil Cracks (B6) _____ Drainage Patterns (B10) _____ Moss Trim Lines (B16) _____ Dry-Season Water Table (C2) _____ Crayfish Burrows (C8) _____ Saturation Visible on Aerial Imagery (C9) _____ Stunted or Stressed Plants (D1) _____ Geomorphic Position (D2) _____ Shallow Aquitard (D3) _____ Microtopographic Relief (D4) _____ FAC-Neutral Test (D5)
<b>Field Observations:</b> Surface Water Present? Yes _____ No <u>X</u> Depth (inches): _____ Water Table Present? Yes _____ No <u>X</u> Depth (inches): _____ Saturation Present? Yes <u>X</u> No _____ Depth (inches): <u>12</u> (includes capillary fringe)	<b>Wetland Hydrology Present?</b> Yes <u>X</u> No _____
Describe Recorded Data (stream gauge, monitoring well, aerial photos, previous inspections), if available:	
Remarks: Soils only lightly saturated; however several other indicators of hydrology also present.	

**VEGETATION** – Use scientific names of plants.

Sampling Point: W-ROW-1

	Absolute % Cover	Dominant Species?	Indicator Status																	
<b>Tree Stratum</b> (Plot size: _____)																				
1. _____	_____	_____	_____	<b>Dominance Test worksheet:</b> Number of Dominant Species That Are OBL, FACW, or FAC: <u>3</u> (A)  Total Number of Dominant Species Across All Strata: <u>3</u> (B)  Percent of Dominant Species That Are OBL, FACW, or FAC: <u>100.0%</u> (A/B)																
2. _____	_____	_____	_____																	
3. _____	_____	_____	_____																	
4. _____	_____	_____	_____																	
5. _____	_____	_____	_____																	
6. _____	_____	_____	_____																	
7. _____	_____	_____	_____																	
_____ =Total Cover				<b>Prevalence Index worksheet:</b> <table style="width:100%; border-collapse: collapse;"> <thead> <tr> <th style="width:50%;">Total % Cover of:</th> <th style="width:50%;">Multiply by:</th> </tr> </thead> <tbody> <tr> <td>OBL species <u>15</u></td> <td>x 1 = <u>15</u></td> </tr> <tr> <td>FACW species <u>105</u></td> <td>x 2 = <u>210</u></td> </tr> <tr> <td>FAC species <u>0</u></td> <td>x 3 = <u>0</u></td> </tr> <tr> <td>FACU species <u>0</u></td> <td>x 4 = <u>0</u></td> </tr> <tr> <td>UPL species <u>0</u></td> <td>x 5 = <u>0</u></td> </tr> <tr> <td>Column Totals: <u>120</u> (A)</td> <td><u>225</u> (B)</td> </tr> <tr> <td colspan="2" style="text-align: center;">Prevalence Index = B/A = <u>1.88</u></td> </tr> </tbody> </table>	Total % Cover of:	Multiply by:	OBL species <u>15</u>	x 1 = <u>15</u>	FACW species <u>105</u>	x 2 = <u>210</u>	FAC species <u>0</u>	x 3 = <u>0</u>	FACU species <u>0</u>	x 4 = <u>0</u>	UPL species <u>0</u>	x 5 = <u>0</u>	Column Totals: <u>120</u> (A)	<u>225</u> (B)	Prevalence Index = B/A = <u>1.88</u>	
Total % Cover of:	Multiply by:																			
OBL species <u>15</u>	x 1 = <u>15</u>																			
FACW species <u>105</u>	x 2 = <u>210</u>																			
FAC species <u>0</u>	x 3 = <u>0</u>																			
FACU species <u>0</u>	x 4 = <u>0</u>																			
UPL species <u>0</u>	x 5 = <u>0</u>																			
Column Totals: <u>120</u> (A)	<u>225</u> (B)																			
Prevalence Index = B/A = <u>1.88</u>																				
<b>Sapling/Shrub Stratum</b> (Plot size: <u>15</u> )																				
1. <u>Cornus amomum</u>	<u>20</u>	<u>Yes</u>	<u>FACW</u>																	
2. _____	_____	_____	_____																	
3. _____	_____	_____	_____																	
4. _____	_____	_____	_____																	
5. _____	_____	_____	_____																	
6. _____	_____	_____	_____																	
7. _____	_____	_____	_____																	
_____ =Total Cover				<b>Hydrophytic Vegetation Indicators:</b> <input type="checkbox"/> 1 - Rapid Test for Hydrophytic Vegetation <input checked="" type="checkbox"/> 2 - Dominance Test is >50% <input checked="" type="checkbox"/> 3 - Prevalence Index is ≤3.0 <sup>1</sup> <input type="checkbox"/> 4 - Morphological Adaptations <sup>1</sup> (Provide supporting data in Remarks or on a separate sheet)  <input type="checkbox"/> Problematic Hydrophytic Vegetation <sup>1</sup> (Explain)  <sup>1</sup> Indicators of hydric soil and wetland hydrology must be present, unless disturbed or problematic.																
<b>Herb Stratum</b> (Plot size: <u>5</u> )																				
1. <u>Phragmites australis</u>	<u>55</u>	<u>Yes</u>	<u>FACW</u>																	
2. <u>Impatiens capensis</u>	<u>25</u>	<u>Yes</u>	<u>FACW</u>																	
3. <u>Symplocarpus foetidus</u>	<u>15</u>	<u>No</u>	<u>OBL</u>																	
4. <u>Onoclea sensibilis</u>	<u>5</u>	<u>No</u>	<u>FACW</u>																	
5. _____	_____	_____	_____																	
6. _____	_____	_____	_____																	
7. _____	_____	_____	_____																	
8. _____	_____	_____	_____																	
9. _____	_____	_____	_____																	
10. _____	_____	_____	_____																	
11. _____	_____	_____	_____																	
12. _____	_____	_____	_____																	
_____ =Total Cover																				
<b>Woody Vine Stratum</b> (Plot size: _____)																				
1. _____	_____	_____	_____																	
2. _____	_____	_____	_____																	
3. _____	_____	_____	_____																	
4. _____	_____	_____	_____																	
_____ =Total Cover																				
<b>Definitions of Vegetation Strata:</b> <b>Tree</b> – Woody plants 3 in. (7.6 cm) or more in diameter at breast height (DBH), regardless of height. <b>Sapling/shrub</b> – Woody plants less than 3 in. DBH and greater than or equal to 3.28 ft (1 m) tall. <b>Herb</b> – All herbaceous (non-woody) plants, regardless of size, and woody plants less than 3.28 ft tall. <b>Woody vines</b> – All woody vines greater than 3.28 ft in height.																				
<b>Hydrophytic Vegetation Present?</b> Yes <u>X</u> No _____																				

Remarks: (Include photo numbers here or on a separate sheet.)



## WETLAND DETERMINATION DATA FORM – Northcentral and Northeast Region

Project/Site: GHCCRP City/County: Newington/Hartford Sampling Date: 6.23.15  
 Applicant/Owner: Eversource State: CT Sampling Point: UP-ROW-1  
 Investigator(s): K. Van Naerssen & M. Notestine Section, Township, Range: \_\_\_\_\_  
 Landform (hillside, terrace, etc.): flat ROW area Local relief (concave, convex, none): None Slope %: 0  
 Subregion (LRR or MLRA): LRR R, MLRA 145 Lat: 41.718089, Long: -72.744627 Datum: \_\_\_\_\_  
 Soil Map Unit Name: Branford silt loam, 3 to 8 percent slopes NWI classification: non WL

Are climatic / hydrologic conditions on the site typical for this time of year? Yes X No \_\_\_\_\_ (If no, explain in Remarks.)  
 Are Vegetation \_\_\_\_\_, Soil \_\_\_\_\_, or Hydrology \_\_\_\_\_ significantly disturbed? Are "Normal Circumstances" present? Yes X No \_\_\_\_\_  
 Are Vegetation \_\_\_\_\_, Soil \_\_\_\_\_, or Hydrology \_\_\_\_\_ naturally problematic? (If needed, explain any answers in Remarks.)

### SUMMARY OF FINDINGS – Attach site map showing sampling point locations, transects, important features, etc.

Hydrophytic Vegetation Present? Yes <u>X</u> No _____ Hydric Soil Present? Yes _____ No <u>X</u> Wetland Hydrology Present? Yes _____ No <u>X</u>	<b>Is the Sampled Area within a Wetland?</b> Yes _____ No <u>X</u> If yes, optional Wetland Site ID: _____
---	---

Remarks: (Explain alternative procedures here or in a separate report.)  
 Although wetland vegetation is present throughout this location, no evidence of hydrology or hydric soils is present.

### HYDROLOGY

<b>Wetland Hydrology Indicators:</b> <u>Primary Indicators (minimum of one is required; check all that apply)</u> _____ Surface Water (A1) _____ Water-Stained Leaves (B9) _____ High Water Table (A2) _____ Aquatic Fauna (B13) _____ Saturation (A3) _____ Marl Deposits (B15) _____ Water Marks (B1) _____ Hydrogen Sulfide Odor (C1) _____ Sediment Deposits (B2) _____ Oxidized Rhizospheres on Living Roots (C3) _____ Drift Deposits (B3) _____ Presence of Reduced Iron (C4) _____ Algal Mat or Crust (B4) _____ Recent Iron Reduction in Tilled Soils (C6) _____ Iron Deposits (B5) _____ Thin Muck Surface (C7) _____ Inundation Visible on Aerial Imagery (B7) _____ Other (Explain in Remarks) _____ Sparsely Vegetated Concave Surface (B8)	<u>Secondary Indicators (minimum of two required)</u> _____ Surface Soil Cracks (B6) _____ Drainage Patterns (B10) _____ Moss Trim Lines (B16) _____ Dry-Season Water Table (C2) _____ Crayfish Burrows (C8) _____ Saturation Visible on Aerial Imagery (C9) _____ Stunted or Stressed Plants (D1) _____ Geomorphic Position (D2) _____ Shallow Aquitard (D3) _____ Microtopographic Relief (D4) <u>X</u> FAC-Neutral Test (D5)
---	--

<b>Field Observations:</b> Surface Water Present? Yes _____ No <u>X</u> Depth (inches): _____ Water Table Present? Yes _____ No <u>X</u> Depth (inches): _____ Saturation Present? Yes _____ No <u>X</u> Depth (inches): _____ (includes capillary fringe)	<b>Wetland Hydrology Present?</b> Yes _____ No <u>X</u>
--	---

Describe Recorded Data (stream gauge, monitoring well, aerial photos, previous inspections), if available:

Remarks:  
 No evidence of wetland hydrology; therefore hydrology criterion is not met.

**VEGETATION** – Use scientific names of plants.

Sampling Point: UP-ROW-1

	Absolute % Cover	Dominant Species?	Indicator Status																	
<b>Tree Stratum</b> (Plot size: _____)																				
1. _____	_____	_____	_____	<b>Dominance Test worksheet:</b> Number of Dominant Species That Are OBL, FACW, or FAC: <u>2</u> (A)  Total Number of Dominant Species Across All Strata: <u>3</u> (B)  Percent of Dominant Species That Are OBL, FACW, or FAC: <u>66.7%</u> (A/B)																
2. _____	_____	_____	_____																	
3. _____	_____	_____	_____																	
4. _____	_____	_____	_____																	
5. _____	_____	_____	_____																	
6. _____	_____	_____	_____																	
7. _____	_____	_____	_____																	
_____ =Total Cover				<b>Prevalence Index worksheet:</b> <table style="width:100%; border-collapse: collapse;"> <thead> <tr> <th style="width:50%;">Total % Cover of:</th> <th style="width:50%;">Multiply by:</th> </tr> </thead> <tbody> <tr> <td>OBL species <u>0</u></td> <td>x 1 = <u>0</u></td> </tr> <tr> <td>FACW species <u>100</u></td> <td>x 2 = <u>200</u></td> </tr> <tr> <td>FAC species <u>0</u></td> <td>x 3 = <u>0</u></td> </tr> <tr> <td>FACU species <u>0</u></td> <td>x 4 = <u>0</u></td> </tr> <tr> <td>UPL species <u>80</u></td> <td>x 5 = <u>400</u></td> </tr> <tr> <td>Column Totals: <u>180</u> (A)</td> <td><u>600</u> (B)</td> </tr> <tr> <td colspan="2" style="text-align: center;">Prevalence Index = B/A = <u>3.33</u></td> </tr> </tbody> </table>	Total % Cover of:	Multiply by:	OBL species <u>0</u>	x 1 = <u>0</u>	FACW species <u>100</u>	x 2 = <u>200</u>	FAC species <u>0</u>	x 3 = <u>0</u>	FACU species <u>0</u>	x 4 = <u>0</u>	UPL species <u>80</u>	x 5 = <u>400</u>	Column Totals: <u>180</u> (A)	<u>600</u> (B)	Prevalence Index = B/A = <u>3.33</u>	
Total % Cover of:	Multiply by:																			
OBL species <u>0</u>	x 1 = <u>0</u>																			
FACW species <u>100</u>	x 2 = <u>200</u>																			
FAC species <u>0</u>	x 3 = <u>0</u>																			
FACU species <u>0</u>	x 4 = <u>0</u>																			
UPL species <u>80</u>	x 5 = <u>400</u>																			
Column Totals: <u>180</u> (A)	<u>600</u> (B)																			
Prevalence Index = B/A = <u>3.33</u>																				
<b>Sapling/Shrub Stratum</b> (Plot size: <u>15</u> )																				
1. <u>Lonicera maackii</u>	<u>80</u>	<u>Yes</u>	<u>UPL</u>																	
2. _____	_____	_____	_____																	
3. _____	_____	_____	_____																	
4. _____	_____	_____	_____																	
5. _____	_____	_____	_____																	
6. _____	_____	_____	_____																	
7. _____	_____	_____	_____																	
_____ =Total Cover				<b>Hydrophytic Vegetation Indicators:</b> <u>1</u> - Rapid Test for Hydrophytic Vegetation <input checked="" type="checkbox"/> <u>2</u> - Dominance Test is >50% <u>3</u> - Prevalence Index is ≤3.0 <sup>1</sup> <u>4</u> - Morphological Adaptations <sup>1</sup> (Provide supporting data in Remarks or on a separate sheet)  _____ Problematic Hydrophytic Vegetation <sup>1</sup> (Explain)  <sup>1</sup> Indicators of hydric soil and wetland hydrology must be present, unless disturbed or problematic.																
<b>Herb Stratum</b> (Plot size: <u>5</u> )																				
1. <u>Impatiens capensis</u>	<u>50</u>	<u>Yes</u>	<u>FACW</u>																	
2. <u>Phragmites australis</u>	<u>50</u>	<u>Yes</u>	<u>FACW</u>																	
3. _____	_____	_____	_____																	
4. _____	_____	_____	_____																	
5. _____	_____	_____	_____																	
6. _____	_____	_____	_____																	
7. _____	_____	_____	_____																	
8. _____	_____	_____	_____																	
9. _____	_____	_____	_____																	
10. _____	_____	_____	_____																	
11. _____	_____	_____	_____																	
12. _____	_____	_____	_____																	
_____ =Total Cover				<b>Definitions of Vegetation Strata:</b>  <b>Tree</b> – Woody plants 3 in. (7.6 cm) or more in diameter at breast height (DBH), regardless of height.  <b>Sapling/shrub</b> – Woody plants less than 3 in. DBH and greater than or equal to 3.28 ft (1 m) tall.  <b>Herb</b> – All herbaceous (non-woody) plants, regardless of size, and woody plants less than 3.28 ft tall.  <b>Woody vines</b> – All woody vines greater than 3.28 ft in height.																
<b>Woody Vine Stratum</b> (Plot size: _____)																				
1. _____	_____	_____	_____																	
2. _____	_____	_____	_____																	
3. _____	_____	_____	_____																	
4. _____	_____	_____	_____																	
_____ =Total Cover				<b>Hydrophytic Vegetation Present?</b> Yes <u>X</u> No _____																

Remarks: (Include photo numbers here or on a separate sheet.)



## WETLAND DETERMINATION DATA FORM – Northcentral and Northeast Region

Project/Site: GHCCRP City/County: Newington/Hartford Sampling Date: 6.23.15  
 Applicant/Owner: Eversource State: CT Sampling Point: W-ROW-2  
 Investigator(s): M. Notestine & K. Van Naerssen Section, Township, Range: \_\_\_\_\_  
 Landform (hillside, terrace, etc.): Slight hillside on ROW Local relief (concave, convex, none): concave Slope %: 5  
 Subregion (LRR or MLRA): LRR R, MLRA 145 Lat: 41.718585, Long: -72.740259 Datum: \_\_\_\_\_  
 Soil Map Unit Name: Scitico, Shaker, and Maybid soils NWI classification: PEM/PSS

Are climatic / hydrologic conditions on the site typical for this time of year? Yes X No \_\_\_\_\_ (If no, explain in Remarks.)  
 Are Vegetation \_\_\_\_\_, Soil \_\_\_\_\_, or Hydrology \_\_\_\_\_ significantly disturbed? Are "Normal Circumstances" present? Yes X No \_\_\_\_\_  
 Are Vegetation \_\_\_\_\_, Soil \_\_\_\_\_, or Hydrology \_\_\_\_\_ naturally problematic? (If needed, explain any answers in Remarks.)

### SUMMARY OF FINDINGS – Attach site map showing sampling point locations, transects, important features, etc.

Hydrophytic Vegetation Present? Yes <u>X</u> No _____ Hydric Soil Present? Yes <u>X</u> No _____ Wetland Hydrology Present? Yes <u>X</u> No _____	<b>Is the Sampled Area within a Wetland?</b> Yes <u>X</u> No _____ If yes, optional Wetland Site ID: _____
Remarks: (Explain alternative procedures here or in a separate report.)   	

### HYDROLOGY

<b>Wetland Hydrology Indicators:</b> <u>Primary Indicators (minimum of one is required; check all that apply)</u> <input checked="" type="checkbox"/> Surface Water (A1) <input checked="" type="checkbox"/> Water-Stained Leaves (B9) <input type="checkbox"/> High Water Table (A2) <input type="checkbox"/> Aquatic Fauna (B13) <input checked="" type="checkbox"/> Saturation (A3) <input type="checkbox"/> Marl Deposits (B15) <input type="checkbox"/> Water Marks (B1) <input type="checkbox"/> Hydrogen Sulfide Odor (C1) <input type="checkbox"/> Sediment Deposits (B2) <input type="checkbox"/> Oxidized Rhizospheres on Living Roots (C3) <input type="checkbox"/> Drift Deposits (B3) <input checked="" type="checkbox"/> Presence of Reduced Iron (C4) <input type="checkbox"/> Algal Mat or Crust (B4) <input type="checkbox"/> Recent Iron Reduction in Tilled Soils (C6) <input type="checkbox"/> Iron Deposits (B5) <input type="checkbox"/> Thin Muck Surface (C7) <input type="checkbox"/> Inundation Visible on Aerial Imagery (B7) <input type="checkbox"/> Other (Explain in Remarks) <input type="checkbox"/> Sparsely Vegetated Concave Surface (B8)	<u>Secondary Indicators (minimum of two required)</u> <input type="checkbox"/> Surface Soil Cracks (B6) <input type="checkbox"/> Drainage Patterns (B10) <input type="checkbox"/> Moss Trim Lines (B16) <input type="checkbox"/> Dry-Season Water Table (C2) <input type="checkbox"/> Crayfish Burrows (C8) <input type="checkbox"/> Saturation Visible on Aerial Imagery (C9) <input type="checkbox"/> Stunted or Stressed Plants (D1) <input type="checkbox"/> Geomorphic Position (D2) <input type="checkbox"/> Shallow Aquitard (D3) <input type="checkbox"/> Microtopographic Relief (D4) <input checked="" type="checkbox"/> FAC-Neutral Test (D5)
<b>Field Observations:</b> Surface Water Present? Yes <u>X</u> No _____ Depth (inches): <u>2</u> Water Table Present? Yes _____ No <u>X</u> Depth (inches): _____ Saturation Present? Yes <u>X</u> No _____ Depth (inches): <u>0</u> (includes capillary fringe)	<b>Wetland Hydrology Present?</b> Yes <u>X</u> No _____
Describe Recorded Data (stream gauge, monitoring well, aerial photos, previous inspections), if available:  	
Remarks: Soils saturated and standing water is present; therefore wetland hydrology criterion is met.	



**VEGETATION** – Use scientific names of plants.

Sampling Point: W-ROW-2

	Absolute % Cover	Dominant Species?	Indicator Status																	
<b>Tree Stratum</b> (Plot size: _____)																				
1. _____	_____	_____	_____	<b>Dominance Test worksheet:</b> Number of Dominant Species That Are OBL, FACW, or FAC: <u>4</u> (A)  Total Number of Dominant Species Across All Strata: <u>6</u> (B)  Percent of Dominant Species That Are OBL, FACW, or FAC: <u>66.7%</u> (A/B)																
2. _____	_____	_____	_____																	
3. _____	_____	_____	_____																	
4. _____	_____	_____	_____																	
5. _____	_____	_____	_____																	
6. _____	_____	_____	_____																	
7. _____	_____	_____	_____																	
_____ =Total Cover				<b>Prevalence Index worksheet:</b> <table style="width:100%; border-collapse: collapse;"> <thead> <tr> <th style="width:50%;">Total % Cover of:</th> <th style="width:50%;">Multiply by:</th> </tr> </thead> <tbody> <tr> <td>OBL species <u>20</u></td> <td>x 1 = <u>20</u></td> </tr> <tr> <td>FACW species <u>78</u></td> <td>x 2 = <u>156</u></td> </tr> <tr> <td>FAC species <u>25</u></td> <td>x 3 = <u>75</u></td> </tr> <tr> <td>FACU species <u>7</u></td> <td>x 4 = <u>28</u></td> </tr> <tr> <td>UPL species <u>0</u></td> <td>x 5 = <u>0</u></td> </tr> <tr> <td>Column Totals: <u>130</u> (A)</td> <td><u>279</u> (B)</td> </tr> <tr> <td colspan="2" style="text-align: center;">Prevalence Index = B/A = <u>2.15</u></td> </tr> </tbody> </table>	Total % Cover of:	Multiply by:	OBL species <u>20</u>	x 1 = <u>20</u>	FACW species <u>78</u>	x 2 = <u>156</u>	FAC species <u>25</u>	x 3 = <u>75</u>	FACU species <u>7</u>	x 4 = <u>28</u>	UPL species <u>0</u>	x 5 = <u>0</u>	Column Totals: <u>130</u> (A)	<u>279</u> (B)	Prevalence Index = B/A = <u>2.15</u>	
Total % Cover of:	Multiply by:																			
OBL species <u>20</u>	x 1 = <u>20</u>																			
FACW species <u>78</u>	x 2 = <u>156</u>																			
FAC species <u>25</u>	x 3 = <u>75</u>																			
FACU species <u>7</u>	x 4 = <u>28</u>																			
UPL species <u>0</u>	x 5 = <u>0</u>																			
Column Totals: <u>130</u> (A)	<u>279</u> (B)																			
Prevalence Index = B/A = <u>2.15</u>																				
<b>Sapling/Shrub Stratum</b> (Plot size: <u>15</u> )																				
1. <u>Cornus amomum</u>	<u>15</u>	<u>Yes</u>	<u>FACW</u>																	
2. <u>Viburnum dentatum</u>	<u>25</u>	<u>Yes</u>	<u>FAC</u>																	
3. <u>Lindera benzoin</u>	<u>3</u>	<u>No</u>	<u>FACW</u>																	
4. <u>Rosa multiflora</u>	<u>7</u>	<u>No</u>	<u>FACU</u>																	
5. _____	_____	_____	_____																	
6. _____	_____	_____	_____																	
7. _____	_____	_____	_____																	
_____ =Total Cover				<b>Hydrophytic Vegetation Indicators:</b> <input type="checkbox"/> 1 - Rapid Test for Hydrophytic Vegetation <input checked="" type="checkbox"/> 2 - Dominance Test is >50% <input checked="" type="checkbox"/> 3 - Prevalence Index is ≤3.0 <sup>1</sup> <input type="checkbox"/> 4 - Morphological Adaptations <sup>1</sup> (Provide supporting data in Remarks or on a separate sheet)  <input type="checkbox"/> Problematic Hydrophytic Vegetation <sup>1</sup> (Explain)  <sup>1</sup> Indicators of hydric soil and wetland hydrology must be present, unless disturbed or problematic.																
<b>Herb Stratum</b> (Plot size: <u>5</u> )																				
1. <u>Phragmites australis</u>	<u>10</u>	<u>No</u>	<u>FACW</u>																	
2. <u>Impatiens capensis</u>	<u>30</u>	<u>Yes</u>	<u>FACW</u>																	
3. <u>Scirpus atrovirens</u>	<u>10</u>	<u>No</u>	<u>OBL</u>																	
4. <u>Asclepias incarnata</u>	<u>10</u>	<u>No</u>	<u>OBL</u>																	
5. <u>Phalaris arundinacea</u>	<u>20</u>	<u>Yes</u>	<u>FACW</u>																	
6. <u>Solidago spp.</u>	<u>20</u>	<u>Yes</u>	_____																	
7. _____	_____	_____	_____																	
8. _____	_____	_____	_____																	
9. _____	_____	_____	_____																	
10. _____	_____	_____	_____																	
11. _____	_____	_____	_____																	
12. _____	_____	_____	_____																	
_____ =Total Cover																				
<b>Woody Vine Stratum</b> (Plot size: _____)																				
1. <u>Vitis</u>	<u>20</u>	<u>Yes</u>	_____																	
2. _____	_____	_____	_____																	
3. _____	_____	_____	_____																	
4. _____	_____	_____	_____																	
_____ =Total Cover				<b>Definitions of Vegetation Strata:</b>  <b>Tree</b> – Woody plants 3 in. (7.6 cm) or more in diameter at breast height (DBH), regardless of height.  <b>Sapling/shrub</b> – Woody plants less than 3 in. DBH and greater than or equal to 3.28 ft (1 m) tall.  <b>Herb</b> – All herbaceous (non-woody) plants, regardless of size, and woody plants less than 3.28 ft tall.  <b>Woody vines</b> – All woody vines greater than 3.28 ft in height.																
_____ =Total Cover																				
_____ =Total Cover				<b>Hydrophytic Vegetation Present?</b> Yes <u>X</u> No _____																

Remarks: (Include photo numbers here or on a separate sheet.)



## WETLAND DETERMINATION DATA FORM – Northcentral and Northeast Region

Project/Site: GHCCRP City/County: Newington/Hartford Sampling Date: 6.23.15  
 Applicant/Owner: Eversource State: CT Sampling Point: UP-ROW-2  
 Investigator(s): K. Van Naerssen & M. Notestine Section, Township, Range: \_\_\_\_\_  
 Landform (hillside, terrace, etc.): slight slope on ROW Local relief (concave, convex, none): convex Slope %: 5  
 Subregion (LRR or MLRA): LRR R, MLRA 145 Lat: 41.718808, Long: -72.739100 Datum: \_\_\_\_\_  
 Soil Map Unit Name: Wethersfield loam, 3 to 8 percent slopes NWI classification: non WL

Are climatic / hydrologic conditions on the site typical for this time of year? Yes X No \_\_\_\_\_ (If no, explain in Remarks.)  
 Are Vegetation \_\_\_\_\_, Soil \_\_\_\_\_, or Hydrology \_\_\_\_\_ significantly disturbed? Are "Normal Circumstances" present? Yes X No \_\_\_\_\_  
 Are Vegetation \_\_\_\_\_, Soil \_\_\_\_\_, or Hydrology \_\_\_\_\_ naturally problematic? (If needed, explain any answers in Remarks.)

### SUMMARY OF FINDINGS – Attach site map showing sampling point locations, transects, important features, etc.

Hydrophytic Vegetation Present? Yes _____ No <u>X</u> Hydric Soil Present? Yes _____ No <u>X</u> Wetland Hydrology Present? Yes _____ No <u>X</u>	<b>Is the Sampled Area within a Wetland?</b> Yes _____ No <u>X</u> If yes, optional Wetland Site ID: _____
Remarks: (Explain alternative procedures here or in a separate report.)	

### HYDROLOGY

<b>Wetland Hydrology Indicators:</b> <u>Primary Indicators (minimum of one is required; check all that apply)</u> _____ Surface Water (A1) _____ Water-Stained Leaves (B9) _____ High Water Table (A2) _____ Aquatic Fauna (B13) _____ Saturation (A3) _____ Marl Deposits (B15) _____ Water Marks (B1) _____ Hydrogen Sulfide Odor (C1) _____ Sediment Deposits (B2) _____ Oxidized Rhizospheres on Living Roots (C3) _____ Drift Deposits (B3) _____ Presence of Reduced Iron (C4) _____ Algal Mat or Crust (B4) _____ Recent Iron Reduction in Tilled Soils (C6) _____ Iron Deposits (B5) _____ Thin Muck Surface (C7) _____ Inundation Visible on Aerial Imagery (B7) _____ Other (Explain in Remarks) _____ Sparsely Vegetated Concave Surface (B8)	<u>Secondary Indicators (minimum of two required)</u> _____ Surface Soil Cracks (B6) _____ Drainage Patterns (B10) _____ Moss Trim Lines (B16) _____ Dry-Season Water Table (C2) _____ Crayfish Burrows (C8) _____ Saturation Visible on Aerial Imagery (C9) _____ Stunted or Stressed Plants (D1) _____ Geomorphic Position (D2) _____ Shallow Aquitard (D3) _____ Microtopographic Relief (D4) _____ FAC-Neutral Test (D5)
---	---

<b>Field Observations:</b> Surface Water Present? Yes _____ No <u>X</u> Depth (inches): _____ Water Table Present? Yes _____ No <u>X</u> Depth (inches): _____ Saturation Present? Yes _____ No <u>X</u> Depth (inches): _____ (includes capillary fringe)	<b>Wetland Hydrology Present?</b> Yes _____ No <u>X</u>
--	---

Describe Recorded Data (stream gauge, monitoring well, aerial photos, previous inspections), if available:

Remarks:  
 No evidence of wetland hydrology; therefore hydrology criterion is not met.

**VEGETATION** – Use scientific names of plants.

Sampling Point: UP-ROW-2

	Absolute % Cover	Dominant Species?	Indicator Status	
<b>Tree Stratum</b> (Plot size: _____)				
1.	_____	_____	_____	
2.	_____	_____	_____	
3.	_____	_____	_____	
4.	_____	_____	_____	
5.	_____	_____	_____	
6.	_____	_____	_____	
7.	_____	_____	_____	
	=Total Cover			
<b>Sapling/Shrub Stratum</b> (Plot size: <u>15</u> )				
1.	<u>Quercus rubra</u>	5	Yes	FACU
2.	_____	_____	_____	_____
3.	_____	_____	_____	_____
4.	_____	_____	_____	_____
5.	_____	_____	_____	_____
6.	_____	_____	_____	_____
7.	_____	_____	_____	_____
	=Total Cover			
<b>Herb Stratum</b> (Plot size: <u>5</u> )				
1.	<u>Dichanthelium clandestinum</u>	30	Yes	FACW
2.	<u>Solidago rugosa</u>	20	Yes	FAC
3.	<u>Potentilla simplex</u>	5	No	FACU
4.	<u>Agrostis gigantea</u>	5	No	FACW
5.	<u>Phleum pratense</u>	10	No	FACU
6.	_____	_____	_____	_____
7.	_____	_____	_____	_____
8.	_____	_____	_____	_____
9.	_____	_____	_____	_____
10.	_____	_____	_____	_____
11.	_____	_____	_____	_____
12.	_____	_____	_____	_____
	=Total Cover			
<b>Woody Vine Stratum</b> (Plot size: _____)				
1.	<u>Rubus occidentalis</u>	10	Yes	UPL
2.	<u>Celastrus orbiculatus</u>	10	Yes	UPL
3.	_____	_____	_____	_____
4.	_____	_____	_____	_____
	=Total Cover			

**Dominance Test worksheet:**

Number of Dominant Species That Are OBL, FACW, or FAC: 2 (A)

Total Number of Dominant Species Across All Strata: 5 (B)

Percent of Dominant Species That Are OBL, FACW, or FAC: 40.0% (A/B)

**Prevalence Index worksheet:**

	Total % Cover of:	Multiply by:	
OBL species	<u>0</u>	x 1 =	<u>0</u>
FACW species	<u>35</u>	x 2 =	<u>70</u>
FAC species	<u>20</u>	x 3 =	<u>60</u>
FACU species	<u>20</u>	x 4 =	<u>80</u>
UPL species	<u>20</u>	x 5 =	<u>100</u>
Column Totals:	<u>95</u> (A)		<u>310</u> (B)
Prevalence Index = B/A =			<u>3.26</u>

**Hydrophytic Vegetation Indicators:**

   1 - Rapid Test for Hydrophytic Vegetation

   2 - Dominance Test is >50%

   3 - Prevalence Index is ≤3.0<sup>1</sup>

   4 - Morphological Adaptations<sup>1</sup> (Provide supporting data in Remarks or on a separate sheet)

   Problematic Hydrophytic Vegetation<sup>1</sup> (Explain)

<sup>1</sup>Indicators of hydric soil and wetland hydrology must be present, unless disturbed or problematic.

**Definitions of Vegetation Strata:**

**Tree** – Woody plants 3 in. (7.6 cm) or more in diameter at breast height (DBH), regardless of height.

**Sapling/shrub** – Woody plants less than 3 in. DBH and greater than or equal to 3.28 ft (1 m) tall.

**Herb** – All herbaceous (non-woody) plants, regardless of size, and woody plants less than 3.28 ft tall.

**Woody vines** – All woody vines greater than 3.28 ft in height.

**Hydrophytic Vegetation Present?**      Yes         No   X

Remarks: (Include photo numbers here or on a separate sheet.)



## WETLAND DETERMINATION DATA FORM – Northcentral and Northeast Region

Project/Site: GHCCRP City/County: Newington/Hartford Sampling Date: 6.23.15  
 Applicant/Owner: Eversource State: CT Sampling Point: W-ROW-3  
 Investigator(s): K. Van Naerssen & M. Notestine Section, Township, Range: \_\_\_\_\_  
 Landform (hillside, terrace, etc.): Slight hillside on ROW Local relief (concave, convex, none): concave Slope %: 7  
 Subregion (LRR or MLRA): LRR R, MLRA 145 Lat: 41.718958, Long: -72.737857 Datum: \_\_\_\_\_  
 Soil Map Unit Name: Wethersfield loam, 3 to 8 percent slopes NWI classification: PSS/PEM

Are climatic / hydrologic conditions on the site typical for this time of year? Yes X No \_\_\_\_\_ (If no, explain in Remarks.)  
 Are Vegetation \_\_\_\_\_, Soil \_\_\_\_\_, or Hydrology \_\_\_\_\_ significantly disturbed? Are "Normal Circumstances" present? Yes X No \_\_\_\_\_  
 Are Vegetation \_\_\_\_\_, Soil \_\_\_\_\_, or Hydrology \_\_\_\_\_ naturally problematic? (If needed, explain any answers in Remarks.)

### SUMMARY OF FINDINGS – Attach site map showing sampling point locations, transects, important features, etc.

Hydrophytic Vegetation Present? Yes <u>X</u> No _____ Hydric Soil Present? Yes <u>X</u> No _____ Wetland Hydrology Present? Yes <u>X</u> No _____	<b>Is the Sampled Area within a Wetland?</b> Yes <u>X</u> No _____ If yes, optional Wetland Site ID: _____
Remarks: (Explain alternative procedures here or in a separate report.)   	

### HYDROLOGY

<b>Wetland Hydrology Indicators:</b> <u>Primary Indicators (minimum of one is required; check all that apply)</u> _____ Surface Water (A1) _____ Water-Stained Leaves (B9) _____ High Water Table (A2) _____ Aquatic Fauna (B13) <u>X</u> Saturation (A3) _____ Marl Deposits (B15) _____ Water Marks (B1) _____ Hydrogen Sulfide Odor (C1) _____ Sediment Deposits (B2) _____ Oxidized Rhizospheres on Living Roots (C3) _____ Drift Deposits (B3) <u>X</u> Presence of Reduced Iron (C4) _____ Algal Mat or Crust (B4) _____ Recent Iron Reduction in Tilled Soils (C6) _____ Iron Deposits (B5) _____ Thin Muck Surface (C7) _____ Inundation Visible on Aerial Imagery (B7) _____ Other (Explain in Remarks) _____ Sparsely Vegetated Concave Surface (B8)	<u>Secondary Indicators (minimum of two required)</u> _____ Surface Soil Cracks (B6) _____ Drainage Patterns (B10) _____ Moss Trim Lines (B16) _____ Dry-Season Water Table (C2) _____ Crayfish Burrows (C8) _____ Saturation Visible on Aerial Imagery (C9) _____ Stunted or Stressed Plants (D1) _____ Geomorphic Position (D2) _____ Shallow Aquitard (D3) _____ Microtopographic Relief (D4) <u>X</u> FAC-Neutral Test (D5)
---	--

<b>Field Observations:</b> Surface Water Present? Yes _____ No <u>X</u> Depth (inches): _____ Water Table Present? Yes _____ No <u>X</u> Depth (inches): _____ Saturation Present? Yes <u>X</u> No _____ Depth (inches): <u>0</u> (includes capillary fringe)	<b>Wetland Hydrology Present?</b> Yes <u>X</u> No _____
---	---

Describe Recorded Data (stream gauge, monitoring well, aerial photos, previous inspections), if available:

Remarks:  
 Soils saturated at surface; therefore wetland hydrology criterion is met.

**VEGETATION** – Use scientific names of plants.

Sampling Point: W-ROW-3

	Absolute % Cover	Dominant Species?	Indicator Status																									
<b>Tree Stratum</b> (Plot size: <u>30</u> )																												
1. <u>Acer saccharinum</u>	<u>10</u>	Yes	FACW	<b>Dominance Test worksheet:</b> Number of Dominant Species That Are OBL, FACW, or FAC: <u>5</u> (A)  Total Number of Dominant Species Across All Strata: <u>5</u> (B)  Percent of Dominant Species That Are OBL, FACW, or FAC: <u>100.0%</u> (A/B)																								
2. _____	_____	_____	_____																									
3. _____	_____	_____	_____																									
4. _____	_____	_____	_____																									
5. _____	_____	_____	_____																									
6. _____	_____	_____	_____																									
7. _____	_____	_____	_____																									
	<u>10</u>	=Total Cover																										
<b>Sapling/Shrub Stratum</b> (Plot size: <u>15</u> )																												
1. <u>Cornus amomum</u>	<u>15</u>	Yes	FACW	<b>Prevalence Index worksheet:</b> <table style="width:100%; border:none;"> <tr> <td style="width:30%;"></td> <td style="width:30%; text-align:center;">Total % Cover of:</td> <td style="width:40%; text-align:center;">Multiply by:</td> </tr> <tr> <td>OBL species</td> <td style="text-align:center;"><u>95</u></td> <td style="text-align:center;">x 1 = <u>95</u></td> </tr> <tr> <td>FACW species</td> <td style="text-align:center;"><u>30</u></td> <td style="text-align:center;">x 2 = <u>60</u></td> </tr> <tr> <td>FAC species</td> <td style="text-align:center;"><u>5</u></td> <td style="text-align:center;">x 3 = <u>15</u></td> </tr> <tr> <td>FACU species</td> <td style="text-align:center;"><u>0</u></td> <td style="text-align:center;">x 4 = <u>0</u></td> </tr> <tr> <td>UPL species</td> <td style="text-align:center;"><u>0</u></td> <td style="text-align:center;">x 5 = <u>0</u></td> </tr> <tr> <td>Column Totals:</td> <td style="text-align:center;"><u>130</u> (A)</td> <td style="text-align:center;"><u>170</u> (B)</td> </tr> <tr> <td colspan="2"></td> <td style="text-align:center;">Prevalence Index = B/A = <u>1.31</u></td> </tr> </table>		Total % Cover of:	Multiply by:	OBL species	<u>95</u>	x 1 = <u>95</u>	FACW species	<u>30</u>	x 2 = <u>60</u>	FAC species	<u>5</u>	x 3 = <u>15</u>	FACU species	<u>0</u>	x 4 = <u>0</u>	UPL species	<u>0</u>	x 5 = <u>0</u>	Column Totals:	<u>130</u> (A)	<u>170</u> (B)			Prevalence Index = B/A = <u>1.31</u>
	Total % Cover of:	Multiply by:																										
OBL species	<u>95</u>	x 1 = <u>95</u>																										
FACW species	<u>30</u>	x 2 = <u>60</u>																										
FAC species	<u>5</u>	x 3 = <u>15</u>																										
FACU species	<u>0</u>	x 4 = <u>0</u>																										
UPL species	<u>0</u>	x 5 = <u>0</u>																										
Column Totals:	<u>130</u> (A)	<u>170</u> (B)																										
		Prevalence Index = B/A = <u>1.31</u>																										
2. <u>Viburnum dentatum</u>	<u>5</u>	Yes	FAC																									
3. <u>Sambucus nigra</u>	<u>5</u>	Yes	FACW																									
4. _____	_____	_____	_____																									
5. _____	_____	_____	_____																									
6. _____	_____	_____	_____																									
7. _____	_____	_____	_____																									
	<u>25</u>	=Total Cover																										
<b>Herb Stratum</b> (Plot size: <u>5</u> )																												
1. <u>Typha latifolia</u>	<u>75</u>	Yes	OBL	<b>Hydrophytic Vegetation Indicators:</b> <input type="checkbox"/> 1 - Rapid Test for Hydrophytic Vegetation <input checked="" type="checkbox"/> 2 - Dominance Test is >50% <input checked="" type="checkbox"/> 3 - Prevalence Index is ≤3.0 <sup>1</sup> <input type="checkbox"/> 4 - Morphological Adaptations <sup>1</sup> (Provide supporting data in Remarks or on a separate sheet) <input type="checkbox"/> Problematic Hydrophytic Vegetation <sup>1</sup> (Explain)  <sup>1</sup> Indicators of hydric soil and wetland hydrology must be present, unless disturbed or problematic.																								
2. <u>Carex lurida</u>	<u>5</u>	No	OBL																									
3. <u>Carex crinita</u>	<u>5</u>	No	OBL																									
4. <u>Juncus effusus</u>	<u>5</u>	No	OBL																									
5. <u>Carex stipata</u>	<u>5</u>	No	OBL																									
6. <u>Solidago spp.</u>	<u>5</u>	No	_____																									
7. _____	_____	_____	_____																									
8. _____	_____	_____	_____																									
9. _____	_____	_____	_____																									
10. _____	_____	_____	_____																									
11. _____	_____	_____	_____																									
12. _____	_____	_____	_____																									
	<u>100</u>	=Total Cover																										
<b>Woody Vine Stratum</b> (Plot size: _____ )																												
1. _____	_____	_____	_____																									
2. _____	_____	_____	_____																									
3. _____	_____	_____	_____																									
4. _____	_____	_____	_____																									
	=Total Cover																											
<b>Definitions of Vegetation Strata:</b> <b>Tree</b> – Woody plants 3 in. (7.6 cm) or more in diameter at breast height (DBH), regardless of height. <b>Sapling/shrub</b> – Woody plants less than 3 in. DBH and greater than or equal to 3.28 ft (1 m) tall. <b>Herb</b> – All herbaceous (non-woody) plants, regardless of size, and woody plants less than 3.28 ft tall. <b>Woody vines</b> – All woody vines greater than 3.28 ft in height.																												
<b>Hydrophytic Vegetation Present?</b> Yes <u>X</u> No _____																												

Remarks: (Include photo numbers here or on a separate sheet.)





## WETLAND DETERMINATION DATA FORM – Northcentral and Northeast Region

Project/Site: GHCCRP City/County: Newington/Hartford Sampling Date: 6.23.15  
 Applicant/Owner: Eversource State: CT Sampling Point: W-ROW-4  
 Investigator(s): K. Van Naerssen & M. Notestine Section, Township, Range: \_\_\_\_\_  
 Landform (hillside, terrace, etc.): wetland shelf along floodplain Local relief (concave, convex, none): concave Slope %: 1  
 Subregion (LRR or MLRA): LRR R, MLRA 145 Lat: 41.734100, Long: -72.727228 Datum: \_\_\_\_\_  
 Soil Map Unit Name: Udorthents, flood control NWI classification: PEM

Are climatic / hydrologic conditions on the site typical for this time of year? Yes X No \_\_\_\_\_ (If no, explain in Remarks.)  
 Are Vegetation \_\_\_\_\_, Soil \_\_\_\_\_, or Hydrology \_\_\_\_\_ significantly disturbed? Are "Normal Circumstances" present? Yes X No \_\_\_\_\_  
 Are Vegetation \_\_\_\_\_, Soil \_\_\_\_\_, or Hydrology \_\_\_\_\_ naturally problematic? (If needed, explain any answers in Remarks.)

### SUMMARY OF FINDINGS – Attach site map showing sampling point locations, transects, important features, etc.

Hydrophytic Vegetation Present? Yes <u>X</u> No _____ Hydric Soil Present? Yes <u>X</u> No _____ Wetland Hydrology Present? Yes <u>X</u> No _____	<b>Is the Sampled Area within a Wetland?</b> Yes <u>X</u> No _____ If yes, optional Wetland Site ID: _____
Remarks: (Explain alternative procedures here or in a separate report.)   	

### HYDROLOGY

<b>Wetland Hydrology Indicators:</b> <u>Primary Indicators (minimum of one is required; check all that apply)</u> <input checked="" type="checkbox"/> Surface Water (A1) _____ Water-Stained Leaves (B9) <input checked="" type="checkbox"/> High Water Table (A2) _____ Aquatic Fauna (B13) <input checked="" type="checkbox"/> Saturation (A3) _____ Marl Deposits (B15) _____ Water Marks (B1) _____ Hydrogen Sulfide Odor (C1) _____ Sediment Deposits (B2) _____ Oxidized Rhizospheres on Living Roots (C3) _____ Drift Deposits (B3) _____ Presence of Reduced Iron (C4) _____ Algal Mat or Crust (B4) _____ Recent Iron Reduction in Tilled Soils (C6) _____ Iron Deposits (B5) _____ Thin Muck Surface (C7) _____ Inundation Visible on Aerial Imagery (B7) _____ Other (Explain in Remarks) _____ Sparsely Vegetated Concave Surface (B8)	<u>Secondary Indicators (minimum of two required)</u> _____ Surface Soil Cracks (B6) <input checked="" type="checkbox"/> Drainage Patterns (B10) _____ Moss Trim Lines (B16) _____ Dry-Season Water Table (C2) _____ Crayfish Burrows (C8) _____ Saturation Visible on Aerial Imagery (C9) _____ Stunted or Stressed Plants (D1) _____ Geomorphic Position (D2) _____ Shallow Aquitard (D3) _____ Microtopographic Relief (D4) <input checked="" type="checkbox"/> FAC-Neutral Test (D5)
---	---

<b>Field Observations:</b> Surface Water Present? Yes <u>X</u> No _____ Depth (inches): <u>4</u> Water Table Present? Yes <u>X</u> No _____ Depth (inches): <u>0</u> Saturation Present? Yes <u>X</u> No _____ Depth (inches): <u>0</u> (includes capillary fringe)	<b>Wetland Hydrology Present?</b> Yes <u>X</u> No _____
---	---

Describe Recorded Data (stream gauge, monitoring well, aerial photos, previous inspections), if available:

Remarks:  
 Soils saturated at surface and standing water pooled to a depth of 4"; therefore wetland hydrology criterion is met.

**VEGETATION** – Use scientific names of plants.

Sampling Point: W-ROW-4

	Absolute % Cover	Dominant Species?	Indicator Status	
<b>Tree Stratum</b> (Plot size: _____)				
1.	_____	_____	_____	
2.	_____	_____	_____	
3.	_____	_____	_____	
4.	_____	_____	_____	
5.	_____	_____	_____	
6.	_____	_____	_____	
7.	_____	_____	_____	
	=Total Cover			
<b>Sapling/Shrub Stratum</b> (Plot size: _____)				
1.	_____	_____	_____	
2.	_____	_____	_____	
3.	_____	_____	_____	
4.	_____	_____	_____	
5.	_____	_____	_____	
6.	_____	_____	_____	
7.	_____	_____	_____	
	=Total Cover			
<b>Herb Stratum</b> (Plot size: <u>5</u> )				
1.	<u>Typha latifolia</u>	38	Yes	OBL
2.	<u>Scirpus atrovirens</u>	5	No	OBL
3.	<u>Carex crinita</u>	2	No	OBL
4.	<u>Phalaris arundinacea</u>	48	Yes	FACW
5.	<u>Carex stipata</u>	2	No	OBL
6.	<u>Solidago spp.</u>	5	No	
7.	_____	_____	_____	
8.	_____	_____	_____	
9.	_____	_____	_____	
10.	_____	_____	_____	
11.	_____	_____	_____	
12.	_____	_____	_____	
	100 =Total Cover			
<b>Woody Vine Stratum</b> (Plot size: _____)				
1.	_____	_____	_____	
2.	_____	_____	_____	
3.	_____	_____	_____	
4.	_____	_____	_____	
	=Total Cover			

**Dominance Test worksheet:**

Number of Dominant Species That Are OBL, FACW, or FAC: 2 (A)

Total Number of Dominant Species Across All Strata: 2 (B)

Percent of Dominant Species That Are OBL, FACW, or FAC: 100.0% (A/B)

**Prevalence Index worksheet:**

Total % Cover of:	Multiply by:
OBL species <u>47</u>	x 1 = <u>47</u>
FACW species <u>48</u>	x 2 = <u>96</u>
FAC species <u>0</u>	x 3 = <u>0</u>
FACU species <u>0</u>	x 4 = <u>0</u>
UPL species <u>0</u>	x 5 = <u>0</u>
Column Totals: <u>95</u> (A)	<u>143</u> (B)
Prevalence Index = B/A = <u>1.51</u>	

**Hydrophytic Vegetation Indicators:**

   1 - Rapid Test for Hydrophytic Vegetation

2 - Dominance Test is >50%

3 - Prevalence Index is ≤3.0<sup>1</sup>

   4 - Morphological Adaptations<sup>1</sup> (Provide supporting data in Remarks or on a separate sheet)

   Problematic Hydrophytic Vegetation<sup>1</sup> (Explain)

<sup>1</sup>Indicators of hydric soil and wetland hydrology must be present, unless disturbed or problematic.

**Definitions of Vegetation Strata:**

**Tree** – Woody plants 3 in. (7.6 cm) or more in diameter at breast height (DBH), regardless of height.

**Sapling/shrub** – Woody plants less than 3 in. DBH and greater than or equal to 3.28 ft (1 m) tall.

**Herb** – All herbaceous (non-woody) plants, regardless of size, and woody plants less than 3.28 ft tall.

**Woody vines** – All woody vines greater than 3.28 ft in height.

**Hydrophytic Vegetation Present?**      Yes       No

Remarks: (Include photo numbers here or on a separate sheet.)



## WETLAND DETERMINATION DATA FORM – Northcentral and Northeast Region

Project/Site: GHCCRP City/County: Newington/Hartford Sampling Date: 6.23.15  
 Applicant/Owner: Eversource State: CT Sampling Point: UP-ROW-3  
 Investigator(s): K. Van Naerssen & M. Notestine Section, Township, Range: \_\_\_\_\_  
 Landform (hillside, terrace, etc.): streambank Local relief (concave, convex, none): concave Slope %: 30  
 Subregion (LRR or MLRA): LRR R, MLRA 145 Lat: 41.734046, Long: -72.726784 Datum: \_\_\_\_\_  
 Soil Map Unit Name: Udorthents, smoothed NWI classification: non WL

Are climatic / hydrologic conditions on the site typical for this time of year? Yes X No \_\_\_\_\_ (If no, explain in Remarks.)  
 Are Vegetation \_\_\_\_\_, Soil \_\_\_\_\_, or Hydrology \_\_\_\_\_ significantly disturbed? Are "Normal Circumstances" present? Yes \_\_\_\_\_ No \_\_\_\_\_  
 Are Vegetation \_\_\_\_\_, Soil \_\_\_\_\_, or Hydrology \_\_\_\_\_ naturally problematic? (If needed, explain any answers in Remarks.)

### SUMMARY OF FINDINGS – Attach site map showing sampling point locations, transects, important features, etc.

Hydrophytic Vegetation Present? Yes _____ No <u>X</u> Hydric Soil Present? Yes _____ No <u>X</u> Wetland Hydrology Present? Yes _____ No <u>X</u>	<b>Is the Sampled Area within a Wetland?</b> Yes _____ No <u>X</u> If yes, optional Wetland Site ID: _____
Remarks: (Explain alternative procedures here or in a separate report.)	

### HYDROLOGY

<b>Wetland Hydrology Indicators:</b> <u>Primary Indicators (minimum of one is required; check all that apply)</u> _____ Surface Water (A1) _____ Water-Stained Leaves (B9) _____ High Water Table (A2) _____ Aquatic Fauna (B13) _____ Saturation (A3) _____ Marl Deposits (B15) _____ Water Marks (B1) _____ Hydrogen Sulfide Odor (C1) _____ Sediment Deposits (B2) _____ Oxidized Rhizospheres on Living Roots (C3) _____ Drift Deposits (B3) _____ Presence of Reduced Iron (C4) _____ Algal Mat or Crust (B4) _____ Recent Iron Reduction in Tilled Soils (C6) _____ Iron Deposits (B5) _____ Thin Muck Surface (C7) _____ Inundation Visible on Aerial Imagery (B7) _____ Other (Explain in Remarks) _____ Sparsely Vegetated Concave Surface (B8)	<u>Secondary Indicators (minimum of two required)</u> _____ Surface Soil Cracks (B6) _____ Drainage Patterns (B10) _____ Moss Trim Lines (B16) _____ Dry-Season Water Table (C2) _____ Crayfish Burrows (C8) _____ Saturation Visible on Aerial Imagery (C9) _____ Stunted or Stressed Plants (D1) _____ Geomorphic Position (D2) _____ Shallow Aquitard (D3) _____ Microtopographic Relief (D4) _____ FAC-Neutral Test (D5)
---	---

<b>Field Observations:</b> Surface Water Present? Yes _____ No <u>X</u> Depth (inches): _____ Water Table Present? Yes _____ No <u>X</u> Depth (inches): _____ Saturation Present? Yes _____ No <u>X</u> Depth (inches): _____ (includes capillary fringe)	<b>Wetland Hydrology Present?</b> Yes _____ No <u>X</u>
--	---

Describe Recorded Data (stream gauge, monitoring well, aerial photos, previous inspections), if available:

Remarks:  
 No evidence of wetland hydrology; therefore hydrology criterion is not met.

**VEGETATION** – Use scientific names of plants.

Sampling Point: UP-ROW-3

	Absolute % Cover	Dominant Species?	Indicator Status	
<b>Tree Stratum</b> (Plot size: _____)				
1.	_____	_____	_____	
2.	_____	_____	_____	
3.	_____	_____	_____	
4.	_____	_____	_____	
5.	_____	_____	_____	
6.	_____	_____	_____	
7.	_____	_____	_____	
	=Total Cover			
<b>Sapling/Shrub Stratum</b> (Plot size: <u>15</u> )				
1.	_____	_____	_____	
2.	_____	_____	_____	
3.	_____	_____	_____	
4.	_____	_____	_____	
5.	_____	_____	_____	
6.	_____	_____	_____	
7.	_____	_____	_____	
	=Total Cover			
<b>Herb Stratum</b> (Plot size: <u>5</u> )				
1.	<u>Asclepias syriaca</u>	5	No	UPL
2.	<u>Solidago rugosa</u>	40	Yes	FAC
3.	<u>Cytisus scoparius</u>	10	No	UPL
4.	<u>Vicia sativa</u>	20	Yes	FACU
5.	<u>Phleum pratense</u>	10	No	FACU
6.	<u>Cirsium arvense</u>	10	No	FACU
7.	_____	_____	_____	
8.	_____	_____	_____	
9.	_____	_____	_____	
10.	_____	_____	_____	
11.	_____	_____	_____	
12.	_____	_____	_____	
	95 =Total Cover			
<b>Woody Vine Stratum</b> (Plot size: _____)				
1.	_____	_____	_____	
2.	_____	_____	_____	
3.	_____	_____	_____	
4.	_____	_____	_____	
	=Total Cover			

**Dominance Test worksheet:**

Number of Dominant Species That Are OBL, FACW, or FAC: 1 (A)

Total Number of Dominant Species Across All Strata: 2 (B)

Percent of Dominant Species That Are OBL, FACW, or FAC: 50.0% (A/B)

---

**Prevalence Index worksheet:**

	Total % Cover of:		Multiply by:	
OBL species	<u>0</u>	x 1 =	<u>0</u>	
FACW species	<u>0</u>	x 2 =	<u>0</u>	
FAC species	<u>40</u>	x 3 =	<u>120</u>	
FACU species	<u>40</u>	x 4 =	<u>160</u>	
UPL species	<u>15</u>	x 5 =	<u>75</u>	
Column Totals:	<u>95</u>	(A)	<u>355</u>	(B)
Prevalence Index = B/A =				<u>3.74</u>

---

**Hydrophytic Vegetation Indicators:**

1 - Rapid Test for Hydrophytic Vegetation

2 - Dominance Test is >50%

3 - Prevalence Index is ≤3.0<sup>1</sup>

4 - Morphological Adaptations<sup>1</sup> (Provide supporting data in Remarks or on a separate sheet)

   Problematic Hydrophytic Vegetation<sup>1</sup> (Explain)

<sup>1</sup>Indicators of hydric soil and wetland hydrology must be present, unless disturbed or problematic.

---

**Definitions of Vegetation Strata:**

**Tree** – Woody plants 3 in. (7.6 cm) or more in diameter at breast height (DBH), regardless of height.

**Sapling/shrub** – Woody plants less than 3 in. DBH and greater than or equal to 3.28 ft (1 m) tall.

**Herb** – All herbaceous (non-woody) plants, regardless of size, and woody plants less than 3.28 ft tall.

**Woody vines** – All woody vines greater than 3.28 ft in height.

---

**Hydrophytic Vegetation Present?**      Yes         No   X

Remarks: (Include photo numbers here or on a separate sheet.)



***Note: This page intentionally left blank.***

**Appendix C**  
**2015 Representative Site Photographs**

---



***Note: This page intentionally left blank.***

**PHOTOGRAPHIC LOG**

<b>Client Name:</b> Eversource		<b>Site Location:</b> GHCCRP		<b>Project No.</b> 60340574	
<b>Photo No.</b> 1	<b>Date:</b> 5/20/2015				
<b>Direction Photo Taken:</b>  East					
<b>Description:</b>  View of northern edge of Berlin Substation. Wetland B-2 is located to the north of this photo.					

<b>Photo No.</b> 2	<b>Date:</b> 5/20/2015				
<b>Direction Photo Taken:</b>  East					
<b>Description:</b>  View of Wetland B-1. Photo taken at the Berlin Substation.					

**PHOTOGRAPHIC LOG**

<b>Client Name:</b> Eversource		<b>Site Location:</b> GHCCRP		<b>Project No.</b> 60340574
<b>Photo No.</b> 3	<b>Date:</b> 5/15/2015	 A photograph showing a dirt path on the right side, bordered by a chain-link fence. To the left of the path is a dense area of green vegetation, identified as Wetland N-1. In the background, there are trees and utility poles under an overcast sky.		
<b>Direction Photo Taken:</b>  West				
<b>Description:</b>  View of Wetland N-1 located south of the Newington Substation. Wetland located on the left side of photo.				

<b>Photo No.</b> 4	<b>Date:</b> 5/15/2015	 A photograph showing a dirt path on the left side, bordered by a chain-link fence. To the right of the path is a paved area. In the background, there are trees and utility poles. Wetland N-1 is visible in the background.	
<b>Direction Photo Taken:</b>  South			
<b>Description:</b>  View of the west side of the Newington Substation and fenceline expansion area. Wetland N-1 located in photo background.			

**PHOTOGRAPHIC LOG**

**Client Name:** Eversource

**Site Location:** GHCCRP

**Project No.** 60340574

**Photo No.**  
5

**Date:**  
5/15/2015

**Direction Photo Taken:**

Southwest

**Description:**

Southwest Hartford Substation main entrance and access drive. Proposed expansion area visible in photo.



**Photo No.**  
6

**Date:**  
5/15/2015

**Direction Photo Taken:**

South

**Description:**

Unnamed Tributary to South Branch of the Park River. Stream is located to the east and south of the Southwest Hartford Substation, downgradient of a steep embankment to the south and east of the access drive.



**PHOTOGRAPHIC LOG**

**Client Name:** Eversource

**Site Location:** GHCCRP

**Project No.** 60340574

**Photo No.**  
7      **Date:**  
6/23/2015

**Direction Photo Taken:**

Southeast

**Description:**

View of Wetland N-1 at the Newington Substation Site.



**Photo No.**  
8      **Date:**  
6/23/2015

**Direction Photo Taken:**

East


**Description:**

View of wetland N-2, located along the Eversource ROW in Newington.



**PHOTOGRAPHIC LOG**

<b>Client Name:</b> Eversource		<b>Site Location:</b> GHCCRP		<b>Project No.</b> 60340574	
<b>Photo No.</b> 9	<b>Date:</b> 6/23/2015				
<b>Direction Photo Taken:</b>  East					
<b>Description:</b>  View of Wetland N-4 located in Newington.					

<b>Photo No.</b> 10	<b>Date:</b> 6/23/2015				
<b>Direction Photo Taken:</b>  Northeast					
<b>Description:</b>  View of Trout Brook near Quaker Lane in West Hartford. Photo taken in proximity to proposed crossing location.					

**PHOTOGRAPHIC LOG**

**Client Name:** Eversource

**Site Location:** GHCCRP

**Project No.** 60340574

**Photo No.**  
11      **Date:**  
6/23/2015

**Direction Photo Taken:**

West

**Description:**

View of Trout Brook from Quaker Lane Bridge in proximity of proposed crossing location. Photo taken in West Hartford, adjacent to Beachland Park.



**Photo No.**  
12      **Date:**  
6/23/2015

**Direction Photo Taken:**

East

**Description:**

View of Trout Brook and Wetland WH-1 along Alternate Route in West Hartford. Trout Brook Trails (Paved and Unpaved) are visible in this picture.



**PHOTOGRAPHIC LOG**

**Client Name:** Eversource

**Site Location:** GHCCRP

**Project No.** 60340574

**Photo No.**  
13

**Date:**  
6/23/2015

**Direction Photo Taken:**

Northwest

**Description:**

View of unnamed tributary to South Branch of Park River culverted crossing beneath New Park Avenue in Hartford.



**Photo No.**  
14

**Date:**  
6/23/2015

**Direction Photo Taken:**

Northwest

**Description:**

View of unnamed tributary to South Branch of Park River. Outfall located downstream of crossing beneath New Park Avenue





***Note: This page intentionally left blank.***

## **Exhibit 2.B Cultural**





## *INTEGRATED HISTORIC PRESERVATION PLANNING*

Mr. Justin Adams  
Senior Licensing and Permitting Specialist  
Eversource Energy  
107 Selden Street  
Berlin, CT 06037

**RE: Cultural Resources Review of the Project Region Associated with the Greater Hartford Connecticut Reliability Project, Hartford, Newington, and Berlin Connecticut**

Mr. Adams:

Heritage Consultants, LLC, is pleased to have this opportunity to provide Eversource Energy with the following cultural resources review of the proposed project referred to as the Greater Hartford Central Connecticut Reliability Project (GHCCRP) in Hartford, West Hartford, Newington, and Berlin Connecticut. To improve the reliability of the electric transmission system in the Greater Hartford, Connecticut area, Eversource Energy (Eversource) proposes to construct and operate a new underground transmission line and to modify three existing substations in central Connecticut. The new underground electric transmission cable system is planned to extend for approximately 3.6 miles between Eversource's existing Newington Substation in the Town of Newington to its Southwest Hartford Substation in the City of Hartford. To interconnect the new 115-kV cable to the transmission grid, Eversource proposes to expand and make related improvements to both substations. In addition, Eversource proposes to modify its existing Berlin Substation, located in the Town of Berlin. As shown in Figure 1; Sheets 1 through 3, the Hartford and Newington portions of the project will be confined mainly to existing streets wherein the proposed transmission line will be buried. The Berlin Substation portion of the project will be confined to the existing substation area.

The cultural resources review entailed the completion of an existing conditions cultural resources summary based on the examination of cultural resources data obtained from the Connecticut State Historic Preservation Office, as well as historic maps, aerial photographs, and topographic quadrangles maintained by Heritage Consultants, LLC. This study also included a pedestrian survey of the proposed project corridors and parcels during which photos of the areas were taken and an archaeological assessment of the project items was completed. This investigation did not consider the effects of the proposed construction upon built resources per se, and it is based upon project location information provided to Heritage Consultants, LLC by AECOM Environment. The objectives of this study were: 1) to gather and present data regarding previously identified cultural resources situated within the vicinity of the proposed project items; 2) to investigate the proposed project region in terms of its natural and historical characteristics; and 3) to evaluate the need for completing additional cultural resources investigations.

### **The Hartford and Newington Portions of the GHCCRP**

As seen in Figure 2; Sheets 1 through 3, which depict excerpts from an 1855 map of the proposed project region, the southwestern portion of Hartford and the northern portion of Newington contained a well-

established transportation network consisting a several mains roads, numerous secondary streets, and a rail line in the middle of the nineteenth century. Nevertheless, the areas of densest settlement were positioned to the north, west, and south of the project area. Further, while the main building types in the area at that time consisted of residences, there were a few commercial enterprises in the region, including a carriage shop, potters shops, and a woolen yarn factory. Thus, the area was of a mixed use during the mid-nineteenth century. Figure 3; Sheets 1 through 3, which consist of map excerpts dating from 1869, show that after the Civil War there was additional in-filling of the proposed project region. However, this area remained of a mixed use character and dense settlement was not found there. It is likely that some portions of the proposed project area were still being farmed at that time rather than being dominated by settlement.

A review of Figure 4; Sheets 1 through 3, reveal that by 1934, the project area in Hartford and Newington had undergone substantial changes. The large open spaces depicted in the 1855 and 1869 maps appear to have been much diminished. The region now contained many more streets and buildings, especially in the northern and southeastern areas. Much of the southwestern portion of the project region, as it passes through Newington, remained open land however, with much of it under cultivation in the early part of the twentieth century. Finally, one prominent landscape feature that appears in the 1934 aerial image shown in Figure 4; Sheets 1 and 2, is what appears to be a large oval track. This may be the former location of the Charter Oak Race Track, which featured harness racing events in the early twentieth century.

The next aerial image in the sequence dates from 1951, and it shows dramatic changes to the Hartford and Newington portions of the GHCCRP area (Figure 5; Sheets 1 through 3). The site of the former race track and the area to the north has been developed to a massive degree, with hundreds of homes erected and a large industrial facility on the former race track location. This large facility is the site of the Colt Firearms factory, which remains in operation to this day. The southern portion of the GHCCRP still retained open land; however, several housing subdivisions were beginning to creep into the region as a result of the suburbanization process that took place after the close of World War II. At this time, only the southwestern portion of the project region retained any appreciable open space, much of which remained under cultivation.

As seen in Figure 6; Sheets 1 through 3, almost the entirety of the Hartford and Newington portions of the GHCCRP project region had been impacted by large scale development by 1990, including the construction of several more large housing subdivisions, additional industrial facilities, and a multitude of small commercial enterprises. The other large addition to the area was the construction of Interstate 84, which extends from east to west. The construction of Interstate 84, which occurred in the 1950s, resulted in the demolition of dozens of former residences and commercial buildings. By this time, the only areas that had not suffered large scale impacts were the southwestern most and southern most areas, both of which consist of open land traversed by an existing power line corridor. Impacts to these areas appear to have been limited to the immediate areas around where utility poles were installed.

Finally, Figure 7; Sheets 1 through 3, which contain excerpts from a 2014 aerial image, shows the GHCCRP project region in its modern state. Today this area is home to a large populace and numerous commercial and industrial enterprises. Again, the only portions of the project region that appear to be only minimally disturbed are the southwestern and southern areas where the existing power line corridor traverses the region.

In addition to the examination of historic maps and aerial images of the GHCCRP region, Heritage Consultants, LLC completed a review of previously recorded cultural resources on file with the

Connecticut State Historic Preservation Office. This review revealed that no previously identified archaeological sites are known in the project region (Figure 8; Sheets 1 through 3); however, this may be the result of under-sampling since no professional cultural resources surveys have been completed in the area. The review of previously identified cultural resources did result in the identification of four structures individually listed on the National Register of Historic Places and two National Register historic districts. The individually listed buildings consist of the Sarah Whitman Hooker House, which was built c. 1720 and is notable as the site where of Andrew Skene, a Loyalist, who was taken prisoner early in the American Revolutionary War (Figure 9; Sheet 3 and Photo 43); the Charles E. Beach House, a prominent shingle style house built in 1900 (Figure 9; Sheet 3 and Photo 44); the Royal Typewriter Company Building, a large Victorian type factory building erected in 1907 (Figure 9; Sheet 1); and a two-and-a-half story Greek Revival house located at 1168 New Britain Avenue (Figure 9; Sheet 3 and Photo 38).

The two historic districts noted in the vicinity of the proposed project corridors include the Parkville Historic District in the north and the Newington Junction North Historic District in the south (Figure 9; Sheet 1 and 3). The Parkville Historic District is a collection of mid-to-late-nineteenth and twentieth-century resources composed of 340 primary buildings, of which 294 are contributing elements to its National Register of Historic Places significance. The district is architecturally significant as a working-class neighborhood that developed during the mid-to-late nineteenth and early twentieth centuries. Its period of significance spans from 1860 to the modern era, and its building resources represents the variety of the architectural styles and developmental trends that typify the era (Photos 3 and 5). The Newington Junction North Historic District is situated along Willard Avenue and to the north of its intersection with West Hill Road. This historic district is comprised of 13 contributing and three non-contributing properties that are situated throughout an area of more than 10 acres of land. The residences in the district consist of examples of Colonial Revival, Late Victorian, and Queen Anne styles, all of which typify the architecture dating from 1850-1949 (Figure 9; Sheet 3 and Photos 55 and 56). While the purpose of this investigation was primarily to assess the archaeological potential of the proposed project items, historic built resources were mapped and streetscape photos of the areas where taken. Through this process, it was determined that any potential affects to the above-referenced historic districts and/or individually listed National Register of Historic Places properties would be temporary in nature and would only occur during construction of the underground portion of the proposed power transmission line. These potential impacts would be removed once the construction was completed and the areas were repaved.

In addition to researching historic mapping, aerial imagery, and previously identified cultural resources, representatives from Heritage Consultants, LLC also completed a pedestrian survey and photo-documentation of the proposed project corridors associated with the GHCCRP as it extends through Hartford and Newington. The results of this effort are captured in Photos 1 through 56 below (Figure 10 Sheets 1 through 3). The visual reconnaissance and the photographic effort revealed that the vast majority of the proposed project corridors consist of paved streets. These areas already contain a wide variety of buried utilities, including sewer lines, water lines, natural gas lines, and electrical utilities associated with traffic signals. As a result, these areas have been heavily disturbed, which has led to the classification of the soils in these areas as “urban land” or Udorthents (see Figure 11 Sheets 1 through 3). These soils type have undergone massive disturbance through cutting, grading, and filling episodes associated with previous construction projects. Both urban land and Udorthent soils types retain little, if any, potential to yield intact cultural deposits. Consequently, the paved portions of the GHCCRP have been assessed as no/low sensitivity areas, and no archaeological testing of these areas is recommended prior to construction of the GHCCRP.

There are several areas level, dry areas with good drainage characteristics along the existing power line corridor that appear to have been only impacted in a localized way (Figure 12). If a route is eventually selected where the proposed transmission line (above ground or underground) will follow the existing power line corridor in the southwestern and southern portion of the proposed GHCRP region, Heritage Consultants, LLC recommends that these areas be subjected to Phase IB subsurface testing prior to construction of the GHCCRP. It is further recommended that the existing power line corridor be cleared of vegetation to facilitate the archaeological survey effort should this route variation be chosen.

### **The Berlin Substation**

As mentioned in the opening paragraph of this document, the GHCCRP also will entail the reorganization of the Berlin Substation situated along the eastern edge of Beckley Road in Berlin, Connecticut. As Figure 13 shows, the existing substation is located to the northeast of the Berlin Fairgrounds and it occupies a fairly level parcel of land. Figure 14, an excerpt from an 1855 map of the region containing the substation, shows that this portion of Berlin was rural in nature. The main areas of settlement were situated to the north, west, and south of the proposed project parcel. The 1869 map shown in Figure 15 shows that not much had changed in the vicinity of the Berlin Substation toward the end of the nineteenth century. The area remained rural and was accessible only by Beckley Road. It is likely that the substation area was used for agricultural production during the nineteenth century. This interpretation is confirmed by Figure 16, an aerial image dating from 1934. It is clear in Figure 16 that the substation area was at that time a large open field that appears as part of a local farm.

The aerial image shown in Figure 17, which dates from 1951, also confirms the presence of a farm and agricultural fields in the region encompassing the current location of the Berlin Substation. This area contained two or three buildings and cleared areas used for agricultural production. The next aerial image in the sequence, which is depicted in Figure 18 and dates from 1990, shows that by the closing decades of the twentieth century, the previously existing farm had been demolished and replaced with the current substation area. In addition this image shows power lines that run from east to west and north to south into and out of the Berlin Substation. Finally, Figure 19, an aerial image dating from 2014, shows the substation area in its modern state. It is clear that a large parcel of land has been cleared and graded for the construction of this electrical facility.

In addition to the examination of historic maps and aerial images of the Berlin Substation, Heritage Consultants, LLC completed a review of previously recorded cultural resources on file with the Connecticut State Historic Preservation Office. This review revealed that while no previously identified archaeological sites are known in the vicinity of the Berlin Substation parcel (Figure 20), a single National Register of Historic Places property has been recorded to the south of the substation parcel (Figure 21) Listed on the National Register of Historic Places in 1977, this property is known as the Ezekial Kelsey House (Photo 60). The Ezekial Kelsey House dates from the middle of the 18th century and is of the "saltbox" form. It is two-and-a-half stories high and it is one room deep with a lean-to that extends across the rear of the building. The home was constructed ca. 1760 by Mr. Kelsey and it is a significant architectural resource, as it is an excellent example of the saltbox form. Since the Berlin Substation is already in place, any reorganization of its internal structure will not constitute an impact to the Ezekial Kelsey House.

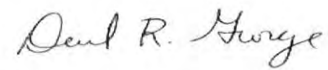
In addition to researching historic mapping, aerial imagery, and previously identified cultural resources, representatives from Heritage Consultants, LLC also completed a pedestrian survey and photo-documentation of the area containing the Berlin Substation (see Figure 22 and Photos 56 through 59). Visual reconnaissance of this area resulted in the determination that proposed project parcel has been

Mr. Adams  
May 19, 2015  
Page 5

massively disturbed by heavy equipment in the past. This was confirmed by an investigation of the soil types comprising the substation property. As seen in Figure 23, the soil type encompassing the substation area is described as urban land. This soil type is described as having been heavily modified through cutting, filling, and grading. Thus, this parcel of land was assessed as having little, if any, potential to yield intact cultural deposits. As a result, no additional archaeological testing of the Berlin Substation is recommended prior to construction.

If you have any questions regarding this Technical Memorandum, or if we may be of additional assistance with this or any other projects you may have, please do not hesitate to call us at 860-667-3001 or email me [dgeorge@heritage-consultants.com](mailto:dgeorge@heritage-consultants.com). We are at your service.

Sincerely,

A handwritten signature in cursive script that reads "David R. George".

David R. George, M.A., R.P.A.  
Heritage Consultants, LLC



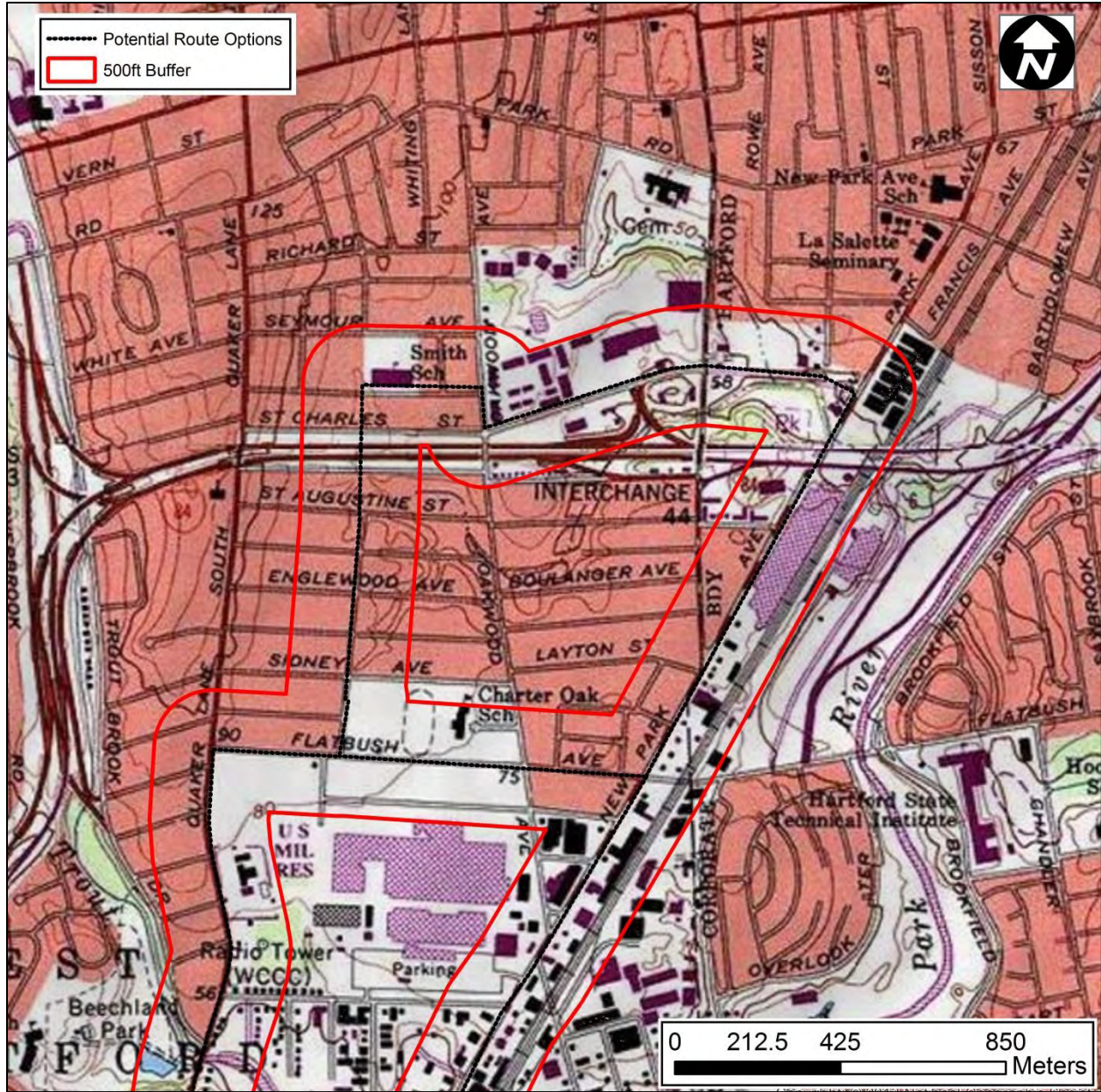


Figure 1, Sheet 1.

Excerpt from a USGS 7.5' series topographic quadrangle image showing the route of the Greater Hartford Reliability Project Corridor in Newington and Hartford, Connecticut.

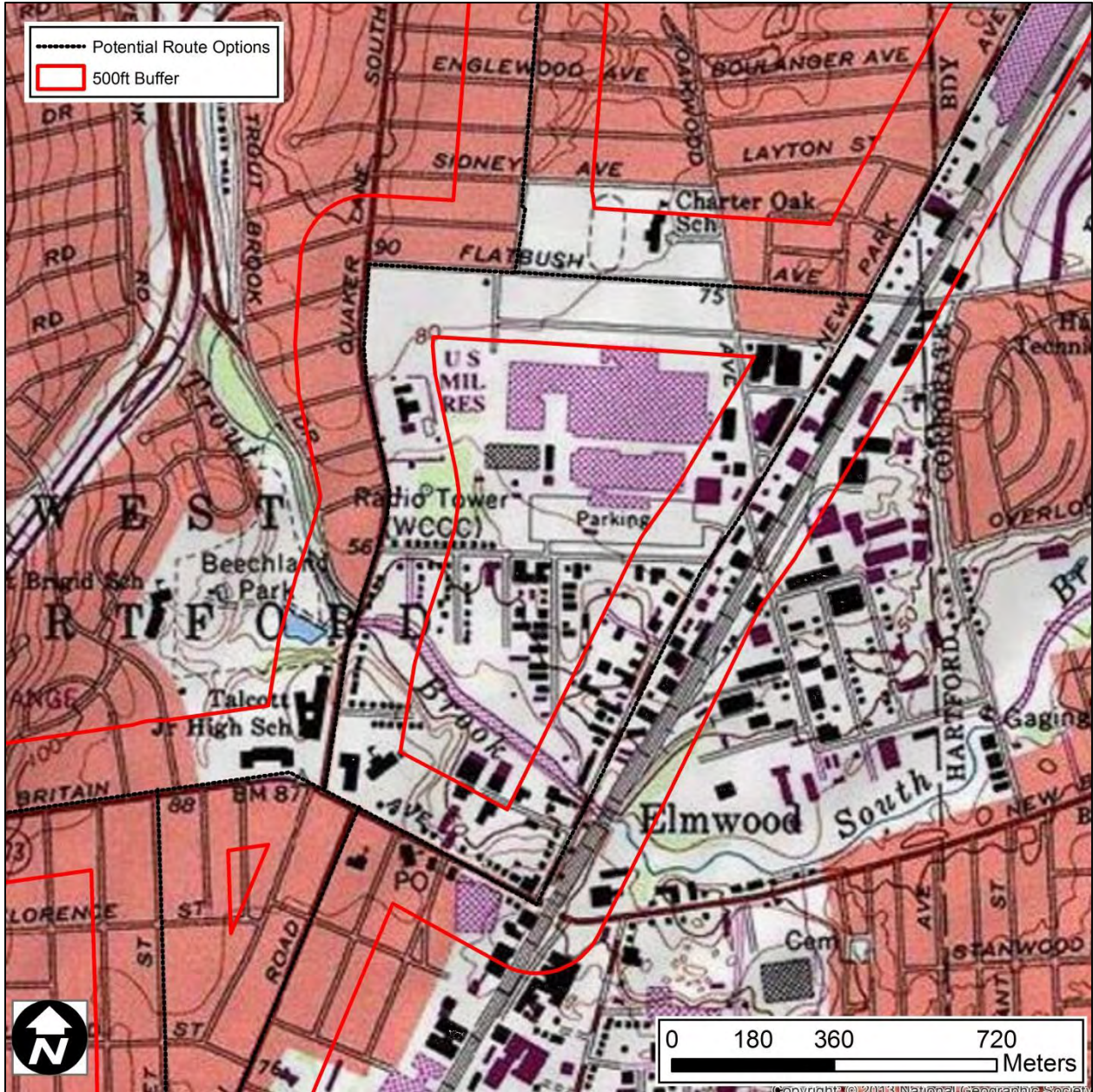


Figure 1, Sheet 2.

Excerpt from a USGS 7.5' series topographic quadrangle image showing the route of the Greater Hartford Reliability Project Corridor in Newington and Hartford, Connecticut.

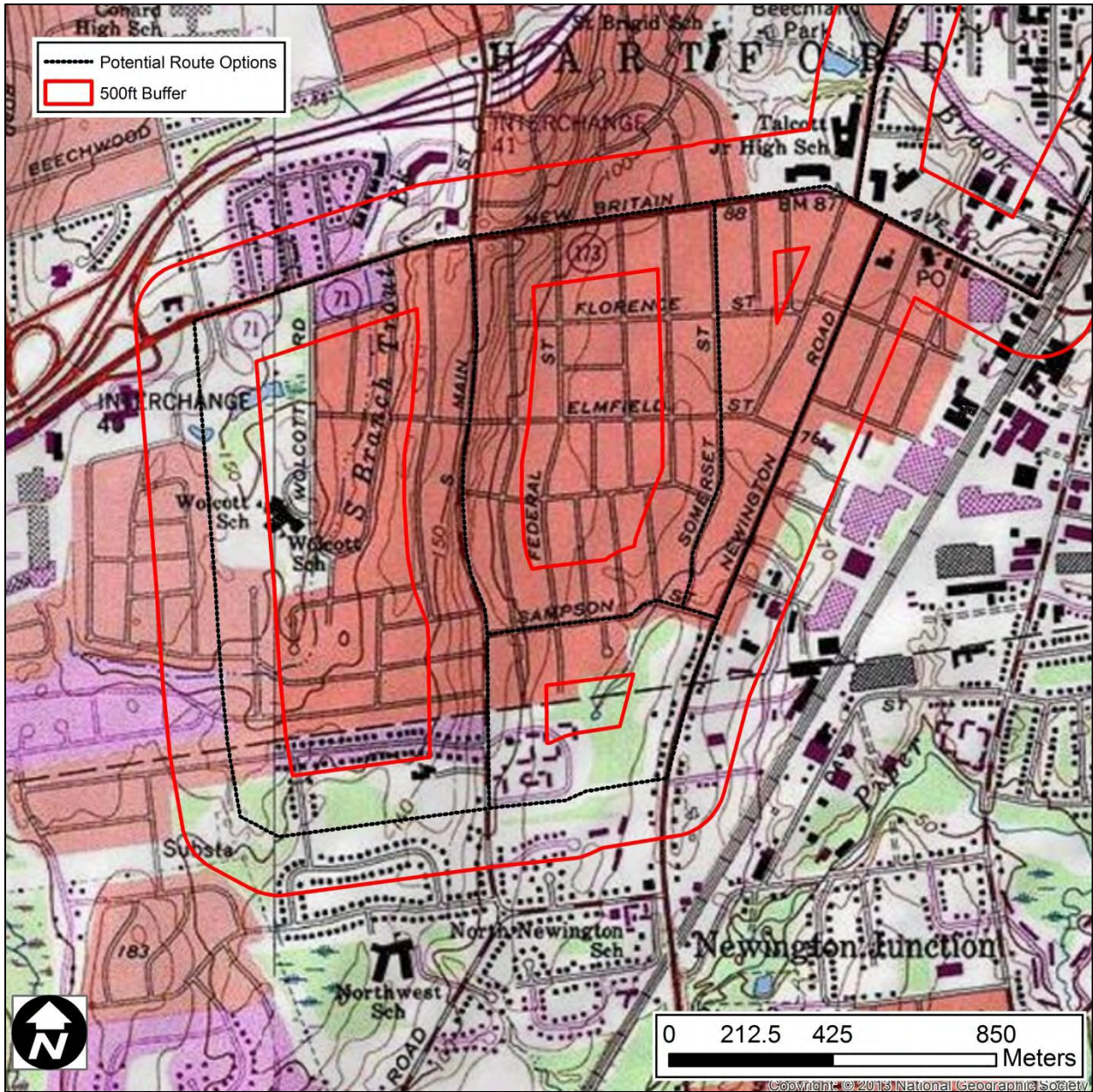


Figure 1, Sheet 3. Excerpt from a USGS 7.5' series topographic quadrangle image showing the route of the Greater Hartford Reliability Project Corridor in Newington and Hartford, Connecticut.

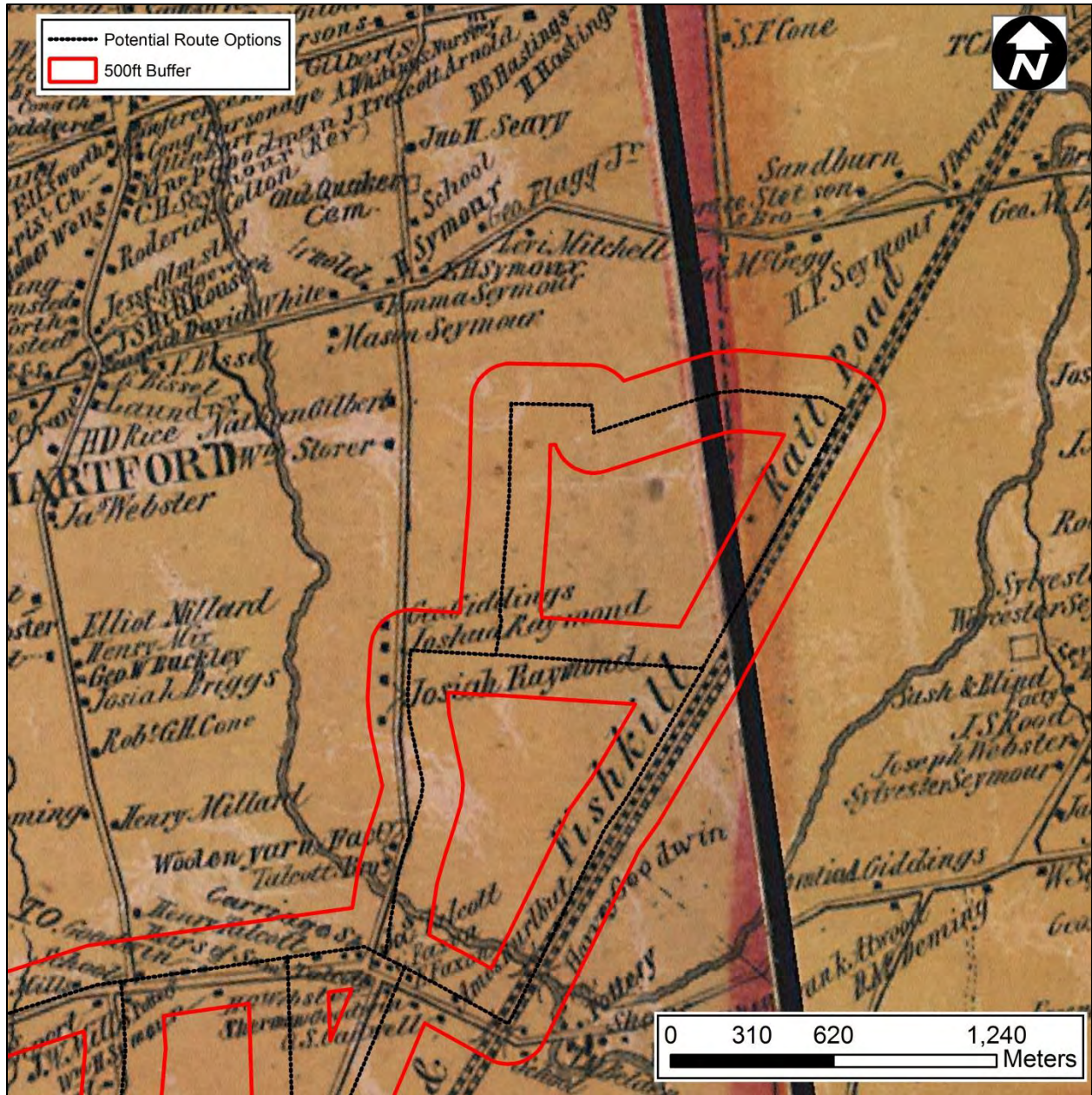


Figure 2, Sheet 1.

Excerpt from an 1855 historic map showing the route of the Greater Hartford Reliability Project Corridor in Newington and Hartford, Connecticut.

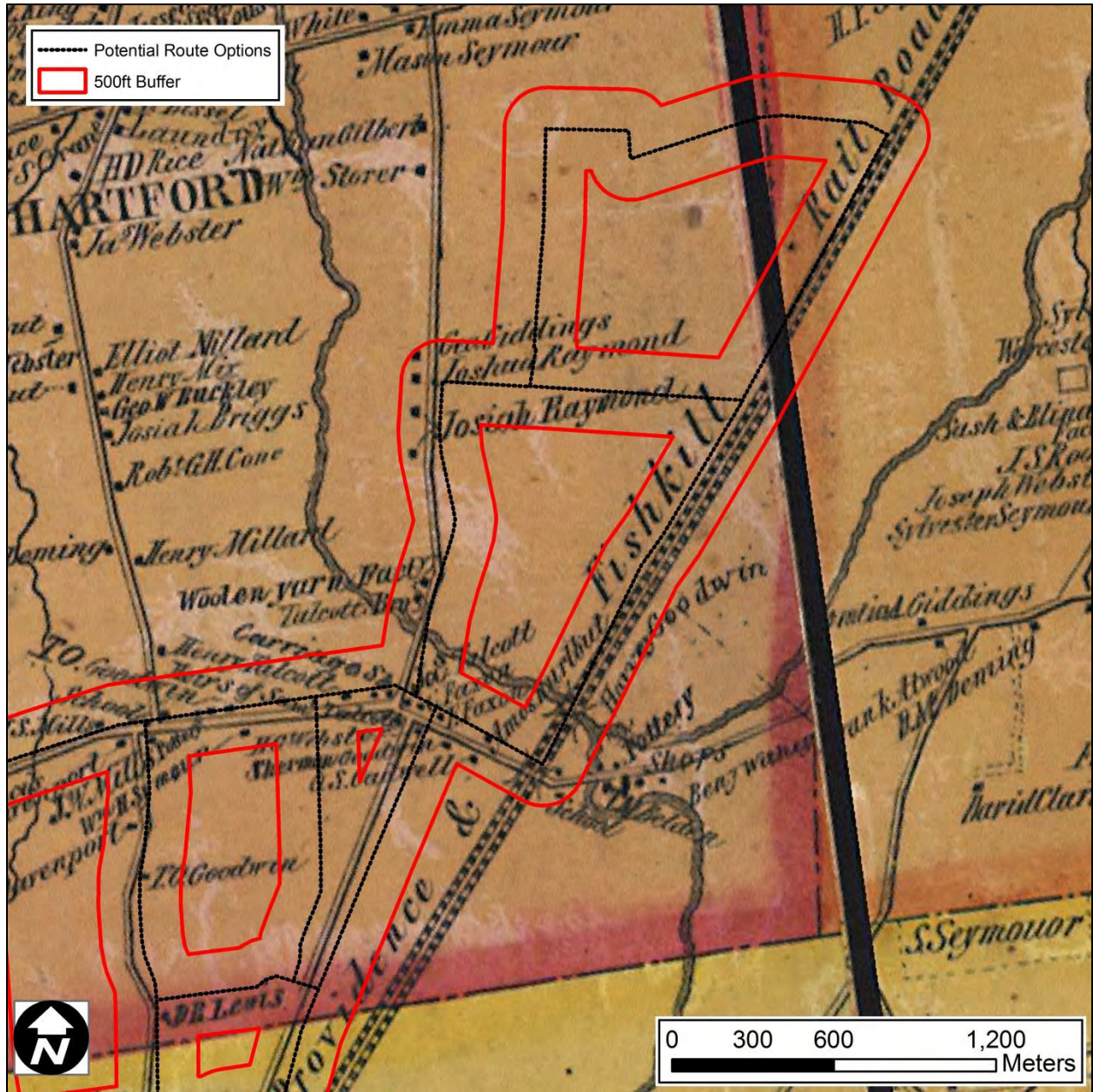


Figure 2, Sheet 2.

Excerpt from an 1855 historic map showing the route of the Greater Hartford Reliability Project Corridor in Newington and Hartford, Connecticut.

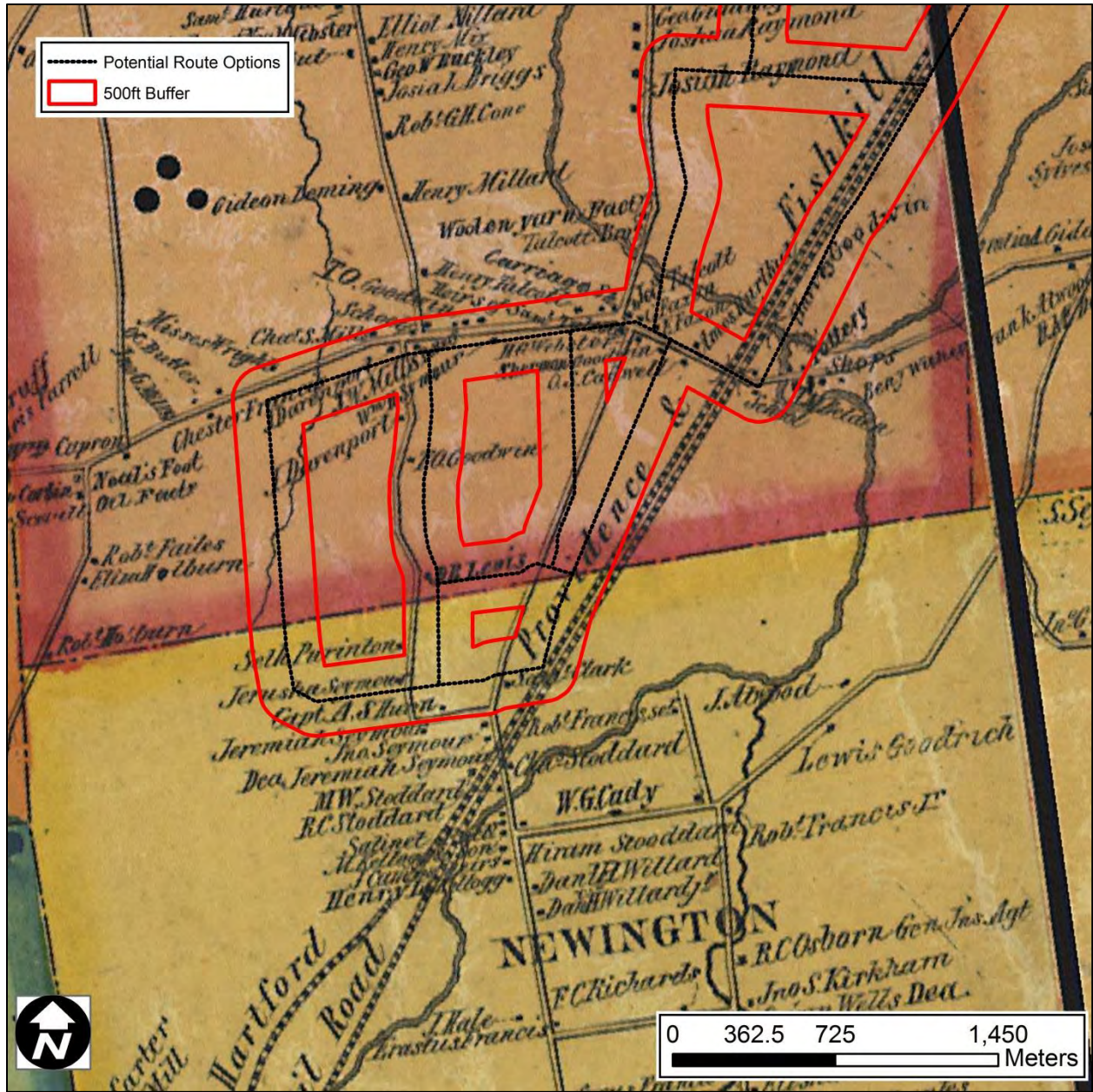


Figure 2, Sheet 3. Excerpt from an 1855 historic map showing the route of the Greater Hartford Reliability Project Corridor in Newington and Hartford, Connecticut.

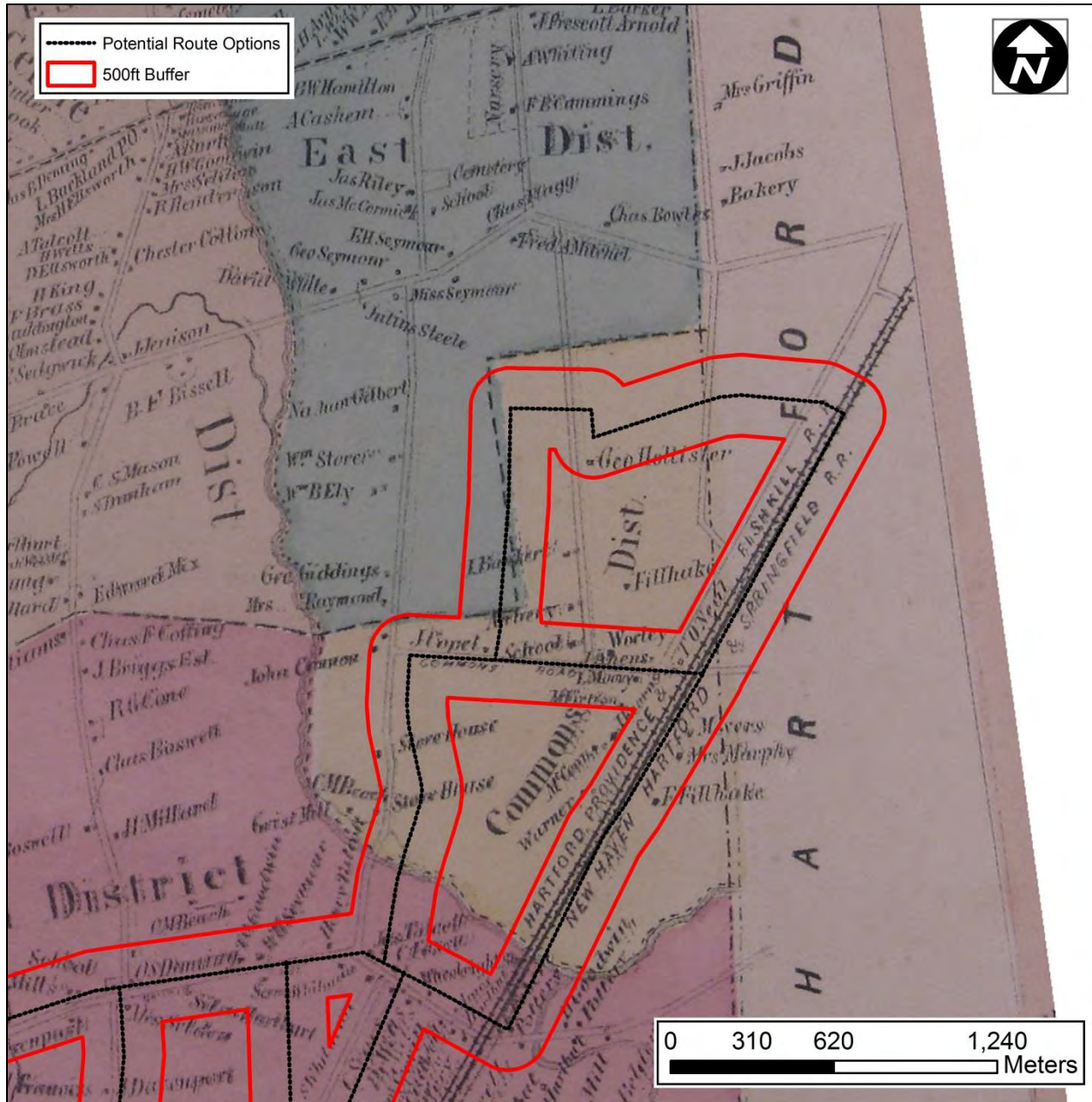


Figure 3, Sheet 1. Excerpt from an 1869 historic map showing the route of the Greater Hartford Reliability Project Corridor in Newington and Hartford, Connecticut.

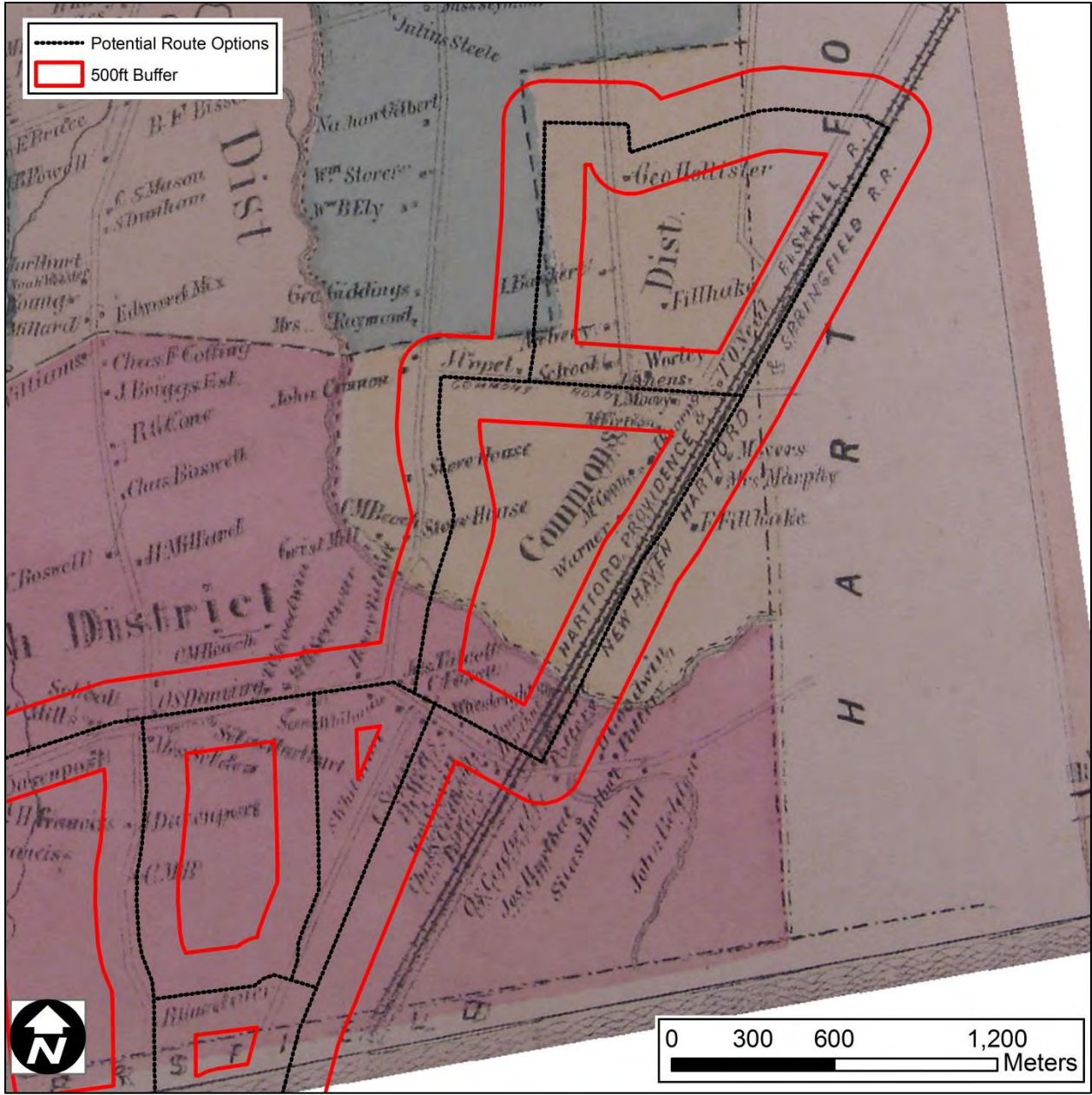


Figure 3, Sheet 2.

Excerpt from an 1869 historic map showing the route of the Greater Hartford Reliability Project Corridor in Newington and Hartford, Connecticut.







Figure 4, Sheet 1. Excerpt from a 1934 aerial image showing the route of the Greater Hartford Reliability Project Corridor in Newington and Hartford, Connecticut.

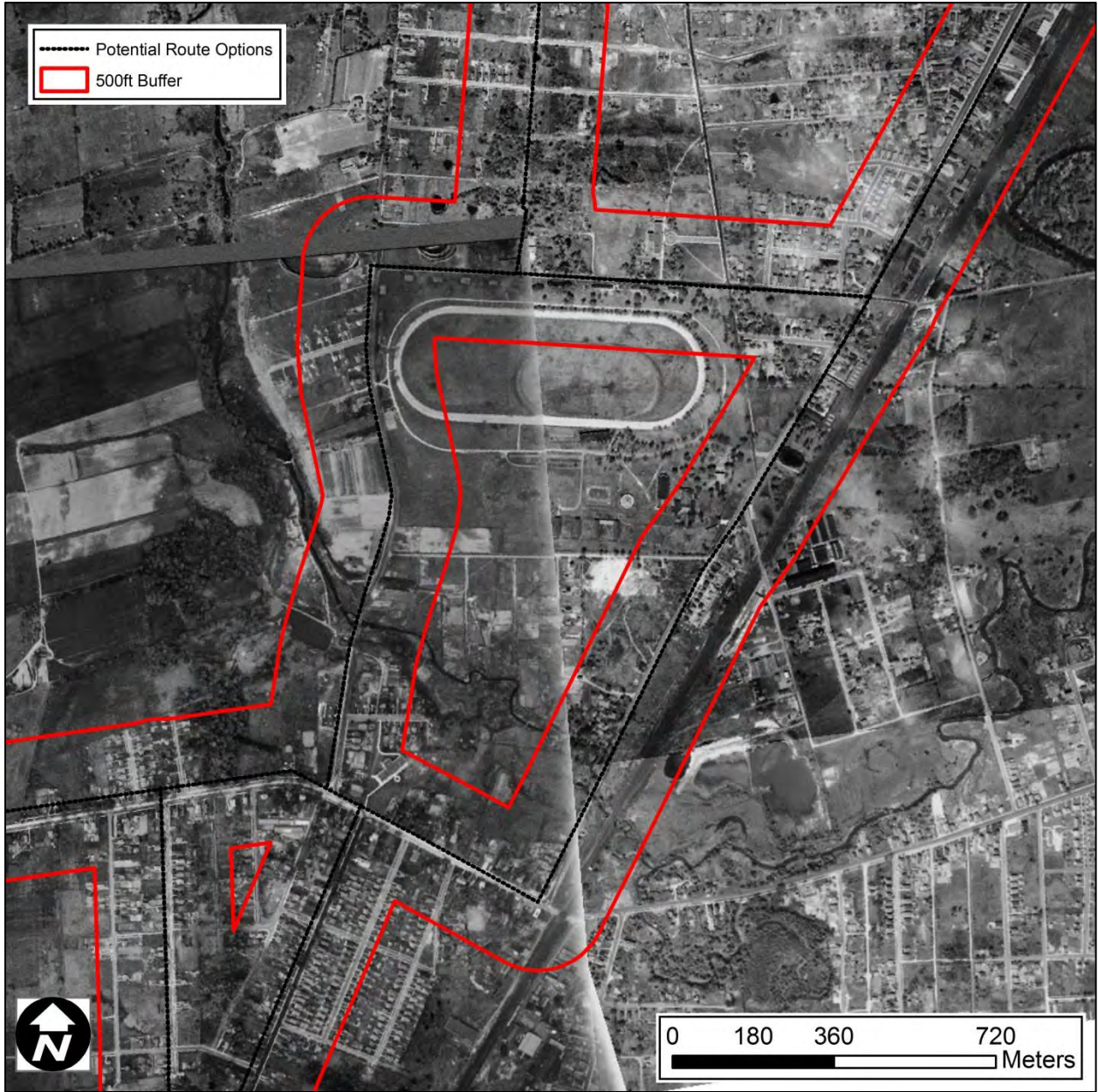


Figure 4, Sheet 2. Excerpt from a 1934 aerial image showing the route of the Greater Hartford Reliability Project Corridor in Newington and Hartford, Connecticut.

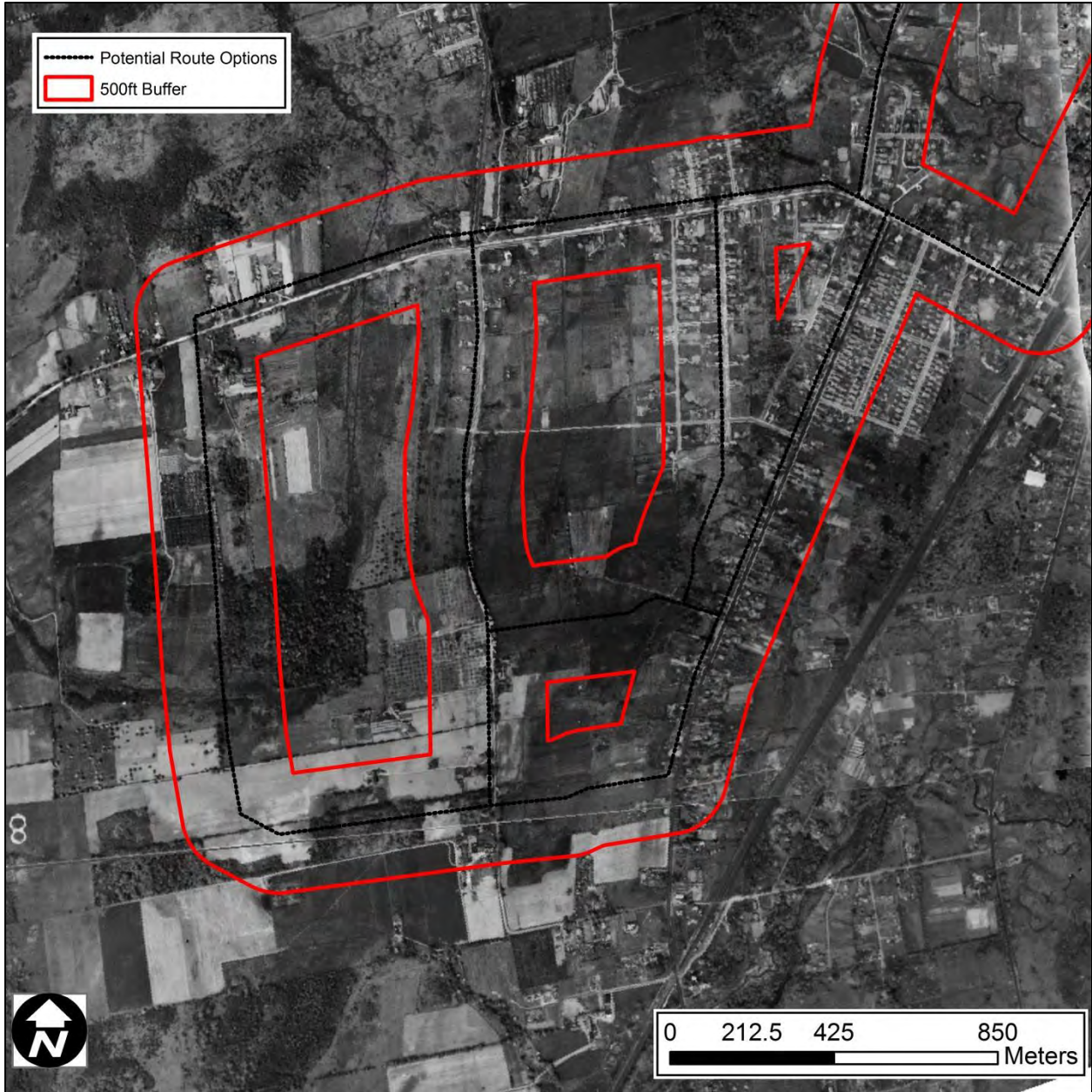


Figure 4, Sheet 3. Excerpt from a 1934 aerial image showing the route of the Greater Hartford Reliability Project Corridor in Newington and Hartford, Connecticut.



Figure 5, Sheet 1. Excerpt from a 1951 aerial image showing the route of the Greater Hartford Reliability Project Corridor in Newington and Hartford, Connecticut.



Figure 5, Sheet 2.

Excerpt from a 1951 aerial image showing the route of the Greater Hartford Reliability Project Corridor in Newington and Hartford, Connecticut.

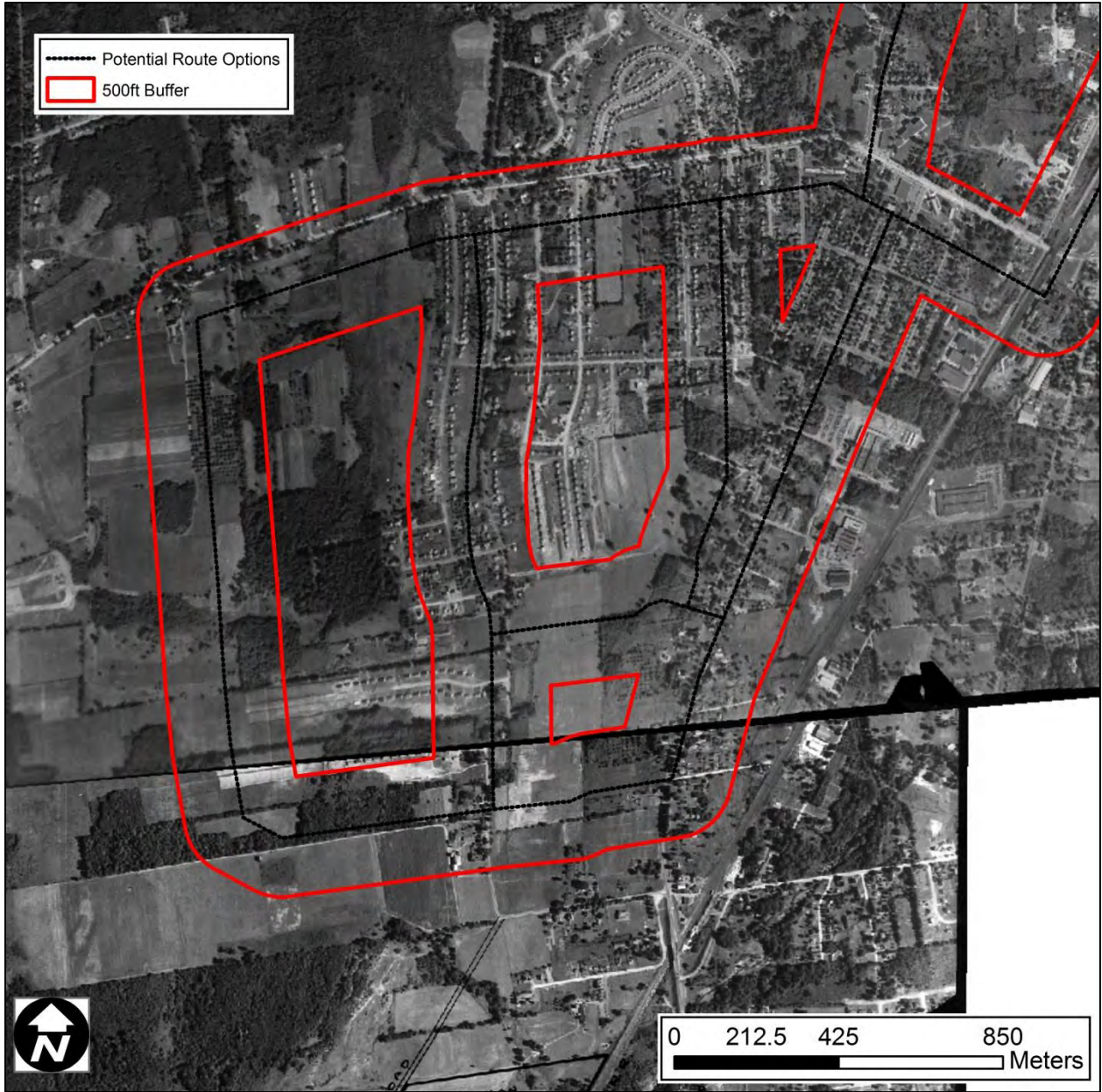


Figure 5, Sheet 3. Excerpt from a 1951 aerial image showing the route of the Greater Hartford Reliability Project Corridor in Newington and Hartford, Connecticut.

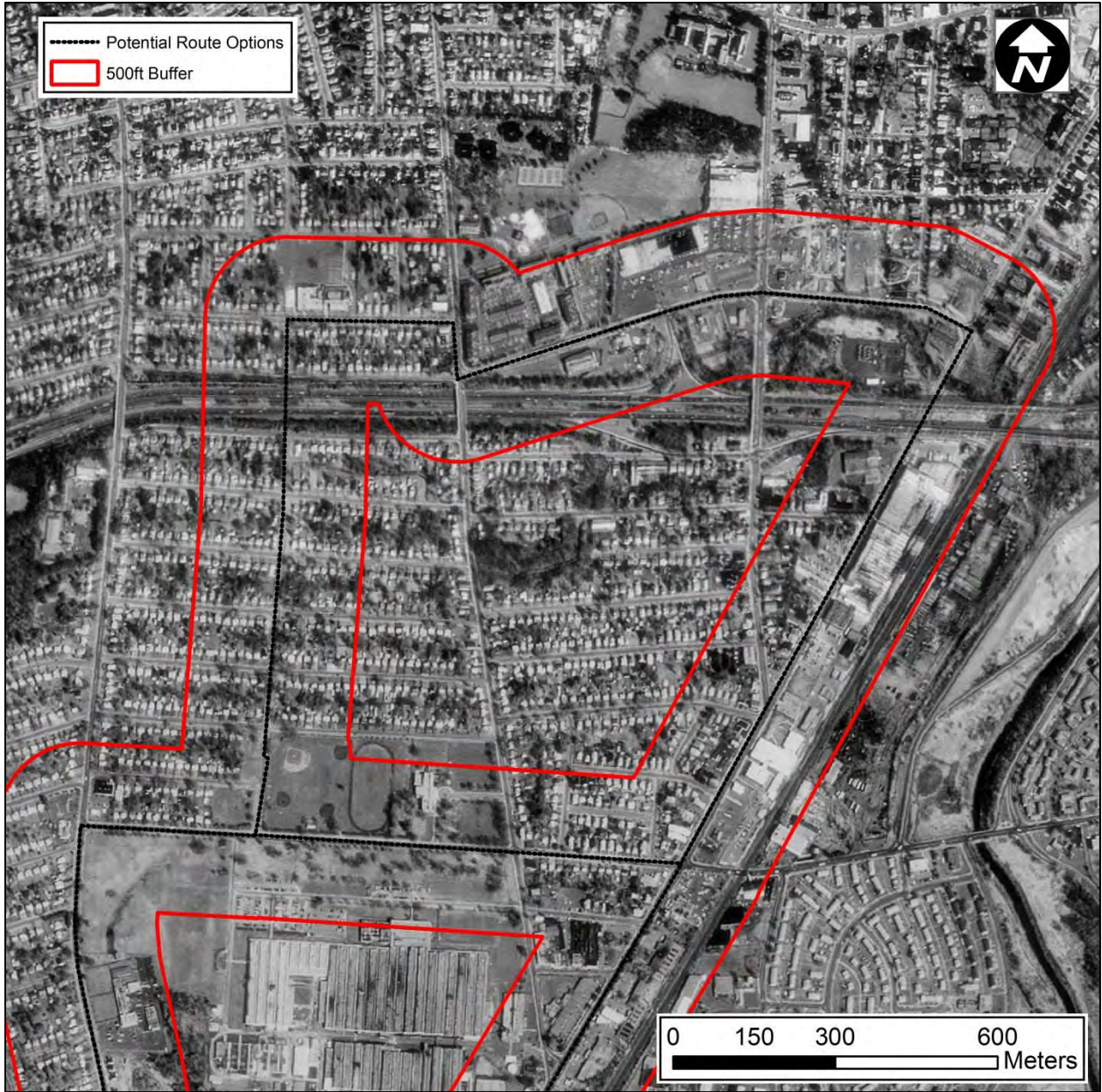


Figure 6, Sheet 1.

Excerpt from a 1990 aerial image showing the route of the Greater Hartford Reliability Project Corridor in Newington and Hartford, Connecticut.





Figure 6, Sheet 2. Excerpt from a 1990 aerial image showing the route of the Greater Hartford Reliability Project Corridor in Newington and Hartford, Connecticut.

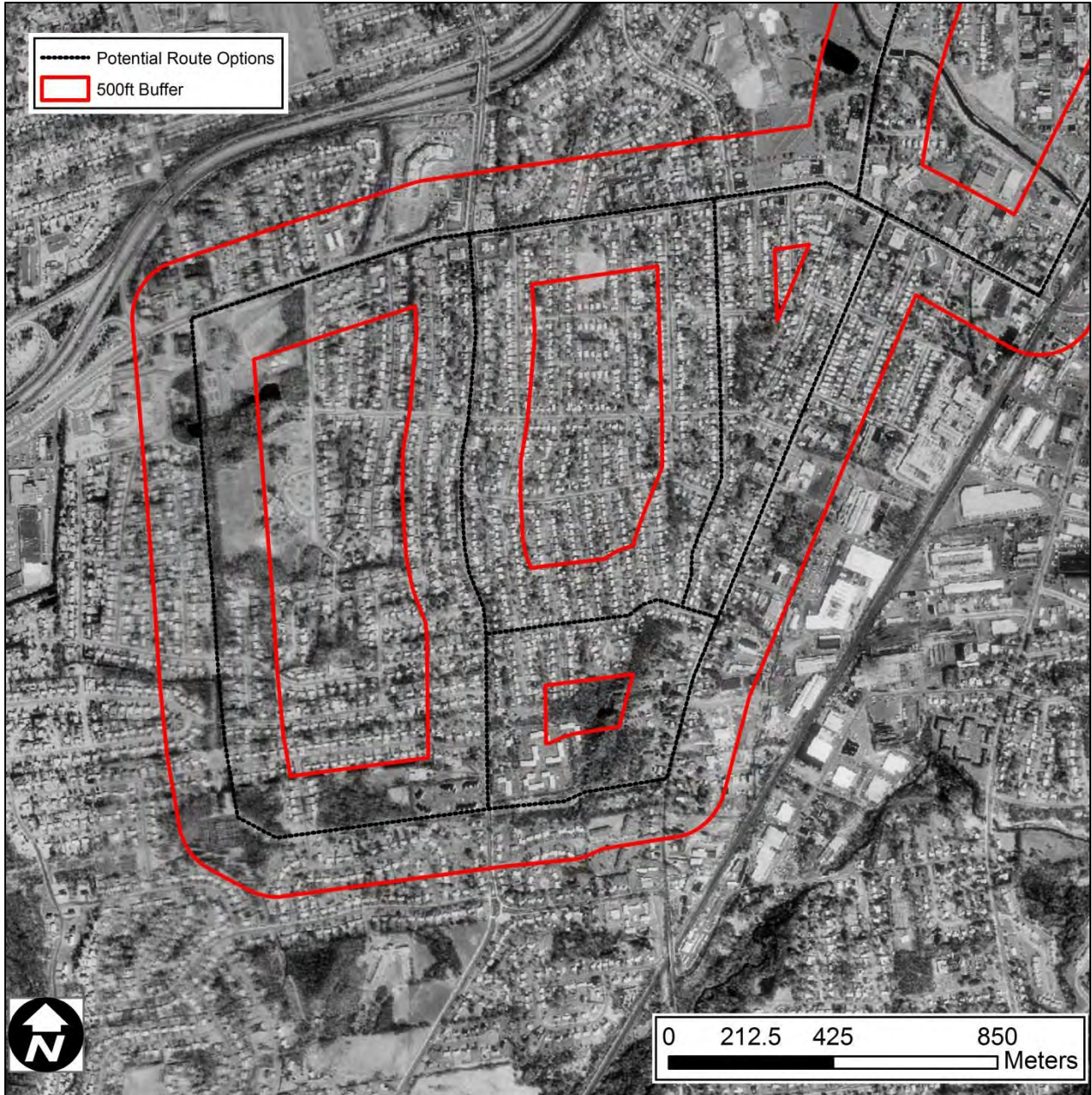


Figure 6, Sheet 3. Excerpt from a 1990 aerial image showing the route of the Greater Hartford Reliability Project Corridor in Newington and Hartford, Connecticut.

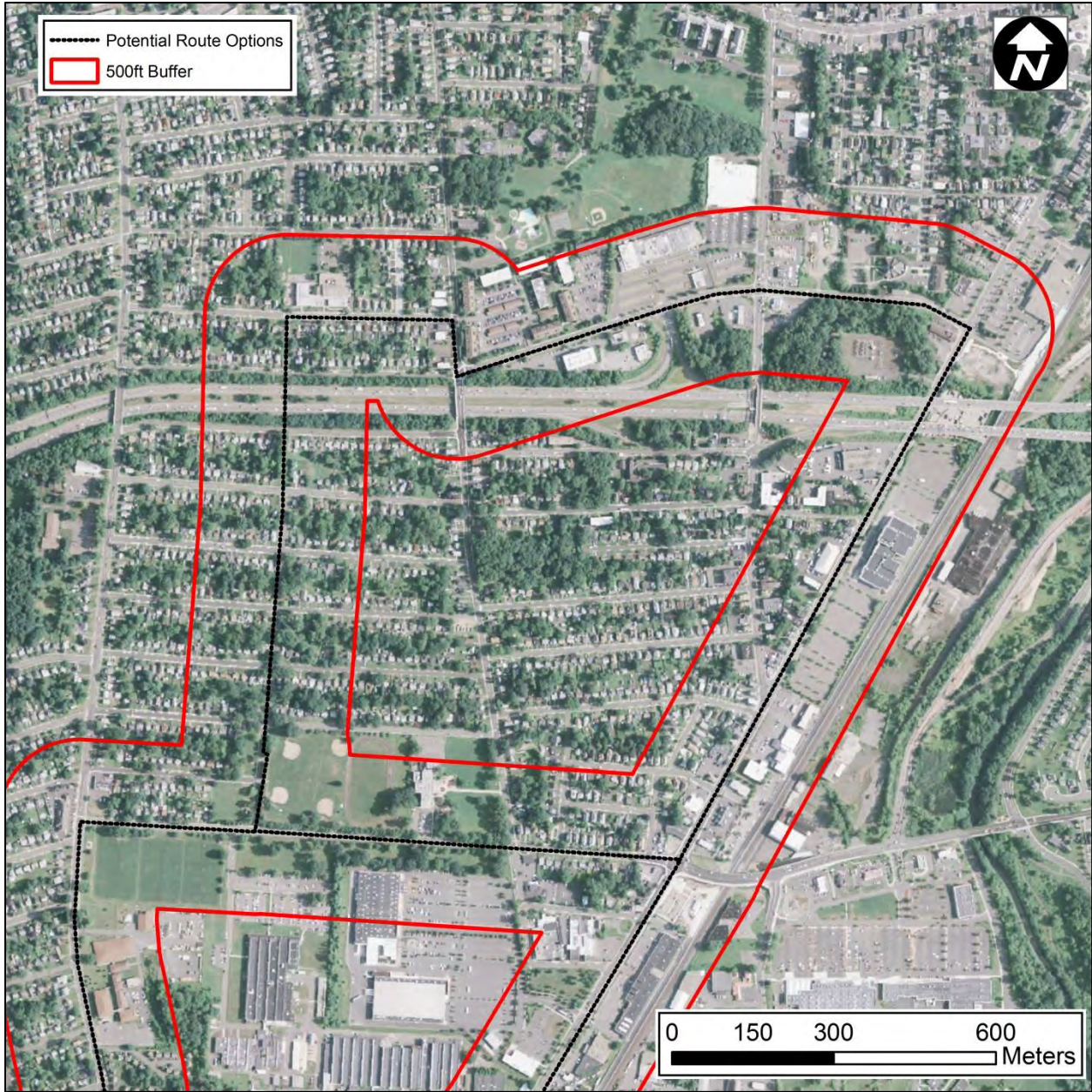


Figure 7, Sheet 1. Excerpt from a 2014 aerial image showing the route of the Greater Hartford Reliability Project Corridor in Newington and Hartford, Connecticut.

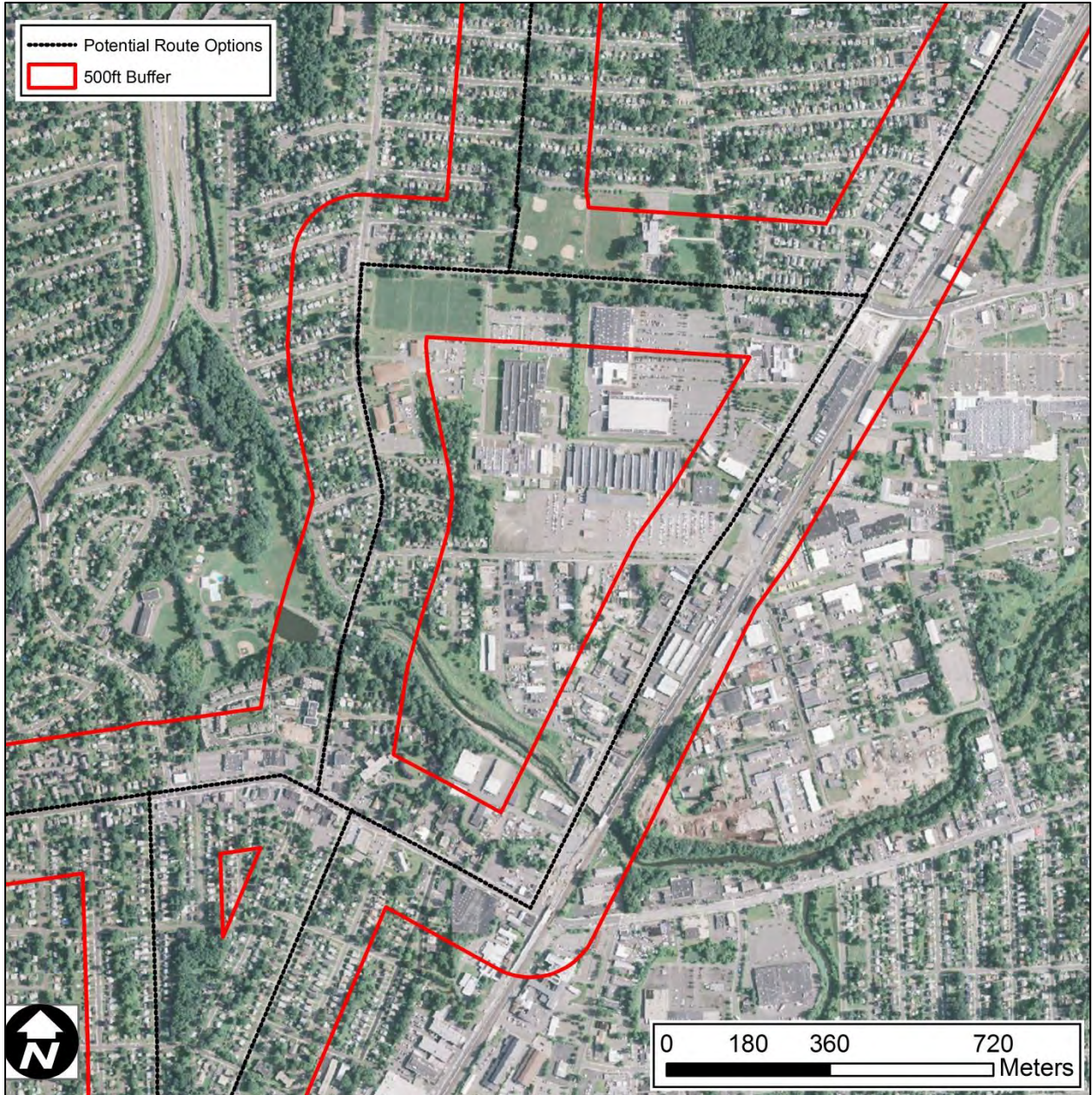


Figure 7, Sheet 2.

Excerpt from a 2014 aerial image showing the route of the Greater Hartford Reliability Project Corridor in Newington and Hartford, Connecticut.

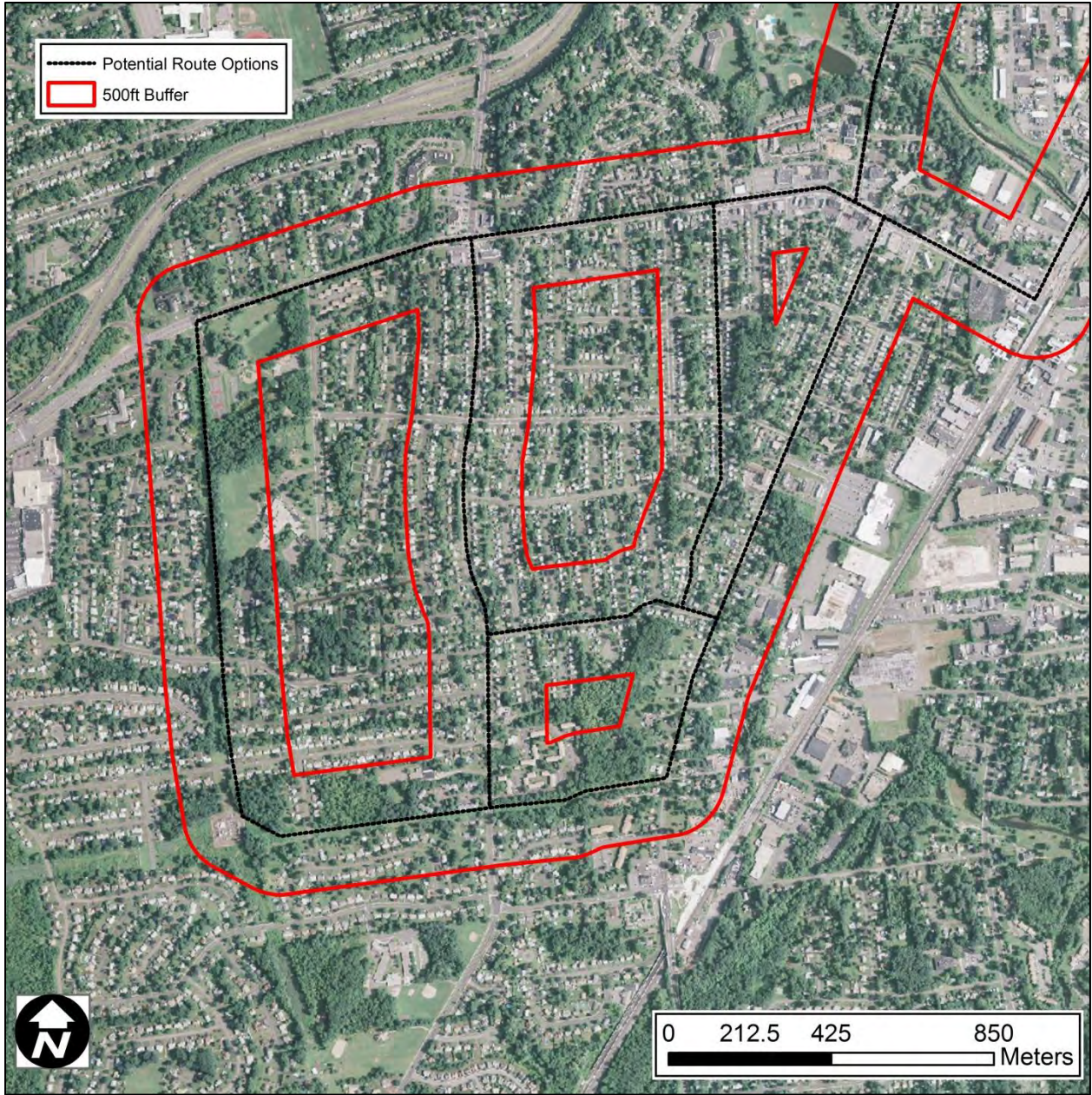


Figure 7, Sheet 3. Excerpt from a 2014 aerial image showing the route of the Greater Hartford Reliability Project Corridor in Newington and Hartford, Connecticut.

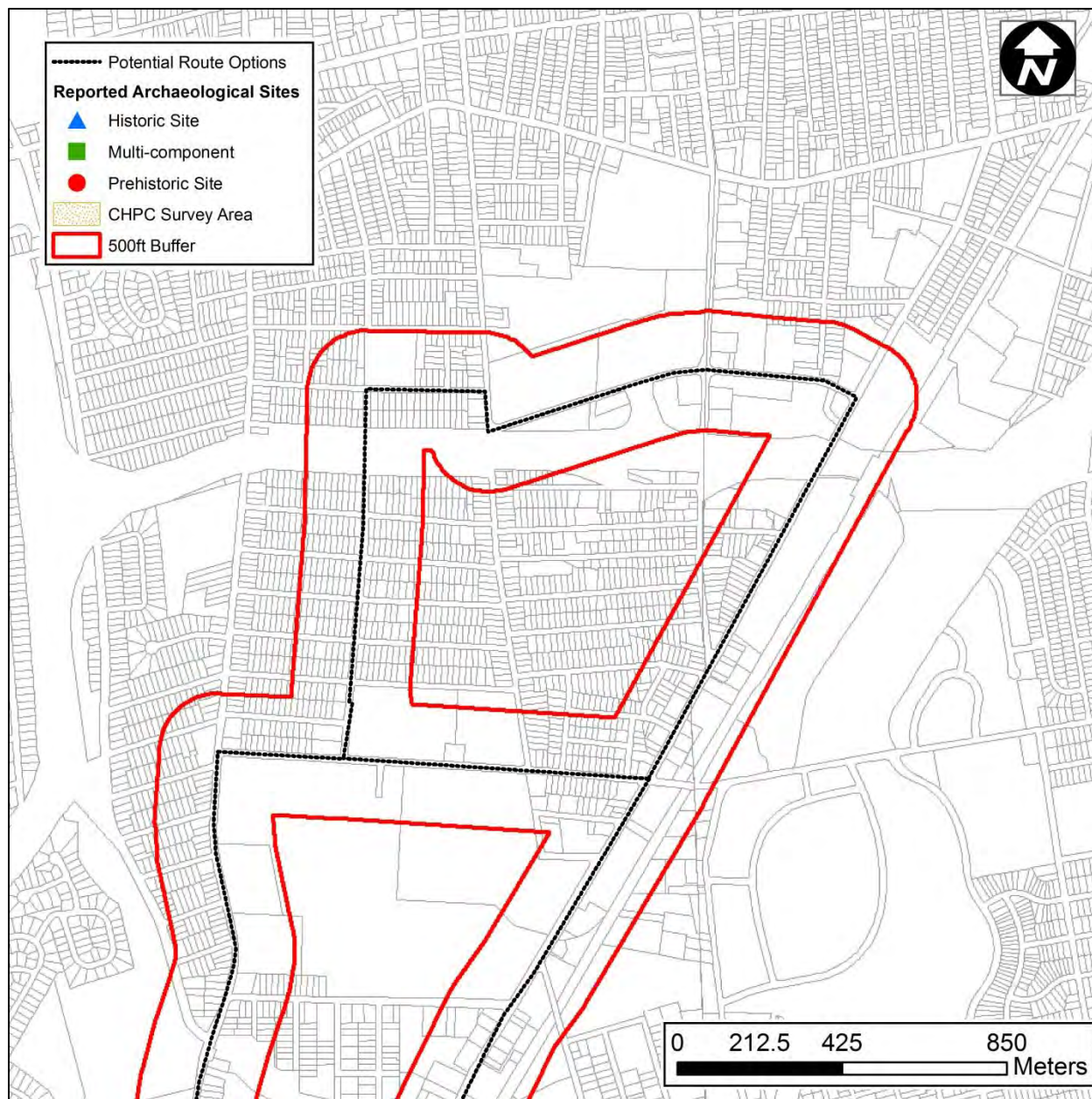


Figure 8, Sheet 1. Digital map depicting the locations of previously identified archaeological sites in the vicinity of the Greater Hartford Reliability Project Corridor in Newington and Hartford, Connecticut.

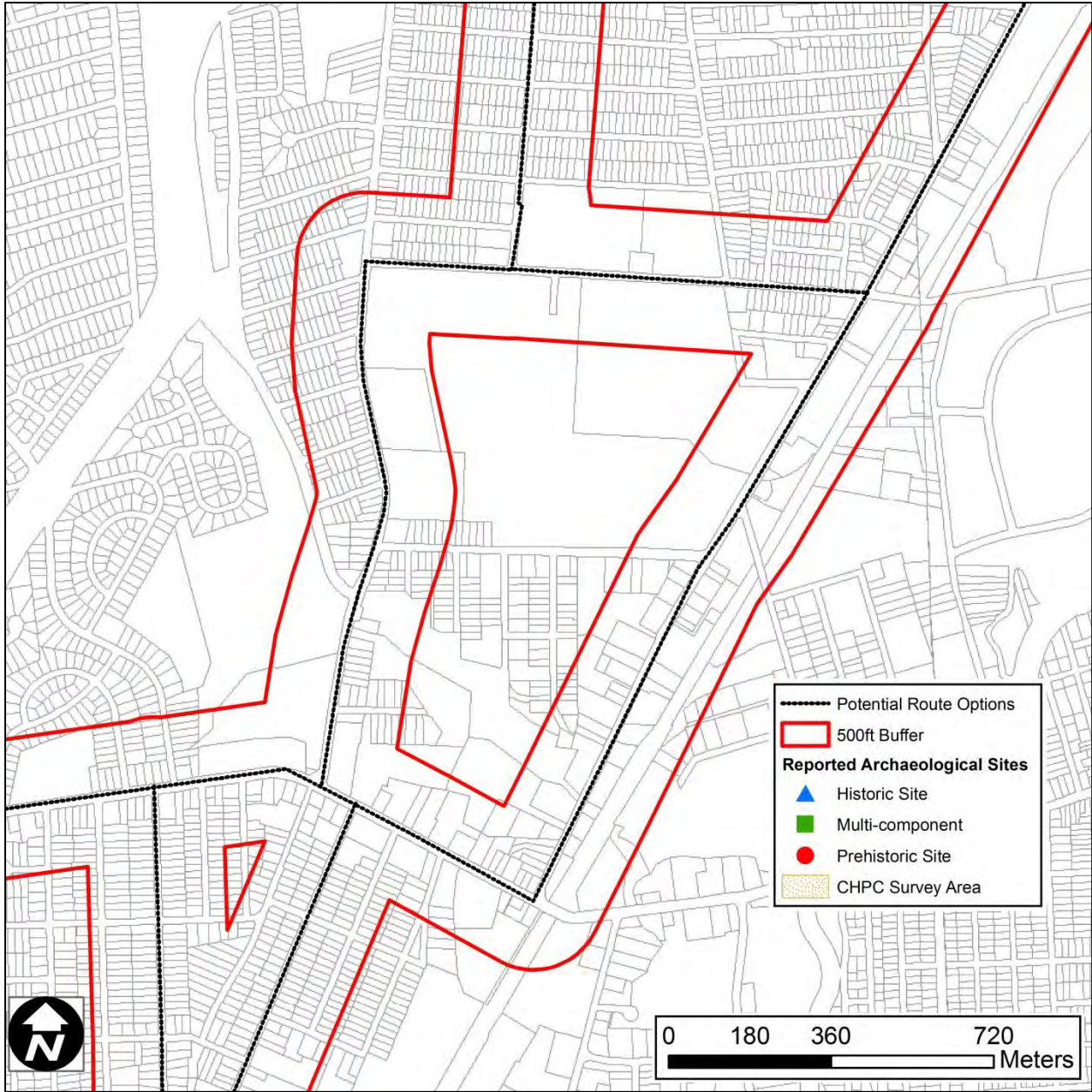


Figure 8, Sheet 2.

Digital map depicting the locations of previously identified archaeological sites in the vicinity of the Greater Hartford Reliability Project Corridor in Newington and Hartford, Connecticut.

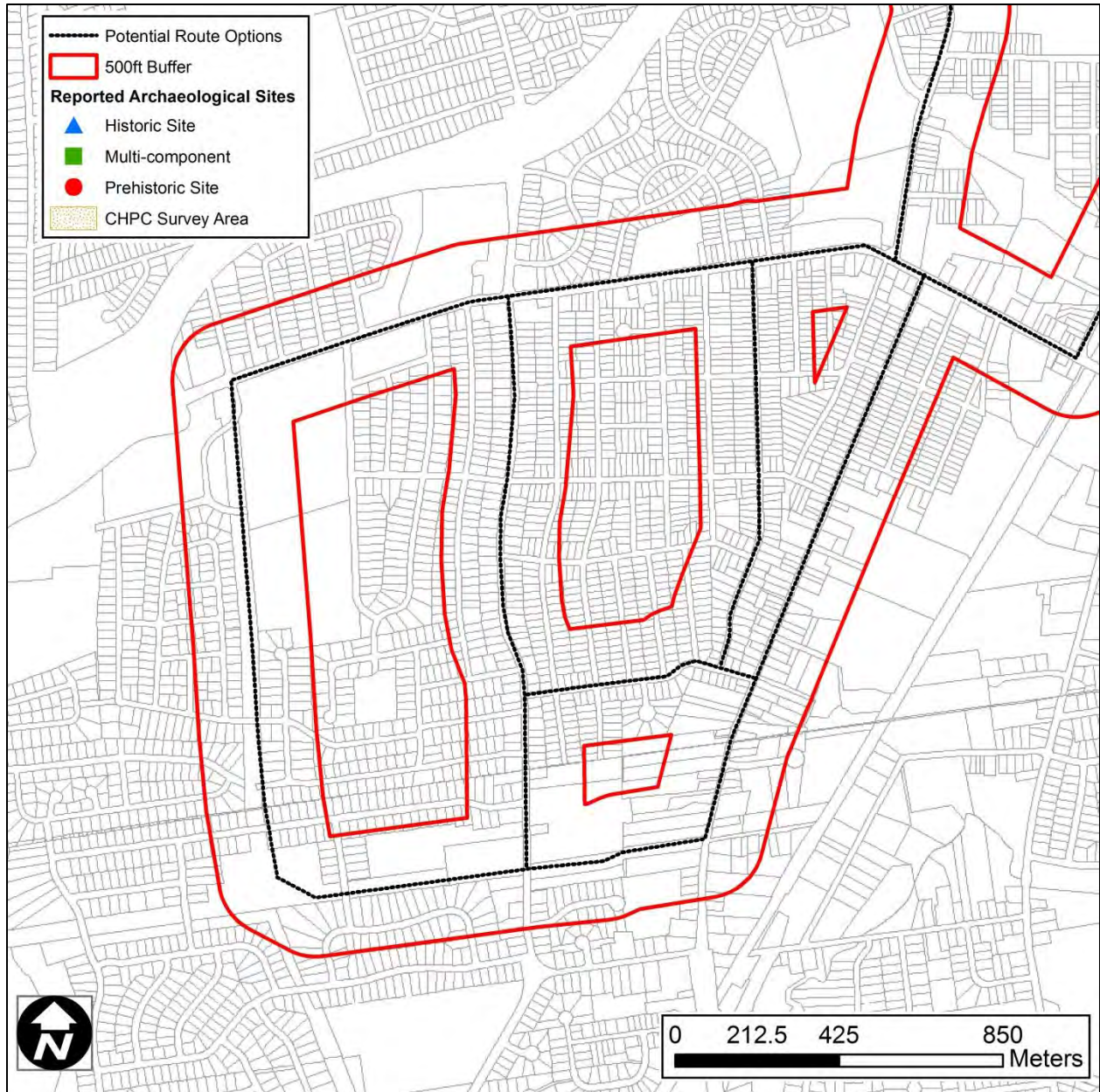


Figure 8, Sheet 3. Digital map depicting the locations of previously identified archaeological sites in the vicinity of the Greater Hartford Reliability Project Corridor in Newington and Hartford, Connecticut.



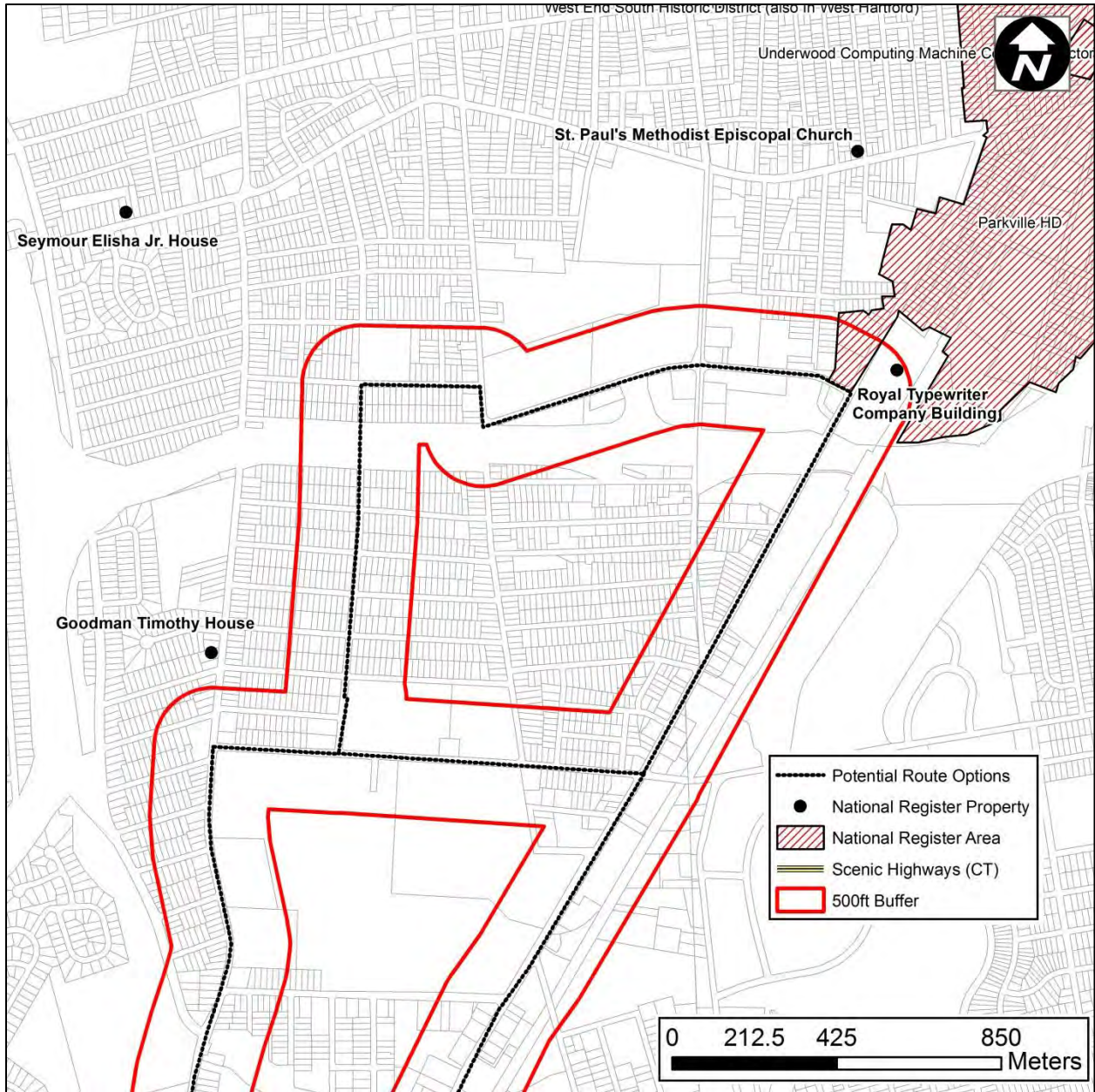


Figure 9, Sheet 1. Digital map depicting the locations of previously identified National Register of Historic Places properties in the vicinity of the Greater Hartford Reliability Project Corridor in Newington and Hartford, Connecticut.

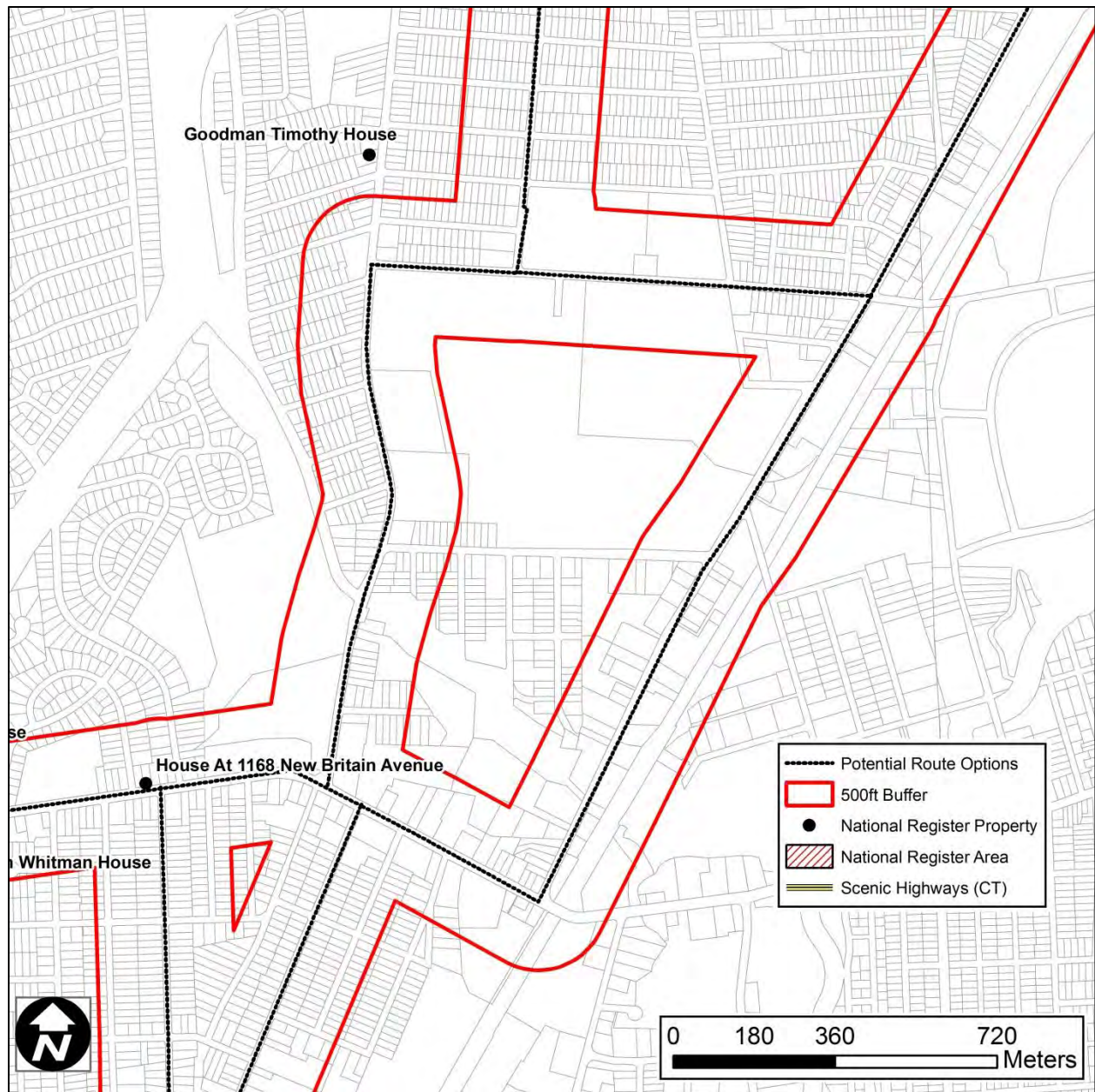


Figure 9, Sheet 2. Digital map depicting the locations of previously identified National Register of Historic Places properties in the vicinity of the Greater Hartford Reliability Project Corridor in Newington and Hartford, Connecticut.

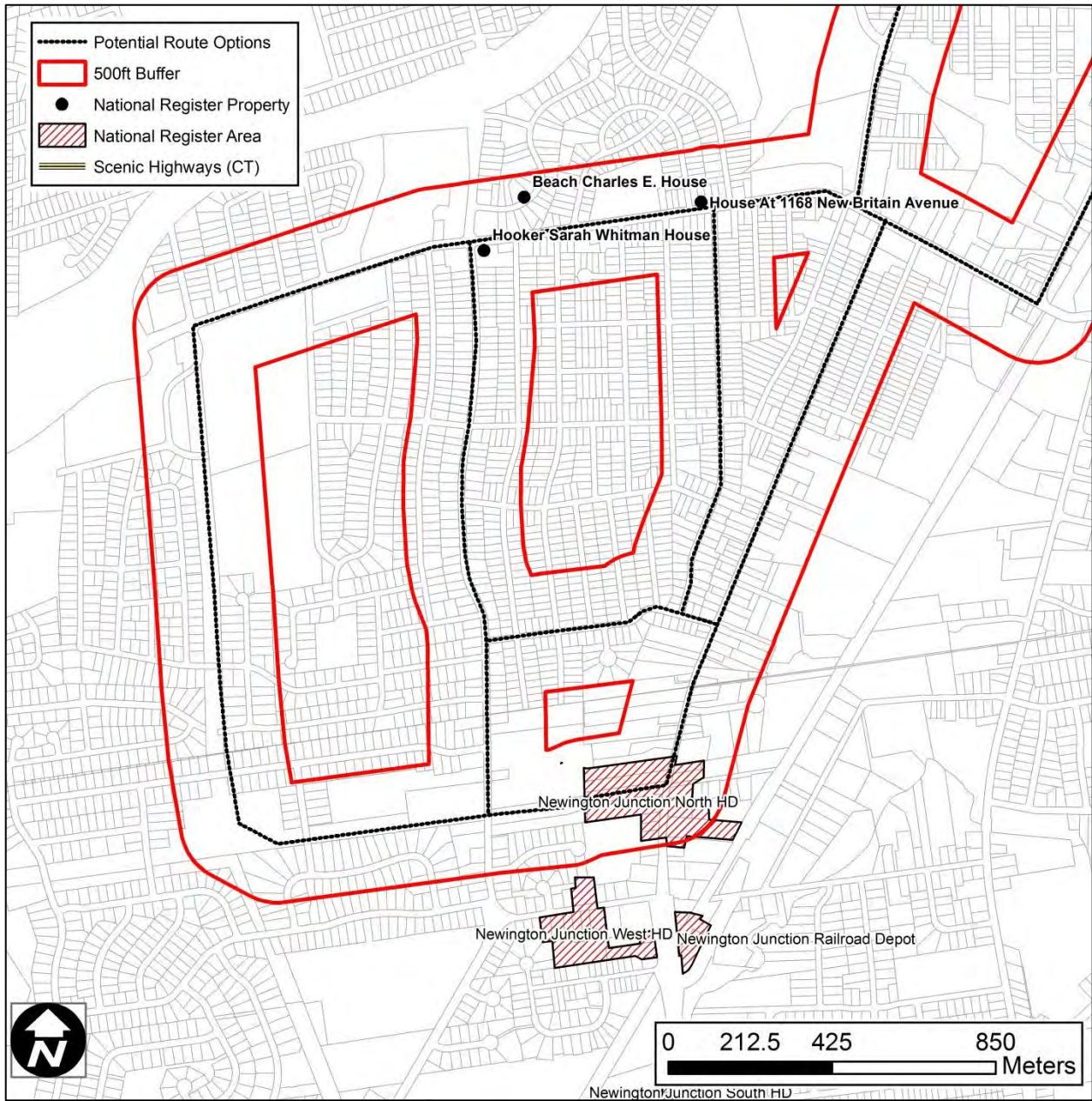


Figure 9, Sheet 3.

Digital map depicting the locations of previously identified National Register of Historic Places properties in the vicinity of the Greater Hartford Reliability Project Corridor in Newington and Hartford, Connecticut.

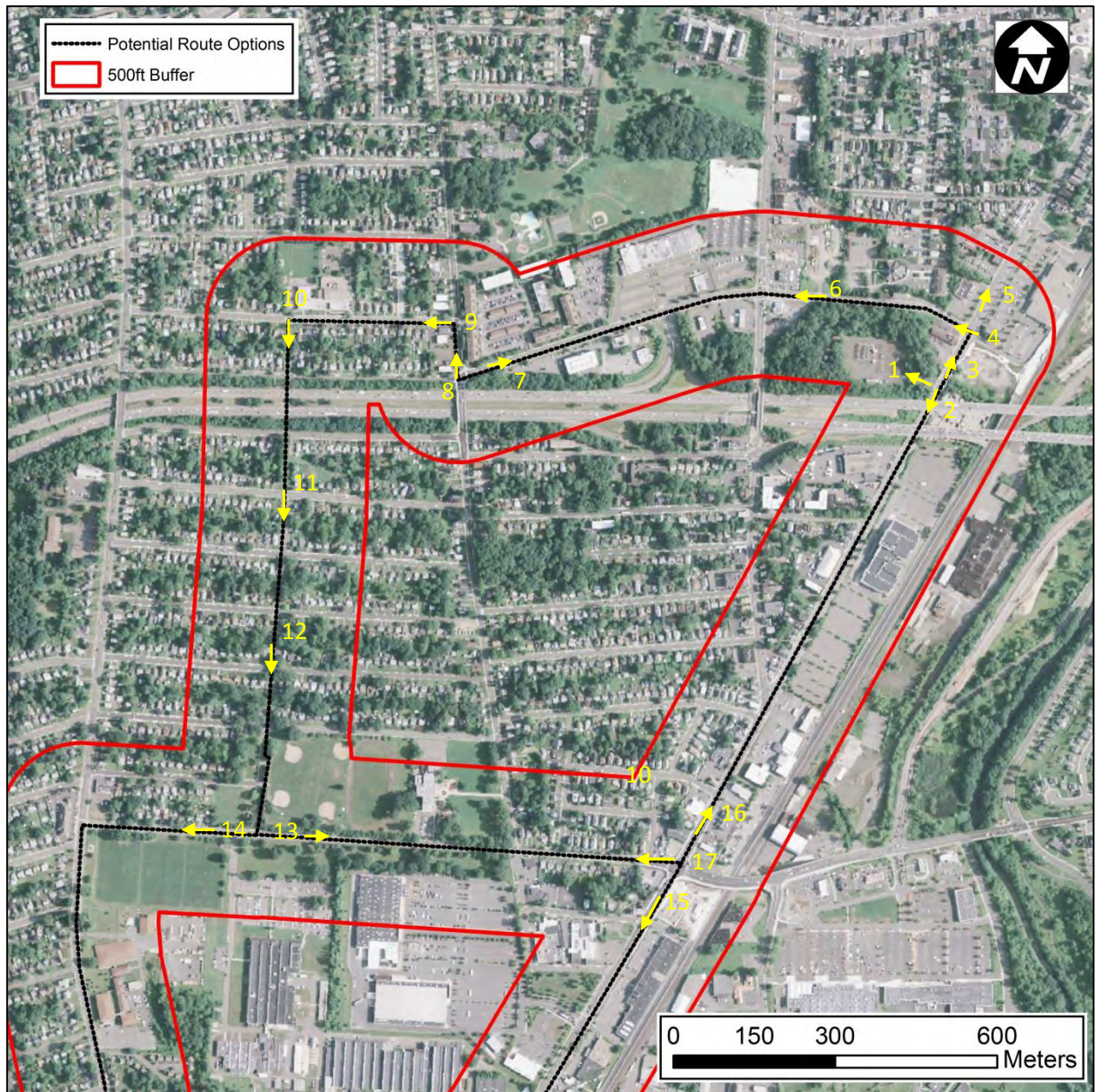


Figure 10, Sheet 1. Excerpt from a modern aerial image showing the proposed project corridors in Hartford and Newington, Connecticut and the directions from which photos were taken during pedestrian survey.

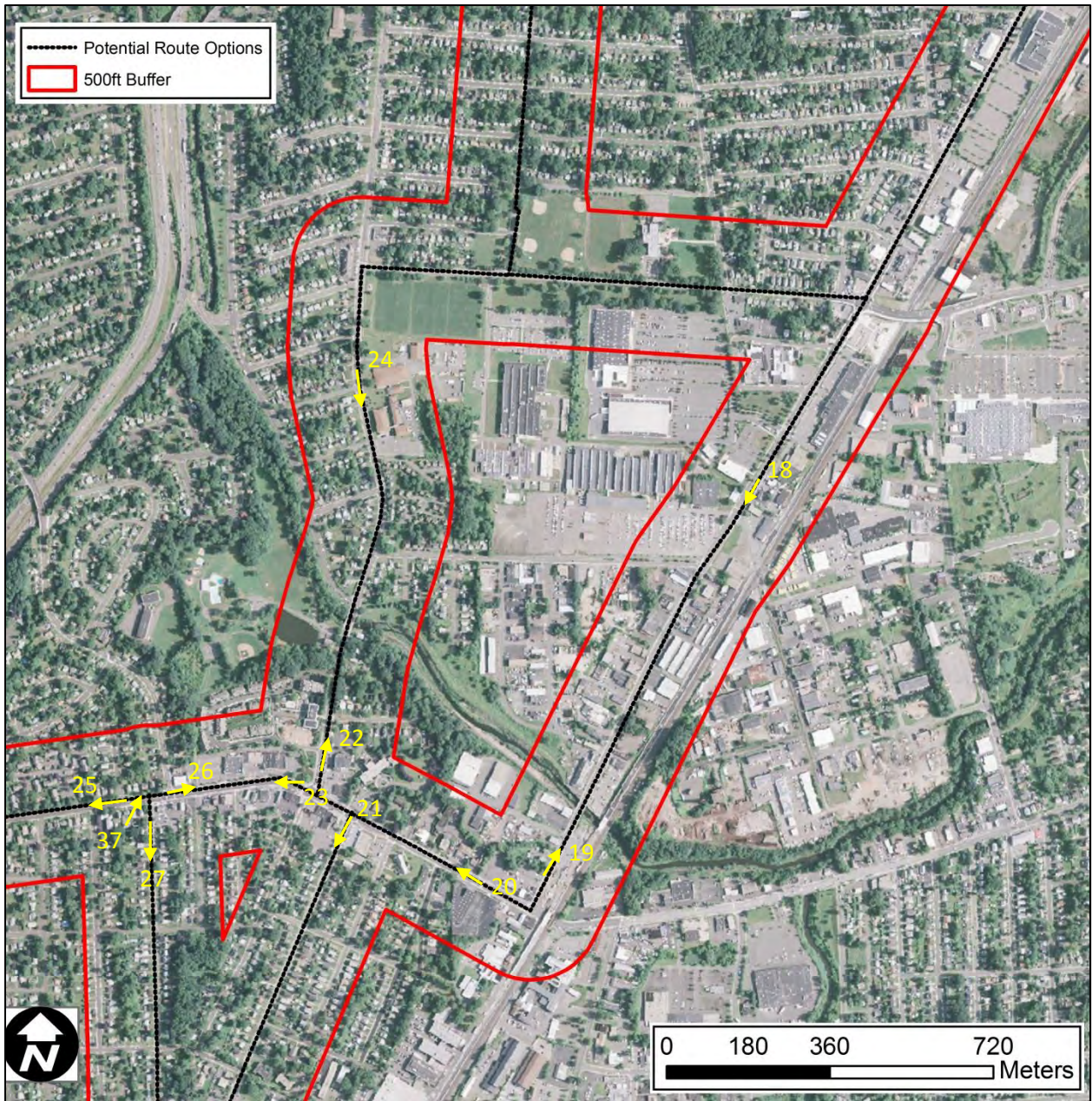


Figure 10, Sheet 2. Excerpt from a modern aerial image showing the proposed project corridors in Hartford and Newington, Connecticut and the directions from which photos were taken during pedestrian survey.

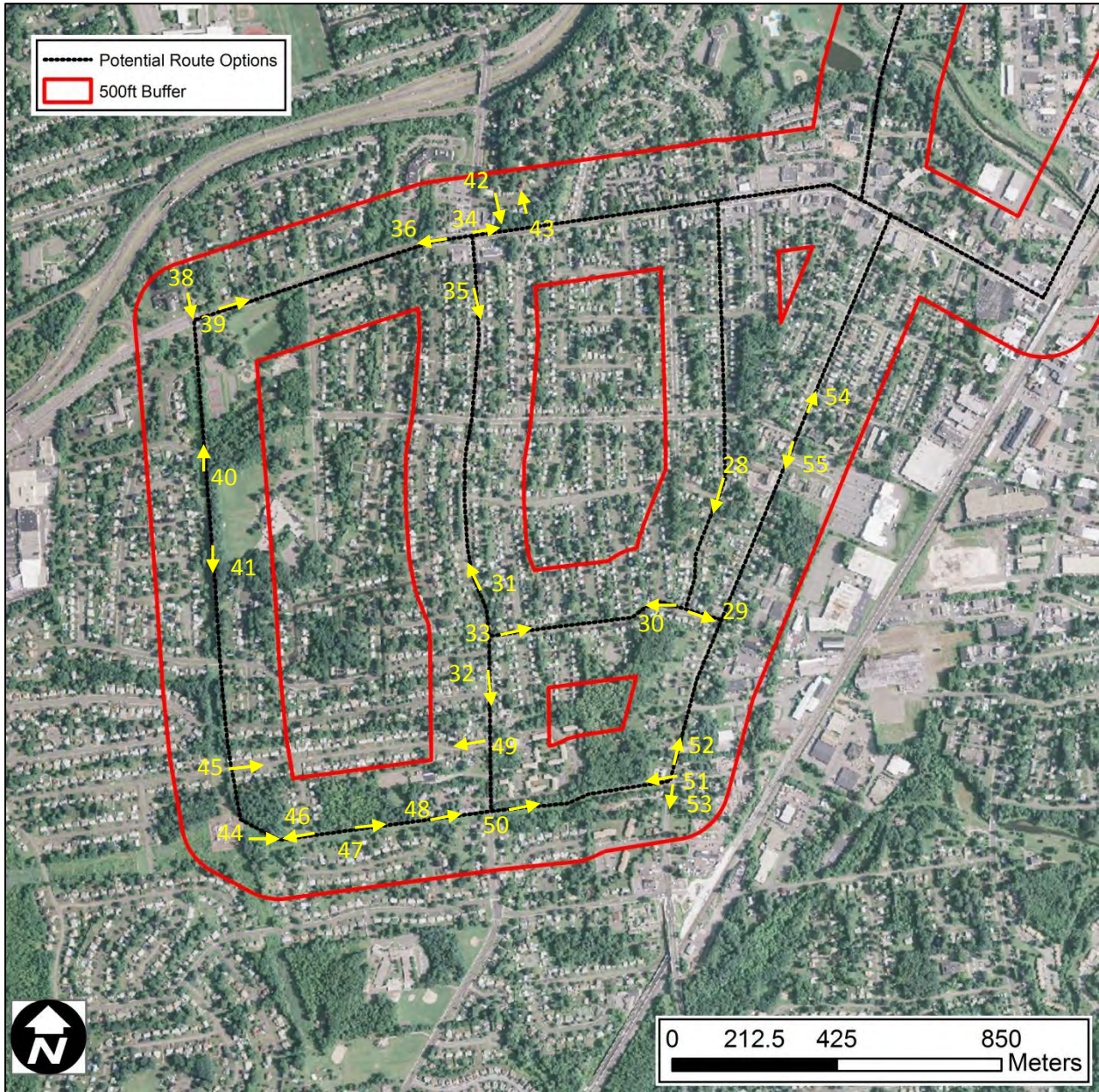


Figure 10, Sheet 3. Excerpt from a modern aerial image showing the proposed project corridors in Hartford and Newington, Connecticut and the directions from which photos were taken during pedestrian survey.

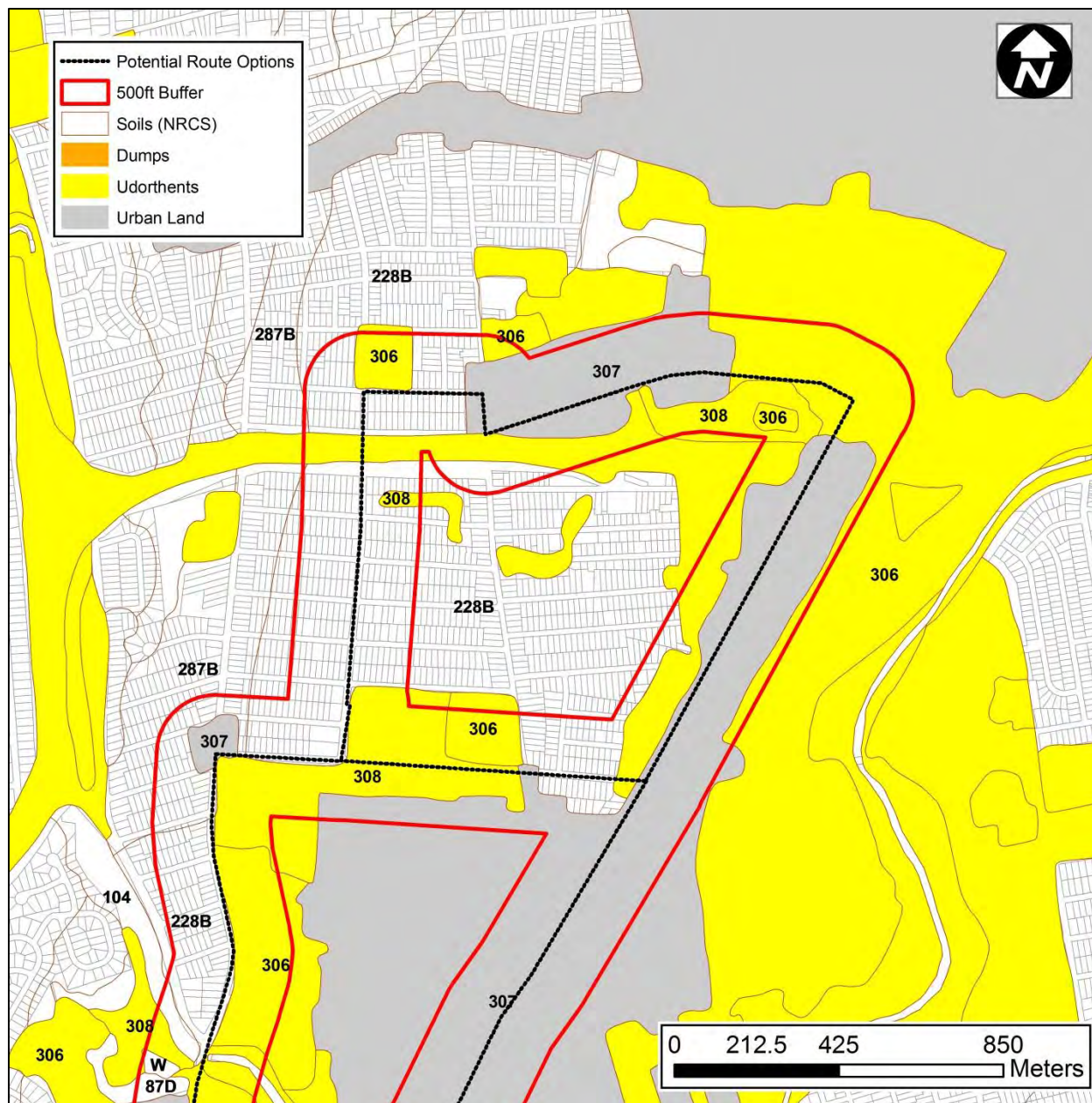


Figure 11, Sheet 1. Digital map depicting the locations of various soil type within the limits of the Greater Hartford Reliability Project Corridor in Newington and Hartford, Connecticut.







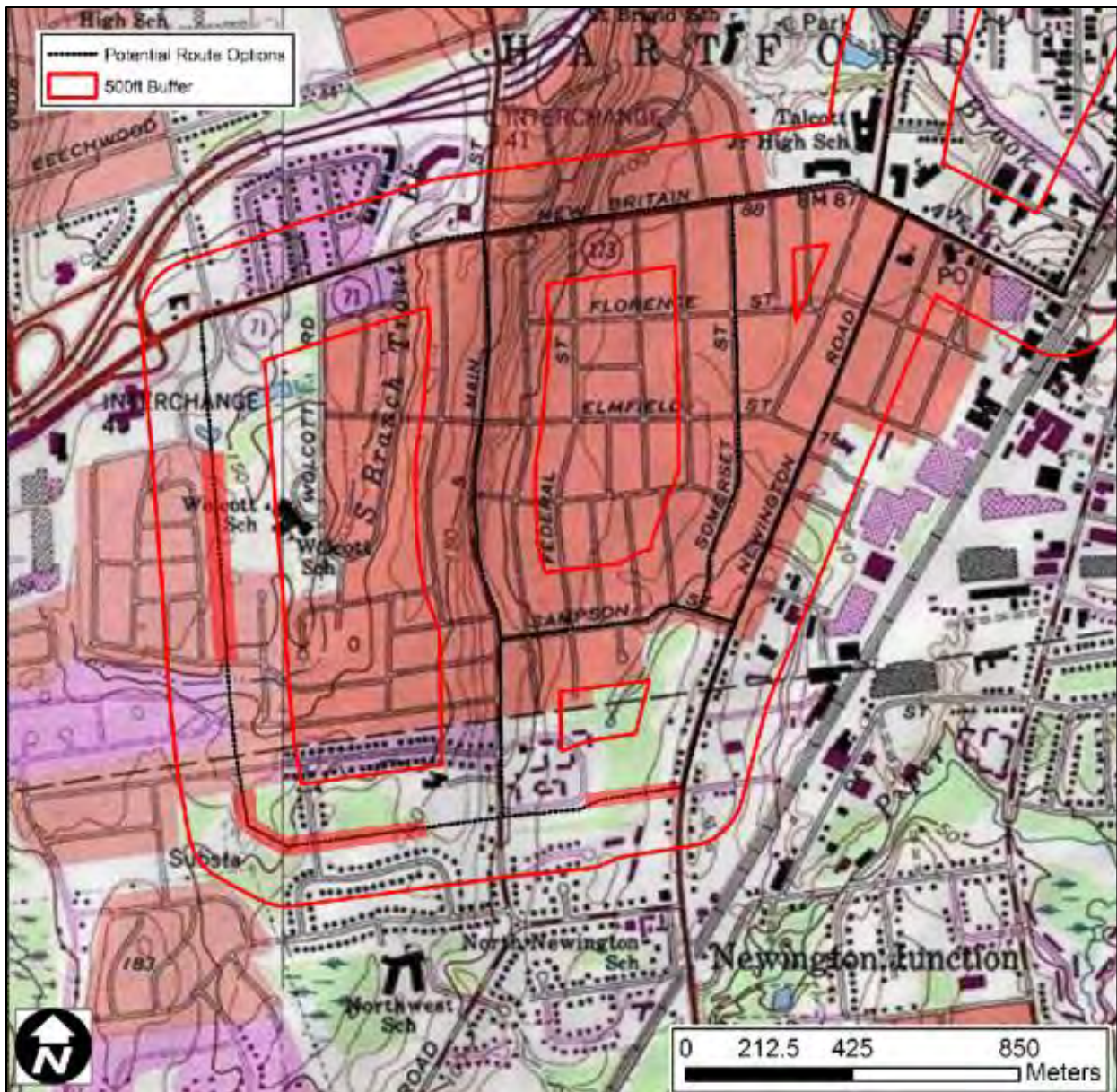


Figure 12. Excerpt for a modern USGS 7.5' series topographic quadrangle depicting the locations of areas of moderate/high archaeological sensitivity within the Greater Hartford Reliability Project Corridor in Newington Connecticut (note the red polygons denote moderate/high areas. The remainder of the region consists of areas of no/low archaeological sensitivity).

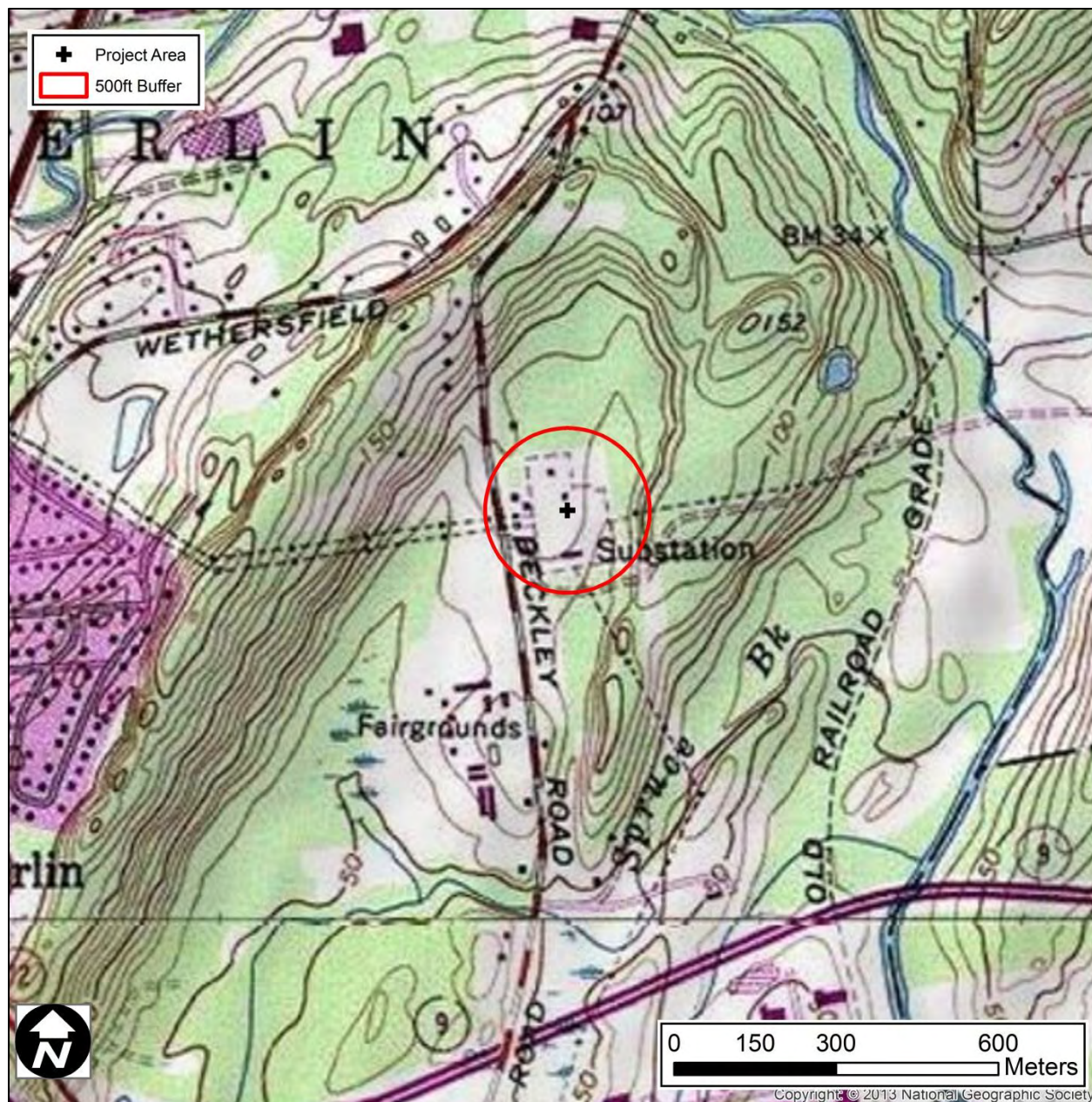


Figure 13. Excerpt from a USGS 7.5' series topographic quadrangle image showing the proposed substation expansion area in Berlin, Connecticut.

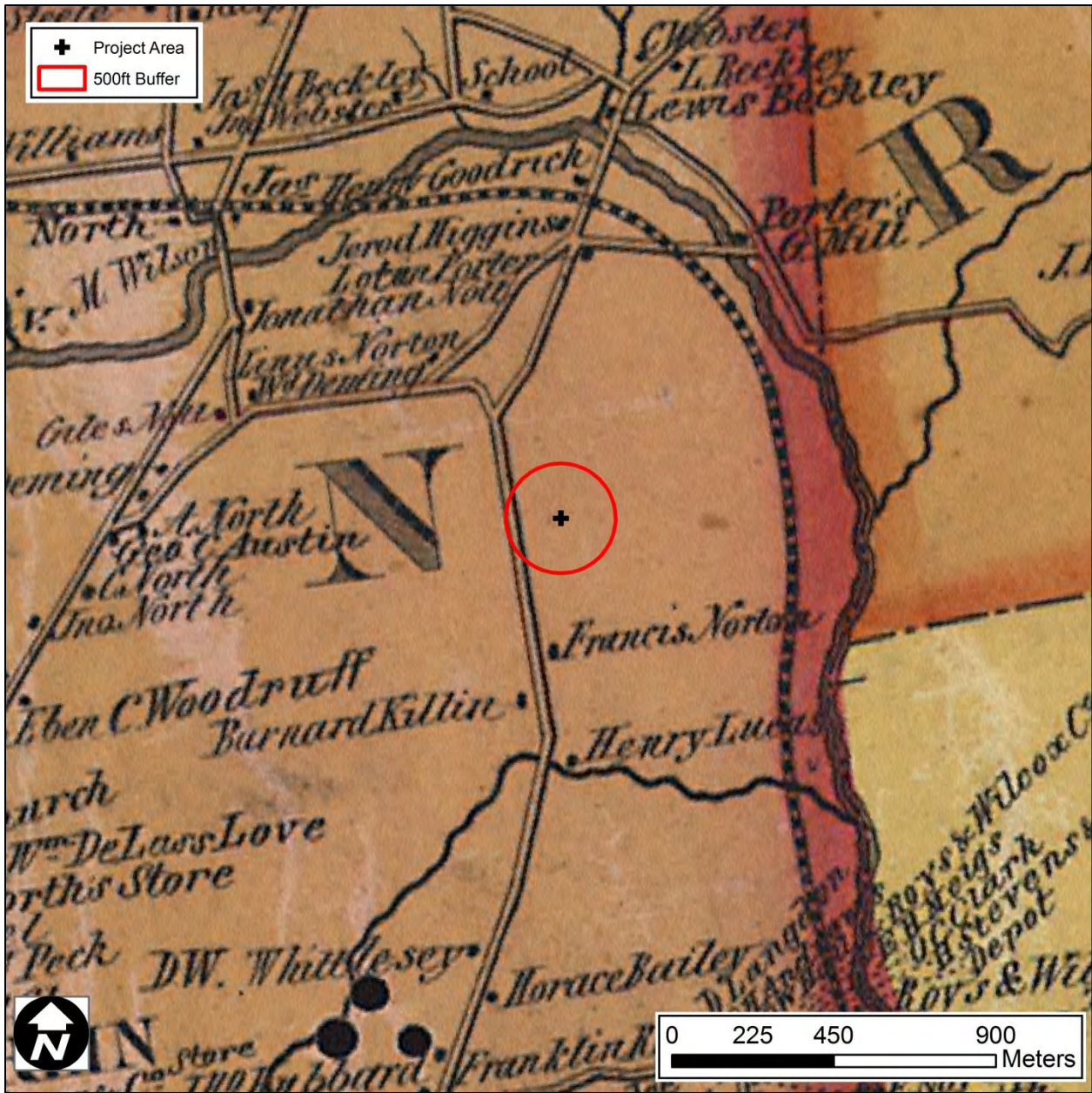


Figure 14. Excerpt from an 1855 historic map showing the proposed substation expansion area in Berlin, Connecticut.



Figure 15. Excerpt from an 1869 historic map showing the proposed substation expansion area in Berlin, Connecticut.



Figure 16. Excerpt from a 1934 aerial image showing the proposed substation expansion area in Berlin, Connecticut.



Figure 17. Excerpt from a 1951 aerial image showing the proposed substation expansion area in Berlin, Connecticut.

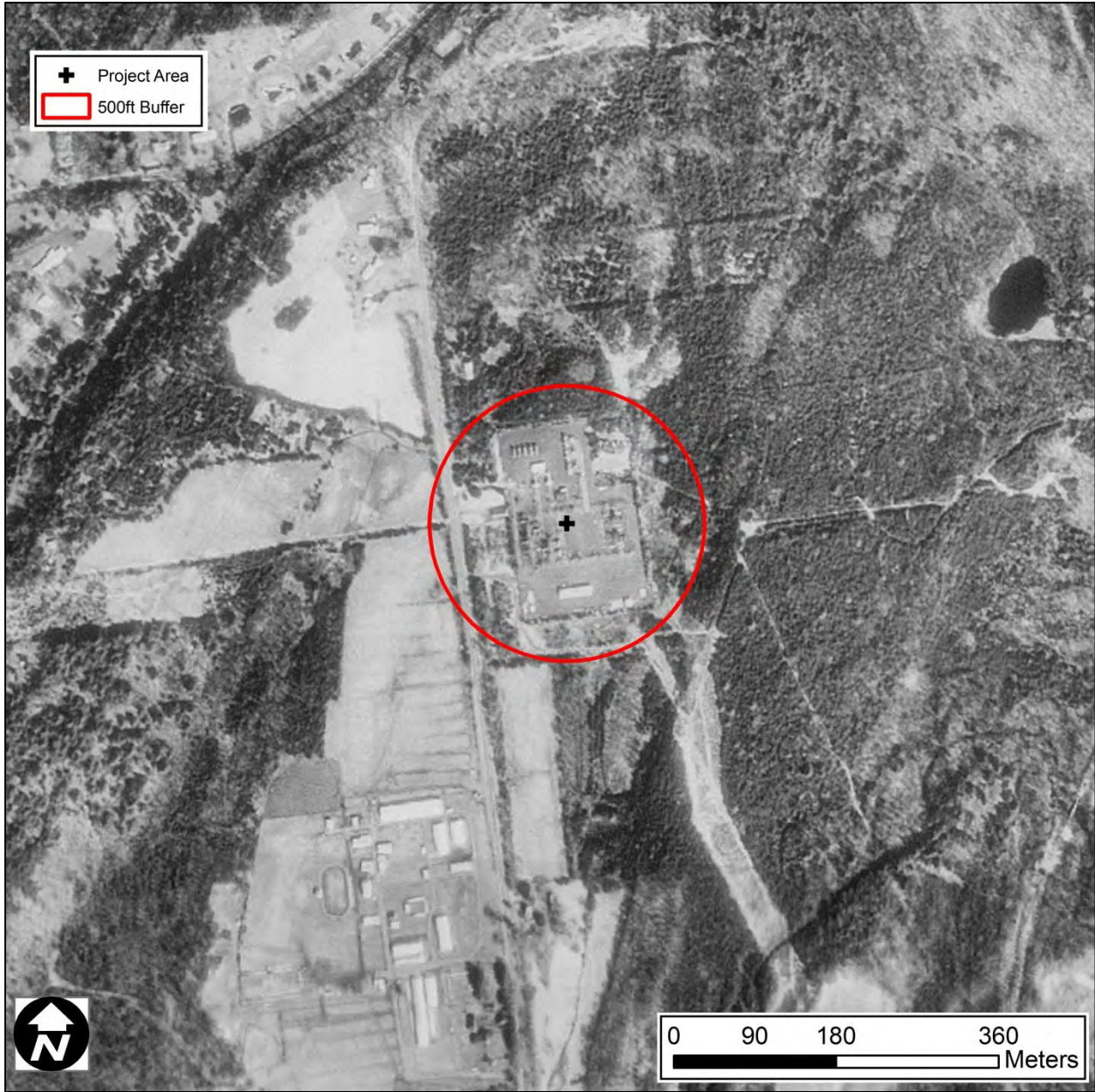


Figure 18. Excerpt from a 1990 aerial image showing the proposed substation expansion area in Berlin, Connecticut.



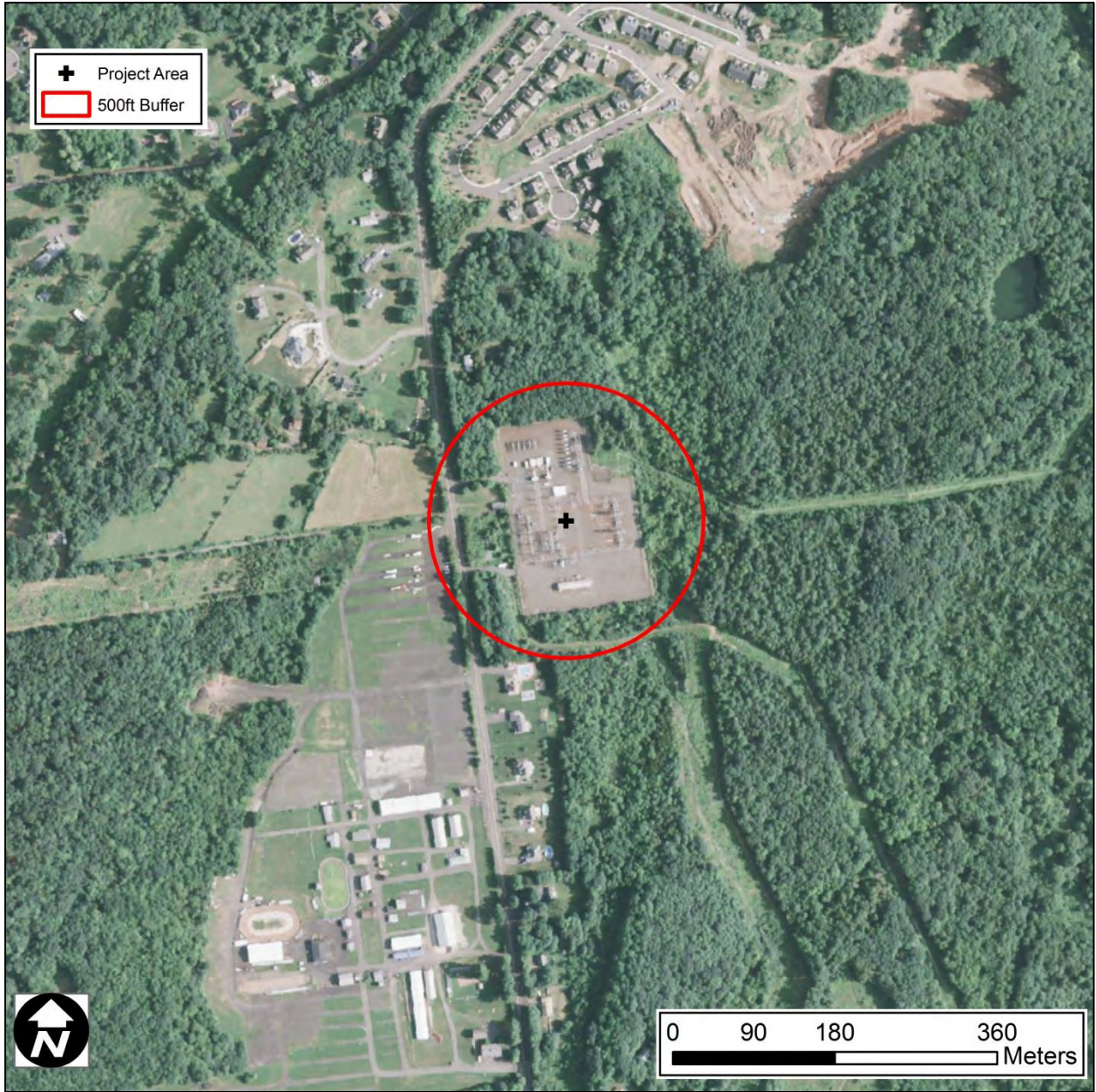


Figure 19. Excerpt from a 2014 aerial image showing the proposed substation expansion area in Berlin, Connecticut.

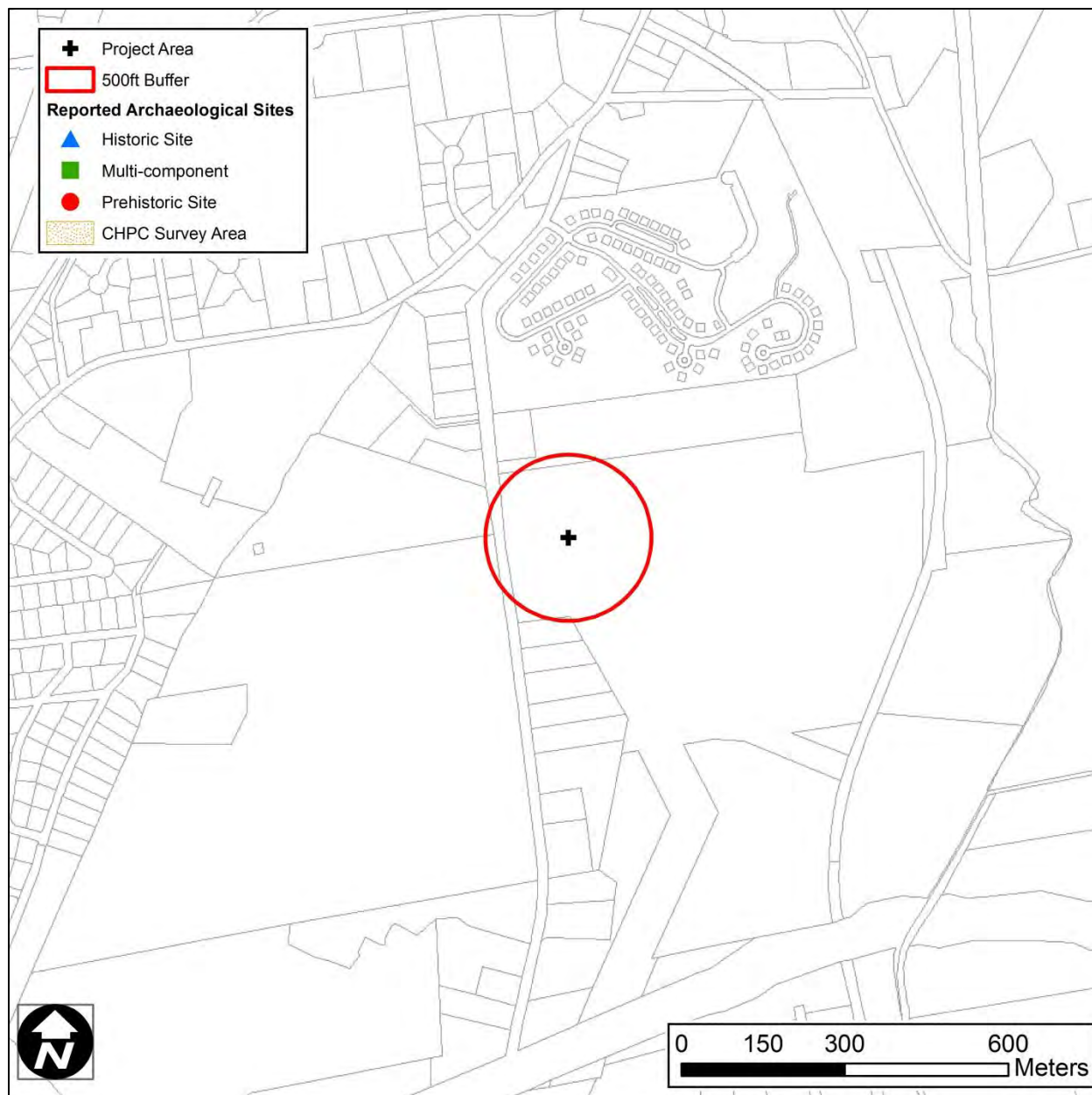


Figure 20. Digital map showing the location of previously identified archaeological sites in the vicinity of the proposed substation expansion area in Berlin, Connecticut.

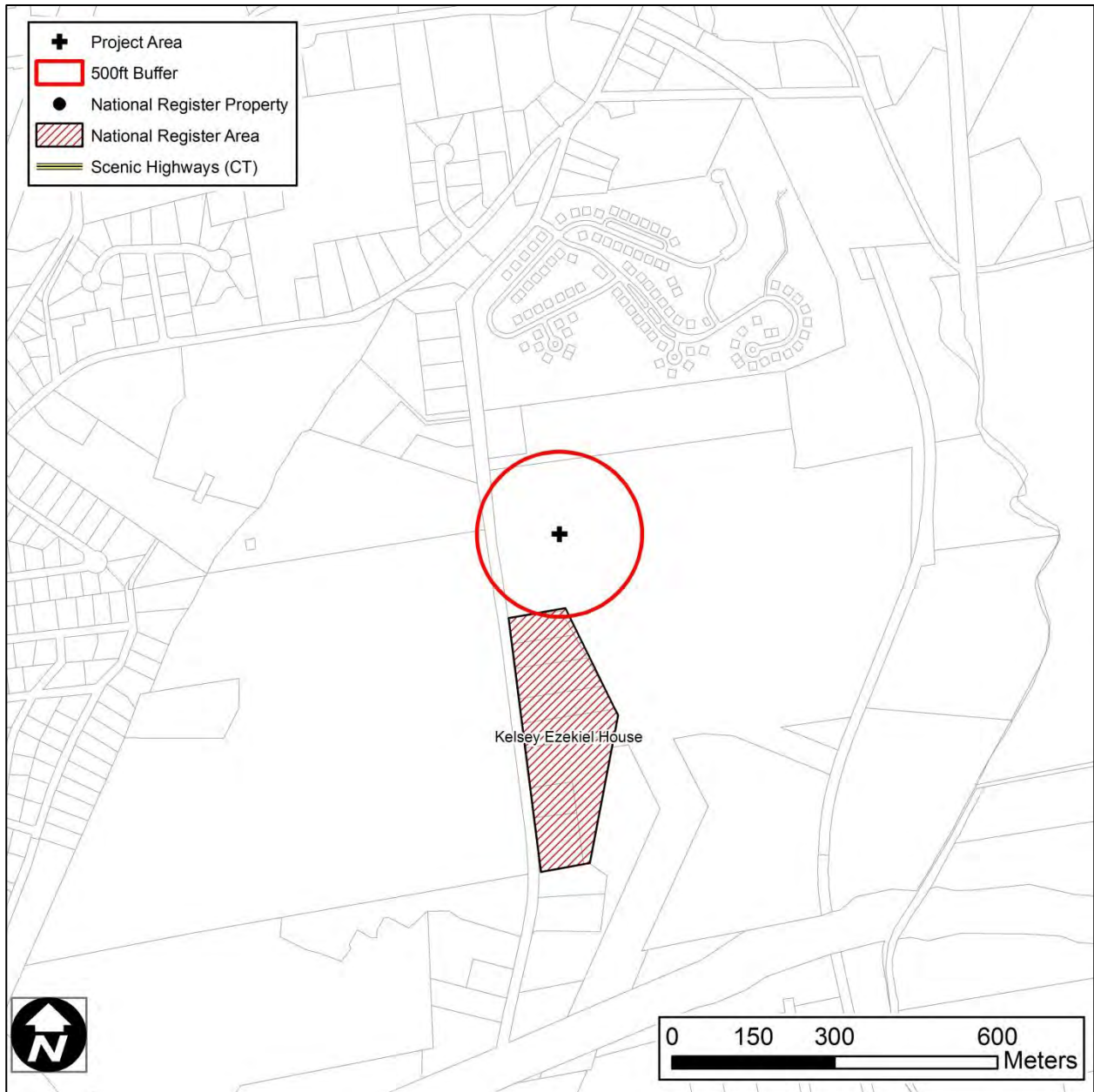


Figure 21. Digital map showing the location of previously identified National Register of Historic Places properties in the vicinity of the proposed substation expansion area in Berlin, Connecticut.

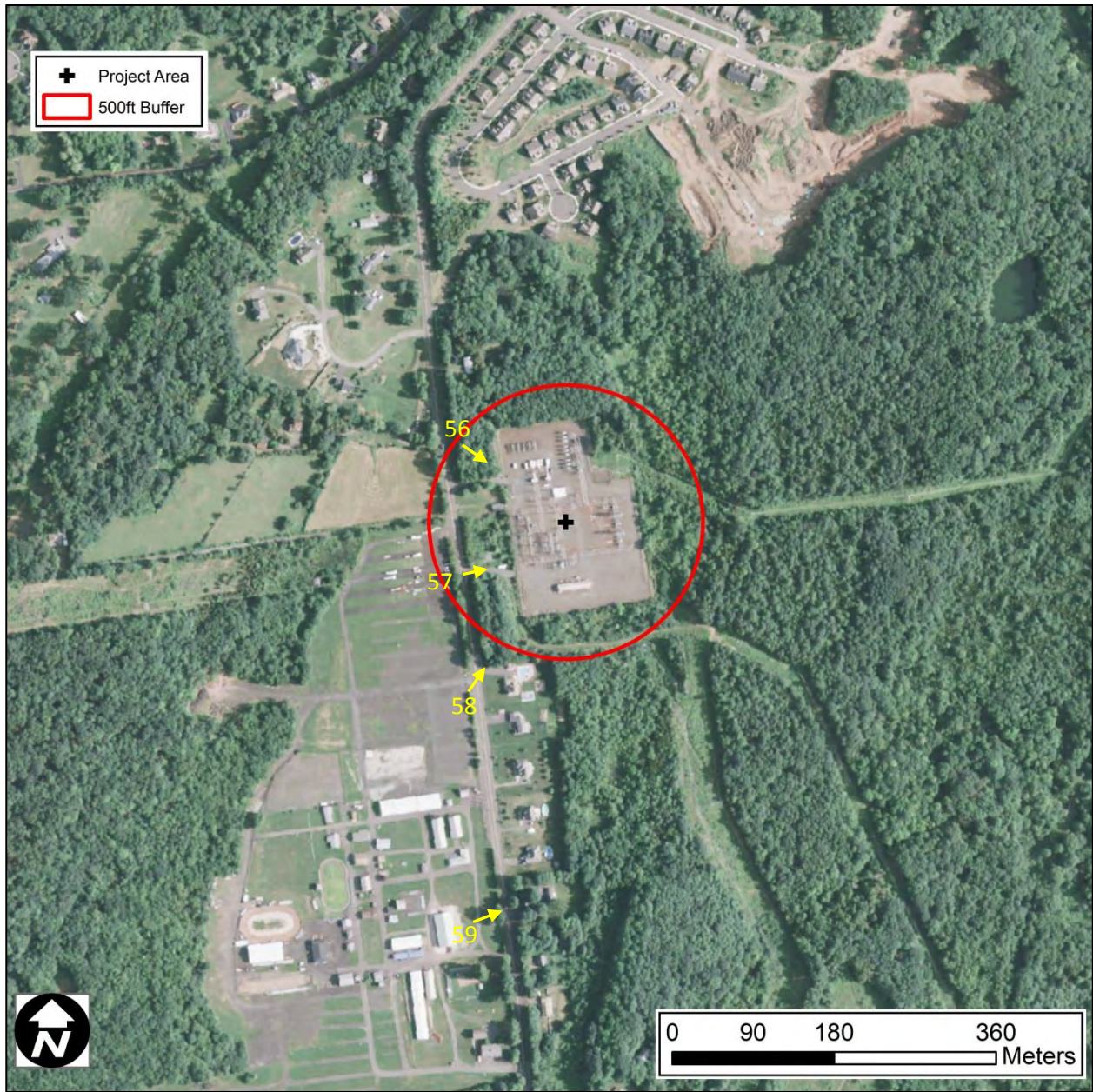


Figure 22. Excerpt from a modern aerial image showing the substation expansion area in Berlin, Connecticut and the directions from which photos were taken during pedestrian survey.

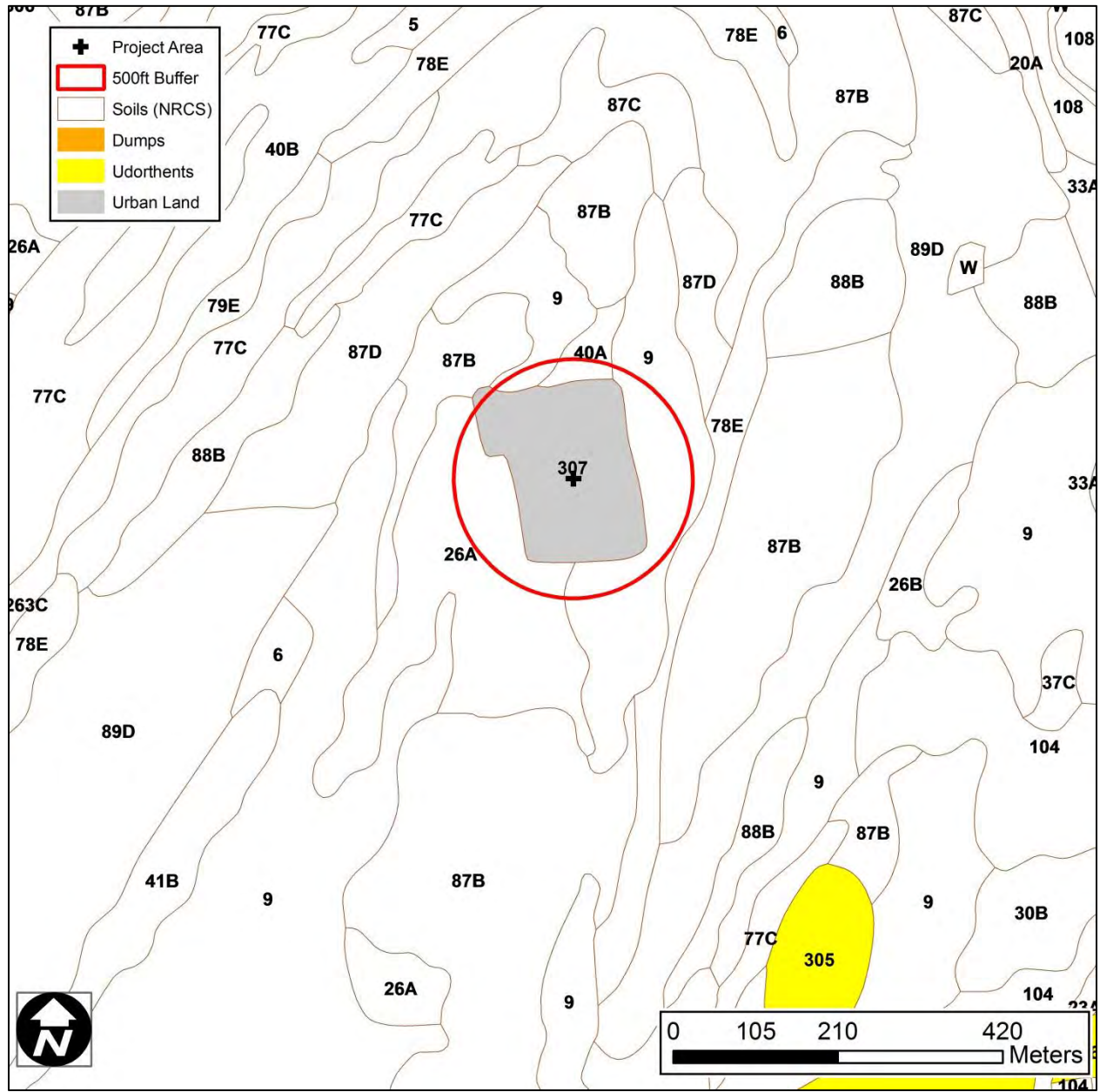


Figure 23. Digital map showing the location soil types in the vicinity of the proposed substation expansion area in Berlin, Connecticut.



Photo 1. Overview photo of the Southwest Hartford Substation facing northwest.



Photo 2. Overview photo of the proposed project corridor facing south along New Park Avenue.

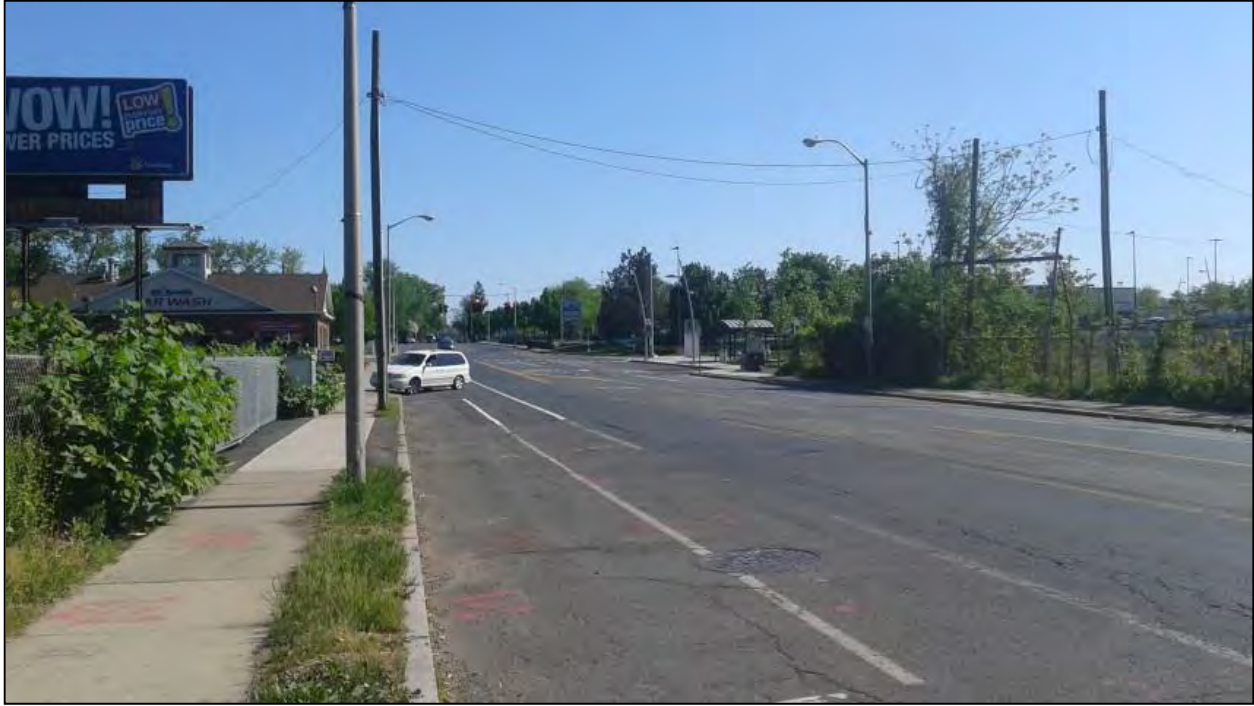


Photo 3. Overview photo of the proposed project corridor facing north along New Park Avenue.



Photo 4. Overview photo of the proposed project corridor facing north along Kane Street.



Photo 5. Overview photo facing northeast from the proposed project corridor and toward the Parkville Historic District and the Royal Typewrite Company Building.



Photo 6. Overview photo of proposed project corridor facing west along Kane Street.





Photo 7. Overview photo of proposed project corridor facing northeast along Kane Street.



Photo 8. Overview photo of proposed project corridor facing north along Oakwood Avenue.



Photo 9. Overview photo of proposed project corridor facing west along Saint James Street.



Photo 10. Overview photo of proposed project corridor facing south along a dead end lane.



Photo 11. Overview photo of proposed project corridor facing south along Price Boulevard.



Photo 12. Overview photo of proposed project corridor facing south along Price Boulevard.



Photo 13. Overview photo of proposed project corridor facing east along Flatbush Avenue.

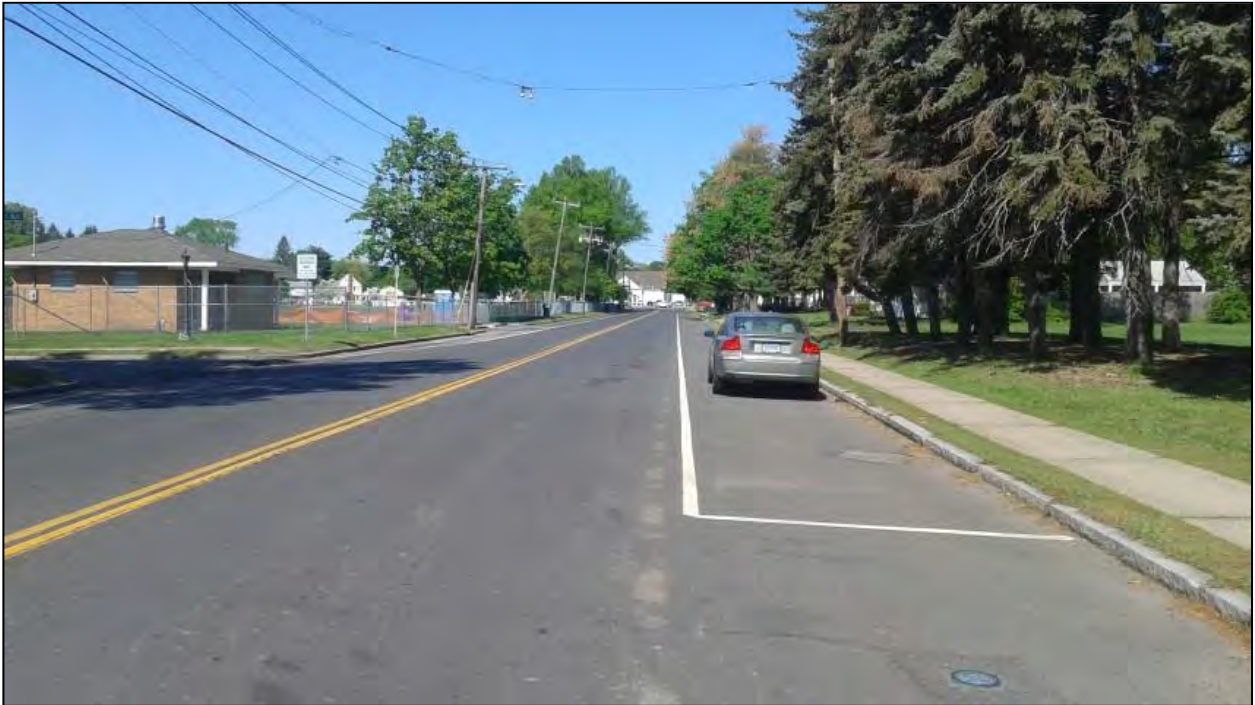


Photo 14. Overview photo of proposed project corridor facing west along Flatbush Avenue



Photo 15. Overview photo of proposed project corridor facing south along New Park Avenue.



Photo 16. Overview photo of proposed project corridor facing north along New Park Avenue.



Photo 17. Overview photo of proposed project corridor facing west along Flatbush Avenue



Photo 18. Overview photo of proposed project corridor facing north along New Park Avenue



Photo 19. Overview photo of proposed project corridor facing north along New Park Avenue



Photo 20. Overview photo of proposed project corridor facing west along New Britain Avenue.



Photo 21. Overview photo of proposed project corridor facing southwest along Newington Road.



Photo 22. Overview photo of proposed project corridor facing north along South Quaker Lane.





Photo 23. Overview photo of proposed project corridor facing west along New Britain Avenue.



Photo 24. Overview photo of proposed project corridor facing south along South Quaker Lane.

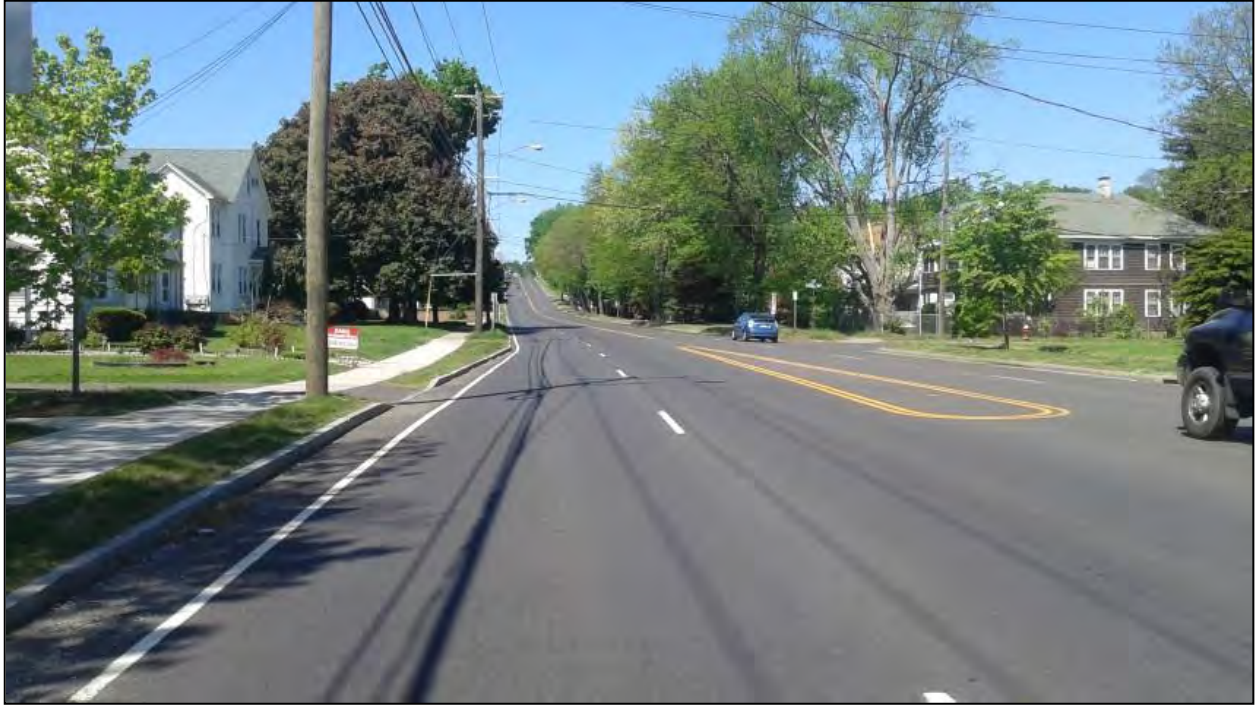


Photo 25. Overview photo of proposed project corridor facing west along New Britain Avenue.



Photo 26. Overview photo of proposed project corridor facing east along New Britain Avenue.



Photo 27. Overview photo of proposed project corridor facing south along Somerset Street.



Photo 28. Overview photo of proposed project corridor facing south along Somerset Street.



Photo 29. Overview photo of proposed project corridor facing east along Samspon Street.



Photo 30. Overview photo of proposed project corridor facing west along Samspon Street.



Photo 31. Overview photo of proposed project corridor facing north along South Main Street.



Photo 32. Overview photo of proposed project corridor facing south along South Main Street.



Photo 33. Overview photo of proposed project corridor facing east along Sampson Street.



Photo 34. Overview photo of proposed project corridor facing east along New Britain Avenue.



Photo 35. Overview photo of proposed project corridor facing south along South Main Street.



Photo 36. Overview photo of proposed project corridor facing west along New Britain Avenue.



Photo 37. Overview photo of 1168 New Britain Avenue facing northeast (this house is listed on the National Register of Historic Places).



Photo 38. Overview photo of proposed project corridor facing east along New Britain Avenue.



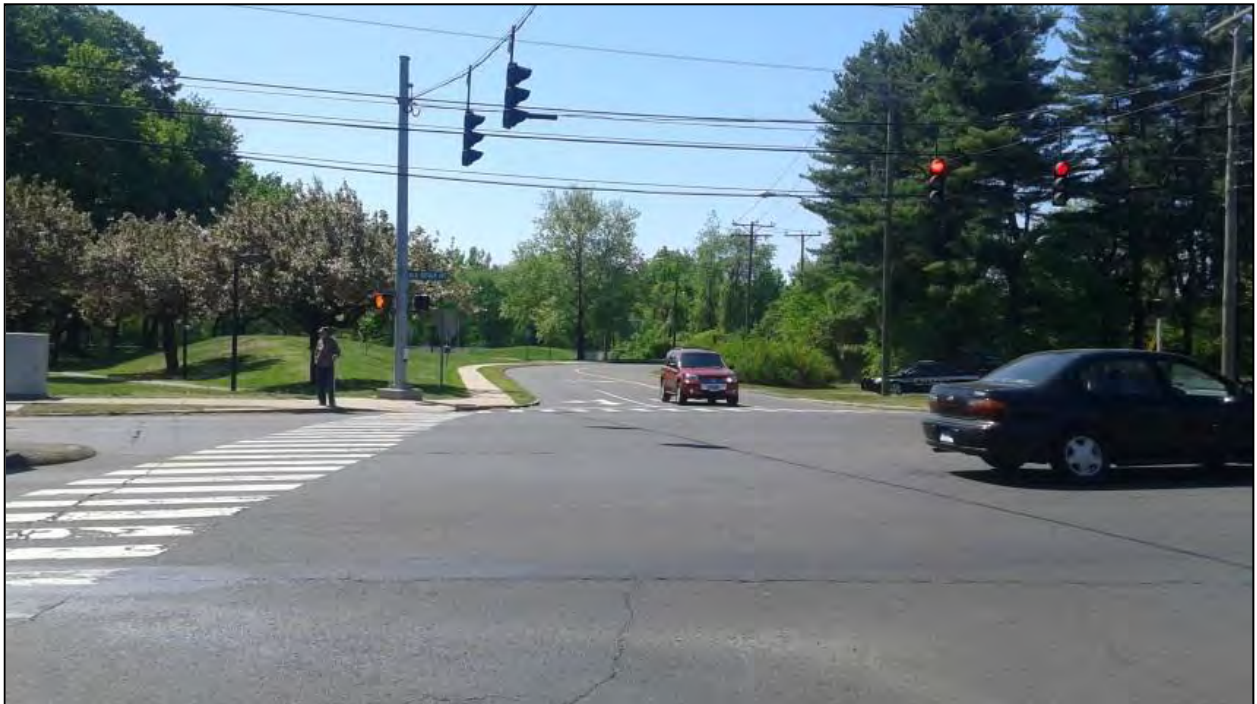


Photo 39. Overview photo of proposed project corridor facing south towards Chatfield Drive.



Photo 40. Overview photo of proposed project corridor facing north along an existing transmission line corridor.



Photo 41. Overview photo of proposed project corridor facing south along an existing transmission line corridor.

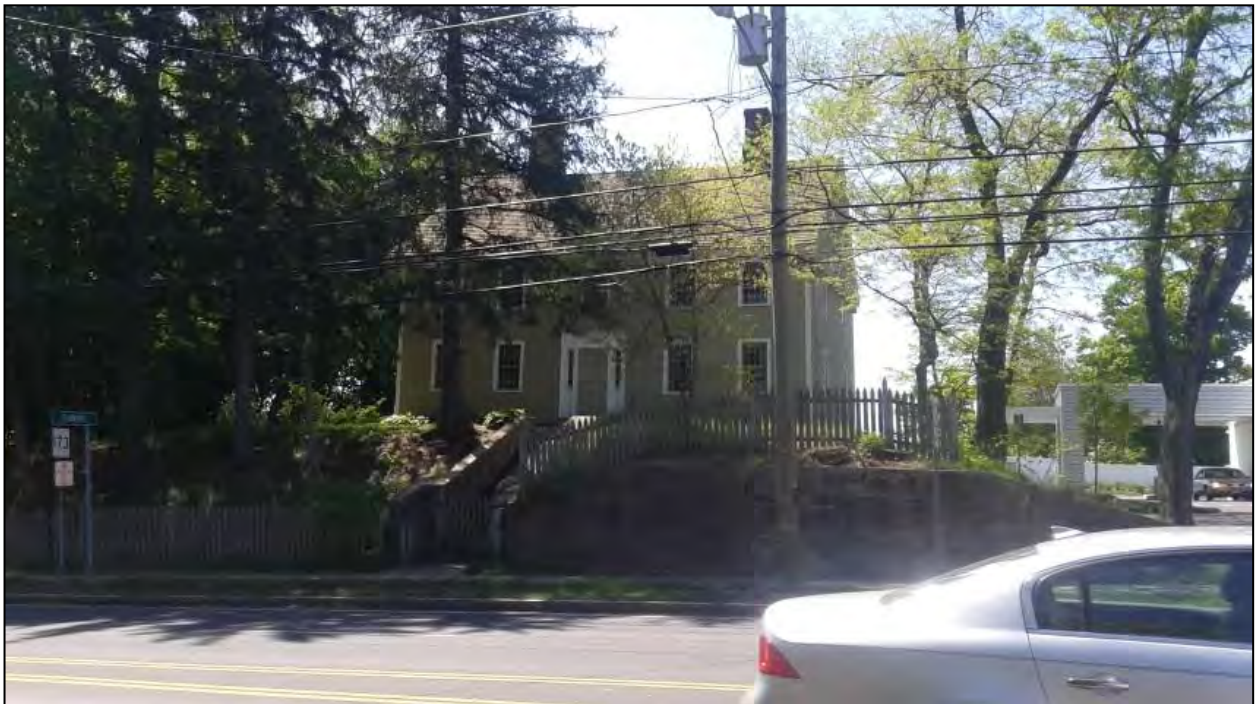


Photo 42. Overview photo of the Sarah Whitman Hooker House on the southern edge of the proposed project corridor facing south (this property is listed on the National Register of Historic Places).



Photo 43. Overview photo of the Charles E. Beacher House facing north (this house is located to the north of the proposed project corridor and it is listed on the National Register of Historic Places).



Photo 44. Overview photo of proposed project corridor facing east along an existing transmission line corridor.



Photo 45. Overview photo of proposed project corridor facing east along Cherry Hill Drive.



Photo 46. Overview photo of proposed project corridor facing west along an existing transmission line corridor.



Photo 47. Overview photo of the Newington Substation facing east.



Photo 48. Overview photo of the Newington Substation facing east.



Photo 49. Overview photo of proposed project corridor facing west along Cherry Hill Road.

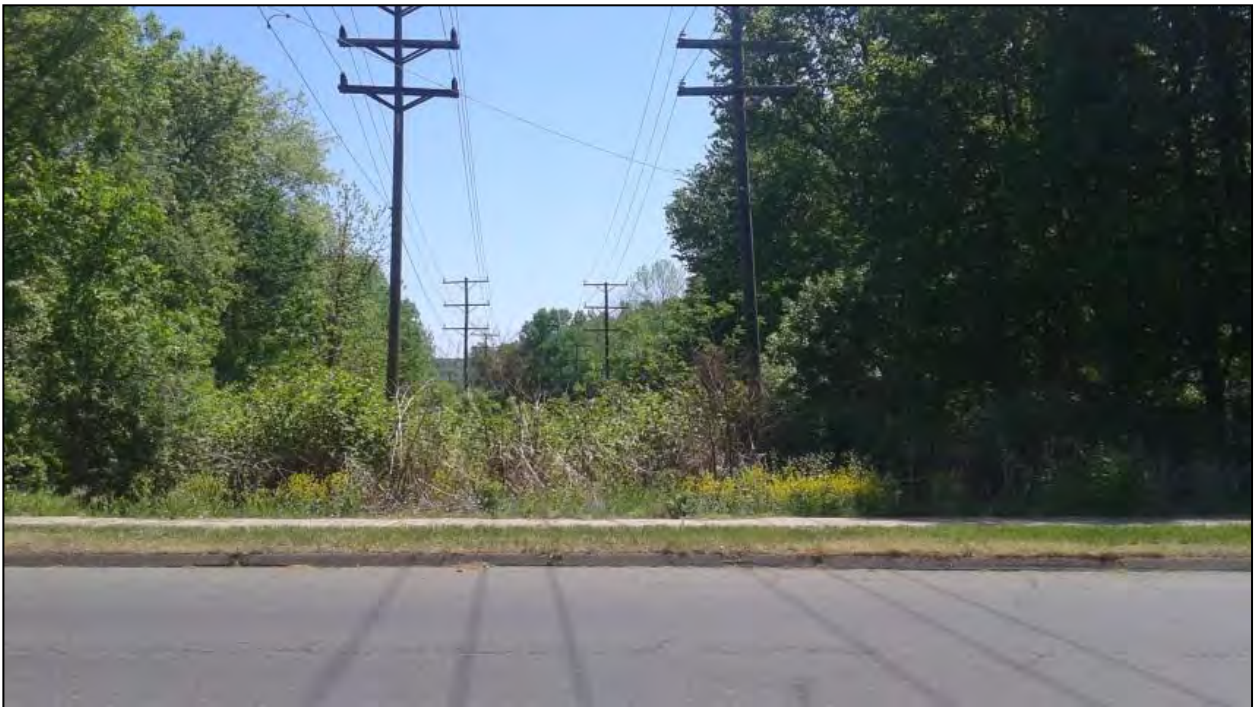


Figure 50. Overview photo of proposed project corridor facing east along an existing transmission line corridor.



Photo 51. Overview photo of proposed project corridor facing west along an existing transmission line corridor.



Photo 52. Overview photo of proposed project corridor facing north along Newington Road (this area is part of the Newington Junction North Historic District).



Photo 53. Overview photo of proposed project corridor facing south along Newington Road (this area is part of the Newington Junction North Historic District).



Photo 54. Overview photo of proposed project corridor facing north along Newington Road.





Photo 55. Overview photo of proposed project corridor facing north along Newington Road.



Photo 56. Overview photo of the Berlin Substation area facing southeast.



Photo 57. Overview photo of the Berlin Substation area facing east.



Photo 58. Overview photo of the Berlin Substation area facing northeast.



Photo 59. Overview photo of the Ezekial Kelsey House facing northeast (this National Register of Historic Places property is located to the south of the Berlin Substation area).

**Exhibit 2.C Municipal Outreach Information/  
Copies of Agency Correspondence**





**RE: Eversource Newington to South West Hartford Underground Project**

From: **DEEP Nddbrequest**

09/02/2015 04:22 PM

To: Justin W. Adams

Cc: DEEP Nddbrequest

History: This message has been forwarded.

Justin,

I concur that there are no anticipated impacts to state-listed species based on the maps and proposed activities for this project.

Take care,

Dawn

Dawn M. McKay

Wildlife Division

Bureau of Natural Resources

Connecticut Department of Energy and Environmental Protection

79 Elm Street, Hartford, CT 06106-5127

P: 860.424.3592 | E: dawn.mckay@ct.gov<mailto:dawn.mckay@ct.gov>

---

From: justin.adams@eversource.com <justin.adams@eversource.com>

Sent: Tuesday, September 1, 2015 3:37 PM

To: DEEP Nddbrequest

Subject: Eversource Newington to South West Hartford Underground Project

Hello,

The Greater Hartford Connecticut Central Reliability Project - Hartford Underground Project (the "Project") consists of the proposed installation of a 115-kV underground transmission cable which would extend approximately 4 miles from the Southwest Hartford substation to the Newington substation. The cable installation will occur mainly within existing roadways. Route selection is being finalized. Please see attached figure depicting potential route variations under consideration.

In addition to proposed work activities at the Southwest Hartford and Newington Substations, Project support activities will also be completed at the Berlin Substation. Work will occur within existing fence boundaries at the Southwest Hartford and Berlin substations. A slight expansion of the Newington substation is anticipated to the south of the existing fence line.

Project work will require the use of general construction equipment. Erosion and sedimentation controls will be installed and maintained throughout the construction process.

Based on a review of current NDDB maps, no listed species are known within the project work areas. Please see the attachment for project area mapping.

Eversource is requesting your concurrence on this review.

Best,

Justin W. Adams

Environmental Affairs

Eversource Energy

(860) 839-8373

---

This e-mail, including any files or attachments transmitted with it, is confidential and/or proprietary and is intended for a specific purpose and for use only by the individual or entity to whom it is addressed. Any disclosure, copying or distribution of this e-mail or the taking of any action based on its contents, other than for its intended purpose, is strictly prohibited. If you have received this e-mail in error, please notify the sender immediately and delete it from your system. Any views or opinions expressed in this e-mail are not necessarily those of Northeast Utilities, its subsidiaries and affiliates dba Eversource Energy (Eversource). E-mail transmission cannot be guaranteed to be error-free or secure or free from viruses, and Eversource disclaims all liability for any resulting damage, errors, or omissions.

# **GHCC Newington-SW Hartford**

---

## *IPaC Trust Resource Report*

Generated September 22, 2015 11:56 AM MDT

This report is for informational purposes only and should not be used for planning or analyzing project-level impacts. For projects that require FWS review, please return to this project on the IPaC website and request an official species list from the Regulatory Documents page.





US Fish &amp; Wildlife Service

# IPaC Trust Resource Report



## Project Description

**NAME**

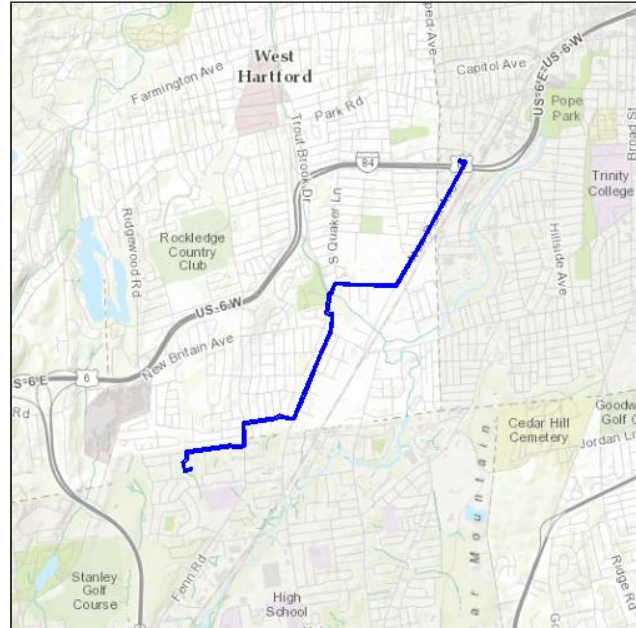
GHCC Newington-SW Hartford

**PROJECT CODE**

CLNHP-PRLJJ-FSBAX-DGUE5-E56LB4

**LOCATION**

Hartford County, Connecticut

**DESCRIPTION**Revised Project Route - GHCC  
Newington-SW Hartford

## U.S. Fish & Wildlife Contact Information

Species in this report are managed by:

**New England Ecological Services Field Office**

70 Commercial Street, Suite 300

Concord, NH 03301-5094

(603) 223-2541

# Endangered Species

Proposed, candidate, threatened, and endangered species that are managed by the [Endangered Species Program](#) and should be considered as part of an effect analysis for this project.

This unofficial species list is for informational purposes only and does not fulfill the requirements under [Section 7](#) of the Endangered Species Act, which states that Federal agencies are required to "request of the Secretary of Interior information whether any species which is listed or proposed to be listed may be present in the area of a proposed action." This requirement applies to projects which are conducted, permitted or licensed by any Federal agency.

A letter from the local office and a species list which fulfills this requirement can be obtained by returning to this project on the IPaC website and requesting an official species list on the Regulatory Documents page.

## Mammals

**Northern Long-eared Bat** *Myotis septentrionalis*

Threatened

CRITICAL HABITAT

**No critical habitat** has been designated for this species.

<https://ecos.fws.gov/speciesProfile/profile/speciesProfile.action?sPCODE=A0JE>

## Critical Habitats

Potential effects to critical habitat(s) within the project area must be analyzed along with the endangered species themselves.

There is no critical habitat within this project area

# Migratory Birds

Birds are protected by the [Migratory Bird Treaty Act](#) and the Bald and Golden Eagle Protection Act.

Any activity which results in the take of migratory birds or eagles is prohibited unless authorized by the U.S. Fish and Wildlife Service (1). There are no provisions for allowing the take of migratory birds that are unintentionally killed or injured.

You are responsible for complying with the appropriate regulations for the protection of birds as part of this project. This involves analyzing potential impacts and implementing appropriate conservation measures for all project activities.

<p><b>American Bittern</b> <i>Botaurus lentiginosus</i>            Season: Breeding  <a href="https://ecos.fws.gov/speciesProfile/profile/speciesProfile.action?spcode=B0F3">https://ecos.fws.gov/speciesProfile/profile/speciesProfile.action?spcode=B0F3</a></p>	<b>Bird of conservation concern</b>
<p><b>Bald Eagle</b> <i>Haliaeetus leucocephalus</i>            Year-round  <a href="https://ecos.fws.gov/speciesProfile/profile/speciesProfile.action?spcode=B008">https://ecos.fws.gov/speciesProfile/profile/speciesProfile.action?spcode=B008</a></p>	<b>Bird of conservation concern</b>
<p><b>Black-billed Cuckoo</b> <i>Coccyzus erythrophthalmus</i>            Season: Breeding  <a href="https://ecos.fws.gov/speciesProfile/profile/speciesProfile.action?spcode=B0HI">https://ecos.fws.gov/speciesProfile/profile/speciesProfile.action?spcode=B0HI</a></p>	<b>Bird of conservation concern</b>
<p><b>Blue-winged Warbler</b> <i>Vermivora pinus</i>            Season: Breeding</p>	<b>Bird of conservation concern</b>
<p><b>Canada Warbler</b> <i>Wilsonia canadensis</i>            Season: Breeding</p>	<b>Bird of conservation concern</b>
<p><b>Fox Sparrow</b> <i>Passerella iliaca</i>            Season: Wintering</p>	<b>Bird of conservation concern</b>
<p><b>Least Bittern</b> <i>Ixobrychus exilis</i>            Season: Breeding</p>	<b>Bird of conservation concern</b>
<p><b>Peregrine Falcon</b> <i>Falco peregrinus</i>            Season: Breeding  <a href="https://ecos.fws.gov/speciesProfile/profile/speciesProfile.action?spcode=B0FU">https://ecos.fws.gov/speciesProfile/profile/speciesProfile.action?spcode=B0FU</a></p>	<b>Bird of conservation concern</b>
<p><b>Pied-billed Grebe</b> <i>Podilymbus podiceps</i>            Year-round</p>	<b>Bird of conservation concern</b>
<p><b>Prairie Warbler</b> <i>Dendroica discolor</i>            Season: Breeding</p>	<b>Bird of conservation concern</b>
<p><b>Purple Sandpiper</b> <i>Calidris maritima</i>            Season: Wintering</p>	<b>Bird of conservation concern</b>
<p><b>Rusty Blackbird</b> <i>Euphagus carolinus</i>            Season: Wintering</p>	<b>Bird of conservation concern</b>
<p><b>Short-eared Owl</b> <i>Asio flammeus</i>            Season: Wintering  <a href="https://ecos.fws.gov/speciesProfile/profile/speciesProfile.action?spcode=B0HD">https://ecos.fws.gov/speciesProfile/profile/speciesProfile.action?spcode=B0HD</a></p>	<b>Bird of conservation concern</b>

**Upland Sandpiper** *Bartramia longicauda*

Season: Breeding

<https://ecos.fws.gov/speciesProfile/profile/speciesProfile.action?spcode=B0HC>

**Bird of conservation concern**

**Wood Thrush** *Hylocichla mustelina*

Season: Breeding

**Bird of conservation concern**

**Worm Eating Warbler** *Helmitheros vermivorum*

Season: Breeding

**Bird of conservation concern**

## Refuges

Any activity proposed on [National Wildlife Refuge](#) lands must undergo a 'Compatibility Determination' conducted by the Refuge. If your project overlaps or otherwise impacts a Refuge, please contact that Refuge to discuss the authorization process.

There are no refuges within this project area

# Wetlands

Impacts to [NWI wetlands](#) and other aquatic habitats from your project may be subject to regulation under Section 404 of the Clean Water Act, or other State/Federal Statutes.

Project proponents should discuss the relationship of these requirements to their project with the Regulatory Program of the appropriate [U.S. Army Corps of Engineers District](#).

## DATA LIMITATIONS

The Service's objective of mapping wetlands and deepwater habitats is to produce reconnaissance level information on the location, type and size of these resources. The maps are prepared from the analysis of high altitude imagery. Wetlands are identified based on vegetation, visible hydrology and geography. A margin of error is inherent in the use of imagery; thus, detailed on-the-ground inspection of any particular site may result in revision of the wetland boundaries or classification established through image analysis.

The accuracy of image interpretation depends on the quality of the imagery, the experience of the image analysts, the amount and quality of the collateral data and the amount of ground truth verification work conducted. Metadata should be consulted to determine the date of the source imagery used and any mapping problems.

Wetlands or other mapped features may have changed since the date of the imagery or field work. There may be occasional differences in polygon boundaries or classifications between the information depicted on the map and the actual conditions on site.

## DATA EXCLUSIONS

Certain wetland habitats are excluded from the National mapping program because of the limitations of aerial imagery as the primary data source used to detect wetlands. These habitats include seagrasses or submerged aquatic vegetation that are found in the intertidal and subtidal zones of estuaries and nearshore coastal waters. Some deepwater reef communities (coral or tubercid worm reefs) have also been excluded from the inventory. These habitats, because of their depth, go undetected by aerial imagery.

## DATA PRECAUTIONS

Federal, state, and local regulatory agencies with jurisdiction over wetlands may define and describe wetlands in a different manner than that used in this inventory. There is no attempt, in either the design or products of this inventory, to define the limits of proprietary jurisdiction of any Federal, state, or local government or to establish the geographical scope of the regulatory programs of government agencies. Persons intending to engage in activities involving modifications within or adjacent to wetland areas should seek the advice of appropriate federal, state, or local agencies concerning specified agency regulatory programs and proprietary jurisdictions that may affect such activities.

# Freshwater Forested/shrub Wetland

**PFO1E**

9.22 acres

**EFH Data Notice:** Essential Fish Habitat (EFH) is defined by textual descriptions contained in the fishery management plans developed by the regional Fishery Management Councils. In most cases mapping data can not fully represent the complexity of the habitats that make up EFH. This report should be used for general interest queries only and should not be interpreted as a definitive evaluation of EFH at this location. A location-specific evaluation of EFH for any official purposes must be performed by a regional expert. Please refer to the following links for the appropriate regional resources.



### Query Results

Map Scale = 1:72,224

Degrees, Minutes, Seconds: Latitude = 41°45'17" N, Longitude = 73°18'2" W

Decimal Degrees: Latitude = 41.75, Longitude = -72.70

The query location intersects with spatial data representing EFH and/or HAPCs for the following species/management units.

### HAPCs

No Habitat Areas of Particular Concern (HAPC) were identified at the report location.

### EFH Areas Protected from Fishing

No EFH Areas Protected from Fishing (EFHA) were identified at the report location.

## **Exhibit 2.D Planning**

- Exhibit 2.D.1 ISO-NE “Greater Hartford and Central Connecticut (GHCC) Area Transmission 2022 Needs Assessment,” May 2014, Redacted to secure Confidential Energy Infrastructure Information (CEII)**
- Exhibit 2.D.2 ISO-NE “Greater Hartford and Central Connecticut (GHCC) Area Transmission 2022 Solutions Study,” February 2015, Redacted to secure Confidential Energy Infrastructure Information (CEII)**
- Exhibit 2.D.3 ISO-NE “Transmission Planning Technical Guide,” December 2014**
- Exhibit 2.D.4 LEI Analysis of the Feasibility and Practicality of Non-Transmission Alternatives (“NTAs”) to the Greater Hartford/Central Connecticut Reliability Project (“GHCCRP”) August 31, 2015**



**Exhibit 2.D.1 ISO-NE “Greater Hartford and Central Connecticut (GHCC) Area Transmission 2022 Needs Assessment,” May 2014, Redacted to secure Confidential Energy Infrastructure Information (CEII)**





# Greater Hartford and Central Connecticut (GHCC) Area Transmission 2022 Needs Assessment

Greater Hartford and Central Connecticut Working Group  
(ISO New England, Northeast Utilities, and United Illuminating)

**REDACTED - PUBLIC VERSION**

© ISO New England Inc.  
May 2014



# Table of Contents

<b>Section 1 Executive Summary</b> .....	<b>9</b>
1.1 Objective .....	9
1.2 Method and Criteria.....	9
1.3 Study Assumptions.....	10
1.4 Design Case Specific Areas of Concern.....	11
1.4.1 Greater Hartford Subarea Thermal and Voltage Needs .....	11
1.4.2 Manchester – Barbour Hill Subarea Thermal and Voltage Needs.....	12
1.4.3 Middletown Subarea Thermal and Voltage Needs .....	12
1.4.4 Northwestern Connecticut Subarea Thermal and Voltage Needs.....	13
1.5 Statements of Need.....	14
<b>Section 2 Introduction and Background Information</b> .....	<b>15</b>
2.1 Study Objective .....	15
2.2 Areas Studied .....	15
2.3 Study Horizon.....	20
2.4 Analysis Description .....	20
<b>Section 3 Study Assumptions</b> .....	<b>21</b>
3.1 Steady State Model Assumptions.....	21
3.1.1 Study Assumptions .....	21
3.1.2 Source of Power Flow Models.....	21
3.1.3 Transmission Topology Changes.....	21
3.1.4 Generation Additions & Retirements.....	22
3.1.5 Explanation of Future Changes Not Included.....	23
3.1.6 Forecasted Load.....	24
3.1.7 Load Levels Studied .....	26
3.1.8 Load Power Factor Assumptions .....	27
3.1.9 Transfer Levels .....	27
3.1.10 Generation Dispatch Scenarios .....	28
3.1.11 Reactive Dispatch Assumptions .....	33
3.1.12 Demand Resources.....	33
3.1.13 Protection and Control System Devices Included in the Study Area.....	34
3.2 Stability Modeling Assumptions .....	36
3.3 Short Circuit Model.....	36
3.3.1 Study Assumptions .....	36
3.3.2 Short Circuit Model .....	36
3.3.3 Generation Additions and Retirements.....	37
3.3.4 Generation and Transmission System Configurations.....	37
3.3.5 Boundaries .....	37
3.3.6 Other Relevant Modeling Assumptions.....	37

<b>Section 4 Analysis Methodology .....</b>	<b>38</b>
4.1 Planning Standards and Criteria .....	38
4.2 Performance Criteria .....	38
4.2.1 Steady-state Criteria.....	38
4.2.2 Stability Performance Criteria .....	39
4.2.3 Short Circuit Performance Criteria .....	40
4.3 System Testing .....	40
4.3.1 System Conditions Tested.....	40
4.3.2 Steady-State Contingencies Tested.....	40
4.3.3 Use of Redispatch .....	41
4.3.4 Stability Contingencies Tested .....	42
4.3.5 Short Circuit Faults Tested .....	42
<b>Section 5 Results of Analysis .....</b>	<b>44</b>
5.1 Overview of Results .....	44
5.1.1 Greater Hartford Subarea Overview .....	44
5.1.2 Manchester - Barbour Hill Subarea Overview.....	49
5.1.3 Middletown Subarea Overview .....	51
5.1.4 Northwestern Connecticut Subarea Overview .....	53
5.2 Steady State Performance Criteria Compliance .....	54
5.2.1 Greater Hartford Subarea Steady-State Performance .....	55
5.2.2 Manchester and Barbour Hill Area Steady-State Performance.....	68
5.2.3 Middletown Subarea Steady-State Performance.....	72
5.2.4 Northwestern Connecticut Subarea Steady-State Performance .....	79
5.2.5 Discussion of the 690 SPS .....	89
5.2.6 Discussion of Western Connecticut Import .....	89
5.2.7 Extreme Contingency Testing.....	90
5.3 Stability Performance Criteria Compliance.....	90
5.3.1 Stability Test Results Summary.....	90
5.4 Short Circuit Performance Criteria Compliance .....	90
5.4.1 Short Circuit Test Results Summary.....	90
<b>Section 6 Critical Load Level Assessment .....</b>	<b>92</b>
6.1 Critical Load Level Methodology .....	92
6.2 Critical Contingency Pairs and Dispatches .....	92
6.3 Comparison of Critical Load Levels with CT Forecasted loads.....	92
6.4 Results of Critical Load Level Assessment.....	93
6.4.1 Greater Hartford Subarea.....	93
6.4.2 Manchester-Barbour Hill Subarea .....	95
6.4.3 Middletown Subarea .....	95
6.4.4 Northwestern Connecticut Subarea.....	96
<b>Section 7 Conclusions on Needs Analysis.....</b>	<b>98</b>

7.1 Statement of Needs.....	98
7.2 Critical Load Levels .....	99
7.2.1 Summary of Results for Greater Hartford Subarea.....	99
7.2.2 Summary of Results for Manchester-Barbour Hill Subarea .....	99
7.2.3 Summary of Results for Middletown Subarea.....	99
7.2.4 Summary of Results for Northwestern CT Subarea.....	99
<b>Section 8 Appendix A: Load Forecast .....</b>	<b>100</b>
<b>Section 9 Appendix B: Case Summaries .....</b>	<b>103</b>
<b>Section 10 Appendix C: Element Out for N-1-1 Analysis .....</b>	<b>104</b>
<b>Section 11 Appendix D: Contingency Listings.....</b>	<b>108</b>
11.1 GHCC Area NERC Category B Contingencies .....	108
11.2 GHCC Area NERC Category C Contingencies .....	111
11.3 GHCC Area Special Protection System and Automatic Control Scheme Contingencies .....	115
11.4 GHCC Area NERC Category D Contingencies .....	116
<b>Section 12 Appendix E: Steady State Testing Results .....</b>	<b>117</b>
<b>Section 13 Appendix F: Extreme Contingency Testing Results .....</b>	<b>118</b>
<b>Section 14 Appendix G: Short Circuit Testing Results .....</b>	<b>119</b>
<b>Section 15 Appendix H: Critical Load Level Assessment Testing .....</b>	<b>120</b>
15.1 Greater Hartford Subarea .....	120
15.2 Manchester-Barbour Hill Subarea.....	122
15.3 Middletown Subarea.....	123
15.4 Northwestern Connecticut Subarea .....	124
<b>Section 16 Appendix I: Critical Load Level Assessment Results.....</b>	<b>126</b>
<b>Section 17 Appendix J: Net Load in Connecticut Calculation .....</b>	<b>127</b>
<b>Section 18 Appendix K: NERC Compliance Statement .....</b>	<b>128</b>

# List of Figures

Figure 2-1: GHCC Study Area Map.....	17
Figure 2-2: GHCC Study Area One Line Diagram.....	18
Figure 2-3: Interfaces of Interest for the GHCC Study Area.....	19
Figure 3-1: Southington Substation.....	35
Figure 3-2: The 69 kV System in Northwestern Connecticut .....	36
Figure 4-1: Circuit Breaker Testing Parameters.....	43
Figure 5-1: An Overview of the Greater Hartford Subarea.....	45
Figure 5-2: South Meadow, Berlin and Southington Load Area.....	46
Figure 5-3: Farmington, Newington and East New Britain Load Pocket.....	47
Figure 5-4: North Bloomfield - Manchester Area.....	48
Figure 5-5: Southington substation and SWCT Import Interface.....	49
Figure 5-6: Barbour Hill Area Load Pocket .....	50
Figure 5-7: An Overview of the Middletown Subarea .....	52
Figure 5-8: Branford - Haddam Load Pocket.....	53
Figure 5-9: An Overview of the Northwestern Connecticut Subarea.....	54
Figure 5-10: N-1 Thermal Violations in the Greater Hartford Area .....	56
Figure 5-11: N-1 Voltage Violations in the Greater Hartford Area .....	58
Figure 5-12: N-1 Thermal Violations in the Greater Hartford Area .....	59
Figure 5-13: N-1-1 Thermal Violations in the South Meadow, Berlin and Southington Area .....	61
Figure 5-14: N-1-1 Thermal Violations in the North Bloomfield – Manchester Area.....	63
Figure 5-15: N-1-1 Thermal Violations in the Southington Area .....	65
Figure 5-16: N-1-1 Voltage Violations in the South Meadow, Berlin and Southington Load Area.....	67
Figure 5-17: N-1-1 Voltage Violations in the North Bloomfield – Manchester Load Area .....	68
Figure 5-18: N-1-1 Thermal Violations in the Manchester and Barbour Hill Area .....	70
Figure 5-19: N-1-1 Voltage Violations in the Manchester and Barbour Hill Area .....	72
Figure 5-20: N-1 Voltage Violations in the Middletown Subarea .....	73
Figure 5-21: N-1-1 Thermal Violations in the Middletown Subarea .....	76
Figure 5-22: N-1-1 Voltage Violations in the Middletown Subarea .....	79
Figure 5-23 N-0 Voltage Violations in the NWCT Subarea .....	80
Figure 5-24: N-1 Thermal Violations in the NWCT Subarea .....	81
Figure 5-25: N-1 Voltage Violations in the NWCT Subarea .....	83
Figure 5-26: N-1-1 Thermal Violations in the NWCT Subarea.....	85
Figure 5-27: N-1-1 Low-Voltage Violations in the NWCT Subarea .....	88



# List of Tables

Table 2-1: Towns Included in Study Area.....	16
Table 3-1: 2022 Passive DR Values: DR through FCA #7 and EE Forecast.....	25
Table 3-2: FCA #7: Active DR Values through FCA #7 .....	26
Table 3-3: Load Levels to be studied .....	27
Table 3-4: Qualified Generating Capacities of Study Area Units .....	28
Table 3-5: Dispatch of Hydro Units in Connecticut.....	30
Table 3-6: Two-Units-Out Generation Dispatches .....	32
Table 3-7: One-Unit-Out Generation Dispatches.....	33
Table 3-8: New England Demand Resource Performance Assumptions .....	34
Table 4-1: Steady-State Thermal Criteria.....	38
Table 4-2: Steady-State Voltage Criteria.....	39
Table 4-3: Study Solution Parameters.....	39
Table 4-4: Summary of NERC, NPCC and/or ISO-NE Category Contingencies to be Included.....	41
Table 4-5: Summary of N-1-1 First Element-Out Scenarios.....	41
Table 5-1: N-1 Thermal Violations in the Greater Hartford Area.....	56
Table 5-2: N-1 Voltage Violations in the Greater Hartford Subarea.....	57
Table 5-3: N-1-1 Thermal Violations in the South Meadow, Berlin and Southington Load Area.....	59
Table 5-4: N-1-1 Thermal Violations in the North Bloomfield – Manchester Load Area.....	62
Table 5-5: N-1-1 Thermal Violations in the Southington Area.....	64
Table 5-6: N-1-1 Voltage Violations in the South Meadow, Berlin and Southington Load Area .....	66
Table 5-7: N-1-1 Voltage Violations in the North Bloomfield – Manchester Load Area.....	67
Table 5-8: N-1-1 Thermal Violations in the Manchester and Barbour Hill Area.....	69
Table 5-9: N-1-1 Voltage Violations in the Manchester and Barbour Hill Area .....	71
Table 5-10: N-1 Voltage Violations in the Middletown Subarea.....	72
Table 5-11: N-1-1 Thermal Violations in the Middletown Subarea.....	74
Table 5-12: N-1-1 Voltage Violations in the Middletown Subarea .....	77
Table 5-13: N-0 Voltage Violations in the NWCT Subarea .....	79
Table 5-14: N-1 Thermal Violations in the NWCT Subarea.....	81
Table 5-15: N-1 Voltage Violations in the NWCT Subarea .....	82
Table 5-16: N-1-1 Thermal Violations in the NWCT Subarea .....	84
Table 5-17: N-1-1 Low-Voltage Violations in the NWCT Subarea.....	86
Table 5-18: N-1-1 Non-Convergence in the NWCT Subarea – Pre 690 SPS .....	89
Table 5-19: Summary of Circuit Breakers with Duties Greater than 90% of Interrupting Rating.....	91
Table 6-1: Projected Load in Connecticut 2013-2022 (Load – Available DR).....	93
Table 6-2: Greater Hartford Subarea Critical Load Levels for Thermal Violations .....	93

Table 6-3: Greater Hartford Subarea Critical Load Levels for Voltage Violations .....	94
Table 6-4: Manchester-Barbour Hill Subarea Critical Load Levels for Thermal Violations .....	95
Table 6-5: Manchester-Barbour Hill Subarea Critical Load Levels for Voltage Violations .....	95
Table 6-6: Middletown Subarea Critical Load Levels for Thermal Violations .....	95
Table 6-7: Middletown Subarea Critical Load Levels for Voltage Violations .....	96
Table 6-8: NWCT Subarea Critical Load Levels for Thermal Violations .....	96
Table 6-9: NWCT Subarea Critical Load Levels for Voltage Violations .....	97
Table 8-1: 2013 CELT Seasonal Peak Load Forecast Distributions .....	100
Table 8-2: 2022 Detailed Load Distributions by State and Company .....	101
Table 8-3: Detailed Demand Response Distributions by Zone .....	102
Table 10-1: N-1-1 First Element-Out Scenarios .....	104
Table 15-1: Greater Hartford Subarea Thermal Violations for Critical Load Levels Assessment .....	120
Table 15-2: Greater Hartford Subarea Voltage Violations for Critical Load Level Assessment .....	121
Table 15-3: Manchester-Barbour Hill Subarea Thermal Violations for Critical Load Level Assessment .....	122
Table 15-4: Manchester-Barbour Hill Subarea Voltage Violations for Critical Load Level Assessment .....	122
Table 15-5: Middletown Subarea Thermal Violations for Critical Load Level Assessment .....	123
Table 15-6: Middletown Subarea Voltage Violations for Critical Load Level Assessment .....	123
Table 15-7: Northwestern CT Subarea Thermal Violations for Critical Load Level Assessment .....	124
Table 15-8: Northwestern CT Subarea Voltage Violations for Critical Load Level Assessment .....	125
Table 17-1: Calculation of Net Load in Connecticut for Year of Need Calculation .....	127

# Section 1

## Executive Summary

### 1.1 Objective

---

The objective of the GHCC study was to evaluate the system needs in the Greater Hartford and Central Connecticut (GHCC) study area and to reassess the needs which drove the Central Connecticut Reliability Project (CCRP), while considering the following:

- Future load growth
- Reliability over a range of generation patterns and transfer levels
- All applicable North American Electric Reliability Corporation (NERC), Northeast Power Coordinating Corporation (NPCC) and ISO New England transmission planning reliability standards
- Regional and local reliability issues
- New England East-West Solution (NEEWS) project, and
- Existing and planned supply resources and demand resources

The scope of the Needs Assessment study performed for the GHCC area included evaluation of the reliability performance of the transmission system serving this area of New England for the year 2022 projected system conditions. The system was tested with all elements in-service i.e. N-0 and under N-1 and N-1-1 contingency conditions for a number of possible operating conditions with respect to related interface transfer levels and generating unit availability conditions.

As described in this report, the Needs Assessment identified certain areas of the system that failed to meet North American Electric Reliability Corporation (NERC), Northeast Power Coordinating Council (NPCC), Independent System Operator of New England Inc. (ISO-NE), and Transmission Owner standards and criteria.

This Needs Assessment was the first step in the study process defined in accordance with the Regional Planning Process as outlined in Attachment K to the ISO-NE Open Access Transmission Tariff (OATT). In accordance with Attachment K, a Solutions Study will be conducted to develop and analyze potential transmission solutions for the needs identified in this analysis.

A working group led by ISO-NE, and consisting of members from ISO-NE, Northeast Utilities (NU), and United Illuminating (UI), was formed to study the Greater Hartford and Central Connecticut transmission system. As part of the Planning Advisory Committee (PAC) process, stakeholders, which include generator owners, suppliers, load serving entities, energy efficiency entities, state regulators, and transmission owners, also provided input throughout the study process.

### 1.2 Method and Criteria

---

The Needs Assessment was performed in accordance with NERC TPL-001, TPL-002 and TPL-003 Transmission System Standards, NPCC Directory<sup>1</sup>, “Design and Operation of the Bulk Power System,” the ISO New England Planning Procedure 3, “Reliability Standards for the New England

Area Bulk Power Supply System,” the ISO New England Planning Procedure 5-3, “Guidelines for Conducting and Evaluating Proposed Plan Application Analyses”.

### **1.3 Study Assumptions**

---

A long-term (ten-year) planning horizon was used for this study based on the most recently available Capacity, Energy, Loads, and Transmission (CELT) forecast data (2013) at the time the study began. This study was focused on the projected 2022 peak demand load levels for the ten-year horizon. The models reflected the following peak load conditions:

**Loads:**

The summer peak 90/10 load level forecast is 34,105 MW for all of New England and 8,825 MW (which represents 26% of the New England load) for the state of Connecticut

**Transmission Topology:**

All relevant transmission projects with Proposed Plan Application (PPA) approval have been included in the study base case. Section 3.1.3 includes a full listing and description of all projects included.

**Generation:**

All generation projects with a Capacity Supply Obligation as of Forward Capacity Auction 7 (FCA #7) were included in the study base case. Section 3.1.4 of this report includes a full listing and description of generation included in the base case. Due to the submission of Non-Price Retirement (NPR) Requests for the Bridgeport Harbor 2 and Norwalk Harbor units for FCA #8, these units have been taken out-of-service (OOS) in the base case.

**Demand Resource Assumptions:**

Demand Resources (active and passive) were modeled based on the Demand Resources (DR) cleared in FCA #7. In addition, any accepted NPR requests for DR and any DR terminations in Connecticut for FCA #8 were also taken into account. Finally, the energy efficiency forecast for the years corresponding to FCA #8 and beyond until 2022 were also modeled based on the 2013 energy efficiency (EE) forecast. Section 3.1.6 includes the details of the demand resources considered for this study.

Section 3 of this report contains more details of all assumptions used to complete this study.

The following types of analyses were performed as part of this study:

- **Steady-State Thermal and Voltage Analysis** – steady-state analysis was performed to determine the level of steady-state power flows on transmission circuits and voltage levels and performance on transmission buses for a variety of one and two-unit-out generation dispatches and inter-regional stresses, for N-0 (All-facilities-in) conditions as well as following contingency events for N-1 (all-facilities-in, first contingency) and N-1-1 (facility-out, first contingency) conditions.
- **Extreme Contingency Analysis** – limited steady-state analysis was performed to evaluate the severity of the impact of NERC Category D Transmission Planning System Standard 004 (TPL-

004)<sup>1</sup> extreme contingencies on transmission system performance. A thermal or voltage violation arising from this analysis may not necessarily demonstrate a reliability need in the study area; as such, this analysis was performed for informational purposes only.

- **Short Circuit Analysis** – a study to determine the ability of substation equipment to withstand and interrupt fault current was also conducted.

## **1.4 Design Case Specific Areas of Concern**

---

While the results of the short circuit analysis indicated that there were no over-dutied substation breakers in the GHCC area, the results of the steady state thermal and voltage analysis indicated that many thermal and voltage issues exist on facilities in each of the subareas comprising the GHCC study area. The results for each study subarea are summarized in the following sub-sections. Each subsection summarizes the number of thermal and voltage violations observed and provides the Connecticut load level at which these violations would be resolved. The Connecticut load numbers provided exclude transmission losses, and include the impact of demand resources. Details on how the net Connecticut loads were obtained are provided in Appendix J: Net Load in Connecticut Calculation.


### **1.4.1 Greater Hartford Subarea Thermal and Voltage Needs**

The Greater Hartford subarea net load for 2022 after demand resources are subtracted is about 1,227 MW. This subarea is a net importer of energy and relies on the surrounding areas to serve local load.

The Greater Hartford subarea had four transmission elements with N-1 thermal violations and four 115 kV buses with N-1 low-voltage violations. Under N-1-1 conditions, there were 27 elements with thermal violations and ten 115 kV PTF buses with low-voltage violations. Two 115 kV non-PTF buses also had low voltages. There were no N-0 violations.

The N-1-1 violations have been grouped into the following three areas:

- South Meadow – Berlin – Southington Area
- North Bloomfield – Manchester Area
- Southington Area

 See Sections 5.1.1 and 5.2.1 for a full discussion of this subarea and its load pockets.

The majority of the worst-case violations in the Greater Hartford subarea are expected to be seen at expected summer peak load levels before 2013. The net Connecticut load at which all thermal violations would be resolved is 4,756 MW and the net Connecticut load at which all voltage violations would be resolved is 4,319 MW. The details of the critical load level analysis are available in Section 6.4.1.

---

<sup>1</sup> Transmission Planning (TPL) System Standard 004: System Performance Following Extreme Events Resulting in the Loss of Two or More Bulk Electric System Elements (Category D), published February 2005; available at <http://www.nerc.com/files/TPL-004-0.pdf>.

### **1.4.2 Manchester – Barbour Hill Subarea Thermal and Voltage Needs**

The Manchester-Barbour Hill subarea net load for 2022 after demand resources are subtracted is about 452 MW. This sub-area is a net importer of energy and relies on the surrounding areas to serve local load.

Within the Manchester-Barbour Hill subarea, there is a smaller Barbour Hill load pocket that consists of five 115 kV substations with net load of about 326 MW.

The Manchester and Barbour Hill Area had five transmission elements with N-1-1 thermal violations and two 115 kV PTF buses with N-1-1 low voltage violations. Additionally, there were four non-PTF buses with N-1-1 voltage violations. There were no N-0 or N-1 steady-state criteria violations.

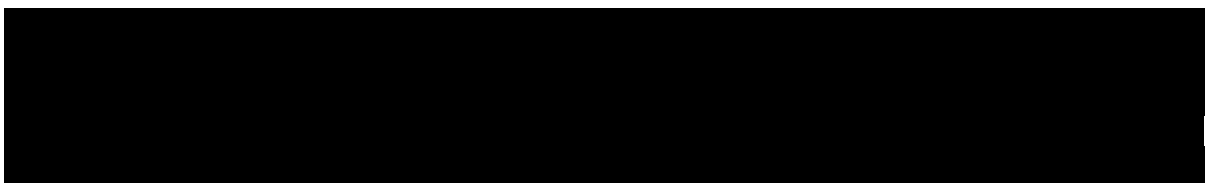
  
See Sections 5.1.2 and 5.2.2 for a full discussion of this subarea.

The majority of the worst-case violations in the Manchester-Barbour Hill subarea are expected to be seen at expected summer peak load levels before 2013. The net Connecticut load at which all thermal violations would be resolved is 5,616 MW and the net Connecticut load at which all the PTF voltage violations would be resolved is 5,069 MW. The details of the critical load level analysis are available in Section 6.4.2.

### **1.4.3 Middletown Subarea Thermal and Voltage Needs**

The Middletown subarea net load for 2022 after demand resources are subtracted is about 656 MW. This subarea depends on the surrounding areas to serve the local load, but unlike the other subareas does have significant local generation that reduces the need for import capability when all units are available.

The Middletown subarea had no N-1 thermal violations and three 115 kV buses with N-1 low voltage violations. Under N-1-1 conditions, there were 11 elements with thermal violations and fourteen 115 kV buses with low voltage violations. There were no N-0 violations.

  
See Sections 5.1.3 and 5.2.3 for a full discussion of this subarea.

The majority of the worst-case violations in the Middletown subarea are expected to be seen at expected summer peak load levels before 2013. The net Connecticut load at which all thermal violations would be resolved is 3,444 MW and the net Connecticut load at which all voltage violations would be resolved is 3,694 MW. The details of the critical load level analysis are available in Section 6.4.3.

#### **1.4.4 Northwestern Connecticut Subarea Thermal and Voltage Needs**

The Northwestern Connecticut (NWCT) subarea net load for 2022 after demand resources are subtracted is about 511 MW. This subarea is a net importer of energy and relies on the surrounding areas to serve local load.

The NWCT subarea had no N-0 thermal violations, but one 69 kV non-PTF bus had an N-0 basecase voltage violation. There were three transmission elements with N-1 thermal violations and five PTF buses with N-1 low-voltage violations. Two non-PTF buses had N-1 voltage violations. Under N-1-1 conditions, there were ten elements with thermal violations and twelve PTF buses with low voltage violations. Two non-PTF buses had N-1-1 voltage violations. See Sections 5.1.4 and 5.2.4 for a full discussion of this subarea.

The majority of the worst-case violations in the Northwestern Connecticut subarea are expected to be seen at expected summer peak load levels before 2013. The net Connecticut load at which all thermal violations would be resolved is 4,225 MW and the net Connecticut load at which all voltage violations would be resolved is 5,694 MW. The details of the critical load level analysis are available in Section 6.4.4.

## 1.5 Statements of Need

---

All the criteria violations observed in the Greater Hartford and Central Connecticut (GHCC) area were based on steady state thermal and voltage testing. The following summarizes the needs for each subarea:

### Greater Hartford Subarea

- Need to resolve N-1 and N-1-1 criteria violations observed in the Greater Hartford area
- Thermal and voltage violations observed in the following areas:
  - North Bloomfield to Manchester area
  - South Meadow – Berlin – Southington area
  - Southington area

### Middletown Subarea:

- Need to resolve the N-1 and N-1-1 criteria violations observed in the Middletown area

### Manchester – Barbour Hill Subarea

- Need to resolve the N-1-1 criteria violations observed in serving load in the Manchester-Barbour Hill area

### Northwestern Connecticut Subarea:

- Need to resolve N-1 and N-1-1 criteria violations observed in serving load in the Northwest Connecticut area

### Western Connecticut Interface:

- Need to resolve N-1-1 criteria violations observed
- The needs are interrelated with the needs in the four subareas listed above



# Section 2

## Introduction and Background Information

### 2.1 Study Objective

---

The objective of the GHCC study was to evaluate the system needs in the Greater Hartford and Central Connecticut (GHCC) study area and to reassess the needs which drove the Central Connecticut Reliability Project (CCRP), while considering the following:

- Future load growth
- Reliability over a range of generation patterns and transfer levels
- All NERC, NPCC and ISO New England applicable transmission planning reliability standards
- Regional and local reliability issues
- New England East-West Solution (NEEWS) project, and
- Existing and planned supply resources and demand resources

The scope of the Needs Assessment study performed for the GHCC area included evaluation of the reliability performance of the transmission system serving this area of New England for the year 2022 projected system conditions. The system was tested with all elements in-service i.e. N-0 and under N-1 and N-1-1 contingency conditions for a number of possible operating conditions with respect to related interface transfer levels and generating unit availability conditions.

This Needs Assessment was the first step in the study process defined in accordance with the Regional Planning Process as outlined in Attachment K to the ISO-NE Open Access Transmission Tariff (OATT). In accordance with Attachment K, a Solutions Study will be conducted to develop and analyze potential transmission solutions for the needs identified in this analysis.

A working group led by ISO-NE, and consisting of members from ISO-NE, Northeast Utilities (NU), and United Illuminating (UI), was formed to study the Greater Hartford and Central Connecticut transmission system. As part of the Planning Advisory Committee (PAC) process, stakeholders, which include generator owners, suppliers, load serving entities, energy efficiency entities, state regulators, and transmission owners, also provided input throughout the study process.

### 2.2 Areas Studied

---

In this study, the GHCC area has been divided into the following four subareas:

1. Greater Hartford
2. Northwest Connecticut
3. Middletown, and
4. Manchester - Barbour Hill

Table 2-1 summarizes the towns included in each of the subareas:

**Table 2-1:  
Towns Included in Study Area**

Subarea	Towns in the Subarea <i>(Note: Location of towns may not dictate where load is served)</i>
<b>Greater Hartford</b>	Avon, Berlin, Bloomfield, Burlington, Cromwell, East Granby, East Hartford, Farmington, Granby, Hartford, New Britain, Newington, Plainville, Rocky Hill, West Hartford, Wethersfield, Windsor
<b>Northwest Connecticut</b>	Barkhamsted, Bethlehem, Bristol, Canaan, Canton, Colebrook, Cornwall, Goshen, Hartland, Harwinton, Kent, Litchfield, Morris, New Hartford, Norfolk, North Canaan, Plymouth, Salisbury, Sharon, Simsbury, Thomaston, Torrington, Warren, Washington, Winchester
<b>Middletown</b>	Chester, Clinton, Colchester, Deep River, Durham, East Haddam, East Hampton, Essex, Guilford, Haddam, Hebron, Killingworth, Lyme, Madison, Marlborough, Meriden, Middlefield, Middletown, Old Lyme, Old Saybrook, Portland, Wallingford, Westbrook
<b>Manchester - Barbour Hill</b>	Bolton, East Windsor, Ellington, Enfield, Glastonbury, Manchester, Somers, South Windsor, Suffield, Tolland, Vernon, Windsor Locks

Figure 2-1 shows the geographic map of the study area and Figure 2-2 shows the one-line diagram for the study area. Each of the figures has the four study subareas delineated.

It should be noted that the Scitico substation, while geographically located within the state of CT and in the Manchester/Barbour Hill area, is fed by 115 kV lines from the Springfield area. Since the Scitico substation is not fed from the Manchester/Barbour Hill area transmission facilities the study of the transmission system around the Scitico substation is excluded from the study area.

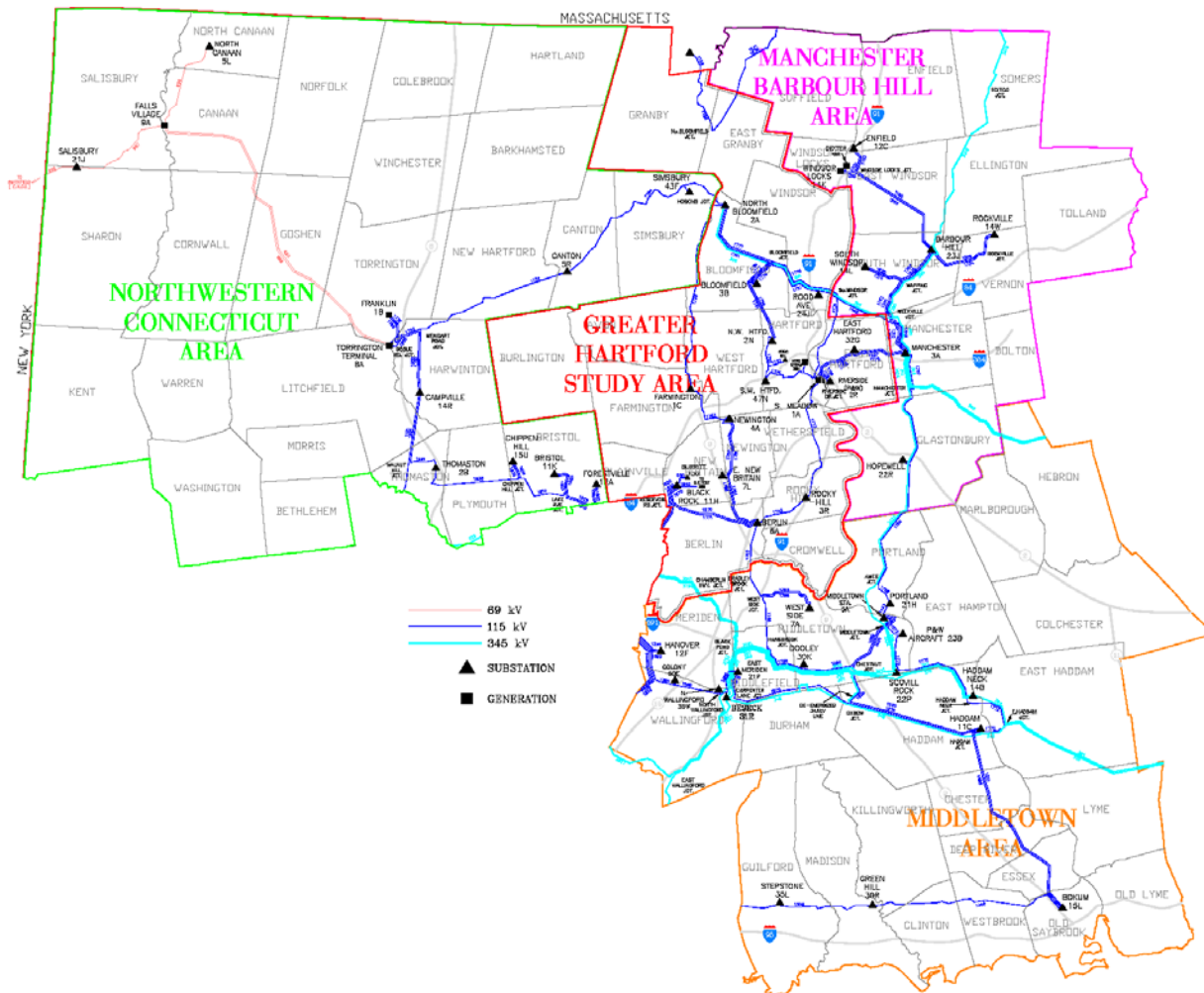
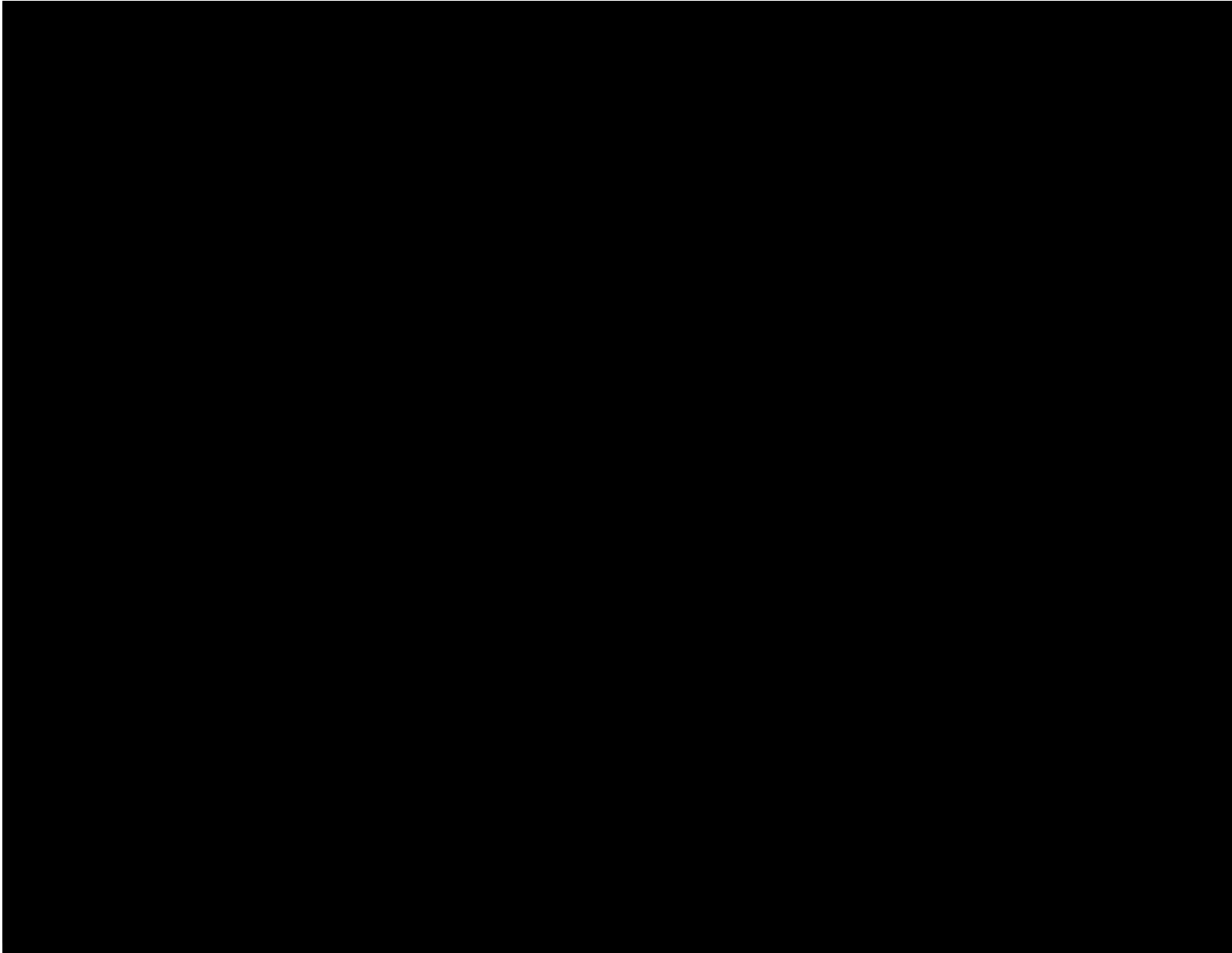


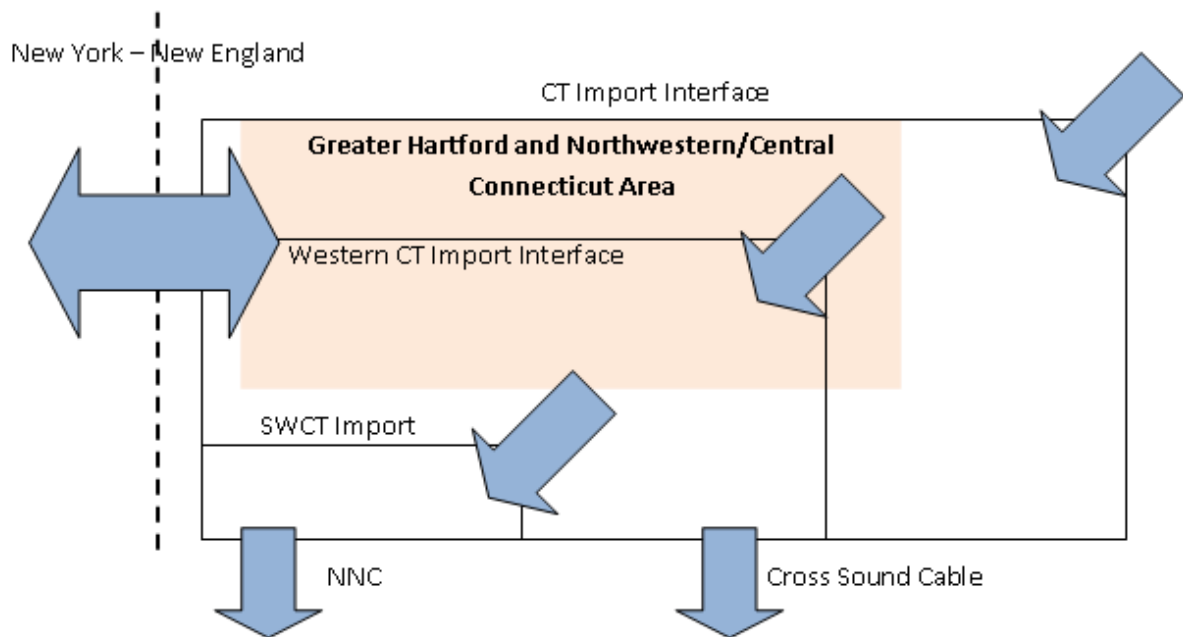
Figure 2-1: GHCC Study Area Map<sup>2</sup>

<sup>2</sup> The diagram is for illustrative purposes to show the study area. In the Manchester – Barbour Hill area, the Scitico substation is supplied from western Massachusetts but serves load in Connecticut. The Scitico station and the load fed from it has been excluded from the study



**Figure 2-2: GHCC Study Area One Line Diagram**

The GHCC study area is located between the Connecticut Import interface and the Southwest Connecticut (SWCT) import interface, while only parts of the study area are within the Western Connecticut import area. In addition to the above interfaces the export/import levels to/from New York through the AC ties, the Cross Sound Cable (CSC), and the Norwalk Northport Cable (NNC) also affect the study area. Figure 2-3 shows the interfaces impacting the study area.



**Figure 2-3: Interfaces of Interest for the GHCC Study Area**

The New England East-West Solution (NEEWS) project received its Proposed Plan Application (PPA) approval in 2008 and was revised and re-approved in 2012. Since the first approval, a significant amount of new resources have been procured in Connecticut via the Forward Capacity Market (FCM). With the addition of these new resources an updated transmission-based needs analysis for the NEEWS transmission project was required. Three of the four components of NEEWS, Greater Springfield Reliability Project (GSRP), the Rhode Island Reliability Project (RIRP), and the Interstate Reliability Project (IRP) have had their needs re-affirmed. In 2010, it was determined that an updated Needs Assessment of the fourth major component of NEEWS – the Central Connecticut Reliability Project would be conducted as part of the GHCC study. CCRP, as originally designed, would add a new 345 kV line to the Western CT import interface, which lies entirely within the GHCC study area.

Some of the highest criteria violations that were seen on 115 kV lines in the Greater Hartford area in preliminary analyses were also observed in the western Connecticut import analysis as part of the preliminary CCRP reassessment. Accordingly, the GHCC analysis was expanded to identify needs for both local reliability issues and western Connecticut import requirements, with the expectation that both sets of needs could be addressed by a single integrated solution. This determination was based on the fact that recent changes in assumptions that included new generation and demand resources were expected to significantly reduce the need for increased western Connecticut import. This assessment considers both local load serving needs and the need for additional western Connecticut import capacity. However, the needs results are presented by geographic location of the element with a thermal or voltage violation and are not separated based on local load serving needs and the need for additional western Connecticut import capability.

## 2.3 Study Horizon

---

This study was initiated in 2012 with a 10-year look ahead at the projected 2022 peak demand load level. The loads are based on the most recent CELT report, issued in May 2013.

## 2.4 Analysis Description

---

The study included the evaluation of the reliability of the transmission system serving the GHCC study area, including the transmission facilities that are part of the Western Connecticut Import Interface for the projected system conditions in 2022. The system was tested under N-0 (all-facilities-in), N-1 (all-facilities-in, first contingency), and N-1-1 (facility-out, first contingency) conditions for a number of possible operating scenarios with respect to related interface transfer levels and generating unit unavailability conditions.

The following types of analysis were performed:

- **Thermal Analysis** – studies to determine the level of steady-state power flows on transmission circuits under base case conditions and following contingency events.
- **Voltage Analysis** – studies to determine steady-state voltage levels and performance under base case conditions and following contingency events.
- **Extreme Contingency** – limited steady-state studies to evaluate the severity of the impact of NERC Category D Transmission Planning System Standard 004 (TPL-004)<sup>3</sup> extreme contingencies on transmission system performance. A thermal or voltage violation arising from this analysis may not necessarily demonstrate a reliability need in the study area.
- **Short Circuit Analysis** – studies to determine the ability of substation equipment to withstand and interrupt fault current.

For the various elements having thermal violations and for buses with voltage violations, a critical load level assessment was performed to determine the Connecticut load level at which these violations would be eliminated.

The following analyses may be performed during the solutions study phase:

- **Stability Analysis** – detailed studies to determine if any substations would be classified as BPS<sup>4</sup> (Bulk Power System) elements with the addition of the proposed solutions.

The Needs Assessment was performed in accordance with relevant NERC, NPCC, ISO-NE criteria as described in Section 4.2.1.

The thermal and voltage analysis was performed using Siemens PTI PSS/E version 32 and PowerGEM TARA version 710. The short circuit analysis was performed using ASPEN.

---

<sup>3</sup> Transmission Planning (TPL) System Standard 004: System Performance Following Extreme Events Resulting in the Loss of Two or More Bulk Electric System Elements (Category D), published February 2005; available at <http://www.nerc.com/files/TPL-004-0.pdf>.

<sup>4</sup> In accordance with NPCC document A-10: Classification of Bulk Power System Elements (<https://www.npcc.org/Standards/Criteria/A-10-Revised%20Full%20Member%20Approved%20December%2001.%202009%20GJD.pdf>)

# Section 3 Study Assumptions

## 3.1 Steady State Model Assumptions

---

### 3.1.1 Study Assumptions

The regional steady-state model was developed to be representative of the 10-year projection of the 90/10 summer peak system demand levels to assess reliability performance under stressed system conditions. The assumptions included consideration of area generation unit unavailability conditions as well as variations in surrounding area regional interface transfer levels. These study assumptions are consistent with ISO-NE Planning Procedure No. 3 (PP 3), “Reliability Standards for the New England Area Bulk Power Supply System”.

### 3.1.2 Source of Power Flow Models

The power flow study cases used in this study were obtained from the ISO-NE Model on Demand system with selected upgrades to reflect the system conditions in 2022. A detailed description of the system upgrades included is provided in later sections of this report.

### 3.1.3 Transmission Topology Changes

Transmission projects with Proposed Plan Application (PPA) approval in accordance with Section I.3.9 of the Tariff, as of the April 2011 RSP Project Listing, have been included in the study base case. New projects in Connecticut that were relevant to the study area were added to the base cases as of the October 2013 project listing. Projects outside of Connecticut that were added to the project listing were deemed to not have a significant impact on the study area and were excluded. Therefore, no updates were made to the base cases since the April 2011 update outside of Connecticut. A listing of the major projects is included below.

#### Maine

- Maine Power Reliability Program (MPRP) (RSP ID: 905-909, 1025-1030, 1158)
- Down East Reliability Improvement (RSP ID: 143)

#### New Hampshire

- Second Deerfield 345/115 kV Autotransformer Project (RSP ID: 277, 1137-1141)

#### Vermont

- Northwest Vermont Reliability Projects (RSP ID: 139)
- Vermont Southern Loop Project (RSP ID: 323, 1032-1035)

#### Massachusetts

- Auburn Area Transmission System Upgrades (RSP ID: 59, 887, 921, 919)
- Merrimack Valley / North Shore Reliability Project (RSP ID: 775-776, 782-783, 840)
- Long Term Lower SEMA Upgrades (RSP ID: 592, 1068, 1118)
- Central/Western Massachusetts Upgrades (RSP ID: 924- 929, 931-932, 934-935, 937- 950, 952- 955)
- NEEWS – Greater Springfield Reliability Project (RSP ID: 196, 259, 687-688, 818-820, 823, 826, 828-829, 1010, 1070-1075, 1078-1080, 1100-1105)
- NEEWS – Interstate Reliability Project (RSP ID: 1094,1202)

## **Rhode Island**

- Greater Rhode Island Transmission Reinforcements (RSP ID: 484, 786, 788, 790-793, 913-918, 1098)
- NEEWS – Rhode Island Reliability Project (RSP ID: 795, 798-800, 1096-1097, 1099, 1106, 1109)
- NEEWS – Interstate Reliability Project (RSP ID: 190, 794, 1095, 1233-1234)

## **Connecticut**

- NEEWS – Greater Springfield Reliability Project (RSP ID: 816, 1054, 1092)
- NEEWS – Interstate Reliability Project (RSP ID: 191, 802, 810, 1085, 1090-1091, 1235)
- Northeast Simsbury Substation 115 kV Circuit Breaker Project (RSP ID: 1230)
- Advanced NEEWS Projects – (RSP ID:1370,1235,1245)
- SWCT Minimum Load Project – Haddam Neck 150 MVAR Shunt Reactor (RSP ID:1400)

For the GSRP, RIRP and IRP components of NEEWS the model reflects the revised PPA that received ISO-NE approval in May 2012. An upgrade that would impact the GHCC study area is the re-conductoring of the 1784 line between North Bloomfield and Northeast Simsbury and the replacement of the 2% reactor on this line at North Bloomfield with a reactor of equal impedance but higher thermal rating.

Several upgrades in the SWCT area have received PPA approval since these basecases were created, but since the Southwest Connecticut working group is reassessing the needs and solutions for that area those upgrades were not included. The only upgrade from the SWCT area that is approved and not under reassessment that was included was the Haddam Neck shunt reactor.

The Central Connecticut Reliability Project (CCRP) component of the NEEWS projects was also excluded since as a part of the GHCC Needs Assessment the needs for these upgrades were reassessed.

In addition to the new transmission projects in Connecticut that were added during the Needs Assessment, any changes to element ratings or impedances as a part of the base case update process were captured on an ongoing basis. These upgrades may have varied some of the line ratings or impedances to reflect the most accurate future system condition. A significant change in this area was the replacement of the Torrington 115/69 kV autotransformer in December 2013.

Eight transmission substation buses in the GHCC study area are arranged as ring buses. Under contingency conditions, a large amount of power could flow through the bus and the traditional model of buses in the basecases would not capture these flows. The updated analysis completed in this Needs Assessment report accurately captured the modeling of these ring buses and reports violations on any of the bus elements that were seen under contingency conditions.

### **3.1.4 Generation Additions & Retirements**

Generation projects with a FCM Capacity Supply Obligation as of Forward Capacity Auction 7 (FCA #7) were included in the study base case. A listing of the recent major new projects cleared in FCA #1 through FCA #7 is included below.

## **Maine**

- QP 244 – Wind Project (FCA #4)

## **New Hampshire**

- QP 251 – Biomass Project (FCA #4)



- QP 307 – Biomass Project (FCA #4)

#### **Massachusetts**

- QP 089 – Cape Wind Turbine Generators (FCA #7)
- QP 196 – Northfield Mountain Uprate 88 MW (FCA #4, #6 and #7)
- QP 387-2 – Combined Cycle Unit (FCA #7)

#### **Rhode Island**

- QP 332 – RISEP Increase (FCA #5)

#### **Connecticut**

- QP 155.6 – Fuel Cell Project in Fairfield, CT (FCA #4)
- QP 289 – Fuel Cell Project in New Haven County, CT (FCA #4)

In March 2012, the Ansonia generation unit (QP-193) withdrew its PPA. As a result the Ansonia generation has been removed from the case. The generator had previously cleared in FCA #2.

During FCA #4, FCA #5, FCA #6, and FCA #7, a dynamic delist was submitted for Bridgeport Harbor 2 for the commitment periods of June 2013 – May 2014, June 2014 – May 2015, June 2015 – May 2016, and June 2016 – May 2017. Subsequently, on September 16, 2013 a full Non-Price Retirement (NPR) Request for this resource was submitted for FCA #8. Following a reliability review by ISO-NE, the NPR request was accepted on October 16, 2013. As a result, for this study, the Bridgeport Harbor 2 unit was assumed OOS as a base case condition.

Additionally, during FCA #5 and FCA #6 a dynamic delist bid was submitted for the AES Thames unit for the commitment periods of June 2014 – May 2015 and June 2015 – May 2016. Subsequently, on September 18, 2012, a Non-Price Retirement Request was submitted for this resource; following a reliability review by ISO-NE, the Non-Price Retirement Request was accepted on November 13, 2012. For this study, the AES Thames unit was assumed OOS as a base case condition.

On September 30, 2013 a Non-Price Retirement request for Norwalk Station (Norwalk 1, 2 and 10) was submitted for the FCA #8 commitment period. The NPR request was accepted on December 20, 2013. As a result, the Norwalk Station was assumed out-of-service as a base condition.

Real Time Emergency Generation (RTEG) represents distributed generation facilities which have air permit restrictions that limit their operations to OP 4, Action 6 – an emergency action which also implements voltage reductions of five percent (5%) of normal operating voltage that require more than 10 minutes to implement. The impact of RTEG was not included in this analysis because in general, long-term analyses should not be performed such that the system must be in an emergency state as required for the implementation of OP 4, Action 6.

### **3.1.5 Explanation of Future Changes Not Included**

The following projects were not added:

- Transmission projects that have not been fully developed and have not received PPA approval as of the April 2011 RSP Project Listing. These projects were not modeled in the study base case due to the uncertainty concerning their final development or lack of an impact on the GHCC study area.
- Transmission Projects that have been added to the project listing since the April 2011 project listing update, but do not have a significant impact on the study area

Additionally, the NEEWS – Central Connecticut Reliability Project component has PPA approval but was not included in the base case because the scope of this study includes the re-assessment of the transmission reliability needs for this component.

### **3.1.6 Forecasted Load**

A ten-year planning horizon was used for this study based on the most recently available CELT report issued in May 2013. This study focused on the projected 2022 peak demand load levels for the ten-year horizon.

The 2022 summer peak 90/10 demand forecast for New England is 34,105 MW.

The CELT load forecast includes both system demand and losses (transmission and distribution) from the power system. The power flow modeling programs have the transmission system explicitly modeled and hence the losses on the transmission system are calculated by the software. Therefore, the actual system load modeled in the case was reduced to account for transmission system losses which are explicitly calculated in the system model. Load distributions in the case are based on the most recent 2013 MMWG case library data.

Demand Resources (DR) are treated as capacity resources in the Forward Capacity Auctions (FCA). DR is split into two major categories, Passive and Active DR. Passive DR is largely comprised of energy efficiency and is expected to lower the system demand during designated peak hours in the summer and winter. Active DR is commonly known as Demand Side Management (DSM) and can be dispatched on a zonal basis if a forecasted or real-time capacity shortage occurs on the system. Starting in 2012, forecasting passive DR has become part of the annual load forecasting process. This forecast takes into account additional electrical efficiency (EE) savings beyond FCM results across the ten-year planning horizon. This forecast is primarily based on forecasted financial investment in state-sponsored EE programs and its correlation with historical data on reduction in peak demand per dollar spent. This EE forecast was published in the annual CELT Report beginning in spring 2012. Active DR are modeled in the base case at the levels of the most recent Forward Capacity Auction (FCA #7), multiplied by a Performance Factor of 75% based on historical performance of similar resources. Passive DR are modeled at 2022 levels based on the passive DR cleared through FCA #7 (2010-2016) and the aforementioned EE forecast for the years until 2022 (2017-2022). In addition, Active and Passive DR levels in Connecticut were scaled down to account for the submission of several Non-Price Retirement Requests for FCA #8 and DR terminations post-FCA #7.

Starting in 2010, DR values are now published in the CELT Report. Because DR are modeled at the low-side of the distribution bus in the power-flow model, all DR values were increased by 5.5% to account for the reduction in losses on the local distribution network. Passive DR are modeled by load zone and Active DR are modeled by dispatch zone. The amounts modeled in the cases are listed in Table 3-1 and Table 3-2 and detailed reports can be seen in Table 8-3 in Appendix A: Load Forecast.

**Table 3-1:  
2022 Passive DR Values: DR through FCA #7 and EE Forecast**

<b>Load Zone</b>	<b>Passive DR (FCA-1-7) DRV<sup>5</sup> (MW)</b>	<b>Passive DR Terminations DRV<sup>5</sup> (MW)</b>	<b>Passive DR NPR DRV<sup>5</sup> (MW)</b>	<b>EE Forecast (2017-2022) DRV (MW)</b>	<b>Total Passive DR DRV (MW)</b>
<b>Maine</b>	159	Not Included	Not Included	56	215
<b>New Hampshire</b>	80	Not Included	Not Included	53	133
<b>Vermont</b>	125	Not Included	Not Included	89	214
<b>Northeast Massachusetts &amp; Boston</b>	341	Not Included	Not Included	276	617
<b>Southeast Massachusetts</b>	194	Not Included	Not Included	147	341
<b>West Central Massachusetts</b>	245	Not Included	Not Included	165	410
<b>Rhode Island</b>	142	Not Included	Not Included	114	256
<b>Connecticut</b>	417	-25	-8	139	523
<b>New England Total</b>	1,703	-25	-8	1,039	2,709

<sup>5</sup> DRV = Demand Reduction Value = the actual amount of load reduced measured at the customer meter; these totals are forecasted values for the commitment period beginning June 1, 2022. These values exclude transmission and distribution losses.

**Table 3-2:  
FCA #7: Active DR Values through FCA #7**

Dispatch Zone	Active DR (FCA-1-7) DRV <sup>6</sup> (MW) (Includes DR terminations in CT)	Active DR NPR DRV <sup>5</sup> (MW)	Total Active DR DRV (MW)
<b>Bangor Hydro</b>	56	Not Included	56
<b>Maine</b>	207	Not Included	207
<b>Portland, ME</b>	32	Not Included	32
<b>New Hampshire</b>	49	Not Included	49
<b>New Hampshire Seacoast</b>	12	Not Included	12
<b>Northwest Vermont</b>	38	Not Included	38
<b>Vermont</b>	25	Not Included	25
<b>Boston, MA</b>	81	Not Included	81
<b>North Shore Massachusetts</b>	36	Not Included	36
<b>Central Massachusetts</b>	51	Not Included	51
<b>Springfield, MA</b>	33	Not Included	33
<b>Western Massachusetts</b>	78	Not Included	78
<b>Lower Southeast Massachusetts</b>	20	Not Included	20
<b>Southeast Massachusetts</b>	121	Not Included	121
<b>Rhode Island</b>	74	Not Included	74
<b>Eastern Connecticut</b>	49	-12	37
<b>Northern Connecticut</b>	100	-16	84
<b>Norwalk-Stamford, Connecticut</b>	37	-3	34
<b>Western Connecticut</b>	117	-13	104
<b>New England Total</b>	1,216	-44	1,171

### 3.1.7 Load Levels Studied

Consistent with ISO-NE planning practices, transmission planning studies utilize the ISO-NE extreme weather 90/10 forecast assumptions for modeling summer peak load profiles in New England. A state-by-state summary of the load modeled in the 2022 cases, taking into account transmission and distribution losses, is shown in Table 3-3. A more detailed report of the loads modeled and how the numbers were derived from the CELT values can be seen in Appendix A: Load Forecast in Table 8-2.

<sup>6</sup> DRV = Demand Reduction Value = the actual amount of load reduced measured at the customer meter; these totals are forecasted values for the commitment period beginning June 1, 2022. These values exclude transmission and distribution losses.

**Table 3-3:  
Load Levels to be studied**

State	2022 CELT 90/10 Load (MW)
Maine	2,450
New Hampshire	3,150
Vermont	1,220
Massachusetts	16,055
Rhode Island	2,405
Connecticut	8,825
<b>New England CELT Load</b>	<b>34,105</b>

In addition to the CELT load described above there is about 365 MW of non-CELT load in Maine that is also in the base cases.

After taking into account the aforementioned transmission losses, the subtraction of demand response loads, and the addition of non-CELT loads, the net load level modeled in the base cases for this study was approximately 29,800 MW.

### 3.1.8 Load Power Factor Assumptions

Load power factors consistent with the local transmission owner’s planning practices were applied uniformly at each substation. Demand resource power factors were set to match the power factor of the load at that bus in the model. A list of overall power factors by company territory can be found in the detailed load report in Appendix A: Load Forecast in Table 8-2.

### 3.1.9 Transfer Levels

In accordance with the reliability criteria of the NERC, NPCC and the ISO, the regional transmission power grid must be designed for reliable operation during stressed system conditions. A detailed list of all transfer levels can be found in Section 6. The following external transfers were utilized for the study:

- N-1 Analysis
  - New York to New England (AC ties) – 0 MW / 1,200 MW Import
  - Cross Sound Cable – 346 MW Export to Long Island<sup>7</sup>
  - Norwalk-Northport Cable – 200 MW Export to Long Island<sup>8</sup>
  - Highgate HVDC – 200 MW Import into New England
  - Phase II HVDC – 2,000 MW Import<sup>9</sup> into New England

<sup>7</sup> [Redacted]

<sup>8</sup> [Redacted]

<sup>9</sup> [Redacted]

- New Brunswick to New England – 1,000 MW Import
- N-1-1 Analysis
  - New York to New England (AC Ties) – 0 MW Export
  - Cross Sound Cable – 0 MW Export
  - Norwalk-Northport Cable – 0 MW Export
  - Highgate HVDC – 200 MW Import into New England
  - Phase II HVDC – 2,000 MW Import into New England
  - New Brunswick to New England – 1,000 MW Import

For this Needs Assessment the generation dispatch dictated the internal transfer levels.

As a part of this Needs Assessment report the violations observed for the 1,200 MW export will be reported in the detailed results in Appendix E: Steady State Testing Results. However the ensuing solutions study will not resolve the violations identified for the 1,200 MW export to NY cases.

The NY dispatch was adjusted depending on the NY-NE stress that was being studied. The dispatches were set up such that:

1. For 1,200 MW import from NY cases – Increased generation in the southern part of NY and reduced generation in upstate NY to create a loop flow that would increase flow on the 398 and 690 lines from New York to New England.
2. For 1,200 MW export to NY cases – Increased generation in the upstate NY and reduced generation in the southern part of NY to create a loop flow that would increase flow on the 398 and 690 lines from New England to New York.

### 3.1.10 Generation Dispatch Scenarios

All generators in the base case are modeled with a maximum capacity corresponding to their qualified capacity as of FCA #7.

Table 3-4 shows the qualified capacities of the generating units in the study area.

**Table 3-4:  
Qualified Generating Capacities of Study Area Units**

Area		Generating Unit	Qualified Capacity (MW)	Fast-Start <sup>10</sup> Unit
<b>Two Largest Critical Units in Connecticut</b>		Millstone 2	877	No
		Millstone 3	1225	No
<b>Middletown Subarea</b>		Middletown 2	117	No
		Middletown 3	236	No
		Middletown 10	17	Yes
		Branford Jet	19	Yes

Comprehensive Area Transmission Review of the New England Transmission System report, the Phase II facility was backed down by 450 MW to 1550 MW.

<sup>10</sup> “Fast-start” generators are those units that can go from being off-line to their full Seasonal Claimed Capacity in 10 minutes. These units do not need to participate in the 10-minute reserve market to be considered a fast-start unit in planning studies.

Area	Generating Unit	Qualified Capacity (MW)	Fast-Start <sup>10</sup> Unit
<b>Critical unit in Eastern CT</b>	Kleen Energy	620	No
<b>Greater Hartford Subarea</b>	CDECCA	55	No
	South Meadow 5	23	No
	South Meadow 6	25	No
	South Meadow 11	36	Yes
	South Meadow 12	38	Yes
	South Meadow 13	38	Yes
	South Meadow 14	37	Yes
<b>Northwest Connecticut Area</b>	Bristol Refuse/ Forestville	13	No
	Falls Village	3	No
	Franklin Drive 10	15	Yes
	Torrington Terminal Jet	19	Yes
<b>Manchester-Barbour Hill Subarea</b>	Dexter	37	No
	Rainbow	8	No
<b>Other Units in Western CT &amp; outside SWCT</b>	Middletown 4	400	No
	Middletown 12	47	Yes
	Middletown 13	47	Yes
	Middletown 14	47	Yes
	Middletown 15	47	Yes
	New Haven Harbor 1	448	No
	New Haven Harbor 2	43	Yes
	New Haven Harbor 3	43	Yes
	New Haven Harbor 4	43	Yes
<b>Two Largest Units in Southwest CT</b>	Bridgeport Harbor 3 (BH3)	383	No
	Bridgeport Energy (BE)	448	No

Twenty two dispatches were set up for the four study areas and for the western Connecticut import and Connecticut import needs assessment. The dispatches were set up by taking out one or two critical units in each subarea.

At all locations in the study area where a single fast-start unit was available, that unit was assumed OOS for each dispatch. For subareas where there were two single fast-start units, one of the two fast-start units was assumed online and available, if non-fast-start units were taken out of service in that subarea. For example, if the Middletown 3 unit is assumed OOS as a non-fast-start unit out of service then one of the two single fast-starts in the Middletown subarea, Branford Jet or Middletown 10, will be assumed to be in-service.

The Connecticut fast-start units were dispatched such that approximately 80% of the fast-start capability in Connecticut was online. The most up-to-date voltage schedules for area units were provided by Northeast Utilities and were utilized in this study. The fast-start dispatch assumptions detailed above were turned on in the base case and no adjustments were made to these fast start units post first contingency.

The performance of one of the hydroelectric units in the study area, Rainbow Hydro, was examined and it was determined that an availability of 10% of its nameplate capacity at summer peak was a reasonable assumption. This assumption was extended to all the Connecticut hydro units. This was acceptable since there are very few hydro units in Connecticut and just 2 of them are in the study area: Rainbow Hydro and Falls Village.

Table 3-5 provides the outputs assumed for the hydro units in Connecticut for units above 5 MW.

**Table 3-5:  
Dispatch of Hydro Units in Connecticut**

Unit Name	Dispatched Amount (MW)	Name Plate (50 degree rating - MW)	Location
<b>Rainbow Hydro</b>	0.8	8.2	Manchester/ Barbour Hill
<b>Stevenson Hydro</b>	2.9	28.9	SWCT
<b>Falls Village</b>	1.0	9.8	NWCT
<b>Rocky River</b>	2.9	29.4	SWCT
<b>Shepaug</b>	4.3	42.9	SWCT
<b>Bulls Bridge</b>	0.8	8.4	SWCT
<b>Derby Dam</b>	0.7	7.1	SWCT

The dispatches for each subarea are defined in the following section:

- **Middletown Subarea:** There were two critical units in this subarea: Middletown 2 and 3; these units were assumed OOS as a base case condition for this area’s two-units-out dispatch. Since these units are located on the same bus, only the largest of the two (Middletown 3) was taken OOS to create a one-unit-out dispatch. The Middletown study area has two single fast-start units, Middletown 10 and Branford Jet. For each case, one-unit-out case and two-unit-out case, two dispatches were created based on fast-start dispatch. Cases with the Middletown 10 off and Branford Jet on are called MIDD\_01 (two units OOS) and MIDD\_1A (one unit out). Alternately, cases with the Middletown 10 on and Branford Jet off are called MIDD\_02 (two units OOS) and MIDD\_2A (one unit out). This leads to a total of four dispatches for this subarea.
- **Manchester-Barbour Hill Subarea:** There were two critical units in this subarea: Dexter and Rainbow Hydro; these units were assumed OOS as a base case condition for this area’s dispatch. Since the Rainbow Hydro unit is a small unit, only one single unit out dispatch was created with Dexter out-of-service. This leads to a total of two dispatches for this subarea.
- **Northwest Connecticut Subarea:** There were two critical units in this subarea: Falls Village Hydro and Forestville; these units were assumed OOS as a base case condition for this area’s two-units-out dispatch. Since the Falls Village Hydro unit is a small unit, only one single unit out dispatch was created with the Forestville unit out of service. The Northwest Connecticut study area has two single fast-start units, Franklin Drive 10 and Torrington Terminal Jet. For each case, one-unit-out case and two-unit-out case, two dispatches were created based on fast-start dispatch. Cases with the Franklin Drive 10 on and Torrington Terminal Jet off are called NWCT\_01 (two units OOS) and NWCT\_1A (one unit out). Alternately, cases with the Franklin Drive 10 off and Torrington Terminal Jet on are called



NWCT\_02 (two units OOS) and NWCT\_2A (one unit out). This leads to a total of four dispatches for this subarea.

- **Hartford Subarea:** There were three critical units in this subarea: South Meadow 5, South Meadow 6 and Capitol District. There were two different two-units-out dispatches for this study area. The first has the two South Meadow units OOS and the other has one South Meadow unit (#6) and the Capitol District unit OOS. Two one-unit-out dispatches were also created, taking out the larger South Meadow unit (#6) and the Capitol District unit separately. This leads to a total of four dispatches for this subarea.
- **Western Connecticut Import Analysis:** Four dispatches were established to test the need for additional western Connecticut import capability.
  - **Dispatch 1** – High SWCT Import – Bridgeport Harbor 3 OOS and Bridgeport Energy OOS
  - **Dispatch 2** – Moderate western CT Import – New Haven Harbor and Kleen Energy OOS (Kleen is an eastern CT unit very close to the western CT import interface)
  - **Dispatch 3** – High Western CT Import – Bridgeport Harbor 3 and New Haven Harbor OOS (two largest 115 kV generators in western Connecticut)
  - **Dispatch 4** – High Western CT import – Bridgeport Energy and New Haven Harbor OOS (two largest generators in western Connecticut)

Additionally, two one-unit out dispatches were created.

- **Dispatch 3A** – High SWCT Import – Bridgeport Energy OOS
- **Dispatch 4A** – High western CT Import – New Haven Harbor OOS

This leads to a total of six dispatches for the western CT import analysis.

- **Connecticut Import Analysis:** As a part of the NEEWS Interstate analysis several line overloads were seen in the GHCC Study area. The overloads seen in the Interstate analysis were not resolved and were examined as a part of this analysis. The two-unit-out stress for this analysis was created by taking the two Millstone units out of service. Since these units are located on the same bus, only the largest of the two (Millstone 3) was taken OOS to create a one-unit-out dispatch. This leads to a total of two dispatches for this analysis.

The twenty-two dispatches just described are summarized in Table 3-6 and Table 3-7 on the following pages.

**Table 3-6:  
Two-Units-Out Generation Dispatches**

Major Area Units	Dispatch Name / Number												
	Middletown #1	Middletown #2	Barbour Hill #1	NWCT #1	NWCT #2	HTFD #1	HTFD #2	CCRP #1	CCRP #2	CCRP #3	CCRP #4	IRP #1 <sup>11</sup>	
<b>Middletown 2</b>	OFF	OFF	ON	ON	ON	ON	ON	ON	ON	ON	ON	ON	
<b>Middletown 3</b>	OFF	OFF	ON	ON	ON	ON	ON	ON	ON	ON	ON	ON	
<b>Middletown 10<sup>12</sup></b>	OFF	ON	OFF	OFF	OFF	OFF	OFF	OFF	OFF	OFF	OFF	OFF	
<b>Branford Jet<sup>12</sup></b>	ON	OFF	OFF	OFF	OFF	OFF	OFF	OFF	OFF	OFF	OFF	OFF	
<b>Dexter</b>	ON	ON	OFF	ON	ON	ON	ON	ON	ON	ON	ON	ON	
<b>Rainbow</b>	ON	ON	OFF	ON	ON	ON	ON	ON	ON	ON	ON	ON	
<b>Falls Village</b>	ON	ON	ON	OFF	OFF	ON	ON	ON	ON	ON	ON	ON	
<b>Forestville</b>	ON	ON	ON	OFF	OFF	ON	ON	ON	ON	ON	ON	ON	
<b>Franklin Drive 10<sup>12</sup></b>	OFF	OFF	OFF	ON	OFF	OFF	OFF	OFF	OFF	OFF	OFF	OFF	
<b>Torrington Term. Jet<sup>12</sup></b>	OFF	OFF	OFF	OFF	ON	OFF	OFF	OFF	OFF	OFF	OFF	OFF	
<b>South Meadow 5</b>	ON	ON	ON	ON	ON	OFF	OFF	ON	ON	ON	ON	ON	
<b>South Meadow 6</b>	ON	ON	ON	ON	ON	OFF	ON	ON	ON	ON	ON	ON	
<b>CDECCA</b>	ON	ON	ON	ON	ON	ON	OFF	ON	ON	ON	ON	ON	
<b>Bridgeport Energy</b>	ON	ON	ON	ON	ON	ON	ON	OFF	ON	ON	OFF	ON	
<b>Bridgeport Harbor 3</b>	ON	ON	ON	ON	ON	ON	ON	OFF	ON	OFF	ON	ON	
<b>Kleen Energy</b>	ON	ON	ON	ON	ON	ON	ON	ON	OFF	ON	ON	ON	
<b>New Haven Harbor 1</b>	ON	ON	ON	ON	ON	ON	ON	ON	OFF	OFF	OFF	ON	
<b>Millstone 2</b>	ON	ON	ON	ON	ON	ON	ON	ON	ON	ON	ON	OFF	
<b>Millstone 3</b>	ON	ON	ON	ON	ON	ON	ON	ON	ON	ON	ON	OFF	

<sup>11</sup> Interstate studies showed severe overloads in the Greater Hartford subarea for this dispatch; for that reason, this dispatch will also be tested in this Needs Assessment, even though the units OOS lie outside of the study area.

<sup>12</sup> Fast-Start unit

**Table 3-7:  
One-Unit-Out Generation Dispatches**

Major Area Units	Dispatch Name/Number									
	Middletown #1A	Middletown #1B	Barbour Hill #1A	NWCT #1A	NWCT #2A	HTFD #1A	HTFD #2A	CCRP #3A	CCRP # 4A	IRP #1A <sup>13</sup>
Middletown 2	ON	ON	ON	ON	ON	ON	ON	ON	ON	ON
Middletown 3	OFF	OFF	ON	ON	ON	ON	ON	ON	ON	ON
Middletown 10 <sup>14</sup>	OFF	ON	OFF	OFF	OFF	OFF	OFF	OFF	OFF	OFF
Branford Jet <sup>14</sup>	ON	OFF	OFF	OFF	OFF	OFF	OFF	OFF	OFF	OFF
Dexter	ON	ON	OFF	ON	ON	ON	ON	ON	ON	ON
Rainbow	ON	ON	ON	ON	ON	ON	ON	ON	ON	ON
Falls Village	ON	ON	ON	ON	ON	ON	ON	ON	ON	ON
Forestville	ON	ON	ON	OFF	OFF	ON	ON	ON	ON	ON
Franklin Drive 10 <sup>14</sup>	OFF	OFF	OFF	ON	OFF	OFF	OFF	OFF	OFF	OFF
Torrington Term. Jet <sup>14</sup>	OFF	OFF	OFF	OFF	ON	OFF	OFF	OFF	OFF	OFF
South Meadow 5	ON	ON	ON	ON	ON	ON	ON	ON	ON	ON
South Meadow 6	ON	ON	ON	ON	ON	OFF	ON	ON	ON	ON
CDECCA	ON	ON	ON	ON	ON	ON	OFF	ON	ON	ON
Bridgeport Energy	ON	ON	ON	ON	ON	ON	ON	OFF	ON	ON
Bridgeport Harbor 3	ON	ON	ON	ON	ON	ON	ON	ON	ON	ON
Kleen Energy	ON	ON	ON	ON	ON	ON	ON	ON	ON	ON
New Haven Harbor 1	ON	ON	ON	ON	ON	ON	ON	ON	OFF	ON
Millstone 2	ON	ON	ON	ON	ON	ON	ON	ON	ON	ON
Millstone 3	ON	ON	ON	ON	ON	ON	ON	ON	ON	OFF

### 3.1.11 Reactive Dispatch Assumptions

All area shunt reactive resources were assumed available and dispatched when required. Reactive output of generating units was modeled to reflect defined limits. A summary of the reactive output of units and shunt devices connected to the transmission system that played a significant role in the study area can be found in the power flow case summaries included in Appendix B: Case Summaries.

### 3.1.12 Demand Resources

As stated in Section 3.1.6, passive demand resources as forecasted for the year 2022 and active demand resources that cleared as of FCA #7 in 2013 were modeled for this study, minus approximately 52 MW of demand resources in Connecticut that have accepted NPR Requests for

<sup>13</sup> Interstate studies showed severe overloads in the Greater Hartford subarea for this dispatch; for that reason, this dispatch was also tested in this Needs Assessment, even though the units OOS lie outside of the study area.

<sup>14</sup> Fast-Start unit

FCA #8. Passive demand resources were assumed to perform to 100% of their forecasted amount. The passive DR included the forecasted EE which was assumed to perform to 100% of the forecast. Active demand resources were assumed to perform to 75% of their cleared amount. Real Time Emergency Generation (RTEG) was not modeled, consistent with all needs and solutions planning analyses.

**Table 3-8:  
New England Demand Resource Performance Assumptions**

Region	Passive DR	Energy Efficiency	Active DR	RTEGs
New England	100%	100%	75%	0%

**3.1.13 Protection and Control System Devices Included in the Study Area**

[Redacted]

[Redacted]

[Redacted]

[Redacted]

[Redacted]

[Redacted]

[Redacted]

[Redacted]

[Redacted]

[Redacted]

[Redacted]

[Redacted]

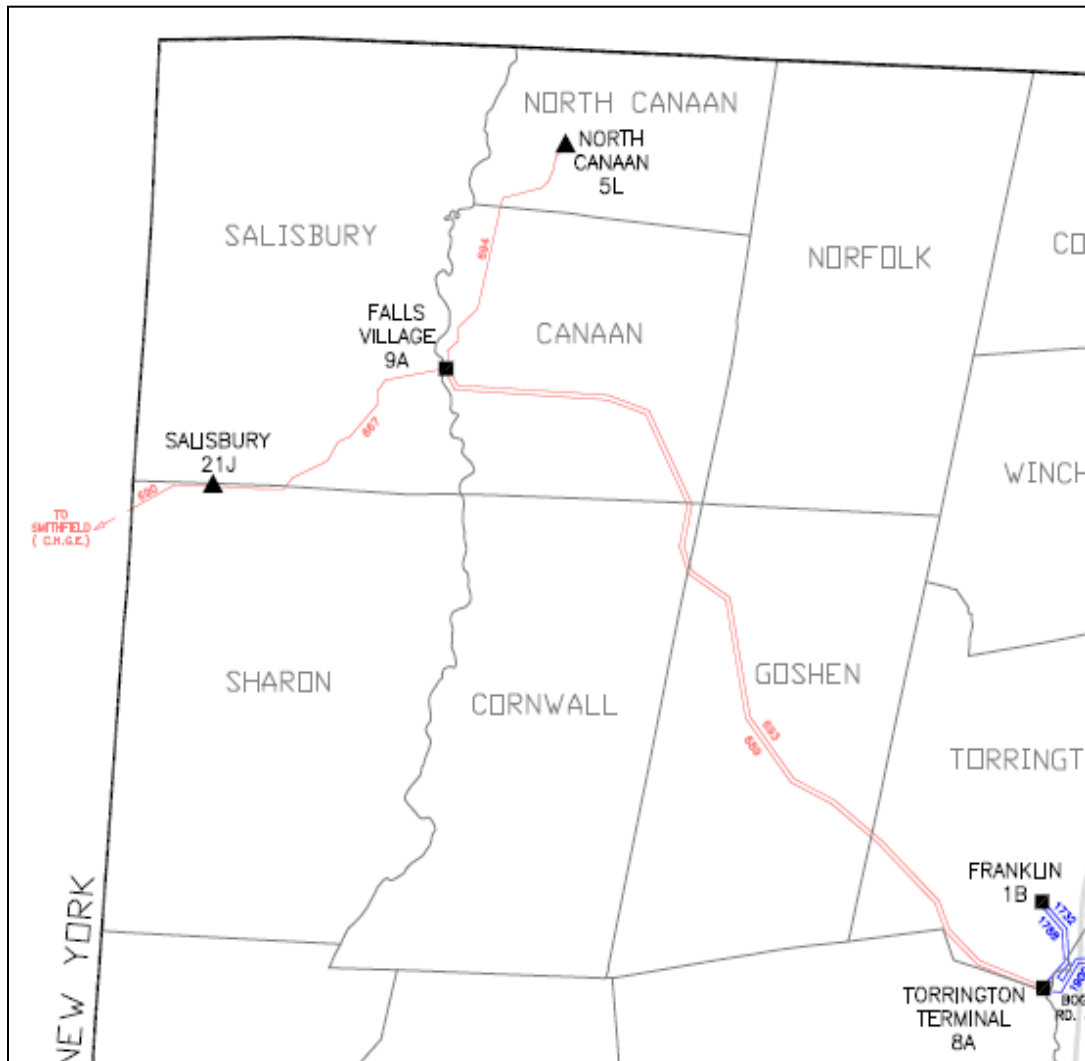


Figure 3-2: The 69 kV System in Northwestern Connecticut

### 3.2 Stability Modeling Assumptions

Not applicable for this study.

### 3.3 Short Circuit Model

#### 3.3.1 Study Assumptions

The short circuit study evaluated the projected 2022 available fault current levels around the GHCC area. It also included the effects of area reliability project upgrades as well as selected proposed generation interconnection projects as outlined in Sections 3.3.3 and 3.3.4 of this study document.

#### 3.3.2 Short Circuit Model

The ASPEN Circuit Breaker Rating Module software was used to calculate all circuit breaker duties. The case for the short circuit study was obtained from the 2011 short circuit base case library and all

PPA-approved projects, as discussed in Section 3.1.3 of this scope document, were added to that model. The Central Connecticut Reliability Project (CCRP) was excluded from the basecase, similar to the steady-state basecases.

### **3.3.3 Generation Additions and Retirements**

The model included proposed generation interconnection projects that have PPA approval as well as those generator projects that have FCA Capacity Supply Obligations (CSOs).

The following relevant generation projects were modeled for this study:

- QP 095 – Kleen Energy (FCA #2)
- QP 125 – Cos Cob 13&14 (FCA #1)
- QP 140 – A.L. Pierce (FCA #1)
- QP 150 – Plainfield Renewable Energy Project (FCA #3)
- QP 155.6 – Fuel Cell Project in Fairfield, CT (FCA #4)
- QP 161 – Devon 15-18 (FCA #2)
- QP 161 – Middletown 12-15 (FCA #2)
- QP 199 – Waterbury Generation (FCA #1)
- QP 206 – Kimberly Clark Energy (FCA #2)
- QP 248 – New Haven Harbor 2-4 (FCA #3)
- QP 289 – Fuel Cell Project in New Haven County, CT (FCA #4)

The non-price retirements of Norwalk Harbor 1, 2, and 10 as well as Bridgeport Harbor 2 were reflected in the short circuit basecase.

### **3.3.4 Generation and Transmission System Configurations**

NPCC Regional Reliability Reference Directory #1, “Design and Operation of the Bulk Power System” and PP 3 require short circuit testing to be conducted with all transmission and generation facilities in-service for all potential operating conditions.

### **3.3.5 Boundaries**

This study included testing of all 69 kV, 115 kV and 345 kV substations and breakers in the GHCC study area.

### **3.3.6 Other Relevant Modeling Assumptions**

Not applicable to this scope document.

# Section 4

## Analysis Methodology

### 4.1 Planning Standards and Criteria

---

The applicable NERC, NPCC and ISO-NE standards and criteria will be tested as part of this evaluation. Descriptions of each of the NERC, NPCC and ISO-NE standard tests that were used to assess system performance are discussed later in this section.

### 4.2 Performance Criteria

---

#### 4.2.1 Steady-state Criteria

The Needs Assessment was performed in accordance with NERC TPL-001, TPL-002, TPL-003 and TPL-004 Transmission Planning System Standards, NPCC “Regional Reliability Reference Directory #1, Design and Operation of the Bulk Power System”, dated 04/20/12, and the ISO Planning Procedure No. 3, “Reliability Standards for the New England Area Bulk Power Supply System”, dated 03/01/13. The contingency analysis steady-state voltage and loading criteria, solution parameters and contingency specifications that were used in this analysis are consistent with these documents.

As a part of this needs analysis the robustness of the system with respect to limited extreme contingency events was evaluated.

#### 4.2.1.1 Thermal and Voltage Limits

Loadings on all transmission facilities rated at 69 kV and above in the study area were monitored. The thermal violation screening criteria defined in Table 4-1 were applied.

**Table 4-1:  
Steady-State Thermal Criteria**

System Condition	Maximum Allowable Facility Loading
Normal (all-lines-in) (Pre-Contingency)	Normal Rating
Post-Contingency	Long Time Emergency (LTE) Rating

Voltages were monitored at all buses with voltages 69 kV and above in the study area. System bus voltages outside of limits identified in Table 4-2 were identified for all normal (pre-contingency) and post-contingency conditions.



**Table 4-2:  
Steady-State Voltage Criteria**

Transmission Owner	Voltage Level	Bus Voltage Limits (Per-Unit)	
		Normal Conditions (Pre-Contingency)	Emergency Conditions (Post-Contingency)
<b>Northeast Utilities</b>	69 kV & above	0.95 to 1.05	0.95 to 1.05
<b>Millstone / Seabrook</b> <sup>15</sup>	345 kV	1.00 to 1.05	1.00 to 1.05
<b>Pilgrim</b> <sup>15</sup>	345 kV	0.995 to 1.05	0.99 to 1.05
<b>Vermont Yankee</b> <sup>15</sup>	115 kV	1.00 to 1.05	1.00 to 1.05
	345 kV	0.985 to 1.05	0.985 to 1.05

It must be noted that some of the facilities that are classified as non-Pool Transmission Facilities (PTF) were reported in this report and the appendices. These violations however will not be categorized as needs and the ensuing solutions study will not develop solutions to solely resolve these violations.

#### 4.2.1.2 Solution Parameters

The steady-state analysis was performed with pre-contingency solution parameters that allow for adjustment of load tap-changing transformers (LTCs), static VAR devices (SVDs, including automatically-switched capacitors), and phase angle regulators (PARs). Table 4-3 displays these solution parameters.

**Table 4-3:  
Study Solution Parameters**

Case	Area Interchange Control	Tap Adjustments	Adjust Phase Shift	Switched Shunt Adjustments
<b>Base</b>	Tie Lines and Loads Enabled	Stepping	Enabled	Enabled
<b>Contingency</b>	Disabled	Stepping	Not Enabled	Not Enabled

As a part of the scope it was stated that sensitivity testing would be conducted with area interchange enabled. However, a few cases were tested with both area interchange enabled and disabled and no significant difference was observed for the contingencies not involving a source loss. Since a majority of the critical contingencies in the area do not involve a source loss, the results with area interchange disabled were only considered for the remainder of this report.

#### 4.2.2 Stability Performance Criteria

Not applicable for this study.

<sup>15</sup> This is in compliance with NUC-001-2, “Nuclear Plant Interface Coordination Reliability Standard,” adopted August 5, 2009.

### 4.2.3 Short Circuit Performance Criteria

This study was performed in accordance with appropriate IEEE C37 standards and specific design parameters of the circuit breakers. This includes specific considerations for total-current rated and symmetrical-current rated breakers as appropriate.

The circuit breakers were evaluated for short circuit adequacy based on the following criteria of Northeast Utilities (NU):

- *Acceptable-duty*: Circuit breaker fault interrupting duty less than 90% of the available fault current. No action required.
- *Marginal-duty*: Circuit Breaker Fault Interrupting Duty greater than or equal to 90% and less than 100%. This is an acceptable operating condition; however, potential solutions should begin to be developed to address solutions that would require a significant lead time to complete.
- *Over-duty Condition*: Circuit Breaker Fault Interrupting Duty greater than 100%. This is considered an unacceptable operating condition requiring a solution to be developed to eliminate the over-duty condition.

## 4.3 System Testing

---

### 4.3.1 System Conditions Tested

Testing of system conditions included the evaluation of system performance under a number of resource outage scenarios, variation of related transfer levels, and an extensive number of transmission equipment contingency events.

### 4.3.2 Steady-State Contingencies Tested

Each base case was subjected to single element contingencies such as the loss of a transmission circuit or an autotransformer. In addition, single contingencies which may cause the loss of multiple transmission circuit facilities, such as those on a common set of tower line structures were simulated. The steady-state contingency events in this study also included circuit breaker failures and substation bus fault conditions that could result in removing multiple transmission elements from service. A comprehensive set of contingency events, listed in Appendix D: Contingency Listings, were tested to monitor thermal and voltage performance of the GHCC study area transmission network. A listing of all contingency types that were tested is included in Table 4-4.

Additional analyses evaluated N-1-1 conditions with an initial outage of a key transmission element or generator followed by another contingency event. The N-1-1 analyses examined the summer peak load case with stressed conditions. For these N-1-1 cases, reliability standards, including ISO-NE Planning Procedure 3, allow specific manual system adjustments, such as fast-start generation redispatch, phase-angle regulator adjustment or HVDC adjustments between the first and second single contingency event. A summary listing of first element-out scenarios is provided in Table 4-5. A total of 113 element-out scenarios were tested. A detailed listing of all the element out scenarios tested is provided in Appendix C: Element Out for N-1-1 Analysis.

A class of contingencies not mentioned in the scope document is the loss of elements without a fault. A distinction was made in this assessment based on the nature of a no-fault contingency as follows:

- Type 1: No-fault contingencies involving the opening of a terminal of a line independent of the design of the terminating facility

- Type 2: A subset of the above contingencies that involves the opening of a single breaker

For N-1 testing, all Type 1 contingencies above were simulated. However, for N-1-1 testing only the Type 2 contingencies were simulated as 2<sup>nd</sup> contingencies.

**Table 4-4:  
Summary of NERC, NPCC and/or ISO-NE Category Contingencies to be Included**

Contingency Type	NERC Type	NPCC D-1 Section	ISO PP 3 Section	Tested in This Study
<b>All Facilities in-service</b>	A	5.4.2.b	3.2.b	Yes
<b>Generator (Single Unit)</b>	B1	5.4.1.a	3.1.a	Yes
<b>Transmission Circuit</b>	B2	5.4.1.a	3.1.a	Yes
<b>Transformers</b>	B3	5.4.1.a	3.1.a	Yes
<b>Element w/o Fault</b>	B5	5.4.1.d	3.1.d	Yes
<b>Bus Section</b>	C1	5.4.1.a	3.1.a	Yes
<b>Breaker Failure</b>	C2	5.4.1.e	3.1.e	Yes
<b>Double Circuit Tower</b>	C5	5.4.1.b	3.1.b	Yes
<b>Extreme Contingencies</b>	D	5.6	6	Yes (Limited)

**Table 4-5:  
Summary of N-1-1 First Element-Out Scenarios**

Contingency Type	Number of Element Out Scenarios
<b>Overhead 345 kV lines</b>	23
<b>Autotransformers</b>	14
<b>Generators</b>	6
<b>Underground 115 kV cables</b>	2
<b>Overhead 115 kV lines</b>	65
<b>Overhead 69 kV Lines</b>	3
<b>Total Number of Scenarios</b>	<b>113</b>

### 4.3.3 Use of Redispatch

When setting up the dispatches in Section 3.1.10, all the regular generators in Connecticut and 80% of the quick starts were dispatched to their qualified capacity with the exception of the critical generators out of service. However, prior to running the N-1 analysis, a generation redispatch was conducted to see if backing down any of these generators would resolve criteria violations. The back down did result in a few violations being eliminated. The tables in Section 5 only report the residual violations post redispatch. The details of the redispatch performed on the basecases can be found in Appendix E: Steady State Testing Results.

Additionally, as outlined in ISO Planning Procedure #3 (PP3), allowable actions after the first contingency event and prior to the second contingency event include redispatch of generation. During the analysis, available generation in the study area and its vicinity were allowed to reduce their output if online. Remote generation in Maine remote from the study area was used to replace the lost

generation within the area of study to simulate the redispatch of fast-start units within New England to keep load balance. A maximum limit of 1200 MW of redispatch was considered acceptable. Anything higher than 1200 MW could not be considered acceptable due to the amount of reserves typically available on the system.

To simulate these actions in power flow analysis, the Security Constrained Redispatch (SCRD<sup>16</sup>) tool in the TARA software package was used.

Additionally, since the shunt devices were assumed to be locked for post contingency conditions as indicated in Table 4-3, pre-contingency adjustment of capacitors were allowed to prevent post contingency voltage concerns. The adjustment was primarily performed to the Southington 115 kV and Frost Bridge 115 kV capacitors.

#### **4.3.4 Stability Contingencies Tested**

Not applicable to this study.

#### **4.3.5 Short Circuit Faults Tested**

The ASPEN circuit breaker rating module software was used to calculate all circuit breaker duties. The pre-fault operating voltage for all GHCC study area buses was set to be 1.04 per unit (p.u.). Figure 4-1 shows the ASPEN options that were used in this study.

---

<sup>16</sup> TARA's SCR D tool does not consider economics in the objective function to solve violation constraints. It solely uses the most effective generation that will resolve a particular constraint on the system

**ANSI/IEEE Breaker Checking Options**

**Fault Types**

3LG     2LG     1LG     LL

For X/R Calculation, use

Separate X-only, R-only networks     Complex impedance network

In 1LG faults, allow up to 15% higher rating for

Symmetrical current rated     Total current rated breakers

Force voltage range factor K=1 in checking

Symmetrical-current rated breakers with max design  or higher

Total-current rated breakers with max design  or higher

**Misc. Options**

Apply scaling factor F to the calculated breaker interrupting duty:

- F = operating kV / nominal bus kV
- F = operating kV / pre-fault bus kV

Set default breaker operating kV equal to flat pre-fault voltage profile p.u.

Treat all sources as "Remote"

Ignore all reclosing settings

Show in report all faults simulated for breaker duty calculation

Compute breaker duty for out-of-service protected equipment

OK    Cancel    Help

---

**Fault Simulation Options**

**Prefault Voltage**

Assumed "Flat" with  
V (pu) =

From a linear network solution

From a Power Flow solution

**Generator Impedance**

[dropdown]

**Define Fault MVA As Product of**

[dropdown]

**Ignore Mutuals < This Threshold**

pu

**Ignore in Short Circuits**

Loads

Transmission line G+B

Shunts with + seq values

Transformer line shunts

**MDV-Protected Series Capacitors**

Iterate short circuit solutions

Acceleration factor =

**Current Limited Generators**

[dropdown]

Do not change display quantity when browsing fault results

Include outaged branches in solution summary in TTY Window

OK    Cancel    Help

**Figure 4-1: Circuit Breaker Testing Parameters**

# Section 5

## Results of Analysis

### 5.1 Overview of Results

---

The GHCC study area load for 2022 was 2846 MW after demand resources are subtracted. The total generation in the area is less than 750 MW. The GHCC area is primarily an import area and depends on the transmission lines connecting the area to the rest of the system to serve load. A majority of the issues seen in the study area are load serving issues caused by the loss of key transmission elements OOS under N-1 and N-1-1 contingency conditions.

The criteria violations observed in the Needs Assessment indicate thermal and voltage violations in the four subareas seen mostly under generation deficiency conditions in each subarea. A number of issues are also seen when all the generation in a subarea is available thereby indicating that the issues are independent of generation dispatch.

As a part of the thermal and voltage analysis it was observed that criteria violations were seen to exist in both the one unit OOS and the two units OOS cases. In most cases there was very little difference in the extent of violation between the one unit OOS and the two units OOS cases. These results indicate that the violations are more a result of the local load and the contingencies applied rather than the specific generation dispatches.

The short circuit analysis indicated that all the study area breakers had acceptable fault duty, and the extreme contingency assessment indicated an acceptable response.

The following section provides a description of each subarea in terms of total load in the subarea and some of the general characteristics that were seen for each subarea. The sections intend to provide a high level overview of the thermal and voltage concerns in each subarea.

#### 5.1.1 Greater Hartford Subarea Overview

The Greater Hartford subarea net load for 2022 after demand resources are subtracted is about 1,227 MW of load. The area has three generators totaling to about 103 MW that may be classified as regular units and four generators totaling to about 149 MW that are classified as fast-start units.

Looking at the load and generation it can be observed that the Greater Hartford area is a net importer of energy and relies on the surrounding areas to serve local load. The major 115 kV lines that feed this subarea are:

- Three 115 kV lines from North Bloomfield (Lines 1726, 1751, and 1777)
  - 1726: North Bloomfield – Farmington
  - 1751: North Bloomfield – Northwest Hartford – Rood Avenue
  - 1777: North Bloomfield – Bloomfield
- Three 115 kV lines from Manchester (Lines 1207, 1448 and 1775)
  - 1207: Manchester – East Hartford
  - 1448: Manchester – Rood Avenue
  - 1775: Manchester – Riverside Drive – South Meadow
- Two 115 kV lines from Southington (Lines 1670 and 1771)
  - 1670: Southington – Black Rock – Berlin

- 1771: Southington – Berlin
- One 115 kV line from Middletown (Line 1765)
- 1765: Westside – Berlin

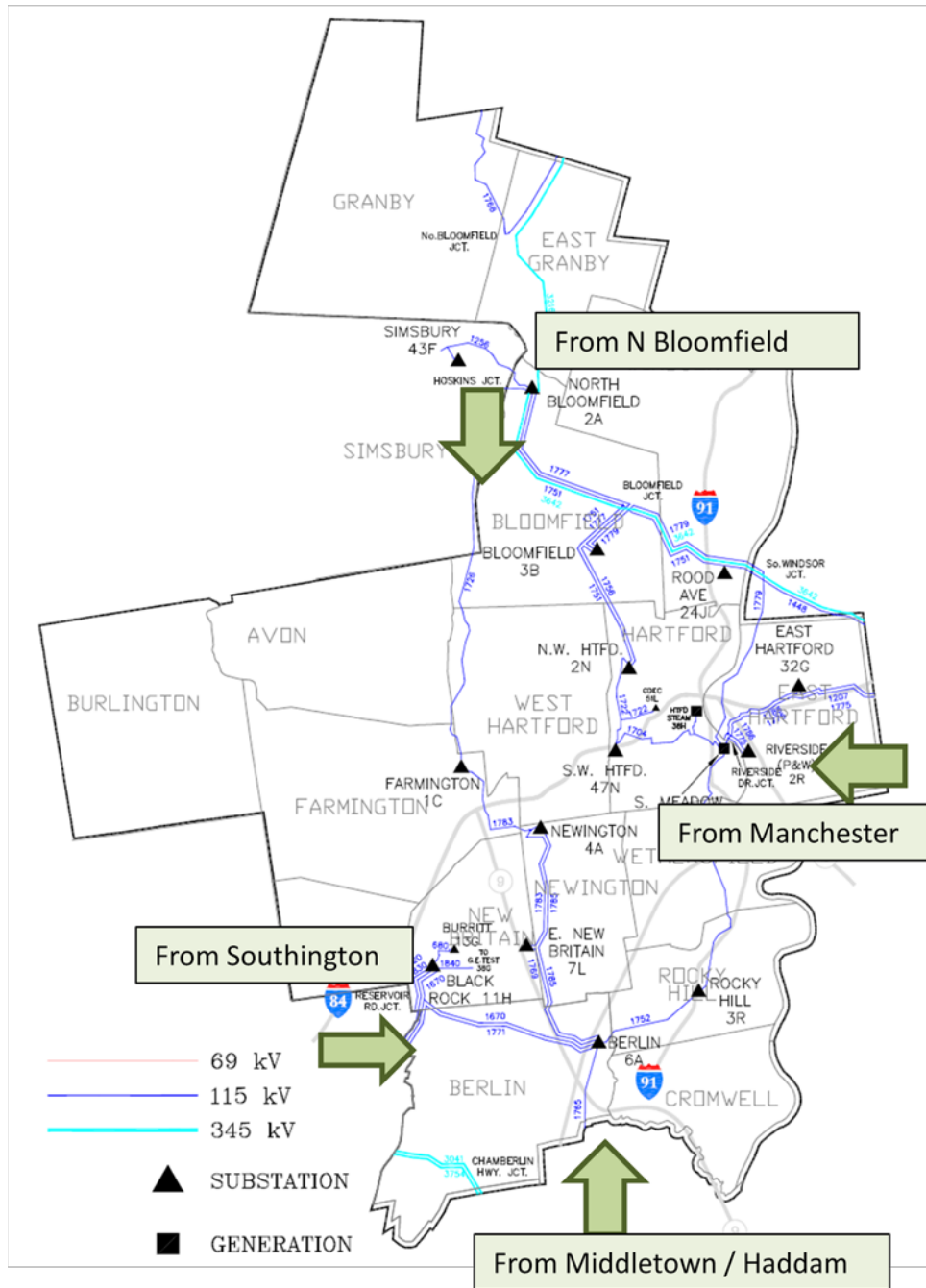


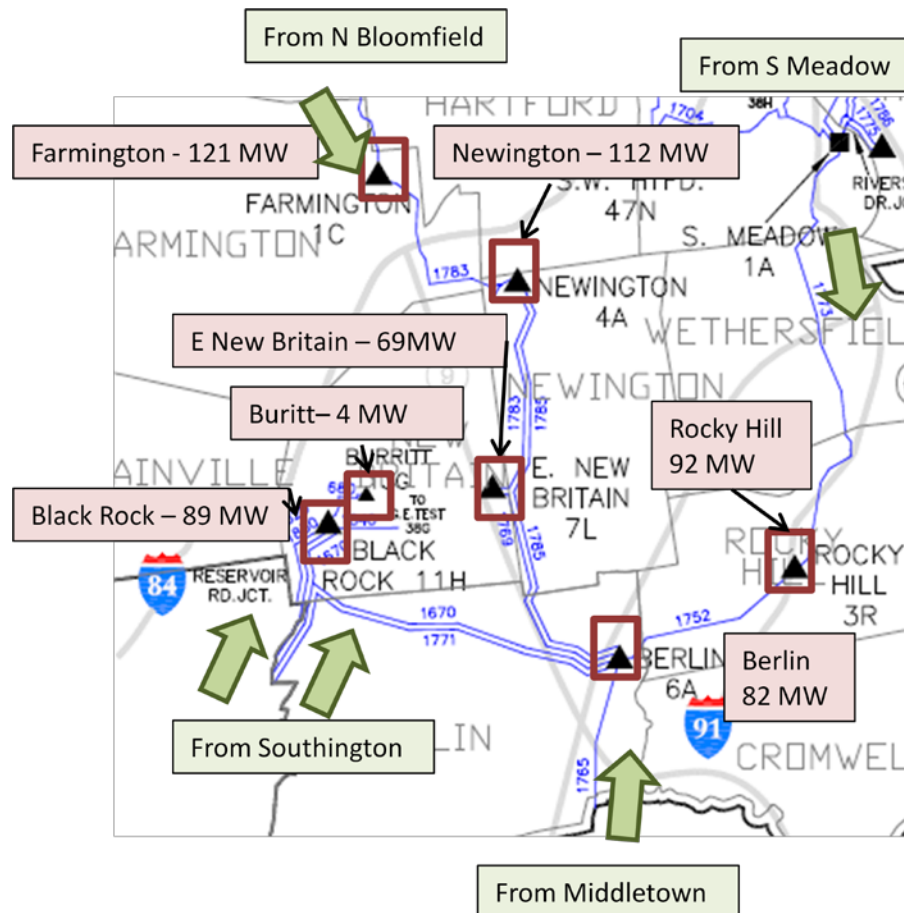
Figure 5-1: An Overview of the Greater Hartford Subarea

The N-1 violations in the subarea were few, but a majority of the violations were N-1-1 violations. The N-1-1 violations have been grouped into the following three areas:

- South Meadow – Berlin – Southington Area
- North Bloomfield – Manchester Area
- Southington Area

### 5.1.1.1 South Meadow, Berlin and Southington Area

- This area has a 2022 load of about 569 MW after DR loads are subtracted. The load is distributed across seven substations.
- This load pocket is served by five 115 kV lines:
  - Two 115 kV lines from Southington to Berlin (Lines 1670 and 1771)
  - A 115 kV line from North Bloomfield to Farmington (Line 1726)
  - A 115 kV line from South Meadow to Rocky Hill (Line 1773)
  - A 115 kV line from Westside towards Berlin (Line 1765)
- There is no generation located within this load pocket
  - Highest violations seen when adjacent Middletown generation is OOS



**Figure 5-2: South Meadow, Berlin and Southington Load Area**

Within this load area is the Farmington, Newington and East New Britain load pocket.



- This load pocket has a net load of 302 MW for 2022 after DR loads are subtracted. The load is distributed across three 115 kV substations.
- This load pocket served by three 115 kV lines:
  - A 115 kV line from North Bloomfield to Farmington (Line 1726)
  - A 115 kV line from Berlin to Newington (Line 1785)
  - A 115 kV line from Berlin to East New Britain (Line 1769)

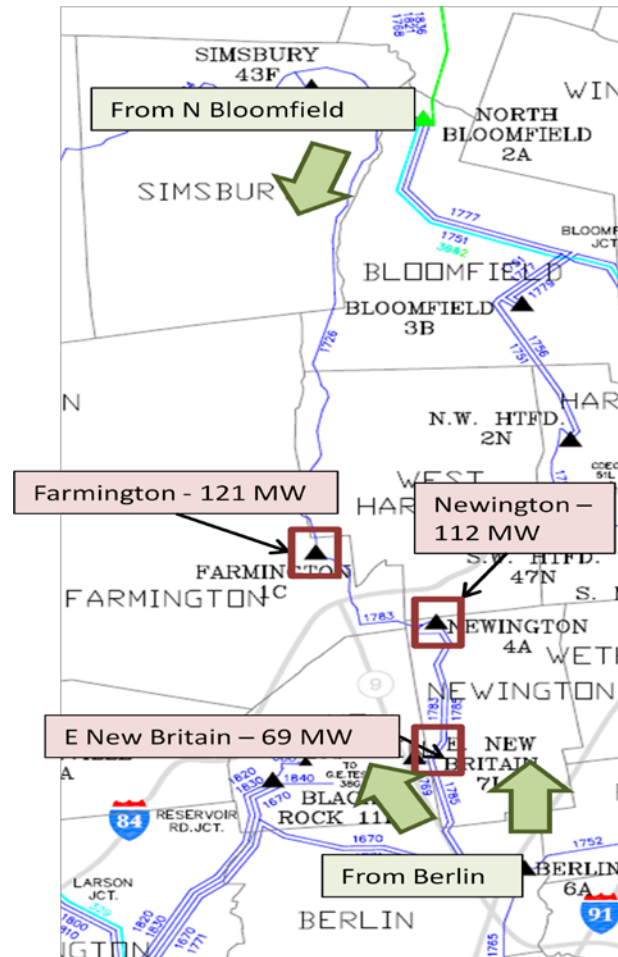


Figure 5-3: Farmington, Newington and East New Britain Load Pocket

### 5.1.1.2 North Bloomfield – Manchester Area

- This area is bound by feeds from North Bloomfield and Manchester.
- This area is served by five 115 kV lines:
  - A three-terminal 115 kV line from North Bloomfield to Northwest Hartford to Rood Avenue (Line 1751)
  - A 115 kV line from North Bloomfield to Bloomfield (Line 1777)

- A three terminal 115 kV line from Manchester – Riverside – South Meadow (Line 1775)
- A 115 kV line from Manchester – East Hartford (Line 1207)
- A 115 kV line from Manchester – Rood Avenue (Line 1448)
- CDECCA generation and South Meadow generation is located at the heart of this area [REDACTED]
- [REDACTED]

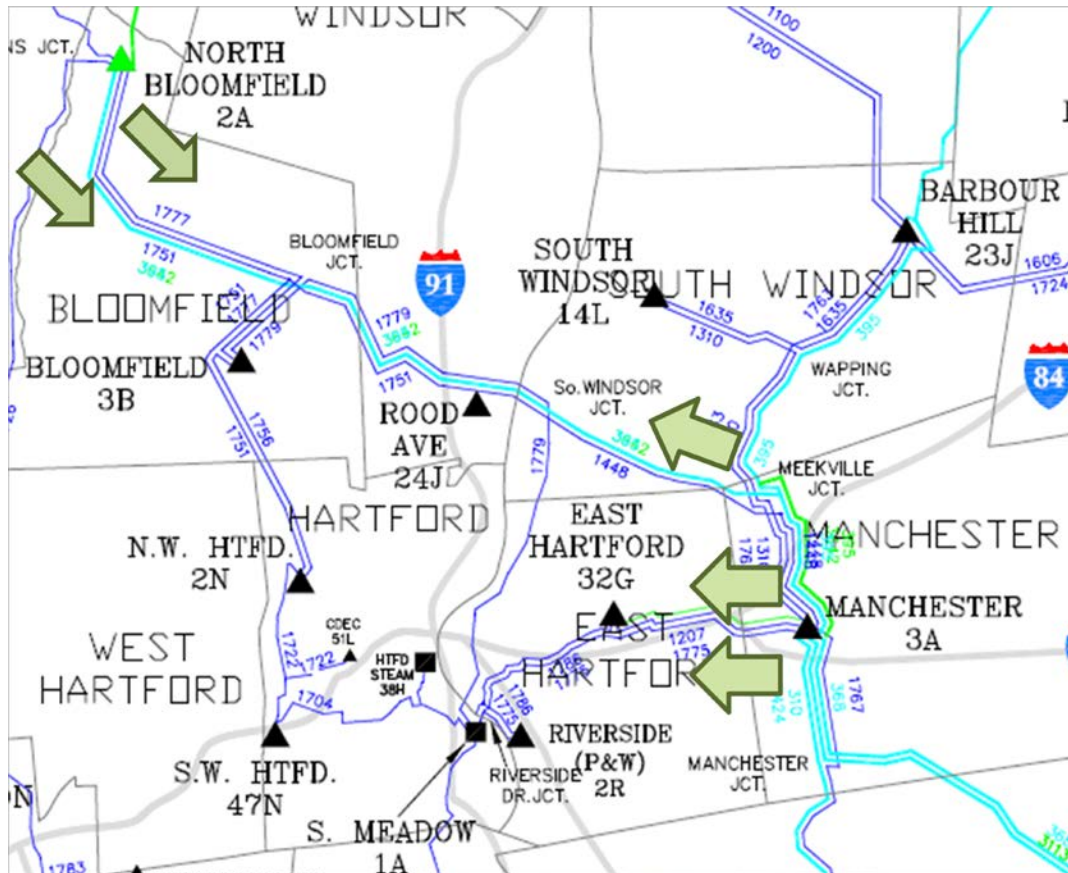


Figure 5-4: North Bloomfield - Manchester Area

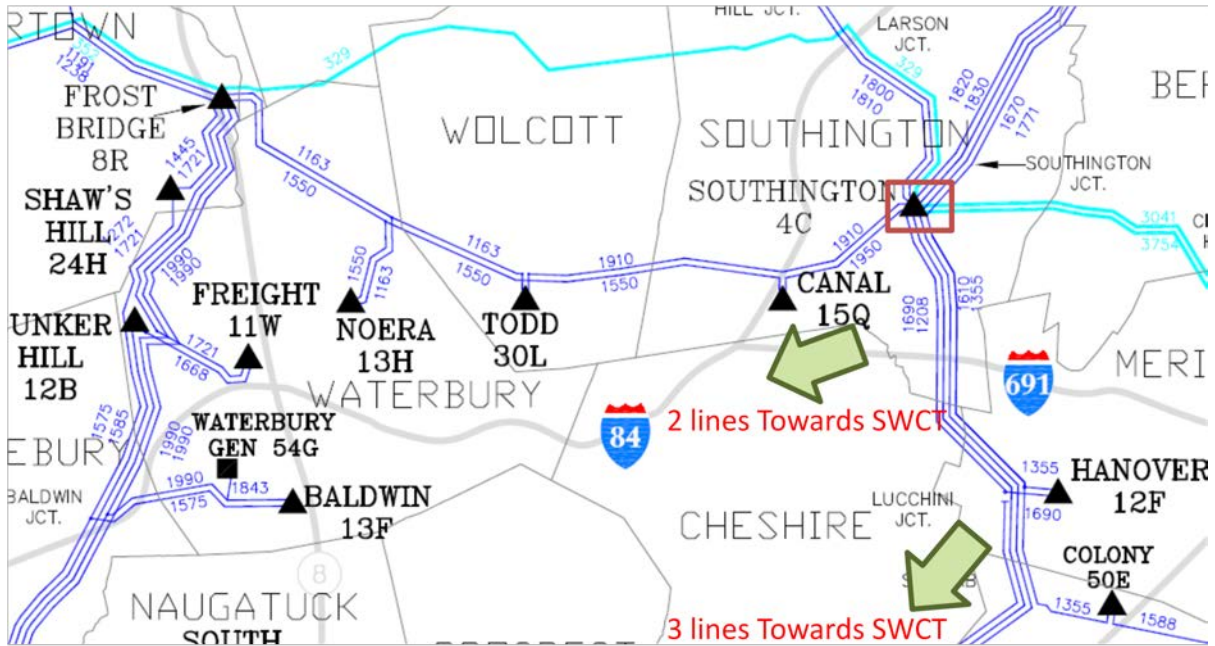
### 5.1.1.3 Southington Area

The final set of violations was seen on elements at or emanating from the Southington substation.

[REDACTED]

The Southington substation has five 115 kV facilities that are a part of the SWCT import interface. There are 4 autotransformers at Southington that feed into these SWCT import lines. The violations seen in this area are all thermal violations.

[REDACTED]



**Figure 5-5: Southington substation and SWCT Import Interface**

Additional details for the violations in the Greater Hartford subarea has been documented in Section 5.2.1.

### 5.1.2 Manchester - Barbour Hill Subarea Overview

The Manchester-Barbour Hill subarea consists of about 452 MW of load including demand resources in 2022. The area has one generator (Dexter) that has a qualified capacity of 37 MW and is considered a regular generator and one hydro station (Rainbow Hydro) that has a total qualified capacity of about 8 MW. The hydro station is dispatched to 10% of its nameplate capacity at 0.8 MW.

Looking at the load and generation it can be observed that the Manchester-Barbour Hill subarea is a net importer of energy and relies on the surrounding areas to serve local load.

All criteria violations in this subarea are observed under N-1-1 conditions. The violations may be broadly divided into two categories:

- Barbour Hill Load Pocket
- Manchester Autotransformers

The Barbour Hill load pocket consists of five 115 kV substations and the details for this load pocket are shown in Figure 5-6. The total load within this load pocket is about 326MW including demand resources. The area is fed by the following three transmission elements:

- The 345/115 kV autotransformer at Barbour Hill (Barbour Hill Auto)
- A 115 kV line from Manchester to Barbour Hill (Line 1763)
- A 115 kV line from Manchester to South Windsor (Line 1310)

Both area units are located within this load pocket

The criteria violations are only seen under N-1-1 conditions.

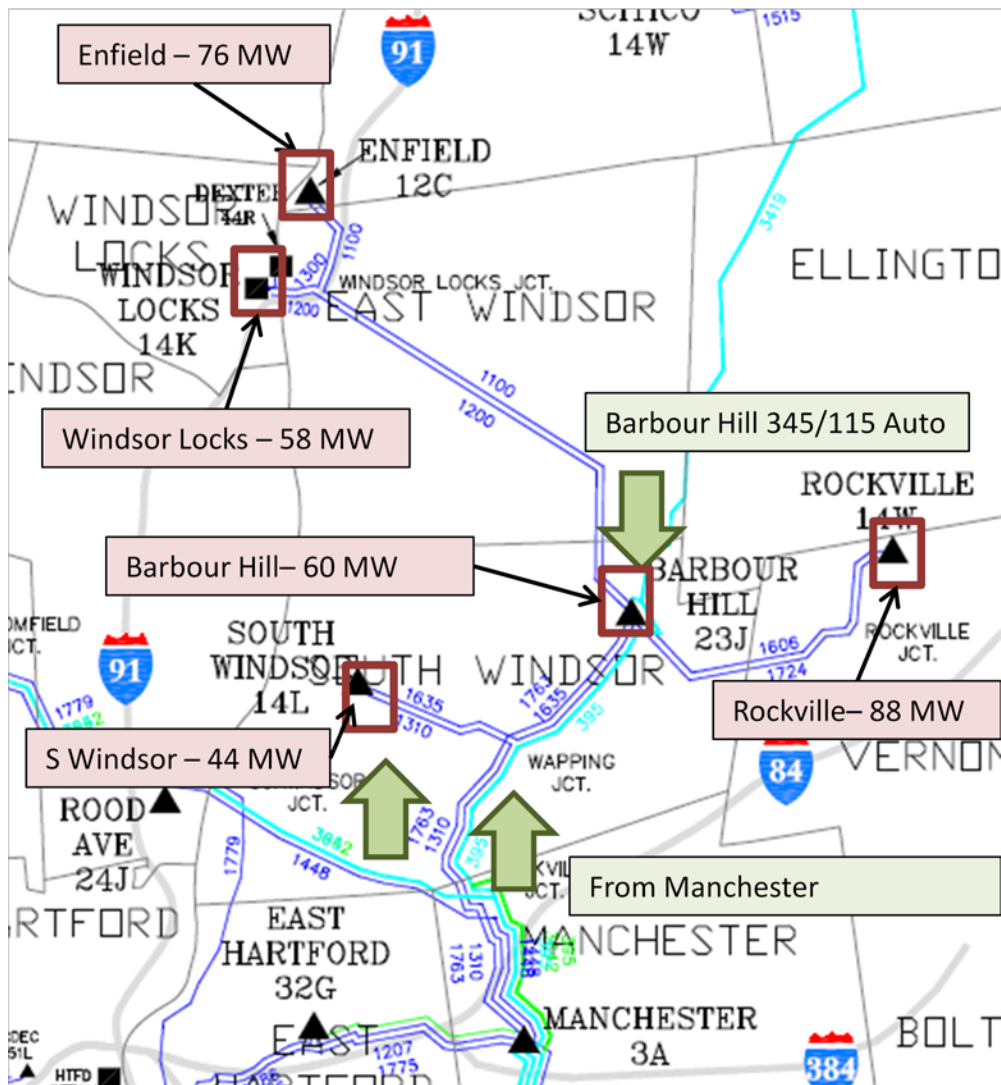


Figure 5-6: Barbour Hill Area Load Pocket




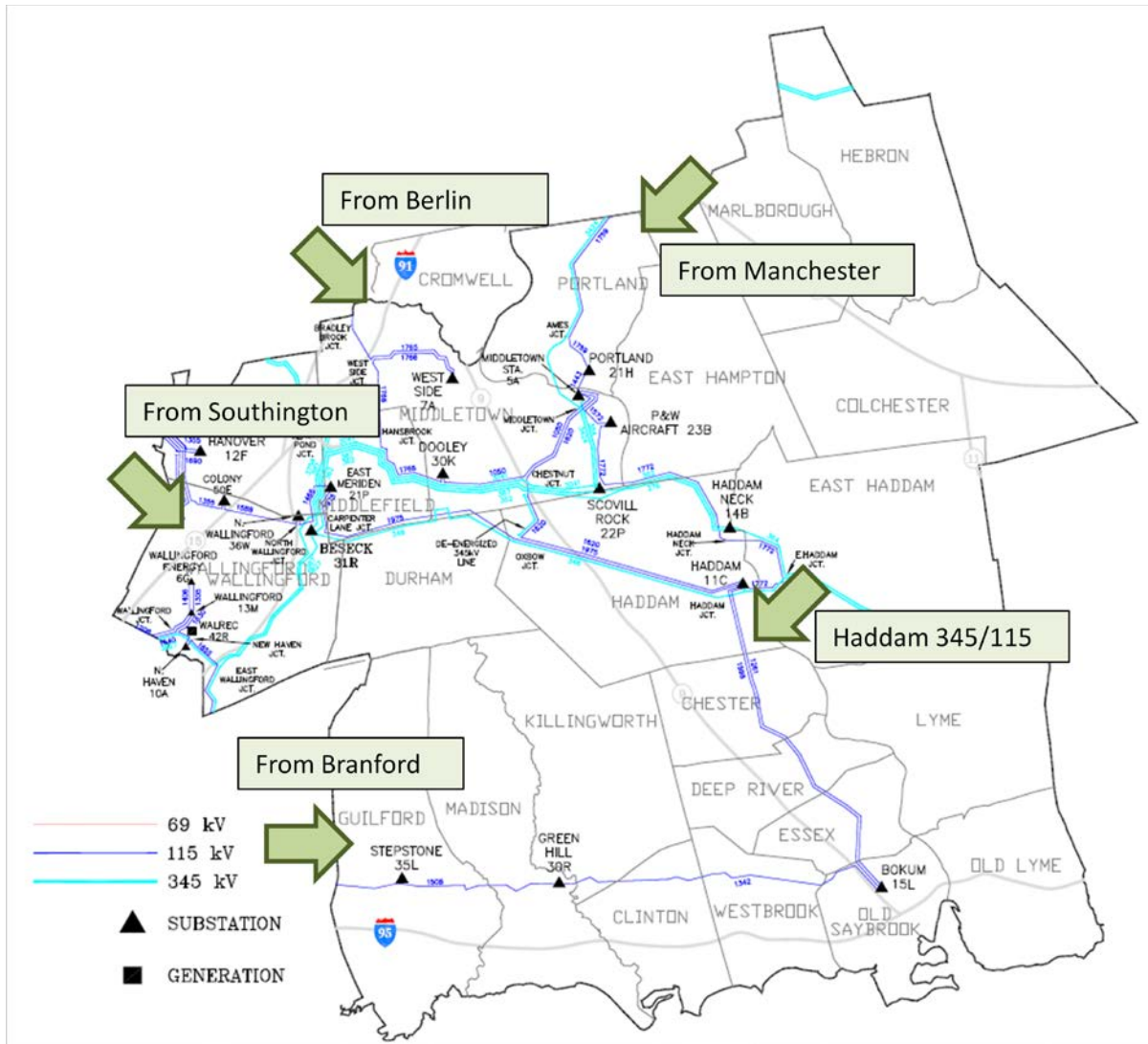
### 5.1.3 Middletown Subarea Overview

The Middletown subarea consists of about 656 MW of load including demand resources in 2022. The area has two generators totaling to about 353 MW (Middletown 2 and 3) that may be classified as regular generators and two generators (Middletown 10 and Branford 10) totaling to about 33 MW that are classified as fast-start units.

Looking at the load and generation it can be observed that the Middletown subarea does depend on the surrounding areas to serve the local load, but has a substantial amount of local generation which reduces the need for import capability when all units are available.

The major transmission elements that feed this subarea are:

- A 345/115 kV autotransformer at Haddam (Haddam 6X)
  - A 115 kV line from Southington to Colony (Line 1355)
  - A 115 kV line from Manchester to Hopewell (Line 1767)
  - A 115 kV line from Branford to Stepstone (Line 1738)
  - A 115 kV line from Berlin to Westside (Line 1765)
- 



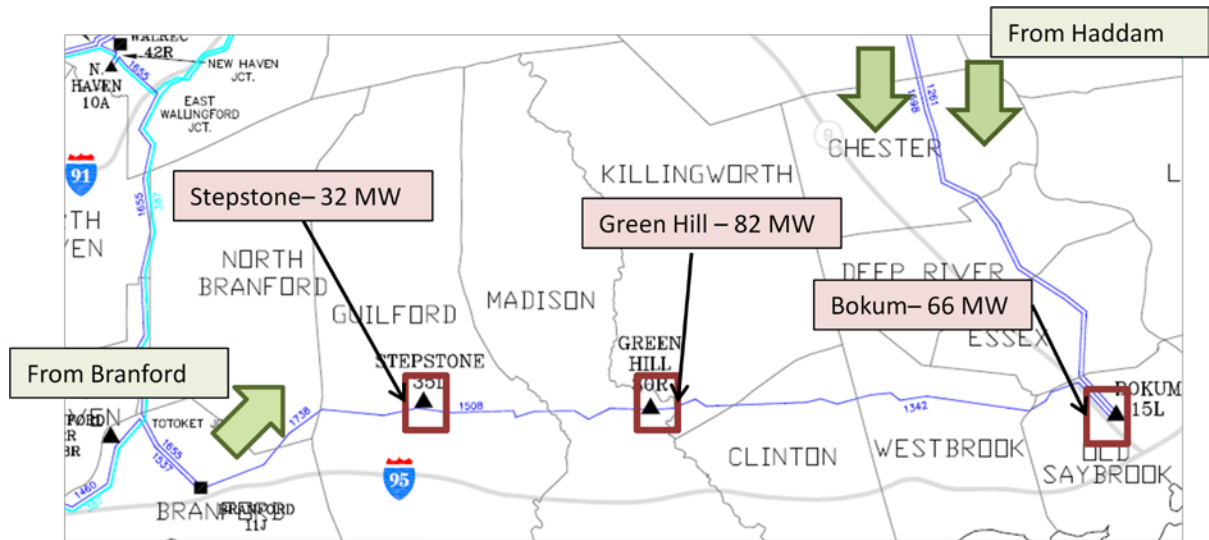
**Figure 5-7: An Overview of the Middletown Subarea**

A smaller load pocket between Haddam and Branford on the 115 kV network experiences some violations for all the dispatches. This load pocket consists of four substations totaling 180 MW of load including demand resources. The only unit in the subarea is the Branford 10 unit [REDACTED]. The dispatch of other regular units has an insignificant impact on these violations.

This load pocket is fed by:

- Two 115 kV lines from Haddam to Bokum (Line 1261 and 1598)
- One 115 kV line from Branford - Stepstone (Line 1738)

Thermal and voltage violations are observed under N-1 and N-1-1 conditions [REDACTED].



**Figure 5-8: Branford - Haddam Load Pocket**

In addition to the issues discussed above some other N-1 and N-1-1 criteria violations were also observed. The details of these violations are discussed in Section 5.2.3.

#### 5.1.4 Northwestern Connecticut Subarea Overview

The Northwestern Connecticut (NWCT) subarea consists of about 511 MW of load including demand resources in 2022. The area has one generator at Forestville at 17 MW which is classified as a regular generator and a hydro station (Falls Village) that has a total qualified capacity of about 3MW. The hydro station is dispatched to 10% of its nameplate capacity (9 MW) at 0.9 MW, based on historical performance data for hydroelectric generation in the area during summer peak load conditions. The subarea also has two fast start generators at Franklin Drive and Torrington Terminal that total to 31 MW.

Looking at the load and generation it can be observed that the Northwestern Connecticut subarea is a net importer of energy and relies on the surrounding areas to serve local load. The major transmission elements that feed this subarea are:

- Two 115 kV lines from Southington (Line 1810 and 1800):
  - 1800: Southington – Forestville
  - 1810: Southington – Chippen Hill – Bristol
- A 115 kV line from N Bloomfield (Line 1256):
  - 1256: North Bloomfield – Northeast Simsbury
- A 115 kV line from Frost Bridge (Line 1191):
  - 1191: Frost Bridge – Chippen Hill
- A 69 kV line from New York (Line 690):
  - 690: Smithfield substation in NY to Salisbury substation in CT

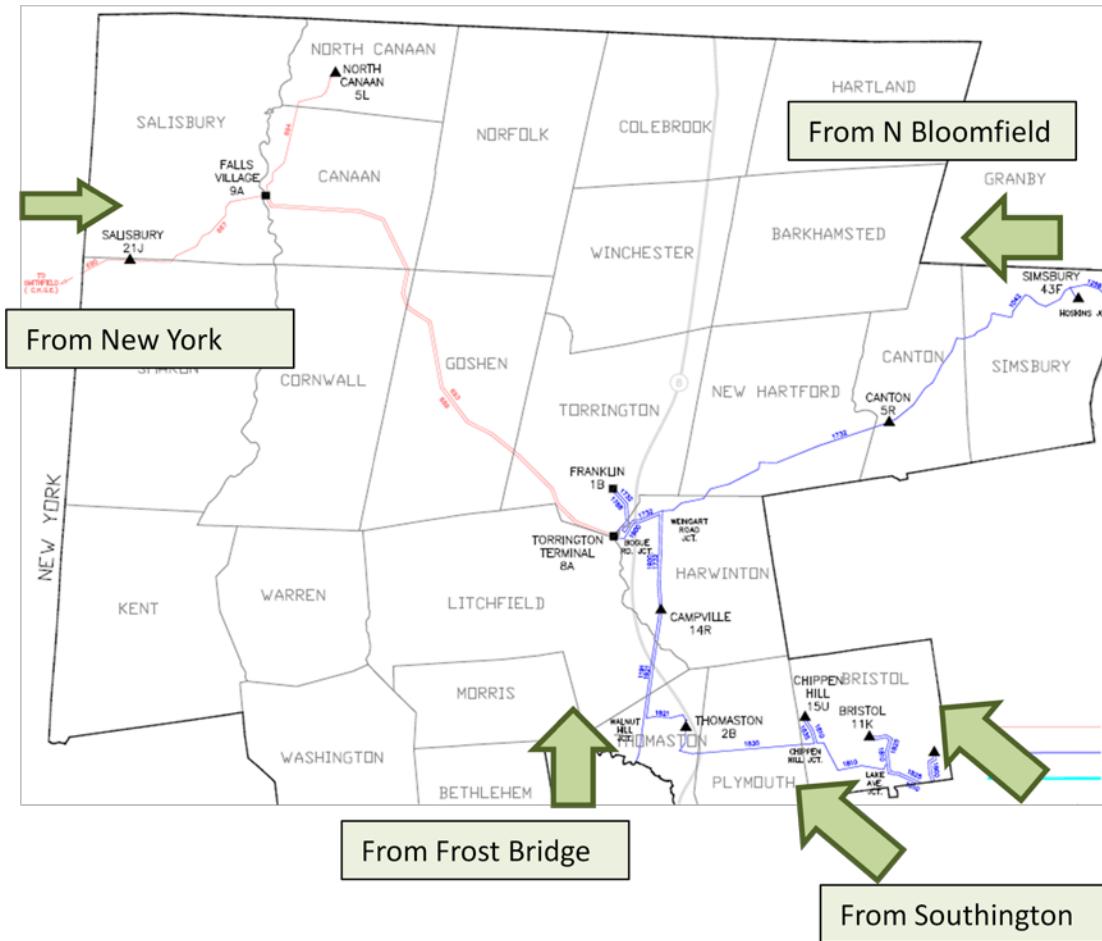


Figure 5-9: An Overview of the Northwestern Connecticut Subarea

The worst-case criteria violations are observed for the N-1-1 conditions

the criteria violations observed under N-1-1 conditions are almost identical with one or two units OOS.

In addition to the N-1-1 issues, some N-1 and N-0 criteria violations were also observed in the Northwestern Connecticut subarea. The details of these violations are discussed in Section 5.2.4.

## 5.2 Steady State Performance Criteria Compliance

The following sections provide the worst-case steady-state performance criteria violations for each of the four subareas studied. The information in the tables and the text captures the worst-case violations for each element that has at least one thermal or voltage violation. For a comprehensive list of all the base case conditions and contingencies for which overloads were observed, the tables provided in



Appendix E: Steady State Testing Results may be used. All thermal violations for N-1 and N-1-1 testing were based on the Long Term Emergency (LTE) rating of the different transmission facilities. Under N-0 conditions, the thermal overloads were based on the Normal rating of the transmission facilities.

For a number of contingency conditions the resultant voltages at some buses were very low. Under very low-voltage conditions there is a possibility that voltage collapse may occur since the load cannot be sustained at that low of a voltage magnitude. With the tools utilized in this study, the resultant voltage is obtained in many cases but the result may be misleading because instead of a low-voltage violation, a voltage collapse may occur. In reporting these results a threshold of 0.8 per unit of voltage was utilized, and if the resultant post contingency voltage was below 0.8 per unit, a footnote is added by an asterisk (\*) indicating that a potential voltage collapse might occur.

In addition, when reviewing the results is that low voltages under post contingencies leads to higher current flow on the transmission elements. Hence, if a particular contingency causes thermal and low-voltage violations, the low voltage would typically aggravate the thermal loadings. If the voltage would be raised the thermal loadings on the line would be lower, thereby reducing the extent of the overload. If a voltage below 0.85 is observed in the vicinity of the overloaded element a footnote is added by a hashtag (#) indicting the low voltage is contributing to the thermal results.

## **5.2.1 Greater Hartford Subarea Steady-State Performance**

The Greater Hartford subarea had four transmission elements with N-1 thermal violations and four 115 kV buses with N-1 low-voltage violations. Under N-1-1 conditions, there were 27 elements with thermal violations and ten 115 kV PTF buses with low-voltage violations. Two 115 kV non-PTF buses also had low voltages. There were no N-0 violations.

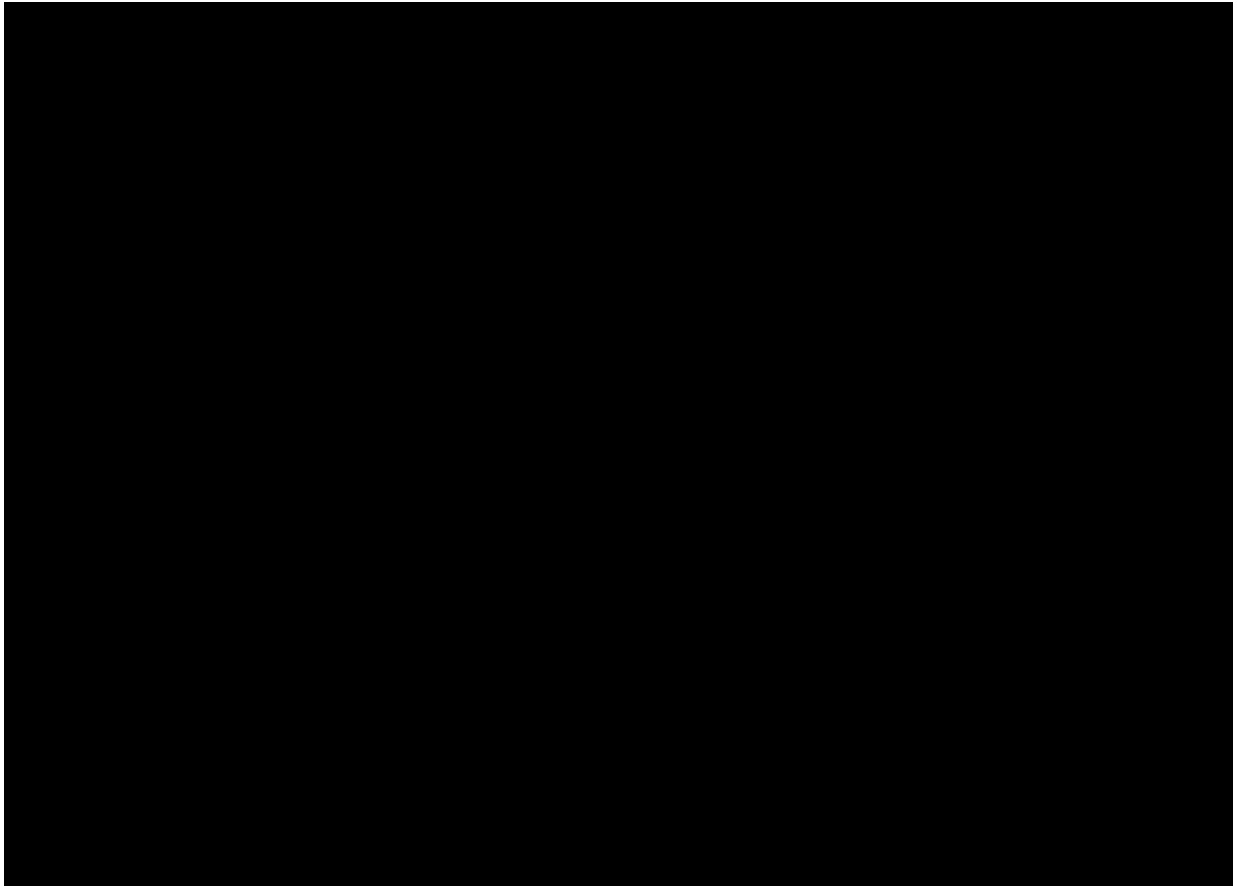
### **5.2.1.1 N-0 Thermal and Voltage Violation Summary**

There were no N-0 violations in the Greater Hartford subarea.

### **5.2.1.2 N-1 Thermal and Voltage Violation Summary**

The following Table 5-1 summarizes the worst-case 115 kV thermal violations seen in the Greater Hartford subarea. The corresponding violations are shown in Figure 5-10. The thermal violations can be classified into 3 categories:

- Dispatch independent violations (1726 and 1783-1)
- Thermal violations that are highest with low Hartford generation (1751)
- Thermal violations that are highest with high western CT import (Southington 2X)



**Figure 5-10: N-1 Thermal Violations in the Greater Hartford Area**

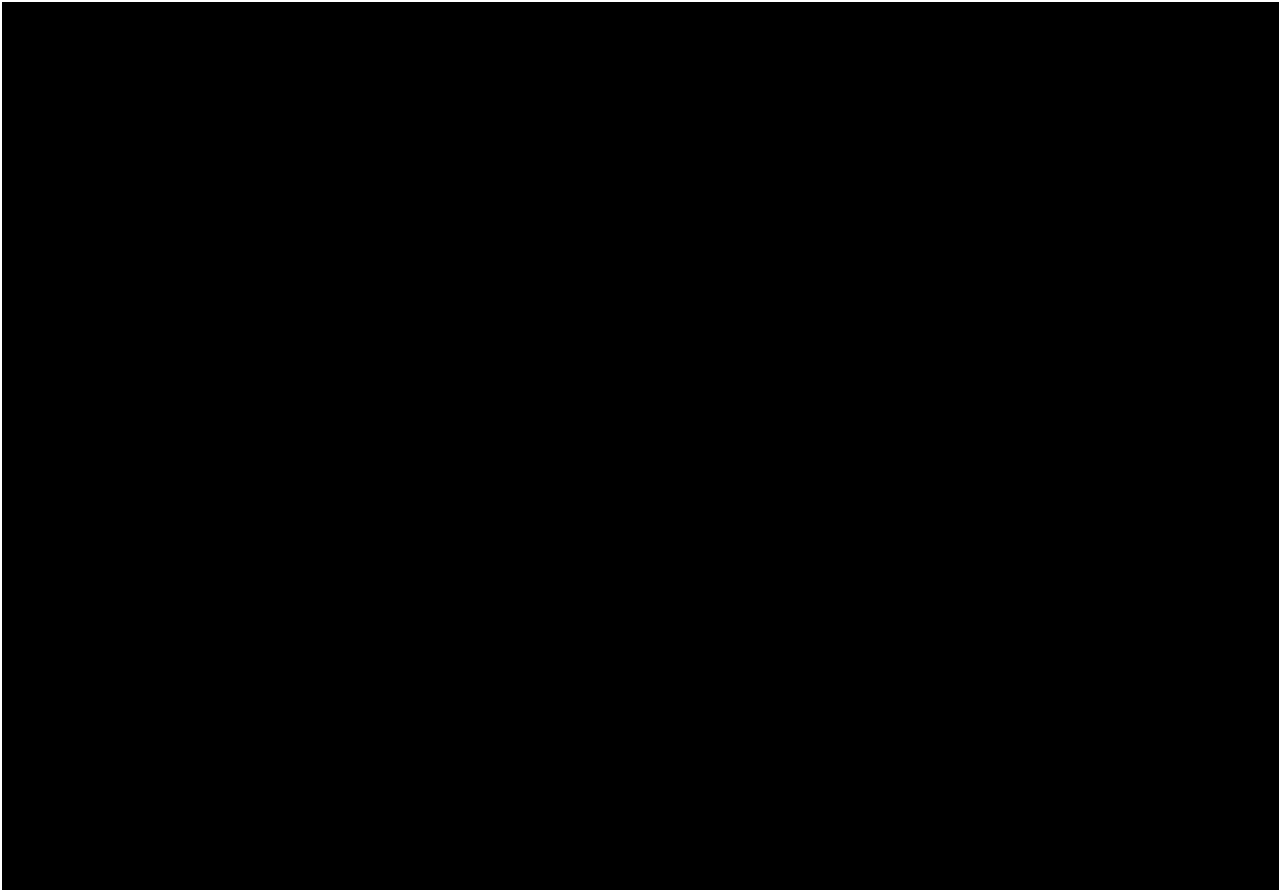
**Table 5-1:  
N-1 Thermal Violations in the Greater Hartford Area**

Element ID	Overloading Element	Worst-case Contingency	Highest Loading (one unit OOS)	Highest Loading (two units OOS)	Comments
1726	North Bloomfield to Farmington	[REDACTED]	129%	129%	[REDACTED]
1783-1	Farmington to Newington Tap	[REDACTED]	144%	144%	[REDACTED]
1751-2	Bloomfield Junction to Northwest Hartford	[REDACTED]	104%	108%	[REDACTED]
STGTN 2X	Southington 345/115 Autotransformer (2X)	[REDACTED]	103%	105%	[REDACTED]

Table 5-2 summarizes the worst-case 115 kV voltage violations seen in the Greater Hartford subarea. The corresponding violations are shown in Figure 5-11.

**Table 5-2:  
N-1 Voltage Violations in the Greater Hartford Subarea**

Bus Name	Worst-Case Contingency	Worst-Case Voltage Violations ( One unit OOS)	Worst-Case Voltage Violations (Two units OOS)	Comments
East New Britain – 115 kV	[REDACTED]	0.85	0.85	[REDACTED]
Farmington – 115 kV	[REDACTED]	0.89	0.89	[REDACTED]
Newington – 115 kV	[REDACTED]	0.85	0.85	[REDACTED]
NW Hartford – 115 kV	[REDACTED]	0.94	0.94	[REDACTED]



**Figure 5-11: N-1 Voltage Violations in the Greater Hartford Area**

### **5.2.1.3 N-1-1 Thermal and Voltage Violation Summary**

The following three tables summarize the worst-case thermal violations seen in the Greater Hartford subarea under N-1-1 conditions. The overloads are divided into three areas as discussed in Section 5.1.1.

Table 5-3 consists of the worst-case N-1-1 violations in the South Meadow, Berlin and Southington Load Area. The thermal violations are demonstrated in Figure 5-12.

The solution for this load pocket would need to be coordinated with the Middletown area solutions.



**Figure 5-12: N-1 Thermal Violations in the Greater Hartford Area**

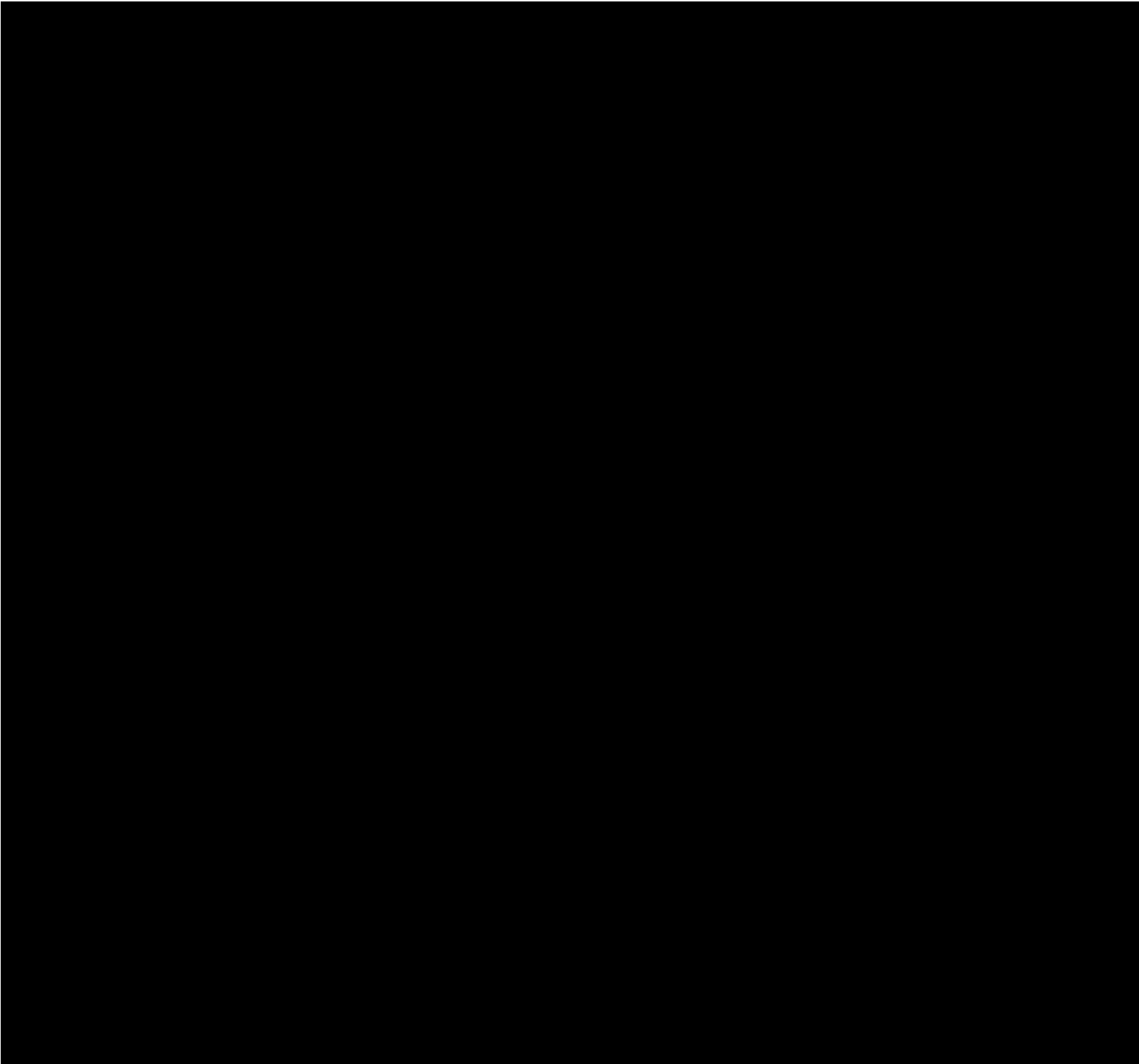
Within this load area is a load pocket consisting of the Farmington, Newington and East New Britain stations. These violations are independent of generation dispatch and are seen in the last four entries in Table 5-3.

**Table 5-3:  
N-1-1 Thermal Violations in the South Meadow, Berlin and Southington Load Area**

Element ID	Overloading Element	Initial Element OOS	Worst-Case Contingency	Highest Loading (One unit OOS)	Highest Loading (Two units OOS)	Comments
1670-1	Southington – Reservoir Rd Junction	[Redacted]	[Redacted]	102%	106%	[Redacted]
1670-2	Reservoir Road Junction - Berlin	[Redacted]	[Redacted]	<100%	101%	[Redacted]
1726	N Bloomfield to Farmington	[Redacted]	[Redacted]	158% <sup>#</sup>	167% <sup>#</sup>	[Redacted]
1752	Rocky Hill- Berlin	[Redacted]	[Redacted]	101% <sup>#</sup>	108% <sup>#</sup>	[Redacted]
1765	Berlin - Westside	[Redacted]	[Redacted]	<100%	147% <sup>#</sup>	[Redacted]
1771	Southington - Berlin	[Redacted]	[Redacted]	<100%	105%	[Redacted]

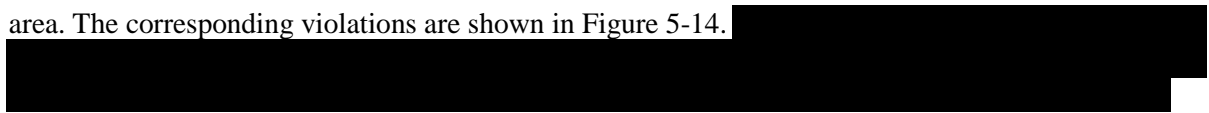
Element ID	Overloading Element	Initial Element OOS	Worst-Case Contingency	Highest Loading (One unit OOS)	Highest Loading (Two units OOS)	Comments
1773	South Meadow – Rocky Hill	[REDACTED]	[REDACTED]	150% <sup>#</sup>	158% <sup>#</sup>	[REDACTED]
1783-1	Farmington to Newington Tap	[REDACTED]	[REDACTED]	190% <sup>#</sup>	205% <sup>#</sup>	[REDACTED]
1769	Berlin to East New Britain	[REDACTED]	[REDACTED]	132%	132%	[REDACTED]
1783-2	Newington Tap to Newington	[REDACTED]	[REDACTED]	149% <sup>#</sup>	149% <sup>#</sup>	[REDACTED]
1783-3	East New Britain to Newington Tap	[REDACTED]	[REDACTED]	107%	107%	[REDACTED]
1785	Berlin to Newington	[REDACTED]	[REDACTED]	189% <sup>#</sup>	189% <sup>#</sup>	[REDACTED]

<sup>#</sup>Low Voltages Aggravate Thermal Loadings



**Figure 5-13: N-1-1 Thermal Violations in the South Meadow, Berlin and Southington Area**

Table 5-4 consists of the N-1-1 thermal violations seen in the North Bloomfield to Manchester load area. The corresponding violations are shown in Figure 5-14.

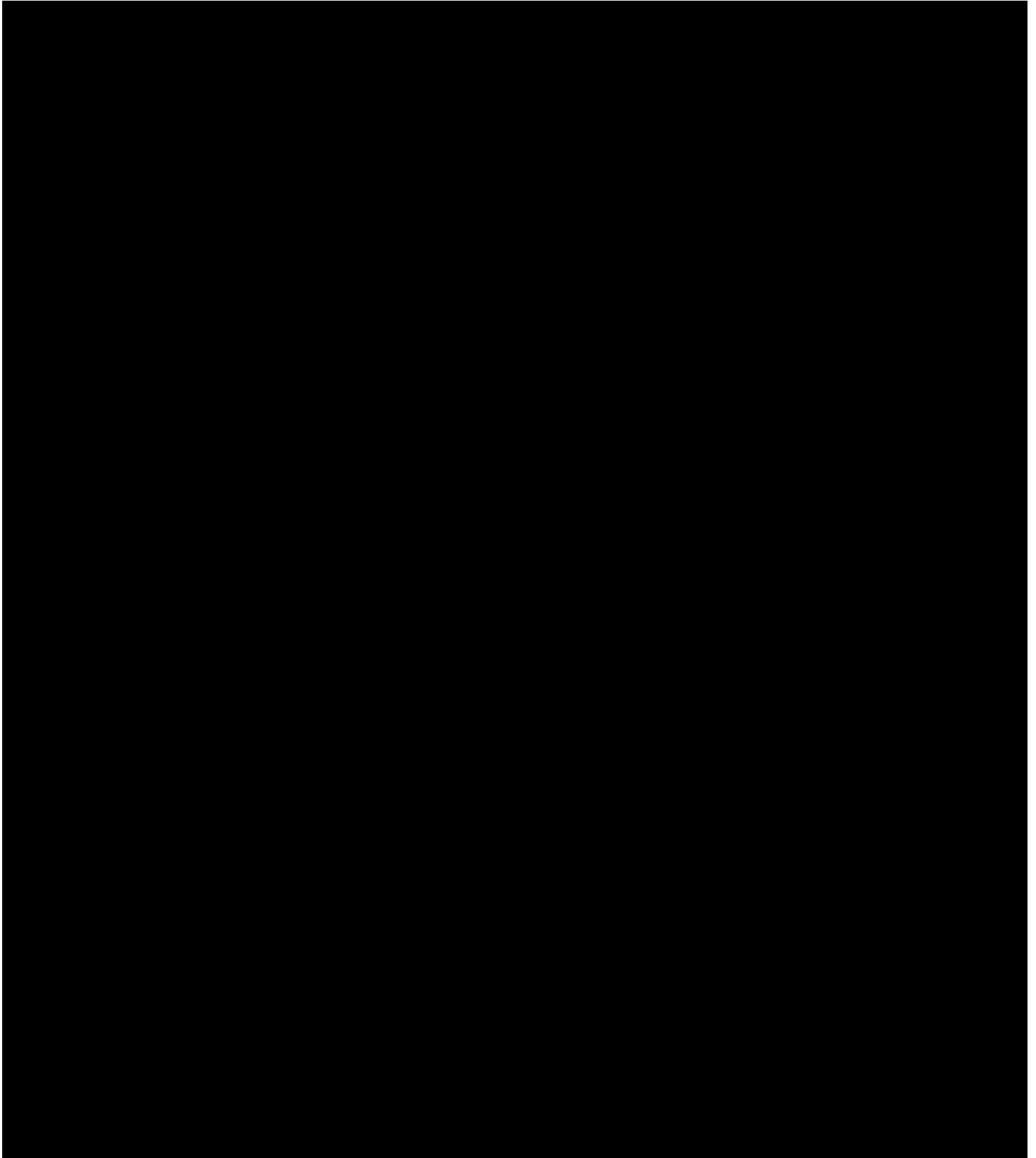


**Table 5-4:  
N-1-1 Thermal Violations in the North Bloomfield – Manchester Load Area**

Element ID	Overloading Element	Initial Element OOS	Worst-Case Contingency	Highest Loading (One unit OOS)	Highest Loading (Two units OOS)	Comments
1207	Manchester – East Hartford	[REDACTED]	[REDACTED]	119%	123%	[REDACTED]
1704	South Meadow to SW Hartford	[REDACTED]	[REDACTED]	131%	131%	[REDACTED]
1722-1	SW Hartford to Capitol District Tap	[REDACTED]	[REDACTED]	109%	109%	[REDACTED]
1722-2	Capitol District Tap to NW Hartford	[REDACTED]	[REDACTED]	116%	119%	[REDACTED]
1751-2	Bloomfield Junction to NW Hartford	[REDACTED]	[REDACTED]	165%	172%	[REDACTED]
1756	Bloomfield to NW Hartford	[REDACTED]	[REDACTED]	119%#	119%#	[REDACTED]
1777	N Bloomfield to Bloomfield	[REDACTED]	[REDACTED]	154%	160%	[REDACTED]
1775-1	Riverside Tap – South Meadow	[REDACTED]	[REDACTED]	111%	116%	[REDACTED]
1775-2	Manchester – Riverside Tap	[REDACTED]	[REDACTED]	117%	122%	[REDACTED]
1779	South Meadow to Bloomfield	[REDACTED]	[REDACTED]	174%#	174%#	[REDACTED]
1786	East Hartford – 1786 Tap	[REDACTED]	[REDACTED]	112%	117%	[REDACTED]
NWHTFD 32T	Breaker 32T Bus Segment	[REDACTED]	[REDACTED]	123%	127%	[REDACTED]

#Low Voltages Aggravate Thermal Loadings





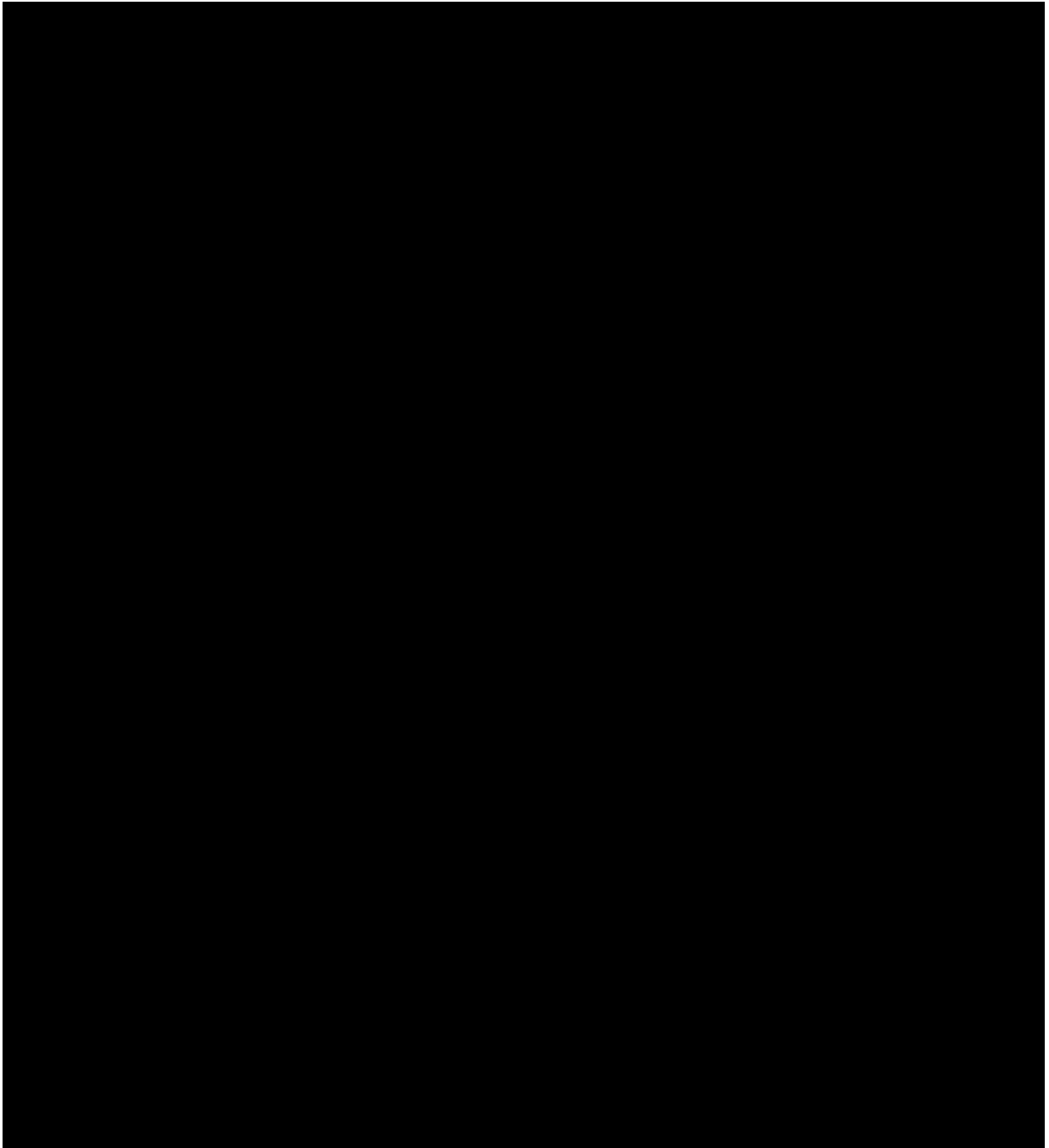
**Figure 5-14: N-1-1 Thermal Violations in the North Bloomfield – Manchester Area**

Finally, the last set of thermal violations in the Greater Hartford subarea under N-1-1 conditions are the two Southington 345/115 kV autotransformers (Southington 2X and Southington 3X) and a 115 kV lines between Southington and southwest Connecticut. These overloads are [REDACTED] shown in Table 5-5 and Figure

5-15

**Table 5-5:  
N-1-1 Thermal Violations in the Southington Area**

Element ID	Overloading Element	Initial Element OOS	Worst-Case Contingency	Highest Loading (One unit OOS)	Highest Loading (Two units OOS)	Comments
STGTN 2X	Southington 345/115 Autotransformer	[REDACTED]	[REDACTED]	146%	148%	[REDACTED]
STGTN 2X	Southington 345/115 Autotransformer	[REDACTED]	[REDACTED]	114%	116%	[REDACTED]
STGTN 3X	Southington 345/115 Autotransformer	[REDACTED]	[REDACTED]	114%	115%	[REDACTED]
1950	Southington to Canal	[REDACTED]	[REDACTED]	N/A	101%	[REDACTED]



**Figure 5-15: N-1-1 Thermal Violations in the Southington Area**

The tables below summarize the worst-case voltage violations seen in the Greater Hartford subarea under N-1-1 conditions. Once again the violations are arranged with the three load areas. All violations observed were low-voltage violations.

Table 5-6 has the voltage violations seen in the South Meadow, Berlin and Southington Load Area



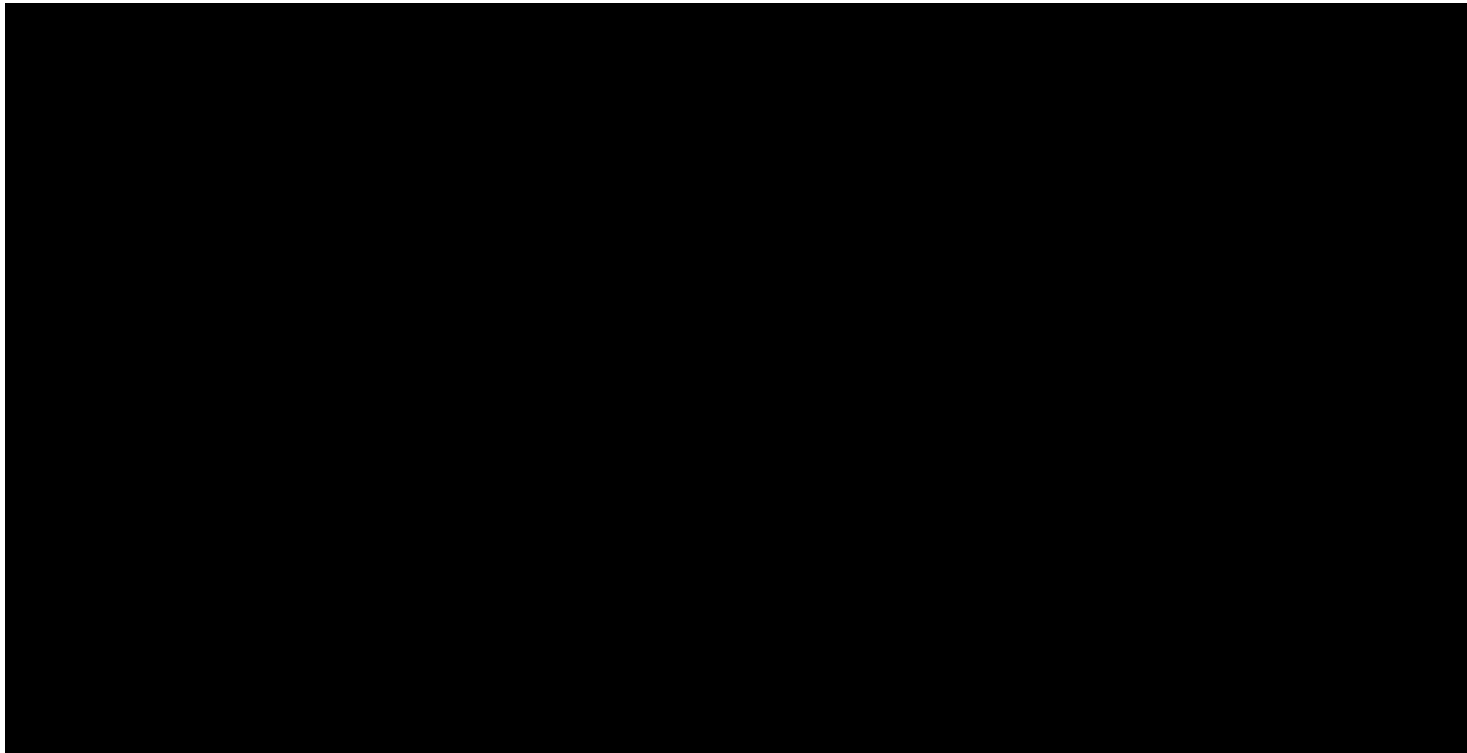
The last two entries in Table 5-6 are non-PTF buses in the Hartford subarea with voltage violations. The non-PTF violations will be recorded in this report but will not be specifically addressed in the solutions study report.

The voltage violations for the South Meadow, Berlin and Southington area are shown in Figure 5-16.

**Table 5-6:  
N-1-1 Voltage Violations in the South Meadow, Berlin and Southington Load Area**

Bus Name	Initial Element OOS	Worst-Case Contingency	Worst-Case Voltage Violations ( One unit OOS)	Worst-Case Voltage Violations (Two units OOS)	Comments
East New Britain – 115 kV	[REDACTED]	[REDACTED]	0.82	0.82	[REDACTED]
Farmington – 115 kV	[REDACTED]	[REDACTED]	0.82	0.81	[REDACTED]
Newington – 115 kV	[REDACTED]	[REDACTED]	0.82	0.82	[REDACTED]
Berlin – 115 kV	[REDACTED]	[REDACTED]	0.84	0.83	[REDACTED]
Rocky Hill – 115 kV	[REDACTED]	[REDACTED]	0.83	0.82	[REDACTED]
Westside – 115 kV	[REDACTED]	[REDACTED]	0.93	0.81	[REDACTED]
Westside – 115 kV <sup>17</sup>	[REDACTED]	[REDACTED]	0.87	0.85	[REDACTED]
Black Rock – 115 kV (non-PTF)	[REDACTED]	[REDACTED]	0.83	0.82	[REDACTED]
GE – 115 kV (non-PTF)	[REDACTED]	[REDACTED]	0.84	0.82	[REDACTED]

<sup>17</sup> Additional entry to reflect worst-case One-unit out-of-service violation



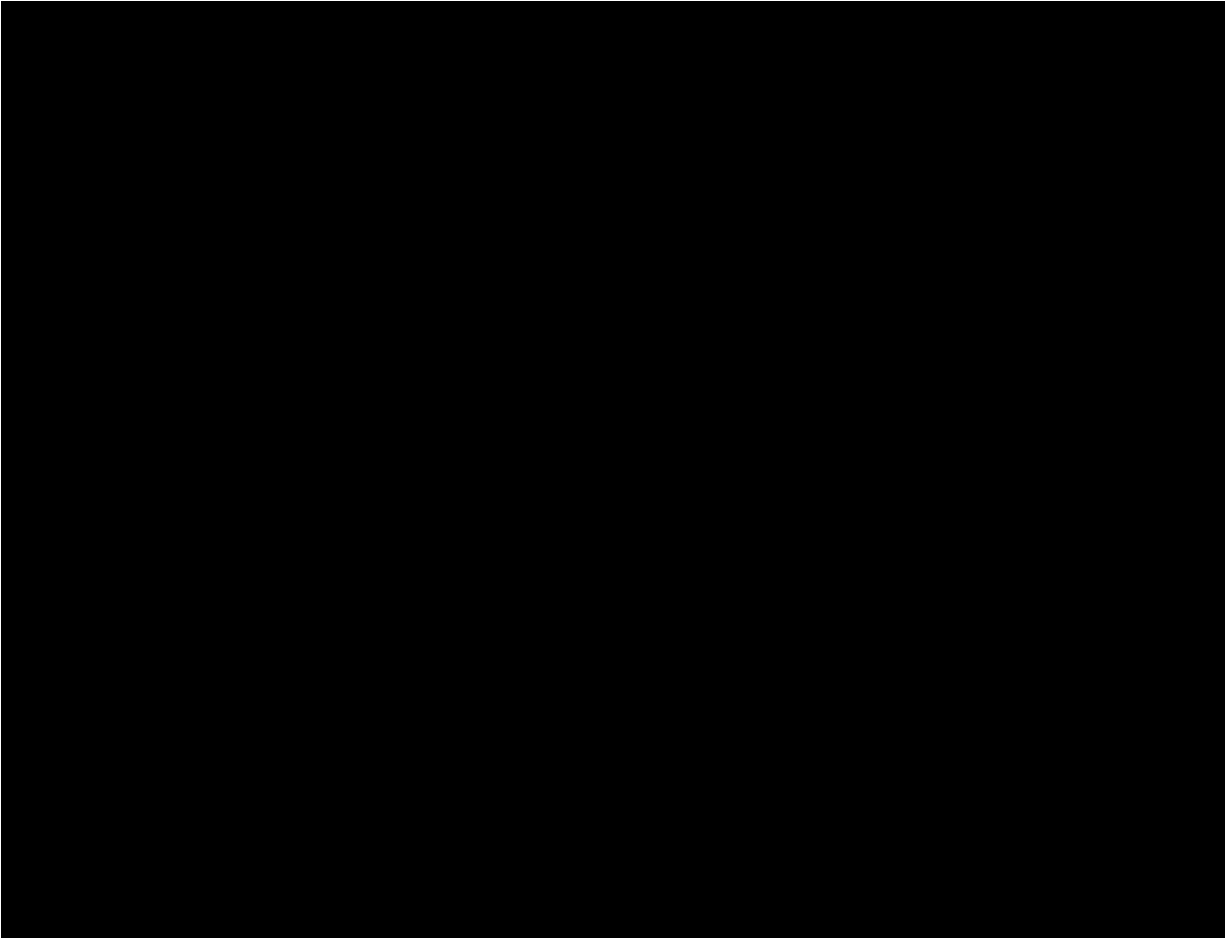
**Figure 5-16: N-1-1 Voltage Violations in the South Meadow, Berlin and Southington Load Area**

Table 5-7 lists the voltage violations seen in the North Bloomfield - Manchester Load Area [REDACTED]. The voltage results for this area are shown in Figure 5-17.

**Table 5-7:  
N-1-1 Voltage Violations in the North Bloomfield – Manchester Load Area**

Bus Name	Initial Element OOS	Worst-Case Contingency	Worst-Case Voltage Violations ( One unit OOS)	Worst-Case Voltage Violations (Two units OOS)	Comments
Bloomfield – 115 kV	[REDACTED]	[REDACTED]	0.83	0.82	[REDACTED]
Capitol District – 115 kV	[REDACTED]	[REDACTED]	0.79*	0.79*	[REDACTED]
NW Hartford – 115 kV	[REDACTED]	[REDACTED]	0.79*	0.79*	[REDACTED]
SW Hartford – 115 kV	[REDACTED]	[REDACTED]	0.79*	0.79*	[REDACTED]

\*Indicates Potential Voltage Collapse



**Figure 5-17: N-1-1 Voltage Violations in the North Bloomfield – Manchester Load Area**

### **5.2.2 Manchester and Barbour Hill Area Steady-State Performance**

The Manchester and Barbour Hill Area had five transmission elements with N-1-1 thermal violations and two 115 kV PTF buses with N-1-1 low voltage violations. Additionally, there were four non-PTF buses with N-1-1 voltage violations. There were no N-0 or N-1 steady-state criteria violations.

#### **5.2.2.1 N-0 Thermal and Voltage Violation Summary**

There were no N-0 violations in the Manchester and Barbour Hill subarea.

#### **5.2.2.2 N-1 Thermal and Voltage Violation Summary**

There were no N-1 violations in the Manchester and Barbour Hill subarea.

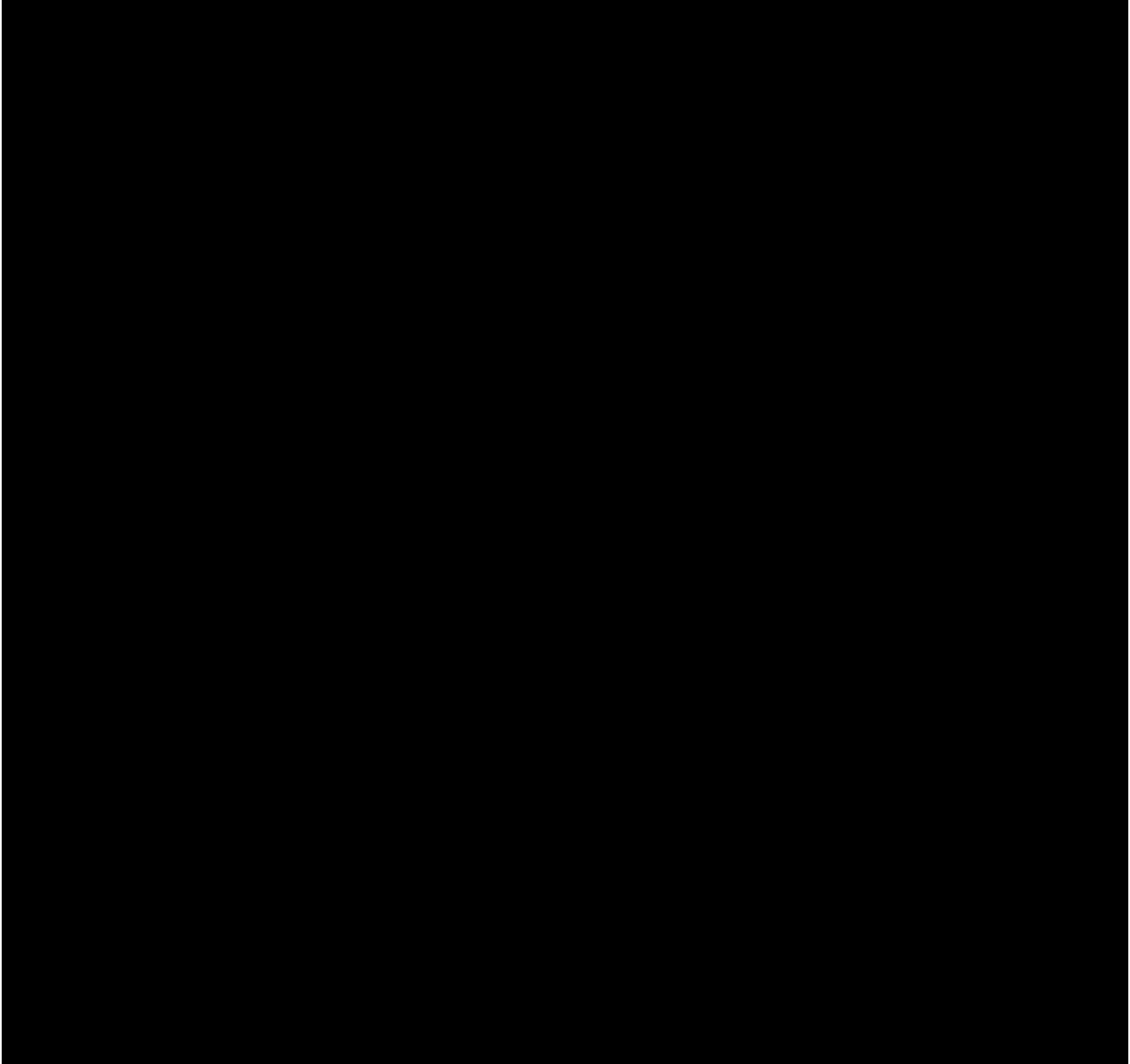
#### **5.2.2.3 N-1-1 Thermal and Voltage Violation Summary**

Table 5-8 lists the five transmission elements that have thermal violations in the Manchester-Barbour Hill area. The table also lists the worst-case contingency elements and conditions that lead to these violations. [REDACTED]

All the worst-case thermal violations are demonstrated in Figure 5-18.

**Table 5-8:  
N-1-1 Thermal Violations in the Manchester and Barbour Hill Area**

Element ID	Overloading Element	Initial Element OOS	Worst-Case Contingency	Highest Loading (One unit OOS)	Highest Loading (Two units OOS)	Comments
1310	Manchester – South Windsor	[REDACTED]	[REDACTED]	152%	153%	[REDACTED]
1635	South Windsor – Barbour Hill	[REDACTED]	[REDACTED]	134%	135%	[REDACTED]
1763	Manchester – Barbour Hill	[REDACTED]	[REDACTED]	146%	147%	[REDACTED]
MANCH 4X	Manchester 345/115 Autotransformer	[REDACTED]	[REDACTED]	119%	124%	[REDACTED]
MANCH 6X	Manchester 345/115 Autotransformer	[REDACTED]	[REDACTED]	122%	127%	[REDACTED]



**Figure 5-18: N-1-1 Thermal Violations in the Manchester and Barbour Hill Area**





Table 5-9 provides the worst-case N-1-1 low voltage violations in the Manchester and Barbour Hill area.

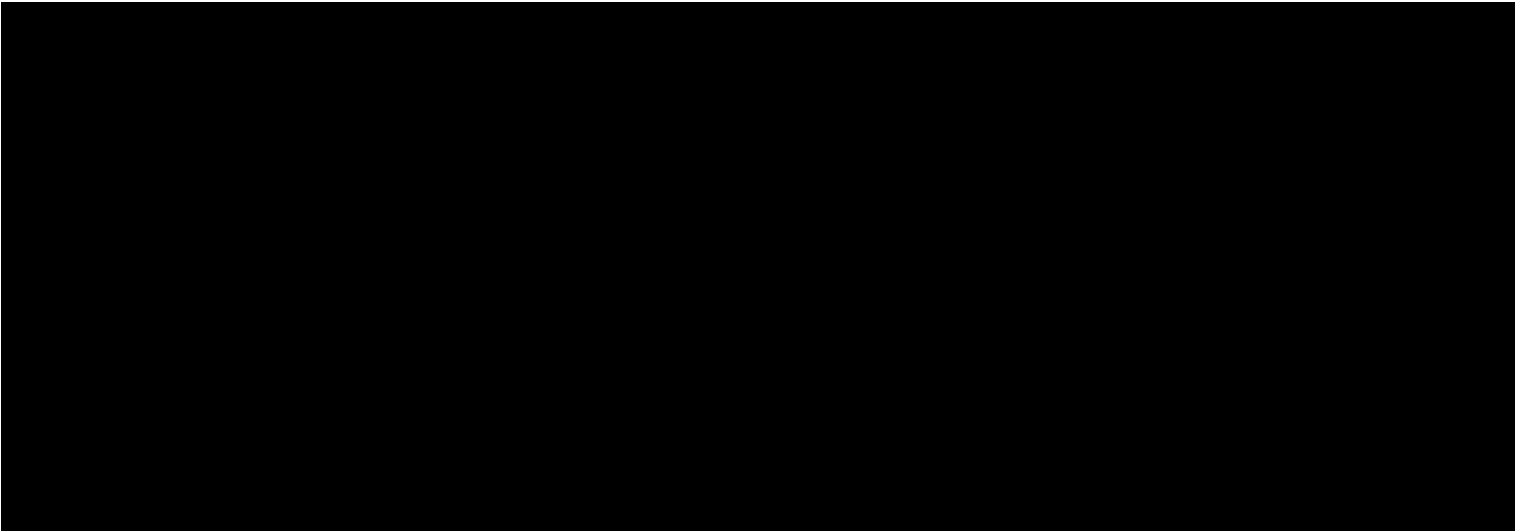
there is no significant difference in the extent of the voltage violation between the one and two units out of service cases.

The first two violations are observed at PTF buses whereas the last four buses are voltage violations at non-PTF buses.

The voltage violations for the Manchester-Barbour Hill area are demonstrated in Figure 5-19.

**Table 5-9:  
N-1-1 Voltage Violations in the Manchester and Barbour Hill Area**

Bus Name	Initial Element OOS	Worst-Case Contingency	Worst-Case Voltage Violations ( One unit OOS)	Worst-Case Voltage Violations (Two units OOS)	Comments
Barbour Hill – 115 kV	[REDACTED]	[REDACTED]	0.87	0.87	[REDACTED]
South Windsor– 115 kV	[REDACTED]	[REDACTED]	0.92	0.92	[REDACTED]
Windsor Locks – 115 kV (Non-PTF)	[REDACTED]	[REDACTED]	0.85	0.85	[REDACTED]
Dexter– 115 kV (Non-PTF)	[REDACTED]	[REDACTED]	0.85	0.85	[REDACTED]
Enfield – 115 kV (Non-PTF)	[REDACTED]	[REDACTED]	0.85	0.85	[REDACTED]
Rockville – 115 kV (Non-PTF)	[REDACTED]	[REDACTED]	0.86	0.86	[REDACTED]



**Figure 5-19: N-1-1 Voltage Violations in the Manchester and Barbour Hill Area**

**5.2.3 Middletown Subarea Steady-State Performance**

The Middletown subarea had no N-1 thermal violations and three 115 kV buses with N-1 low voltage violations. Under N-1-1 conditions, there were 11 elements with thermal violations and fourteen 115 kV buses with low voltage violations. There were no N-0 violations.

**5.2.3.1 N-0 Thermal and Voltage Violation Summary**

There were no N-0 violations in the Middletown subarea.

**5.2.3.2 N-1 Thermal and Voltage Violation Summary**

There were no N-1 thermal violations observed in the Middletown area.

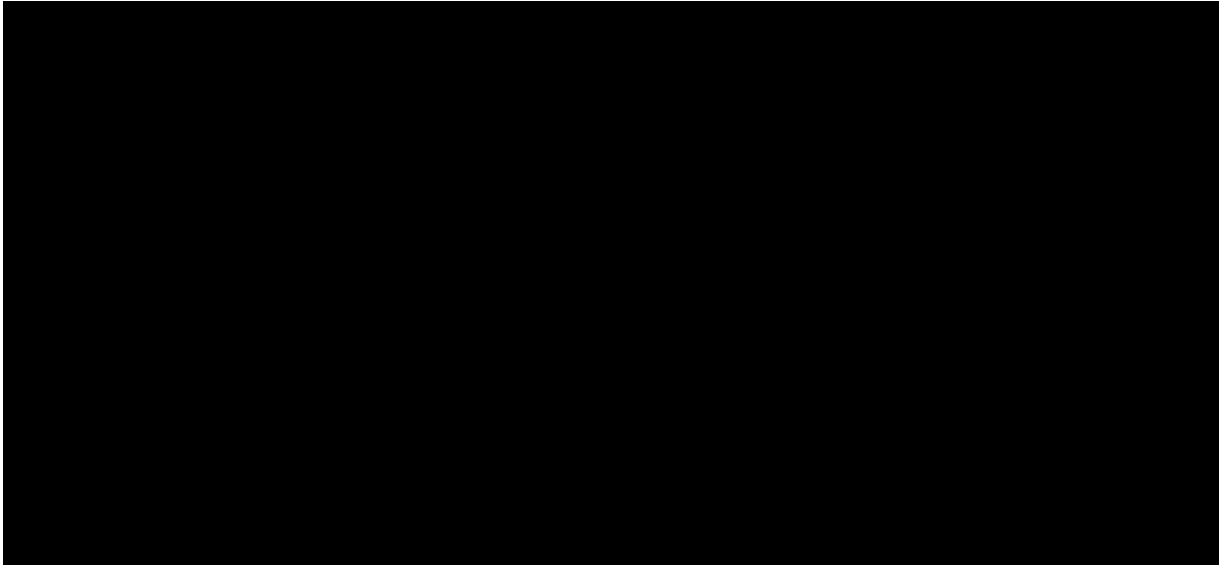
Table 5-10 summarizes the worst-case 115 kV voltage violations seen in the Middletown subarea.



The N-1 voltage violations in the Middletown subarea are shown in Figure 5-20.

**Table 5-10:  
N-1 Voltage Violations in the Middletown Subarea**

Bus Name	Worst-Case Contingency	Worst-Case Voltage Violations ( One unit OOS)	Worst-Case Voltage Violations (Two units OOS)	Comments
Branford – 115 kV	[REDACTED]	0.92	0.92	[REDACTED]
Green Hill – 115 kV	[REDACTED]	0.93	0.93	[REDACTED]
Stepstone – 115 kV	[REDACTED]	0.92	0.92	[REDACTED]



**Figure 5-20: N-1 Voltage Violations in the Middletown Subarea**

### **5.2.3.3 N-1-1 Thermal and Voltage Violation Summary**

Table 5-11 summarizes the worst-case thermal violations seen in the Middletown subarea under N-1-1 conditions. [Redacted]

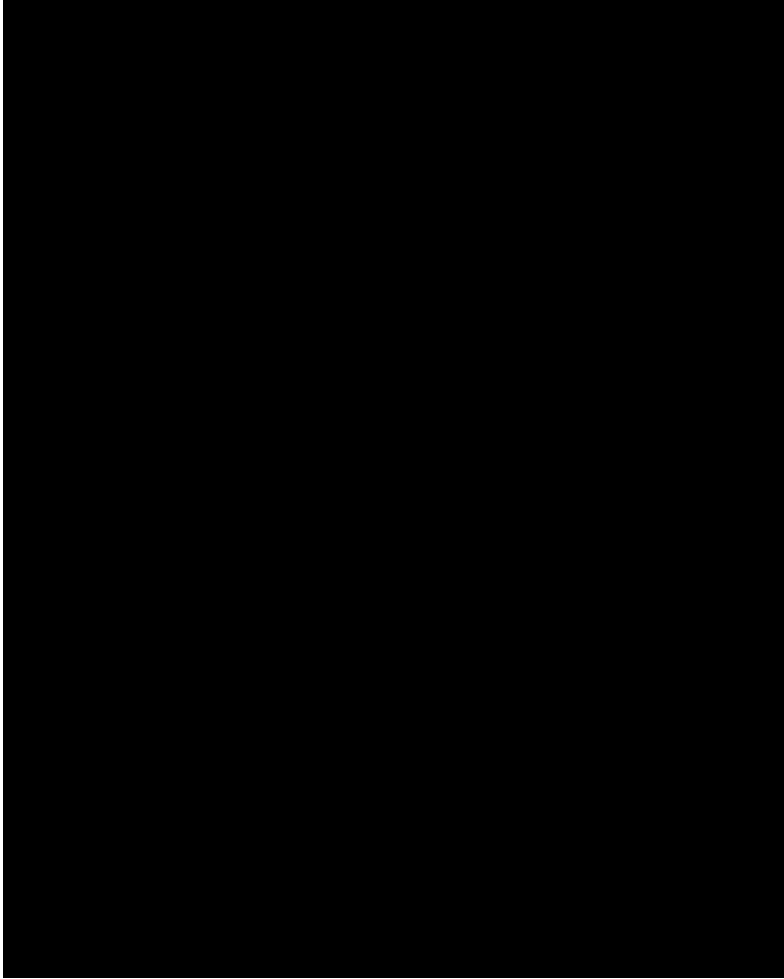
[Redacted]	[Redacted]
[Redacted]	[Redacted]
[Redacted]	[Redacted]
[Redacted]	[Redacted]
[Redacted]	[Redacted]

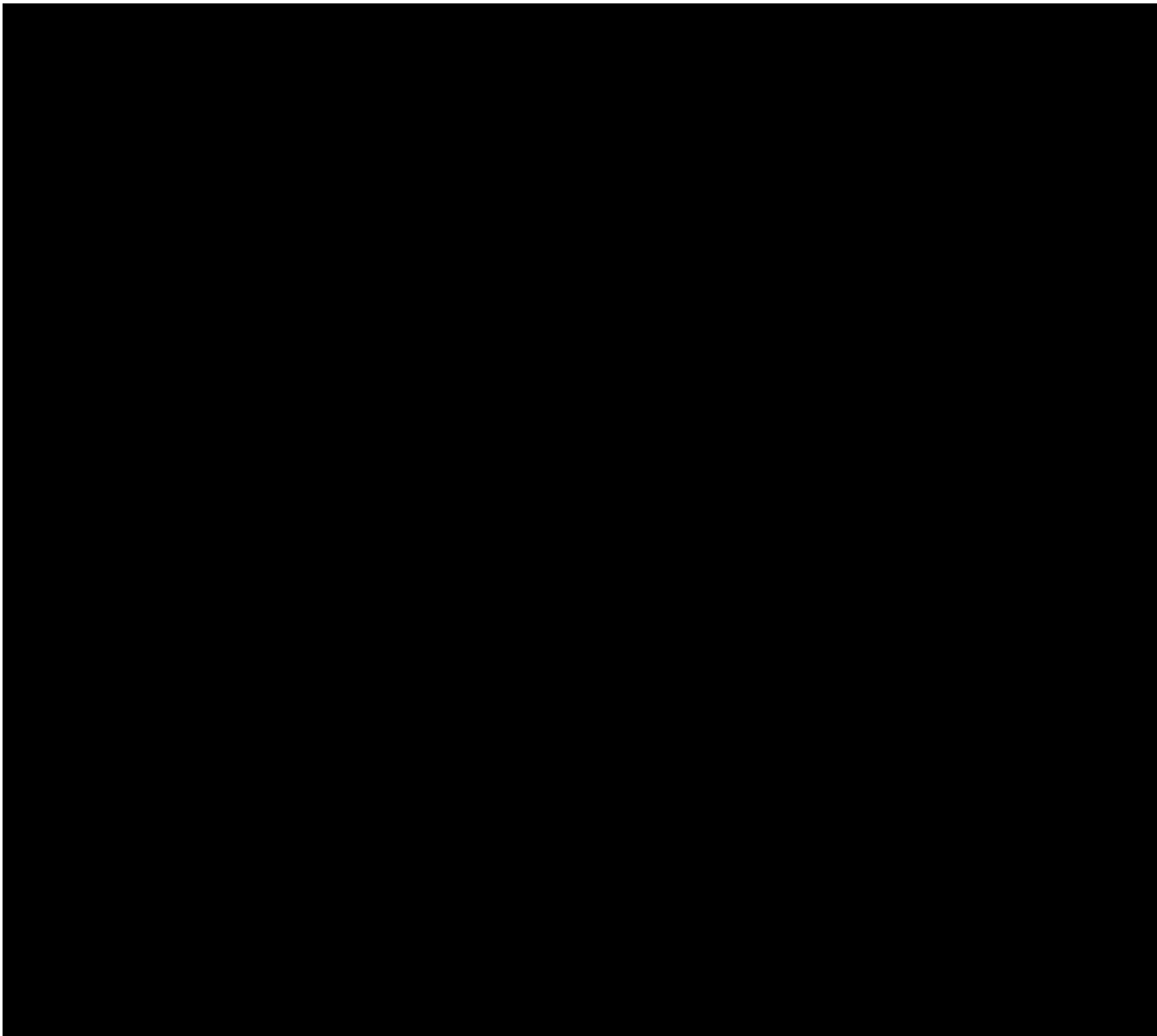
**Table 5-11:  
N-1-1 Thermal Violations in the Middletown Subarea**

Element ID	Overloading Element	Initial Element OOS	Worst-Case Contingency	Highest Loading (One unit OOS)	Highest Loading (Two units OOS)	Comments
1355-1	Hanover Tap – Colony	[REDACTED]	[REDACTED]	126%#	148%#	[REDACTED]
1355-3	Southington – Hanover Tap	[REDACTED]	[REDACTED]	118%#	134%#	[REDACTED]
1443	Portland – Middletown	[REDACTED]	[REDACTED]	N/A	118%#	[REDACTED]
1588	Colony – N Wallingford	[REDACTED]	[REDACTED]	133%#	159%#	[REDACTED]
1759	Hopewell – Portland	[REDACTED]	[REDACTED]	N/A	132%#	[REDACTED]
1050	Middletown – Dooley	[REDACTED]	[REDACTED]	152%#	152%#	[REDACTED]
1766	Dooley - Westside	[REDACTED]	[REDACTED]	145%#	145%#	[REDACTED]
1261	Haddam - Bokum (Circuit 1)	[REDACTED]	[REDACTED]	107%#	107%#	[REDACTED]
1598	Haddam - Bokum (Circuit 2)	[REDACTED]	[REDACTED]	108%#	109%#	[REDACTED]
1620	Middletown – Haddam	[REDACTED]	[REDACTED]	111%	121%	[REDACTED]
362	Haddam Neck – Beseck	[REDACTED]	[REDACTED]	N/A	105%	[REDACTED]

#Low Voltages Aggravate Thermal Loadings

The thermal violations in the Middletown area are shown in the three diagrams that form Figure 5-21.





**Figure 5-21: N-1-1 Thermal Violations in the Middletown Subarea**

Table 5-12 summarizes the worst-case voltage violations seen in the Middletown subarea under N-1-1 conditions. [Redacted]

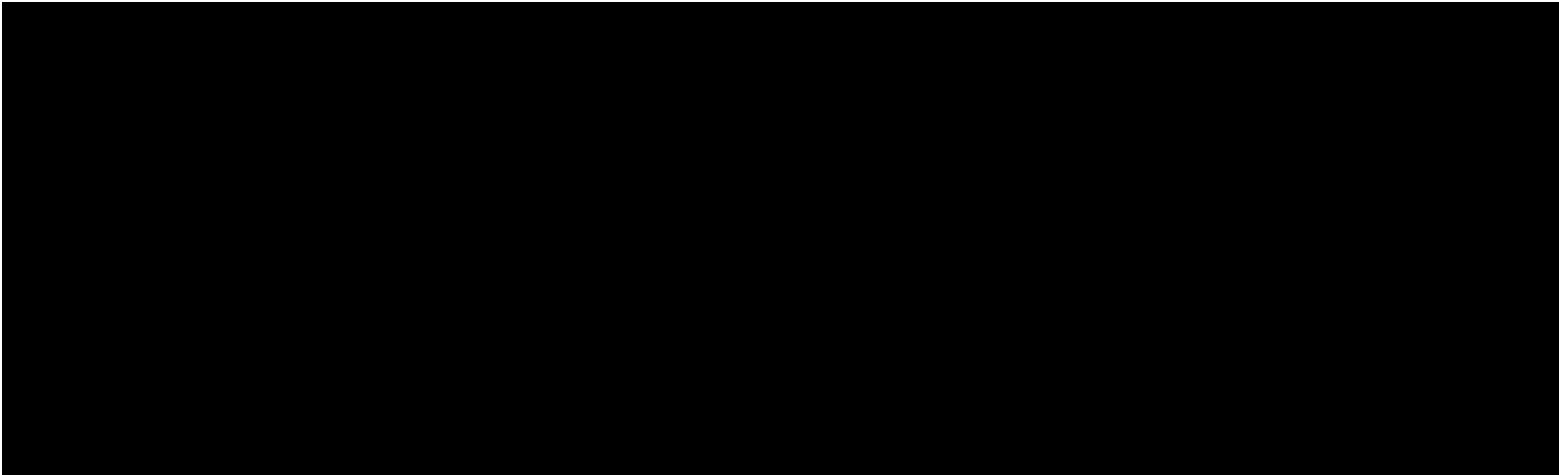
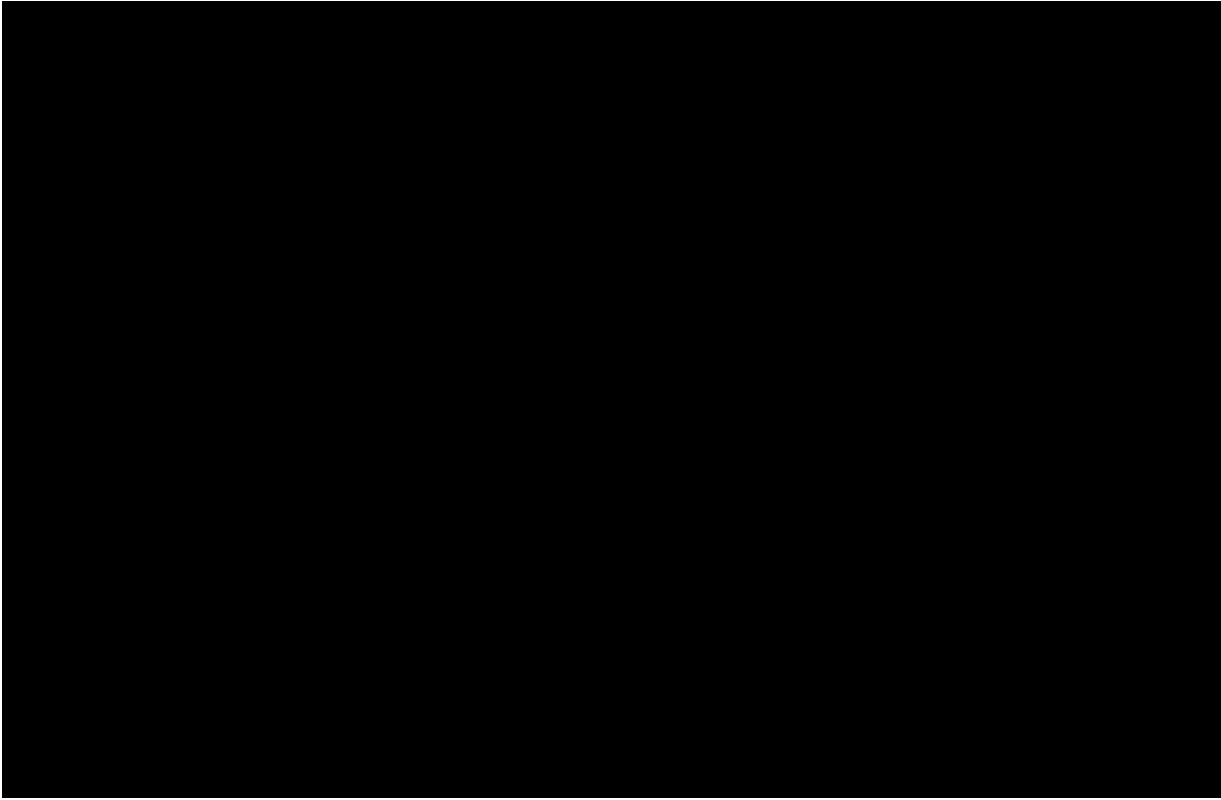
**Table 5-12:  
N-1-1 Voltage Violations in the Middletown Subarea**

Bus Name	Initial Element OOS	Worst-Case Contingency	Worst-Case Voltage Violations ( One unit OOS)	Worst-Case Voltage Violations (Two units OOS)	Comments
Bokum – 115 kV	████	██████████	0.79*	0.74*	████████████████████ ████████████████████
Branford – 115 kV	██	██████████████████	0.82	0.73*	████████████████████ ████████████████████
Colony – 115 kV	████	██████████████████	0.88	0.84	████████████████████ ████████████████████
Dooley – 115 kV	████	██████████████████	0.91	0.80	████████████████████ ████████████████████
Dooley – 115 kV <sup>18</sup>	████ ██████████	██████████████████	0.90	0.90	████████████████████ ████████████████████
East Meriden – 115 kV	████ ██████████	██████████████████ ██████████████████	0.88	0.84	████████████████████ ████████████████████
Green Hill – 115 kV	████	██████████████████	0.73*	0.68*	████████████████████ ████████████████████
Haddam – 115 kV	████	██████████████████	0.84	0.78*	████████████████████ ████████████████████
Hanover – 115 kV	██	██████████████████	0.91	0.87	████████████████████ ████████████████████
Hopewell – 115 kV	████	██████████████████	0.85	0.72*	████████████████████ ████████████████████
Middletown – 115 kV	████	██████████████████	0.90	0.77*	████████████████████ ████████████████████
N-Wallingford – 115 kV	████	██████████████████	0.88	0.84	████████████████████ ████████████████████
Portland – 115 kV	████	██████████████████	0.89	0.76*	████████████████████ ████████████████████
Pratt & Whitney – 115 kV	████	██████████████████	0.91	0.82	████████████████████ ████████████████████
Pratt & Whitney – 115 kV	████	██████████████████	0.89	0.83	████████████████████ ████████████████████
Stepstone – 115 kV	████	██████████████████	0.73*	0.68*	████████████████████ ████████████████████

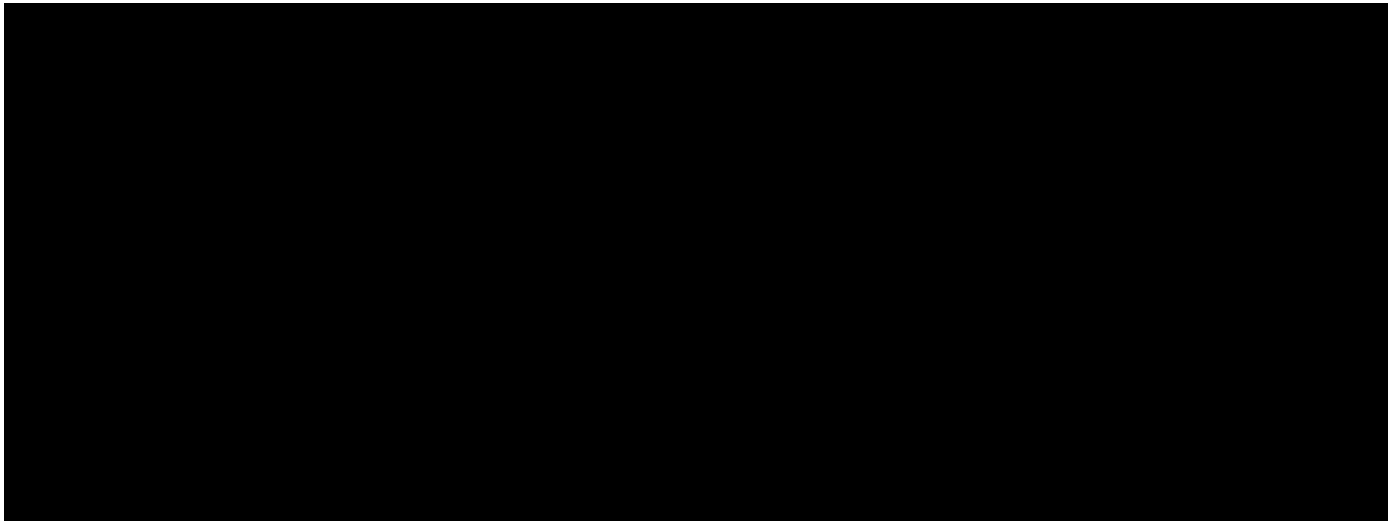
\*Indicates Potential Voltage Collapse

<sup>18</sup> Additional entry to reflect worst-case One-unit out-of-service violation

The voltage violations in the Middletown area are shown in the three diagrams that form Figure 5-22.







**Figure 5-22: N-1-1 Voltage Violations in the Middletown Subarea**

**5.2.4 Northwestern Connecticut Subarea Steady-State Performance**

The Northwestern Connecticut (NWCT) subarea had three transmission elements with N-1 thermal violations and five PTF buses with N-1 low-voltage violations. Two non-PTF buses had N-1 voltage violations. Under N-1-1 conditions, there were ten elements with thermal violations and twelve PTF buses with low voltage violations. Two non-PTF buses had N-1-1 voltage violations. There were no N-0 thermal violations, but one 69 kV non-PTF bus had N-0 basecase voltage violation.

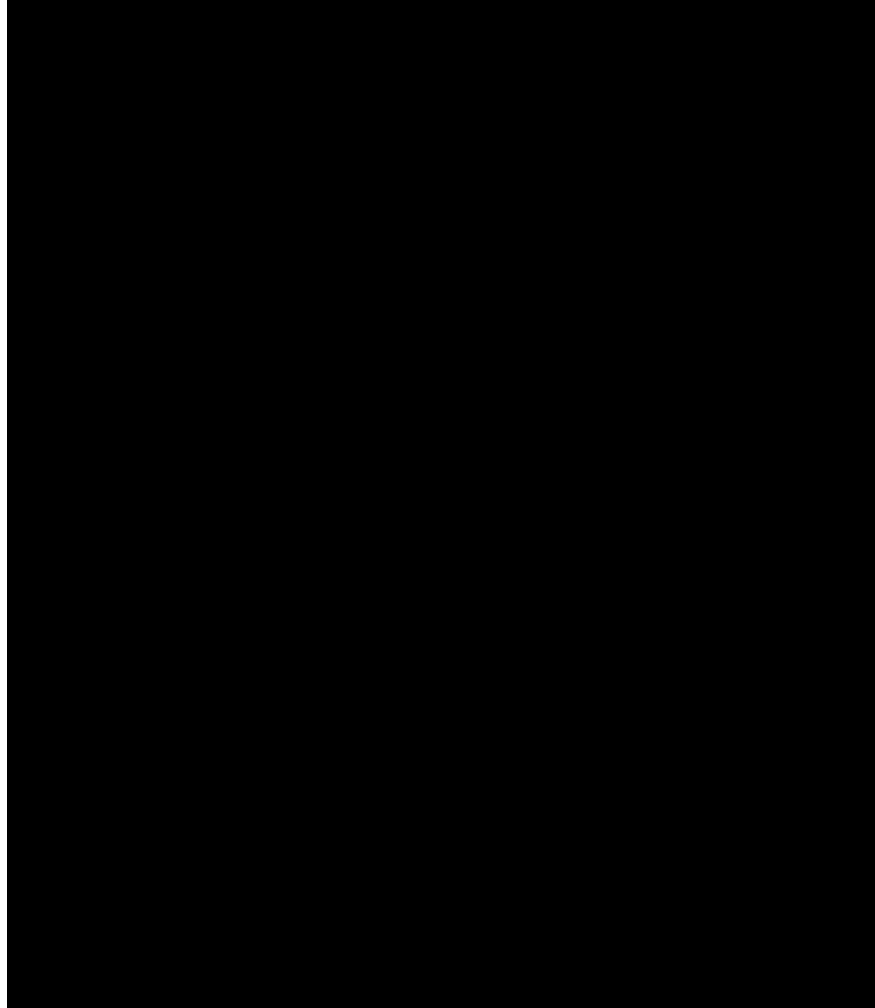
**5.2.4.1 N-0 Thermal and Voltage Violation Summary**

There were no N-0 thermal violations in the NWCT subarea.

From a voltage violation perspective, there was one bus with base case low voltage violations on the 69 kV network in Northwestern CT. Table 5-13 summarizes the worst-case N-0 voltage violations in the NWCT subarea. The North Canaan 69 kV bus is a non-PTF bus and is radial out of the PTF bus at Torrington 69 kV.

**Table 5-13:  
N-0 Voltage Violations in the NWCT Subarea**

Bus Name	Worst-Case Contingency	Worst-Case Voltage Violations (One unit OOS)	Worst-Case Voltage Violations (Two units OOS)	Comments
North Canaan – 69 kV (non-PTF)	Basecase	N/A	0.94	Lowest voltages seen for NWCT Gen OOS



**Figure 5-23 N-0 Voltage Violations in the NWCT Subarea**

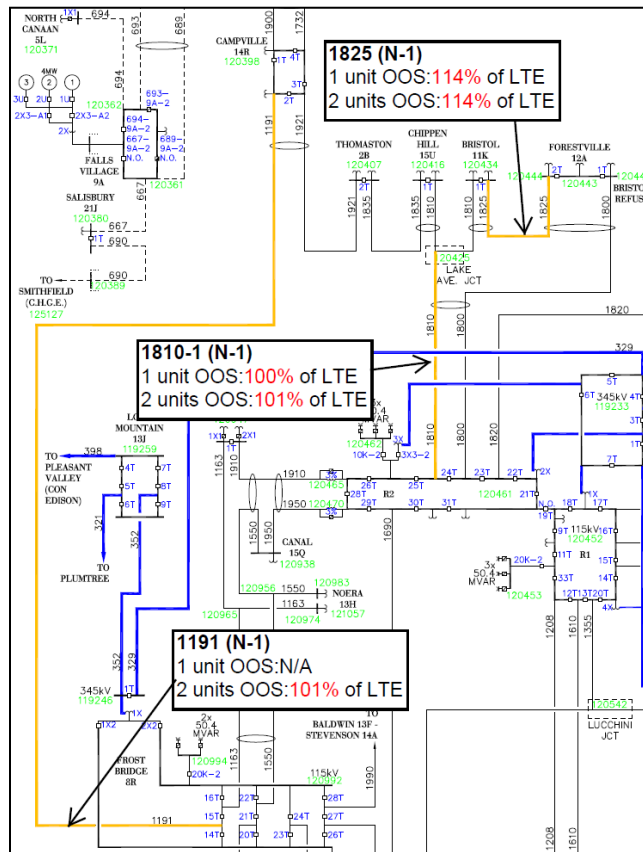
#### **5.2.4.2 N-1 Thermal and Voltage Violation Summary**

Table 5-14 summarizes the worst-case thermal violations under N-1 conditions in the Northwestern Connecticut subarea. [REDACTED]

The N-1 thermal violations in the NWCT subarea are shown in Figure 5-24.

**Table 5-14:  
N-1 Thermal Violations in the NWCT Subarea**

Element ID	Overloading Element	Worst-Case Contingency	Highest Loading (One unit OOS)	Highest Loading (Two units OOS)	Comments
1191	Frost Bridge - Campville	[REDACTED]	N/A	101%	[REDACTED]
1810-1	Southington – Lake Ave Junction	[REDACTED]	100%	101%	[REDACTED]
1825	Bristol - Forestville	[REDACTED]	114%	114%	[REDACTED]



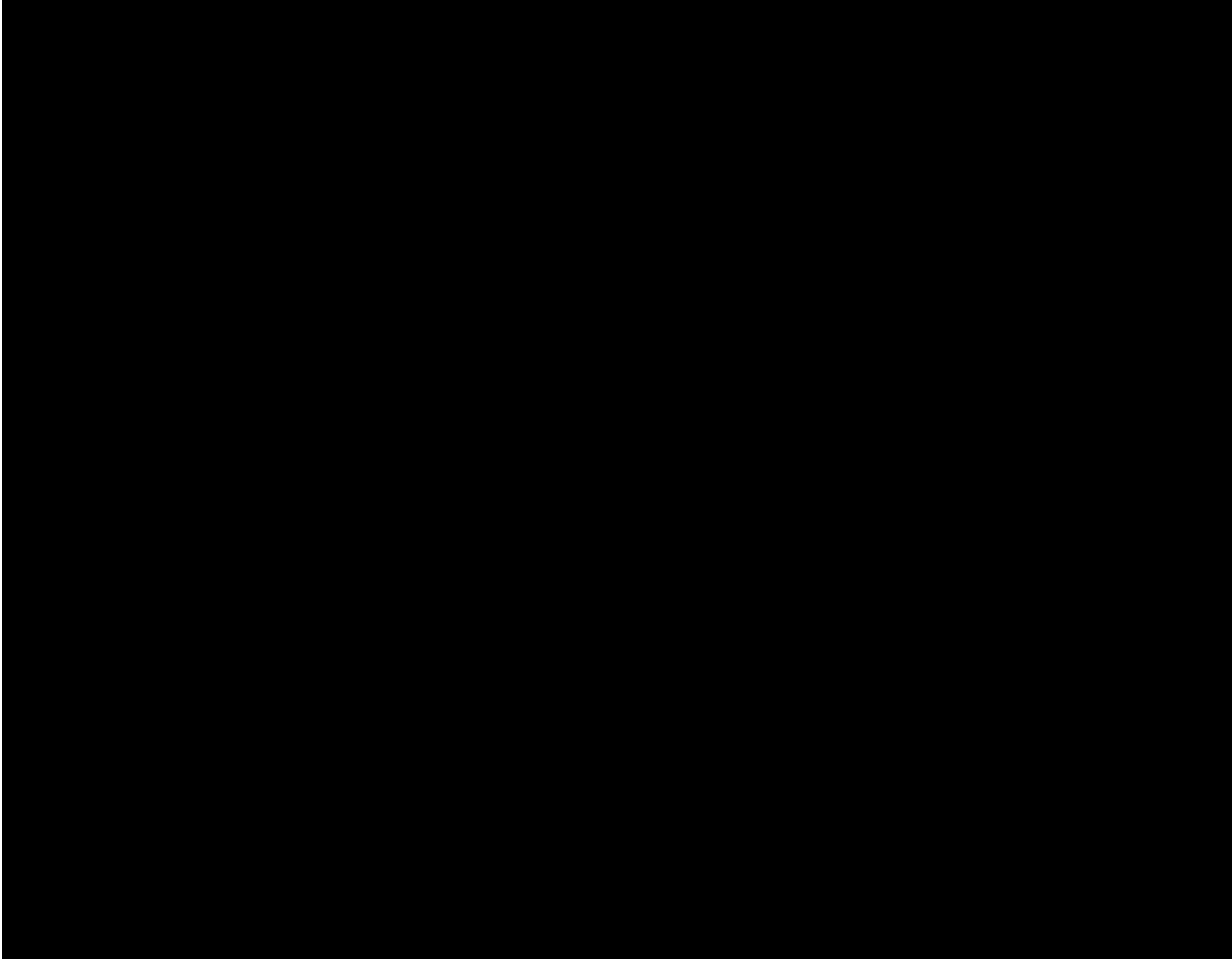
**Figure 5-24: N-1 Thermal Violations in the NWCT Subarea**

Table 5-15 summarizes the worst-case N-1 voltage violations in the NWCT subarea. [REDACTED]

The N-1 voltage violations in the NWCT subarea are shown in Figure 5-25.

**Table 5-15:  
N-1 Voltage Violations in the NWCT Subarea**

Bus Name	Worst-case Contingency	Worst-case Voltage Violations (One unit OOS)	Worst-case Voltage Violations (Two units OOS)	Comments
Campville – 115 kV	[REDACTED]	0.90	0.89	[REDACTED]
Canton – 115 kV	[REDACTED]	0.87	0.87	[REDACTED]
Forestville – 115 kV	[REDACTED]	0.92	0.92	[REDACTED]
Franklin Drive – 115 kV	[REDACTED]	0.90	0.90	[REDACTED]
Torrington Terminal – 115 kV	[REDACTED]	0.90	0.90	[REDACTED]
Falls Village – 69 kV (non - PTF)	[REDACTED]	0.93	0.92	[REDACTED]
North Canaan– 69 kV (non - PTF)	[REDACTED]	0.91	0.91	[REDACTED]



**Figure 5-25: N-1 Voltage Violations in the NWCT Subarea**

### 5.2.4.3 N-1-1 Thermal and Voltage Violation Summary

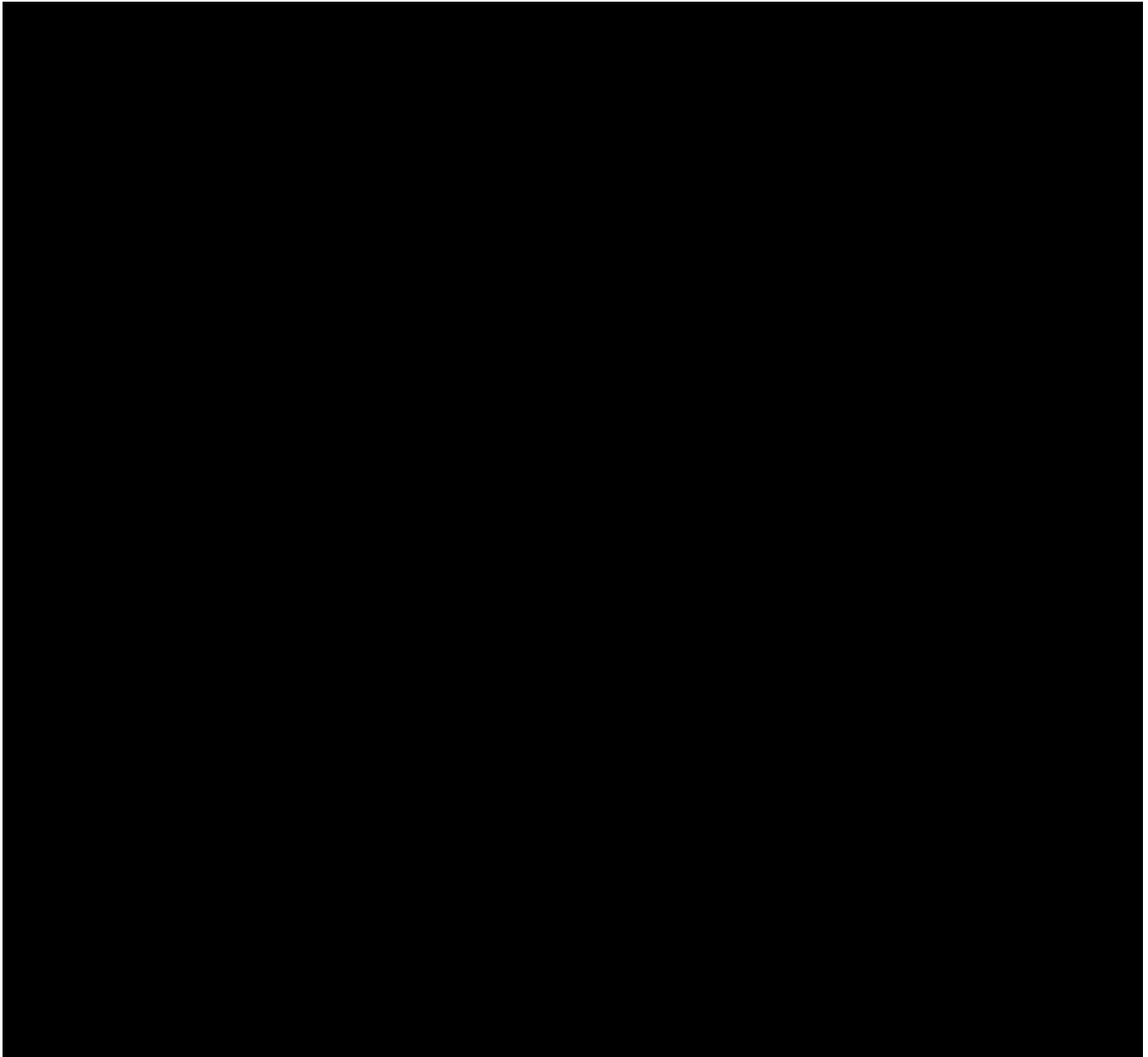
Table 5-16 provides the worst-case N-1-1 thermal violations that were observed in the NWCT subarea. [REDACTED]

**Table 5-16:  
N-1-1 Thermal Violations in the NWCT Subarea**

Element ID	Overloading Element	Initial Element OOS	Worst-Case Contingency	Highest Loading (One unit OOS)	Highest Loading (Two units OOS)	Comments
1191	Frost Bridge - Campville	[REDACTED]	[REDACTED]	172%	172%	[REDACTED]
1256	NE Simsbury - Canton	[REDACTED]	[REDACTED]	142%#	142%#	[REDACTED]
1732	Weingarten Junction – Franklin Drive	[REDACTED]	[REDACTED]	N/A	119%#	[REDACTED]
1810-1	Southington – Lake Ave Junction	[REDACTED]	[REDACTED]	149%#	149%#	[REDACTED]
1810-3	Lake Ave Junction – Chippen Hill	[REDACTED]	[REDACTED]	228%#	229%#	[REDACTED]
1825	Bristol - Forestville	[REDACTED]	[REDACTED]	114%	114%	[REDACTED]
1835	Chippen Hill - Thomaston	[REDACTED]	[REDACTED]	210%#	210%#	[REDACTED]
1921	Thomaston - Campville	[REDACTED]	[REDACTED]	165%#	166%#	[REDACTED]
Campville 1T	Breaker 1T Bus Segment	[REDACTED]	[REDACTED]	107%	107%	[REDACTED]
Campville 3T	Breaker 3T Bus Segment	[REDACTED]	[REDACTED]	153%#	153%#	[REDACTED]

#Low Voltages Aggravate Thermal Loadings

The N-1-1 thermal violations in the NWCT subarea are highlighted in Figure 5-26.



**Figure 5-26: N-1-1 Thermal Violations in the NWCT Subarea**

Table 5-17 provides the worst-case voltage violations in the NWCT subarea. [REDACTED]

[REDACTED] The violations have also been included in Figure 5-27.

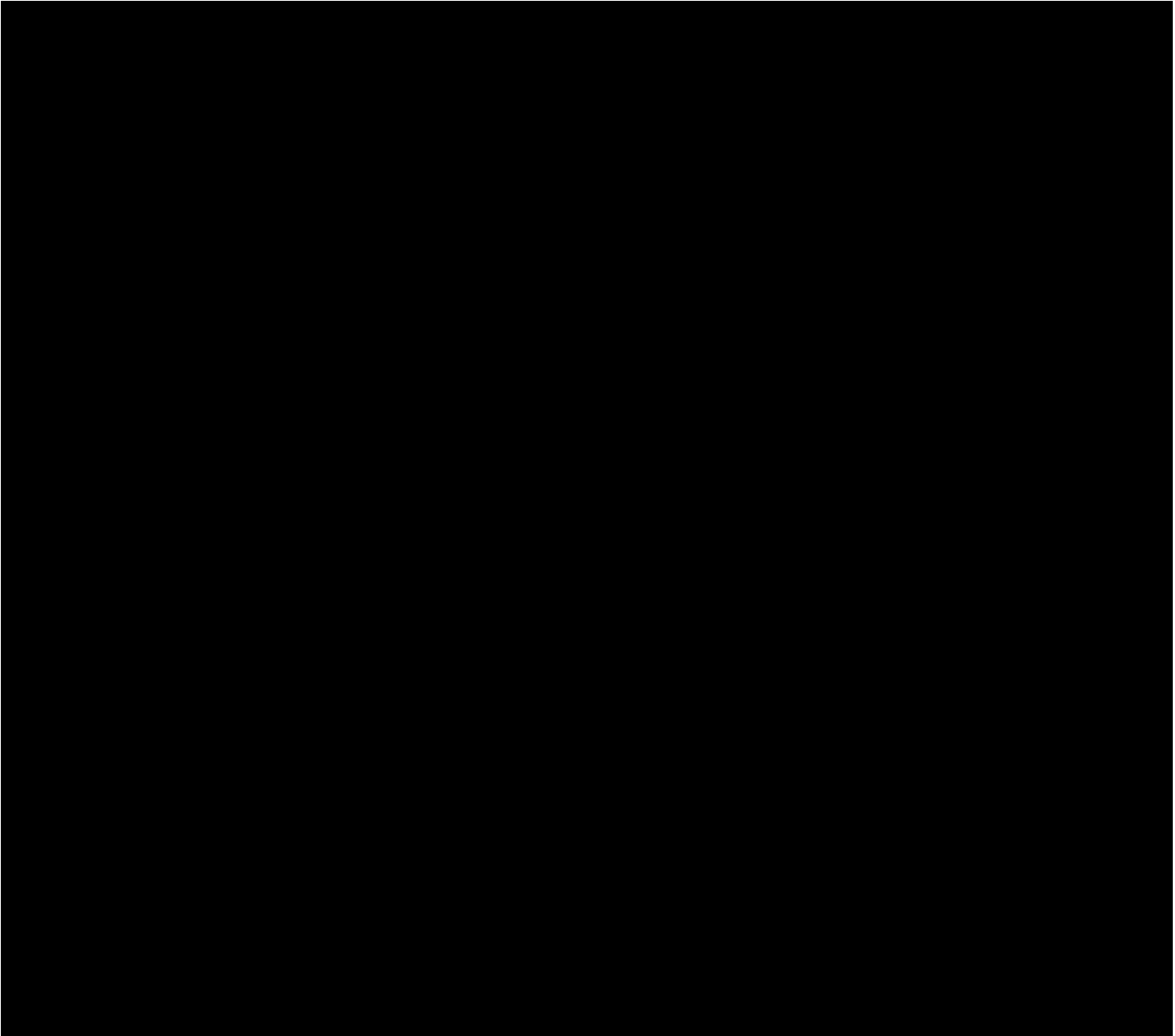
**Table 5-17:  
N-1-1 Low-Voltage Violations in the NWCT Subarea**

Bus Name	Initial Element OOS	Worst-Case Contingency	Worst-Case Voltage Violations ( One unit OOS)	Worst-Case Voltage Violations (Two units OOS)	Comments
Bristol – 115 kV	[REDACTED]	[REDACTED]	0.94	0.93	[REDACTED]
Campville – 115 kV	[REDACTED]	[REDACTED]	0.70*	0.70*	[REDACTED]
Canton – 115 kV	[REDACTED]	[REDACTED]	0.66*	0.66*	[REDACTED]
Chippen Hill – 115 kV	[REDACTED]	[REDACTED]	0.68*	0.68*	[REDACTED]
Forestville – 115 kV	[REDACTED]	[REDACTED]	0.90	0.90	[REDACTED]
Franklin Drive – 115 kV	[REDACTED]	[REDACTED]	0.69*	0.69*	[REDACTED]
NE Simsbury – 115 kV	[REDACTED]	[REDACTED]	0.66*	0.65*	[REDACTED]
Thomaston – 115 kV	[REDACTED]	[REDACTED]	0.69*	0.69*	[REDACTED]
Torrington Terminal – 115 kV	[REDACTED]	[REDACTED]	0.69*	0.69*	[REDACTED]
Falls Village – 69 kV (PTF)	[REDACTED]	[REDACTED]	0.71*	0.70*	[REDACTED]
Salisbury – 69 kV	[REDACTED]	[REDACTED]	0.69*	0.69*	[REDACTED]



Bus Name	Initial Element OOS	Worst-Case Contingency	Worst-Case Voltage Violations ( One unit OOS)	Worst-Case Voltage Violations (Two units OOS)	Comments
Torrington – 69 kV			0.74*	0.73*	
Falls Village – 69 kV (non - PTF)			0.67*	0.66*	
North Canaan– 69 kV (non - PTF)			0.65*	0.65*	

\*Indicates Potential Voltage Collapse



**Figure 5-27: N-1-1 Low-Voltage Violations in the NWCT Subarea**

Finally, Table 5-18 below provides the N-1-1 contingency conditions that led to potential voltage collapse

[Redacted]

**Table 5-18:  
N-1-1 Non-Convergence in the NWCT Subarea – Pre 690 SPS**

Line Out	Second Contingency	Comments
[REDACTED]	[REDACTED]	Independent of dispatch assumptions (SPS Action would isolate load)
[REDACTED]	[REDACTED]	Independent of dispatch assumptions (SPS Action would isolate load)

**5.2.5 Discussion of the 690 SPS**

[REDACTED]

[REDACTED]

[REDACTED]

The review of the 690 SPS and the future operation of the areas impacted by the SPS will not be conducted in the ensuing solutions study report. This matter will be dealt separately in coordination with NYISO.

**5.2.6 Discussion of Western Connecticut Import**

One of the objectives of this Needs Assessment was to reassess the need for the CCRP project which was one of the four components of the New England East West Solution (NEEWS) project. The need for the CCRP project was based on increasing the transfer capability across the western Connecticut import interface. The western Connecticut Import interface has three 345 kV lines that connect the generation rich eastern Connecticut with the load in western Connecticut (348, 364 and 3533).

[REDACTED] The solution to that need was identified as a new 345 kV line that crosses the interface from North Bloomfield to Frost Bridge.

However, as detailed in Sections 5.2.1 through 5.2.4, with the exception of overloads on the 362 line from Haddam Neck to Beseck, there were no other 345 kV violations. This may be attributed to the new generation and demand resources that have been procured in western Connecticut in FCA #1 through FCA #7.

However, a number of 115 kV lines and 345/115 kV autotransformers have thermal overloads that are either seen for the high Western Connecticut Import dispatches, or are driven by the loss of two 345 kV lines that form the Western Connecticut Import interface.

[REDACTED]

The detailed contingency results in Appendix E: Steady State Testing Results reports these overloads. Therefore, it may be concluded that the original need for increased Western Connecticut Import has diminished but it has not been eliminated. Additionally, a majority of the elements that have violations in either high Western Connecticut Import dispatches or for contingencies involving loss of elements which form the Western Connecticut Import interface also have violations for local area contingencies.

### **5.2.7 Extreme Contingency Testing**

As a part of this Needs Assessment, a number of extreme contingencies (NERC Category D contingencies) were tested. The full list of the extreme contingencies tested can be found in Appendix D: Contingency Listings. According to NERC, NPCC and ISO-NE standards, the extreme contingency testing is required to understand the risks and impacts to the system following an extreme event. NERC, NPCC and ISO-NE standards do not require that corrective plans be identified for the violations following these events but rather document the results of the assessment.

Therefore, as part of this study there will be no development of solutions to address violations that result from the extreme contingencies tested but the results may influence the selection of preferred solutions selected to address other violations. The results of the extreme contingency testing can be found in Appendix F: Extreme Contingency Testing Results.

## **5.3 Stability Performance Criteria Compliance**

---

Not applicable for this study.

### **5.3.1 Stability Test Results Summary**

Not applicable for this study.

## **5.4 Short Circuit Performance Criteria Compliance**

---

### **5.4.1 Short Circuit Test Results Summary**

[REDACTED]

**Table 5-19:  
Summary of Circuit Breakers with Duties Greater than 90% of Interrupting Rating**

Substation & Voltage	Breaker Id	Breaker Rating	Breaker Duty (%)

Appendix G: Short Circuit Testing Results has the detailed results for all the substations analyzed.

# Section 6

## Critical Load Level Assessment

### 6.1 Critical Load Level Methodology

---

The critical load level assessment was conducted to determine the load levels at which the criteria violations would be first seen. Since the issues were driven by low voltages and high thermal loadings, reducing load in the study area should reduce the thermal loadings and raise the voltages. The analysis determines the critical load level at which the overloading elements are at or below 100% of their summer LTE rating and the buses with voltage violations have post-contingency voltages that are at or above 0.95 per unit.

Since Connecticut is located at one end of the New England system, the load outside of Connecticut would have a minimal impact on thermal loadings and voltage violations in Connecticut. Hence, as a part of the critical load level assessment, the only load that was scaled down was Connecticut load. The load in the remaining parts of New England was maintained at expected 2022 load levels. Additionally, the generation in Connecticut was kept constant in the critical load level assessment. As load in Connecticut was scaled down, the generation far away from Connecticut, in Southeastern Massachusetts, Boston, Maine, and New Hampshire was scaled down. Thus, as load decreased in Connecticut, Connecticut import decreased.

### 6.2 Critical Contingency Pairs and Dispatches

---

For each element with a thermal or voltage violation, the contingency pair and base case with the worst-case violation was included in the analysis. [REDACTED]

The details of the elements and the corresponding contingency pairs tested are provided in Appendix H: Critical Load Level Assessment Testing.

### 6.3 Comparison of Critical Load Levels with CT Forecasted loads

---

Table 6-1 provides the net load expected in Connecticut for the 2013-2022 timeframe. The loads exclude the transmission losses. The details for the net load calculation are provided in Appendix J: Net Load in Connecticut Calculation.

Hence a critical load level of 7,400 MW indicates that the need is expected to be seen in the 2015-2016 timeframe. For all loads below 7,055 MW, the year of need is prior to 2013. Note that that 2013 load in the table below is based on the 2013 summer peak load forecast in the 2013 CELT and is not the actual load for 2013.

**Table 6-1: Projected Load in Connecticut 2013-2022 (Load – Available DR)**

	2013	2014	2015	2016	2017	2018	2019	2020	2021	2022
<b>CT Load – DR (MW):</b>										
<b>Excluding Transmission Losses</b>	7,055	7,165	7,292	7,456	7,568	7,620	7,677	7,721	7,777	7,819

## 6.4 Results of Critical Load Level Assessment

The details of the critical load level assessment for each subarea are provided in Appendix I: Critical Load Level Assessment Results. The details include the following:

- Element for which the critical load level was developed – Transmission element or bus
- Critical contingency pair being analyzed
- Dispatch that was analyzed
- Critical load level – Connecticut load minus DR at which violations are expected to be eliminated. This load excludes transmission losses.
- Final thermal loading or bus voltage

The following sections summarize the results for each subarea. The lowest critical load level for each element has been identified in the tables below.

### 6.4.1 Greater Hartford Subarea

Table 6-2 summarizes the critical load levels for the subarea buses with thermal violations.

**Table 6-2:  
Greater Hartford Subarea Critical Load Levels for Thermal Violations**

Element ID	Overloading Element	Critical Load Level (CT Load) - MW	Year of Need
1207	Manchester – E Hartford	6,959	Pre-2013
1670-1	Southington – Reservoir Rd Jct	7,195	2014-2015
1670-2	Reservoir Rd Jct - Berlin	7,287	2014-2015
1704	S Meadow - SW Hartford	6,412	Pre-2013
1722-1	SW Hartford – Capitol District Tap	7,334	2015-2016
1722-2	Capitol District Tap – NW Hartford	6,850	Pre-2013
1726	N Bloomfield - Farmington	5,787	Pre-2013
1751	Bloomfield Jct. – NW Hartford	5,959	Pre-2013
1752	Rocky Hill – Berlin	7,537	2016-2017
1756	Bloomfield – NW Hartford	7,194	2014-2015
1765	Berlin - Westside	5,522	Pre-2013
1769	Berlin – E New Britain	6,475	Pre-2013
1771	Southington - Berlin	7,256	2014-2015
1773	S Meadow – Rocky Hill	5,912	Pre-2013
1775-1	Riverside Tap – S Meadow	7,225	2014-2015

Element ID	Overloading Element	Critical Load Level (CT Load) - MW	Year of Need
1775-2	Manchester – Riverside Tap	7,006	Pre-2013
1777	N Bloomfield - Bloomfield	6,170	Pre-2013
1779	S Meadow - Bloomfield	5,600	Pre-2013
1785	Berlin - Newington	4,756	Pre-2013
1783-1	Farmington – Newington Tap	5,147	Pre-2013
1783-2	Newington Tap - Newington	5,756	Pre-2013
1783-3	E New Britain – Riverside Tap	7,342	2015-2016
1786	E Hartford – S Meadow	7,209	2014-2015
1950	Southington – Canal	7,287	2014-2015
NW HTFD 32T	NW Hartford 32T Bus Segment	6,553	Pre-2013
STGTN 2X	Southington 2X Auto	4,819	Pre-2013
STGTN 3X	Southington 3X Auto	6,600	Pre-2013

Table 6-3 summarizes the critical load levels for the subarea buses with voltage violations.

**Table 6-3:  
Greater Hartford Subarea Critical Load Levels for Voltage Violations**

Bus Name – Voltage	Critical Load Level (CT Load) - MW	Year of Need
Berlin – 115 kV	6,194	Pre-2013
Bloomfield – 115 kV	5,569	Pre-2013
Capitol District – 115 kV	5,069	Pre-2013
E New Britain – 115 kV	4,319	Pre-2013
Farmington – 115 kV	5,819	Pre-2013
Newington – 115 kV	4,444	Pre-2013
NW Hartford – 115 kV	5,069	Pre-2013
Rocky Hill – 115 kV	6,069	Pre-2013
SW Hartford – 115 kV	5,069	Pre-2013
Westside – 115 kV	4,694	Pre-2013
Black Rock – 115 kV (Non-PTF)	6,069	Pre-2013
GE – 115 kV (Non-PTF)	6,131	Pre-2013



### 6.4.2 Manchester-Barbour Hill Subarea

Table 6-4 summarizes the critical load levels for the subarea buses with thermal violations.

**Table 6-4:  
Manchester-Barbour Hill Subarea Critical Load Levels for Thermal Violations**

Element ID	Overloading Element	Critical Load Level (CT Load) - MW	Year of Need
1310	Manchester – South Windsor	5,631	Pre-2013
1635	South Windsor – Barbour Hill	6,256	Pre-2013
1763	Manchester – Barbour Hill	5,616	Pre-2013
MANCH 4X	Manchester 345/115 Autotransformer	6,944	Pre-2013
MANCH 6X	Manchester 345/115 Autotransformer	6,762	Pre-2013

Table 6-5 summarizes the critical load levels for the subarea buses with voltage violations.

**Table 6-5:  
Manchester-Barbour Hill Subarea Critical Load Levels for Voltage Violations**

Bus Name	Critical Load Level (CT Load) - MW	Year of Need
Barbour Hill – 115 kV	5,069	Pre-2013
S Windsor – 115 kV	6,319	Pre-2013
Dexter – 115 kV (Non-PTF)	4,569	Pre-2013
Enfield – 115 kV (Non-PTF)	4,569	Pre-2013
Rockville – 115 kV (Non-PTF)	4,819	Pre-2013
Windsor Locks – 115 kV (Non-PTF)	4,569	Pre-2013

### 6.4.3 Middletown Subarea

Table 6-6 summarizes the critical load levels for the subarea buses with thermal violations.

**Table 6-6:  
Middletown Subarea Critical Load Levels for Thermal Violations**

Element ID	Overloading Element	Critical Load Level (CT Load) - MW	Year of Need
362	Haddam Neck – Beseck	7,475	2016-2017
1050	Middletown – Dooley	3,819	Pre-2013
1261	Haddam - Bokum (Circuit 1)	7,545	2016-2017
1443	Portland – Middletown	6,850	Pre-2013
1588	Colony – N Wallingford	4,912	Pre-2013
1598	Haddam - Bokum (Circuit 2)	7,541	2016-2017

Element ID	Overloading Element	Critical Load Level (CT Load) - MW	Year of Need
1620	Middletown – Haddam	6,694	Pre-2013
1759	Hopewell – Portland	6,491	Pre-2013
1766	Dooley - Westside	3,444	Pre-2013
1355-1	Hanover Tap – Colony	5,444	Pre-2013
1355-3	Southington – Hanover Tap	6,100	Pre-2013

Table 6-7 below summarizes the critical load levels for the subarea buses with voltage violations.

**Table 6-7:  
Middletown Subarea Critical Load Levels for Voltage Violations**

Bus Name	Critical Load Level (CT Load) - MW	Year of Need
Branford – 115 kV	6,194	Pre-2013
Bokum – 115 kV	4,694	Pre-2013
Colony – 115 kV	4,569	Pre-2013
Dooley – 115 kV	4,319	Pre-2013
East Meriden – 115 kV	4,694	Pre-2013
Green Hill – 115 kV	4,069	Pre-2013
Haddam – 115 kV	5,194	Pre-2013
Hanover – 115 kV	5,694	Pre-2013
Hopewell – 115 kV	3,694	Pre-2013
Middletown – 115 kV	4,069	Pre-2013
N Wallingford – 115 kV	4,694	Pre-2013
Portland – 115 kV	3,944	Pre-2013
Pratt and Whitney – 115 kV	5,319	Pre-2013
Stepstone – 115 kV	4,069	Pre-2013

#### 6.4.4 Northwestern Connecticut Subarea

Table 6-8 summarizes the critical load levels for the subarea elements with thermal violations.

**Table 6-8:  
NWCT Subarea Critical Load Levels for Thermal Violations**

Element ID	Overloading Element	Critical Load Level (CT Load) - MW	Year of Need
1191	Frost Bridge - Campville	4,600	Pre-2013
1256	NE Simsbury - Canton	6,944	Pre-2013
1732	Campville – Weingarten Jct.	7,616	2017-2018
1810-1	Southington – Lake Ave Junction	6,241	Pre-2013
1810-3	Lake Ave Junction – Chippen Hill	4,225	Pre-2013
1825	Bristol - Forestville	6,174	Pre-2013
1835	Chippen Hill - Thomaston	4,787	Pre-2013
1921	Thomaston - Campville	6,006	Pre-2013

Element ID	Overloading Element	Critical Load Level (CT Load) - MW	Year of Need
<b>CAMP 1T</b>	Campville 1T Breaker Bus Segment	7,444	2015-2016
<b>CAMP 3T</b>	Campville 3T Breaker Bus Segment	6,381	Pre-2013

Table 6-9 summarizes the critical load levels for the subarea buses with voltage violations.

**Table 6-9:  
NWCT Subarea Critical Load Levels for Voltage Violations**

Bus Name	Critical Load Level (CT Load) - MW	Year of Need
<b>Bristol – 115 kV</b>	6,951	Pre-2013
<b>Campville – 115 kV</b>	5,819	Pre-2013
<b>Canton – 115 kV</b>	5,819	Pre-2013
<b>Chippen Hill – 115 kV</b>	5,819	Pre-2013
<b>Forestville – 115 kV</b>	5,694	Pre-2013
<b>Franklin Drive – 115 kV</b>	5,819	Pre-2013
<b>NE Simsbury – 115 kV</b>	5,787	Pre-2013
<b>Thomaston – 115 kV</b>	5,944	Pre-2013
<b>Torrington – 115 kV</b>	5,819	Pre-2013
<b>Falls Village – 69 kV (PTF)</b>	6,944	Pre-2013
<b>Salisbury – 69 kV</b>	6,951	Pre-2013
<b>Torrington – 69 kV</b>	6,881	Pre-2013
<b>Falls Village – 69 kV (Non - PTF)</b>	6,444	Pre-2013
<b>North Canaan – 69 kV (Non - PTF)</b>	6,381	Pre-2013

# Section 7 Conclusions on Needs Analysis

## 7.1 Statement of Needs

---

All the criteria violations observed in the Greater Hartford and Central Connecticut (GHCC) area were based on steady state thermal and voltage testing. The following summarizes the needs for each subarea:

### Greater Hartford Subarea

- Need to resolve N-1 and N-1-1 criteria violations observed in the Greater Hartford area
- Thermal and voltage violations observed in the following areas:
  - North Bloomfield to Manchester area
  - South Meadow – Berlin – Southington area
  - Southington area

█ [REDACTED]

### Middletown Subarea:

- Need to resolve the N-1 and N-1-1 criteria violations observed in the Middletown area

- █ [REDACTED]

█ [REDACTED]

### Manchester – Barbour Hill Subarea

- Need to resolve the N-1-1 criteria violations observed in serving load in the Manchester/Barbour Hill area

- █ [REDACTED]

### Northwestern Connecticut Subarea:

- Need to resolve N-1 and N-1-1 criteria violations observed in serving load in the Northwest Connecticut area

█ [REDACTED]

### Western Connecticut Interface:

- Need to resolve N-1-1 criteria violations observed █ [REDACTED]

The needs are interrelated with the needs in the four subareas listed above

## **7.2 Critical Load Levels**

---

The following sections summarize the critical load levels for each subarea at which all thermal and voltage violations are expected to be resolved. The critical load levels are provided in terms of Connecticut load including demand resources and energy efficiency and the numbers exclude transmission losses.

### **7.2.1 Summary of Results for Greater Hartford Subarea**

The majority of the worst-case violations in the Greater Hartford subarea are expected to be seen at expected summer peak load levels before 2013. The net Connecticut load minus DR at which all thermal violations will be resolved is 4,756 MW and the net Connecticut load at which all voltage violations would be resolved is 4,319 MW.

### **7.2.2 Summary of Results for Manchester-Barbour Hill Subarea**

The majority of the worst-case violations in the Manchester-Barbour Hill subarea are expected to be seen at expected summer peak load levels before 2013. The net Connecticut load minus DR at which all thermal violations will be resolved is 5,616 MW and the net Connecticut load at which all the PTF voltage violations would be resolved is 5,069 MW. The non-PTF voltage violations would only be resolved at a net Connecticut load level of 4,569 MW.

### **7.2.3 Summary of Results for Middletown Subarea**

The majority of the worst-case violations in the Middletown subarea are expected to be seen at expected summer peak load levels before 2013. The net Connecticut load minus DR at which all thermal violations will be resolved is 3,444 MW and the net Connecticut load at which all voltage violations would be resolved is 3,694 MW.

### **7.2.4 Summary of Results for Northwestern CT Subarea**

The majority of the worst-case violations in the Northwestern Connecticut subarea are expected to be seen at expected summer peak load levels before 2013. The net Connecticut load minus DR at which all thermal violations will be resolved is 4,225 MW and the net Connecticut load at which all voltage violations would be resolved is 5,694 MW.

# Section 8

## Appendix A: Load Forecast

**Table 8-1:  
2013 CELT Seasonal Peak Load Forecast Distributions**

		Peak Load Forecast at Milder Than Expected Weather				Reference Forecast at Expected Weather	Peak Load Forecast at More Extreme Than Expected Weather				
<b>Summer (MW)</b>	2013	26470	26715	27045	27420	27840	28285	28735	29385	30135	30790
	2014	26900	27150	27485	27865	28290	28740	29200	29860	30620	31280
	2015	27410	27665	28005	28390	28825	29285	29750	30425	31185	31860
	2016	27910	28165	28515	28910	29350	29815	30295	30980	31740	32420
	2017	28325	28590	28940	29340	29790	30265	30750	31445	32210	32900
	2018	28675	28940	29295	29700	30155	30635	31125	31830	32615	33315
	2019	29025	29295	29655	30065	30525	31010	31505	32220	33010	33720
	2020	29345	29615	29980	30395	30860	31350	31855	32575	33380	34095
	2021	29670	29950	30315	30735	31205	31700	32210	32935	33755	34480
	2022	29970	30250	30625	31045	31520	32020	32535	33270	34105	34840
<b>WTHI (1)</b>		<b>78.49</b>	<b>78.73</b>	<b>79.00</b>	<b>79.39</b>	<b>79.88</b>	<b>80.30</b>	<b>80.72</b>	<b>81.14</b>	<b>81.96</b>	<b>82.33</b>
<b>Dry-Bulb Temperature (2)</b>		<b>88.50</b>	<b>88.90</b>	<b>89.20</b>	<b>89.90</b>	<b>90.20</b>	<b>91.20</b>	<b>92.20</b>	<b>92.90</b>	<b>94.20</b>	<b>95.40</b>
<b>Probability of Forecast Being Exceeded</b>		<b>90%</b>	<b>80%</b>	<b>70%</b>	<b>60%</b>	<b>50%</b>	<b>40%</b>	<b>30%</b>	<b>20%</b>	<b>10%</b>	<b>5%</b>
<b>Winter (MW)</b>	2013/14	22025	22140	22235	22295	22445	22595	22765	22865	23080	23505
	2014/15	22205	22320	22420	22480	22630	22780	22955	23055	23255	23685
	2015/16	22385	22500	22595	22660	22810	22960	23135	23235	23440	23870
	2016/17	22540	22660	22755	22815	22970	23125	23295	23400	23620	24050
	2017/18	22680	22795	22895	22955	23110	23265	23440	23540	23780	24205
	2018/19	22800	22920	23020	23080	23235	23390	23565	23670	23920	24345
	2019/20	22915	23035	23130	23195	23350	23505	23685	23785	24045	24470
	2020/21	23030	23150	23250	23315	23470	23625	23805	23910	24160	24590
	2021/22	23145	23265	23365	23425	23585	23745	23920	24025	24280	24705
	2022/23	23255	23380	23480	23540	23700	23860	24040	24145	24395	24820
<b>Dry-Bulb Temperature (3)</b>		<b>10.72</b>	<b>9.66</b>	<b>8.84</b>	<b>8.30</b>	<b>7.03</b>	<b>5.77</b>	<b>4.40</b>	<b>3.58</b>	<b>1.61</b>	<b>(1.15)</b>

**FOOTNOTES:**

- (1) WTHI - a three-day weighted temperature-humidity index for eight New England weather stations. It is the weather variable used in producing the summer peak load forecast. For more information on the weather variables see [http://www.iso-ne.com/trans/celt/fscet\\_detail/](http://www.iso-ne.com/trans/celt/fscet_detail/).
- (2) Dry-bulb temperature (in degrees Fahrenheit) shown in the summer season is for informational purposes only.
- (3) Dry-bulb temperature (in degrees Fahrenheit) shown in the winter season is a weighted value from eight New England weather stations.

**Table 8-2:  
2022 Detailed Load Distributions by State and Company**

**ISO New England Basecase DB - Load File Report by Company**

Study Date : 08/15/2022      Study Name : GHCC Revised  
 File Created : 2014-01-22      CELT Forecast : 2013      Forecast Year : 2022  
 Season : Summer Peak      Weather : 90/10      Load Distribution : N+10\_SUM  
 ISO-NE CELT : 34105 MW      % of Peak : 100.000%      Tx Losses : 2.50%

State CELT L&L	-	2.50% Tx Losses	+	Non-CELT Load	+	Station Service	-	Area 104 NE Load	=	Area 101 Load
34105 MW		852.6 MW		364.4 MW		0.0 MW		42.8 MW		33574.3 MW

1: State CELT L&L: This represents the sum of the 6 State CELT forecasts. This number can sometimes be 5-10 MW different than the ISO-NE CELT forecast number due to round-off error.  
 2: Non-CELT Load: This is the sum of all load modeled in the case that is not included in the CELT forecast. An example is the "behind the meter" paper mill load in Maine.  
 3: Station Service: This is the amount of generator station service modeled. If station service is off-line, the Area 101 report totals will be different since off-line load is not counted in totals.  
 4: Area 104 NE Load: This load is load modeled in northern VT that is electrically served from Hydro Quebec. To make Area Interchange load independent, this load is assigned Area 104.

**Maine      State Load = 2450 MW - 2.50% Tx Losses = 2388.75 MW**

Company	State Share	Total P (MW)	Total Q (MVAR)	Overall PF	Non-Scaling (MW)
CMP	85.42%	2040.39	655.06	0.952	332.06
BHE	14.59%	348.42	133.15	0.934	17.81

**New Hampshire      State Load = 3150 MW - 2.50% Tx Losses = 3071.25 MW**

Company	State Share	Total P (MW)	Total Q (MVAR)	Overall PF	Non-Scaling (MW)
PSNH	78.73%	2418.00	344.54	0.990	
UNITIL	12.13%	372.58	53.09	0.990	
GSE	9.14%	280.68	6.42	1.000	1.85

**Vermont      State Load = 1220 MW - 2.50% Tx Losses = 1189.5 MW**

Company	State Share	Total P (MW)	Total Q (MVAR)	Overall PF	Non-Scaling (MW)
VELCO	100.00%	1189.57	200.18	0.986	95.79

**Massachusetts      State Load = 16055 MW - 2.50% Tx Losses = 15653.625 MW**

Company	State Share	Total P (MW)	Total Q (MVAR)	Overall PF	Non-Scaling (MW)
BECO	28.31%	4431.86	1146.57	0.968	37.79
COMEL	11.63%	1820.19	368.90	0.980	
MA-NGRID	39.34%	6157.37	355.79	0.998	38.49
WMECO	6.34%	992.13	141.36	0.990	
MUNI:BOST-NGR	3.40%	532.23	93.80	0.985	
MUNI:BOST-NST	1.21%	189.87	29.00	0.989	
MUNI:CNEMA-NGR	2.10%	328.38	33.68	0.995	
MUNI:RI-NGR	0.88%	137.44	16.67	0.993	
MUNI:SEMA-NGR	1.86%	290.39	30.91	0.994	
MUNI:SEMA-NST	1.74%	272.37	50.29	0.983	
MUNI:WMA-NGR	1.01%	157.79	15.67	0.995	
MUNI:WMA-NU	2.20%	343.77	48.98	0.990	

**Rhode Island      State Load = 2405 MW - 2.50% Tx Losses = 2344.875 MW**

Company	State Share	Total P (MW)	Total Q (MVAR)	Overall PF	Non-Scaling (MW)
RI-NGRID	100.00%	2344.90	229.64	0.995	45.44

**Connecticut      State Load = 8825 MW - 2.50% Tx Losses = 8604.375 MW**

Company	State Share	Total P (MW)	Total Q (MVAR)	Overall PF	Non-Scaling (MW)
CLP	76.26%	6561.83	935.10	0.990	82.50
CMEEC	4.71%	405.62	57.80	0.990	
UI	19.02%	1636.87	163.66	0.995	10.00

**Table 8-3:  
Detailed Demand Response Distributions by Zone**

**ISO New England Basecase DB - Demand Resources File Report**

Study Date : 08/15/2022

Study Name : GHCC Revised

File Created : 2014-01-22

CCP : 2016/2017

Load Season : 2022 - Summer Peak

Load Distrib : N+10\_SUM

Distrb Losses : 5.50%

DR Season : SUM

	Demand Reduction Value (DRV)	Load Dependent Capability Assumption (LDCA)	Performance Assumption (PA)	Distribution Losses Gross-Up	Area 104 DR	Area 101 DR
Passive :	1670.15 MW	100.00%	100.00%	91.86 MW	4.77 MW	1757.05 MW
Forecast EE :	1038.85 MW	100.00%	100.00%	57.14 MW	3.37 MW	1092.68 MW
Active :	1171.84 MW	100.00%	75.00%	48.34 MW	1.72 MW	925.35 MW

Demand Reduction Value (DRV): Amount of DR measured at the customer meter without any gross-up values for transmission or distribution losses.  
 Load Dependent Capability Assumption (LDCA): De-rate factor applied based on % of CELT load. (i.e. Light load is 45% of 50/50 load, so the LDCA would be 45%).  
 Performance Assumption (PA): De-rate factor applied based on expected performance of DR after a dispatch signal from Operations.  
 Area 104 DR: This load is modeled in northern VT and is electrically served from Hydro Quebec. To make Area interchange load independent, this load is assigned Area 104.

**Passive Demand Resources - (On-Peak and Seasonal Peak)**

DR Modeled = (DRV\_SUM \* 100.00% LDCA \* 100.00% PA) + 5.50% Distrb Losses Gross-Up

Zone	ID	Description	DRV (MW)	Total P (MW)	Total Q (MVAR)
DR_P_ME	20	Load Zone - Maine	158.72	-167.44	-60.62
DR_P_NH	21	Load Zone - New Hampshire	79.75	-84.16	-11.66
DR_P_VT	22	Load Zone - Vermont	125.44	-132.24	-22.07
DR_P_NEMABOS	23	Load Zone - Northeast Massachusetts & Boston	341.18	-359.90	-79.19
DR_P_SEMA	24	Load Zone - Southeast Massachusetts	193.94	-204.59	-20.15
DR_P_WCMA	25	Load Zone - West Central Massachusetts	244.71	-258.17	-21.99
DR_P_RI	26	Load Zone - Rhode Island	141.90	-149.65	-14.66
DR_P_CT	27	Load Zone - Connecticut	384.51	-405.67	-54.52

**Forecasted Energy Efficiency**

DR Modeled = (DRV\_EE \* 100.00% LDCA \* 100.00% PA) + 5.50% Distrb Losses Gross-Up

Zone	ID	Description	DRV (MW)	Total P (MW)	Total Q (MVAR)
DR_P_ME	20	Load Zone - Maine	56.48	-59.57	-21.50
DR_P_NH	21	Load Zone - New Hampshire	52.78	-55.67	-7.69
DR_P_VT	22	Load Zone - Vermont	88.88	-93.88	-15.70
DR_P_NEMABOS	23	Load Zone - Northeast Massachusetts & Boston	276.34	-291.52	-64.14
DR_P_SEMA	24	Load Zone - Southeast Massachusetts	146.98	-155.05	-15.30
DR_P_WCMA	25	Load Zone - West Central Massachusetts	164.62	-173.68	-14.80
DR_P_RI	26	Load Zone - Rhode Island	113.89	-120.16	-11.81
DR_P_CT	27	Load Zone - Connecticut	138.88	-146.52	-19.68

**Active Demand Resources - (Real-Time Demand Resource (RTDR), Excludes RTEG)**

DR Modeled = (DRV\_SUM \* 100.00% LDCA \* 75.00% PA) + 5.50% Losses Gross-Up

Zone	ID	Description	DRV (MW)	Total P (MW)	Total Q (MVAR)
DR_A_ME_BHE	30	Dispatch Zone - ME - Bangor Hydro	56.40	-44.63	-23.28
DR_A_ME_MAIN	31	Dispatch Zone - ME - Maine	206.61	-163.53	-55.36
DR_A_ME_PORT	32	Dispatch Zone - ME - Portland Maine	31.49	-24.89	-8.12
DR_A_NH_NEWH	33	Dispatch Zone - NH - New Hampshire	48.62	-38.46	-5.28
DR_A_NH_SEAC	34	Dispatch Zone - NH - Seacoast	12.10	-9.58	-1.36
DR_A_VT_NWVT	35	Dispatch Zone - VT - Northwest Vermont	38.46	-30.40	-4.93
DR_A_VT_VERM	36	Dispatch Zone - VT - Vermont	24.83	-19.64	-3.51
DR_A_MA_BOST	37	Dispatch Zone - MA - Boston	81.06	-64.09	-16.39
DR_A_MA_NSHP	38	Dispatch Zone - MA - North Shore	35.48	-28.06	-3.39
DR_A_MA_CMA	39	Dispatch Zone - MA - Central Massachusetts	51.46	-40.67	-2.04
DR_A_MA_SFPD	40	Dispatch Zone - MA - Springfield	32.76	-25.91	-3.69
DR_A_MA_WMA	41	Dispatch Zone - MA - Western Massachusetts	78.27	-61.92	-5.86
DR_A_MA_LSM	42	Dispatch Zone - MA - Lower Southeast Massachusetts	20.01	-15.85	-2.60
DR_A_MA_SEMA	43	Dispatch Zone - MA - Southeast Massachusetts	121.48	-96.13	-6.76
DR_A_RI_RHOD	44	Dispatch Zone - RI - Rhode Island	73.75	-58.38	-5.69
DR_A_CT_EAST	45	Dispatch Zone - CT - Eastern Connecticut	36.55	-28.90	-4.12
DR_A_CT_NORTH	46	Dispatch Zone - CT - Northern Connecticut	84.10	-66.53	-9.48
DR_A_CT_NORTH	47	Dispatch Zone - CT - Norwalk-Stamford	34.23	-27.08	-3.70
DR_A_CT_WEST	48	Dispatch Zone - CT - Western Connecticut	104.18	-82.42	-10.71



## Section 9

### Appendix B: Case Summaries

Quick links to case summaries for each of the dispatches described in Table 3-6 and Table 3-7 are provided below. Each file contains all of the case summaries for the portion of the study area or associated transmission upgrade project noted in the title.

[Appendix B1 Barbour Hill Dispatches.pdf](#)

[Appendix B2 CCRP Dispatches.pdf](#)

[Appendix B3 Greater Hartford Dispatches.pdf](#)

[Appendix B4 IRP Dispatches.pdf](#)

[Appendix B5 Middletown Dispatches.pdf](#)

[Appendix B6 NWCT Dispatches.pdf](#)

# Section 10

## Appendix C: Element Out for N-1-1 Analysis

Table 10-1:  
N-1-1 First Element-Out Scenarios

Line/ Autotransformer	Station A	Station B	Station C	BPS Element
<b>Underground cables</b>				
1704	South Meadow 115 kV	Southwest Hartford 115 kV		Yes
1722	Southwest Hartford 115 kV	CDEC 115 kV	Northwest Hartford 115 kV	No
<b>Overhead 345 kV lines</b>				
310	Manchester 345 kV	Millstone 345 kV		Yes
329	Frost Bridge 345 kV	Southington 345 kV		Yes
330	Card 345 kV	Lake Road 345 kV		Yes
347	Killingly 345 kV	Sherman Road 345 kV		Yes
348	Millstone 345 kV	Haddam 345 kV	Beseck 345 kV	Yes
352	Frost Bridge 345 kV	Long Mountain 345 kV		Yes
352 (w/ Element Restored) <sup>19</sup>	Frost Bridge 345 kV	Long Mountain 345 kV		Yes
362	Beseck 345 kV	Haddam Neck 345 kV		Yes
364	Montville 345 kV	Haddam Neck 345 kV		Yes
368	Manchester 345 kV	Card 345 kV		Yes
371	Millstone 345 kV	Montville 345 kV		Yes
376	Scovill Rock 345 kV	Haddam Neck 345 kV		Yes
383	Millstone 345 kV	Card 345 kV		Yes
3041	Southington 345 kV	Scovill Rock 345 kV		Yes
3196	Agawam 345 kV	Ludlow 345 kV		Yes
3216	North Bloomfield 345 kV	Agawam 345 kV		Yes
3271	Lake Road 345 kV	Card 345 kV		Yes
3348	Killingly 345 kV	Lake Road 345 kV		Yes
3419	Barbour Hill 345 kV	Ludlow 345 kV		Yes
3424	Manchester 345 kV	Kleen Energy 345 kV		Yes
3557	Barbour Hill 345 kV	Manchester 345 kV		Yes
3642	North Bloomfield 345 kV	Manchester 345 kV		Yes
3827	Beseck 345 kV	East Devon 345 kV		Yes
<b>Overhead 115 kV lines</b>				
1042	North Bloomfield 115 kV	Northeast Simsbury 115 kV		Yes

<sup>19</sup> In some cases, the initial element-out scenario also disconnects another element connected to the same breaker position. In some cases the restoration of this additional element in the 30 minutes prior to the next contingency can have an impact on the results. For these conditions, two different initial line-out scenarios were analyzed, one in which the additional element remains offline and one in which the element is restored before the second contingency.

Line/ Autotransformer	Station A	Station B	Station C	BPS Element
<b>1042 (w/ Element Restored)</b>	North Bloomfield 115 kV	Northeast Simsbury 115 kV		No
<b>1050</b>	Middletown 115 kV	Dooley 115 kV		No
<b>1100</b>	Enfield 115 kV	Barbour Hill 115 kV		No
<b>1191</b>	Frost Bridge 115 kV	Campville 115 kV		Yes
<b>1200</b>	Windsor Locks 115 kV	Barbour Hill 115 kV		No
<b>1207</b>	Manchester 115 kV	East Hartford 115 kV		Yes
<b>1208</b>	Southington 115 kV	Wallingford 115 kV		Yes
<b>1256</b>	Canton 115 kV	Northeast Simsbury 115 kV		No
<b>1261</b>	Haddam 115 kV	Bokum 115 kV		Yes
<b>1300</b>	Windsor Locks 115 kV	Enfield 115 kV		No
<b>1310</b>	Manchester 115 kV	East Windsor 115 kV		Yes
<b>1342</b>	Bokum 115 kV	Green Hill 115 kV		No
<b>1355</b>	Southington 115 kV	Hanover 115 kV	Colony 115 kV	Yes
<b>1443</b>	Portland 115 kV	Middletown 115 kV		No
<b>1448</b>	Manchester 115 kV	Rood Avenue 115 kV		Yes
<b>1448 (w/ Element Restored)</b>	Manchester 115 kV	Rood Avenue 115 kV		Yes
<b>1460</b>	East Shore 115 kV	Branford RR 115 kV		Yes
<b>1466</b>	North Wallingford 115 kV	East Meriden 115 kV		No
<b>1508</b>	Stepstone 115 kV	Green Hill 115 kV		No
<b>1508(w/ Element Restored)</b>	Stepstone 115 kV	Green Hill 115 kV		No
<b>1537</b>	Branford 115 kV	Branford RR 115 kV		No
<b>1572_1772</b>	Middletown 115 kV	P&W Aircraft 115 kV	Haddam 115 kV	Yes
<b>1588</b>	North Wallingford 115 kV	Colony 115 kV		No
<b>1598</b>	Haddam 115 kV	Bokum 115 kV		Yes
<b>1606</b>	Barbour Hill 115 kV	Rockville 115 kV		No
<b>1610</b>				
<b>1620</b>	Haddam 115 kV	Middletown 115 kV		Yes
<b>1635</b>	Barbour Hill 345 kV	South Windsor 115 kV		Yes
<b>1655</b>	North Haven 115 kV	Branford 115 kV		No
<b>1670</b>	Berlin 115 kV	Southington 115 kV	Black Rock 115 kV	Yes
<b>1690</b>	Southington 115 kV	Hanover 115 kV		Yes
<b>1724</b>	Barbour Hill 115 kV	Rockville 115 kV		No
<b>1726</b>	Farmington 115 kV	North Bloomfield 115 kV		Yes
<b>1732</b>	Franklin Drive 115 kV	Campville 115 kV	Canton 115 kV	No
<b>1738</b>	Stepstone 115 kV	Branford 115 kV		No
<b>1751</b>	North Bloomfield 115 kV	Rood Avenue 115 kV	Northwest Hartford 115 kV	Yes
<b>1752</b>	Berlin 115 kV	Rocky Hill 115 kV		Yes

Line/ Autotransformer	Station A	Station B	Station C	BPS Element
1756	Bloomfield 115 kV	Northwest Hartford 115 kV		No
1759	Hopewell 115 kV	Portland 115 kV		No
1763	Manchester 115 kV	Barbour Hill 115 kV		Yes
1765	Berlin 115 kV	West Side 115 kV		Yes
1766	Dooley 115 kV	West Side 115 kV		No
1767	Manchester 115 kV	Hopewell 115 kV		Yes
1769	Berlin 115 kV	East New Britain 115 kV		Yes
1771	Berlin 115 kV	Southington 115 kV		Yes
1773	Rocky Hill 115 kV	South Meadow 115 kV		Yes
1775	South Meadow 115 kV	Riverside Drive 115 kV	Manchester 115 kV	Yes
1777	Bloomfield 115 kV	North Bloomfield 115 kV		Yes
1779	Bloomfield 115 kV	South Meadow 115 kV		Yes
1783	East New Britain 115 kV	Newington 115 kV	Farmington 115 kV	No
1785	Berlin 115 kV	Newington 115 kV		Yes
1786	South Meadow 115 kV	East Hartford 115 kV	Riverside Drive 115 kV	Yes
1788	Torrington Terminal 115 kV	Franklin Drive 115 kV		No
1788 (w/ Element Restored)	Torrington Terminal 115 kV	Franklin Drive 115 kV		No
1800	Southington 115 kV	Forestville 115 kV		Yes
1810	Southington 115 kV	Bristol 115 kV	Chippen Hill 115 kV	Yes
1820	Southington 115 kV	Black Rock 115 kV		Yes
1825	Bristol 115 kV	Forestville 115 kV		No
1830	Southington 115 kV	Black Rock 115 kV		Yes
1835	Thomaston 115 kV	Chippen Hill 115 kV		No
1900	Torrington Terminal 115 kV	Campville 115 kV		No
1900 (w/ Element Restored)	Torrington Terminal 115 kV	Campville 115 kV		No
1921	Campville 115 kV	Thomaston 115 kV		No
1975	Haddam 115 kV	East Meriden 115 kV		Yes
<b>Overhead 69 kV Lines</b>				
667_689	Salisbury 69 kV	Falls Village 69 kV	Torrington Terminal 69 kV	No
690	Salisbury 69 kV	Smithfield 69 kV		No
693_694	Torrington Terminal 69 kV	Falls Village 69 kV	North Canaan 69 kV	No
<b>Autotransformers</b>				
Barbour Hill 1X	Barbour Hill 345 kV	Barbour Hill 115 kV		Yes
Frost Bridge 1X	Frost Bridge 345 kV	Frost Bridge 115 kV		Yes
Frost Bridge 1X(w/	Frost Bridge 345 kV	Frost Bridge 115 kV		Yes

Line/ Autotransformer	Station A	Station B	Station C	BPS Element
<b>Element Restored)</b>				
<b>Haddam 6X</b>	Haddam 345 kV	Haddam 115 kV		Yes
<b>North Bloomfield 5X</b>	North Bloomfield 345 kV	North Bloomfield 115 kV		Yes
<b>North Bloomfield 7X</b>	North Bloomfield 345 kV	North Bloomfield 115 kV		Yes
<b>Manchester 4X</b>	Manchester 345 kV	Manchester 115 kV		Yes
<b>Manchester 5X</b>	Manchester 345 kV	Manchester 115 kV		Yes
<b>Manchester 6X</b>	Manchester 345 kV	Manchester 115 kV		Yes
<b>Southington 1X</b>	Southington 345 kV	Southington 115 kV		Yes
<b>Southington 2X</b>	Southington 345 kV	Southington 115 kV		Yes
<b>Southington 3X</b>	Southington 345 kV	Southington 115 kV		Yes
<b>Southington 4X</b>	Southington 345 kV	Southington 115 kV		Yes
<b>Southington 4X (w/ Element Restored)</b>	Southington 345 kV	Southington 115 kV		Yes
<b>Generators</b>				
<b>Bridgeport Energy</b>	Bridgeport Energy 115 kV			Yes
<b>Bridgeport Harbor 3</b>	Pequonnock 115 kV			Yes
<b>Middletown 4</b>	Middletown 345kV			Yes
<b>New Haven Harbor</b>	New Haven 115 kV			Yes
<b>South Meadow 6</b>	South Meadow 115 kV			Yes
<b>Capitol District</b>	CDECCA 115 kV			No

# Section 11

## Appendix D: Contingency Listings

### 11.1 GHCC Area NERC Category B Contingencies

Generator Contingencies = 91 Total				
GN_11_10BE	GN_DEXT_2	GN_LRD1	GN_MON6	GN_SOM6
GN_12_10BE	GN_DV10	GN_LRD2	GN_NHHB	GN_STEV
GN_AETN_CC	GN_DV11	GN_LRD3	GN_NORWICH	GN_THAM
GN_ALP	GN_DV12	GN_MFD1	GN_NRW1	GN_TORR
GN_ANSONIA	GN_DV13	GN_MFD2	GN_NRW2	GN_TUNN
GN_BHR2	GN_DV14	GN_MI12	GN_NRW3	GN_UCONN_CC
GN_BHR3	GN_DV15	GN_MI13	GN_PLAINFLD	GN_WAL1
GN_BHR4	GN_DV16	GN_MI14	GN_QP248_2	GN_WAL2
GN_BPTR	GN_DV17	GN_MI15	GN_QP248_3	GN_WAL3
GN_BRAN	GN_DV18	GN_MIDLTWN10	GN_QP248_4	GN_WAL4
GN_BRF	GN_EXTR	GN_MIDLTWN2	GN_ROCK	GN_WAL5
GN_BULL	GN_FALS	GN_MIDLTWN3	GN_SECR	GN_WBRY
GN_CC10	GN_FOXWOOD_1	GN_MIDLTWN4	GN_SHEP	GN_WLRC
GN_CC11	GN_FOXWOOD_2	GN_MIL2	GN_SO11	GN_WTSD_1
GN_CC12	GN_FRDR	GN_MIL3	GN_SO12	GN_WTSD_2
GN_CC13	GN_KIMB_CC	GN_MO10	GN_SO13	GN_WTSD_3
GN_CC14	GN_KLEEN_CC	GN_MO11	GN_SO14	GN_YALE_DG_1
GN_DERB	GN_LISB	GN_MON5	GN_SOM5	GN_YALE_DG_2
GN_DEXT_1				

Line Contingencies = 271 Total				
LN_100	LN_1515S	LN_1751	LN_314	LN_364
LN_1000	LN_1522	LN_1752	LN_315	LN_3642
LN_1042	LN_1537	LN_1753	LN_316	LN_366
LN_1050	LN_1545	LN_1756	LN_3161	LN_368
LN_1070	LN_1550_1950	LN_1759	LN_3165	LN_370
LN_1080	LN_1555	LN_1760_1876	LN_3196	LN_371
LN_1090	LN_1560N	LN_1763	LN_321	LN_3754
LN_1100	LN_1560S	LN_1765	LN_3216	LN_376
LN_1120	LN_1565	LN_1766	LN_322	LN_381
LN_1130	LN_1570	LN_1767	LN_323	LN_3827
LN_1163	LN_1572_1772	LN_1769	LN_325	LN_383
LN_1165	LN_1575	LN_1770	LN_326	LN_384
LN_1191	LN_1580	LN_1771	LN_327	LN_387
LN_1200	LN_1585	LN_1773	LN_3271	LN_389
LN_1207	LN_1588	LN_1775	LN_328	LN_3921
LN_1208	LN_1594	LN_1776	LN_3280	LN_398
LN_1210	LN_1598	LN_1777	LN_329	LN_399

LN_1220	LN_1605	LN_1779	LN_330	LN_400
LN_1222	LN_1606	LN_1780	LN_331	LN_500
LN_1235	LN_1607	LN_1783	LN_332	LN_601
LN_1238_1813	LN_1610	LN_1785	LN_3320	LN_602
LN_1250	LN_1617	LN_1786	LN_3321	LN_603
LN_1256	LN_1618	LN_1788	LN_333	LN_667_689
LN_1261	LN_1620	LN_1790	LN_334	LN_690
LN_1270	LN_1621	LN_1792	LN_3340	LN_693_694
LN_1272	LN_1622	LN_1800	LN_3348	LN_800
LN_1280	LN_1630	LN_1810	LN_335	LN_8100
LN_1300	LN_1635	LN_1820	LN_336	LN_8200
LN_1310	LN_1637	LN_1825	LN_3361	LN_8300
LN_1319	LN_1640	LN_1830	LN_3381	LN_8301
LN_1337	LN_1650	LN_1835	LN_340	LN_8400
LN_1342	LN_1655	LN_1840	LN_3403	LN_84004
LN_1350	LN_1668	LN_1843	LN_341	LN_8500
LN_1355	LN_1670	LN_1867	LN_3419	LN_8600
LN_1363	LN_1675	LN_1870S	LN_342	LN_8700
LN_1365	LN_1682	LN_1880	LN_3424	LN_8702
LN_1389	LN_1685	LN_1887	LN_343	LN_88003A
LN_1394	LN_1690	LN_1890	LN_344	LN_88003A_UG
LN_1410	LN_1697	LN_1900	LN_347	LN_88005A
LN_1416	LN_1704	LN_1910	LN_348	LN_88006A
LN_1430	LN_1710	LN_1921	LN_350	LN_8804A
LN_1440	LN_1710_LS	LN_1943	LN_3512	LN_8809A
LN_1443	LN_1714	LN_1955	LN_352	LN_89003B
LN_1445	LN_1720	LN_1975	LN_3520	LN_89003B_UG
LN_1448	LN_1721	LN_1977	LN_3521	LN_89005B
LN_1450	LN_1722	LN_1985	LN_3533	LN_89006B
LN_1460	LN_1724	LN_1990	LN_354	LN_8904B
LN_1465	LN_1726	LN_301_302	LN_355	LN_8909B
LN_1466	LN_1730	LN_303	LN_3557	LN_900
LN_1470	LN_1732	LN_3041	LN_356	LN_91001
LN_1490	LN_1734	LN_308	LN_357	LN_9500
LN_1497	LN_1738	LN_310	LN_359	LN_9502
LN_1500	LN_1740	LN_312_393	LN_3619	LN_R118
LN_1505	LN_1742	LN_313	LN_362	
LN_1508	LN_1750			

Transformer Contingencies = 162 Total				
TF_AETN_GSU	TF_CARD_9X	TF_KLG2_GSU	TF_NORHAR_1X	TF_SNGTN_3X
TF_AGAWAM_1X	TF_CARP_HL_1	TF_KLST_GSU	TF_NORHAR_2X	TF_SNGTN_4X
TF_AGAWAM_2X	TF_COOL_K36X	TF_LISBON_GS	TF_NORHAR_8X	TF_SO11_SO12
TF_ALP_GSU	TF_COSCOB_GS	TF_LRD1_GSU	TF_NORWICH	TF_SO13_SO14
TF_ANSONIA	TF_CRVR_345A	TF_LRD2_GSU	TF_NRWLK_2/6	TF_SOM5_GSU
TF_AUBR_210X	TF_CRVR_345B	TF_LRD3_GSU	TF_NRWLK_8X	TF_SOM6_GSU
TF_AUBR_220X	TF_DEVON_10X	TF_LUDLOW_1X	TF_NRWLK_9X	TF_STEV_GSU
TF_BARBHL_1X	TF_DEVON_11X	TF_LUDLOW_3X	TF_NTHFLD_1X	TF_STNYB_10X
TF_BEL1_GSU	TF_DEVON_12X	TF_M1213_GSU	TF_NTHFLD_3X	TF_THAMS_GSU
TF_BEL2_GSU	TF_DEVON_13X	TF_M1415_GSU	TF_NWHV_T1	TF_TORR_10X
TF_BERRY_1X	TF_DEVON_14X	TF_MANCH_4X	TF_NWHV_T2	TF_TORR_1X
TF_BHR2_GSU	TF_DEVON_15X	TF_MANCH_5X	TF_OSG1_GSU	TF_TUNNEL_1X
TF_BHR3_GSU	TF_DEVON_17X	TF_MANCH_6X	TF_OSG2_GSU	TF_VERNON
TF_BHR4_GSU	TF_DEXT_GSU	TF_MFD12_GSU	TF_OSG3_GSU	TF_VTYA_4X
TF_BKS1_GSU	TF_EDEVON_2X	TF_MI10_GSU	TF_OSG4_GSU	TF_VTYA_GSU
TF_BKS2_GSU	TF_ES_8X_CSC	TF_MID2_GSU	TF_OST1_GSU	TF_WACHUS_T5
TF_BPTR_GSU	TF_ES_9X_CSC	TF_MID3_GSU	TF_OST2_GSU	TF_WACHUS_T6
TF_BRA4_GSU	TF_ESHORE_1X	TF_MID4_GSU	TF_PILG_GSU	TF_WACHUS_T7
TF_BRAY_3XAB	TF_ESHORE_8X	TF_MILSTN_2X	TF_PLNFD_GSU	TF_WAL12_GSU
TF_BRAY_5X	TF_ESHORE_9X	TF_MILSTN_3X	TF_PLUMTR_1X	TF_WAL345GSU
TF_BRPTE_10X	TF_EXTR_GSU	TF_MO10_GSU	TF_PLUMTR_2X	TF_WALTHM_2A
TF_BRPTE_11X	TF_FLSVL_GSU	TF_MON5_GSU	TF_QP248_GSU	TF_WAMSBY_T2
TF_BRPTE_12X	TF_FRSTB_1X	TF_MON6_GSU	TF_SACKET_PS	TF_WBRY_GSU
TF_BWTR_161X	TF_FRSTVL_2X	TF_MONT_16X	TF_SECREC_GS	TF_WFAR_174T
TF_BWTR_162X	TF_GLNBRK_4X	TF_MONTV_18X	TF_SERVRD_T1	TF_WFAR_175T
TF_CAN1_GSU	TF_GLNBRK_5X	TF_NBLOOM_5X	TF_SHEPAUG	TF_WLRC_GSU
TF_CAN2_GSU	TF_HADDAM_6X	TF_NBLOOM_7X	TF_SINGER_1X	TF_WMED_345A
TF_CANL_120X	TF_HOLB_345A	TF_NEA1_GSU	TF_SINGER_2X	TF_WMED_345B
TF_CANL_121X	TF_KENTCT_3X	TF_NEA2_GSU	TF_SNDYPD_1X	TF_WRUT_T1
TF_CANL_126X	TF_KENTCT_4X	TF_NEAS_GSU	TF_SNDYPD_2X	TF_WRUT_T2
TF_CANTON_2X	TF_KENTCT_5X	TF_NEWFANE_1	TF_SNGTN_1X	TF_WTRSD_GSU
TF_CARD_5X	TF_KILLNG_2X	TF_NORHAR_10	TF_SNGTN_2X	TF_WWALP_45A
TF_CARD_8X	TF_KLG1_GSU			



Bus Section Contingencies = 80 Total				
BS_ALLINGS_A	BS_BRDWHY_BC	BS_HAWTHRN_A	BS_MONTVLL_A	BS_SHELTON_A
BS_ALLINGS_B	BS_BRDWHY_T_A	BS_HAWTHRN_B	BS_MONTVLL_B	BS_SHELTON_B
BS_ANSON_T_A	BS_BRDWHY_T_D	BS_INDWELL_A	BS_N_HAVEN_A	BS_TORR_69KV
BS_ANSON_T_B	BS_CONGR_A_C	BS_INDWELL_B	BS_N_HAVEN_B	BS_TRPFALS_A
BS_ASHCR_T_A	BS_CONGR_B_D	BS_JUNE_ST_A	BS_NBLOOM_B	BS_TRPFALS_B
BS_ASHCR_T_B	BS_COOLIDGE	BS_JUNE_ST_B	BS_NORWALK_A	BS_TRUMBUL_A
BS_BAIRD_T_A	BS_COSCOB_A1	BS_KENTCTY_1	BS_NORWALK_B	BS_TRUMBUL_B
BS_BAIRD_T_B	BS_COSCOB_A2	BS_MANCHST_A	BS_OLDTOWN_A	BS_VTYA_115
BS_BARNM_T_A	BS_COSCOB_A3	BS_MANCHST_B	BS_OLDTOWN_B	BS_WATERST_B
BS_BARNM_T_B	BS_DEERFLDNH	BS_MILLRV_BC	BS_PLUMTRE_A	BS_WATERST_C
BS_BEACONFLS	BS_DEVON_T_A	BS_MILLRVR_A	BS_PLUMTRE_B	BS_WDMNT_T_A
BS_BERKSHR_A	BS_DEVON_T_B	BS_MILLRVR_D	BS_QUINN_T_A	BS_WDMNT_T_B
BS_BERLIN_A	BS_ELMWEST_A	BS_MILVN_T_A	BS_QUINN_T_B	BS_WMEDWAY_S
BS_BERLIN_B	BS_ELMWEST_B	BS_MILVN_T_B	BS_ROCKY_A3	BS_WRIVER_A
BS_BRDGWTR_N	BS_GLENBRK_A	BS_MIX_T_A	BS_SACKETT_A	BS_WRIVER_B
BS_BRDGWTR_S	BS_GLENBRK_B	BS_MIX_T_B	BS_SACKETT_B	BS_WRIVER_C

Loss of Element w/o Fault (Single Breaker Opening) - Total =30				
NF_348-3	NF_BESECK_R1	NF_BERLNCT_C	NF_HADDAM_C	NF_SO11_SO12
NF_352	NF_1300-2	NF_BRANFRD_C	NF_MANCH_C1	NF_SO13_SO14
NF_387-1	NF_1751-1	NF_CANTON_C	NF_MANCH_C2	NF_1256
NF_FRSTBR_1X	NF_1783-3	NF_FRKLNDR_C	NF_NBLOOM_C	NF_689
NF_MANCH_5X	NF_1910_R	NF_FRSTB_C1	NF_SNGTN_C1	NF_693
NF_SNGTN_4X	NF_1950_R	NF_FRSTB_C2	NF_SNGTN_C2	NF_694

Loss of Element w/o Fault (Multiple Breakers Opening) - Total =48				
NF_3424_MB	NF_1300-3_MB	NF_1670-3_MB	NF_1751-3_MB	NF_1786-2_MB
NF_348-1_MB	NF_1355-1_MB	NF_1704_MB	NF_1772_MB	NF_1786-3_MB
NF_348-2_MB	NF_1355-2_MB	NF_1710-3_MB	NF_1773_MB	NF_1788_MB
NF_364_MB	NF_1355-3_MB	NF_1722-1_MB	NF_1775-1_MB	NF_1810-1_MB
NF_3754_MB	NF_1550-1_MB	NF_1722-2_MB	NF_1775-2_MB	NF_1810-3_MB
NF_1163-1_MB	NF_1550-2_MB	NF_1722-3_MB	NF_1775-3_MB	NF_1810-4_MB
NF_1163-2_MB	NF_1550-3_MB	NF_1732-1_MB	NF_1783-1_MB	NF_1950_MB
NF_1163-3_MB	NF_1572_MB	NF_1732-2_MB	NF_1783-2_MB	NF_AETN_GSU_MB
NF_1238_MB	NF_1670-1_MB	NF_1732-3_MB	NF_1786-1_MB	NF_667_MB
NF_1300-1_MB	NF_1670-2_MB	NF_1751-2_MB		

## 11.2 GHCC Area NERC Category C Contingencies

Breaker Failure Contingencies = 585 Total				
BF_AGAWAM_2T	BF_DEVN_T_2T	BF_KLEEN_2T	BF_NRWLK_2T	BF_SNGTN_5T
BF_AGAWAM_5T	BF_DEVN_T_3T	BF_KLEEN_3T	BF_NRWLK_3T	BF_SNGTN_6T
BF_AGAWM_22T	BF_DEVN_T_4T	BF_KLEEN_4T	BF_NRWLK_4T	BF_SNGTN_7T

BF_AGAWM_25T	BF_DEVON_10T	BF_KLEEN_6T	BF_NRWLK_5T	BF_SNGTN_9T
BF_AGAWM_26T	BF_DEVON_11T	BF_KNTC_115E	BF_NRWLK_6T	BF_SOMST_12
BF_ALLNGS_1T	BF_DEVON_12T	BF_KNTC_345B	BF_NRWLK_7T	BF_SOMST_A
BF_ALLNGS_2T	BF_DEVON_1T	BF_KNTC_345C	BF_NRWLK_8T	BF_STCKHS_1T
BF_ANSON_1T	BF_DEVON_20T	BF_KNTC_345E	BF_NRWLK_9T	BF_STEV_1560
BF_ANSON_2T	BF_DEVON_23T	BF_KNTC_345F	BF_NTHFLD_1T	BF_STEV_1876
BF_ANSON_3T	BF_DEVON_24T	BF_KNTC_4T20	BF_NTHFLD_2T	BF_STEV_1990
BF_ASHCRK_3B	BF_DEVON_25T	BF_KNTC_8510	BF_NTHFLD_3T	BF_STGTN_101
BF_AUBURN_02	BF_DEVON_26T	BF_KNTC_8520	BF_NTHFLD_4T	BF_STGTN_102
BF_AUBURN_03	BF_DEVON_27T	BF_KNTC_8589	BF_NTHFLD_5T	BF_STGTN_103
BF_AUBURN_40	BF_DEVON_28T	BF_KNTC_8910	BF_NWALFD_1T	BF_STGTN_104
BF_AUBURN_41	BF_DEVON_29T	BF_LAKERD_2T	BF_NWHART_31	BF_STGTN_105
BF_BAIRD_75A	BF_DEVON_3T	BF_LAKERD_5T	BF_NWHART_32	BF_STHEND_5T
BF_BAIRD_75B	BF_DEVON_6T	BF_LAKERD_8T	BF_NWHART_33	BF_STONY_1T2
BF_BARBH_18T	BF_DEVON_7T	BF_DEVN_T_1T	BF_NWHV_370	BF_STPSTN_1T
BF_BARBH_21T	BF_DEVON_8T	BF_LUDLOW_1T	BF_NWHV_371	BF_SWHART_1T
BF_BARBHL_3T	BF_DOOLEY_2T	BF_LUDLOW_2T	BF_NWHV_4163	BF_SWNDSR_1T
BF_BARBHL_4T	BF_EDEVN_11T	BF_LUDLOW_3T	BF_NWHV_4341	BF_THMSTN_2T
BF_BARBHL_5T	BF_EDEVN_24T	BF_LUDLOW_4T	BF_NWHV_6342	BF_TODD_1T-2
BF_BATES_1T2	BF_EHART_1T	BF_LUDLOW_5T	BF_NWHV_6442	BF_TORR_10X1
BF_BE_10X	BF_EMERDN_1T	BF_LUDLOW_6T	BF_NWNGTN_1T	BF_TORR_1T-2
BF_BE_11X	BF_ENEWBR_69	BF_LUDLOW_7T	BF_NWNGTN_2T	BF_TORR_6892
BF_BEANHL_1T	BF_ENEWBR_83	BF_LUDLOW_8T	BF_OLDTWN_1T	BF_TORR_6932
BF_BEEN_1319	BF_ENFLD_1T	BF_LUDLOW_9T	BF_OXFORD_1T	BF_TRACY_1T2
BF_BEEN_1570	BF_ESHOR_1K	BF_LUDLW_41T	BF_PEACE_1T2	BF_TRAPFL_1T
BF_BELL_3-20	BF_ESHOR_2K	BF_LUDLW_43T	BF_PEQNC_12T	BF_TRINGL_2T
BF_BERLIN_13	BF_ESHORE_11	BF_LUDLW_44T	BF_PEQNC_22T	BF_TRINGL_3T
BF_BERLIN_14	BF_ESHORE_12	BF_LUDLW_46T	BF_PEQNC_2T	BF_TRINGL_4T
BF_BERLIN_15	BF_ESHORE_13	BF_LUDLW_47T	BF_PEQNC_32T	BF_TRINGL_5T
BF_BERLIN_22	BF_ESHORE_21	BF_LUDLW_49T	BF_PEQNC_42T	BF_TRMBUL_1T
BF_BERLIN_23T	BF_ESHORE_22	BF_MANCH_10T	BF_PEQU_32T	BF_TRMBUL_2T
BF_BERLIN_24	BF_ESHORE_23	BF_MANCH_11T	BF_PEQU_42T	BF_TRMBUL_3T
BF_BERLIN_25	BF_ESHORE_31	BF_MANCH_13T	BF_PILGM_104	BF_TUNNEL_1T
BF_BERLIN_26	BF_ESHORE_32	BF_MANCH_14T	BF_PILGM_105	BF_TUNNEL_2T
BF_BERLIN_27	BF_ESHORE_33	BF_MANCH_15T	BF_PLUMT_1X3	BF_TUNNEL_3T
BF_BERY_345A	BF_ESHORE_41	BF_MANCH_17T	BF_PLUMT_23T	BF_TUNNEL_4T
BF_BERY_345B	BF_ESHORE_43	BF_MANCH_18T	BF_PLUMT_24T	BF_TUNNEL_5T
BF_BERY_345C	BF_ESHORE_71	BF_MANCH_19T	BF_PLUMT_25T	BF_TWKS_7-39
BF_BESECK_8T	BF_ESHORE_73	BF_MANCH_1T	BF_PLUMT_26T	BF_TWKS_8-97
BF_BLDWN_2T2	BF_FARMTN_1T	BF_MANCH_20T	BF_PLUMT_29T	BF_VERN_3TB1
BF_BLDWN_5T2	BF_FARMTN_2T	BF_MANCH_21T	BF_PLUMT_2T	BF_VERN_3TB2
BF_BLKST_101	BF_FARMTN_3T	BF_MANCH_22T	BF_PLUMT_2X3	BF_VERN_3TB3
BF_BLKST_102	BF_FLAXHL_2T	BF_MANCH_23T	BF_PLUMT_30T	BF_VERN_KTB1
BF_BLKST_103	BF_FLNDRS_1T	BF_MANCH_24T	BF_PLUMT_31T	BF_VTYK_1T
BF_BLKST_104	BF_FLSVL_694	BF_MANCH_25T	BF_PLUMT_32T	BF_VTYK_381

BF_BLMFLD_1T	BF_FRAMNG_1	BF_MANCH_2T	BF_PLUMT_4X1	BF_VTYK_40/1
BF_BLMFLD_2T	BF_FRDR_1T-2	BF_MANCH_3T	BF_PRTLND_2T	BF_VTYK_811T
BF_BLMFLD_3T	BF_FREGHT_1T	BF_MANCH_4T	BF_QNNIPC_1T	BF_VTYK_9-40
BF_BOKUM_1T	BF_FREGHT_2T	BF_MANCH_5T	BF_RESCO_9R	BF_WACH_13T
BF_BOKUM_2T	BF_FRNCON_2T	BF_MANCH_6T	BF_RKYHIL_1T	BF_WACH_141N
BF_BOKUM_3T	BF_FRSTB_14T	BF_MANCH_7T	BF_RKYHIL_2T	BF_WACH_141W
BF_BRANF_1T	BF_FRSTB_15T	BF_MANCH_8T	BF_ROCKY_1T2	BF_WACH_142N
BF_BRANF_2T	BF_FRSTB_16T	BF_MIDLTN_10	BF_ROCKY_2T2	BF_WACH_142W
BF_BRANF_4T	BF_FRSTB_1T2	BF_MIDLTN_11	BF_ROOD_1T	BF_WACH_24T
BF_BRANFRR_1	BF_FRSTB_1X2	BF_MIDLTN_3	BF_SACKET_1T	BF_WACH_2-7T
BF_BRDWAY_1T	BF_FRSTB_20T	BF_MIDLTN_7	BF_SALS_1T-2	BF_WACH_3-6T
BF_BRDWAY_2T	BF_FRSTB_21T	BF_MIDRV_1T2	BF_SASCO_1T	BF_WACH_3-7T
BF_BRGWTR_01	BF_FRSTB_22T	BF_MIDRV_2T2	BF_SCOVRK_5T	BF_WACH_4-7T
BF_BRGWTR_04	BF_FRSTB_23T	BF_MILB_0802	BF_SCOVRK_8T	BF_WACH_6T
BF_BRGWTR_07	BF_FRSTB_24T	BF_MILB_1357	BF_SCTICO_1T	BF_WACH_7T
BF_BRGWTR_13	BF_FRSTB_26T	BF_MILB_345B	BF_SERV_RD_A	BF_WALNFD_1T
BF_BRGWTR_40	BF_FRSTB_27T	BF_MILLRV_1T	BF_SHAWS_1T2	BF_WALNFD_2T
BF_BRGWTR_49	BF_FRSTB_28T	BF_MILLRV_2T	BF_SHELTN_1T	BF_WALNFD_3T
BF_BRGWTR_60	BF_FRSTB_2X2	BF_MILST_14T	BF_SHEP_1887	BF_WALNFD_4T
BF_BRGWTR_70	BF_FRSTVL_1T	BF_MILST_8T	BF_SHRMN_143	BF_WALNFD_5T
BF_BRGWTR_80	BF_FRSTVL_2T	BF_MIXAVE_1T	BF_SHUNOK_2T	BF_WALNFD_6T
BF_BRGWTR_90	BF_FTHILL_1T	BF_MIXPDS_3X	BF_SINGR_22T	BF_WATRST_1T
BF_BRISTL_1T	BF_GLBK_10K	BF_MONTV_10T	BF_SINGR_52T	BF_WATRST_2T
BF_BRKSH_12T	BF_GLBK_1753	BF_MONTV_11T	BF_SMEAD_10	BF_WBKFD_1T2
BF_BRKSH_15T	BF_GLBK_1792	BF_MONTV_12T	BF_SMEAD_2	BF_WESTSD_1T
BF_BUDNTN_4T	BF_GLBK_1867	BF_MONTV_13T	BF_SMEAD_3	BF_WFARN_170
BF_BUNKR_1T2	BF_GLBK_1977	BF_MONTV_14T	BF_SMEAD_4	BF_WFARN_176
BF_BUNKR_2T2	BF_GLBK_20K	BF_MONTV_15T	BF_SMEAD_5	BF_WFARN_710
BF_BUNKR_3T2	BF_GLBK_20T	BF_MONTV_16T	BF_SMEAD_7	BF_WFARN_711
BF_BYPT_3-3T	BF_GLBK_22T	BF_MONTV_17T	BF_SMEAD_8	BF_WFARN_714
BF_BYPT_345D	BF_GLBK_23T	BF_MONTV_18T	BF_SNAUG_1T	BF_WFARN_715
BF_CAMPVL_1T	BF_GLBK_25T	BF_MONTV_18X	BF_SNDPD_137	BF_WFARN_C
BF_CAMPVL_2T	BF_GLBK_2T2	BF_MONTV_19T	BF_SNDPD_161	BF_WFARN_F
BF_CAMPVL_3T	BF_GLBK_3T	BF_MONTV_20T	BF_SNDPD_314	BF_WHMPDN_A1
BF_CAMPVL_4T	BF_GLBK_4T	BF_MONTV_21T	BF_SNDPD_326	BF_WHMPDN_A2
BF_CANAL_112	BF_GLBK_4X12	BF_MONTV_22T	BF_SNDPD_337	BF_WILTON_1T
BF_CANAL_212	BF_GLBK_5X12	BF_MONTV_23T	BF_SNDPD_343	BF_WMDWY_101
BF_CANAL_312	BF_GLBK_7T	BF_MONTV_24T	BF_SNDPD_37E	BF_WMDWY_103
BF_CANAL_412	BF_GLBK_8T	BF_MONTV_4T	BF_SNDPD_37W	BF_WMDWY_104
BF_CANAL_512	BF_GLBK_9T	BF_MONTV_9T	BF_SNDPD_38E	BF_WMDWY_105
BF_CANAL_612	BF_GRAND_22T	BF_MYSCT_1T2	BF_SNDPD_38W	BF_WMDWY_106
BF_CANTN_1T2	BF_GRAND_32T	BF_NBLMF_13T	BF_SNDPD_412	BF_WMDWY_107
BF_CANTN_2T2	BF_GRAND_42T	BF_NBLMF_14T	BF_SNDPD_512	BF_WMDWY_108
BF_CARD_10T	BF_GRNHIL_1T	BF_NBLMF_20T	BF_SNDPD_521	BF_WMDWY_109
BF_CARD_11T	BF_GRNHIL_2T	BF_NBLMF_23T	BF_SNDPD_612	BF_WMDWY_111

BF_CARD_12T	BF_HADDAM_26	BF_NBLMF_2T	BF_SNDPD_643	BF_WMDWY_112
BF_CARD_13T	BF_HADDAM_27	BF_NBLMF_5T	BF_SNGTN_10K	BF_WNSRLK_1T
BF_CARD_14T	BF_HADDAM_29	BF_NBLMF_5X3	BF_SNGTN_11T	BF_WOODMT_1T
BF_CARD_15T	BF_HADDAM_32	BF_NBLMF_7X3	BF_SNGTN_14T	BF_WOODMT_2T
BF_CARD_16T	BF_HADDAM_33	BF_NEA_1CB2	BF_SNGTN_15T	BF_WOODRV_70
BF_CARD_1T	BF_HADDAM_35	BF_NEA_1CB3	BF_SNGTN_16T	BF_WRUT_3039
BF_CARD_345K	BF_HADDAM_37	BF_NESIMS_2T	BF_SNGTN_17T	BF_WRUT_3440
BF_CARD_3T	BF_HADDAM_5X	BF_NEWF_20T2	BF_SNGTN_18T	BF_WRUT_350
BF_CARVR_162	BF_HADDAM_6X	BF_NEWF_3320	BF_SNGTN_1T	BF_WRUT_360
BF_CARVR_262	BF_HADDAMN_1T	BF_NEWF_3321	BF_SNGTN_20T	BF_WRUT_371
BF_CARVR_552	BF_HADDAMN_2T	BF_NHAVEN_1T	BF_SNGTN_21T	BF_WRUT_372
BF_CARVR_652	BF_HADDAMN_4T	BF_NHAVEN_2T	BF_SNGTN_22T	BF_WRUT_3740
BF_CARVR_862	BF_HALVAR_1X	BF_NORHAR_1T	BF_SNGTN_23T	BF_WRUT_3937
BF_CHIPL_1T	BF_HAWTRN_1T	BF_NORHAR_2T	BF_SNGTN_24T	BF_WTRFRD_1T
BF_CHL_23-1T	BF_HOLBR_102	BF_NORHAR_3T	BF_SNGTN_25T	BF_WTRSD_1T2
BF_CHL_321	BF_HOLBR_107	BF_NORHAR_4T	BF_SNGTN_26T	BF_WTRSD_2T2
BF_COLONY_1T	BF_HOLBR_7	BF_NORHAR_5T	BF_SNGTN_28T	BF_WTRSD_3T2
BF_COMPO_1T	BF_HOPEWL_2T	BF_NORHAR_6T	BF_SNGTN_29T	BF_WWALP_104
BF_COOL_3TB2	BF_INDWEL_1T	BF_NORHAR_7T	BF_SNGTN_30T	BF_WWALP_105
BF_COOL_K32	BF_JUNEST_1T	BF_NORHN_1K	BF_SNGTN_31T	BF_WWALP_107
BF_COOL_K36	BF_KILLNG_22	BF_NRWLK_10T	BF_SNGTN_33T	BF_WWALP_108
BF_COSCOB_1T	BF_KILLNG_25	BF_NRWLK_11T	BF_SNGTN_3T	BF_WWALP_109
BF_COSCOB_2T	BF_KILLNG_3T	BF_NRWLK_12T	BF_SNGTN_3X3	BF_WWALP_7
BF_DARIEN_1T	BF_KLEEN_1T	BF_NRWLK_1T	BF_SNGTN_4T	BF_WWALP_8

Double Circuit Tower Contingencies = 157 Total				
DC_1000_1070	DC_1355_1610	DC_1620_1975	DC_1820_1830	DC_364_1250
DC_1000_1080	DC_1355_1690	DC_1621_1742	DC_1867_1880	DC_3642_1779
DC_1000_1090	DC_1389_1880	DC_1622_1770	DC_1867_1890	DC_368_1767
DC_1070_1080	DC_1394_1858	DC_1630_1640	DC_1867_1977	DC_3754_1466
DC_1080_100	DC_1394_5155	DC_1630_1655	DC_1880_1890	DC_376_1772
DC_1080_1280	DC_1410_100	DC_1635_1763	DC_1910_1950	DC_379_N186
DC_1080_1410	DC_1410_400	DC_1637_1720	DC_3196_1314	DC_381_N186
DC_1080_1490	DC_1416_1867	DC_1640_1685	DC_3196_1602	DC_3827_1208
DC_1080_1675	DC_1416_1880	DC_1668_1721	DC_3196_1603	DC_3827_1610
DC_1100_1200	DC_1416_1890	DC_1670_1820	DC_321_1618	DC_3827_1655
DC_1100_1300	DC_1440_1450	DC_1670_1830	DC_321_1770	DC_387_1460
DC_1130_1430	DC_1440_1750	DC_1710_1714	DC_321_1887	DC_387_1537
DC_1130_9100	DC_1445_1721	DC_1710_1730	DC_3216_1768	DC_387_1975
DC_1163_1550	DC_1448_1751	DC_1714_1720	DC_3216_1781	DC_400_500
DC_1191_1921	DC_1460_1537	DC_1714_1730	DC_325_331	DC_560N_1570
DC_1200_1300	DC_1470_1565	DC_1720_1714	DC_325_344	DC_560N_1594
DC_1207_1775	DC_1500_1605	DC_1732_1788	DC_335_1-536	DC_580/710LS
DC_1208_1640	DC_1505_1607	DC_1732_1900	DC_337_1161	DC_689_693
DC_1210_1220	DC_1537_1655	DC_1740_1750	DC_3403_1565	DC_697/710LS

DC_1222_1714	DC_1550_1910	DC_1751_1756	DC_342_120W	DC_710/714LS
DC_1235_1250	DC_1570_1580	DC_1751_1777	DC_342_194	DC_800_900
DC_1261_1598	DC_1570_1585	DC_1752_1773	DC_342_355	DC_8100_8200
DC_1272_1721	DC_1572_1620	DC_1770_1887	DC_344_A24	DC_8300_8400
DC_1280_100	DC_1575_1585	DC_1771_1820	DC_348_1772	DC_8300_8600
DC_1280_1410	DC_1575_1990	DC_1775_1786	DC_348_1975	DC_8400_8600
DC_1280_1465	DC_1580_1585	DC_1780_1790	DC_3557_1448	DC_88/89005
DC_1280_400	DC_1580_1710	DC_1788_1900	DC_356_E1	DC_88/89006
DC_1310_1635	DC_1580_1730	DC_1800_1810	DC_362_1772	DC_88003A/89
DC_1310_1763	DC_1606_1724	DC_1800_1825	DC_362_1975	DC_8804_8904
DC_1319_1570	DC_1610_1640	DC_1810_1825	DC_362_376	DC_8809_8909
DC_1319_1580	DC_1610_1685	DC_1810_1835	DC_364_1235	DC_K371_K34
DC_1319_1585	DC_1618_1887			

### 11.3 GHCC Area Special Protection System and Automatic Control Scheme Contingencies

SPS Contingencies = 66 Total				
SPS_1570-2	SPS_8809A	SPS_BSCON_AC	SPS_LN_1130	SPS_GR42T_RB
SPS_17101697	SPS_89003_RB	SPS_BSCON_BD	SPS_LN_1697	SPS_GR42T_TR
SPS_387+NHHB	SPS_89003_TR	SPS_BSELMARB	SPS_LN_1710	SPS_327_315
SPS_387-1	SPS_8909B	SPS_BSELMATR	SPS_LN_91001	SPS_WAT1T_RB
SPS_393+690	SPS_ALS1T_RB	SPS_BSELMBRB	SPS_MIL1T_RB	SPS_WAT1T_TR
SPS_398+690	SPS_ALS1T_TR	SPS_BSELMBTR	SPS_MIL1T_TR	LN_398+690_SPS
SPS_690	SPS_ALS2T_RB	SPS_BSWRVARB	SPS_NHHB	TF_MILSTN_3X+690_SPS
SPS_8301_RB	SPS_ALS2T_TR	SPS_BSWRVATR	ACS_SNGTN_5T	BF_CAMPVL_2T / DC_1191_1921+690_SPS
SPS_8301_TR	SPS_BF_BARDA	SPS_BSWRVBRB	SPS_TRMTB	BF_CAMPVL_4T / DC_1732_1900+690_SPS
SPS_8500_RB	SPS_BF_BARDB	SPS_BSWRVBTR	SPS_GR22T_RB	BF_MILST_14T+690_SPS
SPS_8500_TR	SPS_BF_TRM1T	SPS_CHL_231T	SPS_GR22T_TR	BF_NBLMF_23T+690_SPS
SPS_88003_RB	SPS_BF_TRM2T	SPS_D88003RB	SPS_GR32T_RB	BF_NTHFLD_1T+690_SPS
SPS_88003_TR	SPS_BS_ASHTB	SPS_D88003TR	SPS_GR32T_TR	HVDC_PHASE_2+690_SPS
SPS_88098909				

## 11.4 GHCC Area NERC Category D Contingencies

Generation Station Contingencies - Total = 11				
GS_BRPT_HBEN	GS_MIDDLTWN	GS_MONTVILLE	GS_NRWLKHBR	GS_WALLNGFRD
GS_COSCOB	GS_MILLSTONE	GS_NEW_HAVEN	GS_S-MEADOW	GS_WATERSIDE
GS_DEVON				

Loss of Substation contingencies - Total = 5				
SS_MANCH_345	SS_STGTN_115	SS_DEVON_115	SS_MLSTN_345	SS_MANCH_115

Loss of Right of way contingencies - Total = 5				
ROW_CHST_DLY	ROW_HBRKJ_NO	ROW_SGTN_SCO	ROW_HBRKJ_EH	ROW_STV_BNKR

# Section 12

## Appendix E: Steady State Testing Results

[Appendix E1 Thermal N-1 Results.xlsx](#)

[Appendix E2 Voltage N-1 Results PTF Buses.xlsx](#)

[Appendix E3 Voltage N-1 Results non-PTF Buses.xlsx](#)

[Appendix E4 Non-conv N-1 Results.xlsx](#)

[Appendix E5 Gen Adjustments for N-1 Cases.xlsx](#)

[Appendix E6 Thermal N-1-1 Results.xlsx](#)

[Appendix E7 Voltage N-1-1 Results PTF Buses.xlsx](#)

[Appendix E8 Voltage N-1-1 Results non-PTF Buses.xlsx](#)

[Appendix E9 Non Conv N-1-1 Results.xlsx](#)

[Appendix E10 Gen Adjustments for N-1-1 Cases.xlsx](#)

# Section 13

## Appendix F: Extreme Contingency Testing Results

[Appendix F - GHCC EC Results.xlsx](#)



# Section 14

## Appendix G: Short Circuit Testing Results

[Appendix G - Short Circuit Results.xlsx](#)

# Section 15

## Appendix H: Critical Load Level Assessment Testing

The following sections identify the different contingency pairs evaluated and the reason for them being included in the analysis. Two tables are identified for each subarea. One consists of the thermal violations and the other has the voltage violations.

### 15.1 Greater Hartford Subarea

Table 15-1 has the dispatches and contingency pairs that were tested to determine the critical load level for elements in the Greater Hartford subarea with thermal violations.

**Table 15-1:  
Greater Hartford Subarea Thermal Violations for Critical Load Levels Assessment**

Element ID	Overloading Element	Initial Element OOS	Contingency	Dispatch
1207	Manchester – E Hartford	[REDACTED]	[REDACTED]	HTFD_02
1704	S Meadow - SW Hartford	[REDACTED]	[REDACTED]	HTFD_2A
1726	N Bloomfield - Farmington	[REDACTED]	[REDACTED]	MIDD_01
1751	Bloomfield Jct – NW Hartford	[REDACTED]	[REDACTED]	HTFD_02
1752	Rocky Hill - Berlin	[REDACTED]	[REDACTED]	MIDD_01
1756	Bloomfield – NW Hartford	[REDACTED]	[REDACTED]	HTFD_02
1765	Berlin – Westside	[REDACTED]	[REDACTED]	MIDD_01
1769	Berlin – E New Britain	[REDACTED]	[REDACTED]	MIDD_01
1771	Southington - Berlin	[REDACTED]	[REDACTED]	MIDD_01
1773	S Meadow – Rocky Hill	[REDACTED]	[REDACTED]	MIDD_01
1777	N Bloomfield - Bloomfield	[REDACTED]	[REDACTED]	HTFD_02
1779	S Meadow - Bloomfield	[REDACTED]	[REDACTED]	HTFD_02
1785	Berlin - Newington	[REDACTED]	[REDACTED]	MIDD_01
1670-1	Southington – Reservoir Rd Jct	[REDACTED]	[REDACTED]	MIDD_01
1670-2	Reservoir Rd Jct - Berlin	[REDACTED]	[REDACTED]	MIDD_01
1722-1	SW Hartford – Capitol District Tap	[REDACTED]	[REDACTED]	HTFD_2A
1722-2	Capitol District Tap – NW Hartford	[REDACTED]	[REDACTED]	CCRP_04
1775-1	Riverside Tap – S Meadow	[REDACTED]	[REDACTED]	HTFD_02
1775-2	Manchester – Riverside Tap	[REDACTED]	[REDACTED]	HTFD_02
1783-1	Farmington – Newington Tap	[REDACTED]	[REDACTED]	MIDD_01
1783-2	Newington Tap - Newington	[REDACTED]	[REDACTED]	CCRP_02
1783-3	E New Britain – Riverside	[REDACTED]	[REDACTED]	MIDD_01

Element ID	Overloading Element	Initial Element OOS	Contingency	Dispatch
	Tap			
1950	Southington – Canal	█	█	CCRP_01
NWHTFD 32T	Breaker 32T Bus Segment	█	█	CCRP_04
STGTN 2X	Southington 2X Auto	█	█	CCRP_01
STGTN 3X	Southington 3X Auto	█	█	CCRP_01

Table 15-2 summarizes the dispatches and contingency pairs that were tested to determine the critical load level to eliminate the voltage violations in the Greater Hartford subarea.

**Table 15-2:  
Greater Hartford Subarea Voltage Violations for Critical Load Level Assessment**

Bus Name – Voltage	Initial Element OOS	Worst-case Contingency	Dispatch
Berlin – 115 kV	█	█	MIDD_01
Bloomfield – 115 kV	█	█	HTFD_02
Capitol District – 115 kV	█	█	HTFD_02
E New Britain – 115 kV	█	█	NWCT_2A
Farmington – 115 kV	█	█	MIDD_01
Newington – 115 kV	█	█	NWCT_2A
NW Hartford – 115 kV	█	█	HTFD_02
Rocky Hill – 115 kV	█	█	MIDD_01
West Side – 115 kV	█	█	NWCT_01
SW Hartford – 115 kV	█	█	HTFD_02
Black Rock – 115 kV (Non-PTF)	█	█	MIDD_01
GE Test – 115 kV (Non-PTF)	█	█	MIDD_01

## 15.2 Manchester-Barbour Hill Subarea

Table 15-3 has the dispatches and contingency pairs that were tested to determine the critical load level for elements in the Manchester-Barbour Hill subarea with thermal violations.

**Table 15-3:  
Manchester-Barbour Hill Subarea Thermal Violations for Critical Load Level  
Assessment**

Element ID	Overloading Element	Initial Element OOS	Worst-Case Contingency	Dispatch
1310	Manchester – South Windsor	[REDACTED]	[REDACTED]	BHIL_01
1635	South Windsor – Barbour Hill	[REDACTED]	[REDACTED]	BHIL_01
1763	Manchester – Barbour Hill	[REDACTED]	[REDACTED]	BHIL_01
MANCH 4X	Manchester 345/115 Autotransformer	[REDACTED]	[REDACTED]	MIDD_01
MANCH 6X	Manchester 345/115 Autotransformer	[REDACTED]	[REDACTED]	MIDD_01

Table 15-4 summarizes the dispatches and contingency pairs that were tested to determine the critical load level to eliminate the voltage violations in the Manchester-Barbour Hill subarea.

**Table 15-4: Manchester-Barbour Hill Subarea Voltage Violations for Critical Load  
Level Assessment**

Bus Name	Initial Element OOS	Worst-Case Contingency	Dispatch
Barbour Hill – 115 kV	[REDACTED]	[REDACTED]	BHIL_01
South Windsor – 115 kV	[REDACTED]	[REDACTED]	BHIL_01
Dexter – 115 kV (Non-PTF)	[REDACTED]	[REDACTED]	BHIL_01
Enfield – 115 kV (Non-PTF)	[REDACTED]	[REDACTED]	BHIL_01
Rockville – 115 kV (Non-PTF)	[REDACTED]	[REDACTED]	BHIL_01
Windsor Locks – 115 kV (Non-PTF)	[REDACTED]	[REDACTED]	BHIL_01

### 15.3 Middletown Subarea

Table 15-5 has the dispatches and contingency pairs that were tested to determine the critical load level for elements in the Middletown subarea with thermal violations.

**Table 15-5:  
Middletown Subarea Thermal Violations for Critical Load Level Assessment**

Element ID	Overloading Element	Initial Element OOS	Worst-case Contingency	Dispatch
1050	Middletown – Dooley	[REDACTED]	[REDACTED]	HTFD_2A
1261	Haddam - Bokum (Circuit 1)	[REDACTED]	[REDACTED]	MIDD_02
1443	Portland – Middletown	[REDACTED]	[REDACTED]	MIDD_01
1588	Colony – N Wallingford	[REDACTED]	[REDACTED]	MIDD_01
1598	Haddam - Bokum (Circuit 2)	[REDACTED]	[REDACTED]	MIDD_02
1620	Middletown – Haddam	[REDACTED]	[REDACTED]	CCRP_04
1759	Hopewell – Portland	[REDACTED]	[REDACTED]	MIDD_01
1766	Dooley - Westside	[REDACTED]	[REDACTED]	HTFD_2A
1355-1	Hanover Tap – Colony	[REDACTED]	[REDACTED]	MIDD_01
1355-3	Southington – Hanover Tap	[REDACTED]	[REDACTED]	MIDD_01

Table 15-6 summarizes the dispatches and contingency pairs that were tested to determine the critical load level to eliminate the voltage violations in the Middletown subarea.

**Table 15-6:  
Middletown Subarea Voltage Violations for Critical Load Level Assessment**

Bus Name	Initial Element OOS	Worst-case Contingency	Dispatch
Bokum – 115 kV	[REDACTED]	[REDACTED]	MIDD_01
Colony – 115 kV	[REDACTED]	[REDACTED]	MIDD_01
Dooley – 115 kV	[REDACTED]	[REDACTED]	MIDD_01
East Meriden – 115 kV	[REDACTED]	[REDACTED]	MIDD_01
Green Hill – 115 kV	[REDACTED]	[REDACTED]	MIDD_01
Haddam – 115 kV	[REDACTED]	[REDACTED]	MIDD_01
Hanover – 115 kV	[REDACTED]	[REDACTED]	MIDD_01
Hopewell – 115 kV	[REDACTED]	[REDACTED]	MIDD_01
Middletown – 115 kV	[REDACTED]	[REDACTED]	MIDD_01
N Wallingford – 115 kV	[REDACTED]	[REDACTED]	MIDD_01
Portland – 115 kV	[REDACTED]	[REDACTED]	MIDD_01
Pratt and Whitney – 115 kV	[REDACTED]	[REDACTED]	MIDD_01
Stepstone – 115 kV	[REDACTED]	[REDACTED]	MIDD_01

Bus Name	Initial Element OOS	Worst-case Contingency	Dispatch
Branford – 115 kV			MIDD_01

## 15.4 Northwestern Connecticut Subarea

Table 15-7 has the dispatches and contingency pairs that were tested to determine the critical load level for elements in the Northwestern Connecticut subarea with thermal violations.

**Table 15-7:  
Northwestern CT Subarea Thermal Violations for Critical Load Level Assessment**

Element ID	Overloading Element	Initial Element OOS	Worst-case Contingency	Dispatch	Comments
1256	NE Simsbury – Canton			CCRP_04	Testing performed with and without 690 SPS action
1191	Frost Bridge – Campville			CCRP_04	No SPS Action
1732	Campville – Weingarten Junction			IRP_01	Testing performed with and without 690 SPS action
1825	Bristol – Forestville			CCRP_04	No SPS Action
1835	Chippen Hill – Thomaston			CCRP_04	Testing performed with and without 690 SPS action
1921	Thomaston – Campville			CCRP_04	Testing performed with and without 690 SPS action
1810-1	Southington – Lake Ave Junction			CCRP_04	Testing performed with and without 690 SPS action
1810-3	Lake Ave Junction – Chippen Hill			CCRP_04	Testing performed with and without 690 SPS action
CMPVL 1T	Campville 1T Bus Section			CCRP_04	No SPS Action
CMPVL 3T	Campville 3T Bus Section			CCRP_04	Testing performed with and without 690 SPS action

Table 15-8 summarizes the dispatches and contingency pairs that were tested to determine the critical load level to eliminate the voltage violations in the Northwestern Connecticut subarea.

**Table 15-8:  
Northwestern CT Subarea Voltage Violations for Critical Load Level Assessment**

Bus Name	Initial Element OOS	Worst-case Contingency	Dispatch	Comments
Bristol – 115 kV	█	████████████████████	CCRP_04	Testing performed with and without 690 SPS action
Campville – 115 kV	█	████████████████████	CCRP_04	Testing performed with and without 690 SPS action
Campville – 115 kV	█	████████████████	CCRP_04	Testing performed with and without 690 SPS action
Canton – 115 kV	█	████████████████████	CCRP_04	Testing performed with and without 690 SPS action)
Chippen Hill – 115 kV	█	████████	CCRP_04	Testing performed with and without 690 SPS action)
Falls Village – 69 kV (PTF)	█	████████████████████	CCRP_04	Testing performed with and without 690 SPS action
Forestville – 115	█	████████████████████	NWCT_02	No SPS Action
Franklin Drive – 115 kV	█	████████████████████	CCRP_04	Testing performed with and without 690 SPS action
NE Simsbury – 115 kV	█	████████████████████	CCRP_04	Testing performed with and without 690 SPS action
Salisbury – 69 kV	█	████████████████████	CCRP_04	Testing performed with and without 690 SPS action
Thomaston – 115 kV	█	████████	CCRP_04	Testing performed with and without 690 SPS action)
Torrington – 115 kV	█	████████████████████	CCRP_04	Testing performed with and without 690 SPS action
Torrington – 69 kV	█	████████████████████	CCRP_04	Testing performed with and without 690 SPS action
Falls Village – 69 kV (non - PTF)	█	████████████████████	CCRP_04	Testing performed with and without 690 SPS action
North Canaan – 69 kV (non - PTF)	█	████████████████████	CCRP_04	Testing performed with and without 690 SPS action

## **Section 16**

# **Appendix I: Critical Load Level Assessment Results**

[Appendix I1 -Critical Load Level for Thermal Violations.xlsx](#)

[Appendix I2 -Critical Load Level for Voltage Violations.xlsx](#)



# Section 17

## Appendix J: Net Load in Connecticut Calculation

**Table 17-1:  
Calculation of Net Load in Connecticut for Year of Need Calculation**

All Data below Excludes Transmission Losses <sup>20</sup>	2013	2014	2015	2016	2017	2018	2019	2020	2021	2022
<b>CELT Load in CT</b>	7,776	7,878	8,010	8,136	8,234	8,312	8,395	8,463	8,541	8,604
<b>CT Load Fed from MA</b>	25.8	26.1	26.6	27.0	27.3	27.6	27.9	28.1	28.3	28.5
<b>CELT load fed from substations in CT</b>	7,750	7,852	7,983	8,109	8,207	8,284	8,367	8,435	8,513	8,576
<b>CT Passive DR and EE</b>	414.2	421.2	410.3	413.6	433.4	459.8	485.2	508.7	531.1	551.6
<b>CT Active DR</b>	373.7	354.4	374.1	319.7	273.2	273.2	273.2	273.2	273.2	273.2
<b>Available CT Active DR</b>	280.3	265.8	280.6	239.7	204.9	204.9	204.9	204.9	204.9	204.9
<b>Total DR</b>	694.4	687.0	690.9	653.3	638.4	664.8	690.2	713.6	736.1	756.6
<b>Net Load in CT</b>	<b>7,055</b>	<b>7,165</b>	<b>7,292</b>	<b>7,456</b>	<b>7,568</b>	<b>7,620</b>	<b>7,677</b>	<b>7,721</b>	<b>7,777</b>	<b>7,819</b>

<sup>20</sup> Transmission losses are assumed to be 2.5% of the CELT load, which includes losses

## Section 18

# Appendix K: NERC Compliance Statement

This report is the first part of a two part process used by ISO-NE to assess and address compliance with NERC TPL standards. This Needs Assessment report provides documentation of an evaluation of the performance of the system as contemplated under the TPL standards to determine if the system meets compliance requirements. The Solutions Study report is a complimentary report that documents the study to determine which, if any, upgrades should be implemented along with the in-service dates of proposed upgrades that are needed to address the needs documented in the Needs Assessment report. The Needs Assessment report and the Solution Study report taken together provide the necessary evaluations and determinations required under the NERC TPL standards.

This study provides a detailed assessment of the Greater Hartford and Central Connecticut (GHCC) portion of New England's electric system performance for the 2013-2017 next five years and reviews system performance expected for years 2018-2022 six through ten. This study shows performance for NERC Category A conditions in Section 5.2.1.1 (Page 55), Section 5.2.2.1 (Page 68), Section 5.2.3.1 (Page 72) and Section 5.2.4.1 (Page 79) and performance was inadequate. The study shows NERC Category B condition performance in Section 5.2.1.2 (Page 55), Section 5.2.2.2 (Page 68), Section 5.2.3.2 (Page 72) and Section 5.2.4.2 (Page 80) and performance was inadequate. NERC Category C review can be found in Section 5.2.1.3 (Page 58), Section 5.2.2.3 (Page 68), Section 5.2.3.3 (Page 73) and Section 5.2.4.3 (Pages 84) and performance was inadequate. For NERC Category B and C review all relevant contingencies in the GHCC area were studied. A detailed description of the contingencies tested is included in Section 4.3.2 (Page 40). As shown in Section 6.4 (Pages 93 to 96), the marginal violation is expected to be seen pre-2013 at a net Connecticut load level of 3,444 MW. Limited testing of NERC Category D contingencies was conducted and the results of this testing can be found in Section 5.2.7 (Page 90). These will be taken into account as part of the consideration of alternatives in the study area.

As shown in Section 3.1.6 (Page 24) the study includes a peak load of 34,105 MW in New England and 8,825 MW in Connecticut, for the year 2022. This study uses normal operating procedures as illustrated by transfers, phase shifter settings and normal capacitor settings. Transfers are as shown in Section 3.1.9 (Page 27). Note that while firm transfers are not explicitly modeled or used in New England the system conditions used in this study are always sufficiently stressed to ensure transfer capability across interfaces are maintained. This study includes existing and planned Demand Resources, transmission and generation facilities as shown in Section 3.1.12 (Page 33). Demand Resources effects are included in load projections. The study includes reactive resources as shown in Section 3.1.11 (Page 33). Reactive resources will provide inadequate voltage support for the next ten years. Currently there are no planned outages of sufficient duration which would impact this. The effects of existing and planned protection systems can be found in Section 3.1.13 (Page 34). There are no existing or planned control devices (Dynamic Control Systems) in the study area. ISO New England Operations coordinates and approves planned generator and transmission outages looking out one year. Long term planning studies look at 90/10 load, stressed dispatch and line out conditions that historically provide ample margin to perform maintenance.

**Exhibit 2.D.2 ISO-NE “Greater Hartford and Central Connecticut (GHCC) Area Transmission 2022 Solutions Study,” February 2015, Redacted to secure Confidential Energy Infrastructure Information (CEII)**





# Greater Hartford and Central Connecticut (GHCC) Area Transmission 2022 Solutions Study

Greater Hartford and Central Connecticut Working Group  
(ISO New England, Northeast Utilities, and United Illuminating)



**REDACTED - PUBLIC VERSION**

© ISO New England Inc.  
February 2015

***Note: This page intentionally left blank.***

# Table of Contents

<b>Section 1 Executive Summary .....</b>	<b>1</b>
1.1 Needs Assessment Results and Problem Statement .....	1
1.2 Recommended Solution.....	3
1.3 NERC Compliance Statement .....	6
<b>Section 2 Needs Assessment Results Summary .....</b>	<b>7</b>
2.1 Introduction .....	7
2.2 Needs Assessment Review .....	8
2.2.1 Areas Studied .....	8
2.2.2 Statement of Needs .....	12
2.3 Critical Load Level / Year of Need Analysis .....	13
2.3.1 Summary of Results for Greater Hartford Subarea.....	13
2.3.2 Summary of Results for Manchester-Barbour Hill Subarea .....	13
2.3.3 Summary of Results for Middletown Subarea.....	13
2.3.4 Summary of Results for Northwestern CT Subarea.....	13
<b>Section 3 Solutions Study Assumptions .....</b>	<b>14</b>
3.1 Analysis Description .....	14
3.2 Steady State Model Assumptions .....	15
3.2.1 Study Assumptions .....	15
3.2.2 Source of Power Flow Models.....	15
3.2.3 Transmission Topology Changes.....	15
3.2.4 Generation Assumptions (Additions & Retirements) .....	17
3.2.5 Explanation of Future Changes Not Included.....	18
3.2.6 Forecasted Load .....	18
3.2.7 Load Levels Studied .....	21
3.2.8 Load Power Factor Assumptions .....	22
3.2.9 Transfer Levels .....	22
3.2.10 Generation Dispatch Scenarios .....	22
3.2.11 Reactive Resource and Dispatch Assumptions .....	27
3.2.12 Market Solutions Consideration.....	28
3.2.13 Demand Resource Assumptions .....	28
3.2.14 Description of Existing and Planned Protection and Control System Devices Included in the Study .....	28
3.3 Stability Modeling Assumptions .....	30
3.4 Short Circuit Model Assumptions .....	30
3.4.1 Study Assumptions .....	30
3.4.2 Short Circuit Model .....	30
3.4.3 Contributing Generation Assumptions (Additions & Retirements).....	31
3.4.4 Generation and Transmission System Configurations.....	31

3.4.5 Boundaries .....	32
3.4.6 Short Circuit Study Scenarios .....	32
3.4.7 Other Relevant Modeling Assumptions .....	32
3.5 Other System Studies .....	32
3.5.1 Thermal Transmission Transfer Capability Analysis .....	32
3.5.1.1 Western Connecticut Import Thermal Transfer Analysis .....	33
3.5.1.2 Connecticut Import Thermal Transfer Analysis .....	34
3.6 Changes in Study Assumptions .....	35
<b>Section 4 Analysis Methodology .....</b>	<b>36</b>
4.1 Planning Standards and Criteria .....	36
4.2 Performance Criteria .....	36
4.2.1 Steady State Criteria .....	36
4.2.2 Steady State Thermal and Voltage Limits .....	36
4.2.3 Steady State Solution Parameters .....	37
4.2.4 Stability Performance Criteria .....	37
4.2.5 Short Circuit Performance Criteria .....	37
4.3 System Testing .....	38
4.3.1 System Conditions Tested.....	38
4.3.2 Steady State Contingencies Tested .....	38
4.3.3 Use of Re-Dispatch.....	39
4.3.4 Stability Contingencies/Faults Tested.....	40
4.3.5 Short Circuit Faults Tested .....	40
<b>Section 5 Development of Alternative Solutions .....</b>	<b>41</b>
5.1 Preliminary Screen of Alternative Solutions .....	41
5.2 Coordination of Alternative Solutions with Other Entities .....	41
5.3 Description of Alternative Solutions .....	41
5.3.1 Manchester / Barbour Hill Subarea.....	42
5.3.1.1 Manchester / Barbour Hill Subarea Needs Assessment Results .....	42
5.3.1.2 Manchester / Barbour Hill Subarea Alternative Solutions .....	44
5.3.2 Northwestern Connecticut Subarea.....	47
5.3.2.1 Northwestern Connecticut Subarea Needs Assessment Results .....	47
5.3.2.2 Northwestern Connecticut Subarea Alternative Solutions .....	48
5.3.3 Middletown Subarea .....	51
5.3.3.1 Middletown Subarea Needs Assessment Results .....	51
5.3.3.2 Middletown Subarea Alternative Solutions.....	53
5.3.4 Greater Hartford Subarea .....	57
5.3.4.1 Greater Hartford Subarea Needs Assessment Results .....	57
5.3.4.2 Southington Area Common Solution.....	60
5.3.4.3 Rest of Greater Hartford Subarea .....	61
5.3.4.3.1 South Meadow and Berlin Area Needs.....	61
5.3.4.3.2 North Bloomfield – Manchester Area Needs .....	63
5.3.4.3.3 Rest of Greater Hartford Solutions .....	64



5.3.5 Western Connecticut Import Interface .....	69
<b>Section 6 Alternative Solution Performance Testing and Results .....</b>	<b>71</b>
6.1 Steady State Performance Results .....	71
6.1.1 N-0 Thermal and Voltage Performance Summary.....	71
6.1.2 N-1 Thermal and Voltage Performance Summary.....	71
6.1.3 N-1-1 Thermal and Voltage Performance Summary .....	72
6.1.4 Results of Extreme Contingency Testing.....	73
6.2 Stability Performance Results .....	73
6.3 Short Circuit Performance Results .....	73
6.3.1 Short Circuit Performance Results.....	73
6.4 Other Assessment Performance Results .....	75
6.4.1 Western Connecticut Import Thermal Transfer Comparative Analysis Results.....	75
<b>Section 7 Comparison of Alternative Solutions .....</b>	<b>76</b>
7.1 Factors Used to Compare Alternative Solutions .....	76
7.2 Cost Estimates for Selected Alternative Solutions .....	76
7.3 Comparison of Alternative Solutions .....	81
7.4 Comparison Matrix of Alternative Solutions .....	82
7.5 Recommended Solution Alternative.....	85
<b>Section 8 Conclusion .....</b>	<b>86</b>
8.1 Recommended Solution Description.....	86
8.1.1 Manchester / Barbour Hill Subarea.....	86
8.1.2 Northwestern Connecticut Subarea.....	86
8.1.3 Middletown Subarea .....	87
8.1.4 Greater Hartford Subarea .....	88
8.2 Solution Component Year of Need .....	89
8.3 Schedule for Implementation, Lead Times and Documentation of Continuing Need.....	89
<b>Section 9 Appendix A: Load Forecast .....</b>	<b>90</b>
<b>Section 10 Appendix B: Case Summaries and Load Flow Plots .....</b>	<b>93</b>
<b>Section 11 Appendix C: Element-Out Scenarios for N-1-1 Analysis .....</b>	<b>94</b>
<b>Section 12 Appendix D: Contingency Listings.....</b>	<b>98</b>
12.1 GHCC Area NERC Category B Contingencies .....	98
12.2 GHCC Area NERC Category C Contingencies .....	101
12.3 GHCC Area Special Protection System and Automatic Control Scheme Contingencies .....	105
12.4 GHCC Area NERC Category D Contingencies .....	106
<b>Section 13 Appendix E: Steady State Testing Results .....</b>	<b>107</b>
<b>Section 14 Appendix F: Short Circuit Testing Results .....</b>	<b>108</b>
<b>Section 15 Appendix G: Transfer Analysis Testing Results .....</b>	<b>109</b>

# List of Tables

Table 1-1: Manchester / Barbour Hill Alternative A Solution Components .....	3
Table 1-2: Northwestern Connecticut Alternative A Solution Components .....	3
Table 1-3: Middletown Area 2 <sup>nd</sup> Haddam Autotransformer Alternative Solution Components .....	4
Table 1-4: Greater Hartford Area Newington – Southwest Hartford Underground Line Alternative Solution Components.....	5
Table 2-1: Towns Included in Study Area.....	8
Table 3-1: 2022 Passive DR Values - DR through FCA #7 and EE Forecast.....	20
Table 3-2: FCA #7 - Active DR Values through FCA #7 .....	20
Table 3-3: Net New England Load Levels Studied.....	21
Table 3-4: Qualified Generating Capacities of Study Area Units .....	23
Table 3-5: Dispatch of Hydro Units in Connecticut.....	24
Table 3-6: Two-Unit-Out Generation Dispatches.....	26
Table 3-7: One-Unit-Out Generation Dispatches.....	27
Table 3-8: New England Demand Resource Performance Assumptions .....	28
Table 3-9: Western Connecticut Import Interface Summary .....	33
Table 3-10: Western Connecticut Sink Composition .....	33
Table 3-11: Rest of New England Source Composition.....	34
Table 3-12: Connecticut Import Interface Summary .....	34
Table 3-13: Connecticut Sink Composition .....	35
Table 3-14: SEMA/Boston Source Composition .....	35
Table 4-1: Steady-State Thermal Criteria.....	36
Table 4-2: Steady-State Voltage Criteria.....	37
Table 4-3: Study Solution Parameters .....	37
Table 4-4: Summary of NERC, NPCC and/or ISO-NE Contingencies Included in Study .....	39
Table 4-5: Summary of N-1-1 First Element-Out Scenarios.....	39
Table 5-1: Manchester / Barbour Hill Subarea Solution Alternatives.....	45
Table 5-2: Summary of CT Import Transfer Levels Following Implementation of Manchester – Barbour Hill Alternative Solutions .....	47
Table 5-3: Northwestern Connecticut Subarea Solution Alternatives.....	49
Table 5-4: Middletown Subarea Solution Alternatives .....	54
Table 5-5: Southington Area Common Solution Upgrades.....	61
Table 5-6: Rest of Greater Hartford Subarea Solution Alternatives.....	65
Table 6-1: GHCC and SWCT Preferred Solutions N-1 Thermal Violations Summary .....	71
Table 6-2: GHCC and SWCT Preferred Solutions N-1 Voltage Violations Summary.....	72
Table 6-3: GHCC and SWCT Preferred Solutions N-1 Thermal Violations Summary .....	72
Table 6-4: GHCC and SWCT Preferred Solutions N-1-1 Voltage Violations Summary .....	73

Table 6-5: GHCC and SWCT Preferred Solutions N-1-1 Non-Converged Scenarios .....	73
Table 6-6: Short Circuit Duties at Southington 115 kV Substation .....	74
Table 6-7: WCT Import N-1-1 Thermal Transfer Comparative Analysis Results .....	75
Table 7-1: Manchester / Barbour Hill Common Components Cost Estimates.....	76
Table 7-2: Manchester / Barbour Hill Alternative Solution Components Cost Estimates .....	77
Table 7-3: Northwestern Connecticut Common Components Cost Estimates.....	77
Table 7-4: Northwestern Connecticut Alternative Solution Components Cost Estimates .....	78
Table 7-5: Middletown Common Components Cost Estimates .....	78
Table 7-6: Middletown Alternative Solution Components Cost Estimates.....	79
Table 7-7: Southington Area Common Components Cost Estimates .....	80
Table 7-8: Rest of Greater Hartford Area Common Components Cost Estimates.....	80
Table 7-9: Rest of Greater Hartford Alternative Solution Components Cost Estimates .....	81
Table 7-10: Summary of GHCC Solution Alternatives Total Cost Estimates .....	81
Table 7-11: Comparison Matrix of Manchester / Barbour Hill Alternative Solutions .....	82
Table 7-12: Comparison Matrix of Northwestern Connecticut Alternative Solutions .....	83
Table 7-13: Comparison Matrix of Middletown Alternative Solutions .....	84
Table 7-14: Comparison Matrix of Greater Hartford Alternative Solutions .....	85
Table 8-1: Manchester / Barbour Hill Alternative A Solution Components .....	86
Table 8-2: Northwestern Connecticut Alternative A Solution Components .....	86
Table 8-3: Middletown Area 2nd Haddam Autotransformer Alternative Solution Components.....	87
Table 8-4: Greater Hartford Area Newington – Southwest Hartford Underground Line Alternative Solution Components.....	88
Table 8-5: Preferred Solution Total Cost Estimates .....	89
Table 9-1: 2013 CELT Seasonal Peak Load Forecast Distributions .....	90
Table 9-2: 2022 Detailed Load Distributions by State and Company .....	91
Table 9-3: Detailed Demand Response Distributions by Zone .....	92
Table 11-1: N-1-1 First Element-Out Scenarios.....	94

# List of Figures

Figure 2-1: GHCC Study Area Map.....	9
Figure 2-2: GHCC Study Area One Line Diagram.....	10
Figure 2-3: Interfaces of Interest for the GHCC Study Area.....	11
Figure 3-1: Southington Substation.....	29
Figure 3-2: The 69 kV System in Northwestern Connecticut .....	30
Figure 4-1: Circuit Breaker Testing Parameters.....	40
Figure 5-1: GHCC Study Area Map.....	42
Figure 5-2: Manchester / Barbour Hill Subarea Existing Geographic One-Line .....	44
Figure 5-3: Manchester / Barbour Hill Subarea Alternative A Upgrades .....	45
Figure 5-4: Manchester / Barbour Hill Subarea Alternative B Upgrades .....	46
Figure 5-5: Northwestern Connecticut Subarea Existing Geographic One-Line .....	48
Figure 5-6: Northwestern Connecticut Alternative A Upgrades .....	50
Figure 5-7: Northwestern Connecticut Alternative B Upgrades .....	51
Figure 5-8: Middletown Subarea Existing Geographic One-Line.....	52
Figure 5-9: Branford - Haddam Load Pocket.....	53
Figure 5-10: Middletown Subarea Haddam Autotransformer Alternative Upgrades .....	55
Figure 5-11: Middletown Subarea Scovill Rock Autotransformer Alternative Upgrades .....	56
Figure 5-12: Middletown Subarea Scovill Rock Autotransformer Alternative Upgrades (Cont'd.).....	57
Figure 5-13: Greater Hartford Subarea Existing Geographic One-Line .....	59
Figure 5-14: Southington Substation and SWCT Import Interface.....	60
Figure 5-15: Southington Area Common Solution Upgrades .....	61
Figure 5-16: South Meadow, Berlin and Southington Load Area.....	62
Figure 5-17: Farmington, Newington and East New Britain Load Pocket.....	63
Figure 5-18: North Bloomfield - Manchester Area.....	64
Figure 5-19: Rest of Greater Hartford Underground Line Alternative Upgrades .....	66
Figure 5-20: Rest of Greater Hartford Underground Line Alternative Upgrades (Cont'd.).....	67
Figure 5-21: Rest of Greater Hartford Overhead Line Alternative Upgrades .....	68
Figure 5-22: Rest of Greater Hartford Overhead Line Alternative Upgrades (Cont'd.) .....	69

# Section 1

## Executive Summary

### 1.1 Needs Assessment Results and Problem Statement

---

The objective of this analysis is to identify regulated transmission solutions that address the needs identified in the *Greater Hartford and Central Connecticut (GHCC) Area Transmission 2022 Needs Assessment*, dated May 2014<sup>1</sup>.

A long-term (ten-year) planning horizon was used for this study based on the most recently available Capacity, Energy, Loads, and Transmission (CELT) forecast data (2013) at the time that the Needs Assessment began. This study was focused on the projected 2022 peak demand load levels for the ten-year horizon. The models reflected the following peak load conditions:

**Loads:**

The summer peak 90/10 load level forecast is 34,105 MW for all of New England and 8,825 MW (which represents 26% of the New England load) for the state of Connecticut.

**Transmission Topology:**

All relevant transmission projects with Proposed Plan Application (PPA) approval, with the exception of the NEEWS - Central Connecticut Reliability Project (CCRP), have been included in the study base case. Section 3.2.3 includes a full listing and description of all projects included.

**Generation:**

All generation projects with a Capacity Supply Obligation as of Forward Capacity Auction 7 (FCA #7) were included in the study base case. Section 3.2.4 of this report includes a full listing and description of generation included in the base case. Due to the submission of Non-Price Retirement (NPR) Requests for the Bridgeport Harbor 2 and the Norwalk Harbor units for FCA #8, these units have been taken out-of-service (OOS) in the base case.

**Demand Resource Assumptions:**

Demand Resources (active and passive) were modeled based on the Demand Resources (DR) cleared in FCA #7. In addition, any accepted NPR requests for DR and any DR terminations in Connecticut for FCA #8 were also taken into account. Finally, the energy efficiency forecast for the years corresponding to FCA #8 and beyond until 2022 were also modeled based on the 2013 energy efficiency (EE) forecast. Section 3.2.6 includes the details of the demand resources considered for this study.

All the criteria violations observed in the Greater Hartford and Central Connecticut (GHCC) area were based on steady state thermal and voltage testing. The following summarizes the needs for each subarea:

---

<sup>1</sup> [http://www.iso-ne.com/committees/comm\\_wkgrps/prtcpnts\\_comm/pac/ceii/reports/2014/ghcc\\_needs\\_assessment\\_report\\_rev2.zip](http://www.iso-ne.com/committees/comm_wkgrps/prtcpnts_comm/pac/ceii/reports/2014/ghcc_needs_assessment_report_rev2.zip)

**Greater Hartford Subarea**

- Need to resolve N-1 and N-1-1 criteria violations observed in the Greater Hartford area
- Thermal and voltage violations observed in the following areas:
  - North Bloomfield to Manchester area
  - South Meadow – Berlin – Southington area
  - Southington area
- 

**Middletown Subarea:**

- Need to resolve the N-1 and N-1-1 criteria violations observed in the Middletown area
- [REDACTED]

**Manchester – Barbour Hill Subarea**

- Need to resolve the N-1-1 criteria violations observed in serving load in the Manchester-Barbour Hill area
- [REDACTED]

**Northwestern Connecticut Subarea:**

- Need to resolve N-1 and N-1-1 criteria violations observed in serving load in the Northwest Connecticut area
- [REDACTED]

**Western Connecticut Import Interface:**

- Need to resolve N-1-1 criteria violations [REDACTED]

Section 3 of this report contains more details of all assumptions used to complete this study.

The following types of analyses were performed as part of this study:

- **Steady-State Thermal and Voltage Analysis** – steady-state analysis was performed to determine if the proposed alternatives resolve the thermal and voltage needs identified during the GHCC Needs Assessment. A variety of one and two-unit-out generation dispatches and inter-regional stresses were evaluated for N-0 (All-facilities-in) conditions as well as following contingency events for N-1 (all-facilities-in, first contingency) and N-1-1 (facility-out, first contingency) conditions to evaluate the solution alternatives.
- **Short Circuit Analysis** – a study to ensure that the substation equipment in the study area has the ability to withstand and interrupt fault current with the preferred solution for the GHCC Study area.
- **Transfer Analysis** – analysis was performed to analyze the effect that various proposed solution alternatives may have on the transfer capabilities of the Western Connecticut Import interface.

The results of the Needs Assessment are summarized in Sections 2.2.2 and 2.3 of this report. These results indicate that there are violations of planning criteria under the assumptions and system conditions modeled, with many of the violations seen at 2013 load levels or earlier.

## 1.2 Recommended Solution

Alternative A for the Manchester / Barbour Hill subarea is comprised of several components as described in Table 1-1. A more detailed description of each component can be found in Section 5.3.1.

**Table 1-1: Manchester / Barbour Hill Alternative A Solution Components**

Component ID	Description
1	Add a new 345/115 kV autotransformer at Barbour Hill and associated terminal equipment
3	Reconductor the 115 kV line between Manchester and Barbour Hill (1763) – 7.6 miles
4	Add a 345 kV breaker in series with breaker 24T at the Manchester 345 kV switchyard

Alternative A for the Northwestern Connecticut subarea is comprised of several components as described in Table 1-2. A more detailed description of each component can be found in Section 5.3.2.

**Table 1-2: Northwestern Connecticut Alternative A Solution Components**

Component ID	Description
1	Add a new 10.35 mile, 115 kV line from Frost Bridge to Campville and associated terminal equipment
3	Separation of 115 kV DCT corresponding to the Frost Bridge to Campville (1191) line and the Thomaston to Campville (1921) line and add a breaker at Campville 115 kV substation
4	Upgrade terminal equipment on the 115 kV line between Chippen Hill and Lake Avenue Junction (1810-3)
5	Reconductor the 115 kV line between Southington and Lake Avenue Junction (1810-1) – 5.2 miles

The Haddam Autotransformer alternative for the Middletown subarea is comprised of several components as described in Table 1-3. A more detailed description of each component can be found in Section 5.3.3.

**Table 1-3: Middletown Area 2<sup>nd</sup> Haddam Autotransformer Alternative Solution Components**

Component ID	Description
1	Add a 2nd 345/115 kV autotransformer at Haddam substation and reconfigure the 3-terminal 345 kV 348 line into 2 two-terminal lines
3	Terminal equipment upgrades on the 345 kV line between Haddam and Beseck (362)
4	Separation of 115 kV double circuit towers corresponding to the Branford – Branford RR line (1537) and the Branford to North Haven (1655) line and adding a series breaker at Branford 115 kV substation
5	Terminal equipment upgrades on the Middletown to Dooley Line (1050)
6	Terminal equipment upgrades on the Middletown to Portland Line (1443)
7	Redesign the Green Hill 115 kV substation from a straight bus to a ring bus and add a 37.8 MVAR capacitor bank
8	Add a 37.8 MVAR capacitor bank at Hopewell 115 kV substation
12	Separation of 115 kV double circuit towers corresponding to the Middletown – Pratt and Whitney line (1572) and the Middletown to Haddam (1620) line



The Newington – Southwest Hartford 115 kV underground line alternative is comprised of several components as described in Table 1-4. A more detailed description of each component can be found in Section 5.3.4.

**Table 1-4: Greater Hartford Area Newington – Southwest Hartford Underground Line Alternative Solution Components**

<b>Component ID</b>	<b>Description</b>
<b>1</b>	Add a new 4 mile 115 kV underground cable from Newington to Southwest Hartford and associated terminal equipment including a 2% series reactor
<b>3</b>	Loop the 1779 line between South Meadow and Bloomfield into the Rood Avenue substation and reconfigure the Rood Avenue substation
<b>4</b>	Reconfigure the Berlin 115 kV substation including the addition of two 115 kV breakers and the relocation of a capacitor bank
<b>5</b>	Add a 115 kV 25.2 MVAR capacitor at Westside 115 kV substation
<b>6</b>	Reconductor the 115 kV line between Newington and Newington Tap (1783) – 0.01 miles
<b>7</b>	Separation of 115 kV DCT corresponding to the Bloomfield to South Meadow (1779) line and the Bloomfield to North Bloomfield (1777) line and add a breaker at Bloomfield 115 kV substation
<b>8</b>	Install a 115 kV 3% reactor on the underground cable between South Meadow and Southwest Hartford(1704)
<b>9</b>	Separation of 115 kV DCT corresponding to the Bloomfield to North Bloomfield (1777) line and the North Bloomfield – Rood Avenue – Northwest Hartford (1751) line and add a breaker at North Bloomfield 115 kV substation
<b>S1</b>	Replace the existing 3% series reactors on the 115 kV lines between Southington and Todd (1910) and between Southington and Canal (1950) with 5% series reactors
<b>S2</b>	Replace the normally open 19T breaker at Southington with a 3% series reactor between Southington Ring 1 and Southington Ring 2 and associated substation upgrades
<b>S3</b>	Add a breaker in series with breaker 5T at the Southington 345 kV switchyard
<b>S4</b>	Add a new control house at Southington 115 kV substation

### **1.3 NERC Compliance Statement**

---

In accordance with NERC TPL Standards, this assessment provides:

- A written summary of plans to address the system performance issues described in the *Greater Hartford and Central Connecticut (GHCC) Area Transmission 2022 Needs Assessment*, dated May 2014
- A schedule for implementation, as shown in Section 8.3
- A discussion of expected required in-service dates of facilities and associated load level when required, as shown in Section 8.3
- A discussion of lead times necessary to implement plans in Section 8.3

# Section 2

## Needs Assessment Results Summary

### 2.1 Introduction

---

The objective of the GHCC Needs Assessment was to evaluate the system needs in the Greater Hartford and Central Connecticut (GHCC) study area and to reassess the needs which drove the Central Connecticut Reliability Project (CCRP), while considering the following:

- Future load growth
- Reliability over a range of generation patterns and transfer levels
- All NERC, NPCC and ISO New England applicable transmission planning reliability standards
- Regional and local reliability issues
- New England East-West Solution (NEEWS) project, and
- Existing and planned supply resources and demand resources

The scope of the Needs Assessment study performed for the GHCC area included evaluation of the reliability performance of the transmission system serving this area of New England for the year 2022 projected system conditions. The system was tested with all elements in-service i.e. N-0 (all-facilities-in) and under N-1 (all-facilities-in, first contingency) and N-1-1 (facility-out, first contingency) contingency conditions for a number of possible operating conditions with respect to related interface transfer levels and generating unit availability conditions.

This Needs Assessment was the first step in the study process defined in accordance with the Regional Planning Process as outlined in Attachment K to the ISO-NE Open Access Transmission Tariff (OATT).

A working group led by ISO-NE, and consisting of members from ISO-NE, Northeast Utilities (NU), and United Illuminating (UI), was formed to study the Greater Hartford and Central Connecticut transmission system. As part of the Planning Advisory Committee (PAC) process, stakeholders, which include generator owners, suppliers, load serving entities, energy efficiency entities, state regulators, and transmission owners, also provided input throughout the study process.

The results of the Needs Assessment were presented in a Needs Assessment report<sup>2</sup> “*Final GHCC Needs Assessment Report*,” dated May 2014.

---

<sup>2</sup> <http://www.iso-ne.com/system-planning/key-study-areas/greater-hartford>

## 2.2 Needs Assessment Review

### 2.2.1 Areas Studied

In this study, the GHCC area has been divided into the following four subareas:

1. Greater Hartford
2. Northwest Connecticut
3. Middletown, and
4. Manchester - Barbour Hill

Table 2-1 summarizes the towns included in each of the subareas:

**Table 2-1: Towns Included in Study Area**

Subarea	Towns in the Subarea <i>(Note: Location of towns may not dictate where load is served)</i>
<b>Greater Hartford</b>	Avon, Berlin, Bloomfield, Burlington, Cromwell, East Granby, East Hartford, Farmington, Granby, Hartford, New Britain, Newington, Plainville, Rocky Hill, West Hartford, Wethersfield, Windsor
<b>Northwest Connecticut</b>	Barkhamsted, Bethlehem, Bristol, Canaan, Canton, Colebrook, Cornwall, Goshen, Hartland, Harwinton, Kent, Litchfield, Morris, New Hartford, Norfolk, North Canaan, Plymouth, Salisbury, Sharon, Simsbury, Thomaston, Torrington, Warren, Washington, Winchester
<b>Middletown</b>	Chester, Clinton, Colchester, Deep River, Durham, East Haddam, East Hampton, Essex, Guilford, Haddam, Hebron, Killingworth, Lyme, Madison, Marlborough, Meriden, Middlefield, Middletown, Old Lyme, Old Saybrook, Portland, Wallingford, Westbrook
<b>Manchester - Barbour Hill</b>	Bolton, East Windsor, Ellington, Enfield, Glastonbury, Manchester, Somers, South Windsor, Suffield, Tolland, Vernon, Windsor Locks

Figure 2-1 shows the geographic map of the study area and Figure 2-2 shows the one-line diagram for the study area. Each of the figures has the four study subareas delineated.

It should be noted that the Scitico substation, while geographically located within the state of CT and in the Manchester/Barbour Hill area, is fed by 115 kV lines from the Springfield area. Since the Scitico substation is not fed from the Manchester/Barbour Hill area transmission facilities, the study of the transmission system around the Scitico substation is excluded from the study area.

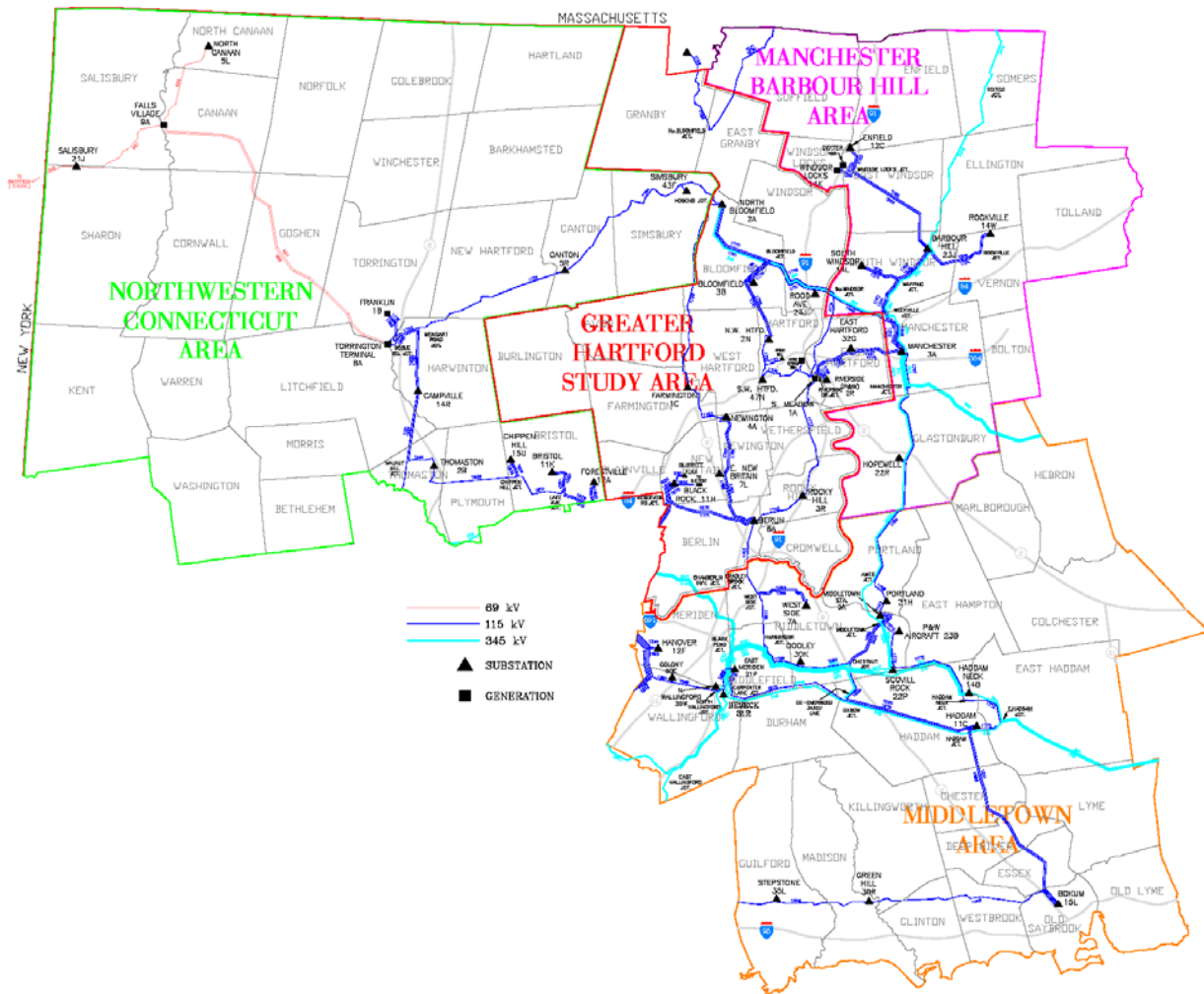
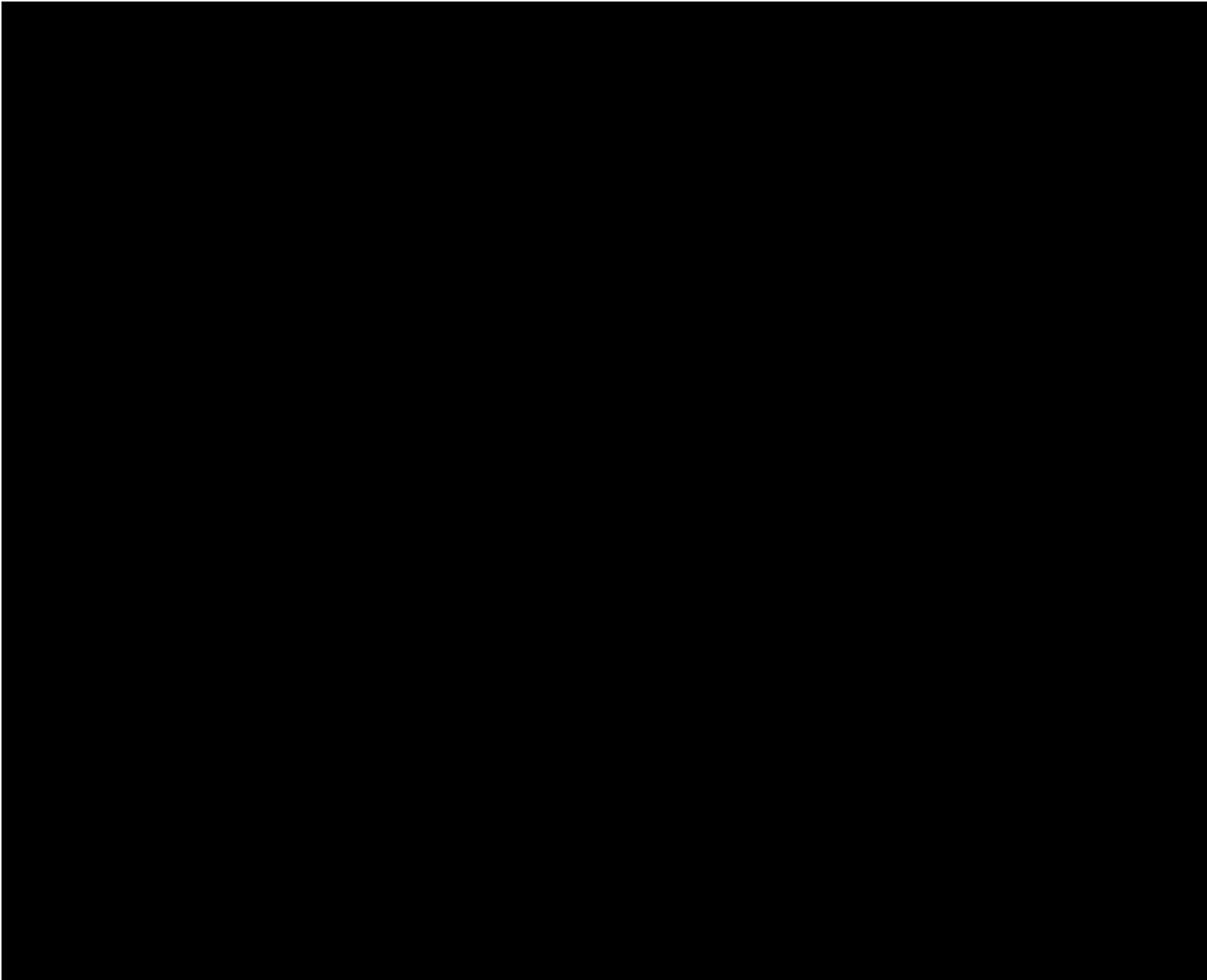


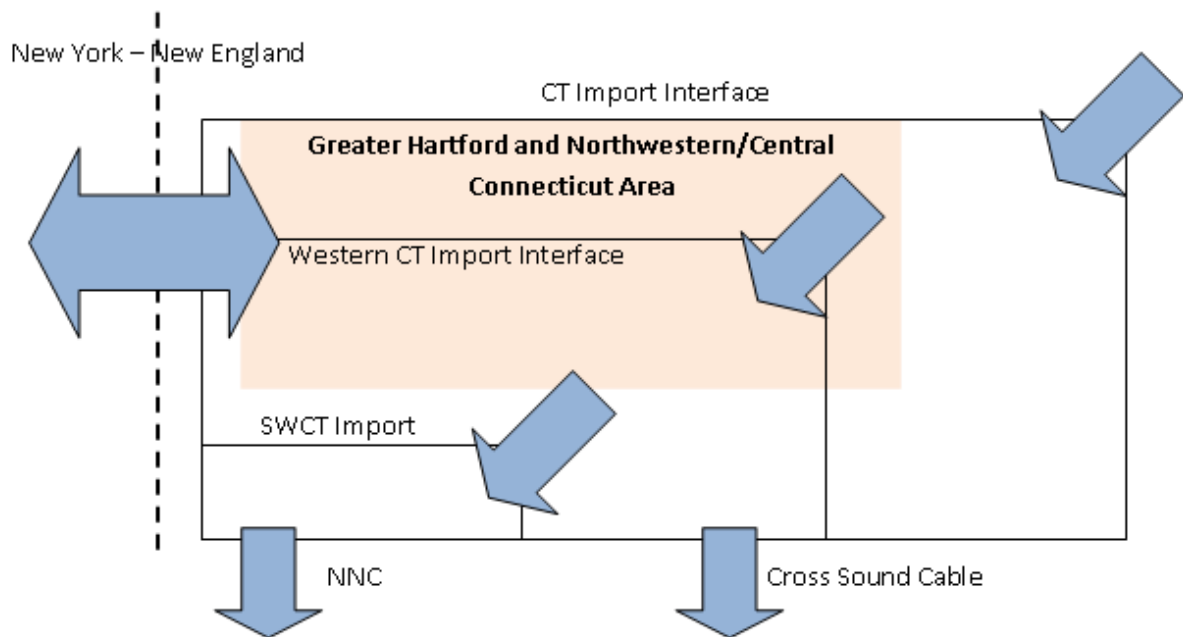
Figure 2-1: GHCC Study Area Map<sup>3</sup>

<sup>3</sup> The diagram is for illustrative purposes to show the study area. In the Manchester – Barbour Hill area, the Scitico substation is supplied from western Massachusetts but serves load in Connecticut. The Scitico station and the load fed from it has been excluded from the study



**Figure 2-2: GHCC Study Area One Line Diagram**

The GHCC study area is located between the Connecticut Import interface and the Southwest Connecticut (SWCT) Import interface, while only parts of the study area are within the Western Connecticut Import area. In addition to the above interfaces the export/import levels to/from New York through the AC ties, the Cross Sound Cable (CSC), and the Norwalk Northport Cable (NNC) also affect the study area. Figure 2-3 shows the interfaces impacting the study area.



**Figure 2-3: Interfaces of Interest for the GHCC Study Area**

The New England East-West Solution (NEEWS) project received its Proposed Plan Application (PPA) approval in 2008 and was revised and re-approved in 2012. Since the first approval, a significant amount of new resources have been procured in Connecticut via the Forward Capacity Market (FCM). With the addition of these new resources an updated transmission-based needs analysis for the NEEWS transmission project was required. Three of the four components of NEEWS, Greater Springfield Reliability Project (GSRP), the Rhode Island Reliability Project (RIRP), and the Interstate Reliability Project (IRP) have had their needs re-affirmed. In 2010, it was determined that an updated Needs Assessment of the fourth major component of NEEWS – the Central Connecticut Reliability Project would be conducted as part of the GHCC study. CCRP, as originally designed, would add a new 345 kV line to the Western Connecticut Import interface, which lies entirely within the GHCC study area.

Some of the highest criteria violations that were seen on 115 kV lines in the Greater Hartford area in preliminary analyses were also observed in the Western Connecticut Import analysis as part of the preliminary CCRP reassessment. Accordingly, the GHCC analysis was expanded to identify needs for both local reliability issues and Western Connecticut Import requirements, with the expectation that both sets of needs could be addressed by a single integrated solution. This determination was based on the fact that recent changes in assumptions that included new generation and demand resources were expected to significantly reduce the need for increased Western Connecticut Import. This assessment considers both local load serving needs and the need for additional Western Connecticut Import capacity. However, the needs results are presented by geographic location of the element with a thermal or voltage violation and are not separated based on local load serving needs and the need for additional Western Connecticut Import capability.

### 2.2.2 Statement of Needs

All the criteria violations observed in the Greater Hartford and Central Connecticut (GHCC) area were based on steady state thermal and voltage testing. The following summarizes the needs for each subarea:

#### Greater Hartford Subarea

- Need to resolve N-1 and N-1-1 criteria violations observed in the Greater Hartford area
- Thermal and voltage violations observed in the following areas:
  - North Bloomfield to Manchester area
  - South Meadow – Berlin – Southington area
  - Southington area
- 

#### Middletown Subarea:

- Need to resolve the N-1 and N-1-1 criteria violations observed in the Middletown area
- [REDACTED]

#### Manchester – Barbour Hill Subarea

- Need to resolve the N-1-1 criteria violations observed in serving load in the Manchester/Barbour Hill area
- [REDACTED]

#### Northwestern Connecticut Subarea:

- Need to resolve N-1 and N-1-1 criteria violations observed in serving load in the Northwest Connecticut area
- [REDACTED]

#### Western Connecticut Interface:

- Need to resolve N-1-1 criteria violations observed [REDACTED]



- The needs are interrelated with the needs in the four subareas listed above.

## **2.3 Critical Load Level / Year of Need Analysis**

---

The following sections summarize the critical load levels for each subarea at which all thermal and voltage violations are expected to be resolved. The critical load levels are provided in terms of Connecticut load including demand resources and energy efficiency and excluding transmission losses.

### **2.3.1 Summary of Results for Greater Hartford Subarea**

The majority of the worst-case violations in the Greater Hartford subarea are expected to be seen at expected summer peak load levels before 2013. The net Connecticut load minus DR at which all thermal violations will be resolved is 4,756 MW and the net Connecticut load at which all voltage violations would be resolved is 4,319 MW.

### **2.3.2 Summary of Results for Manchester-Barbour Hill Subarea**

The majority of the worst-case violations in the Manchester-Barbour Hill subarea are expected to be seen at expected summer peak load levels before 2013. The net Connecticut load minus DR at which all thermal violations will be resolved is 5,616 MW and the net Connecticut load at which all the PTF voltage violations would be resolved is 5,069 MW.

### **2.3.3 Summary of Results for Middletown Subarea**

The majority of the worst-case violations in the Middletown subarea are expected to be seen at expected summer peak load levels before 2013. The net Connecticut load minus DR at which all thermal violations will be resolved is 3,444 MW and the net Connecticut load at which all voltage violations would be resolved is 3,694 MW.

### **2.3.4 Summary of Results for Northwestern CT Subarea**

The majority of the worst-case violations in the Northwestern Connecticut subarea are expected to be seen at expected summer peak load levels before 2013. The net Connecticut load minus DR at which all thermal violations will be resolved is 4,225 MW and the net Connecticut load at which all voltage violations would be resolved is 5,694 MW.

## Section 3

# Solutions Study Assumptions

### 3.1 Analysis Description

---

Since the needs identified in the GHCC Needs Assessment were based on steady state analysis, the development of the solutions was also based on steady state analysis. The objective of the analysis is to resolve the thermal and voltage criteria violations observed in the GHCC study area. The study area was divided into four subareas and the solutions were developed for these subareas. The needs for Western Connecticut Import were seen across multiple subareas but a solution for these needs would be focused in the Hartford and Middletown subareas. Hence, the solution for these needs was combined with the Greater Hartford and Middletown subareas. More details on solution alternative development are provided in Section 5.

The following criteria violations in the GHCC area were not resolved by the Solutions Study:

For each subarea, multiple alternatives were pursued and each alternative would resolve all criteria violations. To compare the steady state performance of the alternatives the number of residual high loadings and the amount of re-dispatch required between first and second contingencies was compared. In addition for the Greater Hartford and Middletown area the impact on western Connecticut transfer capability was also conducted since the solution for Western Connecticut Import based needs was developed in conjunction with local needs in these subareas.

Additionally, for the preferred alternative based on cost and steady state performance a short circuit analysis was conducted to ensure that no breakers were over-dutied as a result of the preferred solution.

To complete the analysis, the following software applications were used:

- Steady State Analysis - PSS/E version 32.2.1 and PowerGEM TARA version 7.65e
- Short Circuit Analysis - Aspen version 12.4
- Transfer Analysis – PowerGEM TARA version 7.65e

## **3.2 Steady State Model Assumptions**

---

### **3.2.1 Study Assumptions**

The regional steady-state model was developed to be representative of the 10-year projection of the 90/10 summer peak system demand levels to assess reliability performance under stressed system conditions. The assumptions included consideration of area generation unit unavailability conditions as well as variations in surrounding area regional interface transfer levels. These study assumptions are consistent with ISO-NE Planning Procedure No. 3 (PP 3), “Reliability Standards for the New England Area Bulk Power Supply System”.

### **3.2.2 Source of Power Flow Models**

The power flow study cases used in this study were obtained from the ISO-NE Model on Demand system with selected upgrades to reflect the system conditions in 2022. A detailed description of the system upgrades included is provided in later sections of this report.

### **3.2.3 Transmission Topology Changes**

Transmission projects with Proposed Plan Application (PPA) approval in accordance with Section I.3.9 of the Tariff, as of the April 2011 RSP Project Listing, have been included in the study base case. New projects in Connecticut that were relevant to the study area were added to the base cases as of the October 2013 project listing. Projects outside of Connecticut that were added to the project listing were deemed to not have a significant impact on the study area and were excluded. The only exception to this was the inclusion of updates to the NEEWS projects that occurred in May 2012. A listing of the major projects is included below.

#### **Maine**

- Maine Power Reliability Program (MPRP) (RSP ID: 905-909, 1025-1030, 1158)
- Down East Reliability Improvement (RSP ID: 143)

#### **New Hampshire**

- Second Deerfield 345/115 kV Autotransformer Project (RSP ID: 277, 1137-1141)

#### **Vermont**

- Northwest Vermont Reliability Projects (RSP ID: 139)
- Vermont Southern Loop Project (RSP ID: 323, 1032-1035)

#### **Massachusetts**

- Auburn Area Transmission System Upgrades (RSP ID: 59, 887, 921, 919)
- Merrimack Valley / North Shore Reliability Project (RSP ID: 775-776, 782-783, 840)
- Long Term Lower SEMA Upgrades (RSP ID: 592, 1068, 1118)
- Central/Western Massachusetts Upgrades (RSP ID: 924- 929, 931-932, 934-935, 937- 950, 952- 955)
- NEEWS – Greater Springfield Reliability Project (RSP ID: 196, 259, 687-688, 818-820, 823, 826, 828-829, 1010, 1070-1075, 1078-1080, 1100-1105)
- NEEWS – Interstate Reliability Project (RSP ID: 1094,1202)

#### **Rhode Island**

- Greater Rhode Island Transmission Reinforcements (RSP ID: 484, 786, 788, 790-793, 913-918, 1098)
- NEEWS – Rhode Island Reliability Project (RSP ID: 795, 798-800, 1096-1097, 1099, 1106, 1109)
- NEEWS – Interstate Reliability Project (RSP ID: 190, 794, 1095, 1233-1234)

## **Connecticut**

- NEEWS – Greater Springfield Reliability Project (RSP ID: 816, 1054, 1092)
- NEEWS – Interstate Reliability Project (RSP ID: 191, 802, 810, 1085, 1090-1091, 1235)
- Northeast Simsbury Substation 115 kV Circuit Breaker Project (RSP ID: 1230)
- Advanced NEEWS Projects – (RSP ID:1370,1235,1245)
- SWCT Minimum Load Project – Haddam Neck 150 MVAR Shunt Reactor (RSP ID:1400)

For the GSRP, RIRP and IRP components of NEEWS the model reflects the revised PPA that received ISO-NE approval in May 2012. An upgrade that would impact the GHCC study area is the reconductoring of the 1784 line between North Bloomfield and Northeast Simsbury and the replacement of the 2% reactor on this line at North Bloomfield with a reactor of equal impedance but higher thermal rating.

Several upgrades in the SWCT area have received PPA approval since these base cases were created, but since the Southwest Connecticut working group was reassessing the needs and solutions for that area those upgrades were not included. The only upgrade from the SWCT area that is approved and not under reassessment that was included was the Haddam Neck shunt reactor.

The Central Connecticut Reliability Project (CCRP) component of the NEEWS projects was also excluded since as a part of the GHCC Needs Assessment the needs for these upgrades were reassessed.

In addition to the new transmission projects in Connecticut that were added during the Needs Assessment, any changes to element ratings or impedances as a part of the base case update process were captured on an ongoing basis. These upgrades may have varied some of the line ratings or impedances to reflect the most accurate future system condition. A significant change in this area was the replacement of the Torrington 115/69 kV autotransformer in December 2013.

Eight transmission substation buses in the GHCC study area are arranged as ring buses. Under contingency conditions, a large amount of power could flow through the bus and the traditional model of buses in the base cases would not capture these flows. The updated analysis completed in this Needs Assessment report accurately captured the modeling of these ring buses and reports violations on any of the bus elements that were seen under contingency conditions.

In addition to the topology changes listed above any changes or corrections to the ratings and impedances of the facilities since the Needs Assessment was finalized has been included in the Solutions Study base cases.

Finally, as upgrades were added as a part of the Solutions Study the associated topology changes and contingency changes were made to the models.

### **3.2.4 Generation Assumptions (Additions & Retirements)**

Generation projects with a FCM Capacity Supply Obligation as of Forward Capacity Auction 7 (FCA #7) were included in the study base case. A listing of the recent major new projects cleared in FCA #1 through FCA #7 is included below.

#### **Maine**

- QP 244 – Wind Project (FCA #4)

#### **New Hampshire**

- QP 251 – Biomass Project (FCA #4)
- QP 307 – Biomass Project (FCA #4)

#### **Massachusetts**

- QP 089 – Cape Wind Turbine Generators (FCA #7)
- QP 196 – Northfield Mountain Up-rate 88 MW (FCA #4, #6 and #7)
- QP 387-2 – Combined Cycle Unit (FCA #7)

#### **Rhode Island**

- QP 332 – RISEP Increase (FCA #5)

#### **Connecticut**

- QP 155.6 – Fuel Cell Project in Fairfield, CT (FCA #4)
- QP 289 – Fuel Cell Project in New Haven County, CT (FCA #4)

In March 2012, the Ansonia generation unit (QP-193) withdrew its PPA. As a result the Ansonia generation has been removed from the case. The generator had previously cleared in FCA #2.

On September 18, 2012, a Non-Price Retirement Request was submitted for AES Thames; following a reliability review by ISO-NE, the Non-Price Retirement Request was accepted on November 13, 2012. For this study, the AES Thames unit was assumed OOS as a base case condition.

On September 16, 2013 a full Non-Price Retirement (NPR) Request for Bridgeport Harbor 2 was submitted for FCA #8. Following a reliability review by ISO-NE, the NPR request was accepted on October 16, 2013. As a result, for this study, the Bridgeport Harbor 2 unit was assumed OOS as a base case condition.

On September 30, 2013 a Non-Price Retirement request for Norwalk Station (Norwalk 1, 2 and 10) was submitted for the FCA #8 commitment period. The NPR request was accepted on December 20, 2013. As a result, the Norwalk Station was assumed out-of-service as a base condition.

No new generation cleared in Connecticut in FCA#8 and hence no new generators were added to the base case based on FCA #8.

Real Time Emergency Generation (RTEG) represents distributed generation facilities which have air permit restrictions that limit their operations to OP 4, Action 6 – an emergency action which also implements voltage reductions of five percent (5%) of normal operating voltage that require more than 10 minutes to implement. The impact of RTEG was not included in this analysis because in general, long-term analyses should not be performed such that the system must be in an emergency state as required for the implementation of OP 4, Action 6.

### 3.2.5 Explanation of Future Changes Not Included

The following projects were not added:

- Transmission projects that have not been fully developed and have not received PPA approval as of the April 2011 RSP Project Listing. These projects were not modeled in the study base case due to the uncertainty concerning their final development or lack of an impact on the GHCC study area.
- Transmission Projects that have been added to the project listing since the April 2011 project listing update, but do not have a significant impact on the study area

Additionally, the NEEWS – Central Connecticut Reliability Project component has PPA approval but was not included in the base case because the scope of this study includes the re-assessment of the transmission reliability needs for this component.

The following projects in SWCT were not included for the base cases used for the thermal and voltage testing:

- Stamford Reliability Cable Project (115 kV cable between Glenbrook and South End substations)
- SONO Substation Addition (CMEEC)
- Fitch Substation Addition (CMEEC)
- 115 kV Circuit Breaker (40 kA) Addison at Newtown Substation

The first three projects are located in the Norwalk Stamford area and were added to resolve local load serving issues. The exclusion of these projects would not affect the thermal and voltage results because:

- The net load in Norwalk Stamford does not change and hence the power flowing through the GHCC Study area does not change
- The change in impedance based on the new Glenbrook to South End cable would not affect the flows through the GHCC study area
- Any contingency changes would not affect the results since the contingencies in Norwalk Stamford are not modeled in the GHCC study since they would not have a significant impact on flows in the GHCC study area

The Newtown breaker addition is also not modeled since contingencies around Newtown are not modeled in the GHCC study and hence any changes based on the breaker addition would not have shown any change in the GHCC study results.

However, once the GHCC preferred solution was selected this solution was tested with the SWCT preferred solutions to ensure that the combined solution still resolved all the needs. This test was performed by both study groups (GHCC and SWCT) and no modifications were required to the preferred solutions developed by each study independently.

### 3.2.6 Forecasted Load

A ten-year planning horizon was initially used for this study based on the 2012 CELT report when the Needs Assessment for the study area. During the course of the Needs Assessment and in the Solutions Study, the forecasted load was updated in the base case to reflect the 2013 CELT report,

which was released in May 2013, but the study year remained as 2022. This study focused on the projected 2022 peak demand load levels for the ten-year horizon.

The 2022 summer peak 90/10 demand forecast for New England is 34,105 MW.

The CELT load forecast includes both system demand and losses (transmission and distribution) from the power system. The power flow modeling programs have the transmission system explicitly modeled and hence the losses on the transmission system are calculated by the software. Therefore, the actual system load modeled in the case was reduced to account for transmission system losses which are explicitly calculated in the system model. Load distributions in the case are based on the most recent 2013 MMWG case library data.

Demand Resources (DR) are treated as capacity resources in the Forward Capacity Auctions (FCA). DR is split into two major categories, Passive and Active DR. Passive DR is largely comprised of energy efficiency and is expected to lower the system demand during designated peak hours in the summer and winter. Active DR is commonly known as Demand Side Management (DSM) and can be dispatched on a zonal basis if a forecasted or real-time capacity shortage occurs on the system. Starting in 2012, forecasting passive DR has become part of the annual load forecasting process. This forecast takes into account additional electrical efficiency (EE) savings beyond FCM results across the ten-year planning horizon. This forecast is primarily based on forecasted financial investment in state-sponsored EE programs and its correlation with historical data on reduction in peak demand per dollar spent. This EE forecast was published in the annual CELT Report beginning in spring 2012. Active DR is modeled in the base case at the levels of the most recent Forward Capacity Auction (FCA #7), multiplied by a Performance Factor of 75% based on historical performance of similar resources. Passive DR is modeled at 2022 levels based on the passive DR cleared through FCA #7 (2010-2016) and the aforementioned EE forecast for the years until 2022 (2017-2022). In addition, Active and Passive DR levels in Connecticut<sup>4</sup> were scaled down to account for the submission of several Non-Price Retirement Requests for FCA #8 and DR terminations post-FCA #7. Starting in 2010, DR values are now published in the CELT Report. Because DR is modeled at the low-side of the distribution bus in the power-flow model, all DR values were increased by 5.5% to account for the reduction in losses on the local distribution network. Passive DR is modeled by load zone and Active DR is modeled by dispatch zone. The amounts modeled in the cases are listed in Table 3-1 and Table 3-2 and detailed reports can be seen in Appendix A: Load Forecast.

---

<sup>4</sup> Since this study is only looking at developing solutions for local issues in and around the Greater Hartford area, it was determined that NPR requests submitted for DR outside of Connecticut had a negligible effect on the results of the analyses and were not taken into account in this study.

**Table 3-1: 2022 Passive DR Values - DR through FCA #7 and EE Forecast**

Load Zone	Passive DR (FCA-1-7) DRV <sup>5</sup> (MW)	Passive DR Terminations DRV (MW)	Passive DR NPR DRV (MW)	EE Forecast (2017-2022) DRV (MW)	Total Passive DR DRV (MW)
<b>Maine</b>	150	Not Included	Not Included	56	206
<b>New Hampshire</b>	77	Not Included	Not Included	53	130
<b>Vermont</b>	120	Not Included	Not Included	89	209
<b>Northeast Massachusetts &amp; Boston</b>	331	Not Included	Not Included	276	607
<b>Southeast Massachusetts</b>	185	Not Included	Not Included	147	332
<b>West Central Massachusetts</b>	235	Not Included	Not Included	165	400
<b>Rhode Island</b>	137	Not Included	Not Included	114	251
<b>Connecticut</b>	385	-25	-8	139	523
<b>New England Total</b>	<b>1,620</b>	<b>-25</b>	<b>-8</b>	<b>1,039</b>	<b>2,658</b>

**Table 3-2: FCA #7 - Active DR Values through FCA #7**

Dispatch Zone	Active DR DRV <sup>6</sup> (MW)	Active DR NPR DRV (MW)	Total Active DR DRV (MW)
<b>Bangor Hydro</b>	56	Not Included	56
<b>Maine</b>	207	Not Included	207
<b>Portland, ME</b>	32	Not Included	32
<b>New Hampshire</b>	49	Not Included	49
<b>New Hampshire Seacoast</b>	12	Not Included	12
<b>Northwest Vermont</b>	38	Not Included	38
<b>Vermont</b>	25	Not Included	25
<b>Boston, MA</b>	81	Not Included	81
<b>North Shore Massachusetts</b>	36	Not Included	36
<b>Central Massachusetts</b>	51	Not Included	51
<b>Springfield, MA</b>	33	Not Included	33
<b>Western Massachusetts</b>	78	Not Included	78
<b>Lower Southeast Massachusetts</b>	20	Not Included	20
<b>Southeast Massachusetts</b>	121	Not Included	121
<b>Rhode Island</b>	74	Not Included	74
<b>Eastern Connecticut</b>	49	-12	37
<b>Northern Connecticut</b>	100	-16	84

<sup>5</sup> DRV = Demand Reduction Value = the actual amount of load reduced measured at the customer meter; these totals are forecasted values for the commitment period beginning June 1, 2022. These values exclude transmission and distribution losses.

<sup>6</sup> Includes DR terminations in CT



Dispatch Zone	Active DR DRV <sup>6</sup> (MW)	Active DR NPR DRV (MW)	Total Active DR DRV (MW)
<b>Norwalk-Stamford, Connecticut</b>	37	-3	34
<b>Western Connecticut</b>	117	-13	104
<b>New England Total</b>	<b>1,216</b>	<b>-44</b>	<b>1,171</b>

### 3.2.7 Load Levels Studied

Consistent with ISO-NE planning practices, transmission planning studies utilize the ISO-NE extreme weather 90/10 forecast assumptions for modeling summer peak load profiles in New England. A summary breakdown of the load modeled in the 2022 cases, taking into account transmission and distribution losses, is shown in Table 3-3. A more detailed report of the loads modeled and how the numbers were derived from the CELT values can be seen in Appendix A: Load Forecast in Table 9-2.

**Table 3-3: Net New England Load Levels Studied**

	Summer Peak (MW)
<b>New England CELT Load</b>	34,105
<b>Transmission Losses (2.5%)</b>	-853
<b>Non-CELT Load (Maine)</b>	364
<b>Passive DR<sup>7</sup></b>	-1,709
<b>Forecasted EE<sup>7</sup></b>	-1,096
<b>Active DR<sup>7 8</sup></b>	-927
<b>Net NE Total Load</b>	<b>29,884</b>
<b>Total Station Service Load<sup>9</sup></b>	950
<b>Net NE Total Load (w/ SS)</b>	30,834

After taking into account the aforementioned transmission losses, the subtraction of demand response loads, and the addition of non-CELT loads, the net load level modeled in the base cases for this study was approximately 29,900 MW.

Prior to completion of this study, the 2014 CELT report was issued in May 2014. The forecasted 2022 summer 90/10 peak demand forecast for New England of 33,865 MW. The state of Connecticut forecast for 2022 remained unchanged from the 2013 to 2014 forecast of 8,825 MW. The New England system had a reduction of 240 MW (0.7%) from the 2013 forecast. With an annual growth rate in New England of over 300 MW per year, this represents less than 1 year of load growth and does not defer the year of need out of the 10-year planning horizon. Therefore this change in forecast did not require a re-run of the power flow analysis.

<sup>7</sup>This value has been adjusted up by 5.5% to account for distribution losses.

<sup>8</sup> This value has been adjusted down by 25% based on performance assumptions for Active DR.

<sup>9</sup> This is an approximate value; this number does not count against the total net reported load in this study due to the variability of total station service load in service based on generation dispatch.

### 3.2.8 Load Power Factor Assumptions

Load power factors consistent with the local transmission owner’s planning practices were applied uniformly at each substation. Demand resource power factors were set to match the power factor of the load at that bus in the model. A list of overall power factors by company territory can be found in the detailed load report in Appendix A: Load Forecast in Table 9-2.

### 3.2.9 Transfer Levels

In accordance with the reliability criteria of the NERC, NPCC and the ISO, the regional transmission power grid must be designed for reliable operation during stressed system conditions. The following external transfers were utilized for the study:

- N-1 Analysis
  - New York to New England (AC ties) – 0 MW / 1,200 MW Import
  - Cross Sound Cable – 346 MW Export to Long Island<sup>10</sup>
  - Norwalk-Northport Cable – 200 MW Export to Long Island<sup>11</sup>
  - Highgate HVDC – 200 MW Import into New England
  - Phase II HVDC – 2,000 MW Import<sup>12</sup> into New England
  - New Brunswick to New England – 1,000 MW Import
- N-1-1 Analysis
  - New York to New England (AC Ties) – 0 MW Export
  - Cross Sound Cable – 0 MW Export
  - Norwalk-Northport Cable – 0 MW Export
  - Highgate HVDC – 200 MW Import into New England
  - Phase II HVDC – 2,000 MW Import into New England
  - New Brunswick to New England – 1,000 MW Import

For this Solutions Study, the generation dispatch dictated the internal transfer levels.

### 3.2.10 Generation Dispatch Scenarios

All generators in the base case are modeled with a maximum capacity corresponding to their Qualified Capacity as of FCA #7.

Table 3-4 shows the Qualified Capacities of the generating units in the study area.

---

**Table 3-4: Qualified Generating Capacities of Study Area Units**

Area	Generating Unit	Qualified Capacity (MW)	Fast-Start <sup>13</sup> Unit
<b>Two Largest Critical Units in Connecticut</b>	Millstone 2	877	No
	Millstone 3	1225	No
<b>Middletown Subarea</b>	Middletown 2	117	No
	Middletown 3	236	No
	Middletown 10	17	Yes
	Branford Jet	19	Yes
<b>Eastern CT</b>	Kleen Energy	620	No
<b>Greater Hartford Subarea</b>	CDECCA	55	No
	South Meadow 5	23	No
	South Meadow 6	25	No
	South Meadow 11	36	Yes
	South Meadow 12	38	Yes
	South Meadow 13	38	Yes
	South Meadow 14	37	Yes
<b>Northwest Connecticut Area</b>	Bristol Refuse/ Forestville	13	No
	Falls Village	3	No
	Franklin Drive 10	15	Yes
	Torrington Terminal Jet	19	Yes
<b>Manchester-Barbour Hill Subarea</b>	Dexter	37	No
	Rainbow	8	No
<b>Other Units in Western CT &amp; outside SWCT</b>	Middletown 4	400	No
	Middletown 12	47	Yes
	Middletown 13	47	Yes
	Middletown 14	47	Yes
	Middletown 15	47	Yes
	New Haven Harbor 1	448	No
	New Haven Harbor 2	43	Yes
	New Haven Harbor 3	43	Yes
New Haven Harbor 4	43	Yes	
<b>Two Largest Units in Southwest CT</b>	Bridgeport Harbor 3 (BH3)	383	No
	Bridgeport Energy (BE)	448	No

Twenty two dispatches were created for the four study areas and for the Western Connecticut Import and Connecticut Import Needs Assessment. The dispatches were created by taking out one or two critical units in each subarea.

<sup>13</sup> “Fast-start” generators are those units that can go from being off-line to their full Seasonal Claimed Capability in 10 minutes. These units do not need to participate in the 10-minute reserve market to be considered a fast-start unit in planning studies.

At all locations in the study area where a single fast-start unit was available, that unit was assumed OOS for each dispatch. For subareas where there were two single fast-start units, one of the two fast-start units was assumed online and available, if non-fast-start units were taken out of service in that subarea. For example, if the Middletown 3 unit is assumed OOS as a non-fast-start unit then one of the two single fast-starts in the Middletown subarea, Branford Jet or Middletown 10, is assumed to be in-service.

The Connecticut fast-start units were dispatched such that approximately 80% of the fast-start capability in Connecticut was online. The most up-to-date voltage schedules for area units provided by Northeast Utilities were utilized in this study. The fast-start dispatch assumptions detailed above were turned on in the base case and no adjustments were made to these fast start units post first contingency.

The historical performance of one of the hydroelectric units in the study area, Rainbow Hydro, was examined and it was determined that an availability of 10% of its nameplate capacity at summer peak was a reasonable assumption. This assumption was extended to all the Connecticut hydro units. This was acceptable since there are very few hydro units in Connecticut and just two of them are in the study area: Rainbow Hydro and Falls Village.

Table 3-5 provides the outputs assumed for the hydro units in Connecticut for units above 5 MW.

**Table 3-5: Dispatch of Hydro Units in Connecticut**

Unit Name	Dispatched Amount (MW)	Name Plate (50 degree rating; MW)	Location
Rainbow Hydro	0.8	8.2	Manchester/Barbour Hill
Stevenson Hydro	2.9	28.9	SWCT
Falls Village	1.0	9.8	NWCT
Rocky River	2.9	29.4	SWCT
Shepaug	4.3	42.9	SWCT
Bulls Bridge	0.8	8.4	SWCT
Derby Dam	0.7	7.1	SWCT

The dispatches for each subarea are defined in the following section:

- **Middletown Subarea:** [REDACTED]

Since these units are located on the same bus, only the largest of the two (Middletown 3) was taken OOS to create a one-unit-out dispatch. The Middletown study area has two single fast-start units, Middletown 10 and Branford Jet. For each case, one-unit-out case and two-unit-out case, two dispatches were created based on fast-start dispatch. Cases with the Middletown 10 off and Branford Jet on are called MIDD\_01 (two units OOS) and MIDD\_1A (one unit out). Alternately, cases with the Middletown 10 on and Branford Jet off are called MIDD\_02 (two units OOS) and MIDD\_2A (one unit out). This leads to a total of four dispatches for this subarea.

- **Manchester-Barbour Hill Subarea:** [REDACTED]  
[REDACTED] ince the Rainbow Hydro unit is a small unit, only one single unit out dispatch was created with Dexter out-of-service. This leads to a total of two dispatches for this subarea.
- **Northwest Connecticut Subarea:** [REDACTED]  
[REDACTED] ince the Falls Village Hydro unit is a small unit, only one single unit out dispatch was created with the Forestville unit out of service. The Northwest Connecticut study area has two single fast-start units, Franklin Drive 10 and Torrington Terminal Jet. For each case, one-unit-out case and two-unit-out case, two dispatches were created based on fast-start dispatch. Cases with the Franklin Drive 10 on and Torrington Terminal Jet off are called NWCT\_01 (two units OOS) and NWCT\_1A (one unit out). Alternately, cases with the Franklin Drive 10 off and Torrington Terminal Jet on are called NWCT\_02 (two units OOS) and NWCT\_2A (one unit out). This leads to a total of four dispatches for this subarea.
- **Hartford Subarea:** [REDACTED]  
[REDACTED] There were two different two-units-out dispatches for this study area. The first has the two South Meadow units OOS and the other has one South Meadow unit (#6) and the Capitol District unit OOS. Two one-unit-out dispatches were also created, taking out the larger South Meadow unit (#6) and the Capitol District unit separately. This leads to a total of four dispatches for this subarea.
- **Western Connecticut Import Analysis:** Four dispatches were established to test the need for additional Western Connecticut Import capability.
  - **Dispatch 1** – High SWCT Import – Bridgeport Harbor 3 OOS and Bridgeport Energy OOS
  - **Dispatch 2** – Moderate Western CT Import – New Haven Harbor and Kleen Energy OOS (Kleen is an eastern CT unit very close to the western CT import interface)
  - **Dispatch 3** – High Western CT Import – Bridgeport Harbor 3 and New Haven Harbor OOS (two largest 115 kV generators in western Connecticut)
  - **Dispatch 4** – High Western CT Import – Bridgeport Energy and New Haven Harbor OOS (two largest generators in western Connecticut)

Additionally, two one-unit out dispatches were created.

- **Dispatch 3A** – High SWCT Import – Bridgeport Energy OOS
- **Dispatch 4A** – High western CT Import – New Haven Harbor OOS

This leads to a total of six dispatches for the Western CT Import analysis.

- **Connecticut Import Analysis:** As a part of the NEEWS Interstate analysis several line overloads were seen in the GHCC Study area. The overloads seen in the Interstate analysis were not resolved and were examined as a part of this analysis. [REDACTED]  
[REDACTED] Since these units are located on the same bus, only the largest of the two (Millstone 3) was taken OOS to create a one-unit-out dispatch. This leads to a total of two dispatches for this analysis.

The twenty-two dispatches just described are summarized in Table 3-6 and Table 3-7 on the following pages.

**Table 3-6: Two-Unit-Out Generation Dispatches**

Major Area Units	Dispatch Name / Number											
	Middletown #1	Middletown #2	Barbour Hill #1	NWCT #1	NWCT #2	HTFD #1	HTFD #2	CCRP #1	CCRP #2	CCRP # 3	CCRP #4	IRP #1 <sup>14</sup>
<b>Middletown 2</b>	OFF	OFF	ON	ON	ON	ON	ON	ON	ON	ON	ON	ON
<b>Middletown 3</b>	OFF	OFF	ON	ON	ON	ON	ON	ON	ON	ON	ON	ON
<b>Middletown 10<sup>15</sup></b>	OFF	ON	OFF	OFF	OFF	OFF	OFF	OFF	OFF	OFF	OFF	OFF
<b>Branford Jet<sup>15</sup></b>	ON	OFF	OFF	OFF	OFF	OFF	OFF	OFF	OFF	OFF	OFF	OFF
<b>Dexter</b>	ON	ON	OFF	ON	ON	ON	ON	ON	ON	ON	ON	ON
<b>Rainbow</b>	ON	ON	OFF	ON	ON	ON	ON	ON	ON	ON	ON	ON
<b>Falls Village</b>	ON	ON	ON	OFF	OFF	ON	ON	ON	ON	ON	ON	ON
<b>Forestville</b>	ON	ON	ON	OFF	OFF	ON	ON	ON	ON	ON	ON	ON
<b>Franklin Drive 10<sup>15</sup></b>	OFF	OFF	OFF	ON	OFF	OFF	OFF	OFF	OFF	OFF	OFF	OFF
<b>Torrington Term. Jet<sup>15</sup></b>	OFF	OFF	OFF	OFF	ON	OFF	OFF	OFF	OFF	OFF	OFF	OFF
<b>South Meadow 5</b>	ON	ON	ON	ON	ON	OFF	OFF	ON	ON	ON	ON	ON
<b>South Meadow 6</b>	ON	ON	ON	ON	ON	OFF	ON	ON	ON	ON	ON	ON
<b>CDECCA</b>	ON	ON	ON	ON	ON	ON	OFF	ON	ON	ON	ON	ON
<b>Bridgeport Energy</b>	ON	ON	ON	ON	ON	ON	ON	OFF	ON	ON	OFF	ON
<b>Bridgeport Harbor 3</b>	ON	ON	ON	ON	ON	ON	ON	OFF	ON	OFF	ON	ON
<b>Kleen Energy</b>	ON	ON	ON	ON	ON	ON	ON	ON	OFF	ON	ON	ON
<b>New Haven Harbor 1</b>	ON	ON	ON	ON	ON	ON	ON	ON	OFF	OFF	OFF	ON
<b>Millstone 2</b>	ON	ON	ON	ON	ON	ON	ON	ON	ON	ON	ON	OFF
<b>Millstone 3</b>	ON	ON	ON	ON	ON	ON	ON	ON	ON	ON	ON	OFF

<sup>14</sup> [REDACTED]

<sup>15</sup> Fast-Start unit

**Table 3-7: One-Unit-Out Generation Dispatches**

Major Area Units	Dispatch Name/Number									
	Middletown #1A	Middletown #1B	Barbour Hill #1A	NWCT #1A	NWCT #2A	HTFD #1A	HTFD #2A	CCRP #3A	CCRP # 4A	IRP #1A <sup>16</sup>
Middletown 2	ON	ON	ON	ON	ON	ON	ON	ON	ON	ON
Middletown 3	OFF	OFF	ON	ON	ON	ON	ON	ON	ON	ON
Middletown 10 <sup>17</sup>	OFF	ON	OFF	OFF	OFF	OFF	OFF	OFF	OFF	OFF
Branford Jet <sup>17</sup>	ON	OFF	OFF	OFF	OFF	OFF	OFF	OFF	OFF	OFF
Dexter	ON	ON	OFF	ON	ON	ON	ON	ON	ON	ON
Rainbow	ON	ON	ON	ON	ON	ON	ON	ON	ON	ON
Falls Village	ON	ON	ON	ON	ON	ON	ON	ON	ON	ON
Forestville	ON	ON	ON	OFF	OFF	ON	ON	ON	ON	ON
Franklin Drive 10 <sup>17</sup>	OFF	OFF	OFF	ON	OFF	OFF	OFF	OFF	OFF	OFF
Torrington Term. Jet <sup>17</sup>	OFF	OFF	OFF	OFF	ON	OFF	OFF	OFF	OFF	OFF
South Meadow 5	ON	ON	ON	ON	ON	ON	ON	ON	ON	ON
South Meadow 6	ON	ON	ON	ON	ON	OFF	ON	ON	ON	ON
CDECCA	ON	ON	ON	ON	ON	ON	OFF	ON	ON	ON
Bridgeport Energy	ON	ON	ON	ON	ON	ON	ON	OFF	ON	ON
Bridgeport Harbor 3	ON	ON	ON	ON	ON	ON	ON	ON	ON	ON
Kleen Energy	ON	ON	ON	ON	ON	ON	ON	ON	ON	ON
New Haven Harbor 1	ON	ON	ON	ON	ON	ON	ON	ON	OFF	ON
Millstone 2	ON	ON	ON	ON	ON	ON	ON	ON	ON	ON
Millstone 3	ON	ON	ON	ON	ON	ON	ON	ON	ON	OFF

### 3.2.11 Reactive Resource and Dispatch Assumptions

All area shunt reactive resources were assumed available and dispatched when required. Reactive output of generating units was modeled to reflect defined limits. A summary of the reactive output of units and shunt devices connected to the transmission system that played a significant role in the study area can be found in the power flow case summaries included in Appendix B: Case Summaries and Load Flow Plots.

<sup>16</sup> [REDACTED]

<sup>17</sup> Fast-Start unit

### 3.2.12 Market Solutions Consideration

In accordance with Attachment K of the OATT, all resources that have cleared in the markets were assumed in the model for future planning reliability studies. This included numerous new generation and demand resources from FCA #1 through 7 as listed in Section 3.2.4 and Section 3.2.6.

It should be noted that during the course of the Solutions Study, FCA #8 was completed in February 2014. The results of the auction were deemed to not have a significant impact in the current study and the cases were not re-run to reflect those changes.

### 3.2.13 Demand Resource Assumptions

As stated in Section 3.2.6, Passive DR, as forecasted for the year 2022, and Active DR that cleared as of FCA #7 in 2013 were modeled for this study, minus approximately 52 MW of demand resources in Connecticut that have accepted NPR Requests for FCA #8. Passive DR was assumed to perform to 100% of their forecasted amount. The Passive DR included the forecasted EE which was assumed to perform to 100% of the forecast. Active DR was assumed to perform to 75% of their cleared amount. Real Time Emergency Generation (RTEG) was not modeled, consistent with all needs and solutions planning analyses.

**Table 3-8: New England Demand Resource Performance Assumptions**

Region	Passive DR	Energy Efficiency	Active DR	RTEGs
New England	100%	100%	75%	0%

### 3.2.14 Description of Existing and Planned Protection and Control System Devices Included in the Study





**Figure 3-1: Southington Substation**

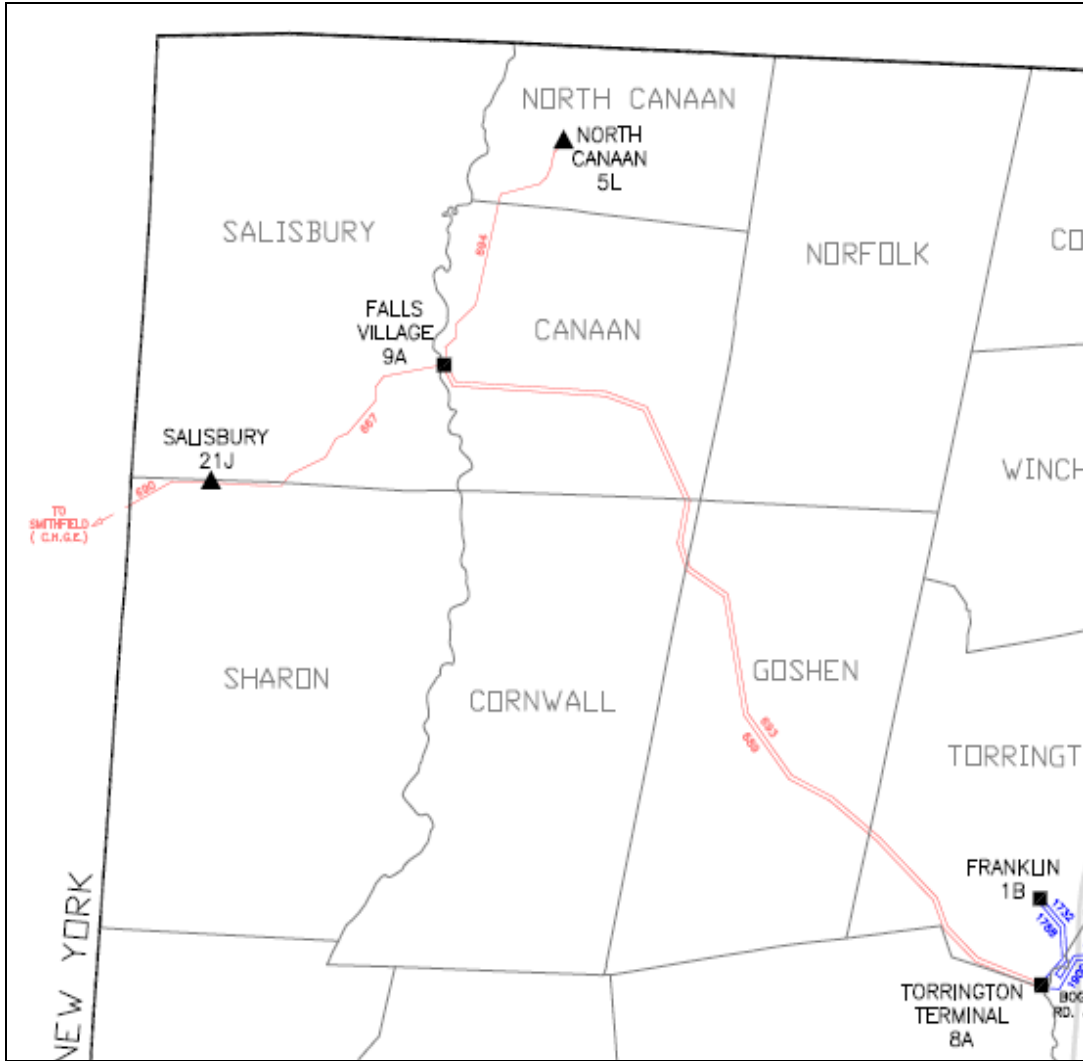


Figure 3-2: The 69 kV System in Northwestern Connecticut

### 3.3 Stability Modeling Assumptions

Not applicable to this study.

### 3.4 Short Circuit Model Assumptions

#### 3.4.1 Study Assumptions

The short circuit study evaluated the projected 2022 available fault current levels around the GHCC area after the addition of the GHCC preferred solution. It also included the effects of area reliability project upgrades as well as selected proposed generation interconnection projects as outlined in Section 3.4.3 and Section 3.4.4 of this study document.

#### 3.4.2 Short Circuit Model

The ASPEN Circuit Breaker Rating Module software was used to calculate all circuit breaker duties. The case for the short circuit study included all PPA-approved transmission projects, as discussed in

Section 3.2.3 of this scope document, were added to that model. The Central Connecticut Reliability Project (CCRP) was excluded from the base case, similar to the steady-state base cases. In addition to the projects described in Section 3.2.3, the following projects in SWCT were added to the base cases:

- Stamford Reliability Cable Project (115 kV cable between Glenbrook and South End substations)
- 115 kV Circuit Breaker (40 kA) Addison at Newtown Substation
- SONO Substation Addition (CMEEC)
- Fitch Substation Addition (CMEEC)

### **3.4.3 Contributing Generation Assumptions (Additions & Retirements)**

The model included proposed generation interconnection projects that have PPA approval as well as those generator projects that have FCA Capacity Supply Obligations (CSOs).

The following relevant generation projects were modeled for this study:

- QP 095 – Kleen Energy (FCA #2)
- QP 125 – Cos Cob 13&14 (FCA #1)
- QP 140 – A.L. Pierce (FCA #1)
- QP 150 – Plainfield Renewable Energy Project (FCA #3)
- QP 155.6 – Fuel Cell Project in Fairfield, CT (FCA #4)
- QP 161 – Devon 15-18 (FCA #2)
- QP 161 – Middletown 12-15 (FCA #2)
- QP 199 – Waterbury Generation (FCA #1)
- QP 206 – Kimberly Clark Energy (FCA #2)
- QP 248 – New Haven Harbor 2-4 (FCA #3)
- QP 289 – Fuel Cell Project in New Haven County, CT (FCA #4)
- QP 384 – Combined Cycle Project in New Haven County, CT

Due to accepted Non-Price Retirement requests for Norwalk Harbor 1, 2, and 10 as well as Bridgeport Harbor 2, these units were removed from the short circuit base case. The only significant change in generation projects from the short circuit assessment done in the Needs Assessment is the addition of QP 384 to the base cases.

### **3.4.4 Generation and Transmission System Configurations**

NPCC Regional Reliability Reference Directory #1, “Design and Operation of the Bulk Power System” and PP-3 require short circuit testing to be conducted with all transmission and generation facilities in-service for all potential operating conditions.

### 3.4.5 Boundaries

This study included testing of all 69 kV, 115 kV and 345 kV substations and breakers in the GHCC study area.

### 3.4.6 Short Circuit Study Scenarios

The following three (3) scenarios were studied as part of the short circuit analysis to study the effect of closing the 19T circuit breaker at Southington and provide breaker duties of the CL&P-owned circuit breakers in Connecticut (69 kV and above) in Connecticut. This was based on the preferred solution for the Southington area issues being the replacement of the normally open breaker 19T at Southington with a normally closed 3% series reactor.

- **Scenario #1:** Pre-project topology with the 19T circuit breaker **opened** at the Southington Substation
- **Scenario #2:** Pre-project topology with the 19T circuit breaker **closed** at the Southington Substation
- **Scenario #3:** Southington 19T circuit breaker replaced with a normally in-service 3% series reactor between the two ring buses at Southington.

### 3.4.7 Other Relevant Modeling Assumptions

Not applicable to this study.

## 3.5 Other System Studies

---

### 3.5.1 Thermal Transmission Transfer Capability Analysis

According to Section 4 of the ISO PP-3, “The New England bulk power supply system shall be designed with adequate inter-Area and intra-Area transmission transfer capability to minimize system reserve requirements, facilitate transfers, provide emergency backup of supply resources, permit economic interchange of power, and to assure the system will remain reliable under contingency conditions.”

Transmission transfer capability analysis determines the ability of a region to serve load utilizing resources within the area, as well as imports from neighboring areas. As load grows and if no future resources are placed in service in the region or no additional transmission capability is built to import more power, load cannot be served reliably. The key inputs to this analysis are the load, area resources, and the import limits into an area from surrounding areas.

To determine a transfer limit, the Siemens PTI program Managing and Utilizing System Transmission (MUST) was used to increase transfers in the network model until a transmission element becomes overloaded in the base case or after a contingency event. To increase transfer levels in a case, the output of a set of generators in the sending region of the transfer (the “source”) is increased and, at the same time, the output of a set of generators in the receiving region of the transfer (the “sink”) is decreased. Testing was performed under all-lines-in and line-out conditions. The transfer level at which an element becomes overloaded is determined to be the transfer limit. The generators in the source and sink were adjusted up or down based on their maximum machine capability.

### 3.5.1.1 Western Connecticut Import Thermal Transfer Analysis

The Western Connecticut Import analysis was conducted to determine post-project import interface limits (N-1-1) for four combinations of solution alternative packages for the Greater Hartford and Middletown study subareas, in order to determine whether any of them provided a significantly greater transfer capability than the others. To determine the limits, the transfer was established so that the source would be east of the Western Connecticut Import interface and the sink would be within the bounds of the Western Connecticut Import interface. This interface is described in Table 3-9.

**Table 3-9: Western Connecticut Import Interface Summary**

The detailed dispatch for this case can be found in Appendix B: Case Summaries and Load Flow Plots. This case was tested for every combination of possible solution alternatives for the Greater Hartford and Middletown subareas as described in Section 5.3, with three different initial element-out scenarios: the 364, 3533, and 348 lines. All of these lines lie along the Western Connecticut Import interface.

The same sink was used for all three line-out scenarios tested. The sink is comprised of the units described in Table 3-10. As Western Connecticut Import transfer levels increase, these units are ramped down in the ratio of their maximum outputs.

**Table 3-10: Western Connecticut Sink Composition**

Generation Units	Ramp-Down Capability (MW)
Devon 10, 11, 12, 13, 14, 15, 16, 17 and 18	267
Milford 1 and 2	783

The same source was used for all transfer scenarios tested. The source is comprised of the units described in Table 3-11. As Western Connecticut Import transfer levels increase, these units are ramped up in the ratio of their maximum outputs.

**Table 3-11: Rest of New England Source Composition**

Generation Units	Ramp-Up Capability (MW)
MIS	267
Footprint Power (QP 387-2)	714

### 3.5.1.2 Connecticut Import Thermal Transfer Analysis

Hence, as a part of the Barbour Hill area solutions development it was important to ensure that Connecticut Import limits were not adversely impacted. For each of the two alternatives developed in the Manchester/Barbour Hill area, N-1-1 Connecticut Import analysis was performed to ensure that Connecticut Import capability is not adversely impacted.

A 2016 summer peak load level case was used for this analysis. All components of NEEWS, with the exception of CCRP, were included.

The Connecticut Import definition is provided in Table 3-12.

**Table 3-12: Connecticut Import Interface Summary**

The generation sink and source tested during this analysis are summarized in Table 3-13 and Table 3-14, respectively.

**Table 3-13: Connecticut Sink Composition**

Generation Units	Ramp-Down Capability (MW)
Millstone 3	1276
Montville 5 and 6	505
Kleen GT1	187
Middletown 4	415
Bridgeport Energy	485
Wallingford 1-5	220
AL Pierce	78
New Haven Harbor 2-4	183
Devon 11-18	334
Waterside	74
Waterbury	104
Norwalk Harbor 1 and 2	352

**Table 3-14: SEMA/Boston Source Composition**

Generation Units	Ramp-Up Capability (MW)
NEA Bellingham	288
West Medway J1-J3	173
Kendall CT	174
Mystic 7	615
Canal 1 and 2	1196
Brayton Point 4	458
ANP Bellingham	560
ANP Blackstone	557
Dighton Power	171

### **3.6 Changes in Study Assumptions**

---

Not applicable to this study.

# Section 4

## Analysis Methodology

### 4.1 Planning Standards and Criteria

---

The applicable NERC, NPCC and ISO-NE standards and criteria will be tested as part of this evaluation. Descriptions of each of the NERC, NPCC and ISO-NE standard tests that were used to assess system performance are discussed later in this section.

### 4.2 Performance Criteria

---

#### 4.2.1 Steady State Criteria

The Solutions Study was performed in accordance with NERC TPL-001, TPL-002, TPL-003 and TPL-004 Transmission Planning System Standards, NPCC “Regional Reliability Reference Directory #1, Design and Operation of the Bulk Power System”, dated 04/20/12, and the ISO Planning Procedure No. 3, “Reliability Standards for the New England Area Bulk Power Supply System”, dated 03/01/13. The contingency analysis steady-state voltage and loading criteria, solution parameters and contingency specifications that were used in this analysis are consistent with these documents.

#### 4.2.2 Steady State Thermal and Voltage Limits

Loadings on all transmission facilities rated at 69 kV and above in the study area were monitored. The thermal violation screening criteria defined in Table 4-1 were applied.

**Table 4-1: Steady-State Thermal Criteria**

System Condition	Maximum Allowable Facility Loading
Normal (all-lines-in) (Pre-Contingency)	Normal Rating
Post-Contingency	Long Time Emergency (LTE) Rating

Voltages were monitored at all buses with voltages 69 kV and above in the study area. System bus voltages outside of limits identified in Table 4-2 were identified for all normal (pre-contingency) and post-contingency conditions.



**Table 4-2: Steady-State Voltage Criteria**

Transmission Owner	Voltage Level	Bus Voltage Limits (Per-Unit)	
		Normal Conditions (Pre-Contingency)	Emergency Conditions (Post-Contingency)
Northeast Utilities	69 kV & above	0.95 to 1.05	0.95 to 1.05
Millstone / Seabrook <sup>18</sup>	345 kV	1.00 to 1.05	1.00 to 1.05
Pilgrim	345 kV	0.995 to 1.05	0.99 to 1.05
Vermont Yankee	115 kV	1.00 to 1.05	1.00 to 1.05
	345 kV	0.985 to 1.05	0.985 to 1.05

### 4.2.3 Steady State Solution Parameters

The steady-state analysis was performed with pre-contingency solution parameters that allow for adjustment of load tap-changing transformers (LTCs), static VAR devices (SVDs, including automatically-switched capacitors), and phase angle regulators (PARs). For post-contingency, only the load tap-changing transformers (LTCs) were allowed to be adjusted. Table 4-3 displays these solution parameters.

**Table 4-3: Study Solution Parameters**

Case	Area Interchange Control	Tap Adjustments	Adjust Phase Shift	Switched Shunt Adjustments
Base	Tie Lines and Loads Enabled	Stepping	Enabled	Enabled
Contingency	Disabled	Stepping	Disabled	Disabled

### 4.2.4 Stability Performance Criteria

Not applicable to this study.

### 4.2.5 Short Circuit Performance Criteria

This study was performed in accordance with appropriate IEEE C37 standards and specific design parameters of the circuit breakers. This includes specific considerations for total-current rated and symmetrical-current rated breakers as appropriate.

The circuit breakers were evaluated for short circuit adequacy based on the following criteria:

- *Acceptable-duty*: Circuit breaker fault interrupting duty less than 90% of the available fault current. No action required.
- *Marginal-duty*: Circuit Breaker Fault Interrupting Duty greater than or equal to 90% and less than 100%.

<sup>18</sup> This is in compliance with NUC-001-2, “Nuclear Plant Interface Coordination Reliability Standard,” adopted August 5, 2009.

- *Over-duty Condition:* Circuit Breaker Fault Interrupting Duty greater than 100%. This is considered an unacceptable operating condition requiring a solution to be developed to eliminate the over-duty condition.

## **4.3 System Testing**

---

### **4.3.1 System Conditions Tested**

Testing of system conditions included the evaluation of system performance under a number of resource outage scenarios, variation of related transfer levels, and an extensive number of transmission equipment contingency events

### **4.3.2 Steady State Contingencies Tested**

Each base case was subjected to single element contingencies such as the loss of a transmission circuit or an autotransformer. In addition, single contingencies which may cause the loss of multiple transmission circuit facilities, such as those on a common set of tower line structures were simulated. The steady-state contingency events in this study also included circuit breaker failures and substation bus fault conditions that could result in removing multiple transmission elements from service. A comprehensive set of contingency events, listed in Appendix D: Contingency Listings, were tested to monitor thermal and voltage performance of the GHCC study area transmission network. A listing of all contingency types that were tested is included in Table 4-4.

Additional analyses evaluated N-1-1 conditions with an initial outage of a key transmission element or generator followed by another contingency event. The N-1-1 analyses examined the summer peak load case with stressed conditions. For these N-1-1 cases, reliability standards, including ISO-NE Planning Procedure 3, allow specific manual system adjustments, such as fast-start generation re-dispatch, phase-angle regulator adjustment or HVDC adjustments between the first and second single contingency event. A summary listing of first element-out scenarios is provided in Table 4-5. A total of 113 element-out scenarios were tested. A detailed listing of all the element out scenarios tested is provided in Appendix C: Element-Out Scenarios for N-1-1 Analysis.

It should be noted that a distinction was made in this Solutions Study based on the nature of a no-fault contingency as follows:

- Type 1: No-fault contingencies involving the opening of a terminal of a line independent of the design of the terminating facility
- Type 2: A subset of the above contingencies that involves the opening of a single breaker

For N-1 testing, all Type 1 contingencies above were simulated. However, for N-1-1 testing only the Type 2 contingencies were simulated as 2<sup>nd</sup> contingencies.

**Table 4-4: Summary of NERC, NPCC and/or ISO-NE Contingencies Included in Study**

Contingency Type	NERC Type	NPCC D-1 Section	ISO PP 3 Section	Tested in This Study
<b>All Facilities in-service</b>	A	5.4.2.b	3.2.b	Yes
<b>Generator (Single Unit)</b>	B1	5.4.1.a	3.1.a	Yes
<b>Transmission Circuit</b>	B2	5.4.1.a	3.1.a	Yes
<b>Transformers</b>	B3	5.4.1.a	3.1.a	Yes
<b>Element w/o Fault</b>	B5	5.4.1.d	3.1.d	Yes
<b>Bus Section</b>	C1	5.4.1.a	3.1.a	Yes
<b>Breaker Failure</b>	C2	5.4.1.e	3.1.e	Yes
<b>Double Circuit Tower</b>	C5	5.4.1.b	3.1.b	Yes
<b>Extreme Contingencies</b>	D	5.6	6	Yes (Limited)

**Table 4-5: Summary of N-1-1 First Element-Out Scenarios**

Contingency Type	Number of Element Out Scenarios
<b>Overhead 345 kV lines</b>	24
<b>Autotransformers</b>	15
<b>Generators</b>	6
<b>Underground 115 kV cables</b>	3
<b>Overhead 115 kV lines</b>	67
<b>Overhead 69 kV Lines</b>	3
<b>Total Number of Scenarios</b>	<b>118</b>

### 4.3.3 Use of Re-Dispatch

As outlined in PP-3, allowable actions after the first contingency event and prior to the second contingency event include re-dispatch of generation. During the analysis, available generation in the study area and its vicinity were allowed to reduce their output if online. Remote generation in Eastern New England was used to replace the lost generation within the area of study to simulate the re-dispatch of 10 minute reserves within New England to keep load balance. A maximum limit of 1,200 MW of re-dispatch was considered acceptable. Anything higher than 1,200 MW could not be considered acceptable due to the amount of reserves typically available on the system.

To simulate these actions in power flow analysis, the Security Constrained Re-Dispatch (SCRD<sup>19</sup>) tool in the TARA software package was used.

Additionally, since the shunt devices were assumed to be locked for post contingency conditions as indicated in Table 4-3, pre-contingency adjustment of capacitors were allowed to prevent post-contingency voltage concerns. The adjustment was primarily performed to the Southington 115 kV and Frost Bridge 115 kV capacitors.

<sup>19</sup> TARA's SCR D tool does not consider economics in the objective function to solve violation constraints. It solely uses the most effective generation that will resolve a particular constraint on the system

### 4.3.4 Stability Contingencies/Faults Tested

Not applicable to this study.

### 4.3.5 Short Circuit Faults Tested

The ASPEN circuit breaker rating module software was used to calculate all circuit breaker duties. The pre-fault operating voltage for all GHCC study area buses was set to be 1.04 per unit (p.u.). Figure 4-1 shows the ASPEN options that were used in this study.

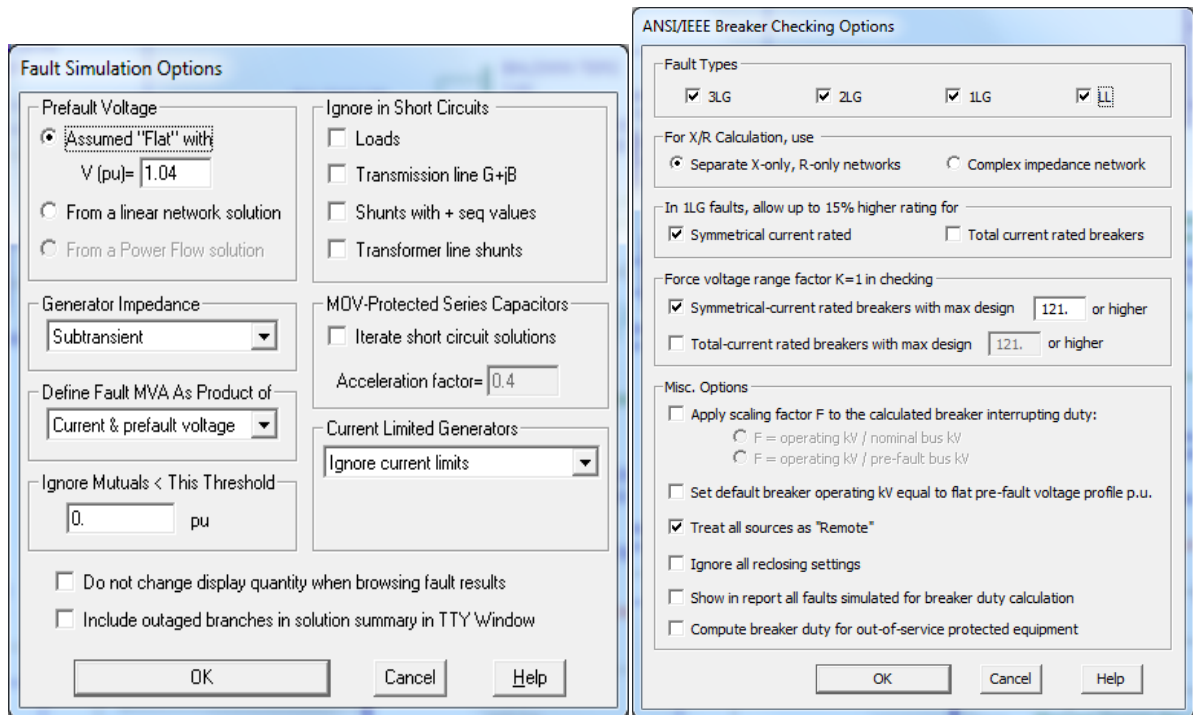


Figure 4-1: Circuit Breaker Testing Parameters

## Section 5

# Development of Alternative Solutions

The GHCC 2022 Needs Assessment identified numerous system weaknesses in the four study subareas and a need for additional transfer capacity across the Western Connecticut Import interface. The subarea weaknesses were evident mostly under generation deficiency conditions in each area. However, a number of issues were also seen when all of the generation in a given subarea is available, which would indicate that those issues are independent of generation dispatch.

The alternative solutions were developed to find ways to strengthen connections to the load pockets by adding new sources into the pocket, improving the remaining elements after N-1-1 contingency events to adequately handle the additional loading, or eliminating the contingency condition causing the violations. These additions and other improvements were designed with the objective of also increasing Western Connecticut Import capability by adding an element to the Western Connecticut Import interface or increasing the capability of one or more existing elements of the interface. A description of all the alternative solutions is in Section 5.3. All of the alternative solutions were first evaluated to ensure that the solution components resolve all the identified criteria violations identified in the Needs Assessment. These evaluations are described in Section 6. The next step was to compare the alternative solution components in terms of cost, constructability, environmental concerns, and several other criteria. These comparisons are described in Section 7.

### 5.1 Preliminary Screen of Alternative Solutions

---

During the conceptual phase of the Solutions Study, several solutions were proposed to address the identified needs. The addition of new 345 and/or 115 kV lines or new 345/115 kV autotransformers were discussed as possible solutions to serve the subareas. In addition, the CCRP portion of NEEWS was also included as a potential alternative. However, it was determined that with the implementation of the preferred GHCC solution, as described in later sections of this report, the need for CCRP was eliminated.

### 5.2 Coordination of Alternative Solutions with Other Entities

---

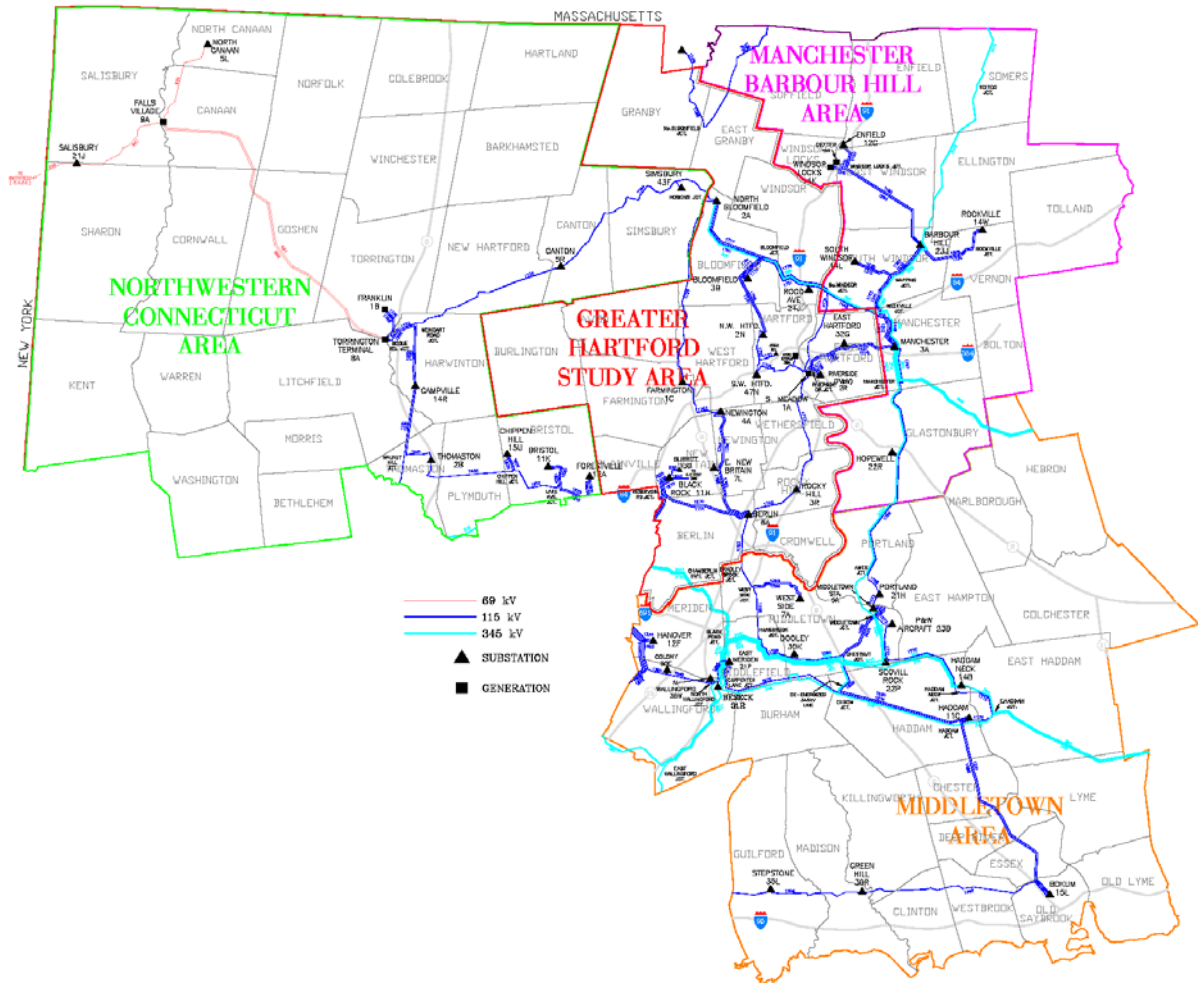
The working group for this study consisted of representatives from NU, UI, and ISO New England. This working group helped to ensure that the study of solution alternatives for the GHCC area took into account planned transmission system changes outside of the study area and the impact of the proposed GHCC solution alternatives on the surrounding transmission system. In particular, the working group has collaborated with the Southwestern Connecticut working group to ensure that the solutions developed for each area are coordinated.

### 5.3 Description of Alternative Solutions

---

The Greater Hartford and Central Connecticut study area covers the majority of the state of Connecticut west of the New England East-West transmission interface that was not studied as part of the ongoing Southwestern Connecticut study. It was determined that the solutions for different subareas within the greater GHCC area could be analyzed independently of one another, since the needs for the area were largely driven by load serving issues following the loss of critical 115 kV

sources into each subarea. Figure 5-1 shows the GHCC geographic area with each study subarea defined.



**Figure 5-1: GHCC Study Area Map**

After a preferred solution alternative was chosen for each subarea, an overall preferred solution for the entire study was tested to ensure that all violations observed during the Needs Assessment were resolved and that the combined solution did not cause any adverse interactions.

### 5.3.1 Manchester / Barbour Hill Subarea

The Manchester-Barbour Hill subarea consists of about 452 MW of load including demand resources in 2022. The area has one generator (Dexter) that has a qualified capacity of 37 MW and is considered a regular generator and one hydro station (Rainbow Hydro) that has a total qualified capacity of about 8 MW. The hydro station is dispatched to 10% of its nameplate capacity at 0.8 MW.

#### 5.3.1.1 Manchester / Barbour Hill Subarea Needs Assessment Results

Looking at the load and generation it can be observed that the Manchester-Barbour Hill subarea is a net importer of energy and relies on the surrounding areas to serve local load. [REDACTED]

[REDACTED] There are also 115 kV ties into the Manchester-Barbour Hill area from the Greater Hartford and Middletown subareas.

All criteria violations in this subarea were observed under N-1-1 conditions. The violations may be broadly divided into two categories:

- Barbour Hill Load Pocket
- Manchester Autotransformers

The Barbour Hill load pocket consists of five 115 kV substations and the details for this load pocket are shown in Figure 5-2. The total load within this load pocket is about 326 MW including demand resources. The area is fed by the following three transmission elements:

- The 345/115 kV autotransformer at Barbour Hill (Barbour Hill Auto)
- A 115 kV line from Manchester to Barbour Hill (Line 1763)
- A 115 kV line from Manchester to South Windsor (Line 1310)

[REDACTED]

The criteria violations are only seen under N-1-1 conditions. [REDACTED]

[REDACTED]

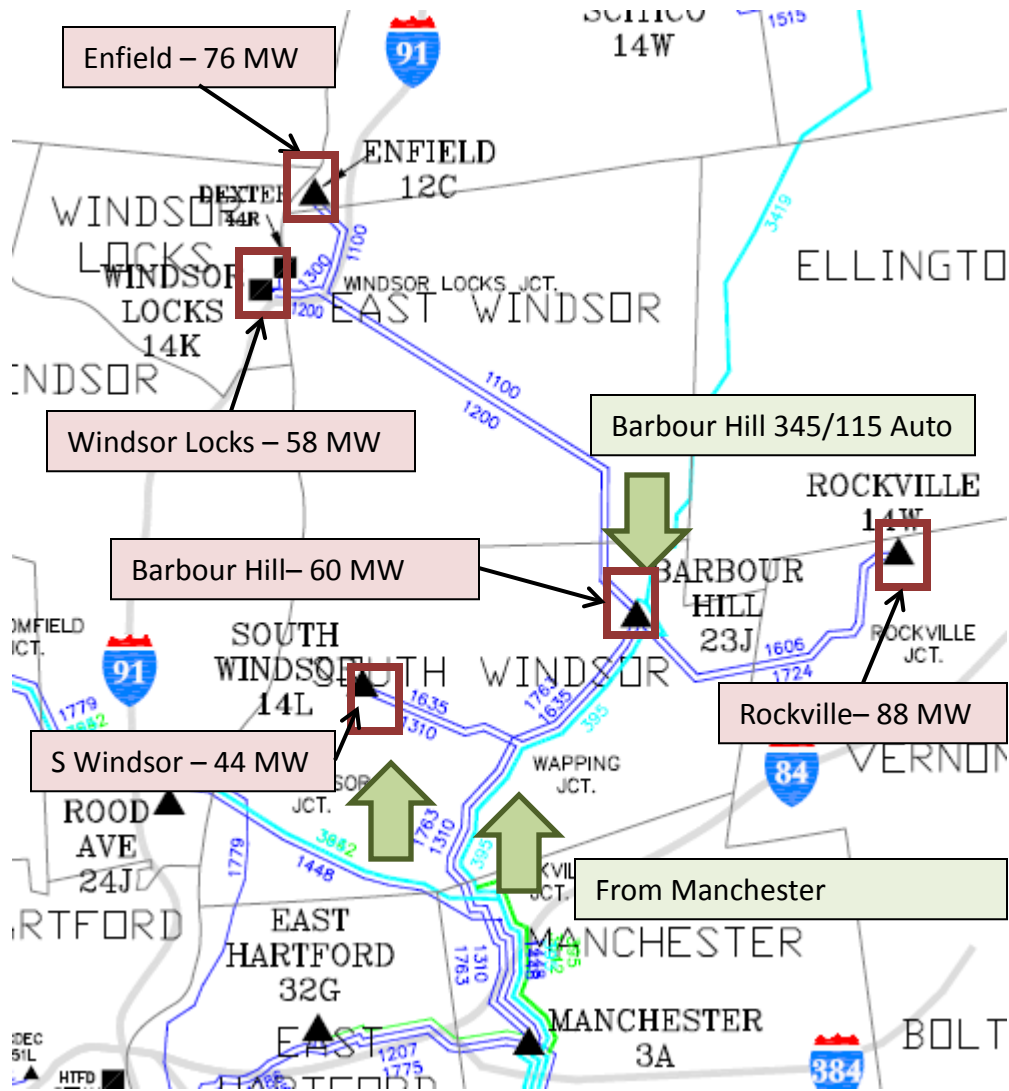
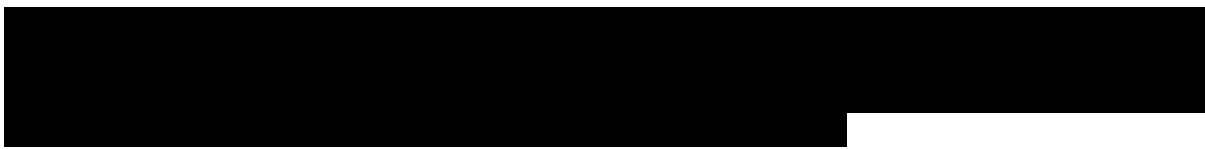


Figure 5-2: Manchester / Barbour Hill Subarea Existing Geographic One-Line



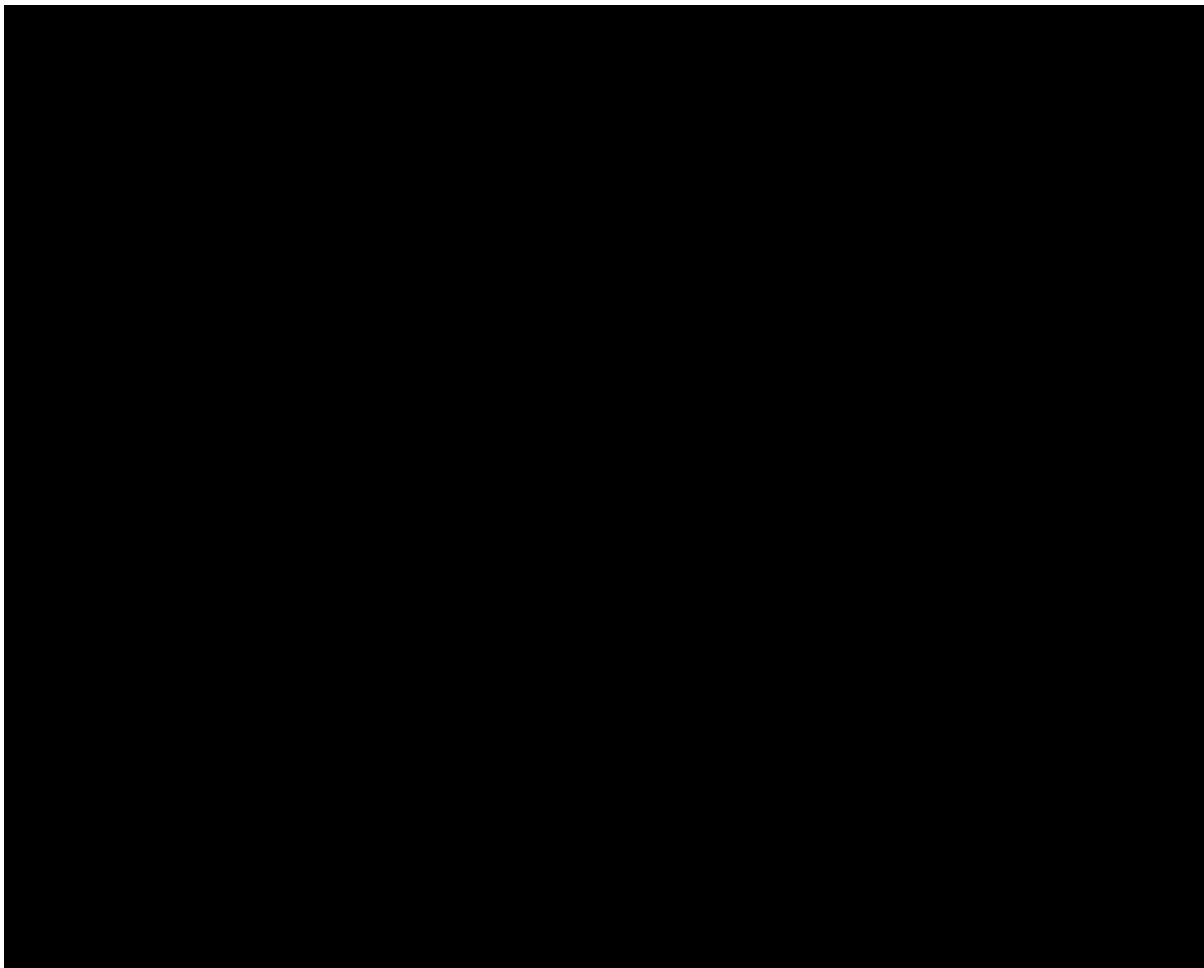
### 5.3.1.2 Manchester / Barbour Hill Subarea Alternative Solutions

Two local solution alternatives were developed to solve the violations in the Manchester / Barbour Hill subarea. Both alternatives provide a new 115 kV source into the Barbour Hill load pocket, and additional components were added to the new source to resolve the remaining criteria violations. The two different solution alternatives are summarized in Table 5-1 below.

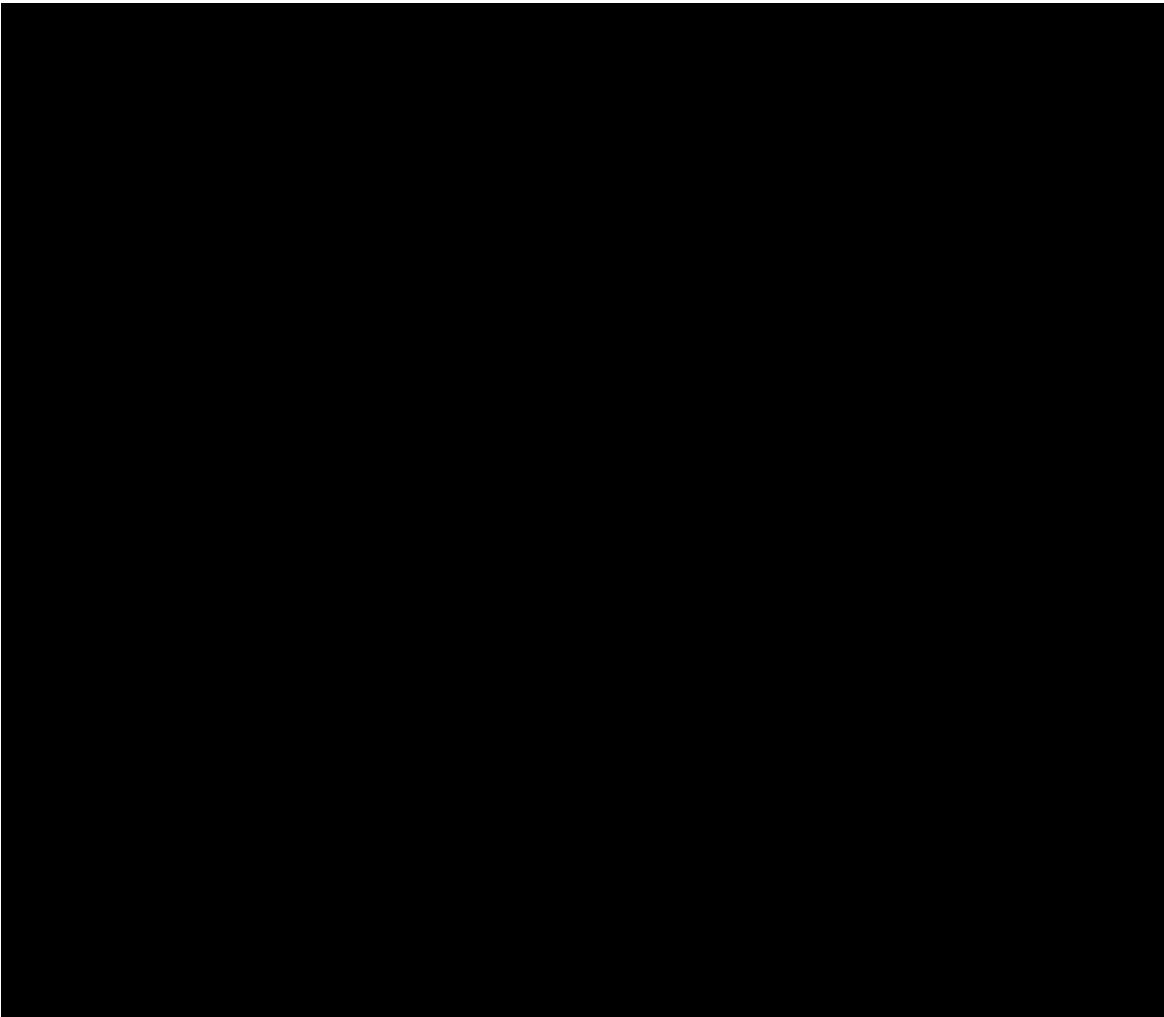


**Table 5-1: Manchester / Barbour Hill Subarea Solution Alternatives**

Component ID	Description	Included in Alternative A	Included in Alternative B
1	Add a new 345/115 kV autotransformer at Barbour Hill and associated terminal equipment	Y	
2	Add a new 7.6 mile, 115 kV line from Manchester to Barbour Hill and associated terminal equipment		Y
3	Reconductor the 115 kV line between Manchester and Barbour Hill (1763) – 7.6 miles	Y	
4	Add a 345 kV breaker in series with breaker 24T at the Manchester 345 kV switchyard	Y	Y
5	Add two 345 kV breakers in series with breaker 18T and 19T at the Manchester 345 kV switchyard		Y
6	Add a 115 kV breaker in series with breaker 13T at the Manchester 115 kV switchyard		Y

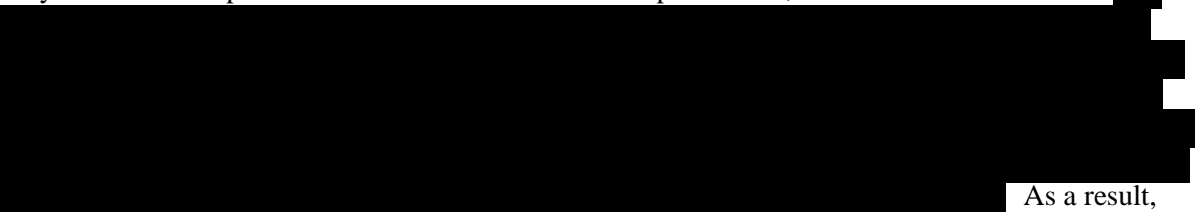


**Figure 5-3: Manchester / Barbour Hill Subarea Alternative A Upgrades**



**Figure 5-4: Manchester / Barbour Hill Subarea Alternative B Upgrades**

It should be noted that some of the upgrades proposed as part of these two alternative solutions are for the purposes of relieving constraints on the Connecticut Import transmission interface following the implementation of either solution. Initial development of the alternative solutions for this subarea only included Component #1 of Alternative A and Components #2, 5 and 6 for Alternative B.



As a result, upgrades were added to both alternatives (Components #3 and 4 of Alternative A and Component #4 of Alternative B) in order to prevent any adverse impact on CT Import capability under post-project conditions. A summary of the observed CT Import transfer levels with and without the Manchester-Barbour Hill alternative solutions in place is included in Table 5-2. More details on this can be found in Appendix G: Transfer Analysis Testing Results.

**Table 5-2: Summary of CT Import Transfer Levels Following Implementation of Manchester – Barbour Hill Alternative Solutions**

Manchester – Barbour Hill Subarea Solution Alternative	CT Import Upgrades Included?	CT Import Level (MVA)		Delta (MW)	Limiting Constraint	Contingency
		Pre-Project	Post-Project			
Alternative A	No	1,793	1,202	-591		
Alternative A	No	1,793	1,756	-37		
Alternative A	Yes	1,793	2,444	+651		
Alternative B	No	1,793	1,770	-23		
Alternative B	Yes	1,793	2,501	+708		

### 5.3.2 Northwestern Connecticut Subarea

The Northwestern Connecticut (NWCT) subarea consists of about 511 MW of load including demand resources in 2022. The area has one generator at Forestville at 17 MW which is classified as a regular generator and a hydro station (Falls Village) that has a total qualified capacity of about 3 MW. The hydro station is dispatched to 10% of its nameplate capacity (9 MW) at 0.9 MW, based on historical performance data for hydroelectric generation in the area during summer peak load conditions. The subarea also has two fast start generators at Franklin Drive and Torrington Terminal that total to 31 MW.

#### 5.3.2.1 Northwestern Connecticut Subarea Needs Assessment Results

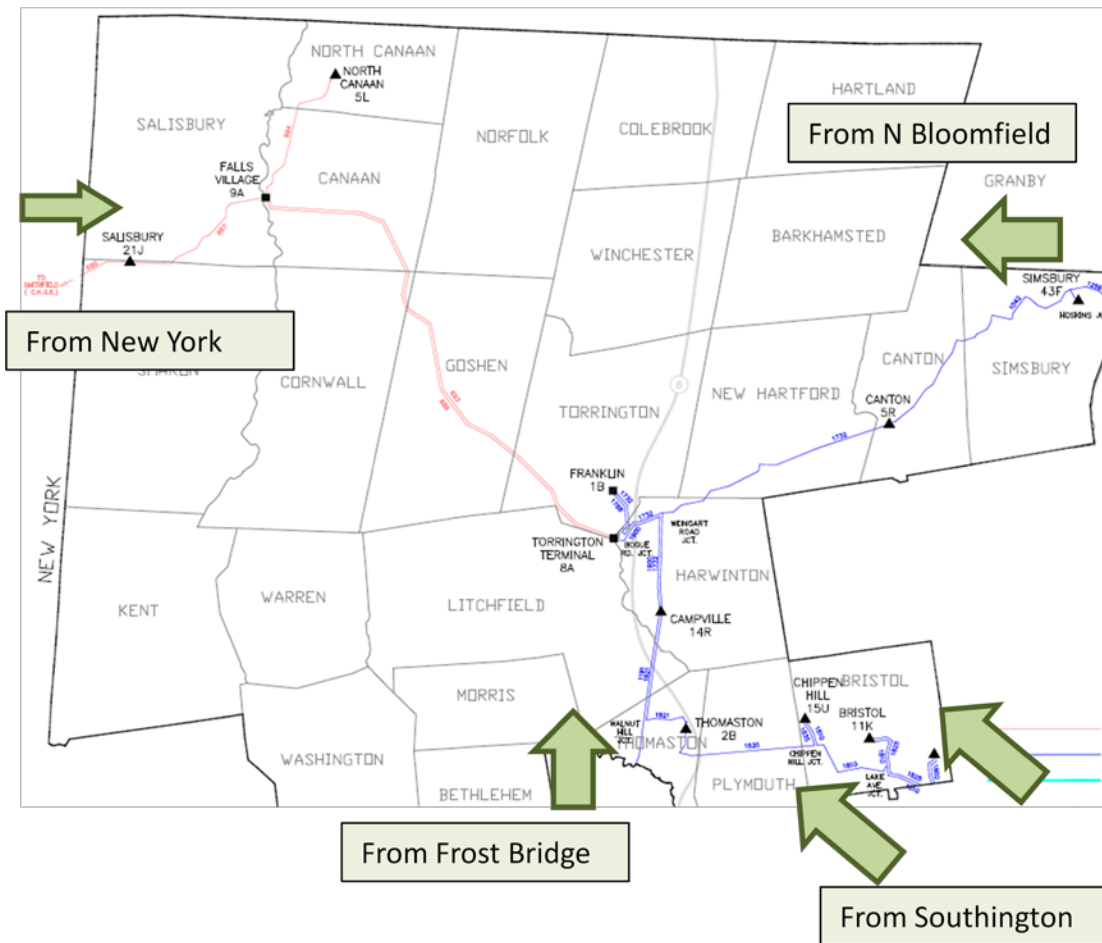
Looking at the load and generation it can be observed that the Northwestern Connecticut subarea is a net importer of energy and relies on the surrounding areas to serve local load. The major transmission elements that feed this subarea are:

- Two 115 kV lines from Southington (Line 1810 and 1800):
  - 1800: Southington – Forestville
  - 1810: Southington – Chippen Hill – Bristol
- A 115 kV line from N Bloomfield (Line 1256):
  - 1256: North Bloomfield – Northeast Simsbury
- A 115 kV line from Frost Bridge (Line 1191):
  - 1191: Frost Bridge – Chippen Hill
- A 69 kV line from New York (Line 690):
  - 690: Smithfield substation in NY to Salisbury substation in CT

\_\_\_\_\_

■ [REDACTED]

■ [REDACTED]



**Figure 5-5: Northwestern Connecticut Subarea Existing Geographic One-Line**

The worst-case criteria violations were observed

[REDACTED]

The criteria violations observed under N-1-1 conditions are almost identical with one or two units OOS.

In addition to the N-1-1 issues, some N-1 and N-0 criteria violations were also observed in the Northwestern Connecticut subarea.

[REDACTED]

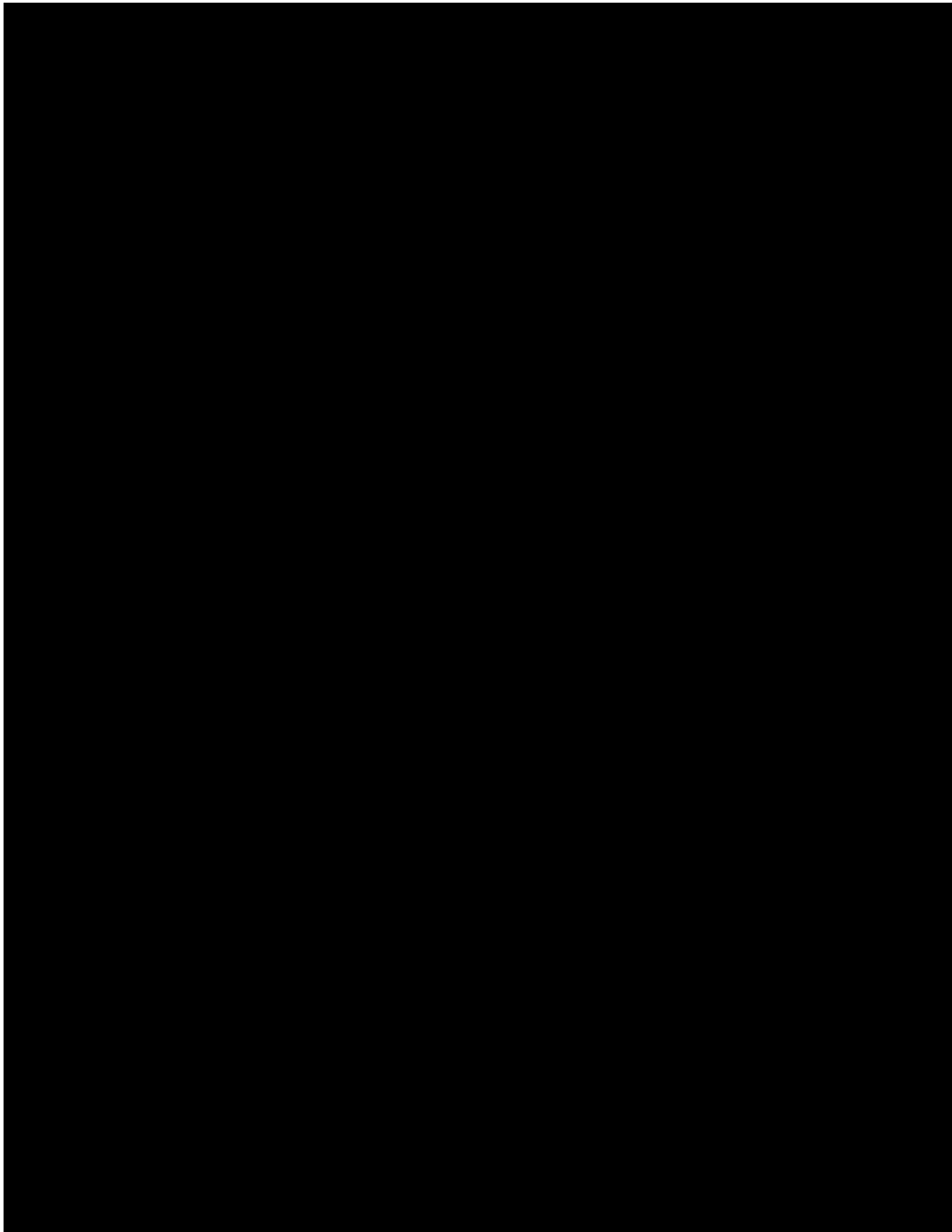
### 5.3.2.2 Northwestern Connecticut Subarea Alternative Solutions

Two local solution alternatives were developed to solve the violations in the Northwestern Connecticut subarea. A third alternative solution, which consisted of a new 115 kV line from North Bloomfield to Campville as well as additional minor upgrades, was analyzed as well. However, this

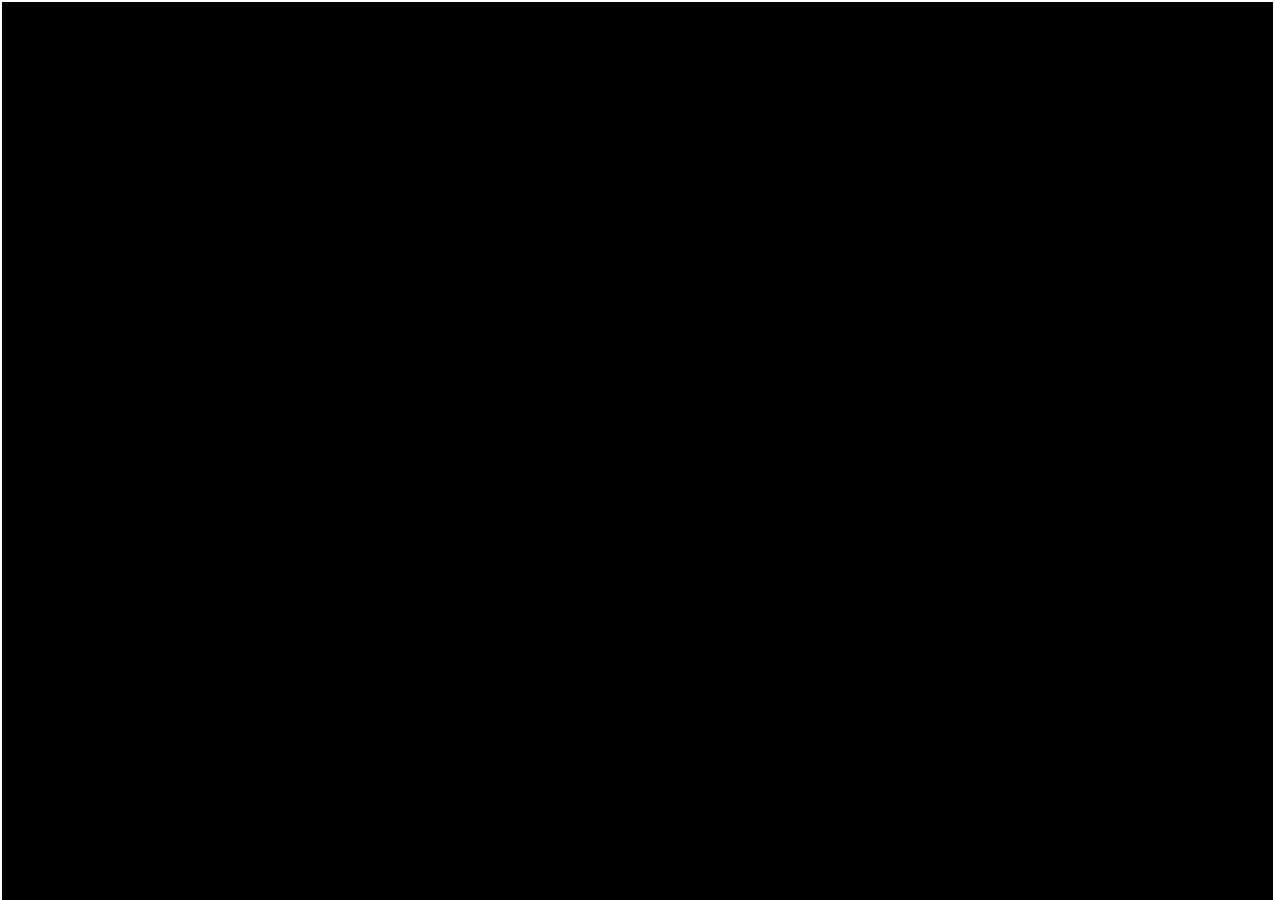
alternative proved to be very cost-prohibitive and was eliminated in favor of a plan that features the construction of a new 115 kV line between North Bloomfield and Canton and other minor upgrades. Both Alternative A and Alternative B provide a new 115 kV source into the subarea, as well as resolve all additional violations not addressed by the new 115 kV source. The two different solution alternatives are summarized in Table 5-3 below.

**Table 5-3: Northwestern Connecticut Subarea Solution Alternatives**

Component ID	Description	Included in Alternative A	Included in Alternative B
1	Add a new 10.35 mile, 115 kV line from Frost Bridge to Campville and associated terminal equipment	Y	
2	Add a new 12.80 mile, 115 kV line from North Bloomfield to Canton and associated terminal equipment		Y
3	Separation of 115 kV DCT corresponding to the Frost Bridge to Campville (1191) line and the Thomaston to Campville (1921) line and add a breaker at Campville 115 kV substation	Y	
4	Upgrade terminal equipment on the 115 kV line between Chippen Hill and Lake Avenue Junction (1810-3)	Y	Y
5	Reconductor the 115 kV line between Southington and Lake Avenue Junction (1810-1) – 5.2 miles		
6	Add a 25.2 MVAR capacitor at Campville substation		Y



**Figure 5-6: Northwestern Connecticut Alternative A Upgrades**



**Figure 5-7: Northwestern Connecticut Alternative B Upgrades**

### **5.3.3 Middletown Subarea**

The Middletown subarea consists of about 656 MW of load including demand resources in 2022. The area has two generators totaling to about 353 MW (Middletown 2 and 3) that may be classified as regular generators and two generators (Middletown 10 and Branford 10) totaling to about 33 MW that are classified as fast-start units.

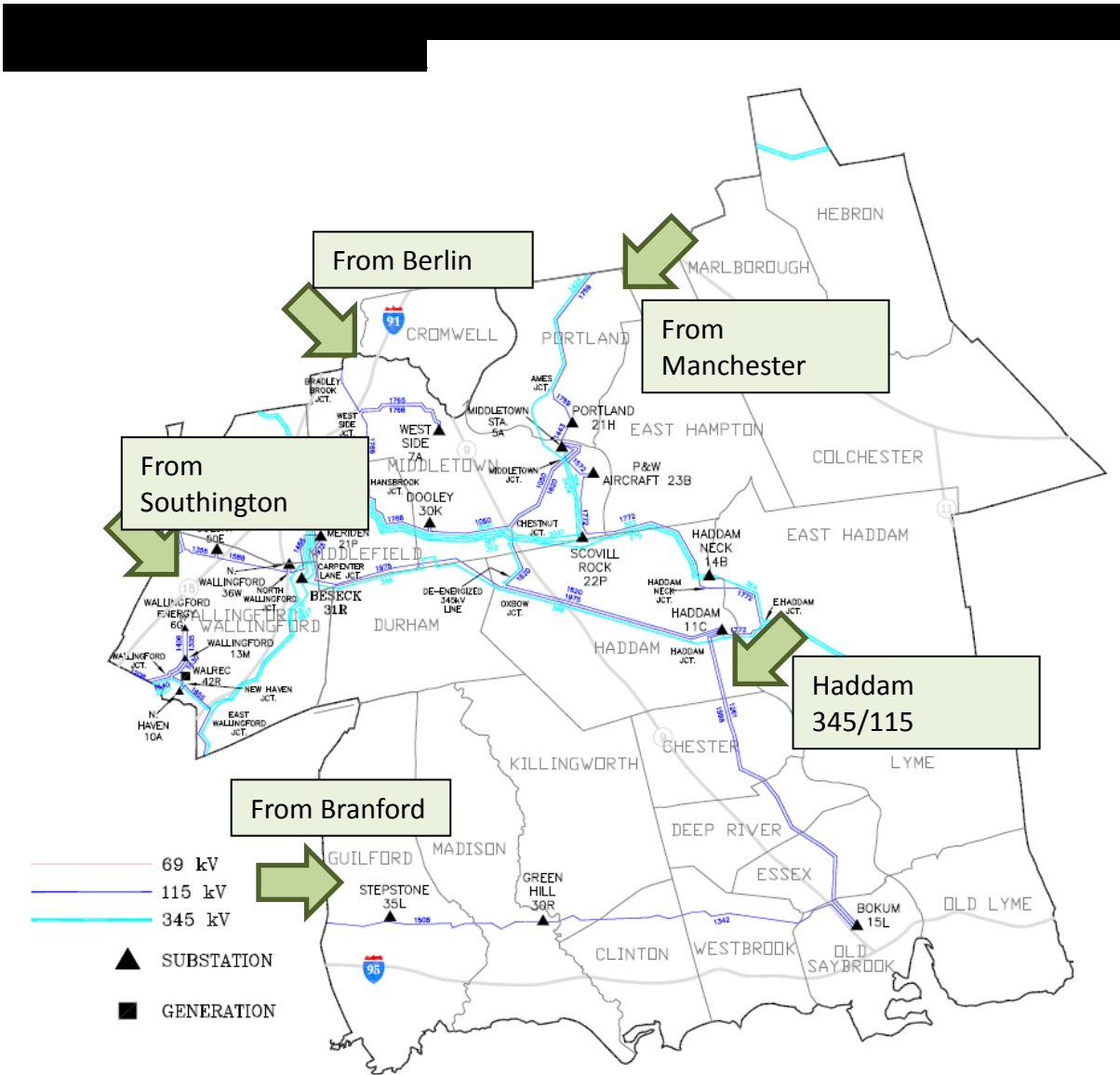
#### **5.3.3.1 Middletown Subarea Needs Assessment Results**

The GHCC Needs Assessment observed that the Middletown subarea does depend on the surrounding areas to serve the local load, but has a substantial amount of local generation which reduces the need for import capability when all units are available.

The major transmission elements that feed this subarea are:

- A 345/115 kV autotransformer at Haddam (Haddam 6X)
- A 115 kV line from Southington to Colony (Line 1355)
- A 115 kV line from Manchester to Hopewell (Line 1767)
- A 115 kV line from Branford to Stepstone (Line 1738)
- A 115 kV line from Berlin to Westside (Line 1765)





**Figure 5-8: Middletown Subarea Existing Geographic One-Line**

A smaller load pocket between Haddam and Branford on the 115 kV network experiences some violations for all the dispatches. This load pocket consists of four substations totaling 180 MW of load including demand resources.

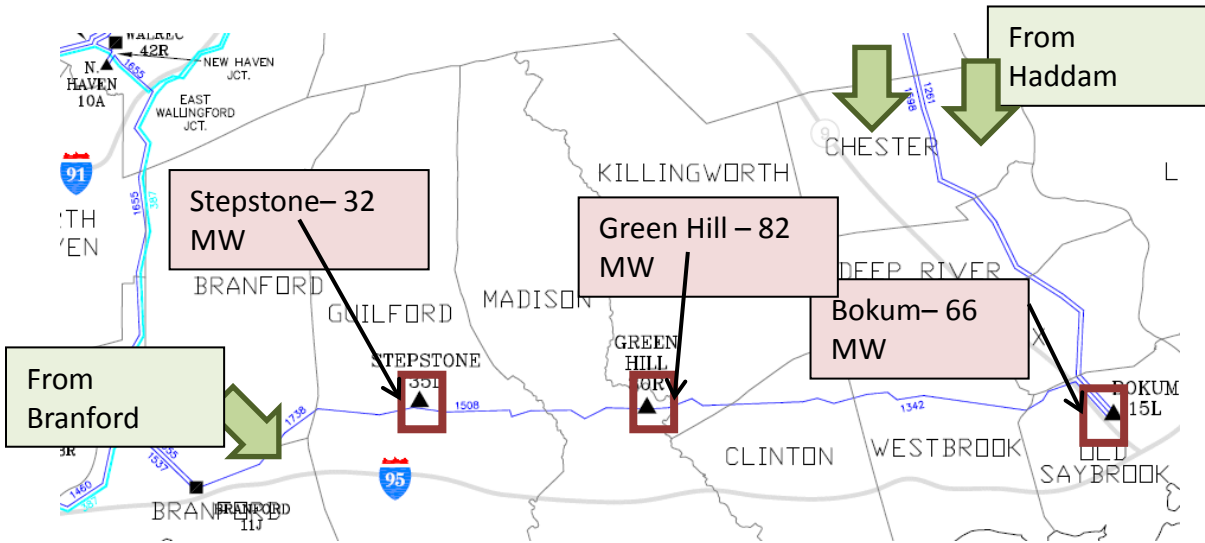
The dispatch of other regular units has an insignificant impact on these violations.

This load pocket is fed by:

- Two 115 kV lines from Haddam to Bokum (Line 1261 and 1598)
- One 115 kV line from Branford - Stepstone (Line 1738)

Thermal and voltage violations were observed under N-1 and N-1-1 conditions when load was fed radially out of Haddam under contingency conditions.





**Figure 5-9: Branford - Haddam Load Pocket**

[REDACTED]

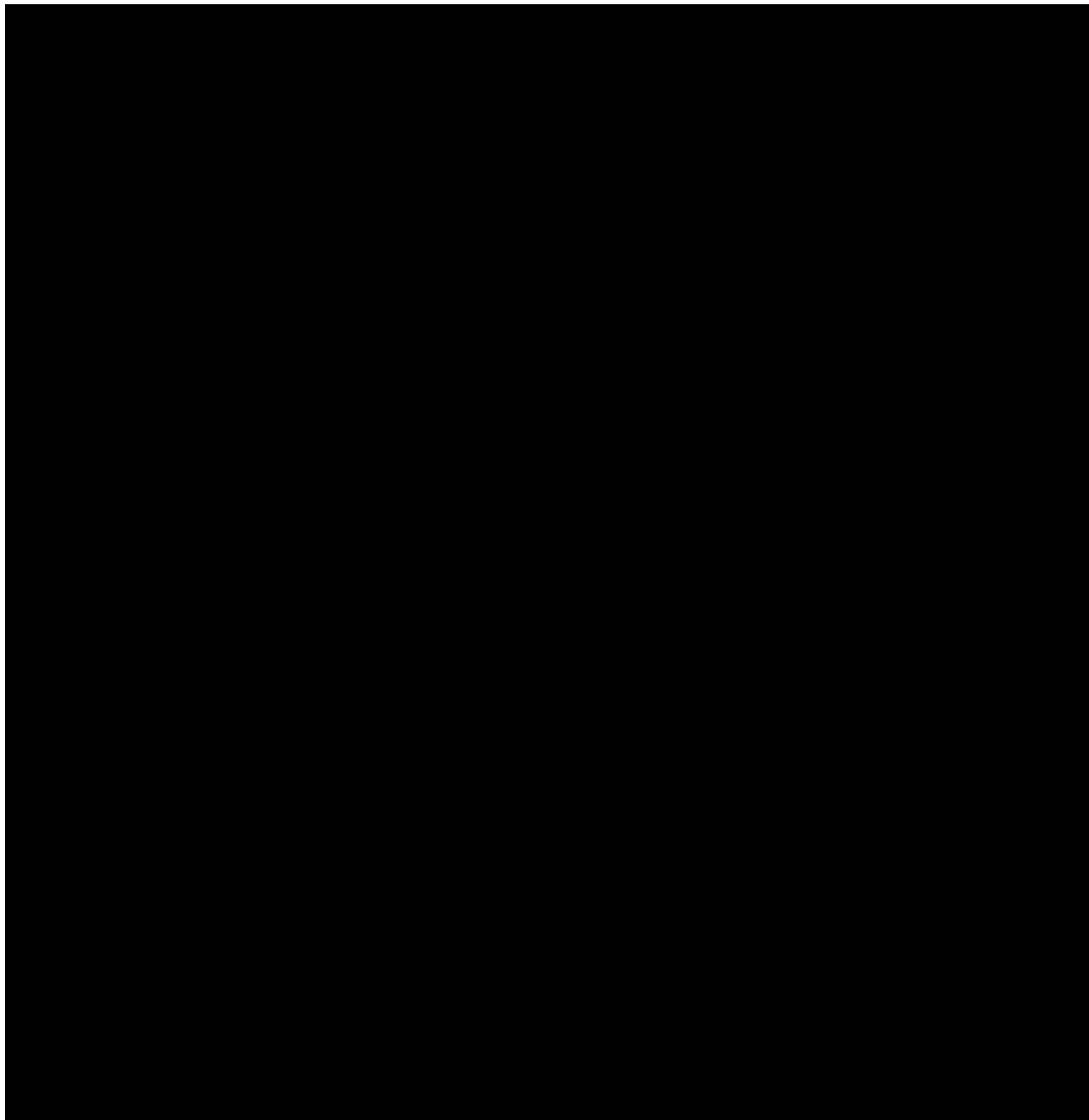
[REDACTED]

**5.3.3.2 Middletown Subarea Alternative Solutions**

Two local solution alternatives were developed to solve the observed violations in the Middletown subarea. Both alternatives, described and summarized in Table 5-4 below, provide a new step-down connection from the 345 kV transmission network into the subarea. Additional minor upgrades were added to each plan to address all remaining violations that the new autotransformers did not.

**Table 5-4: Middletown Subarea Solution Alternatives**

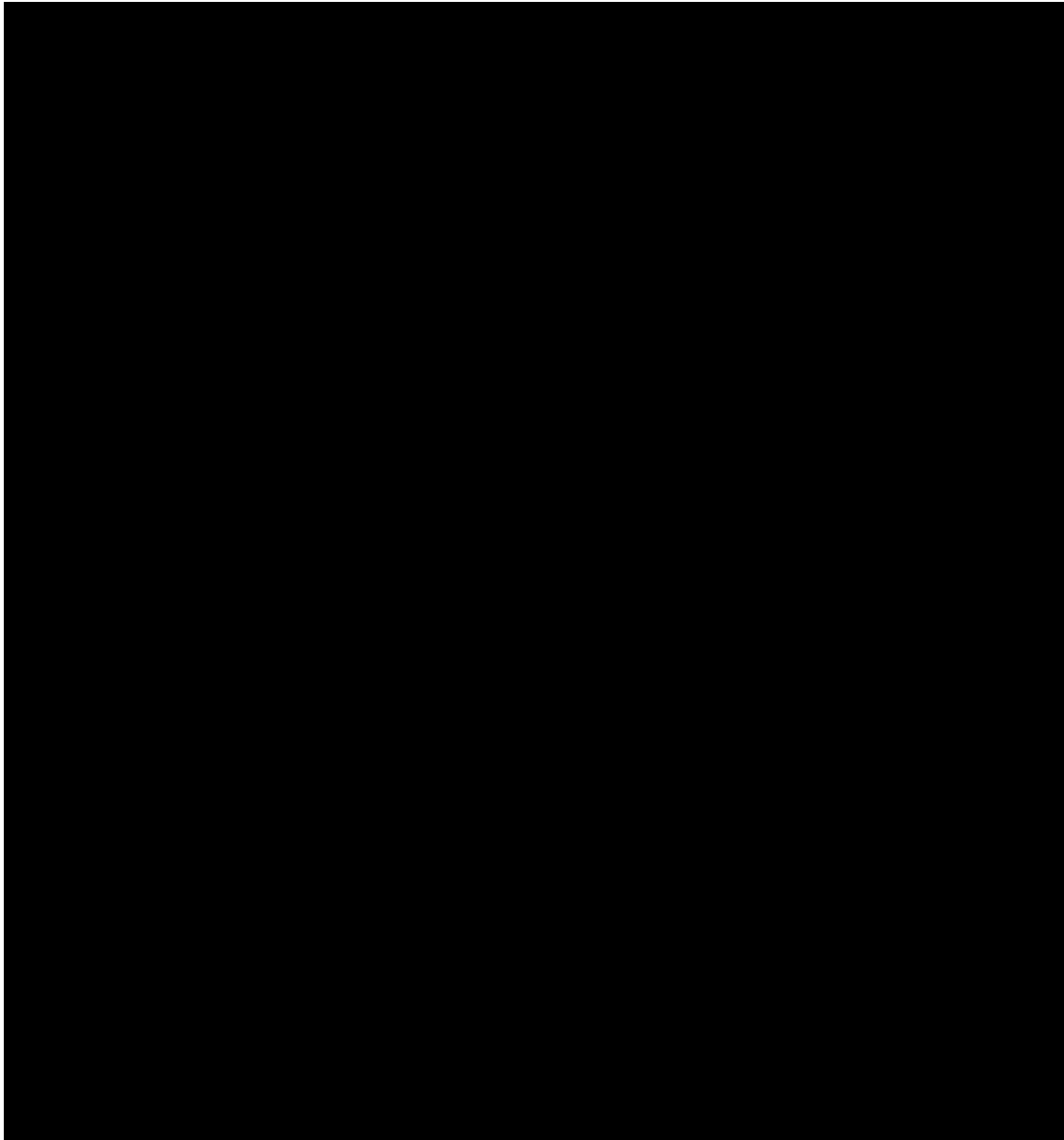
Component ID	Description	Included in Haddam Auto Alternative	Included in Scovill Rock Alternative
1	Add a 2nd 345/115 kV autotransformer at Haddam substation and reconfigure the 3-terminal 345 kV 348 line into 2 two-terminal lines	Y	
2	Add a new 345/115 kV autotransformer at Scovill Rock substation and add a 3.3 mile 115 kV line from Scovill Rock to Middletown substation including associated terminal equipment		Y
3	Terminal equipment upgrades on the 345 kV line between Haddam and Beseck (362)	Y	Y
4	Separation of 115 kV double circuit towers corresponding to the Branford – Branford RR line (1537) and the Branford to North Haven (1655) line and adding a series breaker at Branford 115 kV substation	Y	Y
5	Terminal Equipment upgrades on the Middletown to Dooley Line (1050)	Y	Y
6	Terminal Equipment upgrades on the Middletown to Portland Line (1443)	Y	Y
7	Redesign the Green Hill 115 kV substation from a straight bus to a ring bus and add a 37.8 MVAR capacitor bank	Y	Y
8	Add a 37.8 MVAR capacitor bank at Hopewell 115 kV substation	Y	
9	Eliminate sag limit on the 115 kV line between Colony and Lucchini Junction (1355-1)		Y
10	Reconductor the 115 kV line between North Wallingford and Colony (1588) – 2.6 miles		Y
11	Upgrade the 115 kV line between Southington and Lucchini Junction (1355-3) - 4.6 miles		Y
12	Separation of 115 kV double circuit towers corresponding to the Middletown – Pratt and Whitney line (1572) and the Middletown to Haddam (1620) line	Y	
13	Add a 37.8 MVAR capacitor bank at Haddam 115 kV substation		Y



**Figure 5-10: Middletown Subarea Haddam Autotransformer Alternative Upgrades**



**Figure 5-11: Middletown Subarea Scovill Rock Autotransformer Alternative Upgrades**



**Figure 5-12: Middletown Subarea Scovill Rock Autotransformer Alternative Upgrades (Cont'd.)**

### **5.3.4 Greater Hartford Subarea**

The Greater Hartford subarea net load for 2022 after demand resources are subtracted is about 1,227 MW of load. The area has three generators totaling to about 103 MW that may be classified as regular units and four generators totaling to about 149 MW that are classified as fast-start units.

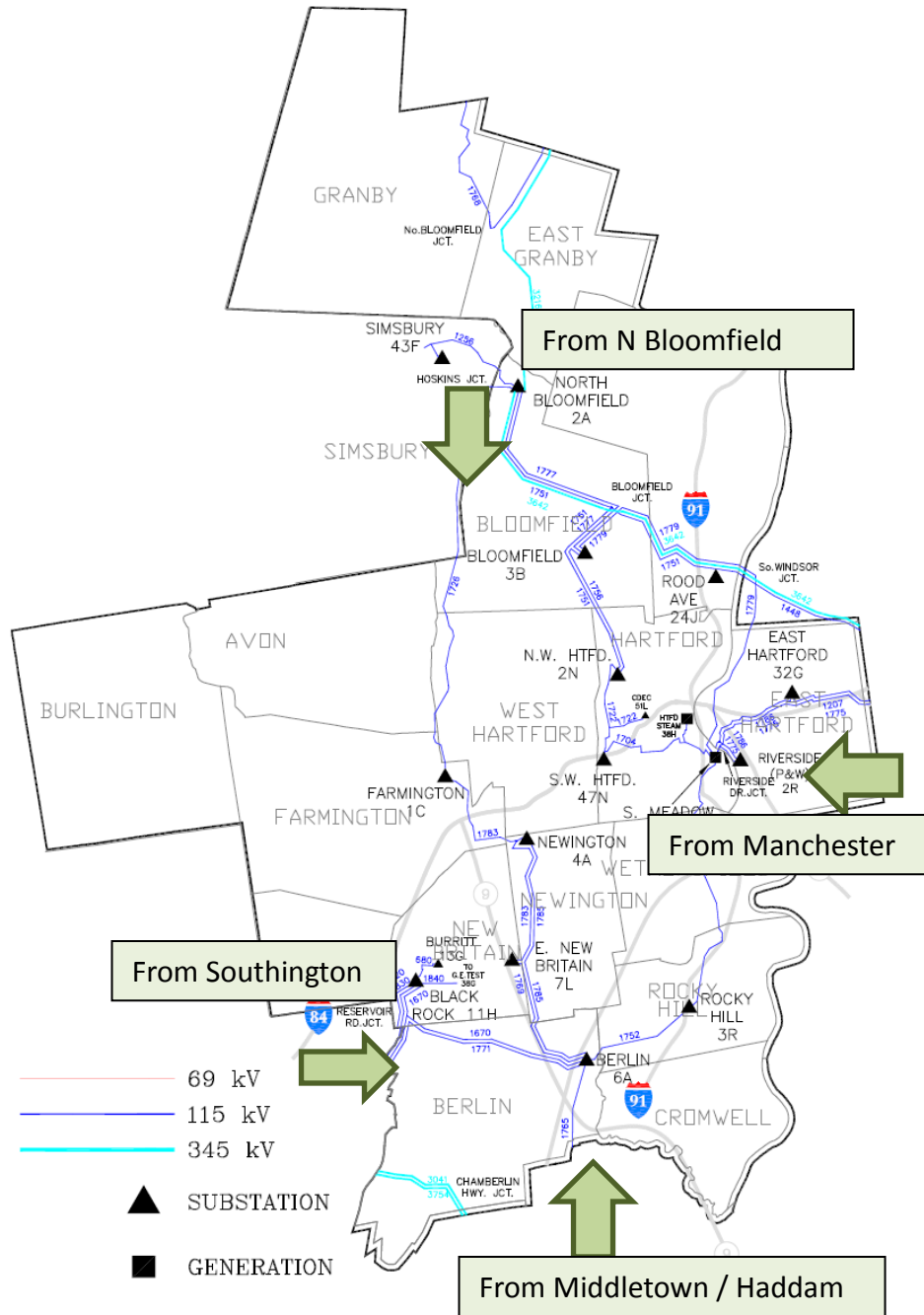
#### **5.3.4.1 Greater Hartford Subarea Needs Assessment Results**

As stated in the GHCC Needs Assessment report, it can be observed that the Greater Hartford area is a net importer of energy and relies on the surrounding areas to serve local load. The major 115 kV lines that feed this subarea are:

- Three 115 kV lines from North Bloomfield (Lines 1726, 1751, and 1777)
  - 1726: North Bloomfield – Farmington
  - 1751: North Bloomfield – Northwest Hartford – Rood Avenue
  - 1777: North Bloomfield – Bloomfield
- Three 115 kV lines from Manchester (Lines 1207, 1448 and 1775)
  - 1207: Manchester – East Hartford
  - 1448: Manchester – Rood Avenue
  - 1775: Manchester – Riverside Drive – South Meadow
- Two 115 kV lines from Southington (Lines 1670 and 1771)
  - 1670: Southington – Black Rock – Berlin
  - 1771: Southington – Berlin
- One 115 kV line from Middletown (Line 1765)
  - 1765: Westside – Berlin



There were no N-0 violations.

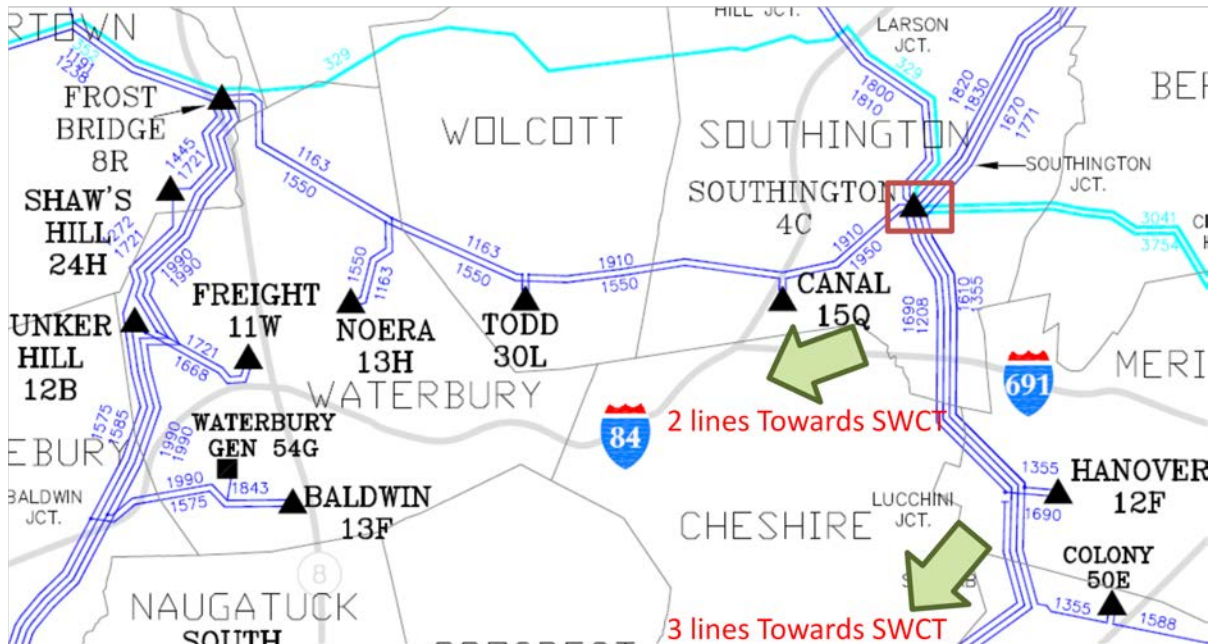


**Figure 5-13: Greater Hartford Subarea Existing Geographic One-Line**

The needs in the Greater Hartford subarea were further divided into three areas: Southington, North Bloomfield – Manchester; and South Meadow – Berlin. A single solution that would be common to all solutions for the entire subarea was developed for Southington. Two major alternatives for addressing weaknesses in the other two areas, which together make up the rest of the Greater Hartford subarea, were developed.

**5.3.4.2 Southington Area Common Solution**

The Southington substation has five 115 kV facilities that are a part of the SWCT import interface. There are 4 autotransformers at Southington that feed into these SWCT import lines. The violations seen in this area are all thermal violations.



**Figure 5-14: Southington Substation and SWCT Import Interface**

The Southington common solutions involve improvements to both the 345 kV and 115 kV portions of the Southington substation.



**Table 5-5: Southington Area Common Solution Upgrades**

Component ID	Description
S1	Replace the existing 3% series reactors on the 115 kV lines between Southington and Todd (1910) and between Southington and Canal (1950) with 5% series reactors
S2	Replace the normally open 19T breaker at Southington with a 3% series reactor between Southington Ring 1 and Southington Ring 2 and associated substation upgrades
S3	Add a breaker in series with breaker 5T at the Southington 345 kV switchyard
S4	Add a new control house at Southington 115 kV substation



**Figure 5-15: Southington Area Common Solution Upgrades**

### 5.3.4.3 Rest of Greater Hartford Subarea

As noted, the rest of the Greater Hartford Subarea consists of two separate load pockets, the South Meadow and Berlin area and the North Bloomfield – Manchester area. Solutions that would address the needs in both load pockets were developed.

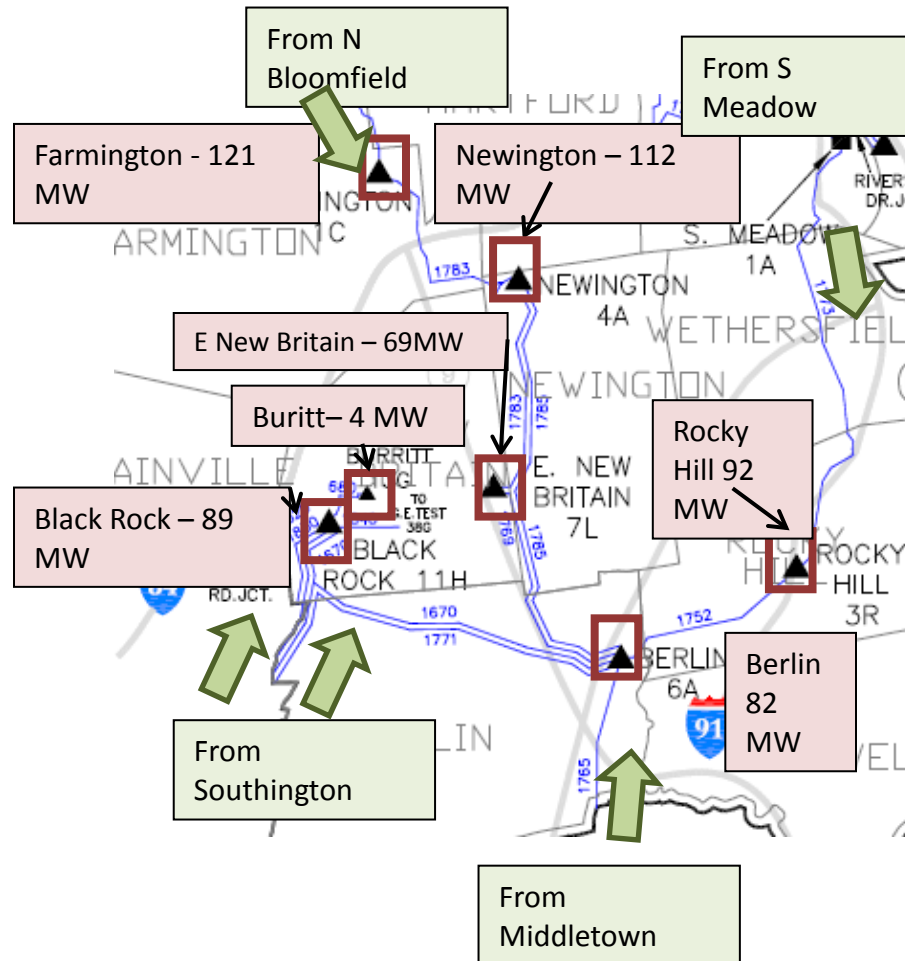
#### 5.3.4.3.1 South Meadow and Berlin Area Needs

This area has a 2022 load of about 569 MW after DR loads are subtracted. The load is distributed across seven substations. This load pocket is served by five 115 kV lines:

- Two 115 kV lines from Southington to Berlin (Lines 1670 and 1771)
- A 115 kV line from North Bloomfield to Farmington (Line 1726)
- A 115 kV line from South Meadow to Rocky Hill (Line 1773)

- A 115 kV line from Westside towards Berlin (Line 1765)

There is no generation located within this load pocket;

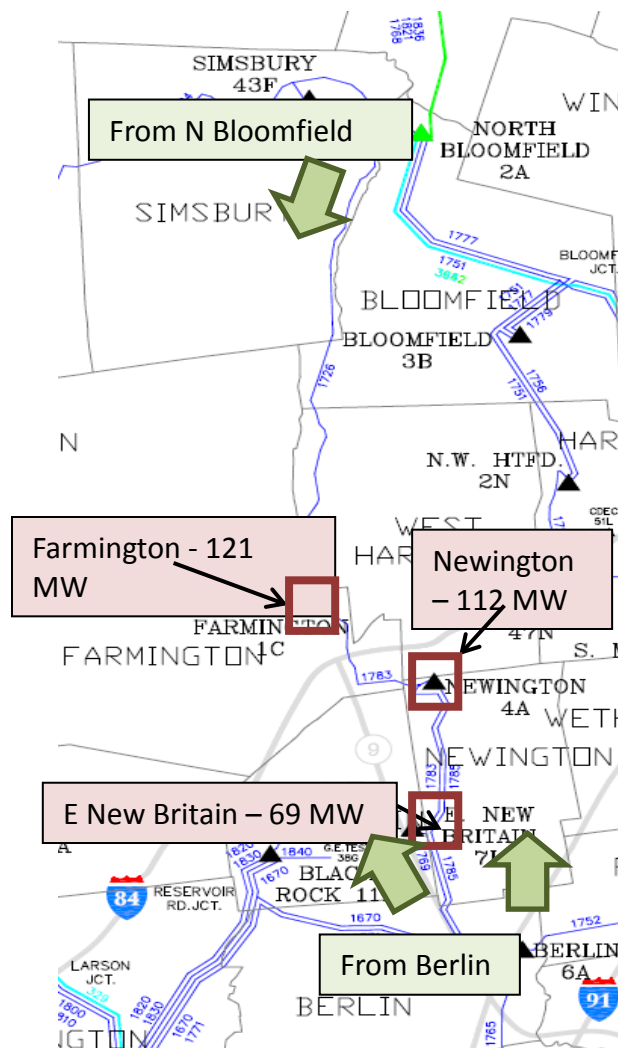


**Figure 5-16: South Meadow, Berlin and Southington Load Area**

Within this load area is the Farmington, Newington and East New Britain load pocket. This load pocket has a net load of 302 MW for 2022 after DR loads are subtracted. The load is distributed across three 115 kV substations. This load pocket served by three 115 kV lines:

- A 115 kV line from North Bloomfield to Farmington (Line 1726)
- A 115 kV line from Berlin to Newington (Line 1785)
- A 115 kV line from Berlin to East New Britain (Line 1769)





**Figure 5-17: Farmington, Newington and East New Britain Load Pocket**

### 5.3.4.3.2 North Bloomfield – Manchester Area Needs

This area is bound by feeds from North Bloomfield and Manchester and is served by five 115 kV lines:

- A three-terminal 115 kV line from North Bloomfield to Northwest Hartford to Rood Avenue (Line 1751)
- A 115 kV line from North Bloomfield to Bloomfield (Line 1777)
- A three terminal 115 kV line from Manchester – Riverside – South Meadow (Line 1775)
- A 115 kV line from Manchester – East Hartford (Line 1207)
- A 115 kV line from Manchester – Rood Avenue (Line 1448)

CDECCA generation and South Meadow generation are located at the center of this area



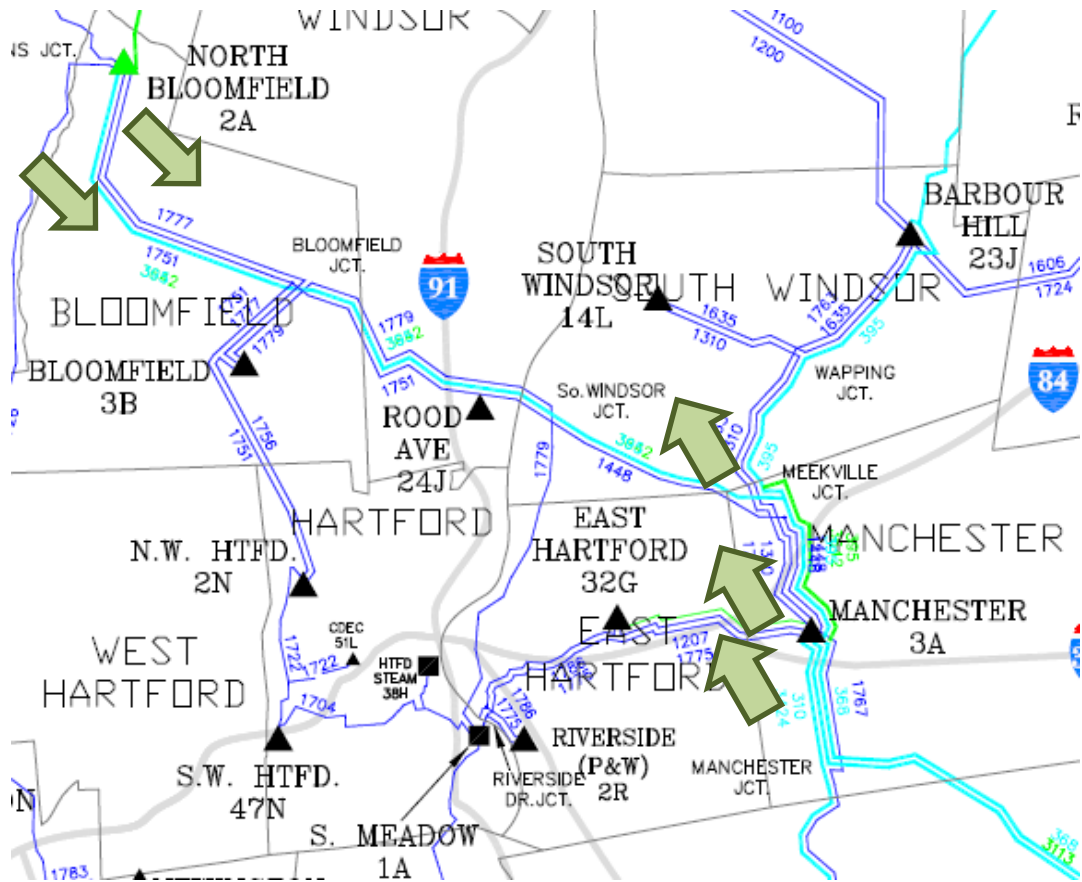


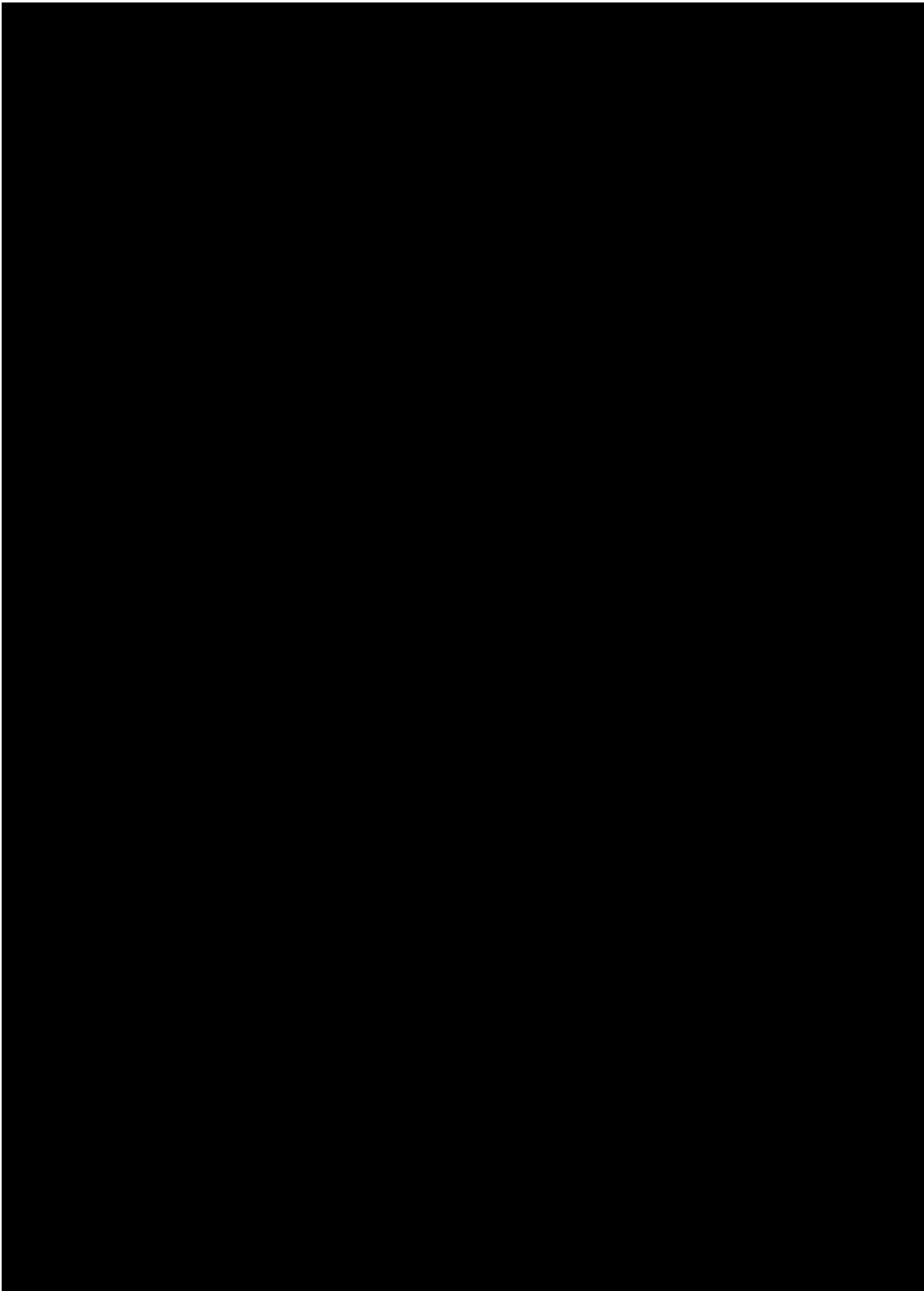
Figure 5-18: North Bloomfield - Manchester Area

### 5.3.4.3.3 Rest of Greater Hartford Solutions

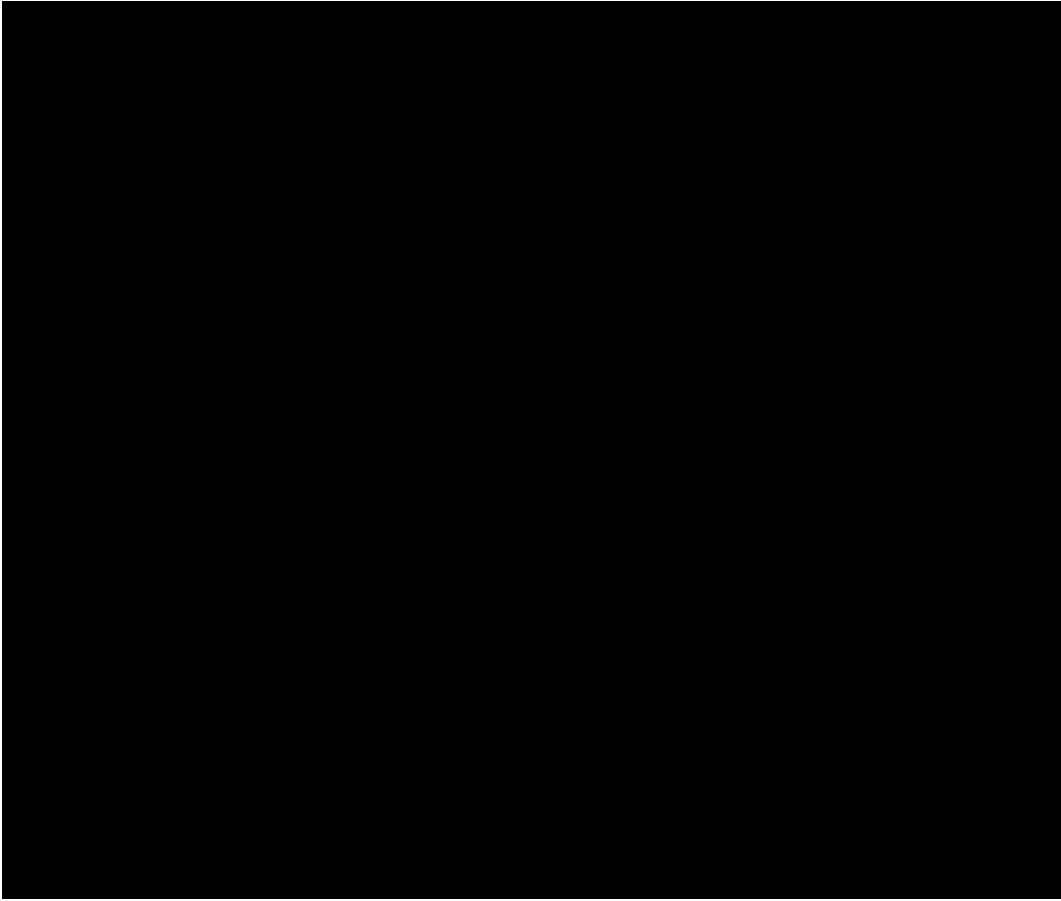
The violations in the two load pockets (excluding the Southington area) that make up the rest of the Greater Hartford subarea could be addressed by the solution alternatives described in Table 5-6. The two major alternative components provide a new 115 kV transmission source into the subarea via a new underground cable or overhead line, as well as address the remaining violations that exist with the addition of either of the two alternatives. The two sets of solutions are denoted by their major components (“Underground Line” or “Overhead Line”):

**Table 5-6: Rest of Greater Hartford Subarea Solution Alternatives**

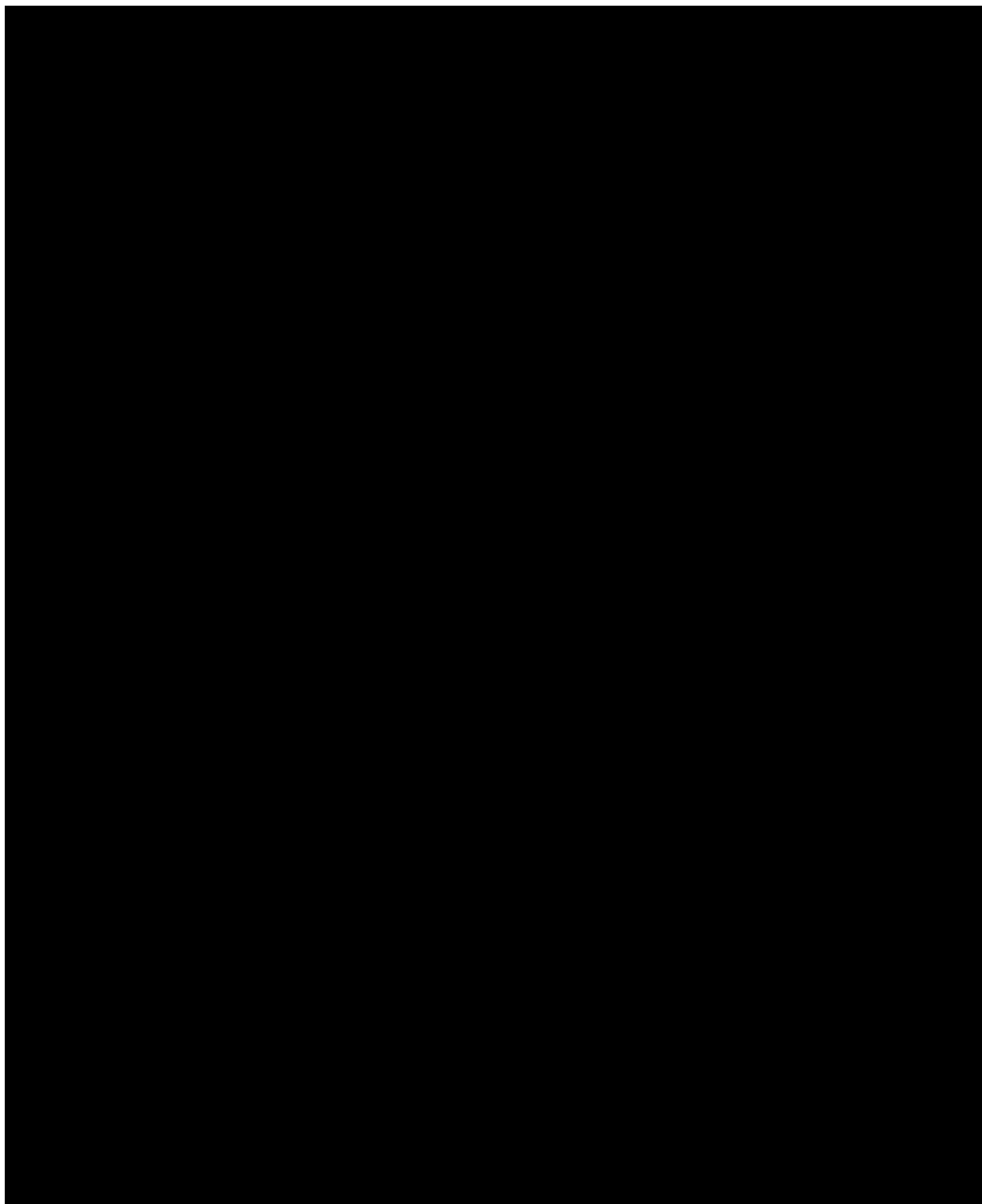
Component ID	Description	Included in Underground Line Alternative	Included in Overhead Line Alternative
1	Add a new 4 mile 115 kV underground cable from Newington to Southwest Hartford and associated terminal equipment including a 2% series reactor	Y	
2	Add a new 11.67 mile 115 kV line from North Bloomfield to Farmington and associated terminal equipment		Y
3	Loop the 1779 line between South Meadow and Bloomfield into the Rood Avenue substation and reconfigure the Rood Avenue substation	Y	Y
4	Reconfigure the Berlin 115 kV substation including the addition of two 115 kV breakers and the relocation of a capacitor bank	Y	Y
5	Add a 115 kV 25.2 MVAR capacitor at Westside 115 kV substation	Y	Y
6	Reconductor the 115 kV line between Newington and Newington Tap (1783) – 0.01 miles	Y	Y
7	Separation of 115 kV DCT corresponding to the Bloomfield to South Meadow (1779) line and the Bloomfield to North Bloomfield (1777) line and add a breaker at Bloomfield 115 kV substation	Y	Y
8	Install a 115 kV 3% reactor on the underground cable between South Meadow and Southwest Hartford(1704)	Y	Y
9	Separation of 115 kV DCT corresponding to the Bloomfield to North Bloomfield (1777) line and the North Bloomfield – Rood Avenue – Northwest Hartford (1751) line and add a breaker at North Bloomfield 115 kV substation	Y	Y
10	Terminal upgrades on the 115 kV line between South Meadow and Rocky Hill		Y
11	Upgrade the 115 kV line between Farmington and Newington Tap (1783) – 3.61 miles		Y



**Figure 5-19: Rest of Greater Hartford Underground Line Alternative Upgrades**

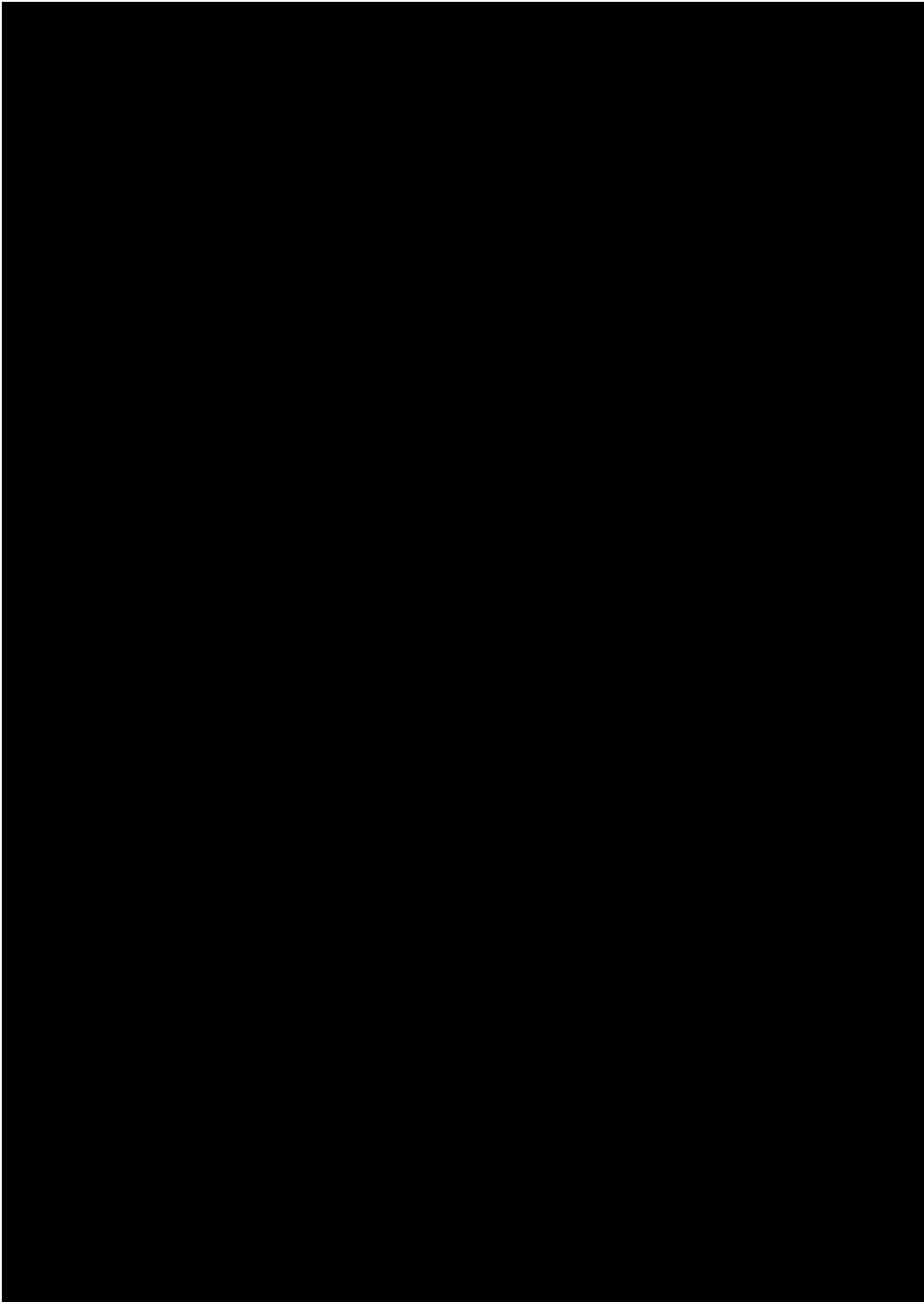


**Figure 5-20: Rest of Greater Hartford Underground Line Alternative Upgrades  
(Cont'd.)**



**Figure 5-21: Rest of Greater Hartford Overhead Line Alternative Upgrades**





**Figure 5-22: Rest of Greater Hartford Overhead Line Alternative Upgrades (Cont'd.)**

### **5.3.5 Western Connecticut Import Interface**

The Western Connecticut Import interface is made up of the transmission elements listed in Table 3-9. The alternative solutions to the local area load serving problems in the Greater Hartford subarea were designed to include elements that would also relieve congestion on the Western Connecticut Import interface. Both the Overhead Line and Underground Line alternatives for the Greater Hartford

subarea would add a new 115 kV element to the interface. Additionally, terminal equipment upgrades to the 362 line at either Haddam Neck or Beseck would increase the capacity of an existing element of the interface. These improvements are the major contributors to an increase in transfer capacity that eliminates all of the pre-project violations that were associated with high Western Connecticut Import levels or driven by the contingency loss of lines across the Western Connecticut Import interface.

# Section 6

## Alternative Solution Performance Testing and Results

All results presented in this section were derived based on the criteria and assumptions identified in Section 3. Since it was determined that the needs for each study subarea were relatively independent of those in the other subareas, each alternative solution was first tested independently of the others to ensure that it resolved all known thermal and voltage criteria violations in its respective subarea. Once the preferred solution alternative for each subarea was selected, the four preferred solution alternatives were studied all at once to ensure that their concurrent implementation did not create any unforeseen criteria violations. The preferred GHCC solution was tested alongside the preferred transmission solution set for the Southwestern Connecticut area; the results of this testing are discussed in the following sections.

### 6.1 Steady State Performance Results

The alternative solutions described in this report all resolved the thermal and voltage criteria violations in their respective study subareas and eliminated criteria violations associated with constraints on the Western Connecticut Import interface. A description of the results of the alternatives is described in the following sections. Detailed steady state analysis results can be found in Appendix E: Steady State Testing Results.

#### 6.1.1 N-0 Thermal and Voltage Performance Summary

N-0 study indicated no violations found.

#### 6.1.2 N-1 Thermal and Voltage Performance Summary

The N-1 study of the GHCC preferred solutions found two remaining thermal violations in the northwestern Connecticut subarea, as summarized in Table 6-1.

**Table 6-1: GHCC and SWCT Preferred Solutions N-1 Thermal Violations Summary**

Study Subarea	Circuit ID	kV	Stations	Worst Dispatch	Worst Contingency	Worst Loading (%LTE)
NWCT	1825	115	Bristol - Forestville	[REDACTED]	[REDACTED]	114.15%
NWCT	690	69	Salisbury – Smithfield (NY)	[REDACTED]	[REDACTED]	230.94%

The N-1 study of the GHCC preferred solutions found eight remaining voltage violations in the study area, as summarized in Table 6-2.

**Table 6-2: GHCC and SWCT Preferred Solutions N-1 Voltage Violations Summary**

Study Subarea	Substation	kV	Worst Dispatch	Worst Contingency	Worst Voltage (p.u.)
Middletown	Hanover	115	[REDACTED]	[REDACTED]	0.7697
Manchester / Barbour Hill	Scitico	115	[REDACTED]	[REDACTED]	0.9413
NWCT	Canton	115	[REDACTED]	[REDACTED]	0.9031
NWCT	Forestville	115	[REDACTED]	[REDACTED]	0.9193
NWCT	Torrington Terminal	115	[REDACTED]	[REDACTED]	0.5796
NWCT	Falls Village	69	[REDACTED]	[REDACTED]	0.5784
NWCT	North Canaan	69	[REDACTED]	[REDACTED]	0.5648
NWCT	Salisbury	69	[REDACTED]	[REDACTED]	0.8009

### 6.1.3 N-1-1 Thermal and Voltage Performance Summary

The N-1-1 study of the GHCC preferred solutions found one remaining thermal violation in the study area, as summarized in Table 6-3.

**Table 6-3: GHCC and SWCT Preferred Solutions N-1 Thermal Violations Summary**

Study Subarea	Circuit ID	kV	Stations	Worst Dispatch	Line Out	Worst Contingency	Worst Loading (%LTE)
NWCT	1825	115	Bristol - Forestville	[REDACTED]	[REDACTED]	[REDACTED]	114.18%

[REDACTED]

The N-1-1 study of the GHCC preferred solutions found two remaining voltage violations in the study area, as summarized in Table 6-4

**Table 6-4: GHCC and SWCT Preferred Solutions N-1-1 Voltage Violations Summary**

Study Subarea	Substation	kV	Worst Dispatch	Line Out	Worst Contingency	Worst Voltage (p.u.)
NWCT	Canton	115				0.9041
NWCT	Forestville	115				0.9189



**Table 6-5: GHCC and SWCT Preferred Solutions N-1-1 Non-Converged Scenarios**

Study Subarea	Line Out	Contingency	Dispatch
NWCT			ALL
NWCT			ALL
NWCT			ALL
NWCT			ALL

#### 6.1.4 Results of Extreme Contingency Testing

Extreme contingency testing did not show any concerns with inter-area impacts as a result of any the tested contingencies.

### 6.2 Stability Performance Results

---

Not applicable to this study.

### 6.3 Short Circuit Performance Results

---

After the preferred solution alternatives were selected, Northeast Utilities studied short circuit duties in the GHCC study area. Particular attention was paid to the effect that the possible replacement of the normally open 19T bus-tie breaker at Southington with a 3% series reactor would have on short circuit duties following the implementation of the preferred solution. Detailed results of the short circuit studies performed are provided in Appendix F: Short Circuit Testing Results.

#### 6.3.1 Short Circuit Performance Results

Summarized results of all three short circuit scenarios analyzed (as described in Section 3.4.6) are provided in Table 6-6.

**Table 6-6: Short Circuit Duties at Southington 115 kV Substation**

Study Scenario	Highest Duty at Southington 115 kV
1	73.4%
2	100.6%
3	81.2%

The results of the short circuit study show that the proposed replacement of the normally open bus tie at Southington with a 3% series reactor resolves all observed pre-project breaker over-duties

No other breakers in the study area had a duty over 90%, either pre- or post-project.

As a part of the GHCC and SWCT PPA study the impact of both projects on short circuit duty will be evaluated. Since the independent projects did not cause a significant change in breaker duties the combined project is not expected to cause any breaker over-duties. However, this will be verified by the PPA study.

## 6.4 Other Assessment Performance Results

### 6.4.1 Western Connecticut Import Thermal Transfer Comparative Analysis Results

All of the solution alternatives for the Greater Hartford and Middletown subareas resolved the criteria violations associated with insufficient transfer capacity across the Western Connecticut Import interface. To determine whether any of the alternatives provided significantly higher thermal transfer capabilities, a limited set of transfer analyses was completed as described in Section 3.5.1. Detailed results of the transfer analysis studies performed are provided in Appendix G: Transfer Analysis Testing Results.

Transfer analysis results of the four different solution alternative combinations are shown in Table 6-7.

**Table 6-7: WCT Import N-1-1 Thermal Transfer Comparative Analysis Results**

Middletown Solution Alternative	Greater Hartford Solution Alternative	Limiting Element	kV	Initial Line-Out	Contingency	WCT Import Limit (MW)
Haddam Auto	Underground Line	[REDACTED]	[REDACTED]	[REDACTED]	[REDACTED]	2,997
Scovill Rock Auto	Underground Line	[REDACTED]	[REDACTED]	[REDACTED]	[REDACTED]	3,025
Haddam Auto	Overhead Line	[REDACTED]	[REDACTED]	[REDACTED]	[REDACTED]	3,035
Scovill Rock Auto	Overhead Line	[REDACTED]	[REDACTED]	[REDACTED]	[REDACTED]	3,045

It should be noted that in determining the transfer levels above, certain constraints that could be resolved by adjustments between 1<sup>st</sup> and 2<sup>nd</sup> contingencies were excluded in the transfer analysis. It was assumed that back-down of local generation could be performed between the two contingencies. However, the Scovill Rock autotransformer alternative required a larger amount of re-dispatch between contingencies compared to the Haddam autotransformer alternative.

# Section 7

## Comparison of Alternative Solutions

### 7.1 Factors Used to Compare Alternative Solutions

---

When the estimated cost (+50%/-25%) accuracy was similar, the key factors used to compare the solution alternatives included:

- Better operational performance (solution alternative requires less or no re-dispatch or capacitor switching)
- Better system performance – Thermal
- Better system performance – Voltage
- Expected in-service date (ISD)
- Expected ease of permitting (e.g. environmental, siting, etc...)
- Ease of constructability (during the construction phase)
- Fewer construction outages (number and length of outages)

The siting issues took into consideration easements along existing rights-of-way as well as available space in the existing substation. Total cost estimates were used to consider differences between all solution alternatives. All of the solution alternatives provide a stronger transmission system in the study area.

### 7.2 Cost Estimates for Selected Alternative Solutions

---

All cost estimates were developed consistent with ISO-NE cost estimation procedures as defined in Attachment D of ISO Planning Procedure No. 4. All cost estimates in this report were developed with +50/-25% accuracy.

For the Manchester / Barbour Hill area, two alternatives were evaluated, designated Alternative A and Alternative B. The cost estimates for the common components of each solution are shown in Table 7-1.

**Table 7-1: Manchester / Barbour Hill Common Components Cost Estimates**

ID	Solution Component	Cost (\$M)
4	Add a 345 kV breaker in series with breaker 24T at the Manchester 345 kV switchyard	2.1
<b>Subtotal of Common Solution Components</b>		<b>2.1</b>



The following solution components shown in Table 7-2 were not common between solution alternatives and represent the differences between the two plans.

**Table 7-2: Manchester / Barbour Hill Alternative Solution Components Cost Estimates**

ID	Solution Component	Cost (\$M)	Included in Alternative A	Included in Alternative B
1	Add a new 345/115 kV autotransformer at Barbour Hill and associated terminal equipment	31.2	Y	
2	Add a new 7.6 mile, 115 kV line from Manchester to Barbour Hill	42.1		Y
3	Reconductor the 115 kV line between Manchester and Barbour Hill (1763) – 7.6 miles	13.5	Y	
5	Add two 345 kV breakers in series with breaker 18T and 19T at the Manchester 345 kV switchyard	4.1		Y
6	Add a 115 kV breaker in series with breaker 13T at the Manchester 115 kV switchyard	1.1		Y
<b>Solution Alternative Totals</b>			<b>44.7</b>	<b>47.3</b>

The next set of cost estimates shown in Table 7-3 and Table 7-4 are for the two solution alternatives in the Northwestern Connecticut subarea.

**Table 7-3: Northwestern Connecticut Common Components Cost Estimates**

ID	Solution Component	Cost (\$M)
4	Upgrade terminal equipment on the 115 kV line between Chippen Hill and Lake Avenue Junction (1810-3)	12.1
5	Reconductor the 115 kV line between Southington and Lake Avenue Junction (1810-1) – 5.2 miles	
<b>Subtotal of Common Solution Components</b>		<b>12.1</b>

**Table 7-4: Northwestern Connecticut Alternative Solution Components Cost Estimates**

ID	Solution Component	Cost (\$M)	Included in Alternative A	Included in Alternative B
1	Add a new 10.35 mile, 115 kV line from Frost Bridge to Campville and associated terminal equipment	45.5	Y	
2	Add a new 12.80 mile, 115 kV line from North Bloomfield to Canton and associated terminal equipment	66.9		Y
3	Separation of 115 kV DCT corresponding to the Frost Bridge to Campville (1191) line and the Thomaston to Campville (1921) line and add a breaker at Campville 115 kV substation	5.5	Y	
6	Add a 25.2 MVAR capacitor at Campville substation	7.0		Y
<b>Solution Alternative Totals</b>			<b>51.0</b>	<b>73.9</b>

The next set of cost estimates shown in Table 7-5 and Table 7-6 are for the two solution alternatives in the Middletown subarea.

**Table 7-5: Middletown Common Components Cost Estimates**

ID	Solution Component	Cost (\$M)
3	Terminal equipment upgrades on the 345 kV line between Haddam and Beseck (362)	0.5
4	Separation of 115 kV double circuit towers corresponding to the Branford – Branford RR line (1537) and the Branford to North Haven (1655) line and adding a series breaker at Branford 115 kV substation	2.0
5	Terminal Equipment upgrades on the Middletown to Dooley Line (1050)	0.1
6	Terminal Equipment upgrades on the Middletown to Portland Line (1443)	0.1
7	Redesign the Green Hill 115 kV substation from a straight bus to a ring bus and add a 37.8 MVAR capacitor bank	7.6
<b>Subtotal of Common Solution Components</b>		<b>10.3</b>

**Table 7-6: Middletown Alternative Solution Components Cost Estimates**

ID	Solution Component	Cost (\$M)	Included in Haddam Auto Alternative	Included in Scovill Rock Auto Alternative
1	Add a 2nd 345/115 kV autotransformer at Haddam substation and reconfigure the 3-terminal 345 kV 348 line into 2 two-terminal lines	46.7	Y	
2	Add a new 345/115 kV autotransformer at Scovill Rock substation and add a 3.3 mile 115 kV line from Scovill Rock to Middletown substation including associated terminal equipment	59.6		Y
8	Add a 37.8 MVAR capacitor bank at Hopewell 115 kV substation	4.3	Y	
9	Eliminate sag limit on the 115 kV line between Colony and Lucchini Junction (1355-1)	1.1		Y
10	Reconductor the 115 kV line between North Wallingford and Colony (1588) – 2.6 miles	6.3		Y
11	Upgrade the 115 kV line between Southington and Lucchini Junction (1355-3) - 4.6 miles	8.9		Y
12	Separation of 115 kV double circuit towers corresponding to the Middletown – Pratt and Whitney line (1572) and the Middletown to Haddam (1620) line	1.9	Y	
13	Add a 37.8 MVAR capacitor bank at Haddam 115 kV substation	4.0		Y
<b>Solution Alternative Totals</b>			<b>52.9</b>	<b>79.9</b>

The final set of cost estimates shown in Table 7-7, Table 7-8, and Table 7-9 are for the solution alternatives in the Greater Hartford subarea.

**Table 7-7: Southington Area Common Components Cost Estimates**

ID	Solution Component	Cost (\$M)
<b>S1</b>	Replace the existing 3% series reactors on the 115 kV lines between Southington and Todd (1910) and between Southington and Canal (1950) with 5% series reactors	5.2
<b>S2</b>	Replace the normally open 19T breaker at Southington with a 3% series reactor between Southington Ring 1 and Southington Ring 2 and associated substation upgrades	8.7
<b>S3</b>	Add a breaker in series with breaker 5T at the Southington 345 kV switchyard <sup>22</sup>	1.8
<b>S4</b>	Add a new control house at Southington 115 kV substation	22.6
<b>Subtotal of Common Solution Components</b>		<b>38.3</b>

**Table 7-8: Rest of Greater Hartford Area Common Components Cost Estimates**

ID	Solution Component	Cost (\$M)
<b>3</b>	Loop the 1779 line between South Meadow and Bloomfield into the Rood Avenue substation and reconfigure the Rood Avenue substation	10.7
<b>4</b>	Reconfigure the Berlin 115 kV substation including the addition of two 115 kV breakers and the relocation of a capacitor bank	4.2
<b>5</b>	Add a 115 kV 25.2 MVAR capacitor at Westside 115 kV substation	2.9
<b>6</b>	Reconductor the 115 kV line between Newington and Newington Tap (1783) – 0.01 mile	1.0
<b>7</b>	Separation of 115 kV DCT corresponding to the Bloomfield to South Meadow (1779) line and the Bloomfield to North Bloomfield (1777) line and add a breaker at Bloomfield 115 kV substation	7.1
<b>8</b>	Install a 115 kV 3% reactor on the underground cable between South Meadow and Southwest Hartford(1704)	3.6
<b>9</b>	Separation of 115 kV DCT corresponding to the Bloomfield to North Bloomfield (1777) line and the North Bloomfield – Rood Avenue – Northwest Hartford (1751) line and add a breaker at North Bloomfield 115 kV substation	20.1
<b>Subtotal of Common Solution Components</b>		<b>49.6</b>

<sup>22</sup> With the doubling of the 5T breaker and the addition of a 3% series reactor between the two 115 kV Southington ring buses, the automatic control scheme associated with the 5T breaker at Southington will no longer be required.

**Table 7-9: Rest of Greater Hartford Alternative Solution Components Cost Estimates**

ID	Solution Component	Cost (\$M)	Included in Underground Line Alternative	Included in Overhead Line Alternative
1	Add a new 4 mile 115 kV underground cable from Newington to Southwest Hartford and associated terminal equipment including a 2% series reactor	91.0	Y	
2	Add a new 11.67 mile 115 kV line from North Bloomfield to Farmington and associated terminal equipment	77.0		Y
10	Terminal upgrades on the 115 kV line between South Meadow and Rocky Hill	0.6		Y
11	Upgrade the 115 kV line between Farmington and Newington Tap (1783) – 3.61 miles	9.5		Y
<b>Solution Alternative Totals</b>			<b>91.0</b>	<b>87.1</b>

### 7.3 Comparison of Alternative Solutions

Table 7-10 below shows the total cost estimates for each alternative in each GHCC study subarea.

**Table 7-10: Summary of GHCC Solution Alternatives Total Cost Estimates**

Subarea	Solution Alternative	Common Components Cost Estimate +50/-25% (\$M)	Unique Components Cost Estimate +50/-25% (\$M)	Total Cost Estimate +50/-25% (\$M)
<b>Manchester / Barbour Hill</b>	Alternative A	2.1	44.7	<b>46.8</b>
	Alternative B	2.1	47.3	<b>49.4</b>
<b>Northwestern Connecticut</b>	Alternative A	12.1	51.0	<b>63.1</b>
	Alternative B	12.1	73.9	<b>86.0</b>
<b>Middletown</b>	2 <sup>nd</sup> Haddam Auto	10.3	52.9	<b>63.2</b>
	Scovill Rock Auto	10.3	79.9	<b>90.2</b>
<b>Greater Hartford (including Southington)</b>	Underground Line (Newington – SW Hartford)	87.9	91.0	<b>178.9</b>
	Overhead Line (N Bloomfield – Farmington)	87.9	87.1	<b>175.0</b>

When evaluating between the two alternatives for each subarea, they contain several common components. To differentiate between the two, only the projects that are not common in each alternative will be evaluated against the remaining key factors. All alternatives are expected to be constructible.

## 7.4 Comparison Matrix of Alternative Solutions

The primary factor in selecting the preferred solution was cost. Other factors included permitting, constructability, operational performance, and expected in-service date. Table 7-11 shows a comparison matrix for the two alternative solutions for the Manchester / Barbour Hill subarea.

**Table 7-11: Comparison Matrix of Manchester / Barbour Hill Alternative Solutions**

Key Factors	Alternative A (Barbour Hill Auto)	Alternative B (Manchester – Barbour Hill 115 kV Line)
Expected Ease of Permitting (e.g. environmental, siting, etc.)	✓	✗
Ease of Constructability (during construction phase)	✗	✓
Better System Performance – Thermal	✓	✓
Better System Performance – Voltage	✓	✗
Ease of Expandability	✓	✓
Expected In-Service Date	2017	2017
Estimated Cost for Unique Solution Components (\$M with +50/-25% accuracy)	44.7 ✓	47.3 ✗

✗ - Is applied to the Alternative which does not achieve the objective as well as the other Alternative

✓ - Is applied to the Alternative which better achieves the objective

Alternative A was chosen as the preferred solution for this subarea for several reasons. Both solution alternatives resolved all thermal and voltage criteria violations in the 10-year planning horizon. However, Alternative A was chosen based on its slightly lower cost and better post-project voltage performance over Alternative B.

Table 7-12 shows a comparison matrix for the two alternative solutions for the Northwestern Connecticut subarea.

**Table 7-12: Comparison Matrix of Northwestern Connecticut Alternative Solutions**

Key Factors	Alternative A (Frost Bridge – Campville 115 kV Line)	Alternative B (North Bloomfield - Canton 115 kV Line)
Expected Ease of Permitting (e.g. environmental, siting, etc.)	✓	✓
Ease of Constructability (during construction phase)	✓	✓
Better System Performance – Thermal	✓	✓
Better System Performance – Voltage	✓	✗
Ease of Expandability	✓	✓
Expected In-Service Date	2017	2017
Estimated Cost for Unique Solution Components (\$M with +50/-25% accuracy)	51.0 ✓	73.9 ✗

- ✗ - Is applied to the Alternative which does not achieve the objective as well as the other Alternative
- ✓ - Is applied to the Alternative which better achieves the objective

Alternative A was chosen as the preferred solution for this subarea for several reasons. Both solution alternatives resolved all thermal and voltage criteria violations in the 10-year planning horizon. However, Alternative A was chosen based on its substantially lower cost and better voltage performance. Alternative B required additional reactive support to be installed at the Campville in order to boost voltages in the area under certain conditions.

Table 7-13 shows a comparison matrix for the two alternative solutions for the Middletown subarea.

**Table 7-13: Comparison Matrix of Middletown Alternative Solutions**

Key Factors	2 <sup>nd</sup> Haddam Autotransformer Alternative	Scovill Rock Autotransformer Alternative
Expected Ease of Permitting (e.g. environmental, siting, etc.)	✓	✗
Ease of Constructability (during construction phase)	✓	✗
Better System Performance – Thermal	✓	✓
Better System Performance – Voltage	✓	✓
Better System Performance – Re-Dispatch Requirements	✗	✓
Better System Performance – Western Connecticut Import Transfer Capability	✗	✓
Ease of Expandability	✓	✓
Expected In-Service Date	2017	2017
Estimated Cost for Unique Solution Components (\$M with +50/-25% accuracy)	52.9 ✓	79.9 ✗

✗ - Is applied to the Alternative which does not achieve the objective as well as the other Alternative

✓ - Is applied to the Alternative which better achieves the objective

The Haddam Auto alternative was chosen as the preferred solution for this subarea. Both solution alternatives resolved all thermal and voltage criteria violations in the 10-year planning horizon. However, the Haddam Auto plan was chosen based on its substantially lower cost. In addition, the substation reconfiguration and expansion to accommodate an additional autotransformer at Haddam would not be as extensive as that required to place a new autotransformer at Scovill Rock.



Table 7-14 shows a comparison matrix for the two alternative solutions for the Greater Hartford subarea.

**Table 7-14: Comparison Matrix of Greater Hartford Alternative Solutions**

Key Factors	Newington – SW Hartford 115 kV Underground Line Alternative	North Bloomfield – Farmington 115 kV Overhead Line Alternative
Expected Ease of Permitting (e.g. environmental, siting, etc.)	✓	✗
Ease of Constructability (during construction phase)	✓	✗
Better System Performance – Thermal	✓	✓
Better System Performance – Voltage	✓	✓
Better System Performance – Re-Dispatch Requirements	✓	✗
Ease of Expandability	✓	✓
Expected In-Service Date	2017	2017
Estimated Cost for Unique Solution Components (\$M with +50/-25% accuracy)	91.0 ✗	87.1 ✓

- ✗ - Is applied to the Alternative which does not achieve the objective as well as the other Alternative
- ✓ - Is applied to the Alternative which better achieves the objective

The Underground Line alternative was chosen as the preferred solution for this. While both solution alternatives resolved all thermal and voltage criteria violations in the 10-year planning horizon, the Newington-SW Hartford 115 kV alternative shows better performance for redispatch requirements for a little less than a \$4 million estimated difference, making it the most cost effective overall solution.

## **7.5 Recommended Solution Alternative**

Based on the key factors used to compare the solution alternatives, Alternative A for the Manchester / Barbour Hill subarea, Alternative A for the Northwestern Connecticut subarea, the second Haddam autotransformer alternative for the Middletown subarea, and the Newington – Southwest Hartford 115 kV underground line alternative for the Greater Hartford subarea are the preferred set of solution alternatives for the entire Greater Hartford and Central Connecticut study area. All of the solution alternatives resolve all thermal and voltage violations identified in the Needs Assessment.

# Section 8

## Conclusion

For each of the four study subareas, two alternatives were evaluated in the comparison of alternatives. The comparison of alternatives was based on the costs, system performance and other key factors like ease of permitting, constructability and expandability. The preferred solution to resolve the criteria violations found in the 10-year planning horizon is a combination of the Manchester/Barbour Hill Alternative A, Northwestern Connecticut Alternative A, the second Haddam autotransformer alternative for Middletown, and the Newington – Southwest Hartford 115 kV underground line for Greater Hartford.

### 8.1 Recommended Solution Description

#### 8.1.1 Manchester / Barbour Hill Subarea

Alternative A for the Manchester / Barbour Hill subarea is comprised of several components as described in Table 8-1. A more detailed description of each component can be found in Section 5.3.1.

**Table 8-1: Manchester / Barbour Hill Alternative A Solution Components**

Component ID	Description
1	Add a new 345/115 kV autotransformer at Barbour Hill and associated terminal equipment
3	Reconductor the 115 kV line between Manchester and Barbour Hill (1763) – 7.6 miles
4	Add a 345 kV breaker in series with breaker 24T at the Manchester 345 kV switchyard

#### 8.1.2 Northwestern Connecticut Subarea

Alternative A for the Northwestern Connecticut subarea is comprised of several components as described in Table 8-2. A more detailed description of each component can be found in Section 5.3.2.

**Table 8-2: Northwestern Connecticut Alternative A Solution Components**

Component ID	Description
1	Add a new 10.35 mile, 115 kV line from Frost Bridge to Campville and associated terminal equipment
3	Separation of 115 kV DCT corresponding to the Frost Bridge to Campville (1191) line and the Thomaston to Campville (1921) line and add a breaker at Campville 115 kV substation
4	Upgrade terminal equipment on the 115 kV line between Chippen Hill and Lake Avenue Junction (1810-3)
5	Reconductor the 115 kV line between Southington and Lake Avenue Junction (1810-1) – 5.2 miles

### 8.1.3 Middletown Subarea

The Haddam Auto alternative for the Middletown subarea is comprised of several components as described in Table 8-3. A more detailed description of each component can be found in Section 5.3.3.

**Table 8-3: Middletown Area 2nd Haddam Autotransformer Alternative Solution Components**

Component ID	Description
1	Add a 2nd 345/115 kV autotransformer at Haddam substation and reconfigure the 3-terminal 345 kV 348 line into 2 two-terminal lines
3	Terminal equipment upgrades on the 345 kV line between Haddam and Beseck (362)
4	Separation of 115 kV double circuit towers corresponding to the Branford – Branford RR line (1537) and the Branford to North Haven (1655) line and adding a series breaker at Branford 115 kV substation
5	Terminal Equipment upgrades on the Middletown to Dooley Line (1050)
6	Terminal Equipment upgrades on the Middletown to Portland Line (1443)
7	Redesign the Green Hill 115 kV substation from a straight bus to a ring bus and add a 37.8 MVAR capacitor bank
8	Add a 37.8 MVAR capacitor bank at Hopewell 115 kV substation
12	Separation of 115 kV double circuit towers corresponding to the Middletown – Pratt and Whitney line (1572) and the Middletown to Haddam (1620) line

### 8.1.4 Greater Hartford Subarea

The Newington – Southwest Hartford 115 kV underground line alternative is comprised of several components as described in Table 8-4. A more detailed description of each component can be found in Section 5.3.4.

**Table 8-4: Greater Hartford Area Newington – Southwest Hartford Underground Line Alternative Solution Components**

Component ID	Description
1	Add a new 4 mile 115 kV underground cable from Newington to Southwest Hartford and associated terminal equipment including a 2% series reactor
3	Loop the 1779 line between South Meadow and Bloomfield into the Rood Avenue substation and reconfigure the Rood Avenue substation
4	Reconfigure the Berlin 115 kV substation including the addition of two 115 kV breakers and the relocation of a capacitor bank
5	Add a 115 kV 25.2 MVAR capacitor at Westside 115 kV substation
6	Reconductor the 115 kV line between Newington and Newington Tap (1783) – 0.01 miles
7	Separation of 115 kV DCT corresponding to the Bloomfield to South Meadow (1779) line and the Bloomfield to North Bloomfield (1777) line and add a breaker at Bloomfield 115 kV substation
8	Install a 115 kV 3% reactor on the underground cable between South Meadow and Southwest Hartford(1704)
9	Separation of 115 kV DCT corresponding to the Bloomfield to North Bloomfield (1777) line and the North Bloomfield – Rood Avenue – Northwest Hartford (1751) line and add a breaker at North Bloomfield 115 kV substation
S1	Replace the existing 3% series reactors on the 115 kV lines between Southington and Todd (1910) and between Southington and Canal (1950) with 5% series reactors
S2	Replace the normally open 19T breaker at Southington with a 3% series reactor between Southington Ring 1 and Southington Ring 2 and associated substation upgrades
S3	Add a breaker in series with breaker 5T at the Southington 345 kV switchyard
S4	Add a new control house at Southington 115 kV substation

Table 8-5 summarizes all of the cost estimates for the preferred set of solutions for the GHCC study area.

**Table 8-5: Preferred Solution Total Cost Estimates**

Subarea	Preferred Solution Set	Cost Estimate +50/-25% (\$M)
<b>Manchester / Barbour Hill</b>	Alternative A	46.8
<b>Northwestern Connecticut</b>	Alternative A	63.1
<b>Middletown</b>	Haddam Auto	63.2
<b>Greater Hartford</b>	Underground Line	178.9
<b>Total Cost Estimate for All Preferred Solutions</b>		<b>352.0</b>

## 8.2 Solution Component Year of Need

---

The Needs Assessment states the majority of violations occur in today’s system or earlier. Currently operations postures the system by generation re-dispatch and other system adjustments to prevent violations. The projected in-service date of all solution components is by the end of 2017.

## 8.3 Schedule for Implementation, Lead Times and Documentation of Continuing Need

---

In accordance with NERC TPL Standards, this assessment provides:

- A written summary of plans to address the system performance issues described in the *Greater Hartford and Central Connecticut (GHCC) Area Transmission 2022 Needs Assessment*, dated May 2014
- A schedule for implementation as described below
- A discussion of expected required in-service dates of facilities and associated load level when required as described below
- A discussion of lead times necessary to implement plans, described below

The planned completion date of the preferred combined solution as described in Section 8.1 above is 2017. With this schedule the preferred combined solution will be in service after potential violations of the NERC Standard Requirements occur. Currently, System Operations postures the system by generation re-dispatch and other system adjustments to prevent these violations. The longest lead time items required to complete the project are large power transformers with a projected lead time of one year. This study has reviewed the continuing need and has identified a recommended solution.

# Section 9

## Appendix A: Load Forecast

**Table 9-1:  
2013 CELT Seasonal Peak Load Forecast Distributions**

		Peak Load Forecast at Milder Than Expected Weather				Reference Forecast at Expected Weather	Peak Load Forecast at More Extreme Than Expected Weather				
<b>Summer (MW)</b>	2013	26470	26715	27045	27420	27840	28285	28735	29385	30135	30790
	2014	26900	27150	27485	27865	28290	28740	29200	29860	30620	31280
	2015	27410	27665	28005	28390	28825	29285	29750	30425	31185	31860
	2016	27910	28165	28515	28910	29350	29815	30295	30980	31740	32420
	2017	28325	28590	28940	29340	29790	30265	30750	31445	32210	32900
	2018	28675	28940	29295	29700	30155	30635	31125	31830	32615	33315
	2019	29025	29295	29655	30065	30525	31010	31505	32220	33010	33720
	2020	29345	29615	29980	30395	30860	31350	31855	32575	33380	34095
	2021	29670	29950	30315	30735	31205	31700	32210	32935	33755	34480
	2022	29970	30250	30625	31045	31520	32020	32535	33270	34105	34840
WTHI (1)		78.49	78.73	79.00	79.39	79.88	80.30	80.72	81.14	81.96	82.33
Dry-Bulb Temperature (2)		88.50	88.90	89.20	89.90	90.20	91.20	92.20	92.90	94.20	95.40
Probability of Forecast Being Exceeded		90%	80%	70%	60%	50%	40%	30%	20%	10%	5%
<b>Winter (MW)</b>	2013/14	22025	22140	22235	22295	22445	22595	22765	22865	23080	23505
	2014/15	22205	22320	22420	22480	22630	22780	22955	23055	23255	23685
	2015/16	22385	22500	22595	22660	22810	22960	23135	23235	23440	23870
	2016/17	22540	22660	22755	22815	22970	23125	23295	23400	23620	24050
	2017/18	22680	22795	22895	22955	23110	23265	23440	23540	23780	24205
	2018/19	22800	22920	23020	23080	23235	23390	23565	23670	23920	24345
	2019/20	22915	23035	23130	23195	23350	23505	23685	23785	24045	24470
	2020/21	23030	23150	23250	23315	23470	23625	23805	23910	24160	24590
	2021/22	23145	23265	23365	23425	23585	23745	23920	24025	24280	24705
	2022/23	23255	23380	23480	23540	23700	23860	24040	24145	24395	24820
Dry-Bulb Temperature (3)		10.72	9.66	8.84	8.30	7.03	5.77	4.40	3.58	1.61	(1.15)

**FOOTNOTES:**

- (1) WTHI - a three-day weighted temperature-humidity index for eight New England weather stations. It is the weather variable used in producing the summer peak load forecast. For more information on the weather variables see [http://www.iso-ne.com/trans/celt/fsct\\_detail/](http://www.iso-ne.com/trans/celt/fsct_detail/).
- (2) Dry-bulb temperature (in degrees Fahrenheit) shown in the summer season is for informational purposes only.
- (3) Dry-bulb temperature (in degrees Fahrenheit) shown in the winter season is a weighted value from eight New England weather stations.

**Table 9-2: 2022 Detailed Load Distributions by State and Company**

**ISO New England Basecase DB - Load File Report by Company**

Study Date : 08/15/2022 Study Name : GHCC Revised  
 File Created : 2014-01-22 CELT Forecast : 2013 Forecast Year : 2022  
 Season : Summer Peak Weather : 90/10 Load Distribution : N+10\_SUM  
 ISO-NE CELT : 34105 MW % of Peak : 100.000% Tx Losses : 2.50%

State CELT L&L	-	2.50% Tx Losses	+	Non-CELT Load	+	Station Service	-	Area 104 NE Load	=	Area 101 Load
34105 MW		852.6 MW		364.4 MW		0.0 MW		42.8 MW		33574.3 MW

1: State CELT L&L: This represents the sum of the 6 State CELT forecasts. This number can sometimes be 5-10 MW different than the ISO-NE CELT forecast number due to round-off error.  
 2: Non-CELT Load: This is the sum of all load modeled in the case that is not included in the CELT forecast. An example is the "behind the meter" paper mill load in Maine.  
 3: Station Service: This is the amount of generator station service modeled. If station service is off-line, the Area 101 report totals will be different since off-line load is not counted in totals.  
 4: Area 104 NE Load: This load is load modeled in northern VT that is electrically served from Hydro Quebec. To make Area Interchange load independent, this load is assigned Area 104.

**Maine State Load = 2450 MW - 2.50% Tx Losses = 2388.75 MW**

Company	State Share	Total P (MW)	Total Q (MVAR)	Overall PF	Non-Scaling (MW)
CMP	85.42%	2040.39	655.06	0.952	332.06
BHE	14.59%	348.42	133.15	0.934	17.81

**New Hampshire State Load = 3150 MW - 2.50% Tx Losses = 3071.25 MW**

Company	State Share	Total P (MW)	Total Q (MVAR)	Overall PF	Non-Scaling (MW)
PSNH	78.73%	2418.00	344.54	0.990	
UNITIL	12.13%	372.58	53.09	0.990	
GSE	9.14%	280.68	6.42	1.000	1.85

**Vermont State Load = 1220 MW - 2.50% Tx Losses = 1189.5 MW**

Company	State Share	Total P (MW)	Total Q (MVAR)	Overall PF	Non-Scaling (MW)
VELCO	100.00%	1189.57	200.18	0.986	95.79

**Massachusetts State Load = 16055 MW - 2.50% Tx Losses = 15653.625 MW**

Company	State Share	Total P (MW)	Total Q (MVAR)	Overall PF	Non-Scaling (MW)
BECO	28.31%	4431.86	1146.57	0.968	37.79
COMEL	11.63%	1820.19	368.90	0.980	
MA-NGRID	39.34%	6157.37	355.79	0.998	38.49
WMECO	6.34%	992.13	141.36	0.990	
MUNI:BOST-NGR	3.40%	532.23	93.80	0.985	
MUNI:BOST-NST	1.21%	189.87	29.00	0.989	
MUNI:CNEMA-NGR	2.10%	328.38	33.68	0.995	
MUNI:RI-NGR	0.88%	137.44	16.67	0.993	
MUNI:SEMA-NGR	1.86%	290.39	30.91	0.994	
MUNI:SEMA-NST	1.74%	272.37	50.29	0.983	
MUNI:WMA-NGR	1.01%	157.79	15.67	0.995	
MUNI:WMA-NU	2.20%	343.77	48.98	0.990	

**Rhode Island State Load = 2405 MW - 2.50% Tx Losses = 2344.875 MW**

Company	State Share	Total P (MW)	Total Q (MVAR)	Overall PF	Non-Scaling (MW)
RI-NGRID	100.00%	2344.90	229.64	0.995	45.44

**Connecticut State Load = 8825 MW - 2.50% Tx Losses = 8604.375 MW**

Company	State Share	Total P (MW)	Total Q (MVAR)	Overall PF	Non-Scaling (MW)
CLP	76.26%	6561.83	935.10	0.990	82.50
CMEEC	4.71%	405.62	57.80	0.990	
UI	19.02%	1636.87	163.66	0.995	10.00

**Table 9-3: Detailed Demand Response Distributions by Zone**

**ISO New England Basecase DB - Demand Resources File Report**

Study Date : 08/15/2022 Study Name : GHCC Revised  
 File Created : 2014-01-22 CCP : 2016/2017 Load Season : 2022 - Summer Peak  
 Load Distrb : N+10\_SUM Distrb Losses : 5.50% DR Season : SUM

	Demand Reduction Value (DRV)	Load Dependent Capability Assumption (LDCA)	Performance Assumption (PA)	Distribution Losses Gross-Up	Area 104 DR	Area 101 DR
Passive :	1670.15 MW	100.00%	100.00%	91.86 MW	4.77 MW	1757.05 MW
Forecast EE :	1038.85 MW	100.00%	100.00%	57.14 MW	3.37 MW	1092.68 MW
Active :	1171.84 MW	100.00%	75.00%	48.34 MW	1.72 MW	925.35 MW

Demand Reduction Value (DRV): Amount of DR measured at the customer meter without any gross-up values for transmission or distribution losses.  
 Load Dependent Capability Assumption (LDCA): De-rate factor applied based on % of CELT load. (i.e. Light load is 45% of 50/50 load, so the LDCA would be 45%).  
 Performance Assumption (PA): De-rate factor applied based on expected performance of DR after a dispatch signal from Operations.  
 Area 104 DR: This load is modeled in northern VT and is electrically served from Hydro Quebec. To make Area interchange load independent, this load is assigned Area 104.

**Passive Demand Resources - (On-Peak and Seasonal Peak)**

DR Modeled = (DRV\_SUM \* 100.00% LDCA \* 100.00% PA) + 5.50% Distrb Losses Gross-Up

Zone	ID	Description	DRV (MW)	Total P (MW)	Total Q (MVAR)
DR_P_ME	20	Load Zone - Maine	158.72	-167.44	-60.62
DR_P_NH	21	Load Zone - New Hampshire	79.75	-84.16	-11.66
DR_P_VT	22	Load Zone - Vermont	125.44	-132.24	-22.07
DR_P_NEMABOS	23	Load Zone - Northeast Massachusetts & Boston	341.18	-359.90	-79.19
DR_P_SEMA	24	Load Zone - Southeast Massachusetts	193.94	-204.59	-20.15
DR_P_WCMA	25	Load Zone - West Central Massachusetts	244.71	-258.17	-21.99
DR_P_RI	26	Load Zone - Rhode Island	141.90	-149.65	-14.66
DR_P_CT	27	Load Zone - Connecticut	384.51	-405.67	-54.52

**Forecasted Energy Efficiency**

DR Modeled = (DRV\_EE \* 100.00% LDCA \* 100.00% PA) + 5.50% Distrb Losses Gross-Up

Zone	ID	Description	DRV (MW)	Total P (MW)	Total Q (MVAR)
DR_P_ME	20	Load Zone - Maine	56.48	-59.57	-21.50
DR_P_NH	21	Load Zone - New Hampshire	52.78	-55.67	-7.69
DR_P_VT	22	Load Zone - Vermont	88.88	-93.88	-15.70
DR_P_NEMABOS	23	Load Zone - Northeast Massachusetts & Boston	276.34	-291.52	-64.14
DR_P_SEMA	24	Load Zone - Southeast Massachusetts	146.98	-155.05	-15.30
DR_P_WCMA	25	Load Zone - West Central Massachusetts	164.62	-173.68	-14.80
DR_P_RI	26	Load Zone - Rhode Island	113.89	-120.16	-11.81
DR_P_CT	27	Load Zone - Connecticut	138.88	-146.52	-19.68

**Active Demand Resources - (Real-Time Demand Resource (RTDR), Excludes RTEG)**

DR Modeled = (DRV\_SUM \* 100.00% LDCA \* 75.00% PA) + 5.50% Losses Gross-Up

Zone	ID	Description	DRV (MW)	Total P (MW)	Total Q (MVAR)
DR_A_ME_BHE	30	Dispatch Zone - ME - Bangor Hydro	56.40	-44.63	-23.28
DR_A_ME_MAIN	31	Dispatch Zone - ME - Maine	206.61	-163.53	-55.36
DR_A_ME_PORT	32	Dispatch Zone - ME - Portland Maine	31.49	-24.89	-8.12
DR_A_NH_NEWH	33	Dispatch Zone - NH - New Hampshire	48.62	-38.46	-5.28
DR_A_NH_SEAC	34	Dispatch Zone - NH - Seacoast	12.10	-9.58	-1.36
DR_A_VT_NWVT	35	Dispatch Zone - VT - Northwest Vermont	38.46	-30.40	-4.93
DR_A_VT_VERM	36	Dispatch Zone - VT - Vermont	24.83	-19.64	-3.51
DR_A_MA_BOST	37	Dispatch Zone - MA - Boston	81.06	-64.09	-16.39
DR_A_MA_NSHR	38	Dispatch Zone - MA - North Shore	35.48	-28.06	-3.39
DR_A_MA_CMA	39	Dispatch Zone - MA - Central Massachusetts	51.46	-40.67	-2.04
DR_A_MA_SPF	40	Dispatch Zone - MA - Springfield	32.76	-25.91	-3.69
DR_A_MA_WMA	41	Dispatch Zone - MA - Western Massachusetts	78.27	-61.92	-5.86
DR_A_MA_LSM	42	Dispatch Zone - MA - Lower Southeast Massachusetts	20.01	-15.85	-2.60
DR_A_MA_SEMA	43	Dispatch Zone - MA - Southeast Massachusetts	121.48	-96.13	-6.76
DR_A_RI_RHOD	44	Dispatch Zone - RI - Rhode Island	73.75	-58.38	-5.69
DR_A_CT_EAST	45	Dispatch Zone - CT - Eastern Connecticut	36.55	-28.90	-4.12
DR_A_CT_NRTH	46	Dispatch Zone - CT - Northern Connecticut	84.10	-66.53	-9.48
DR_A_CT_NRST	47	Dispatch Zone - CT - Norwalk-Stamford	34.23	-27.08	-3.70
DR_A_CT_WEST	48	Dispatch Zone - CT - Western Connecticut	104.18	-82.42	-10.71



## Section 10

### Appendix B: Case Summaries and Load Flow Plots

Quick links to case summaries for each of the dispatches described in Table 3-6 and Table 3-7 are provided below. Each file contains all of the case summaries for the portion of the study area noted in the title. Proposed solution alternatives were added to these to create the post-project cases for analysis.

[Appendix B1: Barbour Hill Subarea Dispatches](#)

[Appendix B2: CCRP Dispatches](#)

[Appendix B3: Greater Hartford Subarea Dispatches](#)

[Appendix B4: IRP Dispatches](#)

[Appendix B5: Middletown Subarea Dispatches](#)

[Appendix B6: Northwestern Connecticut Subarea Dispatches](#)

## Section 11

### Appendix C: Element-Out Scenarios for N-1-1 Analysis

Table 11-1: N-1-1 First Element-Out Scenarios

Line/ Autotransformer	Station A	Station B	Station C
<b>Underground cables</b>			
1704	South Meadow 115 kV	Southwest Hartford 115 kV	
1722	Southwest Hartford 115 kV	CDEC 115 kV	Northwest Hartford 115 kV
115 kV Line (Future)	Newington 115 kV	Southwest Hartford 115 kV	
<b>Overhead 345 kV lines</b>			
310	Manchester 345 kV	Millstone 345 kV	
329	Frost Bridge 345 kV	Southington 345 kV	
330	Card 345 kV	Lake Road 345 kV	
347	Killingly 345 kV	Sherman Road 345 kV	
348E (Future)	Millstone 345 kV	Haddam 345 kV	
348W (Future)	Haddam 345 kV	Beseck 345 kV	
352	Frost Bridge 345 kV	Long Mountain 345 kV	
352 (w/ Element Restored) <sup>23</sup>	Frost Bridge 345 kV	Long Mountain 345 kV	
362	Beseck 345 kV	Haddam Neck 345 kV	
364	Montville 345 kV	Haddam Neck 345 kV	
368	Manchester 345 kV	Card 345 kV	
371	Millstone 345 kV	Montville 345 kV	
376	Scovill Rock 345 kV	Haddam Neck 345 kV	
383	Millstone 345 kV	Card 345 kV	
3041	Southington 345 kV	Scovill Rock 345 kV	
3196	Agawam 345 kV	Ludlow 345 kV	
3216	North Bloomfield 345 kV	Agawam 345 kV	
3271	Lake Road 345 kV	Card 345 kV	
3348	Killingly 345 kV	Lake Road 345 kV	
3419	Barbour Hill 345 kV	Ludlow 345 kV	
3424	Manchester 345 kV	Kleen Energy 345 kV	
3557	Barbour Hill 345 kV	Manchester 345 kV	
3642	North Bloomfield 345 kV	Manchester 345 kV	
3827	Beseck 345 kV	East Devon 345 kV	

<sup>23</sup> In some cases, the initial element-out scenario also disconnects another element connected to the same breaker position. In some cases the restoration of this additional element in the 30 minutes prior to the next contingency can have an impact on the results. For these conditions, two different initial line-out scenarios were analyzed, one in which the additional element remains offline and one in which the element is restored before the second contingency.

Line/ Autotransformer	Station A	Station B	Station C
<b>Overhead 115 kV lines</b>			
<b>1042</b>	North Bloomfield 115 kV	Northeast Simsbury 115 kV	
<b>1042 (w/ Element Restored)</b>	North Bloomfield 115 kV	Northeast Simsbury 115 kV	
<b>1050</b>	Middletown 115 kV	Dooley 115 kV	
<b>1100</b>	Enfield 115 kV	Barbour Hill 115 kV	
<b>1191</b>	Frost Bridge 115 kV	Campville 115 kV	
<b>1200</b>	Windsor Locks 115 kV	Barbour Hill 115 kV	
<b>1207</b>	Manchester 115 kV	East Hartford 115 kV	
<b>1208</b>	Southington 115 kV	Wallingford 115 kV	
<b>1256</b>	Canton 115 kV	Northeast Simsbury 115 kV	
<b>1261</b>	Haddam 115 kV	Bokum 115 kV	
<b>1300</b>	Windsor Locks 115 kV	Enfield 115 kV	
<b>1310</b>	Manchester 115 kV	East Windsor 115 kV	
<b>1342</b>	Bokum 115 kV	Green Hill 115 kV	
<b>1355</b>	Southington 115 kV	Hanover 115 kV	Colony 115 kV
<b>1443</b>	Portland 115 kV	Middletown 115 kV	
<b>1448</b>	Manchester 115 kV	Rood Avenue 115 kV	
<b>1448 (w/ Element Restored)</b>	Manchester 115 kV	Rood Avenue 115 kV	
<b>1460</b>	East Shore 115 kV	Branford RR 115 kV	
<b>1466</b>	North Wallingford 115 kV	East Meriden 115 kV	
<b>1508</b>	Stepstone 115 kV	Green Hill 115 kV	
<b>1508(w/ Element Restored)</b>	Stepstone 115 kV	Green Hill 115 kV	
<b>1537</b>	Branford 115 kV	Branford RR 115 kV	
<b>1572_1772</b>	Middletown 115 kV	P&W Aircraft 115 kV	Haddam 115 kV
<b>1588</b>	North Wallingford 115 kV	Colony 115 kV	
<b>1598</b>	Haddam 115 kV	Bokum 115 kV	
<b>1606</b>	Barbour Hill 115 kV	Rockville 115 kV	
<b>1610</b>			
<b>1620</b>	Haddam 115 kV	Middletown 115 kV	
<b>1635</b>	Barbour Hill 345 kV	South Windsor 115 kV	
<b>1655</b>	North Haven 115 kV	Branford 115 kV	
<b>1670</b>	Berlin 115 kV	Southington 115 kV	Black Rock 115 kV
<b>1690</b>	Southington 115 kV	Hanover 115 kV	
<b>1724</b>	Barbour Hill 115 kV	Rockville 115 kV	
<b>1726</b>	Farmington 115 kV	North Bloomfield 115 kV	
<b>1732</b>	Franklin Drive 115 kV	Campville 115 kV	Canton 115 kV
<b>1738</b>	Stepstone 115 kV	Branford 115 kV	
<b>1751</b>	North Bloomfield 115 kV	Rood Avenue 115 kV	Northwest

Line/ Autotransformer	Station A	Station B	Station C
			Hartford 115 kV
1752	Berlin 115 kV	Rocky Hill 115 kV	
1756	Bloomfield 115 kV	Northwest Hartford 115 kV	
1759	Hopewell 115 kV	Portland 115 kV	
1763	Manchester 115 kV	Barbour Hill 115 kV	
1765	Berlin 115 kV	West Side 115 kV	
1766	Dooley 115 kV	West Side 115 kV	
1767	Manchester 115 kV	Hopewell 115 kV	
1769	Berlin 115 kV	East New Britain 115 kV	
1771	Berlin 115 kV	Southington 115 kV	
1773	Rocky Hill 115 kV	South Meadow 115 kV	
1775	South Meadow 115 kV	Riverside Drive 115 kV	Manchester 115 kV
1777	Bloomfield 115 kV	North Bloomfield 115 kV	
1783	East New Britain 115 kV	Newington 115 kV	Farmington 115 kV
1785	Berlin 115 kV	Newington 115 kV	
1786	South Meadow 115 kV	East Hartford 115 kV	Riverside Drive 115 kV
1788	Torrington Terminal 115 kV	Franklin Drive 115 kV	
1788 (w/ Element Restored)	Torrington Terminal 115 kV	Franklin Drive 115 kV	
1800	Southington 115 kV	Forestville 115 kV	
1810	Southington 115 kV	Bristol 115 kV	Chippen Hill 115 kV
1820	Southington 115 kV	Black Rock 115 kV	
1825	Bristol 115 kV	Forestville 115 kV	
1830	Southington 115 kV	Black Rock 115 kV	
1835	Thomaston 115 kV	Chippen Hill 115 kV	
1900	Torrington Terminal 115 kV	Campville 115 kV	
1900 (w/ Element Restored)	Torrington Terminal 115 kV	Campville 115 kV	
1921	Campville 115 kV	Thomaston 115 kV	
1975	Haddam 115 kV	East Meriden 115 kV	
1779-1 (Future)	Rood Avenue 115 kV	Bloomfield 115 kV	
1779-2 (Future)	South Meadow 115 kV	Rood Avenue 115 kV	
115 kV Line (Future)	Frost Bridge 115 kV	Campville 115 kV	
<b>Overhead 69 kV Lines</b>			
667_689	Salisbury 69 kV	Falls Village 69 kV	Torrington Terminal 69 kV
690	Salisbury 69 kV	Smithfield 69 kV	
693_694	Torrington Terminal 69 kV	Falls Village 69 kV	North Canaan 69 kV
<b>Autotransformers</b>			

Line/ Autotransformer	Station A	Station B	Station C
<b>Barbour Hill 1X</b>	Barbour Hill 345 kV	Barbour Hill 115 kV	
<b>Barbour Hill 2X (Future)</b>	Barbour Hill 345 kV	Barbour Hill 115 kV	
<b>Frost Bridge 1X</b>	Frost Bridge 345 kV	Frost Bridge 115 kV	
<b>Frost Bridge 1X(w/ Element Restored)</b>	Frost Bridge 345 kV	Frost Bridge 115 kV	
<b>Haddam 5X (Future)</b>	Haddam 345 kV	Haddam 115 kV	
<b>Haddam 6X</b>	Haddam 345 kV	Haddam 115 kV	
<b>North Bloomfield 5X</b>	North Bloomfield 345 kV	North Bloomfield 115 kV	
<b>North Bloomfield 7X</b>	North Bloomfield 345 kV	North Bloomfield 115 kV	
<b>Manchester 4X</b>	Manchester 345 kV	Manchester 115 kV	
<b>Manchester 5X</b>	Manchester 345 kV	Manchester 115 kV	
<b>Manchester 6X</b>	Manchester 345 kV	Manchester 115 kV	
<b>Southington 1X</b>	Southington 345 kV	Southington 115 kV	
<b>Southington 2X</b>	Southington 345 kV	Southington 115 kV	
<b>Southington 3X</b>	Southington 345 kV	Southington 115 kV	
<b>Southington 4X</b>	Southington 345 kV	Southington 115 kV	
<b>Generators</b>			
<b>Bridgeport Energy</b>	Bridgeport Energy 115 kV		
<b>Bridgeport Harbor 3</b>	Pequonnock 115 kV		
<b>Middletown 4</b>	Middletown 345kV		
<b>New Haven Harbor</b>	New Haven 115 kV		
<b>South Meadow 6</b>	South Meadow 115 kV		
<b>Capitol District</b>	CDECCA 115 kV		

# Section 12

## Appendix D: Contingency Listings

### 12.1 GHCC Area NERC Category B Contingencies

Generator Contingencies = 91 Total				
GN_11_10BE	GN_DEXT_2	GN_LRD1	GN_MON6	GN_SOM6
GN_12_10BE	GN_DV10	GN_LRD2	GN_NHHB	GN_STEV
GN_AETN_CC	GN_DV11	GN_LRD3	GN_NORWICH	GN_THAM
GN_ALP	GN_DV12	GN_MFD1	GN_NRW1	GN_TORR
GN_ANSONIA	GN_DV13	GN_MFD2	GN_NRW2	GN_TUNN
GN_BHR2	GN_DV14	GN_MI12	GN_NRW3	GN_UCONN_CC
GN_BHR3	GN_DV15	GN_MI13	GN_PLAINFLD	GN_WAL1
GN_BHR4	GN_DV16	GN_MI14	GN_QP248_2	GN_WAL2
GN_BPTR	GN_DV17	GN_MI15	GN_QP248_3	GN_WAL3
GN_BRAN	GN_DV18	GN_MIDLTWN10	GN_QP248_4	GN_WAL4
GN_BRF	GN_EXTR	GN_MIDLTWN2	GN_ROCK	GN_WAL5
GN_BULL	GN_FALS	GN_MIDLTWN3	GN_SECR	GN_WBRY
GN_CC10	GN_FOXWOOD_1	GN_MIDLTWN4	GN_SHEP	GN_WLRC
GN_CC11	GN_FOXWOOD_2	GN_MIL2	GN_SO11	GN_WTSD_1
GN_CC12	GN_FRDR	GN_MIL3	GN_SO12	GN_WTSD_2
GN_CC13	GN_KIMB_CC	GN_MO10	GN_SO13	GN_WTSD_3
GN_CC14	GN_KLEEN_CC	GN_MO11	GN_SO14	GN_YALE_DG_1
GN_DERB	GN_LISB	GN_MON5	GN_SOM5	GN_YALE_DG_2
GN_DEXT_1				

Line Contingencies = 275 Total				
LN_100	LN_1515S	LN_1751	LN_314	LN_364
LN_1000	LN_1522	LN_1752	LN_315	LN_3642
LN_1042	LN_1537	LN_1753	LN_316	LN_366
LN_1050	LN_1545	LN_1756	LN_3161	LN_368
LN_1070	LN_1550_1950	LN_1759	LN_3165	LN_370
LN_1080	LN_1555	LN_1760_1876	LN_3196	LN_371
LN_1090	LN_1560N	LN_1763	LN_321	LN_3754
LN_1100	LN_1560S	LN_1765	LN_3216	LN_376
LN_1120	LN_1565	LN_1766	LN_322	LN_381
LN_1130	LN_1570	LN_1767	LN_323	LN_3827
LN_1163	LN_1572_1772	LN_1769	LN_325	LN_383
LN_1165	LN_1575	LN_1770	LN_326	LN_384
LN_1191	LN_1580	LN_1771	LN_327	LN_387
LN_1200	LN_1585	LN_1773	LN_3271	LN_389
LN_1207	LN_1588	LN_1775	LN_328	LN_3921
LN_1208	LN_1594	LN_1776	LN_3280	LN_398
LN_1210	LN_1598	LN_1777	LN_329	LN_399
LN_1220	LN_1605	LN_1780	LN_330	LN_400

LN_1222	LN_1606	LN_1783	LN_331	LN_500
LN_1235	LN_1607	LN_1785	LN_332	LN_601
LN_1238_1813	LN_1610	LN_1786	LN_3320	LN_602
LN_1250	LN_1617	LN_1788	LN_3321	LN_603
LN_1256	LN_1618	LN_1790	LN_333	LN_667_689
LN_1261	LN_1620	LN_1792	LN_334	LN_690
LN_1270	LN_1621	LN_1800	LN_3340	LN_693_694
LN_1272	LN_1622	LN_1810	LN_3348	LN_800
LN_1280	LN_1630	LN_1820	LN_335	LN_8100
LN_1300	LN_1635	LN_1825	LN_336	LN_8200
LN_1310	LN_1637	LN_1830	LN_3361	LN_8300
LN_1319	LN_1640	LN_1835	LN_3381	LN_8301
LN_1337	LN_1650	LN_1840	LN_340	LN_8400
LN_1342	LN_1655	LN_1843	LN_3403	LN_84004
LN_1350	LN_1668	LN_1867	LN_341	LN_8500
LN_1355	LN_1670	LN_1870S	LN_3419	LN_8600
LN_1363	LN_1675	LN_1880	LN_342	LN_8700
LN_1365	LN_1682	LN_1887	LN_3424	LN_8702
LN_1389	LN_1685	LN_1890	LN_343	LN_88003A
LN_1394	LN_1690	LN_1900	LN_344	LN_88003A_UG
LN_1410	LN_1697	LN_1910	LN_347	LN_88005A
LN_1416	LN_1704	LN_1921	LN_350	LN_88006A
LN_1430	LN_1710	LN_1943	LN_3512	LN_8804A
LN_1440	LN_1710_LS	LN_1955	LN_352	LN_8809A
LN_1443	LN_1714	LN_1975	LN_3520	LN_89003B
LN_1445	LN_1720	LN_1977	LN_3521	LN_89003B_UG
LN_1448	LN_1721	LN_1985	LN_3533	LN_89005B
LN_1450	LN_1722	LN_1990	LN_354	LN_89006B
LN_1460	LN_1724	LN_301_302	LN_355	LN_8904B
LN_1465	LN_1726	LN_303	LN_3557	LN_8909B
LN_1466	LN_1730	LN_3041	LN_356	LN_900
LN_1470	LN_1732	LN_308	LN_357	LN_91001
LN_1490	LN_1734	LN_310	LN_359	LN_9500
LN_1497	LN_1738	LN_312_393	LN_3619	LN_9502
LN_1500	LN_1740	LN_313	LN_362	LN_R118
LN_1505	LN_1742	LN_FB_CMPVL	LN_ROOD_BLMF	LN_NEWN_SWHFD
LN_1508	LN_1750	LN_348E	LN_348W	LN_SMEAD_ROOD

Transformer Contingencies = 164 Total

TF_AETN_GSU	TF_CARD_9X	TF_KLG2_GSU	TF_NORHAR_1X	TF_SNGTN_3X
TF_AGAWAM_1X	TF_CARP_HL_1	TF_KLST_GSU	TF_NORHAR_2X	TF_SNGTN_4X
TF_AGAWAM_2X	TF_COOL_K36X	TF_LISBON_GS	TF_NORHAR_8X	TF_SO11_SO12
TF_ALP_GSU	TF_COSCOB_GS	TF_LRD1_GSU	TF_NORWICH	TF_SO13_SO14
TF_ANSONIA	TF_CRVR_345A	TF_LRD2_GSU	TF_NRWLK_2/6	TF_SOM5_GSU
TF_AUBR_210X	TF_CRVR_345B	TF_LRD3_GSU	TF_NRWLK_8X	TF_SOM6_GSU
TF_AUBR_220X	TF_DEVON_10X	TF_LUDLOW_1X	TF_NRWLK_9X	TF_STEV_GSU
TF_BARBHL_1X	TF_DEVON_11X	TF_LUDLOW_3X	TF_NTHFLD_1X	TF_STNYB_10X
TF_BEL1_GSU	TF_DEVON_12X	TF_M1213_GSU	TF_NTHFLD_3X	TF_THAMS_GSU
TF_BEL2_GSU	TF_DEVON_13X	TF_M1415_GSU	TF_NWHV_T1	TF_TORR_10X
TF_BERRY_1X	TF_DEVON_14X	TF_MANCH_4X	TF_NWHV_T2	TF_TORR_1X
TF_BHR2_GSU	TF_DEVON_15X	TF_MANCH_5X	TF_OSG1_GSU	TF_TUNNEL_1X
TF_BHR3_GSU	TF_DEVON_17X	TF_MANCH_6X	TF_OSG2_GSU	TF_VERNON
TF_BHR4_GSU	TF_DEXT_GSU	TF_MFD12_GSU	TF_OSG3_GSU	TF_VTYA_4X
TF_BKS1_GSU	TF_EDEVON_2X	TF_MI10_GSU	TF_OSG4_GSU	TF_VTYA_GSU
TF_BKS2_GSU	TF_ES_8X_CSC	TF_MID2_GSU	TF_OST1_GSU	TF_WACHUS_T5
TF_BPTR_GSU	TF_ES_9X_CSC	TF_MID3_GSU	TF_OST2_GSU	TF_WACHUS_T6
TF_BRA4_GSU	TF_ESHORE_1X	TF_MID4_GSU	TF_PILG_GSU	TF_WACHUS_T7
TF_BRAY_3XAB	TF_ESHORE_8X	TF_MILSTN_2X	TF_PLNFD_GSU	TF_WAL12_GSU
TF_BRAY_5X	TF_ESHORE_9X	TF_MILSTN_3X	TF_PLUMTR_1X	TF_WAL345GSU
TF_BRPTE_10X	TF_EXTR_GSU	TF_MO10_GSU	TF_PLUMTR_2X	TF_WALTHM_2A
TF_BRPTE_11X	TF_FLSVL_GSU	TF_MON5_GSU	TF_QP248_GSU	TF_WAMSBY_T2
TF_BRPTE_12X	TF_FRSTB_1X	TF_MON6_GSU	TF_SACKET_PS	TF_WBRY_GSU
TF_BWTR_161X	TF_FRSTVL_2X	TF_MONT_16X	TF_SECREC_GS	TF_WFAR_174T
TF_BWTR_162X	TF_GLNBRK_4X	TF_MONTV_18X	TF_SERVRD_T1	TF_WFAR_175T
TF_CAN1_GSU	TF_GLNBRK_5X	TF_NBLOOM_5X	TF_SHEPAUG	TF_WLRC_GSU
TF_CAN2_GSU	TF_HADDAM_6X	TF_NBLOOM_7X	TF_SINGER_1X	TF_WMED_345A
TF_CANL_120X	TF_HOLB_345A	TF_NEA1_GSU	TF_SINGER_2X	TF_WMED_345B
TF_CANL_121X	TF_KENTCT_3X	TF_NEA2_GSU	TF_SNDYPD_1X	TF_WRUT_T1
TF_CANL_126X	TF_KENTCT_4X	TF_NEAS_GSU	TF_SNDYPD_2X	TF_WRUT_T2
TF_CANTON_2X	TF_KENTCT_5X	TF_NEWFANE_1	TF_SNGTN_1X	TF_WTRSD_GSU
TF_CARD_5X	TF_KILLNG_2X	TF_NORHAR_10	TF_SNGTN_2X	TF_WWALP_45A
TF_CARD_8X	TF_KLG1_GSU	TF_HADDAM_5X	TF_BARBHL_2X	



Bus Section Contingencies = 80 Total				
BS_ALLINGS_A	BS_BRDWDY_BC	BS_HAWTHRN_A	BS_MONTVLL_A	BS_SHELTON_A
BS_ALLINGS_B	BS_BRDWDY_T_A	BS_HAWTHRN_B	BS_MONTVLL_B	BS_SHELTON_B
BS_ANSON_T_A	BS_BRDWDY_T_D	BS_INDWELL_A	BS_N_HAVEN_A	BS_TORR_69KV
BS_ANSON_T_B	BS_CONGR_A_C	BS_INDWELL_B	BS_N_HAVEN_B	BS_TRPFALS_A
BS_ASHCR_T_A	BS_CONGR_B_D	BS_JUNE_ST_A	BS_NBLOOM_B	BS_TRPFALS_B
BS_ASHCR_T_B	BS_COOLIDGE	BS_JUNE_ST_B	BS_NORWALK_A	BS_TRUMBUL_A
BS_BAIRD_T_A	BS_COSCOB_A1	BS_KENTCTY_1	BS_NORWALK_B	BS_TRUMBUL_B
BS_BAIRD_T_B	BS_COSCOB_A2	BS_MANCHST_A	BS_OLDTOWN_A	BS_VTYA_115
BS_BARNM_T_A	BS_COSCOB_A3	BS_MANCHST_B	BS_OLDTOWN_B	BS_WATERST_B
BS_BARNM_T_B	BS_DEERFLDNH	BS_MILLRV_BC	BS_PLUMTRE_A	BS_WATERST_C
BS_BEACONFLS	BS_DEVON_T_A	BS_MILLRVR_A	BS_PLUMTRE_B	BS_WDMNT_T_A
BS_BERKSHR_A	BS_DEVON_T_B	BS_MILLRVR_D	BS_QUINN_T_A	BS_WDMNT_T_B
BS_BERLIN_A	BS_ELMWEST_A	BS_MILVN_T_A	BS_QUINN_T_B	BS_WMEDWAY_S
BS_BERLIN_B	BS_ELMWEST_B	BS_MILVN_T_B	BS_ROCKY_A3	BS_WRIVER_A
BS_BRDGWTR_N	BS_GLENBRK_A	BS_MIX_T_A	BS_SACKETT_A	BS_WRIVER_B
BS_BRDGWTR_S	BS_GLENBRK_B	BS_MIX_T_B	BS_SACKETT_B	BS_WRIVER_C

Loss of Element w/o Fault (Single Breaker Opening) - Total =32				
NF_352	NF_BESECK_R1	NF_BERLNCT_C	NF_HADDAM_C	NF_SO11_SO12
NF_387-1	NF_1300-2	NF_BRANFRD_C	NF_MANCH_C1	NF_SO13_SO14
NF_FRSTBR_1X	NF_1751-1	NF_CANTON_C	NF_MANCH_C2	NF_1256
NF_MANCH_5X	NF_1783-3	NF_FRKLNDR_C	NF_NBLOOM_C	NF_689
NF_SNGTN_4X	NF_1910_R	NF_FRSTB_C1	NF_SNGTN_C1	NF_693
NF_GRNHL_C1	NF_1950_R	NF_FRSTB_C2	NF_SNGTN_C2	NF_694
NF_HPWL_C1	NF_WSTSD_C1			

Loss of Element w/o Fault (Multiple Breakers Opening) - Total =48				
NF_3424_MB	NF_1300-3_MB	NF_1670-3_MB	NF_1751-3_MB	NF_1786-2_MB
NF_348-1_MB	NF_1355-1_MB	NF_1704_MB	NF_1772_MB	NF_1786-3_MB
NF_348-2_MB	NF_1355-2_MB	NF_1710-3_MB	NF_1773_MB	NF_1788_MB
NF_364_MB	NF_1355-3_MB	NF_1722-1_MB	NF_1775-1_MB	NF_1810-1_MB
NF_3754_MB	NF_1550-1_MB	NF_1722-2_MB	NF_1775-2_MB	NF_1810-3_MB
NF_1163-1_MB	NF_1550-2_MB	NF_1722-3_MB	NF_1775-3_MB	NF_1810-4_MB
NF_1163-2_MB	NF_1550-3_MB	NF_1732-1_MB	NF_1783-1_MB	NF_1950_MB
NF_1163-3_MB	NF_1572_MB	NF_1732-2_MB	NF_1783-2_MB	NF_AETN_GSU_MB
NF_1238_MB	NF_1670-1_MB	NF_1732-3_MB	NF_1786-1_MB	NF_667_MB
NF_1300-1_MB	NF_1670-2_MB	NF_1751-2_MB		

## 12.2 GHCC Area NERC Category C Contingencies

Breaker Failure Contingencies = 586 Total				
BF_AGAWAM_2T	BF_DEVN_T_2T	BF_KLEEN_2T	BF_NRWLK_2T	BF_SNGTN_6T
BF_AGAWAM_5T	BF_DEVN_T_3T	BF_KLEEN_3T	BF_NRWLK_3T	BF_SNGTN_7T
BF_AGAWM_22T	BF_DEVN_T_4T	BF_KLEEN_4T	BF_NRWLK_4T	BF_SNGTN_9T

BF_AGAWM_25T	BF_DEVON_10T	BF_KLEEN_6T	BF_NRWLK_5T	BF_SOMST_12
BF_AGAWM_26T	BF_DEVON_11T	BF_KNTC_115E	BF_NRWLK_6T	BF_SOMST_A
BF_ALLNGS_1T	BF_DEVON_12T	BF_KNTC_345B	BF_NRWLK_7T	BF_STCKHS_1T
BF_ALLNGS_2T	BF_DEVON_1T	BF_KNTC_345C	BF_NRWLK_8T	BF_STEV_1560
BF_ANSON_1T	BF_DEVON_20T	BF_KNTC_345E	BF_NRWLK_9T	BF_STEV_1876
BF_ANSON_2T	BF_DEVON_23T	BF_KNTC_345F	BF_NTHFLD_1T	BF_STEV_1990
BF_ANSON_3T	BF_DEVON_24T	BF_KNTC_4T20	BF_NTHFLD_2T	BF_STGTN_101
BF_ASHCRK_3B	BF_DEVON_25T	BF_KNTC_8510	BF_NTHFLD_3T	BF_STGTN_102
BF_AUBURN_02	BF_DEVON_26T	BF_KNTC_8520	BF_NTHFLD_4T	BF_STGTN_103
BF_AUBURN_03	BF_DEVON_27T	BF_KNTC_8589	BF_NTHFLD_5T	BF_STGTN_104
BF_AUBURN_40	BF_DEVON_28T	BF_KNTC_8910	BF_NWALFD_1T	BF_STGTN_105
BF_AUBURN_41	BF_DEVON_29T	BF_LAKERD_2T	BF_NWHART_31	BF_STHEND_5T
BF_BAIRD_75A	BF_DEVON_3T	BF_LAKERD_5T	BF_NWHART_32	BF_STONY_1T2
BF_BAIRD_75B	BF_DEVON_6T	BF_LAKERD_8T	BF_NWHART_33	BF_STPSTN_1T
BF_BARBH_18T	BF_DEVON_7T	BF_DEVN_T_1T	BF_NWHV_370	BF_SWHART_1T
BF_BARBH_21T	BF_DEVON_8T	BF_LUDLOW_1T	BF_NWHV_371	BF_SWNSDR_1T
BF_BARBHL_2T	BF_DOOLEY_2T	BF_LUDLOW_2T	BF_NWHV_4163	BF_THMSTN_2T
BF_BARBHL_5T	BF_EDEVN_11T	BF_LUDLOW_3T	BF_NWHV_4341	BF_TODD_1T-2
BF_BATES_1T2	BF_EDEVN_24T	BF_LUDLOW_4T	BF_NWHV_6342	BF_TORR_10X1
BF_BE_10X	BF_EHART_1T	BF_LUDLOW_5T	BF_NWHV_6442	BF_TORR_1T-2
BF_BE_11X	BF_EMERDN_1T	BF_LUDLOW_6T	BF_NWNGTN_1T	BF_TORR_6892
BF_BEANHL_1T	BF_ENEWBR_69	BF_LUDLOW_7T	BF_NWNGTN_2T	BF_TORR_6932
BF_BECN_1319	BF_ENEWBR_83	BF_LUDLOW_8T	BF_OLDTWN_1T	BF_TRACY_1T2
BF_BECN_1570	BF_ENFLD_1T	BF_LUDLOW_9T	BF_OXFORD_1T	BF_TRAPFL_1T
BF_BELL_3-20	BF_ESHOR_1K	BF_LUDLW_41T	BF_PEACE_1T2	BF_TRINGL_2T
BF_BERLIN_13	BF_ESHOR_2K	BF_LUDLW_43T	BF_PEQNC_12T	BF_TRINGL_3T
BF_BERLIN_14	BF_ESHORE_11	BF_LUDLW_44T	BF_PEQNC_22T	BF_TRINGL_4T
BF_BERLIN_15	BF_ESHORE_12	BF_LUDLW_46T	BF_PEQNC_2T	BF_TRINGL_5T
BF_BERLIN_22	BF_ESHORE_13	BF_LUDLW_47T	BF_PEQNC_32T	BF_TRMBUL_1T
BF_BERLIN_23T	BF_ESHORE_21	BF_LUDLW_49T	BF_PEQNC_42T	BF_TRMBUL_2T
BF_BERLIN_24	BF_ESHORE_22	BF_MANCH_10T	BF_PQU_32T	BF_TRMBUL_3T
BF_BERLIN_25	BF_ESHORE_23	BF_MANCH_11T	BF_PQU_42T	BF_TUNNEL_1T
BF_BERLIN_27	BF_ESHORE_31	BF_MANCH_13T	BF_PILGM_104	BF_TUNNEL_2T
BF_BERY_345A	BF_ESHORE_32	BF_MANCH_14T	BF_PILGM_105	BF_TUNNEL_3T
BF_BERY_345B	BF_ESHORE_33	BF_MANCH_15T	BF_PLUMT_1X3	BF_TUNNEL_4T
BF_BERY_345C	BF_ESHORE_41	BF_MANCH_17T	BF_PLUMT_23T	BF_TUNNEL_5T
BF_BESECK_8T	BF_ESHORE_43	BF_MANCH_18T	BF_PLUMT_24T	BF_TWKS_7-39
BF_BLDWN_2T2	BF_ESHORE_71	BF_MANCH_19T	BF_PLUMT_25T	BF_TWKS_8-97
BF_BLDWN_5T2	BF_ESHORE_73	BF_MANCH_1T	BF_PLUMT_26T	BF_VERN_3TB1
BF_BLKST_101	BF_FARMTN_1T	BF_MANCH_20T	BF_PLUMT_29T	BF_VERN_3TB2
BF_BLKST_102	BF_FARMTN_2T	BF_MANCH_21T	BF_PLUMT_2T	BF_VERN_3TB3
BF_BLKST_103	BF_FARMTN_3T	BF_MANCH_22T	BF_PLUMT_2X3	BF_VERN_KTB1
BF_BLKST_104	BF_FLAXHL_2T	BF_MANCH_23T	BF_PLUMT_30T	BF_VTYK_1T
BF_BLMFLD_1T	BF_FLNDRS_1T	BF_MANCH_25T	BF_PLUMT_31T	BF_VTYK_381
BF_BLMFLD_2T	BF_FLSVL_694	BF_MANCH_2T	BF_PLUMT_32T	BF_VTYK_40/1

BF_BLMFLD_3T	BF_FRAMNG_1	BF_MANCH_3T	BF_PLUMT_4X1	BF_VTYK_811T
BF_BOKUM_1T	BF_FRDR_1T-2	BF_MANCH_4T	BF_PRTLND_2T	BF_VTYK_9-40
BF_BOKUM_2T	BF_FREGHT_1T	BF_MANCH_5T	BF_QNNIPC_1T	BF_WACH_13T
BF_BOKUM_3T	BF_FREGHT_2T	BF_MANCH_6T	BF_RESCO_9R	BF_WACH_141N
BF_BRANF_1T	BF_FRNCON_2T	BF_MANCH_7T	BF_RKYHIL_1T	BF_WACH_141W
BF_BRANF_4T	BF_FRSTB_14T	BF_MANCH_8T	BF_RKYHIL_2T	BF_WACH_142N
BF_BRANFRR_1	BF_FRSTB_15T	BF_MIDLTN_10	BF_ROCKY_1T2	BF_WACH_142W
BF_BRDWAY_1T	BF_FRSTB_16T	BF_MIDLTN_11	BF_ROCKY_2T2	BF_WACH_24T
BF_BRDWAY_2T	BF_FRSTB_1T2	BF_MIDLTN_3	BF_SACKET_1T	BF_WACH_2-7T
BF_BRGWTR_01	BF_FRSTB_1X2	BF_MIDLTN_7	BF_SALS_1T-2	BF_WACH_3-6T
BF_BRGWTR_04	BF_FRSTB_20T	BF_MIDRV_1T2	BF_SASCO_1T	BF_WACH_3-7T
BF_BRGWTR_07	BF_FRSTB_21T	BF_MIDRV_2T2	BF_SCOVRK_5T	BF_WACH_4-7T
BF_BRGWTR_13	BF_FRSTB_22T	BF_MILB_0802	BF_SCOVRK_8T	BF_WACH_6T
BF_BRGWTR_40	BF_FRSTB_23T	BF_MILB_1357	BF_SCTICO_1T	BF_WACH_7T
BF_BRGWTR_49	BF_FRSTB_24T	BF_MILB_345B	BF_SERV_RD_A	BF_WALNFD_1T
BF_BRGWTR_60	BF_FRSTB_26T	BF_MILLRV_1T	BF_SHAWS_1T2	BF_WALNFD_2T
BF_BRGWTR_70	BF_FRSTB_27T	BF_MILLRV_2T	BF_SHELTN_1T	BF_WALNFD_3T
BF_BRGWTR_80	BF_FRSTB_28T	BF_MILST_14T	BF_SHEP_1887	BF_WALNFD_4T
BF_BRGWTR_90	BF_FRSTB_2X2	BF_MILST_8T	BF_SHRMN_143	BF_WALNFD_5T
BF_BRISTL_1T	BF_FRSTVL_1T	BF_MIXAVE_1T	BF_SHUNOK_2T	BF_WALNFD_6T
BF_BRKSH_12T	BF_FRSTVL_2T	BF_MIXPDS_3X	BF_SINGR_22T	BF_WATRST_1T
BF_BRKSH_15T	BF_FTHILL_1T	BF_MONTV_10T	BF_SINGR_52T	BF_WATRST_2T
BF_BUDNTN_4T	BF_GLBK_10K	BF_MONTV_11T	BF_SMEAD_10	BF_WBKFD_1T2
BF_BUNKR_1T2	BF_GLBK_1753	BF_MONTV_12T	BF_SMEAD_2	BF_WESTSD_1T
BF_BUNKR_2T2	BF_GLBK_1792	BF_MONTV_13T	BF_SMEAD_3	BF_WFARN_170
BF_BUNKR_3T2	BF_GLBK_1867	BF_MONTV_14T	BF_SMEAD_4	BF_WFARN_176
BF_BYPT_3-3T	BF_GLBK_1977	BF_MONTV_15T	BF_SMEAD_5	BF_WFARN_710
BF_BYPT_345D	BF_GLBK_20K	BF_MONTV_16T	BF_SMEAD_7	BF_WFARN_711
BF_CAMPVL_1T	BF_GLBK_20T	BF_MONTV_17T	BF_SMEAD_8	BF_WFARN_714
BF_CAMPVL_2T	BF_GLBK_22T	BF_MONTV_18T	BF_SNAUG_1T	BF_WFARN_715
BF_CAMPVL_3T	BF_GLBK_23T	BF_MONTV_18X	BF_SNDPD_137	BF_WFARN_C
BF_CAMPVL_4T	BF_GLBK_25T	BF_MONTV_19T	BF_SNDPD_161	BF_WFARN_F
BF_CANAL_112	BF_GLBK_2T2	BF_MONTV_20T	BF_SNDPD_314	BF_WHMPDN_A1
BF_CANAL_212	BF_GLBK_3T	BF_MONTV_21T	BF_SNDPD_326	BF_WHMPDN_A2
BF_CANAL_312	BF_GLBK_4T	BF_MONTV_22T	BF_SNDPD_337	BF_WILTON_1T
BF_CANAL_412	BF_GLBK_4X12	BF_MONTV_23T	BF_SNDPD_343	BF_WMDWY_101
BF_CANAL_512	BF_GLBK_5X12	BF_MONTV_24T	BF_SNDPD_37E	BF_WMDWY_103
BF_CANAL_612	BF_GLBK_7T	BF_MONTV_4T	BF_SNDPD_37W	BF_WMDWY_104
BF_CANTN_1T2	BF_GLBK_8T	BF_MONTV_9T	BF_SNDPD_38E	BF_WMDWY_105
BF_CANTN_2T2	BF_GLBK_9T	BF_MYSCT_1T2	BF_SNDPD_38W	BF_WMDWY_106
BF_CARD_10T	BF_GRAND_22T	BF_NBLMF_14T	BF_SNDPD_412	BF_WMDWY_107
BF_CARD_11T	BF_GRAND_32T	BF_NBLMF_20T	BF_SNDPD_512	BF_WMDWY_108
BF_CARD_12T	BF_GRAND_42T	BF_NBLMF_23T	BF_SNDPD_521	BF_WMDWY_109
BF_CARD_13T	BF_GRNHIL_1T	BF_NBLMF_2T	BF_SNDPD_612	BF_WMDWY_111
BF_CARD_14T	BF_GRNHIL_2T	BF_NBLMF_5T	BF_SNDPD_643	BF_WMDWY_112

BF_CARD_15T	BF_HADDAM_26	BF_NBLMF_5X3	BF_SNGTN_10K	BF_WNSRLK_1T
BF_CARD_16T	BF_HADDAM_27	BF_NBLMF_7X3	BF_SNGTN_11T	BF_WOODMT_1T
BF_CARD_1T	BF_HADDAM_29	BF_NEA_1CB2	BF_SNGTN_14T	BF_WOODMT_2T
BF_CARD_345K	BF_HADDAM_32	BF_NEA_1CB3	BF_SNGTN_15T	BF_WOODRV_70
BF_CARD_3T	BF_HADDAM_33	BF_NESIMS_2T	BF_SNGTN_16T	BF_WRUT_3039
BF_CARVR_162	BF_HADDAM_35	BF_NEWF_20T2	BF_SNGTN_17T	BF_WRUT_3440
BF_CARVR_262	BF_HADDAM_37	BF_NEWF_3320	BF_SNGTN_18T	BF_WRUT_350
BF_CARVR_552	BF_HADDAM_5X	BF_NEWF_3321	BF_SNGTN_1T	BF_WRUT_360
BF_CARVR_652	BF_HADDAMN_1T	BF_NHAVEN_1T	BF_SNGTN_20T	BF_WRUT_371
BF_CARVR_862	BF_HADDAMN_2T	BF_NHAVEN_2T	BF_SNGTN_22T	BF_WRUT_372
BF_CHIPL_1T	BF_HADDAMN_4T	BF_NORHAR_1T	BF_SNGTN_23T	BF_WRUT_3740
BF_CHL_23-1T	BF_HALVAR_1X	BF_NORHAR_2T	BF_SNGTN_24T	BF_WRUT_3937
BF_CHL_321	BF_HAWTRN_1T	BF_NORHAR_3T	BF_SNGTN_25T	BF_WTRFRD_1T
BF_COLONY_1T	BF_HOLBR_102	BF_NORHAR_4T	BF_SNGTN_26T	BF_WTRSD_1T2
BF_COMPO_1T	BF_HOLBR_107	BF_NORHAR_5T	BF_SNGTN_28T	BF_WTRSD_2T2
BF_COOL_3TB2	BF_HOLBR_7	BF_NORHAR_6T	BF_SNGTN_29T	BF_WTRSD_3T2
BF_COOL_K32	BF_HOPEWL_2T	BF_NORHAR_7T	BF_SNGTN_30T	BF_WWALP_104
BF_COOL_K36	BF_INDWEL_1T	BF_NORHN_1K	BF_SNGTN_31T	BF_WWALP_105
BF_COSCOB_1T	BF_JUNEST_1T	BF_NRWLK_10T	BF_SNGTN_33T	BF_WWALP_107
BF_COSCOB_2T	BF_KILLNG_22	BF_NRWLK_11T	BF_SNGTN_3T	BF_WWALP_108
BF_DARIEN_1T	BF_KILLNG_25	BF_NRWLK_12T	BF_SNGTN_3X3	BF_WWALP_109
BF_HADDAM_34	BF_KILLNG_3T	BF_NRWLK_1T	BF_SNGTN_4T	BF_WWALP_7
BF_ROOD_BT	BF_KLEEN_1T	BF_HADDAM_28	BF_HADDAM_BT	BF_WWALP_8
BF_ROOD_CT	BF_HADDAM_31	BF_ROOD_DT	BF_SWHART_AT	BF_HADDAM_ET
BF_SWHART_BT				

Double Circuit Tower Contingencies = 160 Total				
DC_1000_1070	DC_1355_1610	DC_1620_1975	DC_1820_1830	DC_364_1250
DC_1000_1080	DC_1355_1690	DC_1621_1742	DC_1867_1880	DC_3642_1779
DC_1000_1090	DC_1389_1880	DC_1622_1770	DC_1867_1890	DC_368_1767
DC_1070_1080	DC_1394_1858	DC_1630_1640	DC_1867_1977	DC_3754_1466
DC_1080_100	DC_1394_515S	DC_1630_1655	DC_1880_1890	DC_376_1772
DC_1080_1280	DC_1410_100	DC_1635_1763	DC_1910_1950	DC_379_N186
DC_1080_1410	DC_1410_400	DC_1637_1720	DC_3196_1314	DC_381_N186
DC_1080_1490	DC_1416_1867	DC_1640_1685	DC_3196_1602	DC_3827_1208
DC_1080_1675	DC_1416_1880	DC_1668_1721	DC_3196_1603	DC_3827_1610
DC_1100_1200	DC_1416_1890	DC_1670_1820	DC_321_1618	DC_3827_1655
DC_1100_1300	DC_1440_1450	DC_1670_1830	DC_321_1770	DC_387_1460
DC_1130_1430	DC_1440_1750	DC_1710_1714	DC_321_1887	DC_387_1537
DC_1130_9100	DC_1445_1721	DC_1710_1730	DC_3216_1768	DC_387_1975
DC_1163_1550	DC_1460_1537	DC_1714_1720	DC_3216_1781	DC_400_500
DC_1191_1921	DC_1470_1565	DC_1714_1730	DC_325_331	DC_560N_1570
DC_1200_1300	DC_1500_1605	DC_1720_1714	DC_325_344	DC_560N_1594
DC_1207_1775	DC_1505_1607	DC_1732_1788	DC_335_1-536	DC_580/710LS
DC_1208_1640	DC_1550_1910	DC_1732_1900	DC_337_1161	DC_689_693

DC_1210_1220	DC_1570_1580	DC_1740_1750	DC_3403_1565	DC_697/710LS
DC_1222_1714	DC_1570_1585	DC_1751_1756	DC_342_120W	DC_710/714LS
DC_1235_1250	DC_1575_1585	DC_1752_1773	DC_342_194	DC_800_900
DC_1261_1598	DC_1575_1990	DC_1770_1887	DC_342_355	DC_8100_8200
DC_1272_1721	DC_1580_1585	DC_1771_1820	DC_344_A24	DC_8300_8400
DC_1280_100	DC_1580_1710	DC_1775_1786	DC_348_1772	DC_8300_8600
DC_1280_1410	DC_1580_1730	DC_1780_1790	DC_348_1975	DC_8400_8600
DC_1280_1465	DC_1606_1724	DC_1788_1900	DC_3557_1448	DC_88/89005
DC_1280_400	DC_1610_1640	DC_1800_1810	DC_356_E1	DC_88/89006
DC_1310_1635	DC_1610_1685	DC_1800_1825	DC_362_1772	DC_88003A/89
DC_1310_1763	DC_1618_1887	DC_1810_1825	DC_362_1975	DC_8804_8904
DC_1319_1570	DC_1319_1585	DC_1810_1835	DC_362_376	DC_8809_8909
DC_1319_1580	DC_3642_ROOD_SME AD	DC_3642_ROOD_BLM F	DC_364_1235	DC_K371_K34

### 12.3 GHCC Area Special Protection System and Automatic Control Scheme Contingencies

SPS Contingencies = 65 Total				
SPS_1570-2	SPS_8809A	SPS_BSCON_AC	SPS_LN_1130	SPS_GR42T_RB
SPS_17101697	SPS_89003_RB	SPS_BSCON_BD	SPS_LN_1697	SPS_GR42T_TR
SPS_387+NHHB	SPS_89003_TR	SPS_BSELMARB	SPS_LN_1710	SPS_327_315
SPS_387-1	SPS_8909B	SPS_BSELMATR	SPS_LN_91001	SPS_WAT1T_RB
SPS_393+690	SPS_ALS1T_RB	SPS_BSELMBRB	SPS_MIL1T_RB	SPS_WAT1T_TR
SPS_398+690	SPS_ALS1T_TR	SPS_BSELMBTR	SPS_MIL1T_TR	LN_398+690_SPS
SPS_690	SPS_ALS2T_RB	SPS_BSWRVARB	SPS_NHHB	TF_MILSTN_3X+690_SPS
SPS_8301_RB	SPS_ALS2T_TR	SPS_BSWRVATR	SPS_TRMTB	BF_CAMPVL_2T / DC_1191_1921+690_SPS
SPS_8301_TR	SPS_BF_BARDA	SPS_BSWRVBRB	SPS_GR22T_RB	BF_CAMPVL_4T / DC_1732_1900+690_SPS
SPS_8500_RB	SPS_BF_BARDB	SPS_BSWRVBTR	SPS_GR22T_TR	BF_MILST_14T+690_SPS
SPS_8500_TR	SPS_BF_TRM1T	SPS_CHL_231T	SPS_GR32T_RB	BF_NBLMF_23T+690_SPS
SPS_88003_RB	SPS_BF_TRM2T	SPS_D88003RB	SPS_GR32T_TR	BF_NTHFLD_1T+690_SPS
SPS_88003_TR	SPS_BS_ASHTB	SPS_D88003TR	SPS_88098909	HVDC_PHASE_2+690_SPS

## 12.4 GHCC Area NERC Category D Contingencies

---

Generation Station Contingencies - Total = 11				
GS_BRPT_HBEN	GS_MIDDLTWN	GS_MONTVILLE	GS_NRWLKHBR	GS_WALLNGFRD
GS_COSCOB	GS_MILLSTONE	GS_NEW_HAVEN	GS_S-MEADOW	GS_WATERSIDE
GS_DEVON				

Loss of Substation contingencies - Total = 5				
SS_MANCH_345	SS_STGTN_115	SS_DEVON_115	SS_MLSTN_345	SS_MANCH_115

Loss of Right of way contingencies - Total = 5				
ROW_CHST_DLY	ROW_HBRKJ_NO	ROW_SGTN_SCO	ROW_HBRKJ_EH	ROW_STV_BNKR

## Section 13

# Appendix E: Steady State Testing Results

Quick links to Excel files containing PivotTables of the steady state testing results summarized in Section 6.1 are provided below. Each file contains all of the analysis results for the portion of the study area noted in the title.

[Appendix E1: Manchester / Barbour Hill Final Alternatives N-1-1 Thermal Results](#)

[Appendix E2: Manchester / Barbour Hill Final Alternatives N-1-1 Voltage Results](#)

[Appendix E3: Manchester / Barbour Hill Final Alternatives N-1-1 Non-Converged Scenarios](#)

[Appendix E4: NWCT Final Alternatives N-1-1 Thermal Results](#)

[Appendix E5: NWCT Final Alternatives N-1-1 Voltage Results](#)

[Appendix E6: NWCT Final Alternatives N-1-1 Non-Converged Scenarios](#)

[Appendix E7: Greater Hartford / Middletown Final Alternatives N-1 Thermal Results](#)

[Appendix E8: Greater Hartford / Middletown Final Alternatives N-1 Voltage Results](#)

[Appendix E9: GHCC and SWCT Preferred Solutions N-1 Thermal Results](#)

[Appendix E10: GHCC and SWCT Preferred Solutions N-1 Voltage Results](#)

## Section 14

### Appendix F: Short Circuit Testing Results

A quick links to an Excel file containing detailed results of the short circuit testing performed, as summarized in Section 6.3, is provided below.

[Appendix F: Short Circuit Testing Results](#)



## Section 15

### Appendix G: Transfer Analysis Testing Results

A quick link to an Excel file containing detailed results of the transfer analysis performed, as summarized in Section 6.4.1, is provided below.

[Appendix G: Western Connecticut Import Transfer Analysis Results](#)

***Note: This page intentionally left blank.***

**Exhibit 2.D.3 ISO-NE “Transmission Planning  
Technical Guide,” December 2014**





# Transmission Planning Technical Guide

© ISO New England Inc.  
System Planning  
December 2, 2014

***Note: This page intentionally left blank.***

# Contents

<b>Section 1 Introduction</b> .....	<b>5</b>
1.1 Purpose.....	5
1.2 Reliability Standards .....	6
<b>Section 2 Types of Transmission Planning Studies</b> .....	<b>7</b>
<b>Section 3 Transmission Element Ratings</b> .....	<b>9</b>
<b>Section 4 Voltage Criteria</b> .....	<b>10</b>
4.1 Overview.....	10
4.2 Pre-Contingency Voltages .....	10
4.3 Post-Contingency Low Voltages Prior to Equipment Operation .....	10
4.4 Post-Contingency Low Voltages After Equipment Operation .....	11
4.5 Post-Contingency High Voltages Prior to Equipment Operation.....	11
4.6 Post-Contingency High Voltages After Equipment Operation.....	11
4.7 Voltage Limits for Line End Open Contingencies.....	11
4.8 Transient Voltage Response .....	11
4.9 Voltage Limits at Buses Associated with Nuclear Units.....	12
<b>Section 5 Assumptions Concerning Load</b> .....	<b>13</b>
<b>Section 6 Load Power Factor Assumptions</b> .....	<b>16</b>
<b>Section 7 Load Models</b> .....	<b>17</b>
7.1 Load Model for Steady-State Analysis .....	17
7.2 Load Model for Stability Analysis .....	17
<b>Section 8 Base Case Topology</b> .....	<b>18</b>
8.1 Summary of Base Case Topology.....	18
8.2 Modeling Existing and Proposed Generation .....	21
8.3 Base Cases for PPA Studies and System Impact Studies.....	21
8.4 Coordinating Ongoing Studies.....	21
8.5 Base Case Sensitivities .....	22
8.6 Modeling Projects with Different In-Service Dates .....	22
<b>Section 9 Generator Ratings</b> .....	<b>23</b>
9.1 Overview of Generator Real Power Ratings .....	23
9.2 Generator Ratings in Steady-State Needs Assessments, Solutions Studies, and NPCC Area Review Analyses.....	24
9.3 Generator Ratings in PPA Studies and System Impact Studies .....	24
9.4 Generator Ratings in Stability Studies .....	24
9.5 Generator Ratings in Forward Capacity Market Studies .....	25
9.6 Generator Reactive Ratings .....	25
<b>Section 10 Generators Out of Service in Base Case</b> .....	<b>26</b>

<b>Section 11 Determination of Generation Dispatch in Base Case</b> .....	<b>27</b>
11.1 Overview.....	27
11.2 Treatment of Different Types of Generation.....	27
11.3 Treatment of Wind Generation.....	28
11.4 Treatment of Conventional Hydro Generation.....	28
11.5 Treatment of Pumped Storage Hydro.....	29
11.6 Treatment of Fast Start Generation.....	29
11.7 Treatment of Solar Generation.....	29
11.8 Treatment of Demand Resources.....	30
11.9 Treatment of Combined Cycle Generation.....	30
11.10 Generator Dispatch in Stability Studies.....	31
<b>Section 12 Contingencies</b> .....	<b>32</b>
12.1 Basis for Contingencies Used in Planning Studies.....	32
12.2 Contingencies in Steady-State Analysis.....	32
12.3 Contingencies in Stability Analysis.....	32
12.4 N-1 Contingencies.....	33
12.5 N-1-1 Contingencies.....	34
12.6 Extreme Contingencies.....	34
12.7 Line Open Testing.....	36
<b>Section 13 Interfaces/Transfer Levels To Be Modeled</b> .....	<b>37</b>
13.1 Overview.....	37
13.2 Methodology to Determine Transfer Limits.....	37
13.3 Modeling Assumptions – System Conditions.....	37
13.4 Stressed Transfer Level Assumptions.....	38
13.5 Transfer Level Modeling Procedures.....	38
<b>Section 14 Modeling Phase Angle Regulators</b> .....	<b>41</b>
<b>Section 15 Modeling Load Tap Changers</b> .....	<b>42</b>
<b>Section 16 Modeling Switchable Shunt Devices</b> .....	<b>43</b>
<b>Section 17 Modeling Series Reactors</b> .....	<b>44</b>
<b>Section 18 Modeling High Voltage Direct Current Lines</b> .....	<b>45</b>
<b>Section 19 Modeling Dynamic Reactive Devices</b> .....	<b>47</b>
<b>Section 20 Special Protection Systems (Remedial Action Schemes)</b> .....	<b>48</b>
<b>Section 21 Load Interruption Guidelines</b> .....	<b>49</b>
<b>Section 22 Short Circuit Studies</b> .....	<b>50</b>
<b>Section 23 Critical Load Level Analysis</b> .....	<b>51</b>
<b>Section 24 Bulk Power System Testing</b> .....	<b>52</b>
<b>Section 25 Treatment on Non-Transmission Alternatives</b> .....	<b>53</b>
<b>Section 26 Power Flow Study Solution Settings</b> .....	<b>54</b>
26.1 Area Interchange.....	54



26.2 Phase-Angle Regulators .....	54
26.3 Transformer Load Tap Changers .....	54
26.4 Shunt Reactive Devices .....	55
26.5 Series Reactive Devices .....	56
26.6 High Voltage Direct Current Lines .....	56
<b>Appendix A – Definitions .....</b>	<b>57</b>
<b>Appendix B – Fast Start Units .....</b>	<b>62</b>
<b>Appendix C – Guidelines for Treatment of Demand Resources in System Planning Analysis .....</b>	<b>63</b>
<b>Appendix D – Dynamic Stability Simulation Damping Criteria .....</b>	<b>64</b>
<b>Appendix E – Dynamic Stability Simulation Voltage Sag Criteria .....</b>	<b>65</b>
<b>Appendix F – Stability Task Force Presentation to Reliability Committee-September 9, 2000 .....</b>	<b>66</b>
<b>Appendix G – Reference Document for Base Modeling of Transmission System Elements in New England .....</b>	<b>67</b>
<b>Appendix H – Position Paper on the Simulation of No-Fault Contingencies.....</b>	<b>68</b>

***Note: This page intentionally left blank.***

## Section 1

### Introduction

This guide describes the current standards, criteria and assumptions used in various transmission planning studies in New England.

Section 1 of this guide describes its purpose and the source of the standards, criteria and assumptions used in transmission planning studies. Section 2 describes the various types of transmission planning studies that use these standards, criteria and assumptions. Sections 3 and 4 discuss thermal and voltage ratings used in planning studies.

The remaining sections each describe the different assumptions that are utilized in transmission planning studies and the basis for these assumptions. The assumptions are presented in an order that is useful to a planner performing a transmission planning study.

Sections 5, 6 and 7 discuss modeling load in different types of transmission planning studies. Section 8 discusses the topology, transmission system and generators, used in different types of transmission planning studies. Sections 9-11 describe assumptions associated with generators. Section 12 discusses contingencies and Section 13 discusses interface stresses.

Sections 14- 20 discuss modeling of specific types of equipment. The remaining sections describe specific parts of planning studies.

Capitalized terms in this guide are defined in Section I of the Tariff or in Section 2 or Appendix A of this guide.

The provisions in this document are intended to be consistent with ISO New England's Tariff. If, however, the provisions in this planning document conflict with the Tariff in any way, the Tariff takes precedence as the ISO is bound to operate in accordance with the ISO New England Tariff.

#### 1.1 Purpose

---

The purpose of this guide is to clearly articulate the current assumptions used in planning studies of the transmission system consisting of New England Pool Transmission Facilities ("PTF"). Pursuant to Attachment K, ISO New England ("the ISO" or "ISO-NE") is responsible for the planning of the PTF portion of New England's transmission system. Pool Transmission Facilities are the transmission facilities owned by Participating Transmission Owners ("PTOs"), over which the ISO exercises Operating Authority in accordance with the terms set forth in the Transmission Operating Agreement, rated at 69 kV and above, except for lines and associated facilities that contribute little or no parallel capability to the PTF. The scope of PTF facilities is defined in Section II.49 of the ISO New England Open Access Transmission Tariff ("OATT" or "Tariff").

The PTO's are responsible for planning of the Non-PTF and coordinating such planning efforts with the ISO. The planning assumptions in this guide apply to the non-PTF transmission system when studying upgrades to the non-PTF transmission system which will result in new or modified PTF transmission facilities. The PTO's establish the planning assumptions for planning of the Non-PTF which does not impact the PTF. Section 6 of Attachment K to the OATT describes the responsibilities for planning the PTF and non-PTF transmission systems.

The planning assumptions in this guide also apply to studies of the impacts of system changes on the PTF transmission system, the Highgate Transmission System, Other Transmission Facilities, and Merchant Transmission Facilities. This includes studies of the impacts of Elective Transmission Upgrades and generator interconnections, regardless of the point of interconnection.

## 1.2 Reliability Standards

---

ISO New England establishes reliability standards for the six-state New England region on the basis of authority granted to the ISO by the Federal Energy Regulatory Commission. Because New England is part of a much larger power system, the region also is subject to reliability standards established for the northeast and the entire United States by the Northeast Power Coordinating Council and the North American Electric Reliability Corporation.

The standards, criteria and assumptions used in planning studies are guided by a series of reliability standards and criteria:

- North American Electric Reliability Corporation (“NERC”) Reliability Standards for Transmission Planning (“TPLs”) which apply to North America. These standards can be found on the NERC website at <http://www.nerc.com/page.php?cid=2|20>
- Northeast Power Coordinating Council (“NPCC”) Design and Operation of the Bulk Power Systems (Directory #1) which describes criteria applicable to Ontario, Quebec, Canadian Maritimes, New York and New England. These criteria can be found at the NPCC website at <https://www.npcc.org/Standards/Directories/Forms/Public%20List.aspx>
- ISO New England Planning and Operating Procedures which apply to New England except for the northern section of Maine that is not directly interconnected to the rest of the United States but is interconnected to New Brunswick. These standards can be found at the ISO-NE website at [http://www.iso-ne.com/rules\\_proceeds/index.html](http://www.iso-ne.com/rules_proceeds/index.html)

NERC, NPCC and ISO-NE describe the purpose of their reliability standards and criteria as:

- NERC describes the intent of Transmission Planning Standards, its TPLs, as providing for system simulations and associated assessments that are needed periodically to ensure that reliable systems are developed that meet specified performance requirements with sufficient lead time, and that continue to be modified or upgraded as necessary to meet present and future system needs.
- NPCC describes the intent of its criteria as providing a “design-based approach” to ensure the Bulk Power System is designed and operated to a level of reliability such that the loss of a major portion of the system, or unintentional separation of a major portion of the system, will not result from any design contingencies.
- ISO-NE, in its Planning Procedure No. 3 (“PP-3”), describes that the purpose of the New England Reliability Standards is to assure the reliability and efficiency of the New England bulk power supply system through coordination of system planning, design and operation.

The ISO-NE planning standards and criteria, which are explained in this guide, are based on the NERC, NPCC and ISO-NE specific standards and criteria, and are set out for application in the region in ISO-NE Planning and Operation procedures. As the NERC registered Planning Authority, ISO-NE has the responsibility to establish procedures and assumptions that satisfy the intent of the NERC and NPCC standards.

## Section 2

### Types of Transmission Planning Studies

There are a number of different types of planning studies conducted in New England which assess or reflect the capability of the transmission system, including Market Efficiency upgrade studies, operational studies and reliability studies. The focus of this guide is on reliability studies.

The major types of studies addressed in this guide are:

- Proposed Plan Application (“PPA”) Study-a study done to determine if any addition or change to the system has a significant adverse effect on stability, reliability or operating characteristics of the PTF or Non-PTF transmission system.(See Section I.3.9 of the OATT). Note that this does not need to be an independent study but can be submission or supplementation of another study such as a System Impact Study or Transmission Solutions Study as long as appropriate system conditions were included in that study.
- System Impact (“SIS”) Study-a study done to determine the system upgrades required to interconnect a new or modified generating facility (See Schedule 22 of the OATT, Section 7 and Schedule 23 of the OATT, Section 3.4), to determine the system upgrades required to interconnect an Elective Transmission Upgrade, or to determine the system upgrades required to provide transmission service pursuant to the OATT. A Feasibility Study is often the first step in the interconnection study process and may be done as part of the System Impact Study or separately.
- Transmission Needs Assessment-a study done to assess the adequacy of the PTF system (See OATT Section II, Attachment K, Section 4)
- Transmission Solutions Studies-a study done to develop regulated solutions to issues identified in a Transmission Needs Assessment of the PTF system (See OATT Section II, Attachment K, Section 4.2 (b))
- NPCC Area Review Analyses-a study to assess Bulk Power System reliability (See NPCC Directory #1, Appendix B)
- Bulk Power System (“BPS”) Testing-a study done to determine if Elements should be classified as part of the Bulk Power System (See NPCC Document A-10, Classification of Bulk Power System Elements)
- Transfer Limit Study-a study done to determine the range of megawatts that can be transferred across an interface under a variety of system conditions
- Interregional Study-a study involving two or more adjacent regions, for example New York and New England
- Overlapping Impact Study-the optional study that an Interconnection Customer may select as part of its interconnection studies. This study provides information on the potential upgrades required for the generation project to qualify as a capacity resource in the Forward Capacity Market. (See Schedule 22 of the OATT, Section 6.2 or 7.3)
- FCM New Resource Qualification Network Capacity Interconnection Standard Analyses-a study of the transmission system done to determine a list of potential Element or interface loading problems caused by a resource seeking to obtain a new or increased capacity supply obligation. This study is done if a System Impact Study for a generator interconnection is not complete. (See Planning Procedure 10, section 5.6)

- FCM New Resource Qualification Overlapping Impact Analyses-a study of the transmission system done to determine the deliverability of a resource seeking to obtain a new or increased capacity supply obligation. (See Planning Procedure 10, section 5.7)
- FCM Study for Annual Reconfiguration Auctions and Annual CSO Bilaterals-a study of the transmission system done to determine the deliverability of a resource seeking to obtain a new or increased capacity supply obligation. (See Planning Procedure 10, section 5.8)
- FCM Delist/Non-Price Retirement Analyses-a study of the transmission system done to determine the reliability impacts of delists and retirements. (See Planning Procedure 10, section 7)
- Transmission Security Analyses-a deterministic study done to determine the capacity requirements of import constrained load zones. (See Planning Procedure 10, section 6)

## Section 3

### Transmission Element Ratings

Planning utilizes the following thermal capacity ratings for transmission facilities, as described in ISO-NE Operating Procedure No. 16 Transmission System Data - Appendix A - Explanation of Terms and Instructions for Data Preparation of NX-9A (OP-16A):

- Normal  
Normal is a continuous 24 hour rating
- Long Time Emergency (“LTE”)  
LTE is a 12 hour rating in Summer and a 4 hour rating in Winter
- Short Time Emergency (“STE”)  
STE is a 15 minute rating

Summer equipment ratings (April 1 through October 31) and Winter equipment ratings (November 1 through March 31) are applied as defined in ISO-NE Operating Procedure 16. The twelve hour and four hour durations are based on the load shape for Summer and Winter peak load days.

The transmission Element ratings used in planning studies are described in ISO New England Planning Procedure 5-3 and in ISO New England Planning Procedure 7: Procedures for Determining and Implementing Transmission Facility Ratings in New England. In general, Element loadings up to normal ratings are acceptable for "All lines in" conditions. Element loadings up to LTE ratings are acceptable for up to the durations described above. Element loadings up to the STE ratings may be used following a contingency for up to fifteen minutes. STE ratings may only be used in limited situations such as in export areas where the Element loading can be reduced below the LTE ratings within fifteen minutes by operator or automatic corrective action.

There is also a Drastic Action Limit that is only used as a last resort during actual system operations where preplanned immediate post-contingency actions can reduce loadings below LTE within five minutes. Drastic Action Limits are not used in testing the system adequacy in planning studies or for planning the transmission system.

Element ratings are calculated per ISO New England Planning Procedure 7, and are submitted to ISO New England per ISO New England Operating Procedure 16: Transmission System Data.

## Section 4

### Voltage Criteria

#### 4.1 Overview

---

The voltage standards used for transmission planning have been established to satisfy three constraints: maintaining voltages on the distribution system and experienced by the ultimate customer within required limits, maintaining the voltages experienced by transmission equipment and equipment connected to the transmission system within that equipment's rating, and avoiding voltage collapse. Generally the maximum voltages are limited by equipment and the minimum voltages are limited by customer requirements and voltage collapse. Note: This Transmission Planning Technical Guide does not address voltage flicker or harmonics.

The voltage standards prior to equipment operation apply to voltages at a location that last for seconds or minutes, such as voltages that occur prior to transformer load tap changer ("LTC") operation or capacitor switching. The voltage standards prior to equipment operation do not apply to transient voltage excursions such as switching surges, or voltage excursions during a fault or during disconnection of faulted equipment.

The voltage standards apply to PTF facilities operated at a nominal voltage of 69 kV or above.

#### 4.2 Pre-Contingency Voltages

---

The voltages at all PTF buses must be in the range of 0.95-1.05 per unit with all lines in service.

There are two exceptions to this standard. The first is voltage limits at nuclear units, which are described in Section 4.9. The second exception is that higher voltages are permitted at buses where the Transmission Owner has determined that all equipment at those buses is rated to operate at the higher voltage. Often the limiting equipment under steady-state high voltage conditions is a circuit breaker. IEEE standard C37.06 lists the maximum voltage for 345 kV circuit breakers as 362 kV, the maximum voltage for 230 kV circuit breakers as 245 kV, the maximum voltage for 138 kV circuit breakers as 145 kV, the maximum voltage for 115 kV circuit breakers as 123 kV and the maximum voltage for 69 kV circuit breakers as 72.5 kV. Older 115 kV circuit breakers may have a different maximum voltage.

For testing N-1 contingencies, shunt VAR devices are modeled in or out of service pre-contingency, to prepare for high or low voltage caused by the contingency, as long as the pre-contingency voltage standard is satisfied. For testing of an N-1-1 contingency, shunt VAR devices are switched between the first and second contingencies to prepare for the second contingency as long as the post contingency voltage standard is satisfied following the first contingency and prior to the second contingency.

#### 4.3 Post-Contingency Low Voltages Prior to Equipment Operation

---

The lowest post-contingency voltages at all PTF buses must be equal to or higher than 0.90 per unit prior to the automatic or manual switching of shunt or series capacitors and reactors, and operation of tap changers on transformers, autotransformers, phase-shifting transformers and shunt reactors. Dynamic devices such as generator voltage regulators, STATCOMs, SVCs, DVARs, and HVDC equipment are assumed to have operated properly to provide voltage support when calculating these voltages.

Also capacitor banks that switch automatically with no intentional time delay (switching time is the time for the sensing relay and the control scheme to operate, usually a few cycles up to a second) may be assumed to have operated when calculating these voltages.

No contingency defined in Section 12.4 or 12.5 is allowed to cause a voltage collapse.



#### **4.4 Post-Contingency Low Voltages After Equipment Operation**

---

The lowest voltages at all PTF buses must be equal to or higher than 0.95 per unit after the switching of shunt or series capacitors and reactors, and operation of tap changers on transformers, autotransformers, phase-shifting transformers and shunt reactors.

There are two exceptions to this standard. The first is voltage limits at nuclear units. The other exception is that voltages as low as 0.90 per unit are allowed at a limited number of PTF buses where the associated lower voltage system has been designed to accept these lower voltages and where the change in voltage pre-contingency to post-contingency is not greater than 0.1 per unit. The planner should consult with the Transmission Owner and ISO-NE to determine if the second exception applies to any buses in the study area.

#### **4.5 Post-Contingency High Voltages Prior to Equipment Operation**

---

The standard for high voltages prior to corrective action is under development.

#### **4.6 Post-Contingency High Voltages After Equipment Operation**

---

The highest voltages at all PTF buses must be equal to or lower than 1.05 per unit.

The only exception is that higher voltages are permitted where the Transmission Owner has determined that all equipment at those buses is rated to operate at the higher voltage. The planner should consult with the Transmission Owner and ISO-NE to determine if the exception applies to any buses in the study area.

#### **4.7 Voltage Limits for Line End Open Contingencies**

---

There is no minimum voltage limit for the open end of a line if there is no load connected to the line section with the open end. If there is load connected the above standards for post-contingency low voltage apply.

The maximum voltage limit for the open end of a line is under development.

#### **4.8 Transient Voltage Response**

---

NERC is revising its transmission planning procedures to establish the requirement for transient voltage response criteria. This section will address those criteria once it is final.

## 4.9 Voltage Limits at Buses Associated with Nuclear Units

---

The minimum voltage limits at the following buses serving nuclear units, both for pre-contingency and for post-contingency after the switching of capacitors and operation of transformer load tap changers, are listed below. These limits apply whether or not the generation is dispatched in the study.

**Table 4-1**  
**Nuclear Unit Minimum Voltages**

<b>Critical Bus</b>	<b>Minimum Bus Voltage</b>
Millstone 345 kV bus	345 kV
Pilgrim 345 kV bus	343.5 kV
Seabrook 345 kV bus	345 kV
Vermont Yankee 115 kV bus	112 kV (1)

- (1) Due to the retirement of Vermont Yankee, the unique minimum voltage limit at Vermont Yankee 345 kV will be eliminated. The unique voltage limit at Vermont Yankee 115 kV will temporarily be 112 kV and will be eliminated within about three years dependent on NRC approval.

The minimum voltage requirements at buses serving nuclear units are provided in accordance with NERC Standard NUC-001 and documented in the appendices to Master Local Control Center Procedure MLCC 1.

## Section 5

### Assumptions Concerning Load

Load data is included in the power flow cases provided by ISO-NE. The following describes the make-up of the load data in those cases.

ISO New England's Planning Procedure 5-3: Guidelines for Conducting and Evaluating Proposed Plan Application Analyses states:

- Disturbances are typically studied at peak load levels in steady-state analysis since peak load levels usually promote more pronounced thermal and voltage responses within the New England Control Area than at other load levels. However, other load levels may be of interest in a particular analysis and, as appropriate, additional studies are conducted.

The following load levels are used in planning studies:

- Peak Load
- Intermediate Load
- Light Load
- Minimum Load

The Report of Capacity, Energy, Loads, and Transmission (CELT) is the primary source of assumptions for use in electric planning and reliability studies for the ISO New England Reliability Coordinator area. The CELT includes generators at their net output and customers with behind the meter generation at their net load or generation. In many planning studies, this generation is modeled at its gross output. When this is done, it is necessary to add generating station service loads and certain manufacturing loads, predominately mill load in Maine, to the CELT load forecast. These loads add approximately 1,464 megawatts of load that is not included in the CELT load forecast. About 1,100 megawatts of this is station service load and 364 MW is associated with the manufacturing loads. The amount of station service represented will be dependent on the generation that is in service. Station service should be turned off if the generation it is associated with is out of service, with the exception of station service to nuclear plants. Also specific large new loads, such as data centers and large green house facilities, are not generally included in the CELT load forecast, and may be included in the study depending on the degree of certainty that the large new load will come to fruition.

When assessing peak load conditions, 100% of the projected 90/10 summer peak load for the New England Control Area is used. The New England system experiences its peak load in the summer. The 90/10 Peak Load represents a load level that has a 10% probability of being exceeded due to variations in weather. Summer peak load values are generally obtained from the CELT report. This forecast includes losses of about 8% of the total load, 2.5% for transmission and large transformer losses and 5.5% for distribution losses. Thus the amount of customer load served is typically slightly less than the forecast. The peak load level is adjusted for modeling of Demand Resources as discussed in Section 11.8. The target load level for Peak Load is achieved by requesting a case with the 90/10 CELT forecast year and the study year being evaluated.

The Intermediate Load, Light Load and Minimum Load levels were derived from actual measured load, which is total generation plus net flows on external tie lines. These load levels include transmission losses and manufacturing loads. The loads in the base cases provided by ISO-NE are adjusted to account for these factors. Since actual measured load includes the impacts of distributed resources and distributed generation, no adjustments to ISO-NE bases cases are needed to address these impacts. The Intermediate Load, Light Load and Minimum Load will be reviewed periodically and may be adjusted in the future based on actual load levels.

The Intermediate Load level, also called the shoulder load level, represents both loads in off peak hours during the summer and loads during peak hours in the Spring and Fall. The Intermediate Load level was developed by

reviewing actual system loads for the three years (2011-2013) and approximating a value system loads were at or below 90% of the time (7884 hours.) The load level analysis used 500 MW increments and the current value was rounded down to account for the anticipated impact of continuing energy efficiency programs. The target load level of 18,000 MW for Intermediate Load is adjusted to 17,636 MW C to properly account for the manufacturing loads.

The Light Load level was developed by reviewing actual system loads for the last ten years and approximating a value system loads were at or below for 2000 hours. The load level analysis used 500 MW increments and the current value was rounded down to account for the anticipated impact of continuing energy efficiency programs. The target load level of 12,500 MW for Light Load is adjusted to 12,136 MW to properly account for the manufacturing loads.

In a similar fashion, the Minimum Load level was developed by reviewing actual minimum system loads, excluding data associated with significant outages such as after a hurricane. The original intent was to base the load level used on 500 MW increments and the value was rounded down to account for the anticipated impact of continuing energy efficiency programs. The original intent was to model 8,500 MW as the total of CELT load and manufacturing loads. However, the concept was never clearly documented and most studies have been based on a CELT load of 8,500 MW with the additional 364 MW of manufacturing load also reflected. This has been reviewed and is acceptable and therefore will be carried forward until such time that historic data shows that this value needs revision

Steady-state testing is done at summer load levels because equipment ratings are lower in the summer and loads are generally higher. Stability testing is always done at the Light Load level to simulate stressed conditions due to lower inertia resulting from fewer generators being dispatched and reduced damping resulting from reduced load. Except where experience has shown it is not necessary, stability testing is also done at peak loads to bound potential operating conditions and test for low voltages. Testing at the Minimum Load level is done to test for potential high voltages when line reactive losses may be low and fewer generators are dispatched resulting in lower availability of reactive resources.

The following table lists the load levels generally used in different planning studies:

**Table 5-1  
Load Levels Tested in Planning Studies**

<b>Study</b>	<b>Peak Load</b>	<b>Intermediate Load</b>	<b>Light Load</b>	<b>Minimum Load</b>
System Impact Study (Steady State)	Yes	Yes	(6)	(1)
System Impact Study (Stability)	Yes	No	Yes	No
PPA Study of Transmission (Steady State)	Yes	(2)	No	(1)
PPA Study of Transmission (Stability)	Yes	No	Yes	No
Transmission Needs Assessment (Steady State)	Yes	(2)	No	Yes
Transmission Needs Assessment (Stability)	Yes	No	Yes	No
Transmission Solutions Study (Steady State)	Yes	(2)	No	Yes
Transmission Solutions Study (Stability)	Yes	No	Yes	No
NPCC Area Review Analyses (Steady State)	Yes	No	No	No
NPCC Area Review Analyses (Stability)	Yes	No	Yes	No
BPS Testing (Steady State)	Yes	No	No	No
BPS Testing (Stability)	Yes	No	Yes	No
Transfer Limit Studies (Steady State)	Yes	(3)	No	No
Transfer Limit Studies (Stability)	Yes	No	Yes	No

<b>Study</b>	<b>Peak Load</b>	<b>Intermediate Load</b>	<b>Light Load</b>	<b>Minimum Load</b>
Interregional Studies	Yes	No	No	No
FCM New Resource Qualification Overlapping Impact Analyses (4)	Yes	No	No	No
FCM New Resource Qualification NCIS Analyses (4)	Yes	No	No	No
FCM Study for Annual Reconfiguration Auctions and Annual CSO Bilaterals (4) (5)	Yes	No	No	No
FCM Delist/Non-Price Retirement Analyses (4)	Yes	No	No	No
Transmission Security Analyses (4) (5)	Yes	No	No	No

- (1) Testing at a Minimum Load level is done for projects that add a significant amount of transmission (charging current) to the system or where there is significant generation that does not provide voltage regulation.
- (2) It may be appropriate to explicitly analyze intermediate load levels to assess the consequences of generator and transmission maintenance.

Critical outages and limiting facilities may sometimes change at load levels other than peak, thereby occasionally requiring transfer limit analysis at intermediate loads.

- (3) These studies are described in ISO New England Planning Procedure No. 10, Planning Procedure to Support the Forward Capacity Market.

Sensitivity analyses at load levels lower than peak are considered when such lower load levels might result in high voltage conditions, system instability or other unreliable conditions per ISO New England Planning Procedure No. 10.

Testing at Light Load is done when generation may be limited due to Light Load export limits

## Section 6

### Load Power Factor Assumptions

The power factor of the load is important in planning studies because it impacts the current flow in each transmission Element. For example, a 100 megawatt load causes about 500 amps to flow in a 115 kV line if it is at unity power factor and about 560 amps to flow if it is at 0.90 power factor. The larger current flow resulting from a lower power factor causes increased real power and reactive power losses and causes poorer transmission voltages. This may result in the need for replacing transmission Elements to increase their ratings, in the need for additional shunt devices such as capacitors or reactors to control voltages, or in a decrease in the ability to transfer power from one area to another.

Each transmission owner in New England uses a process that is specific and appropriate to their particular service area to determine the load power factor to be assumed for loads in its service territory. The following summarizes the methods used by transmission owners within the New England area to set the load power factor values to be used in modeling their systems at the 90/10 Peak Load:

**Table 6-1**  
**Power Factor Assumptions**

Company	Base Modeling Assumption
BHE	Uses Historical Power Factor (PF) values
CMP	Historical metered PF values (Long term studies use 0.955 lagging)
Municipal Utilities	Uses Historical PF values
National Grid	1.00 PF at Distribution Bus
NSTAR North	Individual Station 3 Year Average PF at Distribution Bus
NSTAR South	0.985 lagging PF at Distribution Bus
NU	0.990 lagging PF at Distribution Bus
UI	0.995 lagging PF at Distribution Bus
VELCO	Historical PF at Distribution Bus provided by Distribution Companies

The above power factor assumptions are also used in Intermediate Load and Light Load cases. The power factor at the Minimum Load level is set at 0.998 leading at the distribution bus for all scaling load in New England with the exception of:

1. Boston downtown load fed by NSTAR that is set to a power factor of 0.978 lagging at the distribution bus
2. Boston suburban load fed by NSTAR this is set to unity power factor at the distribution bus

The non-scaling load includes mill loads in Maine, MBTA loads in Boston, railroad loads in Connecticut and other similar loads.

ISO-NE Operating Procedure 17, Load Power Factor Correction, discusses load power factor and describes the annual survey done to measure compliance with acceptable load power factors.

## Section 7

### Load Models

#### 7.1 Load Model for Steady-State Analysis

---

In steady-state studies, loads are modeled as constant MVA loads, comprised of active (“real”) P and reactive (“imaginary”) Q loads. They are modeled by the Transmission Owners based on historical and projected data at individual buses, modeling equivalent loads that represent line or transformer flows. These loads may be modeled at distribution, sub-transmission, or transmission voltages.

#### 7.2 Load Model for Stability Analysis

---

Loads (including generator station service) are assumed to be uniformly modeled as constant impedances throughout New England and New York. The constant impedances are calculated using the P and Q values of the load. This representation is based on extensive simulation testing using various load models to derive the appropriate model from an angular stability point of view, as described in the 1981 NEPOOL report, “Effect of Various Load Models on System Transient Response.”

For under frequency load shedding analysis, other load models are sometimes used, such as either a polynomial combination of constant impedance, constant current and constant load; or a complex load model, including modeling of motors. The alternate modeling is based on the end use composition of the load.

Voltage stability analysis is sometimes done using a complex load model, including modeling of motors.

## Section 8

### Base Case Topology

#### 8.1 Summary of Base Case Topology

Base case topology refers to how system Elements are represented and linked together for the year(s) to be studied. System Elements modeled in base cases include, but are not limited to transmission lines, transformers, and other series and shunt Elements in New England, generators on the New England transmission system, generators on the New England distribution system, merchant transmission facilities in New England, and similar topology for adjacent systems.

There are a number of Tariff and practical considerations that determine the topology used for various types of planning studies. For example, Needs Assessments and Solutions Studies need to include the facilities that have a commitment to be available (e.g. an obligation in the Forward Capacity Market, a reliability upgrade with an approved PPA or a merchant facility with an approved PPA and an associated binding contract ) and need to exclude projects that are not committed to be available. For System Impact Studies for generation the studies need to include all active generators in the FERC section of the ISO-NE queue that have earlier (higher) queue positions. The starting point for the development of a base case is ISO-NE’s Model on Demand database which includes a model of the external system from the Multi-regional Modeling Working Group (“MMWG”). This Model on Demand data base is used to create ISO-NE’s portion of the MMWG base case. However the Model on Demand data base is updated periodically to include updated ratings, updated impedances and newly approved projects. The following table summarizes the topology used in planning studies:

**Table 8-1**  
**Base Case Topology**

Study	Transmission in New England	Generation in New England (7,8)	Merchant Facilities	Transmission outside New England	Generation outside New England
PPA Study of transmission project (Steady State and Stability)	In-Service, Under Construction, and Planned (1)	In-Service, Under Construction or has an approved PPA (1)	In-Service, Under Construction or has an approved PPA	Models from recent Multiregional Modeling Working Group (“MMWG”) base case	Models from recent MMWG base case
System Impact Study (Steady State and Stability)	In-Service, Under Construction, and Planned (1)	In-Service, Under Construction, or has an approved PPA or is included in FERC section of the ISO-NE queue (1)	In-Service, Under Construction or has an approved PPA	Models from recent MMWG base case	Models from recent MMWG base case
Transmission Needs Assessment (Steady State)	In-Service, Under Construction, Planned, and Proposed (6)	Has a capacity supply obligation or a binding contract (4)	In-Service, Under Construction, or has an approved PPA; and delivers an import with a capacity supply obligation or a binding contract (4); and has a certain ISD	Models from recent MMWG base case	Models from recent MMWG base case



<b>Study</b>	<b>Transmission in New England</b>	<b>Generation in New England (7,8)</b>	<b>Merchant Facilities</b>	<b>Transmission outside New England</b>	<b>Generation outside New England</b>
Transmission Solutions Study (Steady State and Stability)	In-Service, Under Construction, Planned, and Proposed (6)	Has a capacity supply obligation or a binding contract (4)	In-Service, Under Construction, or has an approved PPA: and delivers an import with a capacity supply obligation or a binding contract (4); and has a certain ISD	Models from recent MMWG base case	Models from recent MMWG base case
Area Review Analyses (Steady State and Stability)	In-Service, Under Construction, and Planned	In-Service, Under Construction, or has an approved PPA	In-Service, Under Construction, or has an approved PPA	Models from recent MMWG base case	Models from recent MMWG base case
BPS Testing Analyses (Steady State and Stability)	In-Service, Under Construction, and Planned	In-Service, Under Construction, or has an approved PPA	In-Service, Under Construction, or has an approved PPA	Models from recent MMWG base case	Models from recent MMWG base case
Transfer Limit Studies (Steady State and Stability)	In-Service, Under Construction, and Planned	In-Service, Under Construction or has an approved PPA	In-Service, Under Construction or has an approved PPA	Models from recent MMWG base case	Models from recent MMWG base case
Interregional Studies	In-Service, Under Construction, and Planned (2)	In-Service, Under Construction or has an approved PPA	In-Service, Under Construction or has an approved PPA	Models from recent MMWG base case	Models from recent MMWG base case
FCM New Resource Qualification Overlapping Impact Analyses (3) (4)	In-Service, or Under Construction, Planned, or Proposed with an In Service Date (ISD) certified by the Transmission Owner ("TO")	Existing resources and resources that have a capacity supply obligation	In-Service, Under Construction, Planned, or Proposed with an ISD certified by the Owner	Models from recent MMWG base case	Models from recent MMWG base case and generators which represent flows to/from external areas
FCM New Resource Qualification Network Resource Interconnection Standard Analyses (5)	In-Service or Under Construction, Planned, or Proposed with an ISD certified by the TO	Existing resources and resources that have a capacity supply obligation	In-Service, Under Construction, Planned, or Proposed with an ISD certified by the Owner	Models from recent MMWG base case	Models from recent MMWG base case and generators which represent flows to/from external areas

<b>Study</b>	<b>Transmission in New England</b>	<b>Generation in New England (7,8)</b>	<b>Merchant Facilities</b>	<b>Transmission outside New England</b>	<b>Generation outside New England</b>
FCM Study for Annual Reconfiguration Auctions and Annual CSO Bilaterals (5)	In-Service or Under Construction, Planned, or Proposed with an ISD certified by the TO	Existing resources and resources that have a capacity supply obligation	In-Service, Under Construction, Planned, or Proposed with an ISD certified by the Owner	Models from recent MMWG base case	Models from recent MMWG base case and generators which represent flows to/from external areas
FCM Delist/Non-Price Retirement Analyses (5)	In-Service or Under Construction, Planned, or Proposed with an ISD certified by the TO	Existing resources and resources that have a capacity supply obligation	In-Service, Under Construction, Planned, or Proposed with an ISD certified by the Owner	Models from recent MMWG base case	Models from recent MMWG base case and generators which represent flows to/from external areas
Transmission Security Analyses (5)	In-Service or Under Construction, Planned, or Proposed with an ISD certified by the TO	Existing resources and resources that have a capacity supply obligation	In-Service, Under Construction, Planned, or Proposed with an ISD certified by the Owner	N/A	N/A

- (1) Projects with a nearly completed PPA Study and that have an impact on this study are also considered in the base case. This includes transmission projects and generation interconnections to the PTF or non-PTF transmission system. Also generators without capacity supply obligations in the Forward Capacity Market are included in PPA Studies.
- (2) Some interregional studies may include facilities that do not have approved Proposed Plan Applications.
- (3) Base Cases for preliminary, non-binding overlapping impact analysis done as part of a generation Feasibility Study or generation System Impact Study are developed with input from the Interconnection Customer.
- (4) Section 4.2 of Attachment K describes that resources that are bound by a state-sponsored RFP or financially binding contract are represented in base cases.
- (5) These studies are described in ISO New England Planning Procedure No. 10, Planning Procedure to Support the Forward Capacity Market.
- (6) Sensitivity analysis may also be done to confirm the Proposed Projects in the Study Area continue to be needed.
- (7) Generators that have submitted a Non-Price Retirement Request are considered to be retired in the year associated with their Non-Price Retirement Request and in subsequent years.
- (8) In Transmission Needs Assessments and Transmission Solutions Studies, additional generators are often considered unavailable. Generators that have a rejected Permanent De-list bid are considered unavailable (See Attachment K 4.1.c). Also, generators that have delisted in the two most recent FCM auctions are considered unavailable. In addition, the ISO may consider generators unavailable because of circumstances such as denial of license extensions or being physically unable to operate.

## **8.2 Modeling Existing and Proposed Generation**

---

Generating facilities 5 megawatts and greater are listed in the CELT report and are explicitly modeled in planning study base cases. The current exception to this is generators 5 MW and greater that are “behind the meter” and do not individually participate in the ISO New England energy market. Some of these generators are netted to load. However, as these generators could have an impact on system performance, future efforts will be made to model these resources in greater detail. The ISO is collecting load flow, stability and short circuit models for generators 5 MW and greater that are new or being modified. Additional models such as PSCAD models are collected as necessary. For example a PSCAD model is often required for solar and wind generation connecting to the transmission system.

Generators less than 5 MW are modeled explicitly, either as individual units or as the equivalent of multiple units, or are netted to load. Generators connected to the distribution system are generally modeled at a low voltage bus connected to the transmission system through a load serving transformer.

## **8.3 Base Cases for PPA Studies and System Impact Studies**

---

Similar topology is used in base cases for PPA Studies for transmission projects and System Impact Studies. Both types of studies include projects in the Planned status in their base cases. However, projects with a nearly completed PPA Study and that have an impact on a study area are also considered in the base case.

Section 2.3 of Schedule 22 of the OATT states that base cases for generation interconnection Feasibility and System Impact Studies shall include all generation projects and transmission projects, including merchant transmission projects that are proposed for the New England Transmission System for which a transmission expansion plan has been submitted and approved by the ISO. This provision has been interpreted that a project is approved when it is approved under Section I.3.9 of the Tariff.

Sections 6.2 and 7.3 of Schedule 22 of the OATT further state that on the date the Interconnection Study is commenced, the base cases for generation interconnection studies shall also include generators that have a pending earlier-queued Interconnection Request to interconnect to the New England Transmission System or are directly interconnected to the New England Transmission System.

## **8.4 Coordinating Ongoing Studies**

---

At any point in time there are numerous active studies of the New England transmission system. The New England planning process requires study teams to communicate with other study teams to ascertain if the different teams have identified issues which may be addressed, in whole or in part, by a common solution, or if changes to the transmission system are being proposed that might impact their study. It is appropriate for a Needs Assessment, a Solutions Study or a Generator Interconnection Study to consider relevant projects that have nearly completed their PPA analyses. For example, a study of New Hampshire might consider a 345 kV line from New Hampshire to Boston that is a preferred solution in a Solutions Study of the Boston area, or, when issues in both areas are considered, may suggest a benefit of modifying a solution that has already progressed to the Proposed or the Planned stage.

## 8.5 Base Case Sensitivities

---

Often in transmission planning studies, there is uncertainty surrounding the inclusion of a resource, a transmission facility, or a large new load in the base case for a study. These uncertainties are handled by doing sensitivity analysis to determine the impact the inclusion or exclusion of a particular resource, transmission project or load has on the study results. Sensitivity studies are done to determine the impact of changes that are somewhat likely to occur within the planning horizon and may influence the magnitude of the need or the choice of the solution. Typically, stakeholder input is solicited at PAC meetings in determining the manner in which sensitivity results are factored into studies. Examples are resources that may be retired or added, and transmission projects that may be added, modified, or delayed. Sensitivity analysis usually analyzes a limited number of conditions for a limited number of contingencies.

## 8.6 Modeling Projects with Different In-Service Dates

---

In some situations it is necessary to do a study where the year of study is earlier than the in service dates of all the projects that need to be considered in the base case. In such situations it is necessary to also include a year of study that is after the in-service-dates of all relevant projects.

As an example, consider two generation projects in the ISO's queue. The first project has queue position 1000 and a Commercial Operation Date of 2018. The second project has queue position 1001 and a Commercial Operation Date of 2015. Sections 6.2 and 7.3 of Schedule 22 of the OATT require that the study of the project with queue position 1001 to include the project with queue position 1000. To accomplish this, the study of the project with queue position 1001 would be done with 2015 base case without the project with queue position 1000 and also with a 2018 base case that includes the project with queue position 1000 and any transmission upgrades associated with queue position 1000.

## Section 9

### Generator Ratings

#### 9.1 Overview of Generator Real Power Ratings

Within New England, a number of different real power (megawatt) ratings for generators connected to the grid are published. Examples of the different generator ratings are summarized in the table below. The detailed definitions of these ratings are included in Appendix A. CNRC and NRC values for New England generators are published each year in the CELT (Capacity, Energy, Loads, & Transmission) Report.<sup>1</sup> QC values are calculated based on recent demonstrated capability for each generator. The Capacity Supply Obligation value and QC values are published for each Forward Capacity Auction in the informational results filings to FERC.<sup>2</sup>

**Table 9-1**  
**Generator Real Power Ratings**

Capacity Network Resource Capability (“CNRC”) – Summer- (maximum output at or above 90 degrees Fahrenheit)	CNRC Summer is the maximum amount of capacity that a generator has interconnection rights to provide in Summer. It is measured as the net output at the Point of Interconnection and cannot exceed the generator’s maximum output at or above 90 degrees Fahrenheit
Capacity Network Resource Capability (“CNRC”) - Winter (maximum output at or above 20 degrees Fahrenheit)	CNRC Winter is the maximum amount of capacity that a generator has interconnection rights to provide in Winter. It is measured as the net output at the Point of Interconnection and cannot exceed the generator’s maximum output at or above 20 degrees Fahrenheit
Capacity Supply Obligation (“CSO”)	A requirement of a resource to supply capacity. This requirement can vary over time based on the resource’s participation in the Forward Capacity Market.
Network Resource Capability (“NRC”) -Summer (maximum output at or above 50 degrees Fahrenheit)	NRC Summer is the maximum amount of electrical output that a generator has interconnection rights to provide in Summer. It is measured as the net output at the Point of Interconnection and cannot exceed the generator’s maximum output at or above 50 degrees Fahrenheit
Network Resource Capability (“NRC”) –Winter (maximum output at or above 0 degrees Fahrenheit)	NRC Winter is the maximum amount of electrical output that a generator has interconnection rights to provide in Winter. It is measured as the net output at the Point of Interconnection and cannot exceed the generator’s maximum output at or above 0 degrees Fahrenheit
Qualified Capacity (“QC”)	QC is the amount of capacity a resource may provide in the Summer or Winter in a Capacity Commitment Period, as determined in the Forward Capacity Market qualification processes

In New England planning studies, except for the FCM studies, generators connected to the transmission system are generally modeled as a generator with its gross output, its station service load and its generator step-up transformer (“GSU”). In FCM studies, except for Network Capacity Interconnection Standard studies, generation is generally modeled net of station service load at the low voltage side of the GSU and station service load is set to zero. This is done because the CSO, QC and CNRC values are net values. One exception is

<sup>1</sup> <http://www.iso-ne.com/trans/celt/index.html>

<sup>2</sup> <http://www.iso-ne.com/regulatory/ferc/filings/index.html>

made in FCM-related studies for nuclear resources, where the generator is modeled at its gross output, in order to capture the need to maintain supply to the generator's station service load if the generator is out of service. Another exception is generating facilities composed of multiple smaller generators such as wind farms, solar and small hydro units. These facilities are often modeled as a single equivalent generator on the low voltage side of the transformer that interconnects the facility with the transmission system.

The ratings and impedances for an existing GSU are documented on the NX-9 form for that transformer. The existing generator's station service load is documented on the NX-12 form for that generator. Similar data is available from the Interconnection Requests for proposed generators. The generator's gross output is calculated by adding its appropriate net output to its station service load associated with that net output. GSU losses are generally ignored in calculating the gross output of a generator. This data is used by the ISO-NE to help create the base cases for planning studies.

In New England planning studies, generators connected to the distribution system are generally modeled as connected to a low voltage bus that is connected to a transformer that steps up to transmission voltage or netted to distribution load. Multiple generators connected to the same low voltage bus may be modeled individually or as an equivalent generator.

## **9.2 Generator Ratings in Steady-State Needs Assessments, Solutions Studies, and NPCC Area Review Analyses**

---

The Summer Qualified Capacity value is used to represent a machine's maximum real power output (megawatt) for all load levels studied except for Light Load (when applicable) and Minimum Load Studies. QC is used in these studies because QC represents the recently demonstrated capability of the generation. The QC value is the maximum Capacity Supply Obligation that a resource may obtain in the Forward Capacity Market. Any requested reduction in obligation from a resource's QC is subject to a reliability review and may be rejected for reliability reasons. The Capacity Network Resource Capability acts as an approved interconnection capability cap within the Forward Capacity Market that limits how much a resource could increase its QC without an Interconnection Request. In other words, QC cannot exceed CNRC. Because QC corresponds to the recently demonstrated capability, as opposed to CNRC which is the upper limit of the capacity capability of a resource, using QC instead of CNRC does not overstate the amount of capacity that could potentially be obligated to provide capacity to the system.

For reliability analysis conducted at Light Load and Minimum Load Levels, the generator's Summer NRC value (maximum megawatt output at or above 50 degrees) is used. Some generators have higher individual resource capabilities at 50 degree ratings compared with 90 degrees. Therefore, using 50 degree ratings allows a smaller number of resources to be online to serve load. The fewer the number of resources online, the less overall reactive capability on the system to mitigate high voltage concerns. This value is also consistent with the expected ratings of machines at the temperatures that are typically experienced during lighter load periods in the summer rating period.

## **9.3 Generator Ratings in PPA Studies and System Impact Studies**

---

The generator's Summer NRC value is used to represent a machine's maximum real power output (megawatts) for all load levels. For generator System Impact Studies, using this value ensures that studies match up with the level of service being provided. Studying Elective Transmission Upgrades and transmission projects with machines at these ratings also ensures equal treatment when trying to determine the adverse impact to the system due to a project.

## **9.4 Generator Ratings in Stability Studies**

---

The generator's Winter NRC value is used to represent a machine's maximum real power output (megawatts) for all load levels in all stability studies. Using the Winter NRC values ensures that stressed dispatches (in terms of

limited inertia on the system and internal generator rotor angles) are studied and addressed, therefore ensuring reliable operation of the system in real-time. This operability is required because real-time power system analysis is unable to identify stability concerns or determine stability limits that may exist on the system. These limits are determined in offline operational studies performed in a manner that ensures that they are applicable over a wide range of system conditions, including various ambient temperatures and load levels.

## **9.5 Generator Ratings in Forward Capacity Market Studies**

---

The generator's Summer CNRC value is used to represent a machine's maximum real power output (megawatts) for FCM New Resource Qualification Overlapping Impact Analyses. This output represents the level of interconnection service that a generator has obtained for providing capacity.

The generator's Summer NRC value is used to represent a machine's maximum real power output (megawatts) for FCM New Resource Qualification NCIS Analyses. This output represents the level of interconnection service that a generator has obtained for providing energy.

The generator's Summer QC value is used to represent a machine's maximum real power output (megawatts) for FCM Delist/Non-Price Retirement Analyses and Transmission Security Analyses. This output represents the expected output of a generator during Summer peak periods.

The lower of a generator's Summer QC value or Summer Capacity Supply Obligation is used to represent a machine's maximum real power output (megawatts) for FCM Study for Annual Reconfiguration Auctions and Annual CSO Bilaterals. This output represents the expected capacity capability of a generator during Summer peak periods.

## **9.6 Generator Reactive Ratings**

---

This section is under development.

## Section 10

### Generators Out of Service in Base Case

In Transmission Needs Assessments and Transmission Solutions Studies, generally two generation resources are considered out of service in the study area. These resources can be individual generators or interdependent generating facilities such as combined-cycle units (see section 11.9). The most impactful generators, those whose outage creates the greatest stress on the portion of transmission system under study, are considered out of service. Identifying the most impactful generators may in itself require some analysis. Additional generators could be considered to be out of service if the area under study has a large population of generators or if examining Intermediate, Light or Minimum Load maintenance conditions. Often multiple base cases are required to assess the impact of different combinations of generators being out of service. In general, having several generators out in a base case addresses issues such as the following:

- Higher generator forced outage rates than other transmission system Elements
- Higher generator outages and limitations during stressed operating conditions such as a heat wave or a cold snap
- Past experience with simultaneous unplanned outages of multiple generators
- High cost of Reliability Must Run Generation
- Generator maintenance requirements
- Unanticipated generator retirements
- Fuel shortages

In some of the other transmission planning studies listed in Section 2, the most impactful single generators are considered out of service in the base cases and other generators may be turned off in order to create system stresses. For example, in FCM overlapping impact studies, the system is stressed by assuming that the most impactful helper is out of service. The most impactful helper is the generator that, when placed in service at its full output, will result in the most significant reduction in the flow on the limiting element.



## Section 11

### Determination of Generation Dispatch in Base Case

#### 11.1 Overview

Different types of studies are conducted to achieve different transmission planning objectives. Therefore, it is necessary to consider the different range of anticipated generator capabilities which are appropriate to the objectives of study and the specific conditions which are being examined.

#### 11.2 Treatment of Different Types of Generation

The following table lists the maximum generation levels generally used in different planning studies. Generators, when dispatched, are usually dispatched up to their maximum output in a study.

**Table 11-1  
Generator Maximum Power Output in Planning Studies**

Study	Conventional Generation	Fast Start Generation	Hydro (1) Generation	Wind Generation	Solar Generation
System Impact Study (Steady State)	Summer NRC	Summer NRC	Summer NRC	Summer NRC	Summer NRC
System Impact (Stability)	Winter NRC	Winter NRC	Winter NRC	Winter NRC	Winter NRC
PPA Study of Transmission (Steady State)	Summer NRC	Summer NRC	Summer NRC	Summer NRC	Summer NRC
PPA Study of Transmission (Stability)	Winter NRC	Winter NRC	Winter NRC	Winter NRC	Winter NRC
Transmission Needs Assessment (Steady State)	Summer QC	Summer QC	Historical Level	5% of nameplate for on-shore wind (2)	Summer QC
Transmission Solutions Study (Steady State)	Summer QC	Summer QC	Historical Level	5% of nameplate for on-shore wind (2)	Summer QC
Transmission Solutions Study (Stability)	Winter NRC	Winter NRC	Winter NRC	Winter NRC	Winter NRC
Area Review Analyses (Steady State)	Summer NRC	Summer NRC	Summer NRC	Summer NRC	Summer NRC
Area Review Analyses (Stability)	Winter NRC	Winter NRC	Winter NRC	Winter NRC	Winter NRC
BPS Testing Analyses (Steady State)	Summer NRC	Summer NRC	Summer NRC	Summer NRC	Summer NRC
BPS Testing Analyses(Stability)	Winter NRC	Winter NRC	Winter NRC	Winter NRC	Winter NRC
Transfer Limit Studies (Steady State)	Summer NRC	Summer NRC	Summer NRC	Summer NRC	Summer NRC
Transfer Limit Studies (Stability)	Winter NRC	Winter NRC	Winter NRC	Winter NRC	Winter NRC

(1) Table lists treatment on conventional hydro. The treatment of pumped storage hydro is described in Section 11.5.

(2) 20% of the nameplate for off-shore wind

<b>Study</b>	<b>Conventional Generation</b>	<b>Fast Start Generation</b>	<b>Hydro (1) Generation</b>	<b>Wind Generation</b>	<b>Solar Generation</b>
Interregional Studies	Summer NRC	Summer NRC	Summer NRC	Summer NRC	Summer NRC
FCM New Resource Qualification Overlapping Impact Analysis	Summer CNRC	Summer CNRC	Summer CNRC	Summer CNRC	Summer CNRC
FCM New Resource Qualification Network Capacity Interconnection Standard Analyses	Summer NRC	Summer NRC	Summer NRC	Summer NRC	Summer NRC
FCM Delist/Non-Price Retirement Analyses	Summer QC	Summer QC	Summer QC	Summer QC	Summer QC
FCM Study for Annual Reconfiguration Auctions and Annual CSO Bilaterals	Lower of Summer QC or CSO	Lower of Summer QC or CSO	Lower of Summer QC or CSO	Lower of Summer QC or CSO	Lower of Summer QC or CSO
Transmission Security Analyses	Summer QC	Summer QC	Summer QC	Summer QC	Summer QC

(1) Table lists treatment on conventional hydro. The treatment of pumped storage hydro is described in Section 11.5.

### 11.3 Treatment of Wind Generation

Studies of wind generation in New England reveal that the output of on-shore (land-based) wind generation can be very low during Summer peak load hours.<sup>3</sup> In general, when it is needed to support area transmission requirements, on-shore wind generation is modeled at 5% of nameplate and off-shore wind is modeled at 20% of nameplate for Needs Assessment and Solutions Studies. If a wind farm’s Qualified Capacity is lower than the above value, the Qualified Capacity will be used in Needs Assessments and Solutions Studies.

The above percentages are estimates of the level of wind generation output that can be counted on during Summer peak for reliability analysis. To ensure that the interconnection rights of wind resources are preserved, wind generation is modeled at its NRC value in PPA studies.

### 11.4 Treatment of Conventional Hydro Generation

There are two classifications of conventional hydro, those hydro facilities that have no control over water flow, for example no capability to store water, and those hydro facilities that can control water flow, for example those facilities with a reservoir or river bed that can store water. For the purpose of planning studies, hydro facilities listed as “hydro (weekly cycle)” or “hydro (daily cycle-pondage)” in the CELT report are considered to be able to control water flow. Hydro facilities listed as “hydro (daily cycle-run of river)” in the CELT report, are assumed to have no ability to control water flow and are classified as intermittent resources. Hydro facilities that can control water flow are classified as non- intermittent resources. For both classifications the output of the hydro generation is set at its historic capability that can be relied on for reliability purposes or at 10% of nameplate, which is an estimate of that historic capability, in the base cases for Needs Assessments and Solutions Studies. Post contingency, conventional hydro that has the capability to control water flow and has sufficient water storage capability is dispatched up to 100% of its nameplate to relieve criteria violations in Needs and Solutions Analysis. Hydro facilities that have no control over water flow or limited water storage capability are dispatched at the same output pre and post contingency.

<sup>3</sup> This was discussed at the Planning Advisory Committee meetings on September 21, 2011 and October 22, 2014.

## 11.5 Treatment of Pumped Storage Hydro

---

There are three pumped storage-hydro plants connected to the New England Transmission System: Northfield Mountain and J. Cockwell (also known as Bear Swamp) in Massachusetts and Rocky River in Connecticut. Records indicate that these facilities historically have had limited stored energy during prolonged heat waves because limited time and resources are available to allow these units to refill their reservoirs during off-peak periods. Additionally J. Cockwell and Northfield are often used to provide reserve capacity. Based on this, the following generation levels are generally used in Needs Assessments and Solutions Studies.

**Table 11-2**  
**Pumped Storage Hydro Generation Levels**

<b>Generating Facility</b>	<b>Megawatt Output</b>
J. Cockwell	50% of Summer QC
Northfield Mountain	50% of Summer QC
Rocky River	Treated as conventional hydro with ponding capability

In Needs Assessments and Solutions Studies addressing the area that includes a pumped storage-hydro facility, the pumped storage-hydro facility in that area may also be dispatched at their maximum and/or minimum values to ensure that they can be utilized to serve load when they are available since they are often utilized in operations to provide reserve. In PPA studies, pumped storage-hydro plants are dispatched at their full output when necessary to show that their ability to supply load is maintained.

## 11.6 Treatment of Fast Start Generation

---

Fast start units are generally used as reserve for generation that has tripped off line, for peak load conditions, and to mitigate overloads or unacceptable voltage following a contingency, N-1 or N-1-1. Based on operating experience and analysis, 80% of fast start units in the study area are assumed to be available. However it is not appropriate to rely on any one specific fast start unit as the solution to an overload.

For the purpose of transmission planning studies, fast start units are those combustion turbines or diesel generators that can go from being off line to their full Seasonal Claimed Capability in 10 minutes. A list of fast start units has been developed by reviewing market information such as notification times, start times and ramp rates. The list is included as Appendix B in the guide. The capacity included in the list is from Forward Capacity Auction 8. The capacity of any generator may have changed and needs to be confirmed. The unit does not need to participate in the 10-minute reserve market to be considered a fast start unit in planning studies.

For the steady-state portion of Transmission Needs Assessments and Solutions Studies at peak load, the fast start units can be turned on in the base cases. When using this approach, criteria violations that can be mitigated by turning off fast start generation can be disregarded.

For Transmission Needs Assessments and Solutions Studies at Intermediate or Light load level, fast start units are turned off in the base cases and turned on to mitigate post-contingency criteria violations.

One exception to the above is that fast start generation in Vermont is not dispatched in the base case in Needs Assessments and Solutions Studies due to their past poor performance, but they are may be turned on between the first and second contingency.

## 11.7 Treatment of Solar Generation

---

Solar generation will be represented in the power flow base cases that are provided by ISO-NE. Solar generation with has a nameplates capacity of 5 MW or greater will be modeled explicitly as generators in all

base cases. Solar generation which is less than 5 MW will be modeled explicitly as a reduction to load in base cases representing peak loads. Solar generation less than 5 MW will not be modeled explicitly in the fixed load level cases representing shoulder, light and minimum loads, because the impact of solar generation was considered in the establishment of the fixed load levels (see Section 5, “Assumptions Concerning Load”).

The amount of solar generation represented in peak load base cases is based on the forecast developed by the Distributed Generation Forecast Working Group. This working group annually develops a forecast of the amount of solar generation expected to be connected in New England in future years. The amount of solar generation connected to the system that is represented in the models is derived by multiplying the nameplate capability by an adjustment factor of 26% which represents the output of solar generation during the peak load period between 4 p.m. and 6 p.m. in the summer. This is the time period when solar output begins to go down due the angle of the sun and when loads are still at or near the peak level. Solar generation is distributed among distribution buses using information on the location of solar generation provided by distribution companies and based on the location of solar generators over one MW that submit information as required by Planning Procedure PP 5-1.

Solar generation will be represented in peak power flow cases such that it does not affect the net power factor of the load. It is assumed that distribution companies will adjust their power factor correction programs to account for solar generation. At peak load levels, solar generation generally should reduce distribution VAR losses, therefore modeling solar power such that it does not impact net load power factor should be a slightly conservative approach.

## **11.8 Treatment of Demand Resources**

---

Through the Forward Capacity Market, Demand Resources (“DR”) can be procured to provide capacity and have future commitments similar to that of a generator. There are currently two categories of DR in the FCM: Passive Demand Resources (“Passive DR”) and Active Demand Resources (“Active DR”). Passive DR consists of two types of Resources: On-Peak and Seasonal Peak. Active DR reduces load based on ISO-NE instructions under real-time system conditions. Active DR consists of Real-Time Demand Response resources (“RTDR”) and Real-Time Emergency Generation resources (“RTEG”). After June 2017, RTDR will be replaced with Demand Response Capacity Resources (DRCR). In addition to the demand resources mentioned above that are procured through the FCM, the ISO forecasts Energy Efficiency as a part of the annual CELT forecast. This Energy Efficiency is a form of passive DR but is treated separately as it is forecasted beyond the FCM horizon. This DR is included for studies that analyze time periods beyond the FCM horizon.

The modeling of Demand Resources in planning studies varies with the type of study and the load level being studied. Demand Resources and their modeling are described fully in Appendix C, “Guidelines for Treatment of Demand Resources in System Planning Analyses”.

Demand Resources will not be modeled explicitly in the fixed load level cases representing shoulder, light and minimum loads, because the impact of Demand Resources was included in the actual measured load used to establish the fixed load levels (see Section 5, “Assumptions Concerning Load”).

## **11.9 Treatment of Combined Cycle Generation**

---

For the purposes of modeling generating units in a base case and in generator contingencies, all generators of a combined cycle unit are considered to be in-service at the same time or out-of-service together. The basis for this assumption is that many of the combustion and steam generators that make up combined cycle units cannot operate independently because they share a common shaft, they have air permit or cooling restrictions, or they do not have a separate source of steam. Other combined cycle units share a GSU or other interconnection facilities such that a fault on those facilities causes the outage of the entire facility. ISO New England’s operating history with combined cycle units has shown that even for units that claim to be able to operate in modes where one portion of the facility is out of service, they rarely operate in this partial mode.

## 11.10 Generator Dispatch in Stability Studies

---

At both Peak and Light load levels, generators are modeled at highest gross (maximum) MW output at 0° F or higher. Generators are generally dispatched either “full-on” at maximum capability, or “full-off.” If transmission transfers need to be adjusted, then the following is done:

- First, generators are re-dispatched by simulating them “full on” or “off”
- Second, adjust generators, if necessary, least critical to study results to obtain desired transfers (“off” or as close to “full on” as possible).

This is done to obtain generators’ maximum stressed internal angles in order to establish a stability limit under worst-case conditions. Generator reactive dispatch must also be considered for generators being evaluated for stability performance. Pre-fault reactive output is based on the Light Load voltage schedule in Operating Procedure OP-12.

## Section 12

### Contingencies

#### 12.1 Basis for Contingencies Used in Planning Studies

---

The contingencies that are tested in planning studies of the New England transmission system are defined in NERC, NPCC and ISO New England reliability standards and criteria. These standards and criteria form deterministic planning criteria. The application of this deterministic criteria results in a transmission system that is robust enough to operate reliably for the myriad of operating conditions that occur on the transmission system.

These standards and criteria identify certain contingencies that must be tested and the power flow in each Element in the system must remain under the Element's emergency limits following any specified contingency. In most of New England, the Long Time Emergency Rating is used as the emergency thermal limit. The Short Time Emergency Rating may be used as the emergency thermal limit when an area is exporting if generation can be dispatched lower to mitigate overloads. The Short Time Emergency Rating may be used as the emergency thermal limit in areas where phase-shifting transformers can be used to mitigate overloads. Voltage limits are discussed earlier in this guide.

Contingencies used for the design of the transmission system can be classified as:

- N-1, those Normal Contingencies (“NCs”) with a single initiating cause (a N-1 contingency may disconnect one or more transmission Elements)
- N-1-1, those NCs with two separate initiating causes and where timely system adjustments are permitted between initiating causes
- Extreme contingencies

Planning criteria allow certain adjustments to the transmission system between the two initiating causes resulting in N-1-1 contingencies as described in Section 12.5.

Steady-state analysis focuses on the conditions that exist following the contingencies. Stability analysis focuses on the conditions during and shortly after the contingency, but before a new steady-state condition has been reached.

#### 12.2 Contingencies in Steady-State Analysis

---

NERC and/or NPCC require that the New England Bulk Power System shall maintain equipment loadings and voltages within normal limits for pre-disturbance conditions and within applicable emergency limits for the system conditions following the contingencies described in Sections 12.4 and 12.5.

#### 12.3 Contingencies in Stability Analysis

---

NERC and NPCC require that the New England Bulk Power System shall remain stable and damped and the Nuclear Plant Interface Coordinating Standard (NUC-001-2 approved August 5, 2009) shall be met. This requirement must be met during and following the most severe of the contingencies stated below “With Due Regard to Reclosing”, and before making any manual system adjustments. For each of the contingencies below that involves a fault, stability and damping shall be maintained when the simulation is based on fault clearing initiated by the “system A” Protection Group, and also shall be maintained when the simulation is based on fault clearing initiated by the “system B” Protection Group where such protection group is required or where there would otherwise be a significant adverse impact outside the local area.

New England’s planning criteria defines a unit as maintaining stability when it meets the damping criteria in Appendix C of ISO-NE Planning Procedure No. 3 (also included as Appendix D to this guide). New England also uses the voltage sag guideline, which is included as Appendix E to this guide, to determine if it may be necessary to mitigate voltage sags.

Consistent with Operating Procedure OP-19, New England’s planning procedures require generator unit stability for all Normal Design Contingencies as defined in Planning Procedure PP-3. This criterion applies when the fastest protection scheme is unavailable at any BPS substation involved in the fault clearing. This criterion applies if the fastest protection scheme is available at any non-BPS substation involved in the fault clearing. If the fastest protection scheme is unavailable at a non-BPS substation, unit instability is permitted as long as the net source loss resulting from the Normal Design Contingency is not more than 1,200 MW, and the net source loss is confined to the local area (i.e. no generator instability or system separation can occur outside the local area).

The 1,200 MW limit derives from the NPCC Directory 1 criteria which require that a Normal Design Contingency have no significant adverse impact outside the local area. The maximum loss of source for a Normal Design Contingency has been jointly agreed upon by NYISO (formerly NYPP), ISO-NE (formerly NEPEX) and PJM to be between 1,200 MW and 2,200 MW depending on system conditions within NYISO and PJM. This practice is observed pursuant to a joint, FERC-approved protocol, which is Attachment G to the ISO-NE Tariff. The low limit of 1,200 MW has historically been used for Design Contingencies in New England.

**Table 12-1  
Protection Modeling in Stability Studies**

Station Type	Fastest Protection System Modeling for Normal Design Contingencies	
	Fastest Protection System In-Service	Fastest Protection System Out-of-Service
BPS	Not Tested	Tested
Non-BPS	Tested	Not Tested

## 12.4 N-1 Contingencies

NERC and/or NPCC require that the following N-1 contingencies be tested:

- a. A permanent three-phase fault with Normal Fault Clearing on any:
  - Generator
  - Transmission circuit
  - Transformer
  - Bus section
  - Series or shunt compensating device
- b. Simultaneous permanent phase-to-ground faults on:
  - Different phases of each of two adjacent transmission circuits on a multiple circuit transmission tower, with Normal Fault Clearing. If multiple circuit towers are used only for station entrance and exit purposes, and if they do not exceed five towers at each station, then this condition and other similar situations can be excluded from ISO-NE testing on the basis of acceptable risk, provided that the ISO approves the request for an exclusion. For exclusions of more than five towers, the ISO and the NPCC Reliability Coordinating Committee need to specifically approve each request for exclusion.
  - Any two circuits on a multiple circuit tower

- c. A permanent phase-to-ground fault, with Delayed Fault Clearing, on any:
  - Transmission circuit
  - Transformer
  - Bus section

This Delayed Fault Clearing could be due to malfunction of any of the following:

- Circuit breaker
  - Relay system
  - Signal channel
- d. Loss of any Element without a fault ( See Section 12.7)
  - e. A permanent phase-to-ground fault in a circuit breaker, with Normal Fault Clearing. (Normal Fault Clearing time for this condition may not be high speed.)
  - f. Simultaneous permanent loss of both poles of a direct current bipolar facility without an ac fault
  - g. The failure of any Special Protection System which is not functionally redundant to operate properly when required following the contingencies listed in "a" through "f" above.
  - h. The failure of a circuit breaker to operate when initiated by an SPS following: loss of any Element without a fault: or a permanent phase to ground with Normal Clearing, on any transmission circuit, transformer or bus section.

## 12.5 N-1-1 Contingencies

---

NERC and/or NPCC require that the N-1-1 contingencies be tested. These are events that have two initiating events that occur close together in time. The list of first initiating events tested must include events from all of the following possible categories of events:

- a. Loss of a generator
- b. Loss of a series or shunt compensating device
- c. Loss of one pole of a direct current bipolar facility
- d. Loss of a transmission circuit
- e. Loss of a transformer

Following the first initiating event, generation and power flows are adjusted in preparation for the next initiating event using units capable of ten-minute reserve, generator runback, generator tripping, phase angle regulators and high-voltage direct-current controls, transformer load tap changers, and switching series and shunt capacitors and reactors. Generator adjustments must not exceed 1,200 MW. The second events tested must include all of the contingencies in Section 12.4.

## 12.6 Extreme Contingencies

---

Consistent with NERC and NPCC requirements, New England tests extreme contingencies. This assessment recognizes that the New England transmission system can be subjected to events that exceed in severity the contingencies listed in Section 12.4 and 12.5. Planning studies are conducted to determine the effect of the following extreme contingencies on New England bulk power supply system performance as a measure of system strength. Plans or operating procedures are developed, where appropriate, to reduce the probability of



occurrence of such contingencies, or to mitigate the consequences that are indicated as a result of the simulation of such contingencies.

- a. Loss of the entire capability of a generating station.
- b. Loss of all transmission circuits emanating from a:
  - Generating station
  - Switching station
  - DC terminal
  - Substation (either all circuits at a single voltage level, or all circuits at any voltage level)
- c. Loss of all transmission circuits on a common right-of-way.
- d. Permanent three-phase fault on any:
  - Generator
  - Transmission circuit
  - Transformer or bus sectionwith Delayed Fault Clearing and with due regard to reclosing  
  
This Delayed Fault Clearing could be due to malfunction of:
  - Circuit breaker
  - Relay system
  - Signal channel
- e. The sudden dropping of a large load or major load center
- f. The effect of severe power swings arising from disturbances outside of New England
- g. Failure of a Special Protection System to operate when required following the normal contingencies listed in "a" through "f"
- h. The operation or partial operation of a Special Protection System for an event or condition for which it was not intended to operate
- i. Common mode failure of the fuel delivery system that would result in the sudden loss of multiple plants (i.e., gas pipeline contingencies, including both gas transmission lines and gas mains)

The following responses are considered unacceptable responses to an extreme contingency involving a three phase fault with Delayed Clearing and should be mitigated:

- Transiently unstable response resulting in wide spread system collapse
- Transiently stable response with undamped or sustained power system oscillations
- A net loss of source within New England in excess of 2,200 MW resulting from any combination of the loss of synchronism of one or more generating units, generation rejection initiated by a Special Protection System, tripping of the New Brunswick-New England tie, or any other system separation. The loss of source is net of any load that is interrupted as a result of the contingency.

The following response can be considered acceptable to an extreme contingency involving a three phase fault with Delayed Clearing:

- A net loss of source above 1,400 MW and up to 2,200 MW, resulting from any combination of the loss of synchronism of one or more generating units, generation rejection initiated by a Special Protection System,

or any other defined system separation, if supported by studies, on the basis of acceptable likelihood of occurrence, limited exposure to the pre-contingent operating conditions required to create the scenario, or efforts to minimize the likelihood of occurrence or to mitigate against the consequence of the contingency. The loss of source is net of any load that is interrupted as a result of the contingency. The 1,400 MW and 2,200 MW levels are documented in a NEPOOL Stability Task Force presentation to the NEPOOL Reliability Committee on September 9, 2000. This presentation is included as Appendix F to this guide.

## 12.7 Line Open Testing

---

The requirement to evaluate a no-fault contingency (often thought of as the opening of one terminal of a line) as a contingency event in transmission studies has been a topic for discussion over the years. The following describes how that requirement is addressed in New England. Additional detail is provided in the white paper that is included as Attachment H to this guide.

The following is a summary of the line open testing requirements:

1. NERC BES facilities:
  - a. Single contingency testing (N-1) - Evaluate the opening of the terminal of a line, independent of the design of the termination facilities.
  - b. First or Second contingency in N-1-1 testing – Not required
2. NPCC BPS and New England PTF facilities:
  - a. Single contingency testing (N-1) – Evaluate the opening of a single circuit breaker.
  - b. Second contingency in N-1-1 testing – Evaluate the opening of a single circuit breaker as the second contingency, not as the first contingency in the pair

When evaluating the no-fault contingencies pursuant to implementation of NERC, NPCC, and ISO New England criteria, the following will be used to establish the acceptability of post-contingency results and potential corrective actions:

- a. If voltage is within acceptance criteria and power flows are within the applicable emergency rating, operator action can be assumed as a mitigating measure.
- b. If voltage is outside of acceptance criteria or power flows are above the applicable emergency rating, operator action cannot be assumed as a mitigating measure. Mitigating measures may include, but are not limited to, transfer trip schemes detecting an open circuit breaker(s) or open disconnect switch(es), or, special protection systems (SPS) designed to trigger for specific system conditions that include the no fault opening of a transmission line.

Special consideration must be given to the design and operation of SPSs when evaluating this no fault contingency. An SPS may not operate for a line end open condition if its triggers are not satisfied, or may operate inappropriately if its triggers are satisfied but only one terminal of a line is open.

Generally, in New England, opening one end of a two terminal line is not a concern. However, in instances of long lines, high voltages may be a concern due to the charging associated with an unloaded line.

## Section 13

# Interfaces/Transfer Levels To Be Modeled

### 13.1 Overview

---

Reliability studies begin with development of system models which must include definition of the initial or base conditions that are assumed to exist in the study area over the study horizon. These assumed initial conditions must be based on requirements as described within the applicable reliability standards and criteria as well as supplemental information that describe system operating conditions likely to exist.

It is important to note that study assumptions used for interface transfer level analysis must always be coordinated with generator outage assumptions. Specifically, unit unavailability is only relevant to generation inside the boundaries of a specific local study area. On the other hand, interface transfer levels are adjusted to target levels by only varying generation resources outside the boundaries of the local study area. This approach ensures interface transfer levels are tested at appropriate levels while maintaining a disciplined approach to unit unavailability consideration.

### 13.2 Methodology to Determine Transfer Limits

---

In response to NERC standards, the ISO is documenting the methodology used to determine transfer limits. Once that methodology is finalized, it will be inserted into this guide.

### 13.3 Modeling Assumptions – System Conditions

---

NPCC’s Basic Criteria for Design and Operation of Interconnected Power Systems requires in Section 2.1 - Design Criteria, that planning entities include modeling of conditions that “stress” the system when conducting reliability assessments:

“Design studies shall assume power flow conditions utilizing transfers, load and generation conditions that stress the system. Transfer capability studies shall be based on the load and generation conditions expected to exist for the period under study. All reclosing facilities shall be assumed in service unless it is known that such facilities will be rendered inoperative.”

ISO-NE’s Reliability Standards for the New England Area Bulk Power Supply System also states in Section 3 - Area Transmission Requirements, that studies be conducted assuming conditions that “reasonably stress” the system:

“With due allowance for generator maintenance and forced outages, design studies will assume power flow conditions with applicable transfers, load, and resource conditions that reasonably stress the system. Transfers of power to and from another Area, as well as within New England, shall be considered in the design of inter-Area and intra-Area transmission facilities.”

In each case, an assumption that considers stressed system conditions with respect to transfer levels must be included in reliability studies. ISO-NE has the primary responsibility for interpreting these general descriptions.

Additionally, these requirements are confirmed by ISO-NE’s PP5-3, “Guidelines for Conducting and Evaluating Proposed Plan Application Analysis,” which sets forth the testing parameters for the required PPA approval under Section I.3.9 of ISO-NE’s Tariff. PP5-3 requires that “intra-area transfers will be simulated at or near their established limits (in the direction to produce ‘worst cases’ results).” Given the reliability standard obligations as well as the requirements for the PPA approval of any transmission upgrade, reasonably stressed transfer conditions that simulate interfaces at or near their defined limits are used in determining the transmission system needs.

## 13.4 Stressed Transfer Level Assumptions

---

The system is designed to preserve existing range of transfer capabilities. This is a requirement defined in ISO-NE Planning Procedure PP 5-3, the Reliability Standards for the New England Area Bulk Power Supply System and is a fundamental objective of the minimum interconnection standard. In order to meet this requirement, interfaces that may affect the area under study are modeled with transfer levels that cover the full range of existing capabilities. The review of interface stresses includes an evaluation of each interface internal to New England as well as interfaces between New England and adjacent control areas to determine the set of interfaces that may have a significant impact on the results of studies for the study area. Interfaces that are not directly connected to a study area but may have a significant effect on the study area interface are considered “coincident interfaces”. The procedures for selecting transfer levels for study area interfaces and coincident interfaces are provided below.

There may be a need to increase transfer capabilities as generation patterns shift across the system. General system trends in the direction of flow and magnitude may change dramatically over time. Some examples of conditions in which transfer capabilities requirements have changed include:

- The Connecticut area used to export across the Connecticut interface to eastern New England over many hours, but significant load growth and the outage of the nuclear units changed this to an import
- Whether the New Brunswick control area is an exporter to New England or an importer from New England can vary and depends on many factors including the availability of generation in New Brunswick.
- There has been an increase of “in-merit” natural gas generation being sited adjacent to existing gas pipelines in southern New England.
- Studies associated with the New England East West Solution have in the past been focused on the need to move power from across New England from east to west. The most recent update of these studies now shows the need to move power from west to east, even prior to consideration of the retirement of Salem Harbor station in 2014.

## 13.5 Transfer Level Modeling Procedures

---

Interfaces associated with a study area must be considered individually as well as in combination with each other when more than one interface is involved. Transfer levels for defined interfaces are tested based on the defined capability for the specific system conditions and system configurations to be studied. Transfer levels are also adjusted as appropriate for the load levels that are to be studied. Transfer level testing may require thermal, voltage and/or stability testing to confirm no adverse impact on transfer limits.

Interface transfer levels are tested up to their capability in order to sustain the economic efficiency of the electric system and reliable operation and transmission service obligations of the New England transmission system.

The following procedure is used when conducting system reliability assessments:

For the steady-state studies, the relevant interface transfer levels need to be determined up front for each dispatch in Needs Assessment studies. Solutions Study transfer levels are tested with the same transfer levels as tested in any associated Needs Assessment study as well as additional variations in transfer levels as determined to be appropriate to demonstrate that solution alternatives have not adversely affected any existing interface transfer capabilities.

In the past, Needs Assessments supported by ISO New England included base case conditions that simulated local generation outages simultaneously with power exports from New England to other Areas, such as New York. Simulation results that failed to meet system performance criteria (typically steady state thermal and voltage) would identify base case and contingency related system needs to be addressed.

In November, 2013, the ISO revised its practice with respect to Needs Assessments and Solutions Studies. Needs Assessments (steady state and dynamics) no longer model power exports to other Areas (New York, New Brunswick, and Quebec) in the base case conditions and N-1 contingency analysis when evaluating transmission system needs. As a result, reliability based needs and their related backstop transmission solutions will not be identified and developed to support power exports out of New England. The only exception to this policy change would be long term power exports realized through the Forward Capacity Market, such as certain power exports across the Cross Sound Cable, which will be modeled with 100 MW from New England to Long Island due to the Administrative Export De-list bid associated with Bear Swamp.

However testing required by NPCC Document A-10, Classification of Bulk Power System elements, as part of a Needs Assessment must consider the full range of potential operating conditions and therefore will continue to consider conditions where New England is exporting to other Areas.

Even with this decision by the ISO, planned system changes still need to respect Section I.3.9 of the Tariff, generally referred to as the PPA process. As part of the I.3.9 evaluation, the applicant must demonstrate that any proposed system changes do not have a significant adverse effect upon the reliability or operating characteristics of the Transmission Owner's transmission facilities, the transmission facilities of another Transmission Owner, or the system of a Market Participant, the Market Participant or Transmission Owner. In carrying out these responsibilities, testing must demonstrate that the project has not reduced transfer capability from pre-project levels.

Transfer level modeling when conducting a Needs Assessment are based on the dispatch conditions within the study area such that the transfer level = local load – local generation. The local area generation dispatch assumptions are consistent with stressed system modeling unit availability assumptions and provide the basis for the transfer level expected to exist for the area under study.

Transfer level modeling for Solutions Studies, in addition to modeling conditions as studied in any associated Needs Assessments, also includes modeling of system conditions that evaluate the ability to dispatch units with a capacity supply obligation within an area under heavy load conditions. ISO-NE may also determine that additional transfer level variations need to be tested in order to demonstrate that there is no adverse impact to existing interface transfer capabilities associated with any proposed solution alternatives.

Transfer level modeling for those cases in which more than one coincident interface (i.e. surrounding interfaces rather than an interface internal to the study area) can impact a study area is based on a set of transfer level combinations that includes the maximum and minimum values for each interface. This includes situations where the interface limits are not independent and for which simultaneous limits have been identified. For example, study of the Greater Boston area would consider the Boston Import interface as internal to the study and the North-South, SEMA/RI and East-West as coincident interfaces. Modeling of the Boston interface would be based on the procedures as described above. Modeling of the North-South, SEMA/RI and East-West interfaces would include those levels as shown in the table below.

Testing of coincident interfaces includes interface transfers modeled at high as well as low transfer levels. High transfer levels are modeled as close as possible to the defined maximum for an interface and low values are modeled as close as possible to the defined minimum for an interface. For example, if three interfaces can all affect a study area there will be eight variations in interface levels such that all combinations are tested:

**Table 13-1  
Example of Modeling Interface Flows in Planning Studies**

<b>Interface 1</b>	<b>Interface 2</b>	<b>Interface 3</b>
High	High	High
High	High	Low
High	Low	High
High	Low	Low
Low	Low	High
Low	High	Low
Low	High	High
Low	Low	Low

If specific transfer level combinations cannot be achieved due to load and/or dispatch constraints an explanation of the conditions that prevented testing of the combination is provided.

## Section 14

### Modeling Phase Angle Regulators

The modeling of each Phase Shifting Transformers (Phase Angle Regulators) is described in ISO New England's *Reference Document for Base Modeling of Transmission System Elements in New England*. This document is located in the ISO New England Planning Procedures subdirectory of the Rules & Procedures directory, on the ISO New England web site and is included as Appendix G to this guide. Modeling of phase shifting transformers in power flow studies is also addressed in Section 26.

Phase Shifting Transformers are used by system operators in the following locations within New England to control active (real) power flows on the transmission system within operating limits.

- The Saco Valley / Y138 Phase Shifter is located along the New Hampshire – Maine border, and is used to control 115 kV tie flow along the Y138 line into central New Hampshire
- The Sandbar Phase Shifter is located along the Vermont – New York border, and is used to control power flow into the northwest Vermont load pocket from northeast New York
- The Blissville Phase Shifter is located along the Vermont – New York border, and is mainly used to prevent overloads on the New York side
- The Granite Phase Shifters are located in Vermont and are mainly used to control flow on the 230 kV line between New Hampshire and Vermont
- The three Waltham Phase Shifters and the two Baker Street Phase Shifters are located in the Boston, Massachusetts area. They are adjusted manually to regulate the amount of flow into and through Boston.
- The Sackett Phase Shifter is located in southwest Connecticut and will be replaced by a series reactor in late 2017. It is run in manual mode mainly to draw power from Grand Avenue towards Mix Avenue Substation.
- The Northport / 1385 Phase Shifter, located at LILCO's Northport station (controlled by Long Island Power Authority) is used to control the power flow on the Norwalk Harbor – Northport 601, 602, and 603 submarine cables

## Section 15

### Modeling Load Tap Changers

Many transformers connected to the New England Transmission system have the capability of automatic load tap changing. This allows the transformer to automatically adjust the turns' ratio of its windings to control the voltage on the regulated side of the transformer. In transmission planning studies, load tap changers are allowed to operate when determining the voltages and flows after a contingency.

Modeling the operation of load tap changers on transformers that connect load to the transmission system generally produces conservative results because raising the voltage on the distribution system will reduce the voltage on the transmission system. Operation of load taps changers on autotransformers raises the voltage on the lower voltage transmission system (typically 115 kV) and reduces the voltage on the higher voltage transmission system (typically 230 kV or 345 kV).

In areas of the transmission system where there are known voltage concerns that occur prior to load tap changer operation, it is necessary to do sensitivity testing to determine if voltage criteria violations occur prior to load tap changer operation. This is further discussed in the voltage criteria section. Modeling of transformer load tap changers in load flow studies is also addressed in Section 26.



## Section 16

### Modeling Switchable Shunt Devices

In transmission planning studies, switchable shunt devices are allowed to operate when determining the voltages and flows after a contingency.

In areas of the transmission system where there are known high or low voltage concerns that occur prior to operation of switchable shunt devices, it is necessary to do testing to determine if voltage criteria violations occur prior to operation of switchable shunt devices. This is further discussed in the voltage criteria section 4. Modeling of switchable shunt devices in load flow studies is also addressed in Section 26.

## Section 17

### Modeling Series Reactors

There are 17 series reactors on the New England transmission system. Some of these are permanently in service to limit short circuit duty, others may be switched to control flows on specific transmission Elements. The following table lists these devices and briefly describes their purpose and operation in planning studies.

**Table 17-1**  
**Modeling Series Reactors in Planning Studies**

Device	Ohms	State	Normal Operation	Purpose
Breckwood series reactor in 1322 line	5.55 ohms	MA	Out of Service (Shorted)	Inserted to limit short circuit duty at Breckwood when 1T circuit breaker is closed
Cadwell Series Reactor in 1556 line	3.97 ohms	MA	In Service	Limits short circuit duty at 115 kV East Springfield substation, not to be switched in planning studies
Cadwell Series Reactor in 1645 line	3.97 ohms	MA	In Service	Limits short circuit duty at 115 kV East Springfield substation, not to be switched in planning studies
East Devon series reactor in 1497 line	1.32 ohms	CT	In Service	Limits short circuit duty on 115 kV system, not to be switched in planning studies
East Devon series reactor in 1776 line	1.32 ohms	CT	In Service	Limits fault duty on 115 kV systems, not to be switched in planning studies
Greggs series reactor in F162 line	10 ohms	NH	Out of Service (Shorted)	Controls flows on the 115 kV system, can be switched in to mitigate thermal overloads
Hawthorne series reactor in 1222 line	5 ohms	CT	Out of Service (Shorted)	Controls flows on the 115 kV system, can be switched in to mitigate thermal overloads
Mix Avenue series reactor in 1610	7.5 ohms	CT	In Service	Will be installed in late 2017 to control flows on the 115 kV system, not to be switched in planning studies
North Bloomfield series reactor in 1784 line	2.65 ohms	CT	In Service	Controls flows on the 115 kV system, can be by-passed to mitigate thermal overloads
North Cambridge series reactor in 329-530 line	2.75 ohms	MA	In Service	Limit flows and short circuit duty on 115 kV cables, not to be switched in planning studies
North Cambridge series reactor in 329-531 line	2.75 ohms	MA	In Service	Limit flows and short circuit duty on 115 kV cables, not to be switched in planning studies
Norwalk series reactor in 1637 line	5 ohms	CT	Out of Service (Shorted)	Controls flows on the 115 kV system, can be switched in to mitigate thermal overloads
Potter series reactor in 115-10-16 line	3 ohms	MA	In Service	Limit flows on 115 kV cables, not to be switched in planning studies
Sandbar Overload Mitigation Series reactor in PV-20 line	30 ohms	VT	Out of Service (Shorted)	Controls flows on the 115 kV system, can be switched in to mitigate thermal overloads
Southington series reactor in 1910 line	3.97 ohms	CT	In Service	Controls flows on the 115 kV system, can be by-passed to mitigate thermal overloads
Southington series reactor in 1950 line	3.97 ohms	CT	In Service	Controls flows on the 115 kV system, can be by-passed to mitigate thermal overloads
Woburn series reactor in 211-514 line	2.75 ohms	MA	In Service	Limit flows and short circuit duty on 115 kV cables, not to be switched in planning studies

## Section 18

### Modeling High Voltage Direct Current Lines

There are three existing high voltage direct current facilities on the New England Transmission System, Highgate, Hydro Quebec Phase 2 and the Cross Sound Cable and one future high voltage direct current facility with an approved PPA, Northern Pass Transmission. The following tables lists the flows on these facilities generally used in the base cases for different planning studies:

**Table 18-1**  
**Modeling Existing DC Lines in Planning Studies**

Study (1)	Highgate	Phase 2	Cross Sound Cable
PPA Study (I.3.9) of transmission project (Steady State and Stability)	0 to 225 MW towards Vermont at border	0 to 2000 MW towards New England	-330 to 346 MW towards Long Island
System Impact Study (Steady State and Stability)	0 to 225 MW towards Vermont at border	0 to 2000 MW towards New England	-330 to 346 MW towards Long Island
Transmission Needs Assessment (Steady State)	0 to 225 MW towards Vermont at border	0 to 2000 MW towards New England	0 to 346 MW towards Long Island
Transmission Solutions Study (Steady State and Stability)	0 to 225 MW towards Vermont at border	0 to 2000 MW towards New England	0 to 346 MW towards Long Island
Area Review Analyses (Steady State and Stability)	0 to 225 MW towards Vermont at border	0 to 2000 MW towards New England	0 to 346 MW towards Long Island
BPS Testing Analyses (Steady State and Stability)	0 to 225 MW towards Vermont at border	0 to 2000 MW towards New England	0 to 346 MW towards Long Island
Transfer Limit Studies (Steady State and Stability)	0 to 225 MW towards Vermont at border	0 to 2000 MW towards New England	-330 to 346 MW towards Long Island
Interregional Studies	0 to 225 MW towards Vermont at border	0 to 2000 MW towards New England	-330 to 346 MW towards Long Island
FCM New Resource Qualification Overlapping Impact Analyses	0 to 225 towards Vermont at border	0 to 1400 MW towards New England	0 MW
FCM New Resource Qualification NCIS Analyses	0 to 225 towards Vermont at border	0 MW towards New England	0 MW
FCM Delist/ Non-price Retirement Analyses	0 to qualified existing imports	0 to qualified existing imports	Qualified Administrative export to 0 MW
FCM Study for Annual Reconfiguration Auctions and Annual CSO Bilaterals	0 to cleared imports	0 to cleared imports	Cleared Administrative export to 0 MW
Transmission Security Analyses	Qualified existing imports	Qualified existing imports	0 MW

(1) Imports on these facilities are considered Resources as discussed in Planning Procedure PP5-6.

**Table 18-2  
Modeling Future DC Lines in Planning Studies**

<b>Study (1)</b>	<b>Northern Pass</b>
PPA Study (I.3.9) of transmission project (Steady State and Stability)	0 to1200 MW towards New Hampshire
System Impact Study (Steady State and Stability)	0 to1200 MW towards New Hampshire
Transmission Needs Assessment (Steady State)	0 MW
Transmission Solutions Study (Steady State and Stability)	0 MW
Area Review Analyses (Steady State and Stability)	0 to1200 MW towards New Hampshire
BPS Testing Analyses (Steady State and Stability)	0 to1200 MW towards New Hampshire
Transfer Limit Studies (Steady State and Stability)	0 to1200 MW towards New Hampshire
Interregional Studies	0 to1200 MW towards New Hampshire
FCM New Resource Qualification Overlapping Impact Analyses	0 MW
FCM New Resource Qualification NCIS Analyses	0 MW
FCM Delist/ Non-price Retirement Analyses	0 MW
FCM Study for Annual Reconfiguration Auctions and Annual CSO Bilaterals	0 MW
Transmission Security Analyses	0 MW

(1) Imports on this facility are considered Resources as discussed in Planning Procedure PP5-6

Modeling of high voltage direct current lines in load flow studies is also addressed in Section 26.

## **Section 19**

# **Modeling Dynamic Reactive Devices**

This section is under development

## Section 20

### Special Protection Systems (Remedial Action Schemes)

Special Protection Systems (“SPSs”) may be employed in the design of the interconnected power system subject to the guidelines in the ISO New England Planning Procedure 5-6 “Special Protection Systems Application Guidelines.” All SPSs proposed for use on the New England system must be reviewed by the Reliability Committee and NPCC and approved by the ISO. Some SPSs may also require approval by NPCC. The requirements for the design of SPSs are defined in the NPCC Directory #4 "Bulk Power System Protection Criteria" and the NPCC Directory #7 "Special Protection Systems".

The owner of the SPS must provide sufficient documentation and modeling information such that the SPS can be modeled by the ISO, and other planning entities, in steady-state and stability analyses. The studies that support the SPS must examine, among other things:

- System impact should the SPS fail to operate when needed
- System impact when the SPS acts when not needed
- Will the SPS function properly and acceptably during facility out conditions

Once a SPS is approved, its operation should be considered in all transmission planning studies.

## Section 21

### Load Interruption Guidelines

This section is under development.

Guidelines, which describe the amount of load that may be interrupted and the circumstances where load may be interrupted, were presented to the Reliability Committee (“RC”) on November 17, 2010. At the request of stakeholders, ISO-NE retransmitted this material to the RC on November 17, 2011 for comment and to the Planning Advisory Committee on November 21, 2011. ISO-NE has received comments on the guideline and is reviewing those comments.

## Section 22

### Short Circuit Studies

This section is under development.

NPCC requires that the transmission system be designed such that equipment capabilities are adequate for fault levels with all transmission and generating facilities in service. In New England, the base case for short circuit studies include transmission projects that are In-Service, Under Construction, and Planned and generators that are In-Service, Under Construction, are included in FERC section of the ISO-NE queue at the time the study begins, or have an approved Proposed Plan Applications. Projects with a nearly completed PPA Study and that have an impact on this study are also considered in the base case.

The voltage values that are used in short circuit studies are:

BHE-1.05 per unit  
CMP -1.05 per unit  
NGRID - 1.03 per unit  
NU (NSTAR) -1.03 per unit  
NU (CT, W. MA, NH) -1.04 per unit  
UI - 1.04 per unit  
Vermont- 1.05 per unit



## Section 23

### Critical Load Level Analysis

The Critical Load Level is the lowest load level at which the criteria violation occurs. One technique used to estimate Critical Load Level (“CLL”) for overloads is linear extrapolation. Other methods are also acceptable.

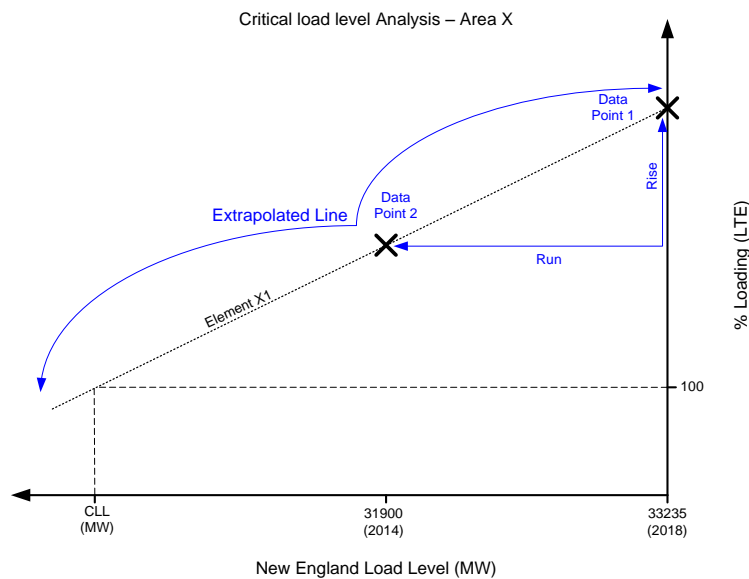
The linear extrapolation method is an approximation and provides a reasonable estimate with a minimum of additional analyses. The method requires that level of the loading on a transmission Element be determined at two load levels for the contingency or contingencies that have the largest impact on that transmission Element. This is done for each transmission Element that is overloaded. The load level in each base case is plotted on the x axis of a graph and percentage of the overload is plotted on y-axis. A straight line is drawn to connect these two points. The critical load level is the load level (x axis value) associated with 100 percent on the y axis.

An example of the use of linear extrapolation from a study of southwest Connecticut follows:

The initial base case was a 2018 base case. A second base case was developed by adjusting loads in the first case to 2014 year load levels taking into account the following:

- Loads plus losses in ISO-NE adjusted to 2009 CELT year 2014 levels (31,900 MW)
- Generation outside of CT was used to adjust to the new 2014 load levels
- Connecticut loads scaled according to 2009 RSP to 2014 levels (8,455 MW)
- Loads adjusted to account for FCA 3 cleared DR

No transmission topology changes were made to the adjusted 2014 cases. The highest overload per Element was identified in 2018 and the same Element’s loading was obtained from the 2014 case results. This was done for the same single contingency (N-1) or line-out plus contingency pair (N-1-1) for every case. That is, both N-1 and N-1-1 analysis were performed in order to obtain two data points (2018 and 2014). Using the two data points available, linear extrapolation was used to form a line loading equation (slope = rise / run,  $y = mx + b$ , etc.) for each monitored Element which can then provide the loading of a particular line for different New England load levels. As an example, below shows the extrapolated line for Element X1 in Area X for a thermal violation.



## **Section 24**

### **Bulk Power System Testing**

This section is under development.

## **Section 25**

### **Treatment on Non-Transmission Alternatives**

This section is under development.

## Section 26

### Power Flow Study Solution Settings

#### 26.1 Area Interchange

---

Enabling area interchange models the normal operation of the power system in that it adjusts generation to maintain inter-area transfers at a pre-determined level. Each area defined in the power system model has one of its generators designated as the area-slack bus. Area interchange is implemented by setting an overall interchange with all neighboring areas and the power flow program adjusts the output of the area-slack machines to match that set point. The area-slack bus for the New England Area is generally Brayton Point 3. For studies of the area near Brayton Point 3, a remote generator such as Seabrook in New Hampshire or Yarmouth 4 in Maine (also referred to as Wyman 4) is typically chosen as the area-slack bus.

Annually the Multiregional Modeling Working Group (“MMWG”) establishes the area interchange assumptions for different seasons, load levels, and years. These assumptions are included in base cases provided by the ISO. Requesting base cases from the ISO, which represent the scenarios that will be studied, ensures that area interchanges external to New England are appropriate.

In establishing a base case (N-0 or N-1) for a particular study, the planner selects the appropriate interchanges between New England and other areas. This should be done with area interchange enabled for tie lines and loads. This ensures that area interchanges external to New England are correct and that loads shared between New England and Quebec are accounted for properly. The planner should re-dispatch generation in New England to obtain the desired interchanges with areas external to New England. The area-slack bus will adjust its output for the change in losses resulting from this re-dispatch. The planner should verify that the generation at the area-slack bus is within the operating limits of that generator.

For contingency analysis, area interchange is generally disabled. This causes the system swing bus output in the power flow model to increase for any generation lost due to a contingency. Following a loss of generation, each generator in the Eastern Interconnection increases its output in proportion to its inertia. About 95% of the total inertia for the eastern interconnection is to the west of New England. The system swing bus in the New England base cases is Browns Ferry in TVA. Using the system swing bus to adjust for any lost generation appropriately approximates post-contingency conditions on the power system prior to system-wide governors reacting to the disturbance and readjusting output.

#### 26.2 Phase-Angle Regulators

---

The modeling of each Phase Shifting Transformers (Phase Angle Regular) is described in ISO New England’s *Reference Document for Base Modeling of Transmission System Elements in New England*. This document is located in the ISO New England Planning Procedures subdirectory of the Rules & Procedures directory, on the ISO New England web site and is included as Appendix G to this guide.

#### 26.3 Transformer Load Tap Changers

---

Transformer load tap changers (LTC’s) can exist on autotransformers, load serving transformers and transformers associated with generation (e.g. transformers associated with wind parks). LTC’s allow the ratio of

the transformer to be adjusted while the transformer is carrying load so that voltage on low voltage side of the transformer can be maintained at a pre-determined level.

An LTC adjusts voltage in small steps at a rate of about 3-10 seconds per step. A typical LTC may be able to adjust its ratio by plus or minus ten percent may have sixteen 5/8% steps. Also the action of an LTC is delayed to prevent operations during temporary voltage excursions. For example, a 345 kV autotransformer might delay initiating tap changing by thirty seconds. A load-serving transformer, which is connected to the 115 kV system near the autotransformer, might delay changing its tap by forty-five seconds to coordinate with the autotransformer. The total time for an LTC to adjust voltage can be several minutes. For example, a LTC, which has thirty-two 5/8% steps, requires five seconds per step and has a thirty second initial delay, would require seventy seconds to adjust its ratio by five percent.

To model the actual operations of the system, LTC operation is typically enabled in the power system model to allow the LTC's to adjust after contingencies for Steady State analysis. This generally represents the most severe condition because contingencies typically result in lower voltages and operation of LTC's to maintain distribution voltages result in higher current flow and lower voltages on the transmission system. Similarly operation of LTC's on autotransformers typically results in lower voltage on the high voltage side of the autotransformer.

In some portions of the transmission system, the voltage immediately following a contingency may be problematic because voltage collapse may occur. When instantaneous voltage is a concern, sensitivity analysis should be done with LTC's locked (not permitted to adjust) in the power flow model due to the amount of time required for the taps to move.

## **26.4 Shunt Reactive Devices**

---

This section is under development by the ISO/TO study coordination group and will be sent out at a later date.

## 26.5 Series Reactive Devices

Section 17 of this guide describes the series reactive devices in the New England transmission system. The following table lists those series reactive devices that can be switched to resolve criteria violations. Those devices that are out-of service in the base case can be switched into service. Those devices that are in-service in the base case can be switched out of service. The switching can be done post contingency if flows do not exceed STE ratings. When post contingency flows exceed STE ratings, switching must be done pre-contingency and analysis must be done to ensure that the switching does not create other problems.

**Table 26-1**  
**Modeling Series Reactors in Planning Studies**

Device	Base Case	Adjustments
Greggs series reactor in F162 line	Out of Service (Shorted)	Controls flows on the 115 kV system, can be switched in to mitigate criteria violations
Hawthorne series reactor in 1222 line	Out of Service (Shorted)	Controls flows on the 115 kV system, can be switched in to mitigate criteria violations
North Bloomfield series reactor in 1784 line	In Service	Controls flows on the 115 kV system, can be bypassed to mitigate criteria violations
Norwalk series reactor in 1637 line	In Service	Controls flows on the 115 kV system, can be bypassed to mitigate criteria violations
Sandbar Overload Mitigation Series reactor in PV-20 line	Out of Service (Shorted)	Controls flows on the 115 kV system, can be switched in to mitigate criteria violations. This reactor is controlled by a Special Protection System
South Agawam series reactor in 1821 line	In Service	Controls flows on the 115 kV system, can be bypassed to mitigate criteria violations
South Agawam series reactor in 1836 line	In Service	Controls flows on the 115 kV system, can be by-passed to mitigate criteria violations
Southington series reactor in 1910 line	In Service	Controls flows on the 115 kV system, can be by-passed to mitigate criteria violations
Southington series reactor in 1950 line	In Service	Controls flows on the 115 kV system, can be by-passed to mitigate criteria violations

## 26.6 High Voltage Direct Current Lines

The flows in higher voltage direct current lines are not automatically adjusted after a contingency except where an adjustment is triggered by a Special Protection System.

## Appendix A – Definitions

### **50/50 PEAK LOAD**

A peak load with a 50% chance of being exceeded because of weather conditions, expected to occur in New England at a temperature of 90.4°F.

### **90/10 PEAK LOAD**

A peak load with a 10% chance of being exceeded because of weather conditions, expected to occur in New England at a temperature of 94.2°F.

### **ADVERSE IMPACT**

See Significant Adverse Impact

### **APPLICABLE EMERGENCY LIMIT**

- These Emergency limits depend on the duration of the occurrence, and are subject to New England standards.
- Emergency limits are those which can be utilized for the time required to take corrective action, but in no case less than five minutes.
- The limiting condition for voltages should recognize that voltages should not drop below that required for suitable system stability performance, meet the Nuclear Plant Interface Requirements and should not adversely affect the operation of the New England Bulk Power Supply System.
- The limiting condition for equipment loadings should be such that cascading outages will not occur due to operation of protective devices upon the failure of facilities.

### **AREA**

An Area (when capitalized) refers to one of the following: New England, New York, Ontario, Quebec or the Maritimes (New Brunswick, Nova Scotia and Prince Edward Island); or, as the situation requires, area (lower case) may mean a part of a system or more than a single system.

### **AREA REVIEW ANALYSIS (see NPCC Directory #1, Appendix B)**

A study to assess bulk power system reliability

### **BULK ELECTRIC POWER SYSTEM (as defined in the NERC Glossary of Terms Used in Reliability Standards)**

As defined by the Regional Reliability Organization, the electrical generation resources, transmission lines, interconnections with neighboring systems, and associated equipment, generally operated at voltages of 100 kV or higher. Radial transmission facilities serving only load with one transmission source are generally not included in this definition.

### **BULK POWER SUPPLY SYSTEM**

The New England interconnected bulk power supply system is comprised of generation and transmission facilities on which faults or disturbances can have a significant effect outside of the local area.

### **BULK POWER SYSTEM TESTING (see NPCC Document A-10, Classification of Bulk Power System Elements)**

A study done to determine if Elements are classified as part of the Bulk Power System

**BULK POWER SYSTEM (as defined in NPCC Glossary of Terms Used in Directories)**

The interconnected electrical system within northeastern North America comprised of system elements on which faults or disturbances can have significant adverse impact outside the local area

**CAPACITY SUPPLY OBLIGATION (as defined in Section I of the Tariff)**

This is an obligation to provide capacity from a resource, or a portion thereof, to satisfy a portion of the Installed Capacity Requirement that is acquired through a Forward Capacity Auction in accordance with Section III.13.2, a reconfiguration auction in accordance with Section III.13.4, or a Capacity Supply Obligation Bilateral in accordance with Section III.13.5.1 of Market Rule 1.

**CONTINGENCY (as defined in NPCC Document A-7)**

An event, usually involving the loss of one or more Elements, which affects the power system at least momentarily

**CAPACITY NETWORK RESOURCE CAPABILITY (as defined in Schedule 22 of the OATT)**

Capacity Network Resource Capability (“CNR Capability”) is defined in Schedule 22 of the Tariff and means (i) in the case of a Generating Facility that is a New Generating Capacity Resource pursuant to Section III.13.1 of the Tariff or an Existing Generating Capacity Resource that is increasing its capability pursuant to Section III.13.1.2.2.5 of the Tariff, the highest megawatt amount of the Capacity Supply Obligation obtained by the Generating Facility in accordance with Section III.13 of the Tariff, and, if applicable, as specified in a filing by the System Operator with the Commission in accordance with Section III.13.8.2 of the Tariff, or (ii) in the case of a Generating Facility that meets the criteria under Section 5.2.3 of this LGIP, the total megawatt amount determined pursuant to the hierarchy established in Section 5.2.3. The CNR Capability shall not exceed the maximum net megawatt electrical output of the Generating Facility at the Point of Interconnection at an ambient temperature at or above 90 F. degrees for Summer and at or above 20 degrees F. for Winter. Where the Generating Facility includes multiple production devices, the CNR Capability shall not exceed the aggregate maximum net megawatt electrical output of the Generating Facility at the Point of Interconnection at an ambient temperature at or above 90 degrees F. for Summer and at or above 20 degrees F. for Winter. The CNR Capability of a generating facility can be found in the Forecast Report of Capacity, Energy, Loads and Transmission (CELT Report) which is produced annually by ISO New England.

**DELAYED FAULT CLEARING (as defined in NPCC Document A-7)**

Fault clearing consistent with correct operation of a breaker failure protection group and its associated breakers, or of a backup protection group with an intentional time delay.

**ELEMENT (as defined in NPCC Document A-7)**

Any electric device with terminals which may be connected to other electric devices, usually limited to a generator, transformer, circuit, circuit breaker, or bus section.

**FCM STUDY FOR ANNUAL RECONFIGURATION AUCTIONS AND ANNUAL BILATERALS**

The FCM study as part of the annual reconfiguration auction or annual evaluation of Capacity Supply Obligations as described in Sections 13.4 and 13.5 of Market Rule 1.

**FCM DELIST/NON-PRICE RETIREMENT ANALYSES**

The FCM Delist/Non-Price Retirement Analyses is the analysis of de-list bids, demand bids and non-price retirement requests as described in Section 7.0 of Planning Procedure PP-10.

**FCM NEW RESOURCE QUALIFICATION OVERLAPPING IMPACT ANALYSES**

The FCM New Resource Qualification Overlapping Analyses is the analysis of overlapping interconnection impacts as described in Section 5.7 of Planning Procedure PP-10. This study is similar in scope as the thermal analyses performed in a System Impact Study associated with a generator interconnection request.

**FCM NEW RESOURCE QUALIFICATION NCIS ANALYSES**



The FCM New Resource Qualification NCIS Analyses is the initial interconnection analysis under the Network Capability Interconnection Standard as described in Section 5.6 of Planning Procedure PP-10. This study is similar in scope as the thermal analyses performed in a System Impact Study associated with a generator interconnection request.

**NORMAL FAULT CLEARING (as defined in NPCC Document A-7)**

Fault clearing consistent with correct operation of the protection system and with the correct operation of all circuit breakers or other automatic switching devices intended to operate in conjunction with that protection system

**NR CAPABILITY**

Network Resource Capability (“NR Capability”) is defined in Schedule 22 of the Tariff and means the maximum gross and net megawatt electrical output of the Generating Facility at the Point of Interconnection at an ambient temperature at or above 50 degrees Fahrenheit for Summer and at or above 0 degrees Fahrenheit for Winter. Where the Generating Facility includes multiple energy production devices, the NR Capability shall be the aggregate maximum gross and net megawatt electrical output of the Generating Facility at the Point of Interconnection at an ambient temperature at or above 50 degrees Fahrenheit for Summer and at or above 0 degrees Fahrenheit for Winter. The NR Capability shall be equal to or greater than the CNR Capability. The NR Capability of a generating facility can be found in the Forecast Report of Capacity, Energy, Loads and Transmission (CELT Report) which is produced annually by ISO New England.

**NUCLEAR PLANT INTERFACE REQUIREMENTS (as defined in the NERC Glossary of Terms Used in Reliability Standards)**

The requirements based on Nuclear Plant Licensing Requirements (NPLRs) and Bulk Electric System requirements that have been mutually agreed to by the Nuclear Plant Generator Operator and the applicable Transmission Entities.

**NUCLEAR PLANT LICENSING REQUIREMENTS (NPLRs) (as defined in the NERC Glossary of Terms Used in Reliability Standards)**

Requirements included in the design basis of the nuclear plant and statutorily mandated for the operation of the plant, including nuclear power plant licensing requirements for:

1. Off-site power supply to enable safe shutdown of the plant during an electric system or plant event; and
2. Avoiding preventable challenges to nuclear safety as a result of an electric system disturbance, transient, or condition.

**PLANNED (as defined in Attachment K of Section II of the ISO-NE Tariff)**

A transmission upgrade the ISO has approved under Section I.3.9 of the tariff. (Both a Needs Assessment and a Solutions Study have been completed for planned projects.)

**PROPOSED (as defined in Attachment K of Section II of the ISO-NE Tariff)**

A regulated transmission solution that (1) has been proposed in response to a specific identified need in a needs assessment or the RSP and (2) has been evaluated or further defined and developed in a Solutions Study, as specified in the OATT, Attachment K, Section 4.2(b) but has not received ISO-NE approval under Section I.3.9 of the tariff. The regulated transmission solution must include analysis sufficient to support a determination by the ISO, as communicated to the PAC, that it would likely meet the identified need included in the needs assessment or the RSP, but has not received approval by the ISO under Section I.3.9 of the Tariff.

**PROTECTION GROUP (as defined in NPCC Document A-7)**

A fully integrated assembly of protective relays and associated equipment that is designed to perform the specified protective functions for a power system Element, independent of other groups.

Notes:

1. Variously identified as Main Protection, Primary Protection, Breaker Failure Protection, Back-Up Protection, Alternate Protection, Secondary Protection, A Protection, B Protection, Group A, Group B, System 1 or System 2.
2. Pilot protection is considered to be one protection group.

**PROTECTION SYSTEM (as defined in NPCC Document A-7)**

Element Basis: One or more protection groups; including all equipment such as instrument transformers, station wiring, circuit breakers and associated trip/close modules, and communication facilities; installed at all terminals of a power system Element to provide the complete protection of that Element.

Terminal Basis: One or more protection groups, as above, installed at one terminal of a power system Element, typically a transmission line.

**QUALIFIED CAPACITY (as defined in Section I of the ISO-NE Tariff)**

Qualified Capacity is the amount of capacity a resource may provide in the Summer or Winter in a Capacity Commitment Period, as determined in the Forward Capacity Market qualification processes.

**RESOURCE (as defined in Section I of the ISO-NE Tariff)**

Resource means a generating unit, a Dispatchable Asset Related Demand, an External Resource or an External Transaction.

**SIGNIFICANT ADVERSE IMPACT (Based on Section I.3.9 of the Tariff and Planning Procedure 5-3)**

A change to the transmission system that increases the flow in an Element by at least two percent of the Element's rating and that causes that flow to exceed that Element's appropriate thermal rating by more than two percent. The appropriate thermal rating is the normal rating with all lines in service and the long time emergency or short time emergency rating after a contingency ( See Section 3).

A change to the transmission system that causes at least a one percent change in a voltage and causes a voltage level that is higher or lower than the appropriate rating by more than one percent (See Section 4).

A change to the transmission system that causes at least a one percent change in the short circuit current experienced by an Element and that causes a short circuit stress that is higher than an Element's interrupting or withstand capability. (See Section 22)

With due regard for the maximum operating capability of the affected systems, one or more of the following conditions arising from faults or disturbances, shall be deemed as having significant adverse impact:

A fault or a disturbance that cause:

- any loss of synchronism or tripping of a generator
- unacceptable system dynamic response as described in Planning Procedure PP-3
- unacceptable equipment tripping: tripping of an un-faulted bulk power system element (element that has already been classified as bulk power system) under planned system configuration due to operation of a protection system in response to a stable power swing or operation of a Type I or Type II Special Protection System in response to a condition for which its operation is not required

**SPECIAL PROTECTION SYSTEM (SPS) (as defined in NPCC Document A-7)**

A protection system designed to detect abnormal system conditions, and take corrective action other than the isolation of faulted Elements. Such action may include changes in load, generation, or system configuration to maintain system stability, acceptable voltages or power flows. Automatic under frequency load shedding, as defined in NPCC Emergency Operation Criteria A-3, is not considered an SPS. Conventionally switched, locally controlled shunt devices are not SPSs.

**STEADY STATE (as defined in ANSI/IEEE Standard 100)**

The state in which some specified characteristic of a condition such as value, rate, periodicity, or amplitude exhibits only negligible change over an arbitrary long period of time (In this guide, the term steady state refers to sixty hertz currents and voltages after current and voltages deviations caused by abnormal conditions such as faults, load rejections and the like are dissipated)

**SUMMER (as defined in ISO-NE OP-16 Appendix A)**

The Summer period is April 1 to October 31.

**TEN-MINUTE RESERVE (as defined in NPCC Document A-7)**

The sum of synchronized and non-synchronized reserve that is fully available in ten minutes.

**VOLTAGE COLLAPSE**

The situation which results in a progressive decrease in voltage to unacceptable low levels, levels at which power transfers become infeasible. Voltage collapse usually leads to a black-out.

**WINTER (as defined in ISO-NE OP-16 Appendix A)**

The Winter period is November 1 to March 31.

**WITH DUE REGARD TO RECLOSING (as defined in NPCC Document A-7)**

This phrase means that before any manual system adjustments, recognition will be given to the type of reclosing (i.e., manual or automatic) and the kind of protection.

## Appendix B – Fast Start Units

The list of fast start units referenced in Section 11.6 is listed separately on the ISO-NE website at:

[http://www.iso-ne.com/static-assets/documents/committees/comm\\_wkgrps/prtcpnts\\_comm/pac/plan\\_guides/plan\\_tech\\_guide/technical\\_planning\\_guide\\_appendix\\_b\\_reference\\_document.pdf](http://www.iso-ne.com/static-assets/documents/committees/comm_wkgrps/prtcpnts_comm/pac/plan_guides/plan_tech_guide/technical_planning_guide_appendix_b_reference_document.pdf)

## Appendix C – Guidelines for Treatment of Demand Resources in System Planning Analysis

This document referenced in Section 11.8 is listed separately on the ISO-NE website at:

[http://www.iso-ne.com/static-assets/documents/committees/comm\\_wkgrps/prtcpnts\\_comm/pac/plan\\_guides/plan\\_tech\\_guide/technical\\_planning\\_guide\\_appendix\\_c\\_guidelines\\_for\\_treatment\\_of\\_demand\\_resources\\_in\\_system\\_planning\\_analysis.pdf](http://www.iso-ne.com/static-assets/documents/committees/comm_wkgrps/prtcpnts_comm/pac/plan_guides/plan_tech_guide/technical_planning_guide_appendix_c_guidelines_for_treatment_of_demand_resources_in_system_planning_analysis.pdf)

## Appendix D – Dynamic Stability Simulation Damping Criteria

The damping criteria referenced in Section 12.3 is listed separately on the ISO-NE website at:

[http://www.iso-ne.com/static-assets/documents/committees/comm\\_wkgrps/prtcpnts\\_comm/pac/plan\\_guides/plan\\_tech\\_guide/technical\\_planning\\_guide\\_appendix\\_d\\_damping\\_criteria.pdf](http://www.iso-ne.com/static-assets/documents/committees/comm_wkgrps/prtcpnts_comm/pac/plan_guides/plan_tech_guide/technical_planning_guide_appendix_d_damping_criteria.pdf)

## Appendix E – Dynamic Stability Simulation Voltage Sag Criteria

This document referenced in Section 12.3 is listed separately on the ISO-NE website at:

[http://www.iso-ne.com/static-assets/documents/committees/comm\\_wkgrps/prtcpnts\\_comm/pac/plan\\_guides/plan\\_tech\\_guide/technical\\_planning\\_guide\\_appendix\\_e\\_voltage\\_sag\\_guideline.pdf](http://www.iso-ne.com/static-assets/documents/committees/comm_wkgrps/prtcpnts_comm/pac/plan_guides/plan_tech_guide/technical_planning_guide_appendix_e_voltage_sag_guideline.pdf)

## **Appendix F – Stability Task Force Presentation to Reliability Committee-September 9, 2000**

This document referenced in Section 12.6 is listed separately on the ISO-NE website at:

[http://www.iso-ne.com/static-assets/documents/committees/comm\\_wkgrps/prtcpnts\\_comm/pac/plan\\_guides/plan\\_tech\\_guide/technical\\_planning\\_guide\\_appendix\\_f\\_stabiliy\\_task\\_force\\_presentation.pdf](http://www.iso-ne.com/static-assets/documents/committees/comm_wkgrps/prtcpnts_comm/pac/plan_guides/plan_tech_guide/technical_planning_guide_appendix_f_stabiliy_task_force_presentation.pdf)



## Appendix G – Reference Document for Base Modeling of Transmission System Elements in New England

This document, referenced in Sections 14 and 26.2, is listed separately on the ISO-NE website at:

[http://www.iso-ne.com/static-assets/documents/committees/comm\\_wkgrps/prtcpnts\\_comm/pac/plan\\_guides/plan\\_tech\\_guide/technical\\_planning\\_guide\\_appendix\\_g\\_reference\\_document.pdf](http://www.iso-ne.com/static-assets/documents/committees/comm_wkgrps/prtcpnts_comm/pac/plan_guides/plan_tech_guide/technical_planning_guide_appendix_g_reference_document.pdf)

## Appendix H – Position Paper on the Simulation of No-Fault Contingencies

This document, referenced in Section 12.7, is listed separately on the ISO-NE website at:

[http://www.iso-ne.com/static-assets/documents/2014/12/technical\\_planning\\_guide\\_appendix\\_h\\_reference\\_document.pdf](http://www.iso-ne.com/static-assets/documents/2014/12/technical_planning_guide_appendix_h_reference_document.pdf)

**Exhibit 2.D.4    LEI Analysis of the Feasibility and  
Practicality of Non-Transmission  
Alternatives (“NTAs”) to the Greater  
Hartford/Central Connecticut  
Reliability Project (“GHCCRP”) August  
31, 2015**



# ANALYSIS OF THE FEASIBILITY AND PRACTICALITY OF NON-TRANSMISSION ALTERNATIVES (“NTAs”) TO THE GREATER HARTFORD / CENTRAL CONNECTICUT RELIABILITY PROJECT (“GHCCRP”)

August 31<sup>st</sup>, 2015

*prepared for Eversource Energy*

*by*



**Julia Frayer and Sayad Moudachirou**

London Economics International LLC  
717 Atlantic Avenue, Suite 1A  
Boston, MA  
02111 USA  
T: (617) 933-7200  
F: (617) 933-7201

***Note: This page intentionally left blank.***

## *Synopsis*

Eversource Energy (“Eversource”) retained London Economics International LLC (“LEI”) to provide independent expert analysis on the feasibility and practicality of relying on non-transmission alternatives (“NTAs”) in lieu of a transmission project proposed to fix reliability violations in the Greater Hartford (“GH”) electrical subarea. This report is intended to be filed with Eversource’s application for the 115 kV Greater Hartford / Central Connecticut Reliability Project (“GHCCRP”) before the Connecticut Siting Council (“CSC”).

As part of the process of the needs assessment and identification of the preferred transmission solution for GHCC, ISO-NE conducted an analysis of market resource alternative (“MRA”<sup>1</sup>) for the various subareas of GHCC. ISO-NE identified the quantity and location of NTAs that would alleviate the thermal system overloads. Although the NTA study was conducted in late 2012, the violations are the same or worsening in light of the evolving market conditions. Indeed, the GHCC transmission solution study noted that a solution was needed as soon as possible, because the thermal loads could occur at peak loads consistent with 2013 levels. Eversource’s planning staff confirmed the reasonableness of the ISO-NE’s identified quantities of NTAs. Therefore, LEI relied upon the quantities and locations of NTAs specified in ISO-NE’s study. ISO-NE determined that 196 MW of energy injection is required to resolve reliability problems in the GH subarea. LEI then examined what actual supply-side and demand-side resources could fulfill the need and selected hypothetical technically feasible NTA technologies for cost analysis, based on the location, costs and other practical factors of consideration. We define technically “feasible” technologies as technologies that could be hypothetically implemented based on planning criteria and technology specific operating profiles. A technically feasible NTA technology therefore meets the reliability issues being addressed by the proposed transmission components.

LEI identified peaker aeroderivative,<sup>2</sup> Combined Cycle Gas Turbines (“CCGT”), and passive demand response (energy efficiency) as technically feasible NTA technologies at the Northwest Hartford (“NW Hartford”) substation. Although we explored the technical feasibility of solar photovoltaic (“PV”) as NTA at the considered location, such technology was however dismissed over its cost, the volume of nameplate capacity needed, and the associated acreage requirements.

Next, LEI assessed whether the technically feasible NTAs could be cost-effective or practical. LEI employed industry-standard levelized costing principles to select the least cost NTA for each location from the group of technically feasible NTA technologies. Since no merchant sponsor has proposed to build the NTAs and they would not generate a return that would attract private investors, LEI assumed that they would be built only if their net costs were imposed on electric ratepayers. LEI estimated the net direct cost to Connecticut ratepayers of the least cost NTA technology by deducting expected average annual market-related revenues from levelized annual gross costs. The total net direct cost to ratepayers of the least cost technically feasible NTA solution for GH was estimated to range from \$21 million to \$33 million a year, which is significantly higher than the \$4.6 million per year that Eversource estimates as the share of the revenue requirement associated with the GHCCRP transmission solution that would be allocated to Connecticut ratepayers. A host of factors – including

---

<sup>1</sup> MRA and NTA refer to the same concept of resources used as alternative to transmission projects.

<sup>2</sup> The term “Aeroderivative” is defined later in the document.

land availability, enabling infrastructure, and technology durability - will bear on the practicality of least cost technically feasible NTA technologies. Gas-fired units (CCGT and peakers) were the resources associated with the least cost NTA solution in the GH subarea. However, no such facilities are currently operating or have been proposed for development at the NW Hartford substation. Furthermore, the considered substation is located some distance (4 miles) away from the nearest gas pipeline. Therefore, a new gas lateral would need to be constructed if the selected NTA is a gas-fired generator, which would further increase the cost for Connecticut end-users.



# Table of Contents

<b>1</b>	<b>EXECUTIVE SUMMARY</b>	<b>7</b>
1.1	BACKGROUND ON LEI	9
1.2	WHAT NTA TECHNOLOGIES WERE CONSIDERED?	10
1.3	OVERVIEW OF METHODOLOGICAL APPROACH	10
1.4	KEY FINDINGS ON TECHNICALLY FEASIBLE NTA TECHNOLOGIES	12
1.5	KEY FINDINGS FROM COST ANALYSIS	14
<b>2</b>	<b>BACKGROUND ON THE GREATER HARTFORD CENTRAL CONNECTICUT SOLUTION AND THE GH TRANSMISSION SOLUTION</b>	<b>18</b>
2.1	GREATER HARTFORD CENTRAL CONNECTICUT TRANSMISSION REINFORCEMENT PROJECTS	18
2.2	THE NORTHWESTERN CONNECTICUT TRANSMISSION SOLUTION	19
<b>3</b>	<b>WHAT IS AN NTA?</b>	<b>20</b>
3.1	EVALUATION OF AN NTA	21
3.2	PROSPECTIVE NTA TECHNOLOGIES	22
<b>4</b>	<b>OVERVIEW OF METHODOLOGICAL APPROACH</b>	<b>25</b>
4.1	DETERMINATION OF HYPOTHETICAL NTA SOLUTIONS	26
4.1.1	<i>Choice of NTA study</i>	28
4.1.2	<i>Independence of NTA requirements across subareas</i>	28
4.1.3	<i>Staleness of the NTA studies</i>	29
4.2	METHODOLOGY FOR IDENTIFYING TECHNICALLY FEASIBLE NTA TECHNOLOGIES	30
4.3	METHODOLOGY FOR ESTIMATING COST OF TECHNICALLY FEASIBLE NTA TECHNOLOGIES	33
4.3.1	<i>Determining gross LCOE for technically feasible NTA technologies</i>	34
4.3.2	<i>Determining Net LCOE for technically feasible NTA technologies</i>	35
<b>5</b>	<b>ANALYSIS AND RESULTS</b>	<b>37</b>
5.1	COST ESTIMATES	39
5.1.1	<i>Gross cost estimates for ratepayers</i>	39
5.1.2	<i>Net direct cost estimates of NTA solutions for ratepayers</i>	40
5.2	QUALITATIVE DISCUSSION ON FEASIBILITY OF NTA SOLUTION IN THE GH SUBAREA	42
<b>6</b>	<b>CONCLUSION</b>	<b>45</b>
<b>7</b>	<b>APPENDIX A: LEI'S QUALIFICATIONS</b>	<b>46</b>
<b>8</b>	<b>APPENDIX B: TECHNICAL AND OPERATIONAL CHARACTERISTICS OF VARIOUS NTA TECHNOLOGIES</b>	<b>53</b>
<b>9</b>	<b>APPENDIX C: DERIVATION OF COST ESTIMATES FOR VARIOUS NTA TECHNOLOGIES</b>	<b>58</b>
<b>10</b>	<b>APPENDIX D: BIBLIOGRAPHY AND WORKS CITED</b>	<b>61</b>

## Table of Figures

FIGURE 1. GH SOLUTION COMPONENTS.....	7
FIGURE 2. METHODOLOGICAL APPROACH .....	11
FIGURE 3. RANGE OF FEASIBLE NTA TECHNOLOGIES FOR LOCATIONS IN THE GH SUBAREA .....	12
FIGURE 4. METHODOLOGY FOR ESTIMATING NET DIRECT COSTS OF TECHNICALLY FEASIBLE NTA TECHNOLOGIES (\$/kW-YEAR) .....	15
FIGURE 5. SUMMARY OF LEI’S SCENARIOS .....	16
FIGURE 6. ESTIMATED NET DIRECT COSTS OF NTA SOLUTION IN GH SUBAREA .....	17
FIGURE 7. MAPPING OF THE GHCC AREA .....	18
FIGURE 8. GH SOLUTION COMPONENTS.....	19
FIGURE 9. NTA TECHNOLOGY CATEGORIES.....	20
FIGURE 10. DESCRIPTIVE SUMMARY OF NTA TECHNOLOGIES .....	23
FIGURE 11. METHODOLOGICAL APPROACH .....	25
FIGURE 12. SUMMARY OF MODELING ASSUMPTIONS USED IN THE NTA STUDIES.....	27
FIGURE 13. SUMMARY OF INJECTION REQUIREMENTS FOR THE HYPOTHETICAL NTA SOLUTION FOR THE GH SUBAREA.....	28
FIGURE 14. NTA REQUIREMENTS AT THE NW HARTFORD SUBSTATION .....	30
FIGURE 15. METHODOLOGY FOR IDENTIFYING TECHNICALLY FEASIBLE NTA TECHNOLOGIES (SUPPLY-SIDE RESOURCES) ..	32
FIGURE 16. METHODOLOGY FOR ESTIMATING NET DIRECT COSTS OF TECHNICALLY FEASIBLE NTA TECHNOLOGIES (\$/kW-YEAR) .....	34
FIGURE 17. SUMMARY OF GROSS LCOE PER YEAR FOR EACH TECHNOLOGY .....	35
FIGURE 18. COMPONENTS OF THE NET LCOE CALCULATIONS FOR EACH TECHNICALLY FEASIBLE NTA TECHNOLOGY (\$/kW-YEAR) .....	36
FIGURE 19. ILLUSTRATION OF GROSS AND NET DIRECT COST.....	38
FIGURE 20. ILLUSTRATION (IN FOUR STEPS) OF LEAST COST TECHNICALLY FEASIBLE TECHNOLOGIES SELECTION .....	39
FIGURE 21. SUMMARY OF LEI’S SCENARIOS .....	41
FIGURE 22. ESTIMATED NET DIRECT COSTS OF NTA SOLUTION FOR GH PER ANNUM BASED ON VARYING ASSUMPTIONS REGARDING OFFSETTING REVENUES AND SUBSIDIES .....	41
FIGURE 23. QUALITATIVE REVIEW OF NTA TECHNOLOGIES .....	43
FIGURE 24. TECHNICAL CHARACTERISTICS OF NTA TECHNOLOGIES .....	54
FIGURE 25. TECHNOLOGY PARAMETER DETERMINATION ASSUMPTIONS.....	55
FIGURE 26. GROSS AND NET LCOE PER TECHNOLOGY (\$/kW-YEAR).....	58
FIGURE 26. OVERNIGHT COST PER TECHNOLOGY (\$/kW-YEAR) .....	58
FIGURE 27. ASSUMPTIONS AND SOURCES ON GROSS LCOE .....	59
FIGURE 28. ASSUMPTIONS AND SOURCES OF REVENUE STREAMS .....	60

## Acronyms

AC	Alternating Current
ACP	Alternative Compliance Payment
CCGT	Combined Cycle Gas Turbine
CLL	Critical Load Level
CSC	Connecticut Siting Council
DALRP	Day Ahead Load Response Program
DG	Distributed Generation
DR	Demand Response
EPRI	Electric Power Research Institute
FCA	Forward Capacity Auction
FCM	Forward Capacity Market
FO&M	Fixed Operating & Maintenance
GH	Greater Hartford
GHCC	Greater Hartford Central Connecticut
HVDC	High Voltage Direct Current
IEA	International Energy Agency
ISO	Independent System Operator
ISO-NE	Independent System Operator- New England
kW	Kilowatt
LCOE	Levelized Cost of Entry
LEI	London Economics International
MRA	market resource alternative
NERC	North American Electric Reliability Corporation
NPCC	Northeast Power Coordinating Council
NREL	National Renewable Energy Laboratory
NTA	Non-Transmission Alternative
NWCT	Northwestern Connecticut
O&M	Operating & Maintenance
PNNL	Pacific Northwest National Laboratory
PV	Photovoltaic
REC	Renewable Energy Credit
RTDR	Real-Time Active DR
RTEG	Real-Time Emergency Generation
RTO	Regional Transmission Organization
VOLL	Value of Lost Load
VOM	Variable Operating and Maintenance

***Note: This page intentionally left blank.***

# 1 Executive Summary

Over the course of the year 2012 through to 2014, the reliability aspects of the bulk power system in the GHCC areas were studied by ISO-New England (“ISO-NE”). This study, referred to as the *Greater Hartford Central Connecticut Area Transmission 2022 Needs Assessment Report* (“GHCC Needs Assessment”) and issued in August 2012, analyzed a geographic area spanning the central and western part of Connecticut (essentially to the west of the Connecticut East-West interface and north of the Southwest Connecticut Import interface). For purposes of its analysis, ISO-NE analyzed four subareas within the GHCC Needs Assessment (some of which were themselves composed of further detailed subareas), namely the Manchester-Barbour Hill Area, Middleton Area, Northwest Connecticut Area, and Greater Hartford Area. Two components of the GHCC transmission solution will require transmission siting approval from the Connecticut Siting Council (“CSC”): the Northwestern Connecticut Reliability project (“NWCT”) and the GHCCRP, which is the subject of this report. The principal component of the GHCCRP is the construction of a 4 mile, 115 kV line from the Newington Substation in Newington to the Southwest Hartford Substation in Hartford. The full scope of the project is summarized in the table below.

**Figure 1. GH solution components**

ID	Solution Component
1	Add a new 4 mile 115 kV underground cable from Newington to Southwest Hartford and associated terminal equipment including a 2% series reactor
2	Loop the 1779 line between South Meadow and Bloomfield into the Rood Avenue substation and reconfigure the Rood Avenue substation
3	Reconfigure the Berlin 115 kV substation including the addition of two 115 kV breakers and the relocation of a capacitor bank
4	Add a 115 kV 25.2 MVAR capacitor at Westside 115 kV substation
5	Reconductor the 115 kV line between Newington and Newington Tap (1783) - 0.01 mile
6	Separation of 115 kV DCT corresponding to the Bloomfield to South Meadow (1779) line and the Bloomfield to North Bloomfield (1777) line and add a breaker at Bloomfield 115 kV substation
7	Install a 115 kV 3% reactor on the underground cable between South Meadow and Southwest Hartford(1704)
8	Separation of 115 kV DCT corresponding to the Bloomfield to North Bloomfield (1777) line and the North Bloomfield - Rood Avenue - Northwest Hartford (1751) line and add a breaker at North Bloomfield 115 kV substation

Source: Eversource

LEI was engaged by Eversource to analyze the potential for technically-feasible, cost-effective and practical NTAs to replace the GHCCRP. LEI describes in detail the methodology and approach used to conduct its analysis in sections 4 and 5.

A Non-Transmission Alternative is a solution (or group of solutions) to an identified electric system need that does not involve the construction of traditional transmission infrastructure. NTA technologies may include supply-side resources (e.g. conventional generation, distributed generation or advanced generation technologies such as energy storage technologies), demand-side resources (e.g. demand response or energy efficiency), or a combination of both.

#### **How to choose between a transmission solution and an NTA?**

In theory, if an NTA can satisfactorily meet the technical requirements of the system that are driving the need for the transmission solution, it can then delay the timing of needed transmission investment. Consumers would pay for the transmission solution and may need to pay for the costs of deploying the NTA. Therefore, it is important to compare the costs of the transmission solution against the NTA. However, it is also important to recognize that NTAs and transmission may also have different characteristics that affect other aspects of electricity service. Even if an NTA has a lower cost and can fulfill the technical requirements of the system (e.g., the reliability need), there may also be other services and benefits that transmission can provide versus NTAs. Only if an NTA can fulfill all the same technical requirements and generate benefits at comparable or lower costs than those associated with transmission projects, should an NTA be pursued.

LEI was asked to determine whether there is a technically feasible combination of NTA technologies that could be more cost-effective than the GHCCRP in addressing the load serving concerns in the Greater Hartford subarea.<sup>3</sup>

As part of the process for the needs assessment for the Greater Hartford / Central Connecticut area and identification of preferred transmission solutions, ISO-NE conducted two NTA studies<sup>4</sup> in late 2012 that identified the smallest aggregate quantity of injections (as measured in MW terms) in the entire area (composed of four subareas including GH, grouped together) that would alleviate the thermal system overloads. The assumptions underpinning the NTA studies are based on the initial Needs Assessment study (2012). ISO-NE performed separate and distinct hypothetical analyses for either a 100% demand-

<sup>3</sup> In addition to addressing local load-serving concerns, the GHCCRP was designed to increase transfer capability across the Western Connecticut Import Interface. LEI was not tasked to determine if a feasible NTA that would resolve the load serving issues in the sub-area would also perform the “double duty” of increasing transfer capability across the interface or eliminating the need for such an increase.

<sup>4</sup> According to ISO-NE, the two analyses were conducted separately consistently with ISO-NE’s protocol at the time. One study focused on demand-side NTAs only, while the other focused on supply-side NTAs. The demand-side study was not realistic as it required demand reductions at many locations that would not be practically achievable (such as 100% load reductions). Since the time of these studies, ISO-NE has moved to a hybrid approach considering both supply-side and demand-side resources under the same analysis, and employing more realistic assumptions on demand-side load reductions. LEI therefore has not relied on ISO-NE’s demand-side NTA study. Rather, LEI has used the required injection values and the location for those values developed in the revised ISO-NE Supply-side MRA Study as the basis for developing supply, demand, or hybrid solutions.

side solution or a 100% supply-side solution. Both analyses were done under a number of different dispatch conditions, with the objective being to identify a minimum amount of total MWs (dispersed across the “best” locations) associated with either net load reduction or/and additional supply that would resolve all overloads and thermal violations under N-1-1 contingency events.<sup>5</sup> A single injection point was identified for an NTA solution in the GH subarea by ISO-NE: the NW Hartford bus (or injection point). According to ISO-NE, the quantity of energy injection or load reduction required to resolve the target reliability criteria violations totaled 196 MW for the GH subarea. Eversource’s engineers confirmed that the injection location and the associated NTA requirement were not likely to have significantly changed as a result of increasing load in the GH subarea, or evolving market conditions.

LEI evaluated technically feasible NTA resources at the NW Hartford bus that fulfill the 196 MW of requirement, as determined by ISO-NE. LEI’s analysis started with identifying a list of technically feasible NTA technologies that possess the operating characteristics required to meet the criteria of the NTA injections (either in terms of size, location, or operating profile) at the NW Hartford substation. We then compared the costs of implementing each of the prospective NTA technologies, in order to select the least cost one. The least cost NTA technology was then compared to the cost of the proposed transmission project. We also examined practical challenges related to the development and commercialization of an NTA technology. We concluded that the least cost technically feasible NTA solution is likely to be more difficult to implement than a transmission solution, and would be five times more costly on average for Connecticut ratepayers.

## 1.1 Background on LEI

LEI is a global economic and financial consultancy specializing in energy and infrastructure. The firm combines a detailed understanding of specific network and commodity industries, such as electricity generation and distribution, with sophisticated analysis and a suite of proprietary quantitative models to produce reliable and comprehensible results. LEI benefits from a balance of private sector and government clients, which enables the firm to effectively advise both regarding the impact of regulatory initiatives on private investment, as well as regulatory responses to activities undertaken by individual firms. LEI has extensive experience working with both renewable and conventional generation technologies, as well as transmission infrastructure in the New England and Connecticut region. LEI has also undertaken economic cost-benefit analysis, market price forecasting and asset valuation as well as presented expert witness testimony in front of various regulators in North America, including the Connecticut Siting Council, the Connecticut Department of Public Utility Control (“DPUC”), a predecessor entity to today’s Public Utilities Regulatory Authority (“PURA”). A detailed description of LEI’s experience is presented in Appendix A.

---

<sup>5</sup> Market Resource alternative Analysis - Demand-side Results, *GHCC Area*, PAC Meeting - Revised November 14, 2012, page 7 and Market Resource alternative Analysis - Final Demand-side Results, *GHCC Area*, PAC Meeting, December 13, 2012, page 8.

## **1.2 What NTA technologies were considered?**

The analysis presented in this report was designed around a mix of supply-side and demand-side technologies initially identified by both LEI and the Eversource:

1. conventional fossil fuel fired generation (natural gas-fired peaking and combined cycle technologies);
2. large scale renewable generation (solar, wind and fuel cells);
3. distributed generation (solar);
4. active demand response (such as real-time demand response and real-time emergency generation);
5. passive demand response (such as energy efficiency programs); and
6. energy storage technologies (such as utility-scale battery technology and flywheels).

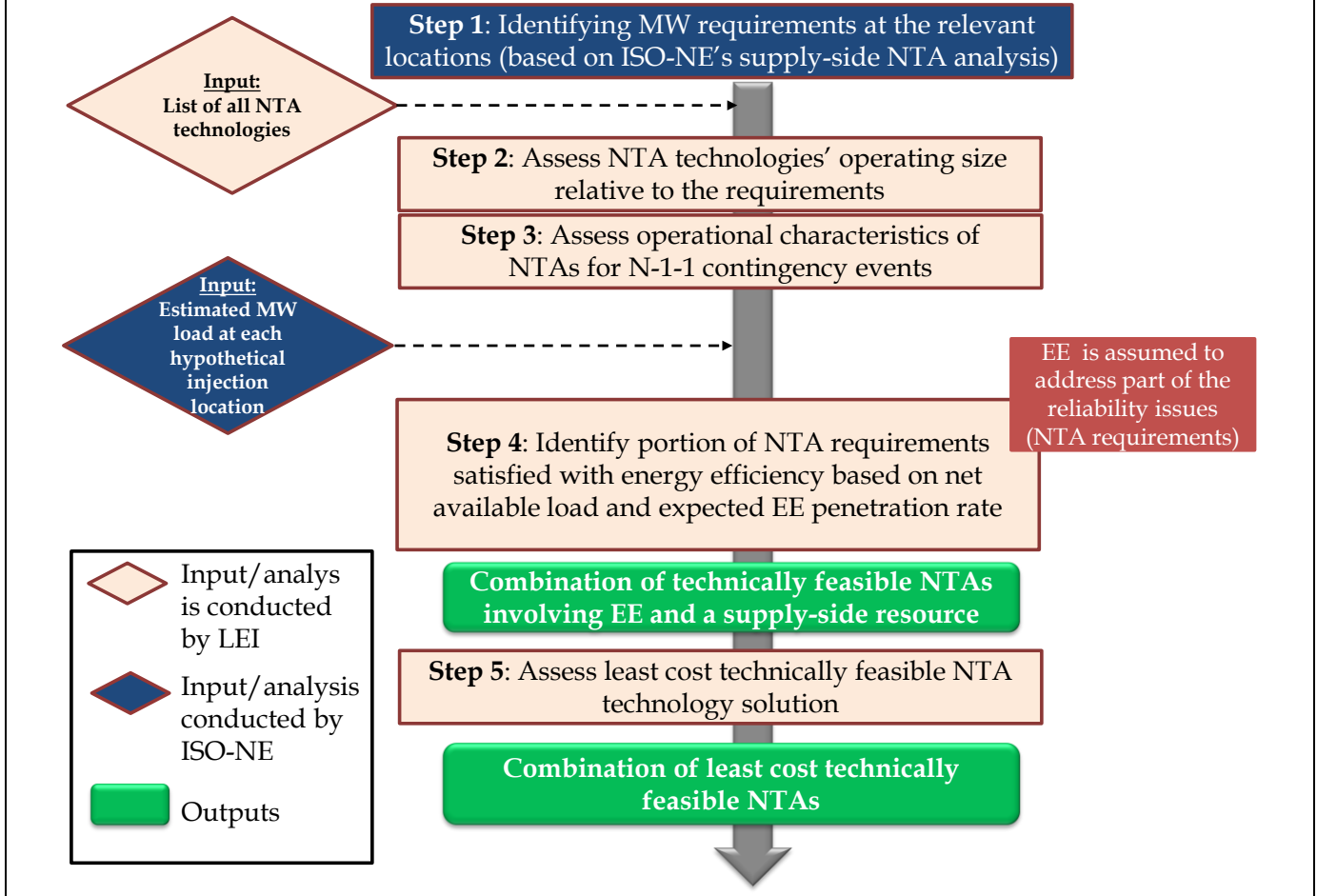
In undertaking the technology identification and cost analysis, LEI relied primarily on real world operating experience with such technologies in New England, as well as research documents and market information made publicly available by ISO-NE and the State of Connecticut related to technologies' operational data and statistics. Understanding of local market conditions was enhanced by Eversource's proprietary information. Where necessary, information from actual operational experience was supplemented with engineering-related data and generic technology information, including data on capital and operating costs, as well as operating parameters. Such generic information was collected from reputable sources, such as the US Department of Energy and affiliated national laboratories, manufacturers, and engineering procurement companies that work with such technologies. A detailed bibliography list is provided in Appendix D.

## **1.3 Overview of methodological approach**

In order to identify technically feasible NTA technologies that can feasibly, cost-effectively and practically satisfy the reliability issues being addressed by GHCCRP transmission solution, a five-step methodology was designed. These steps are shown in Figure 2 below and are detailed in Section 4 of this report.



**Figure 2. Methodological Approach**



LEI undertook a technology mapping process in order to identify and associate a technically feasible NTA technology with the hypothetical NTA requirements for the designated location and injection amount (i.e., capability to produce energy, measured in MW terms). LEI used decision tree techniques to sequentially filter and narrow down the available list of technologies according to the requirements at each location.

While LEI recognizes that there may be multiple NTA technologies that are feasible with each injection point/amount, the purpose of this analysis is to identify technically feasible NTA technologies that possess the operating characteristics required to meet the criteria of the hypothetical NTA injections (either in terms of size, location, or operating profile). The details of LEI's methodology are presented in Section 4.3 of this report.

The next step in LEI's analysis employs a levelized cost methodology in order to evaluate the direct costs to ratepayers of implementing NTA technologies. The direct costs were calculated by aggregating the total cost of implementing least cost technically feasible NTA technologies by location. LEI first assessed the costs of technically feasible NTA solutions by evaluating the total costs of investment and operations (based on gross Levelized Cost of Entry ("LCOE") per kW year). Then, LEI considered the

net costs of investment and operations that ratepayers would bear after accounting for possible market revenues.

### 1.4 Key Findings on technically feasible NTA technologies

*CCGTs (small plant) and peaker aeroderivative units are the most suitable NTA technologies at the NW Hartford substation due to the size of the requirement (196 MW is required at that bus).*

LEI ran a hybrid analysis assuming that a portion of the NTA requirement will be filled out by demand-side resources (limited by net load availability and expected load reduction rate), while supply-side resources will be used to address the residual NTA requirement. In other words, the technically feasible technologies identified through LEI’s analysis consist of energy efficiency (“EE”) and a supply-side resource. Based on Eversource’s experience with existing EE programs, we assumed that any incremental energy efficiency programs (above and beyond existing and planned programs) could reduce peak load by up to 15% at the NW Hartford substation.<sup>6</sup>

At the target substation, CCGTs and peaker aeroderivative (likely multiple units) appear as technically feasible NTA technologies due to the size of the requirement (196 MW). In Figure 3, we present the NTA requirements at the NW Hartford substation, and summarize all the possible NTA technologies based on size and operational criteria.

**Figure 3. Range of feasible NTA technologies for location in the GH subarea**

Requirement at the NW Hartford substation (MW)		196
Technically feasible technologies		Capacity (MW)
EE	EE	23
Supply-side resources	Peaker Aeroderivative*	182
	CCGT	182

Each of the supply-side resources (peaker and CCGT) should be considered in combination with the EE

**Notes:** All capacity numbers are nameplate.

\* “Peaker aeroderivative” would consist of multiple units of peaker aeroderivative technology

As can be seen at the NW Hartford substation, both peaker aeroderivative units, and CCGT (in combination with EE) meet the cumulative NTA resource needs. The final choice of which of these NTA technologies will be selected is determined on the basis of each technology’s net levelized costs and the associated nameplate capacity (MWs).

The NTA requirements are presented under N-1-1 contingency events in Figure 3. Based on standard planning protocols as provided for in ISO-NE procedures, an N-1-1 contingency event is defined as follows:

- an N-1-1 contingency event refers to a situation when an additional single element of transmission or generation system fails, and a technically feasible NTA technology must be able

<sup>6</sup> The 15% assumption is discussed in detail in Section 3.2 of the report.

to provide energy within 30 minutes and continue to operate until the failed elements are repaired or as long as deemed necessary by the ISO-NE. Typically, ISO-NE can resolve contingency events within a 12 to 24 hour cycle, and LEI has conservatively assumed a 12 hours duration to resolve the contingency in its analysis.

One of the primary criteria to qualify as an N-1-1 NTA is the ability to operate whenever load in the region of study exceeds the critical load limit (“CLL”). According to the ISO New England, the CLL is defined as the load level at which violation could occur, and therefore a solution would be needed.<sup>7</sup> In the GHCC Needs Assessment, ISO-NE performed a CLL study and determined the level of load for the entire Connecticut area, at which the overloads and thermal violations would be resolved within the GH subarea. LEI compared the estimated CLL number (4,225 MW) to forecasted hourly load in Connecticut in 2022<sup>8</sup>, in order to estimate the period of the year (shoulder, summer or winter), as well as the time of the day (daytime or nighttime) when the load is most likely to reach the CLL. The results of our CLL analysis indicate that a prospective NTA solution would likely need to be available round-the clock (all seasons, daytime and nighttime).<sup>9</sup>

Given the hypothetical NTA requirements, some technologies are not technically viable, mainly due to their operational characteristics. For example, fast discharge energy storage resources (such as flywheels) are not technically feasible on a standalone basis because they cannot inject power continuously for 12 hours as required by an N-1-1 contingency event.

Other small scale NTA technologies, such as solar DG, cannot effectively meet the technical requirements of the contingencies and the sizing required of hypothetical NTA requirements at the NW Hartford substation. In addition, solar DG resources have an operating profile that does not provide for the sustained performance required under N-1-1 contingencies. Even if solar DG were to be paired with energy storage technologies (such as batteries) to overcome the intermittency of operation, DG units would not provide a technically feasible NTA technology because of the very small amount of energy generated by a typical 5 MW<sup>10</sup> solar DG unit. Therefore, a large combination of units would be required, which would be cost prohibitive. LEI’s examination of utility-scale solar PV installations is a sufficient proxy for solar technology in general.

Finally, it bears noting that Real-Time Active DR (“RTDR”), which is typically associated with industrial or large commercial customer sites (such as manufacturing facilities or processing factories), were not directly taken into consideration in the analysis, although LEI still considered them as potential NTA technologies. There is a lack of publicly available information on RTDR’s operational

---

<sup>7</sup> Section 5.5: Information on Critical Load Level. Regional System Plan 2013. Available at: [http://iso-ne.com/static-assets/documents/trans/rsp/2013/rsp13\\_final.docx](http://iso-ne.com/static-assets/documents/trans/rsp/2013/rsp13_final.docx).

<sup>8</sup> Source: ISO-NE.

<sup>9</sup> In our CLL/Load analysis, violations occur 39% of the time in the Winter, 45% of the time in the Summer and 7% of the time in the shoulder season.

<sup>10</sup> According to the ISO New England Transmission, Markets And Services Tariff, General Terms and Conditions Section I.2.2, solar distributed generation are limited in size at 5 MW.

mode (such parameters will vary with equipment type and size), timing and duration of operation, as well as response/performance rates and opportunity costs, which does not allow us to model these technologies with confidence. Furthermore, under ISO-NE's rules, RTDR and real-time emergency generation ("RTEG") are not typically operable at any given time of the day, which would be a stumbling block to their technical feasibility under N-1-1 contingency events.<sup>11</sup>

Technically, peaker frame units can also operate in the size range of between 20 and 250 MW, but these units do not qualify as a technically feasible NTA technology due to technical and market economics-related reasons. Under N-1-1 contingency events, we have assumed that a technically feasible NTA technology would be required to be capable of injecting power within 30 minutes. In order for peaker frame units to fulfill these timing requirements, and given the source of fuel (i.e., pipeline gas) and nominations required for such fuel, such units would need to be effectively committed day-ahead in order to be capable of operating in real-time, as they would not be able to ramp up from a cold start given the advance notice required for fuel supply and also the speed of ramping. Although the ISO-NE has the authority to commit resources "out-of-merit" on a day ahead basis, bringing online a gas-fired frame peaker and having it running essentially "out-of-merit" in order to be prepared for contingencies may be expensive and potentially distort market price signals. The ISO-NE may have more economic resources available for such purposes, such as other types of peakers (including dual fuel aeroderivative units and jet engines) if and when such a contingency occurs. Due to these operational considerations, LEI did not qualify peaker frame units as technically feasible NTA technologies for N-1-1 contingency events.

## 1.5 Key Findings from cost analysis

LEI employed industry-standard levelized costing principles to the identified pool of technically feasible NTA technologies in order to estimate the total cost of implementing the least cost NTA technologies. For each selected technology, LEI estimated a gross LCOE which, represents a resource' all-in-costs, annualized and levelized over its life cycle. The gross LCOE is reported in annual and per kilowatt terms (\$/kW-year) and embodies all investment and operating costs, including capital costs (equity and debt), fixed operating and maintenance ("FOM") costs, fuel costs (where relevant), and variable operating and maintenance ("VOM") costs. The net LCOE for each NTA technology is derived by deducting from gross LCOE a bundle of potential revenues and income streams associated with each NTA technology. The net LCOE is used to reflect the fact that total direct cost to ratepayers of implementing an NTA could be reduced through revenues earned by the resource from other sources, such as wholesale energy and capacity markets, ancillary services or other income streams.<sup>12</sup>

At the NW Hartford injection location, LEI calculated the total costs for the identified technically feasible NTA technologies based on the combination of their respective gross LCOE (or net LCOE) and

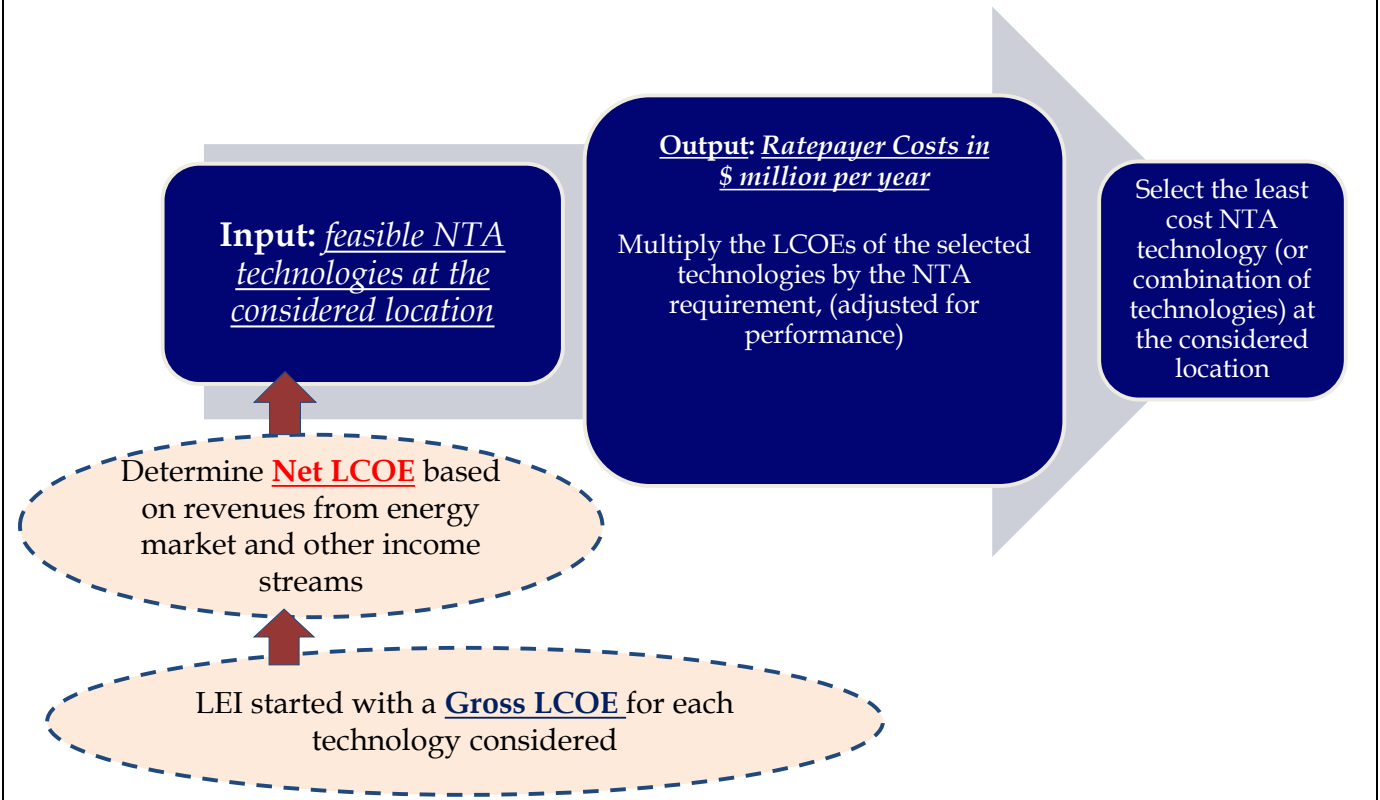
---

<sup>11</sup> "ISO New England Operating Procedure No. 14 - Technical Requirements for Generators, Demand Resources, Asset Related Demands and Alternative Technology Regulation Resources." *ISO-NE, November 7, 2014* [http://www.iso-ne.com/rules\\_proceeds/operating/isone/op14/op14\\_rto\\_final.pdf](http://www.iso-ne.com/rules_proceeds/operating/isone/op14/op14_rto_final.pdf).

<sup>12</sup> These revenues were estimated notionally based on current market intelligence and are discussed further in Section 5.1.2.

total capacity needs (at the injection location), with adjustment for operating factors.<sup>13</sup> LEI selected the least costly combination<sup>14</sup> by comparing the resulting costs for all technically feasible NTA technologies (presented in Figure 3) at the substation. The least cost combination is then used to derive the overall direct cost for Connecticut’s ratepayers in \$ million terms per year.

**Figure 4. Methodology for estimating net direct costs of technically feasible NTA technologies (\$/kW-year)**



Under the base line gross LCOE, gross cost for ratepayers is estimated at \$88 million a year. When adding a +/- 20% sensitivity, the resulting gross direct cost falls within a range of \$70 million to \$105 million a year. LEI recognizes that total costs of NTA technologies can be defrayed by revenues from ISO-NE wholesale markets as well as other sources. In order to capture an accurate estimate of net direct cost to Connecticut ratepayers from technically feasible NTA solutions, LEI deducted these revenues from the gross costs (to derive net LCOE). Nonetheless, there is a significant amount of uncertainty regarding the magnitude and sustainability of these revenue offsets. To account for this uncertainty, LEI also conducted a scenario analysis on the net LCOEs.

<sup>13</sup> Operating factors include capacity factor, availability factor (which is defined as 1-forced outage rate), and ramping rates, which describe how “fast” a power plant can increase or decrease output - it is usually defined in MW per minute.

<sup>14</sup> Combination of EE and a supply-side resource.

LEI considered the uncertainty of all new generating resources such as CCGTs or peakers clearing forward capacity auctions (“FCAs”). Some of the uncertainty is based upon the fact that the auctions for the next three years have already been completed; there are also some question marks on the needs of such new resources in future FCAs; in which case new resources – as represented by these NTA technologies – may not be able to get capacity revenues for some time. Securing these resources in a timely fashion in order to meet the reliability requirements of the GH subarea, will need to be done outside the Forward Capacity Market (“FCM”) timetables, given that new capacity has already been procured for the 2018-2019 delivery period in the Forward Capacity Auction #9 (“FCA#9”) of February 2015. Therefore, it will necessitate out-of market solicitation, exposing Connecticut ratepayers to greater cost. LEI calculated the net direct costs to ratepayers under two scenarios: (i) feasible resources would not be able to clear all FCAs but would receive capacity payments over half<sup>15</sup> of the years of their life span; and (ii) feasible resources do not clear any FCA and consequently do not earn any capacity revenues over their life cycle. Figure 5 provides a summary of the two scenarios.

**Figure 5. Summary of LEI’s scenarios**

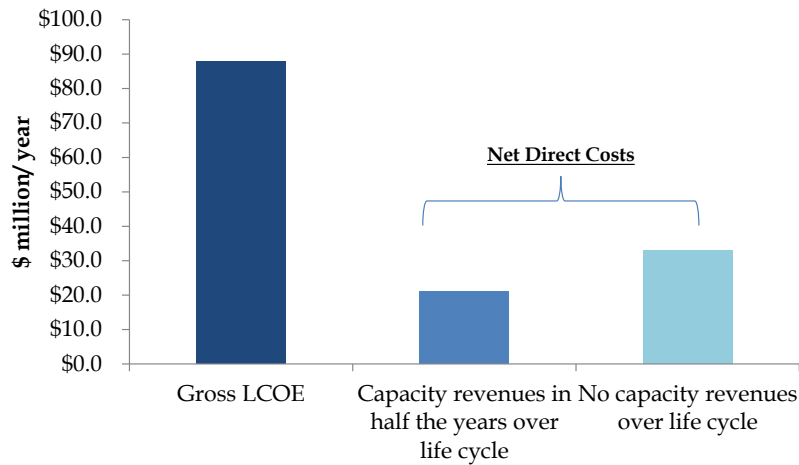
Scenario	Methodology	Key assumptions for net LCOE
<b>Scenario 1</b> (Capacity revenues in half the years over life cycle)	Net LCOE used to select the least cost technologies	We assumed that new resources such as CCGT and peakers would receive capacity payments over half the years of their life cycle
<b>Scenario 2</b> (No capacity revenues in years over life cycle)	Net LCOE used to select the least cost technologies	We assumed that none of the new resources would receive capacity payments over their respective life cycle

The total net direct cost (gross costs net of revenues offsets) for ratepayers was determined to range between \$21 million and \$33 million a year across the two scenarios.<sup>16</sup> The lowest annual net direct costs estimated for Connecticut ratepayers, (\$21 million per year under Scenario 1) is more than five-fold higher than the share of the estimated annual revenue requirement for the GHCCRP transmission solution that would be borne by Connecticut ratepayers (\$4.6 million a year).

<sup>15</sup> There is also uncertainty in the future price of capacity, which we indirectly reflect with this 50% variable in the capacity revenue formula.

<sup>16</sup> Net LCOEs were derived from mid-range gross LCOE values.

**Figure 6. Estimated net direct costs of NTA solution in GH subarea**



Greater Hartford	Scenario 1	Scenario 2	GHCCRP
Scenarios	Capacity revenues in half the years over life cycle	No capacity revenues over life cycle	Cost of the transmission solution shouldered by end-users
Total cost (\$ million/ year)	\$21.2	\$33.0	\$4.6

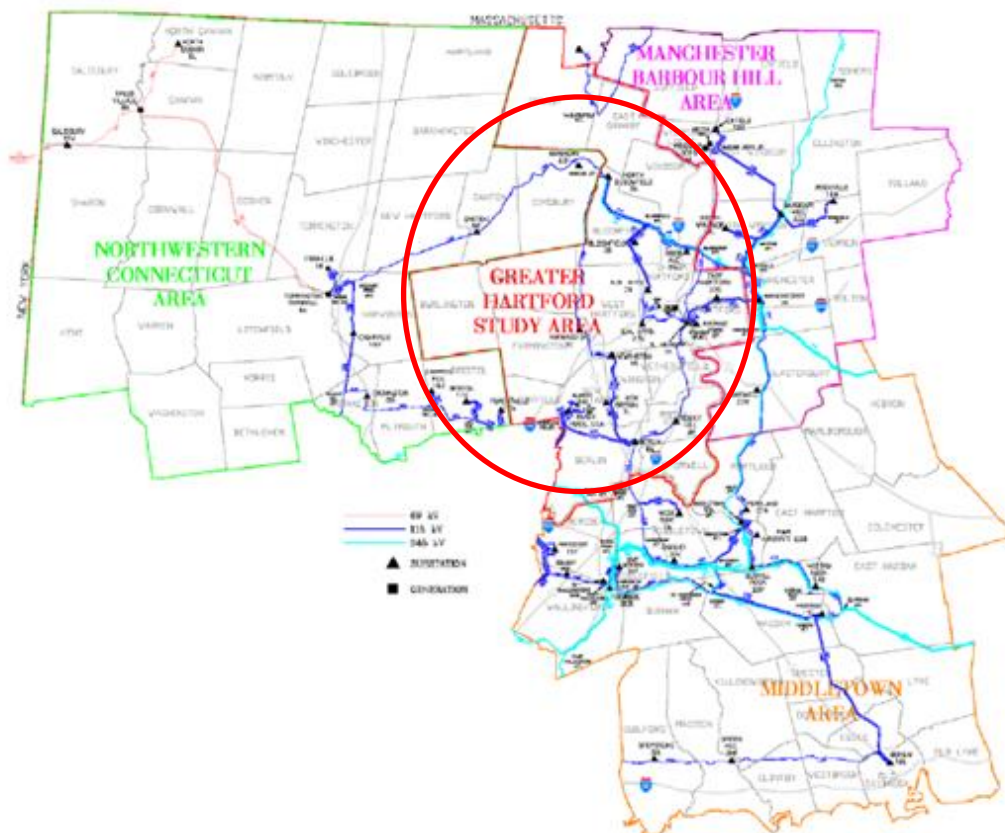
Connecticut ratepayers are expected to shoulder 27% of the GHCCRP transmission solution annual revenue requirements based on current load projections published by ISO-NE and current rules with respect to transmission cost allocation. The total estimated revenue requirement is \$17.1 million for the GHCCRP transmission solution. Therefore, Connecticut ratepayers would be responsible for \$4.6 million a year. However 100% of the NTA technologies costs will be borne by Connecticut end-users.

## 2 Background on the Greater Hartford Central Connecticut Solution and the GHCCRP transmission solution

### 2.1 Greater Hartford Central Connecticut Transmission Reinforcement Projects

Over the course of the 2012-2014 period, the reliability aspects of the bulk power system in the GHCC areas were studied by ISO-New England (“ISO-NE”). This study, the *Greater Hartford Central Connecticut Area Transmission 2022 Needs Assessment Report* (“GHCC Needs Assessment”), was released in August 2012 and analyzed a geographic area spanning the central and western part of Connecticut (essentially to the west of the East-West interface and north of the Southwest Connecticut Import interface). For purposes of its analysis, ISO-NE analyzed four subareas within the GHCC Needs Assessment, namely the Manchester-Barbour Hill subarea, Middletown subarea, Northwest Connecticut subarea, and Greater Hartford subarea as illustrated in Figure 7.

Figure 7. Mapping of the GHCC area



Circled in red is the GH subarea

Source: Market Resource Alternative - *Demand-side results* - GHCC, PAC, November 14, 2012

Critical Energy Infrastructure Information - Not for release



LEI understands that among the numerous components to the preferred transmission solution, two components of the GHCC solution will require transmission siting approval from the Connecticut Siting Council: the NWCT Reliability project and the GHCCRP subarea which is the area of study in this report.

## 2.2 The Northwestern Connecticut transmission solution

What we refer to in this report as “The GHCCRP transmission solution” consists of the construction of a 4 mile, 115 kV line from Newington to Southwest Hartford combined with multiple upgrades and equipment addition - as summarized in the table below.

**Figure 8. GHCCRP solution components**

ID	Solution Component
1	Add a new 4 mile 115 kV underground cable from Newington to Southwest Hartford and associated terminal equipment including a 2% series reactor
2	Loop the 1779 line between South Meadow and Bloomfield into the Rood Avenue substation and reconfigure the Rood Avenue substation
3	Reconfigure the Berlin 115 kV substation including the addition of two 115 kV breakers and the relocation of a capacitor bank
4	Add a 115 kV 25.2 MVAR capacitor at Westside 115 kV substation
5	Reconductor the 115 kV line between Newington and Newington Tap (1783) - 0.01 mile
6	Separation of 115 kV DCT corresponding to the Bloomfield to South Meadow (1779) line and the Bloomfield to North Bloomfield (1777) line and add a breaker at Bloomfield 115 kV substation
7	Install a 115 kV 3% reactor on the underground cable between South Meadow and Southwest Hartford(1704)
8	Separation of 115 kV DCT corresponding to the Bloomfield to North Bloomfield (1777) line and the North Bloomfield - Rood Avenue - Northwest Hartford (1751) line and add a breaker at North Bloomfield 115 kV substation







Source: Eversource

### 3 What is an NTA?

An NTA is a solution (or a group of solutions) to an identified electric system need that does not involve the construction of traditional transmission infrastructure. NTAs may include supply-side resources (e.g. conventional generation, distributed generation, and advanced generation-like technologies such as batteries and storage), demand-side resources (e.g. demand response and energy efficiency), or a combination of the two. More recently, the term “NTAs” has been expanded to include smart grid distribution technologies.

Discussions of NTAs occurring in wholesale power markets and at state regulatory bodies generally focus on six categories of NTA technologies as described further in Figure 9 below: energy efficiency; demand response; utility-scale generation; distributed generation; energy storage; and smart grid technology.

**Figure 9. NTA Technology Categories**

	<b>Energy Efficiency</b>	improvements that result in the ability to use less energy to provide end-use customers with the same (or a better) level of service in an economically efficient way
	<b>Demand Response</b>	changes in electric usage by end-use customers from their normal consumption patterns in response to changes in the price of electricity over time or to incentive payments
	<b>Utility-scale Generation</b>	relatively large generators that connect to the grid at the transmission (high voltage) level
	<b>Distributed Generation</b>	small generation systems located at a customer site
	<b>Energy Storage</b>	technologies that allow electricity generated at one time to be used at another time
	<b>Smart Grid</b>	technologies that enable a more efficient use of the electric power grid through computer-based remote control and automation

Note: LEI was not asked to consider SmartGrid as a technology category in this analysis because it is relatively untested and there is limited data available to model it as an NTA technology with confidence.

Consistent with the general categories of NTA technologies and adjusted for what is reasonable in New England (and specifically in Connecticut), the analysis presented in this report was designed around a list of six types of NTA technologies as follows:

1. conventional fossil fuel fired generation (natural gas-fired peaking and combined cycle technologies);
2. large scale renewable generation (solar and wind);
3. distributed generation (solar and fuel cells);
4. active demand response (such as real-time demand response and real-time emergency generation);
5. passive demand response (such as energy efficiency programs); and
6. energy storage technologies (such as utility-scale battery technology and flywheels).

The six types of NTA technologies listed above include both supply-side and demand-side resources. Supply-side technologies include conventional fossil fuel-fired generation, large-scale renewable generation, distributed generation, and energy storage technologies. Supply-side technologies can also include applications with energy storage technologies. Demand-side technologies include various forms of demand response.

Each of these NTA technologies has inherent operating characteristics that may determine their applicability as a technically feasible NTA technology vis-à-vis the reliability-driven requirements for a solution. When evaluating the practical feasibility of NTA technologies (ability for the NTA technologies-based solution to be implemented in real life) versus a transmission solution, the analysis must be done in a way that would make NTAs and transmission comparable in terms of both technical characteristics (reliability) and economic attributes (costs and benefits), as we discuss further below.

### 3.1 Evaluation of an NTA

As part of its ongoing work with the energy industry, LEI has proposed a set of tools and analytical techniques to allow for a comprehensive evaluation of NTAs and transmission solutions.<sup>17</sup> Although the specific steps and analytical tools can differ, subject to the specific context of a given investment need and system operator's planning process, there are a number of guiding principles that must be considered.

First and foremost, a rigorous analysis should acknowledge that NTA technologies and transmission will provide different services and therefore could generate different levels of benefits for consumers. Furthermore, a rigorous analysis needs to ensure that NTAs meet the technical needs underpinning the transmission solution. Finally, LEI recommends that a comparative analysis is conducted within the discipline of cost-benefit framework, where benefits and costs are considered as comprehensively as possible. Economic cost-benefit analysis should consider the dynamic evolution of the system, rational market response to NTAs and/or transmission, and consideration of the operational uncertainties of each over time.<sup>18</sup>

---

<sup>17</sup> *Market Resource Alternatives – an examination of new technologies in the Electric Transmission Planning Progress*, WIRES Group, September 2014.

<sup>18</sup> A comprehensive benefit analysis was outside the scope of work in this engagement, given that the levelized cost analysis demonstrated such a wide disparity between the costs (and associated practical challenges) related to implementing NTAs versus the costs linked to the development of the proposed transmission project.

LEI has applied these principles in this NTA analysis. The study begins with the simulation-based supply-side NTA analysis performed by ISO-NE, where the reliability requirements for the GH subarea were determined in the form of location-specific NTA requirements for one bus: NW Hartford. LEI then assigned technologies to the specified NTA requirements using a logical decision tree process to sequentially filter and narrow down the available list of technologies that meet the technical needs underpinning the solutions. Next, LEI employed a levelized cost methodology in order to evaluate the direct costs per annum to ratepayers of implementing NTA technologies. LEI's cost analysis was designed to be as comprehensive as possible. For each NTA technology, LEI developed an all-in cost (gross LCOE) inclusive of development and operation costs (capital cost, fixed and variable operating and maintenance cost, and fuel cost). The net LCOE values were then derived by adjusting gross LCOE values from potential revenues yielded by the NTA technologies.

### **3.2 Prospective NTA technologies**

Thirteen selected prospective NTA technologies have been short-listed based on their ability to operate in the GH subarea. The considered technologies have unique operating characteristics which are compared against NTA injection requirements to determine their feasibility. Figure 10 lists the technologies under consideration for technically feasible NTAs. In addition, the figure also outlines typical capacity ranges, operating profiles and performance rates associated with these technologies, which are detailed in Appendix B. In addition to stand-alone NTAs, the analysis also includes various practical combinations such as solar PV with storage, which are also included in the Figure 10.

In undertaking the technology identification and cost analysis, and for developing the technical assumptions in Figure 10, LEI relied primarily on real world operating experience with such technologies in New England, as well as research documents and market information made publicly available by ISO-NE, and the state of Connecticut related to technologies' operational data and statistics. The understanding of local market conditions was facilitated through Eversource's proprietary market information; where necessary, technologies' operational data were supplemented with engineering-related data and generic information on technologies, including generic information on levelized costs. Such generic information was collected from reputable sources, such as the US Department of Energy and affiliated national laboratories, manufacturers, and engineering procurement companies that work with such technologies. A detailed bibliography list is provided in Appendix D.

**Figure 10. Descriptive summary of NTA technologies**

MRA Resource	Installed Capacity range	Operations profile	Performance Rate
<b>Combined Cycle Gas Turbine (CCGT)</b>	100 to 800 MW range in CT	Baseload	95% availability factor
<b>Peaker Aeroderivative Unit</b>	1 to 125 MW range	Peaking load	85% availability factor
<b>Peaker Frame Unit</b>	20 to 250 MW range	Peaking load	83% availability factor
<b>Dual-fuel Jet Engine</b>	<1 to 50 MW	Peaking load	85% availability factor
<b>Solar Utility Scale (with storage)</b>	5 to 250 MW	Potential baseload depending on storage capacity	15% efficiency ratio
<b>Solar Utility Scale</b>	5 to 250 MW	Daytime peaking load during sunny days	15% efficiency ratio
<b>Solar DG (with storage)</b>	<1 to 5 MW	Potential peaking load depending on storage	15% efficiency ratio
<b>Solar DG</b>	<1 to 5 MW	Daytime peaking load during sunny days	15% efficiency ratio
<b>Fast Discharge Battery</b>	<1 to 10 MW	Can provide instantaneous power for short periods	Variable, depending on efficiency, charging time and storage capacity
<b>Slow Discharge Battery</b>	10 to 20 MW	Can provide steady supply of power for short periods	Variable, depending on efficiency, charging time and storage capacity
<b>Active DR - Emergency Generation</b>	Variable (based on type of equipment and load)	Peaking load	Assume 15% of peak load becomes available to respond
<b>Passive DR (Energy Efficiency)</b>	Variable (based on type of equipment and load)	Intermittent	Assume 15% of peak load becomes available to respond
<b>Fuel Cells</b>	2.8 MW to 63 MW	Baseload	95% availability factor

Note 1: Wind was not considered as a technically feasible NTA due to the lack of potential for sizeable wind capacity development in the Connecticut.

Note 2: Installed capacity range for utility scale fast and slow discharge batteries depends on the number of individual batteries connected together at a given site. The range indicated in the figure above is indicative, and LEI used variable sizes depending on requirements in order to ascertain the technical feasibility of using batteries as NTA technologies.

Note 3: Performance rates for CCGTs, Peaker Aeroderivative units, Peaker frame units and dual-fuel jet engines calculated based on the ISO New England EFORd Class Averages, sourced from: [http://www.iso-ne.com/static-assets/documents/genrtn\\_resrcs/gads/class\\_ave\\_2010.pdf](http://www.iso-ne.com/static-assets/documents/genrtn_resrcs/gads/class_ave_2010.pdf)

Note 4: Active DR emergency profile is sourced from ISO New England Operating Procedure No. 14 - Technical Requirements for Generators, Demand Resources, Asset Related Demands and Alternative Technology Regulation Resources." ISO-NE, November 7, 2014 [http://www.iso-ne.com/rules\\_proceeds/operating/isone/op14/op14\\_rto\\_final.pdf](http://www.iso-ne.com/rules_proceeds/operating/isone/op14/op14_rto_final.pdf).

Note 5: Size of fuel cells based on DFC3000 units from FuelCell Energy. The maximum size was based on the anticipated 63 MW fuel cells plant to be built in Connecticut (the largest yet in the world). Fuel Cells technology is baseload and can run 24/7 pending fuel availability. Given the limited information on availability factor, we assumed the same availability factor as a CCGT.

More details on the methodology and sources are provided in Appendix B.

In analyzing the potential for new energy efficiency as a technically feasible NTA technology, LEI assumed that at most 15% of the net peak load can be reduced using new energy efficiency measures. According to Eversource, achieving peak load reductions of 15% with passive energy efficiency resources over and above current levels is an aggressive assumption as it would represent approximately a two-fold increase in projected peak reduction currently expected from Eversource's energy efficiency programs. This level of peak reduction through passive energy efficiency resources would be unprecedented in Connecticut and the wider New England region, especially given that the more cost effective energy efficiency measures have been implemented. Achieving demand reduction will become (and has become) increasingly challenging and costly. In addition, successful geo-targeting energy efficiency to small geographic areas can be challenging as it relies upon customers willingness to participate in programs. For example, Eversource's Marshfield Distribution Relief Pilot (a targeted attempt to reduce 2 MW of demand on key circuits/substations through a combination of energy efficiency, direct load control, and solar PV installation) resulted in actual kW reductions of approximately 715 kW - less than 3% of peak day afternoon loads of 25,000 - 30,000 kW on the affected lines. Energy efficiency contributed only 320 kW to this achieved load reduction.

Operations profiles for each NTA technology are used to determine when a given technology can operate during a 24 hour period. N-1-1 contingency events require that a technically feasible NTA technology can operate for 12 hours. For each NTA technology listed in the figure above, its operations profile determines if it can meet the requirements posed by the contingency events. For example, while a peaker frame unit can operate for 24 hours, it may not be operating during off-peak night-time hours, which prevents it from a technically feasible NTA technology.

It bears noting that RTDR, which is typically associated with industrial or large commercial customer sites (such as manufacturing facilities or processing factories), was not directly taken into consideration in the analysis, although it could theoretically be considered as a potential NTA technology. There is limited publicly available information on RTDR's operational mode. Operation characteristics would vary from one resource to the other due to a host of parameters including equipment activity type, timing and duration of operation, response/performance rates and opportunity costs, which does not allow us to model these technologies with confidence. Furthermore, under ISO-NE's rules, RTDR and RTEG are not typically operable at any given time of the day, which would be a stumbling block to their technical feasibility under N-1-1 contingency events.<sup>19</sup> For reference purposes, LEI nevertheless estimated gross and net LCOE figures associated with both RTDR and RTEG in Appendix C.

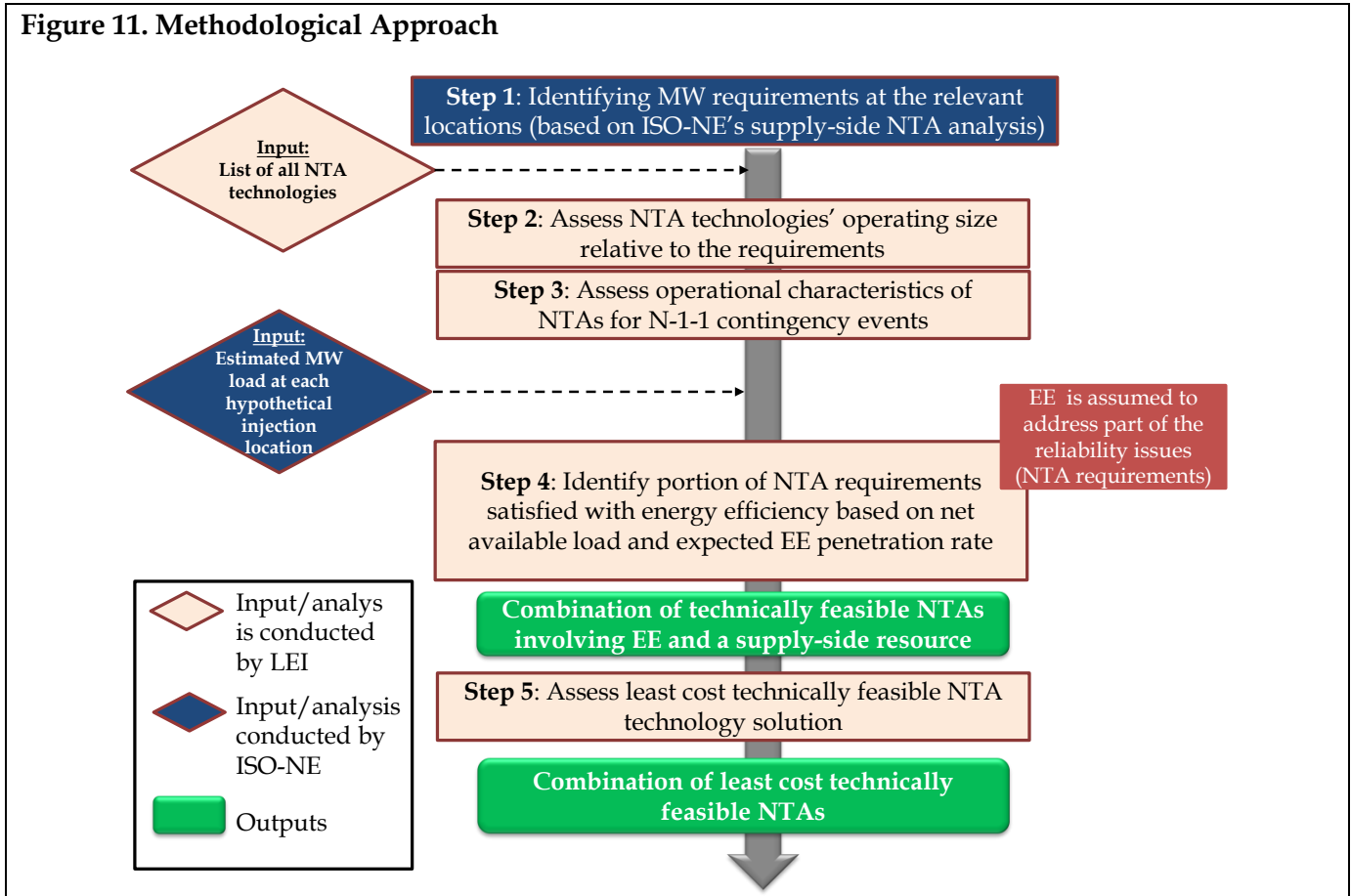
---

<sup>19</sup> " ISO New England Operating Procedure No. 14 - Technical Requirements for Generators, Demand Resources, Asset Related Demands and Alternative Technology Regulation Resources." *ISO-NE, November 7, 2014* <[http://www.iso-ne.com/rules\\_proceeds/operating/isone/op14/op14\\_rto\\_final.pdf](http://www.iso-ne.com/rules_proceeds/operating/isone/op14/op14_rto_final.pdf)>.

## 4 Overview of Methodological Approach

In order to identify technically feasible NTA technologies that can satisfy the reliability issues being addressed by the GHCCRP, a five-phase methodology was designed as illustrated in Figure 11 below.

**Figure 11. Methodological Approach**



The overarching objective of LEI's methodology from Step 1 through Step 4 is to: i) identify the portion of NTA requirements covered by energy efficiency programs at a given location; and ii) determine both volume (MW) and type of supply-side NTA technologies required to address the remainder of the capacity needs at the injection point. The methodology uses decision tree analytics to sequentially filter and narrow down the available list of technologies according to the requirements at each location. In summary, the five steps for selecting a technically-feasible NTA technology are as follows:

- Step 1: determine capacity needs (in MW) at the NW Hartford substation (completed by ISO-NE) to solve for reliability issues;
- Step 2: screen prospective technologies based on their size and the capacity needs at the injection point. This is analytically straightforward and effectively narrows the list of technically feasible NTA technologies for the subsequent steps;
- Step 3: evaluate the successfully screened NTA technologies based on their technical parameters and select the ones that conform to the contingency event requirements; and

- Step 4: evaluate the feasibility of addressing the reliability requirements with a combination of energy efficiency programs and supply-side NTA resources. The amount of EE relied upon is determined based on net available load and expected EE's penetration rate at the injection point.

While LEI recognizes that there may be multiple NTA technologies (or combination of NTA technologies) that are technically feasible at a substation, the purpose of this analysis is to only identify all possible technically feasible NTA technologies that individually meet the criteria of the hypothetical NTA injections (either in terms of size, location, or operating profile).

In the last step (Step 5), the levelized cost methodology evaluates the direct cost of implementing the combination of technically feasible NTA technologies for Connecticut ratepayers. Since no merchant sponsor is proposing to build an NTA and our analysis shows that it would not yield a sufficient return to attract private investment, we assume that it would be built only if its costs were borne by electric ratepayers. Those direct costs are then compared to the costs of building and servicing the components of the GHCCRP transmission solution. The direct cost to Connecticut customers is calculated by aggregating, net direct costs to consumers associated with constructing and operating the least cost technically feasible NTA technologies identified for the NW Hartford substation. The full cost of the NTA technologies would be passed through to Connecticut ratepayers. On the other hand, for the proposed transmission solution, the costs of the transmission solution will be rolled into regional network service and recovered through the Pooled Transmission Facilities rates. Therefore Connecticut ratepayers would only pay a share of those costs based on current ISO-NE rules for transmission cost allocation (i.e., 27% of the total costs to construct and operate, based on current load projections).

#### **4.1 Determination of hypothetical NTA solutions**

As part of the process for the needs assessment for the GHCC and identification of preferred transmission solutions, ISO-NE conducted two NTAs studies<sup>20</sup> in late 2012 that identified the smallest aggregate quantity of injections (as measured in MW terms) across the four subareas (the entire GHCC area) that would alleviate the thermal system overloads. The assumptions underpinning the NTA studies are based on the initial Needs Assessment study (2012). ISO-NE performed separate and distinct hypothetical analyses for either a 100% demand-side solution or a 100% supply-side solution – both analyses were done under a number of different dispatch conditions, with the objective being to identify a minimum amount of total MWs (dispersed across the “best” locations) associated with either net load reduction or additional supply that would resolve all overloads and thermal violations under N-1-1 contingency events. The analyses were performed for the GHCC area as a whole, instead of at subarea level. Figure 12 summarizes the assumptions relied upon for the Needs Assessment and therefore for the NTA studies.

---

<sup>20</sup> According to ISO-NE, the two analyses were conducted separately consistently with ISO-NE's protocol at the time. Since then, ISO-NE has moved to a hybrid approach considering both supply-side and demand-side resources under the same analysis.



**Figure 12. Summary of modeling assumptions used in the NTA studies**

Items	Description	Sources
Horizon	10 years (2013-2022) with a focus on the year 2022	ISO-NE
Power Flow study	ISO-NE's Model on demand system to reflect system conditions in 2022	ISO-NE
Topology	Included transmission projects with proposed plan application approved as of April 2011 as well as new projects as of October 2013.	April 2011 RSP Project Listing, and ISO-NE
Supply	Generation projects with a FCM Capacity Supply Obligation as of Forward Capacity Auction 7 (FCA #7) were included in the study base case. This includes the Cape wind project which materialization is in jeopardy. It does not include Bridgeport Harbor 2 and Norwalk Harbor.	GHCC Needs Assessments
Load	Used year 2022, 90/10 summer peak load level from the CELT: 34,105 MW for New England and 8,825 MW for Connecticut.  The CELT load forecast includes both system demand and losses (transmission and distribution) from the power system.	CELT report issued in May 2013
Energy efficiency (Passive DR)	Includes 100% passive demand response cleared in FCA (#1 to #6); Assume 100% of EE forecast for the remaining years 2016-2022. EE resources were modeled via a load reduction spread across their respective load zones.	FCA (#1 to #6); Final 2013 Energy-Efficiency Forecast 2016-2022 (March 2013)
Active demand response ("DR")	Based on active demand response cleared in FCA (#1 to #6) to which it is applied a 75% performance factor based on historical performance of similar resource. Active DR were modeled via a load reduction spread across their respective dispatch zones.	FCA (#1 to #6)

The ISO-NE's supply-side analysis estimated that approximately 936 MW would be needed to solve overloads and thermal violations in the GHCC area (and 196 MW in the GH subarea), versus 1,350 MW for the demand-side analysis. There were three fundamental aspects of the ISO-NE's analyses that needed to be considered in deciding on the pertinence and the usability of ISO-NE's study results:

- i) *The choice of NTA study:* should LEI use the demand-side or the supply-side NTA study or both?
- ii) *The independence of the NTA requirements for the various subareas:* can the NTA requirements for each subarea be evaluated without consideration of the NTA needs in another subarea?
- iii) *The staleness of the NTA studies:* is it reasonable for LEI to rely on NTA requirements based on a study performed in late 2012?

Further details on the consideration of these three issues is provided below. However, in summary, based on discussion with ISO-NE staff that authored the NTA studies and discussions with Eversource's system planners, LEI concluded that the demand-side NTA study did not need to be

evaluated. LEI also concluded that the NTA requirements for each subarea can be analyzed individually, and that the requirements themselves as estimated by ISO-NE in late 2012 were still valid.

#### 4.1.1 Choice of NTA study

The NTA demand-side analysis has unrealistic demand reduction assumptions.<sup>21</sup> This NTA study was one of the first ever done by ISO-NE and the ISO has since then modified its approach. LEI’s understanding was confirmed by a discussion with ISO-NE staff,<sup>22</sup> who recommended not developing any analysis based upon these results. ISO-NE staff suggested testing the feasibility of both supply-side and demand-side technologies at the NW Hartford substation based on the total requirement identified under the NTA supply-side analysis (as summarized in the figure below, and totaling 196 MW).

**Figure 13. Summary of injection requirements for the hypothetical NTA solution for the GH subarea**

Project Subarea	Substation	MRA requirements
Greater Hartford	NW Hartford	196 MW

#### 4.1.2 Independence of NTA requirements across subareas

When ISO-NE expanded the scope of its GHCC Needs Assessment in 2011 to cover all of the Greater Hartford, Manchester/Barbour Hill, Middletown, and Northwest Connecticut subareas, it expected, based on earlier, preliminary study results, that the needs and solutions in the four subareas would be “interdependent.”<sup>23</sup> This was still the case when the ISO-NE performed its initial GHCC Needs Assessment, which was presented in August, 2012 (Needs Assessment I), and its NTA studies,<sup>24</sup> which were presented to the PAC in November and December 2012.

The NTA studies “used the same conditions and study criteria used in the [initial] GHCC Transmission Needs Assessment.”<sup>25</sup> In the studies, ISO-NE cautioned that each subarea’s NTAs “work only if applied simultaneously with other subareas.”

Subsequently, as work progressed on the preferred transmission solutions for the GHCC area, through a “Working Group” that was led by ISO-NE planners (and included representatives of the planning staffs of the Northeast Utilities Service Company and The United Illumination Company), it became

<sup>21</sup> For instance 64% of demand reduction was assumed for the Northwestern CT subarea, Source: NTA Demand side results GHCC, PAC meeting, November 14, 2012.

<sup>22</sup> Discussion with Justice Ansah and Dwarakesh Nallan on May 14, 2015.

<sup>23</sup> Planning Advisory Committee Presentation, “Greater Hartford and Central Connecticut Area (GHCC) Needs Assessment Scope of Work, March 16, 2011, at page 3

<sup>24</sup> Demand-side and supply-side NTA studies.

<sup>25</sup> Supply-side MRA analysis, at page 7.

clear that previous assumptions on interdependence were not relevant. As the Working Group developed transmission solutions to address criteria violations in the four subareas, they realized that the needs of each subarea could be resolved independently. As stated in their final Solutions Report, published in February, 2015, the Working Group ultimately determined that the solutions for different subareas within the greater GHCC area could be analyzed independently of one another since the needs for the area were largely driven by load serving issues following the loss of critical 115 kV sources into each area. Thus, in the final Solutions Report, the Working Group analyzed separate “local solution alternatives” for the Northwestern Connecticut subarea, the Middletown subarea, and for the GH subarea.

Eversource planners who were part of the ISO-NE GHCC Working Group have advised LEI that it is reasonable to assume that, since each subarea was ultimately determined to be an independent local transmission solution, each subarea could also be considered as independent local non-transmission solution. In a memo submitted to LEI on the topic, Eversource stated that “to determine if there is a practical NTA for the GH subarea, an NTA consisting of the quantities (MW) of injections or load reductions at the busses specified in the ISO-NE study for each of these subareas may be analyzed without considering the solutions that would need to be implemented to address issues in other subareas.” Further, “if a conceptual NTA identified by ISO-NE’s NTA analysis is determined to be practical, based on cost, technical, environmental and siting considerations, then additional system modeling can be performed to confirm that it will provide the expected performance on its own, or what additional transmission or non-transmission improvements would be required.”<sup>26</sup>

#### **4.1.3 Staleness of the NTA studies**

ISO-NE’s supply-side NTA analysis was performed based on the assumptions in the GHCC Needs Assessment presented to the PAC meeting in December 2012. Thereafter, in light of significant changes in predicted resources in the study area, ISO-NE revised<sup>27</sup> its Needs Assessment to reflect increases in the predicted Connecticut net load for 2022 and changes in the distribution of that load. As a result, the modeled net load for the GH subarea changed from 1,203 MW to 1,222 MW, an increase of 19 MW or 1.5%. While it is possible that these changes might result in a change to the NTA requirements identified in the 2012 supply-side NTA study, the change, if any, would be an increase in the required MW according to Eversource planners. In other words, for the purposes of assessing the technical feasibility of NTA technologies to the proposed transmission improvements, it is reasonable to consider the NTA requirements identified in ISO-NE’s analysis (without consideration for additional MW) to conduct our independent analysis. Should an NTA be found to be the least cost solution based on economic, environmental, and siting considerations, supplemental load flow studies would need to be performed to assess the performance of the NTA and whether any changes to the NTA quantity are required.

Figure 14 shows the geographical location of the NW Hartford substation (bus) in relation to the interstate natural gas pipelines that supply Connecticut. The injection amount or requirement is in

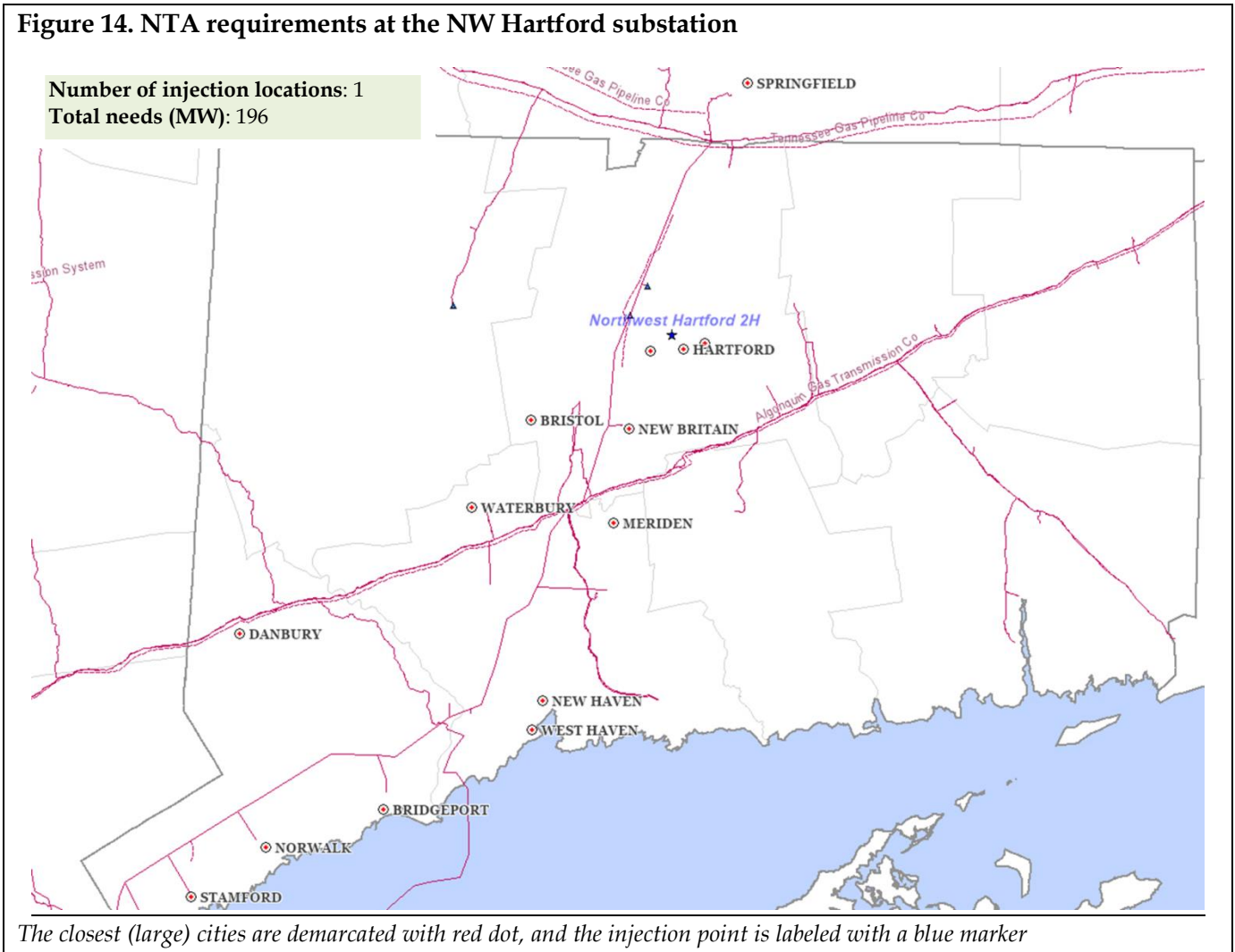
---

<sup>26</sup> Analysis of Non Transmission Alternatives to Transmission Improvements in Greater Hartford and Northwest Connecticut Subareas, Robert Russo and Joseph Adadjo, Eversource Energy Service Company, Planning, June 8, 2015.

<sup>27</sup> Greater Hartford and Central Connecticut (GHCC) Area Transmission 2022 Needs Assessment, May 2014.

capacity (MW terms) but also effectively represents an amount of energy that would be needed to be injected into the system at a given moment in time, in order to ensure reliable operations during contingency events.

**Figure 14. NTA requirements at the NW Hartford substation**



#### 4.2 Methodology for identifying technically feasible NTA technologies

As summarized in the previous section, LEI used a five-step methodology for selecting the least cost technically feasible NTA technologies at the NW Hartford substation. The first four steps are dedicated to the selection of all the technologies that would be technically feasible at the relevant location, whereas the last step is used to select the least cost of this group of resources.

A technically feasible NTA technology is defined as one that can independently fulfill to all the requirements at the specific location. In other words, if at a location, two different technologies are required to work together (e.g. solar PV during the day and a CCGT at night) to meet the requirements,

then neither of these technologies is determined to be technically feasible for this location on their own.<sup>28</sup>

However, a given location can have multiple NTA technologies that can each independently meet the NTA requirement. In such cases, the final selection from among the technically feasible NTA technologies is based on their levelized costs (multiplied by the NTA requirement), as discussed further in Section 5.1 below.

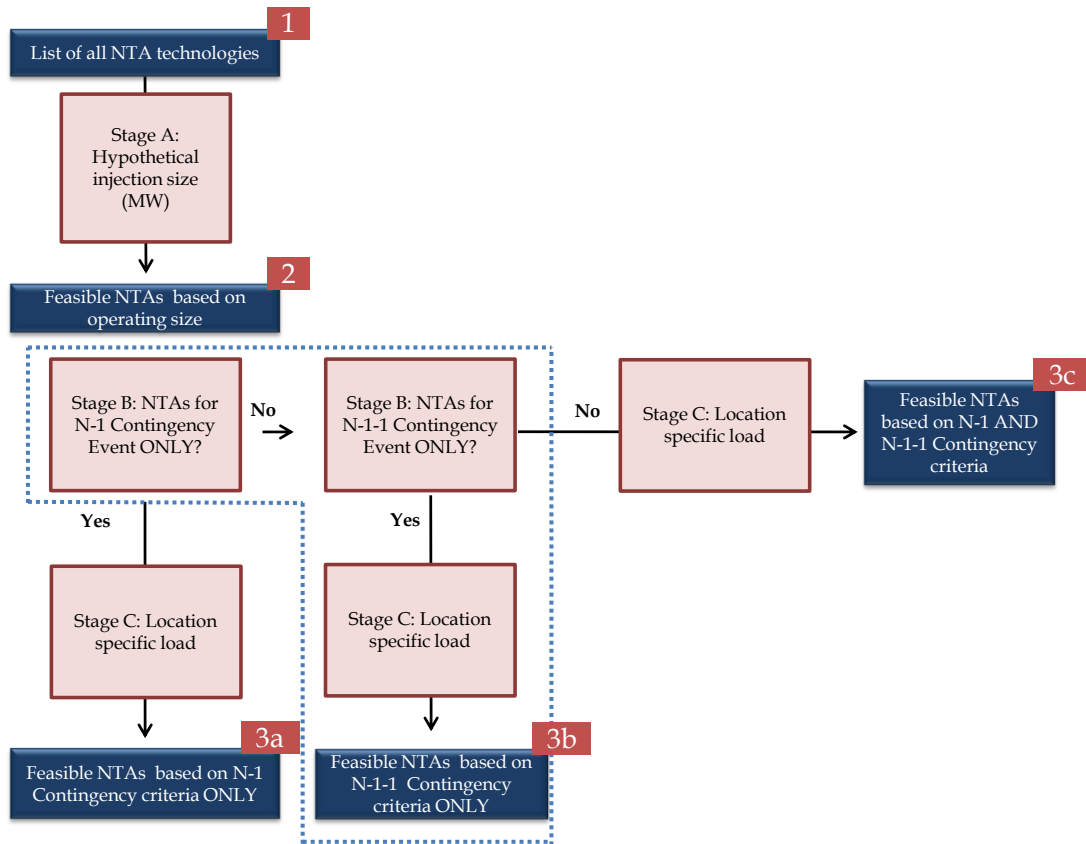
When we use the term, “technically feasible”, we are reflecting on a specific technology’s ability to meet requirements set out by system planning criteria, and therefore in the case of this analysis, “feasibility” is not to be interpreted in the more connotative sense of the word (and the technologies may still be deemed to be impractical or commercially infeasible, as discussed in Section 5 of this report). System planning criteria refers to requirements such as the maximum allowable time for an NTA technology to respond to N-1-1 contingency events (response time) and the minimum duration of time for which an NTA technology must remain operational after being called into service. In contrast, physical considerations, which are not a part of this methodology, refer to the amount of land required for a given NTA technology to be located at a substation and the time required for siting and construction, as well as the anticipated market need for the NTA technology in the future. These physical constraints and commercial development considerations are presented in Section 5.2. The cost implications of technically feasible NTA technologies are also discussed in detail in Section 5.1.

Figure 15 depicts in a flow chart the decision process followed to arrive at a selection of technically feasible technologies that clears both the size and the operational criteria commanded by n-1-1 contingency events. The decision process is another interpretation of Steps 1 through 4 of Figure 11.

---

<sup>28</sup> The exception to this philosophy relates to solar PV technologies and energy storage. We do combine these two separate NTA technologies in order to form a third unique technology; energy storage enables the solar PV unit to qualify as a technically feasible NTA technology (if some of the production from day-time hours is stored so that it can be injected into the grid at night).

**Figure 15. Methodology for identifying technically feasible NTA technologies (supply-side resources)**



Note: Circled in dotted line is the process followed for selecting technically feasible NTA technologies based on operating size, operational characteristics and n-1-1 contingency criteria.

### **Stage A: Size**

The first step focuses on the level or size of injection required by location or node. Upon reviewing commercial information provided by manufacturers (such as General Electric (“GE”), SIEMENS or FuelCell Energy) on technologies, and comparing the typical size of the prospective resources in operation in Connecticut against the size of injection requirements at each location, it is possible to eliminate NTA technologies that are not suitable to the size of the injection. The maximum and minimum sizes considered for each NTA technology are summarized in Figure 10.

### **Stage B: Operational**

We then move to consider the operating characteristics of the list of technically feasible NTA technologies from Stage A, relative to the requirements of the NTA injection amounts. These operating characteristics refer to N-1-1 contingency events. LEI understands that as part of the NTA studies, ISO-NE modeled the N-1-1 contingencies, as those were more severe than the N-1 contingencies.

N-1 and N-1-1 contingency events have associated operational considerations that must be met by a technology in order to be considered a technically feasible NTA technology. Although LEI's selection process was designed to be fully inclusive and solve multiple situations, including those where NTA requirements would emerge under both N-1 and N-1-1 contingency events, this analysis only considered N-1-1 events' criteria with respect to technologies' operational characteristics - as highlighted in dotted line on Figure 15. An N-1 contingency event refers to a situation when a single element of the generation or transmission system fails. An N-1-1 contingency event refers to a situation where an additional single element of the generation or transmission system fails within 30 minutes of the N-1 contingency event. Under these circumstances, a qualified NTA technology must be able to provide energy within 30 minutes and must continue to do so until the elements are repaired or as long as deemed necessary by the ISO-NE (typically, ISO-NE can resolve contingency events within a 12 to 24 hour cycle; LEI has assumed a 12 hour duration to resolve the N-1-1 contingency events in its analysis.

### ***Stage C: Locational***

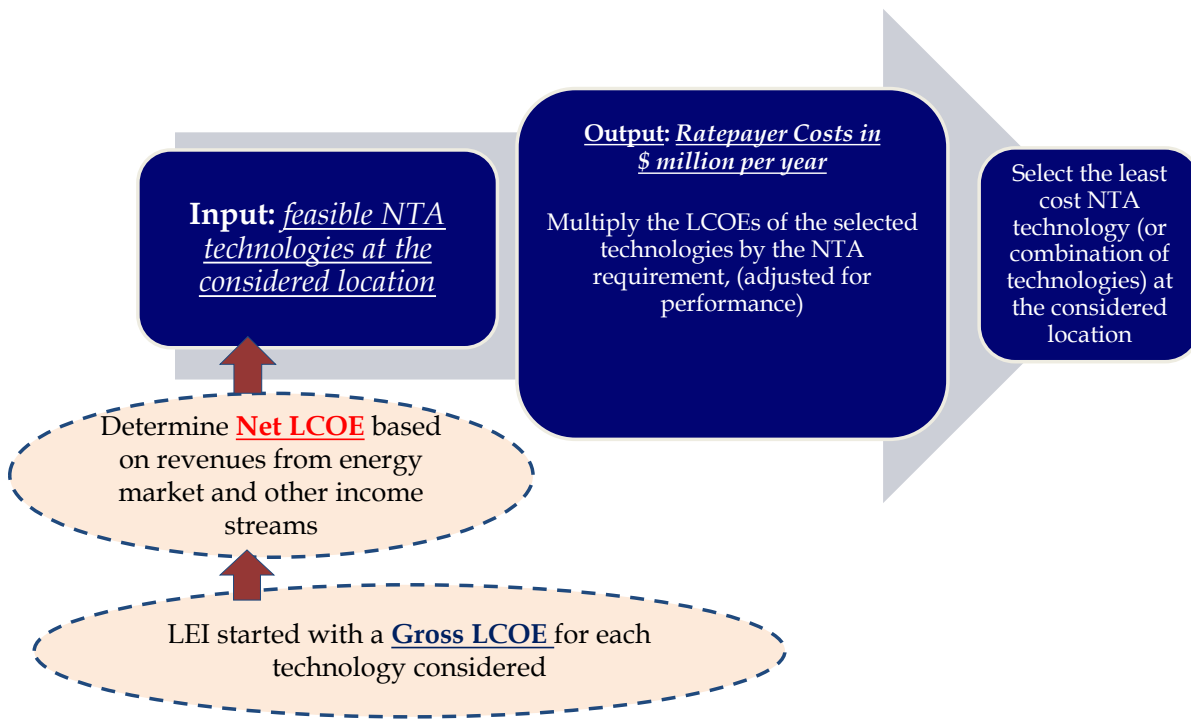
The last stage further refines this list of technically feasible NTA technologies by using locational considerations at the NW Hartford substation. This stage of the methodology evaluates the potential for implementing incremental EE measures based on the net load (MW demand) at each injection location. We assumed that energy efficiency programs will be part of any NTA solution deemed feasible to address reliability requirements. The underlying assumption is that the level of peak reduction achieved through passive energy efficiency resources would not exceed 15% at the relevant location, lowering consequently the associated NTA requirements. Achieving incremental peak load reductions from energy efficiency of 15% above levels achieved through state-mandated programs would be unprecedented as such a target reduction goes well beyond utility geo-targeting experiences to date.

The sample of NTA technologies resulting from LEI's selection process were then used as direct inputs into the cost analysis.

### **4.3 Methodology for estimating cost of technically feasible NTA technologies**

LEI applied industry-standard levelized costing principles to the identified pool of technically feasible NTA technologies from Stage 3B (Figure 15) above in order to estimate the total cost of implementing the least cost technically feasible NTA technologies. For each selected technology, LEI estimated a gross LCOE, which represents a resource' all-in-costs, levelized over its life cycle. The gross LCOE is a per kilowatt per year figure (\$/kW-year) that embodies all costs including capital costs, going-forward FOM costs, as well as fuel and VOM costs. The gross LCOE represents a long term timeframe that is consistent with the requirements identified at the NW Hartford substation. As a next step, LEI derived Net LCOE for each technology by deducting from gross LCOE a bundle of potential revenue streams associated with each NTA technology. The analysis then consisted of multiplying at the considered injection point the net LCOEs of all feasible technologies by the NTA capacity requirements (adjusted for performance and availability). The least cost technically feasible NTA solution for NW Hartford was selected by comparing the products of net LCOEs and NTA capacity requirements for all feasible technologies. Finally, we aggregated the total costs associated with the identified least cost technically feasible NTA technologies at NW Hartford in order to determine net direct cost for the Connecticut ratepayers. Figure 16 provides an illustration of this methodology.

**Figure 16. Methodology for estimating net direct costs of technically feasible NTA technologies (\$/kW-year)**



*Gross and Net LCOE are expressed in dollars per kW-year unless otherwise specified.*

#### 4.3.1 Determining gross LCOE for technically feasible NTA technologies

Gross LCOE represents the total fixed cost of NTA technologies levelized over the lifetime of the relevant technologies. As discussed previously, gross LCOE includes capital costs, fuel costs, as well as both FOM and VOM. Gross LCOE is denominated in \$/kW per year and then multiplied by the installed capacity of the technically feasible NTA technologies to derive an annual gross cost. Figure 17 provides a summary of calculated gross LCOE for all technologies deemed technically feasible. For cost information, LEI relied primarily on data made publicly available by ISO-NE and the state of Connecticut. We then cross-compared and supplemented this data with information collected from reputable sources, such as the US Department of Energy and affiliated national laboratories, manufacturers and engineering procurement companies that work with such technologies, as well as actual operating data from similar installations across New England.

Appendix C provides a detailed description of assumptions and sources used for determining the ranges of gross LCOEs. LEI defined a +/- 20% range of gross LCOE to take into consideration the uncertainty associated with cost assumptions. In fact, in real life, development and operation costs of facilities can vary significantly and deviate from a generic assumption due to a variety of reasons including plant location, financing structure and market conditions, technology types, labor cost, environmental cost, site preparation, fuel supply, etc. The cost range was suggested in an attempt to



crystallize this uncertainty. The +/-20% cost range was used to measure the impact of this uncertainty on the net direct costs of technically feasible NTA solutions.

**Figure 17. Summary of Gross LCOE per year for each technology**

Feasible Technologies (all numbers in \$/kW - year unless specified otherwise)	Gross LCOE (\$/kW-year)	Range (\$/kW-year) +/-20%	
CCGT	\$ 418.0	\$ 334.4	\$ 501.6
Peaker Aeroderivative	\$ 323.4	\$ 258.7	\$ 388.1
Dual fuel jet engine	\$ 362.9	\$ 290.3	\$ 435.5
Slow Discharge Batteries	\$ 181.4	\$ 145.1	\$ 217.7
Solar Utility Scale (with storage)	\$ 415.9	\$ 332.7	\$ 499.1
Passive DR (Energy Efficiency)	\$ 513.0	\$ 410.4	\$ 615.6
Fuel Cells	\$ 382.7	\$ 306.1	\$ 459.2

Gross LCOE for CCGT was adjusted to reflect smaller than standard size of the required plant. The size of generic CCGT considered in ISO-NE’s analysis ranges between 500 and 700 MW. CCGTs needed to meet the NTA requirements in this analysis are much smaller and therefore, they are likely to be more expensive in dollar per kW terms. The opportunity cost of inefficient scale for CCGTs is reflected in the numbers above by application of a 12% increase to the gross LCOE figure, based on the overnight cost difference between 400 MW and a 600 MW CCGT power plant (Source: EIA).

Sources: ISO-NE (ISO New England Inc. and New England Power Pool, Docket No. ER14) 000, Demand Curve Changes, Paril 2014), National Renewable Energy Laboratory (“NREL”), Pacific Northwest National Laboratory (“PNNL”), International Energy Agency, Electric Power Research Institute (“EPRI”), Department of Energy, FuelCell Energy and LEI

### 4.3.2 Determining Net LCOE for technically feasible NTA technologies

The total gross cost of NTA technologies can be defrayed by market revenues and other sources of income received by these resources when they begin operations, which in turn would reduce the cost of the NTA to ratepayers. Therefore we deduct these revenues from the gross LCOEs, so as to isolate the net direct costs to ratepayers for a technically feasible NTA solution. In this respect, LEI adjusted the gross LCOE analysis by incorporating a number of potential market revenue streams associated with each feasible technology. The resulting calculation is the net LCOE which is relied upon to evaluate net direct cost of implementing technically feasible NTA technologies for ratepayers. The revenue streams considered in this analysis include revenues from the energy and capacity markets, Local Forward Reserve Market (“LFRM”) and Regulation Market revenues, income associated with avoided retail rate costs (for solar DG and energy efficiency resources), as well as Renewable Energy Credits. However, we did not integrate in the analysis any additional charges (such as Net Commitment Period Compensation (“NCPC”) associated with operating the technologies out of merit.<sup>29</sup> Figure 18 depicts

<sup>29</sup> NCPC is the additional compensation received by a resource that is committed for reliability purposes but not dispatched above its economic minimum output level.

the revenue streams considered and provides a summary of calculated Net LCOE by feasible technology. Appendix C summarizes the sources relied upon to estimate the revenue offsets.

**Figure 18. Components of the net LCOE calculations for each technically feasible NTA technology (\$/kW-year)**

In \$/kW-year	CCGT	Aero Peaker	Passive DR (EE)	Fuel Cell
<b>Gross LCOE</b>	418.0	323.4	513.0	382.7
<b>Energy*</b>	283.3	117.8	-	54.0
<b>FCM</b>	57.3	57.3	61.9	-
<b>LFRM</b>	-	-	-	-
<b>Regulation</b>	-	-	-	-
<b>Avoided retailed cost</b>	-	-	143.3	-
<b>Net LCOE</b>	77.4	148.3	307.8	328.7

Notes: This table illustrates net LCOEs for a scenario assuming half of FCM payments are received by the resources. Rows highlighted in pink represent revenue offsets, while the bottom blue row contains the net LCOE results from the realization of all of these revenue offsets.

*FCM price based on FCA#9 results (\$9.55/kW-month) (before adjustment for derating factor and scenario)*

*\*Energy revenues inclusive of VOM and fuel cost recovery*

*LFRM (\$/MW-month) for summer 2013: \$2,996; LFRM (\$/MW-month) for winter (2013/2014): \$5,501*

*Annual average regulation price (without performance payment in 2013):\$18/MWh*

*Avoided retail cost: (based on average residential retail rate) \$21.9/MWh*

*Charging costs for battery have not been taken into account*

Sources: ISO-NE, NREL, PNNL, IEA, EPRI, DOE and LEI

## 5 Analysis and results

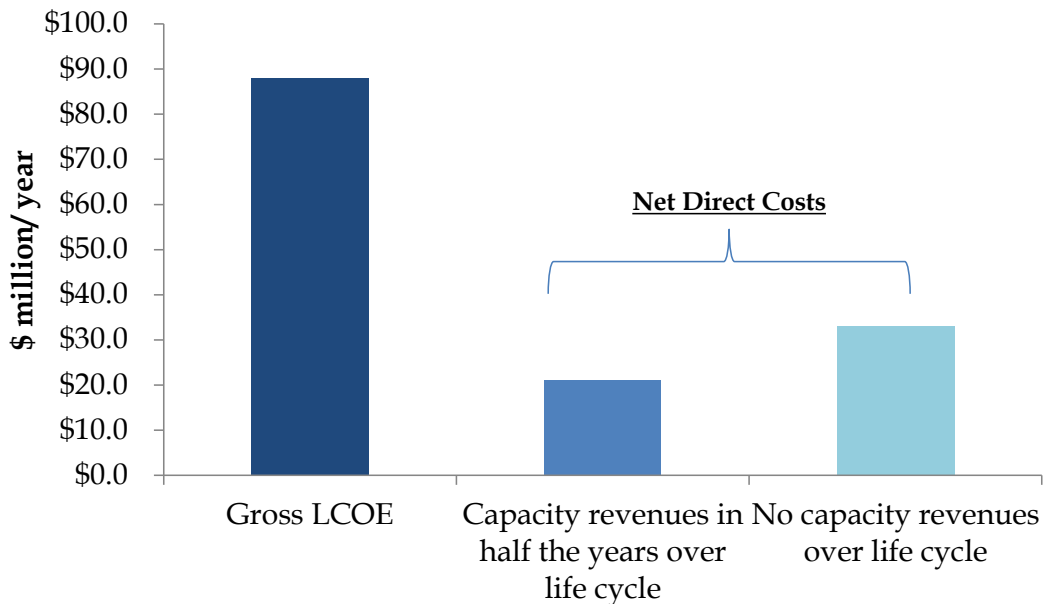
Of the total thirteen NTA technologies under consideration, two technologies qualify as technically feasible for the GH subarea. At the NW Hartford substation (196 MW of requirement), the technically feasible NTA technologies include: (i) CCGT and (ii) peaker aeroderivative (multiple units). And, based on our hybrid approach, some of the requirements can be fulfilled by EE. We believe that no more than 23 MW of load reduction via EE should be expected given the assumed 15% threshold of demand reduction. Fast discharge batteries, solar PV (DG and utility scale) without storage, and peaker frame units are among the technologies that never qualify as technically feasible NTA technologies owing to their various technical characteristics (i.e., limitations on performance duration, and/or time of performance).

The injection amounts associated with these technologies need to be converted into an installed capacity figure using the performance rates of each individual technology (e.g., availability factor for thermal technologies, conversion efficiency for solar units and batteries). For instance, a requirement of 1 MW may actually require installed capacity that exceeds 1 MW. Furthermore, since more than one NTA technology can be technically feasible for a given location, the installed capacity of all the technically feasible technologies can be significantly larger than the NTA requirement at that location, as there are multiple feasible technologies that are possible at many locations. For example, the 196 MW of NTA requirements at NH Hartford translate into 206 MW of CCGT installed capacity after accounting for expected performance (without taking EE into consideration).

The cost analysis begins with the evaluation of total cost of technically feasible technologies based on gross LCOE and estimated required nameplate capacity. Under the baseline gross LCOE, gross costs for a technically feasible NTA to the GHCCRP that involve a small portion of EE and CCGT resources, are estimated at \$88 million per year. When adding a +/- 20% sensitivity on gross LCOEs, the resulting gross costs range from \$70 million to \$105 million a year.

LEI recognizes that total costs of NTA technologies can be defrayed by revenues from markets as well as other sources. Therefore, in estimating the cost of a feasible NTA solution that would be payable by Connecticut ratepayers, LEI elected to deduct expected notional market revenues from the gross costs in order to derive a net LCOE. The net LCOE multiplied by the required nameplate capacity for the technically feasible NTA technologies completes the process of estimating the net direct cost to ratepayers.

**Figure 19. Illustration of gross and net direct cost**



The primary uncertainty in estimating the net LCOE is the revenue forecast for each technology. Running a full blown simulation for each technology and forecasting year by year revenues was outside the scope of this study. Therefore, projected revenue offsets were estimated using existing market information and general market expectations for the future.<sup>30</sup> For example, for capacity revenue, LEI assumed an average price over time consistent with FCA#9. Energy market revenues were forecast based on information relied upon by ISO-NE to establish net CONE for various technologies, and other rules within the FCM. In summary, the net direct cost was estimated to range between \$21 million and \$33 million per year across the two scenarios. The two scenarios vary according to the level of capacity revenues attributable to NTA resources during the technologies' lifecycle. The scenario that produces the lowest net direct cost to ratepayers is Scenario 1, where the technically feasible NTA technologies are assumed to receive capacity payments over half the years of their lifecycle. Under this scenario, the net direct cost to ratepayers is estimated at \$21 million a year, which is significantly more than the portion of the annual revenue requirements of the GHCCRP transmission solution, supported by Connecticut ratepayers (approximately \$4.6 million). In addition, it is important to keep in mind that 100% of the NTA technologies' costs would be shouldered by Connecticut ratepayers; whereas only 27% of the projected annual revenue requirement (27% of \$17.1 million a year) for the transmission solution is expected to be borne by Connecticut end-users.<sup>31</sup>

<sup>30</sup> A detailed modeling analysis would be required to further refine these revenue estimates and factor in the resources' year on year impacts on market conditions and how that, in turn, affects market prices; such an analysis is beyond the scope of this report.

<sup>31</sup> Transmission solution costs provided by Eversource

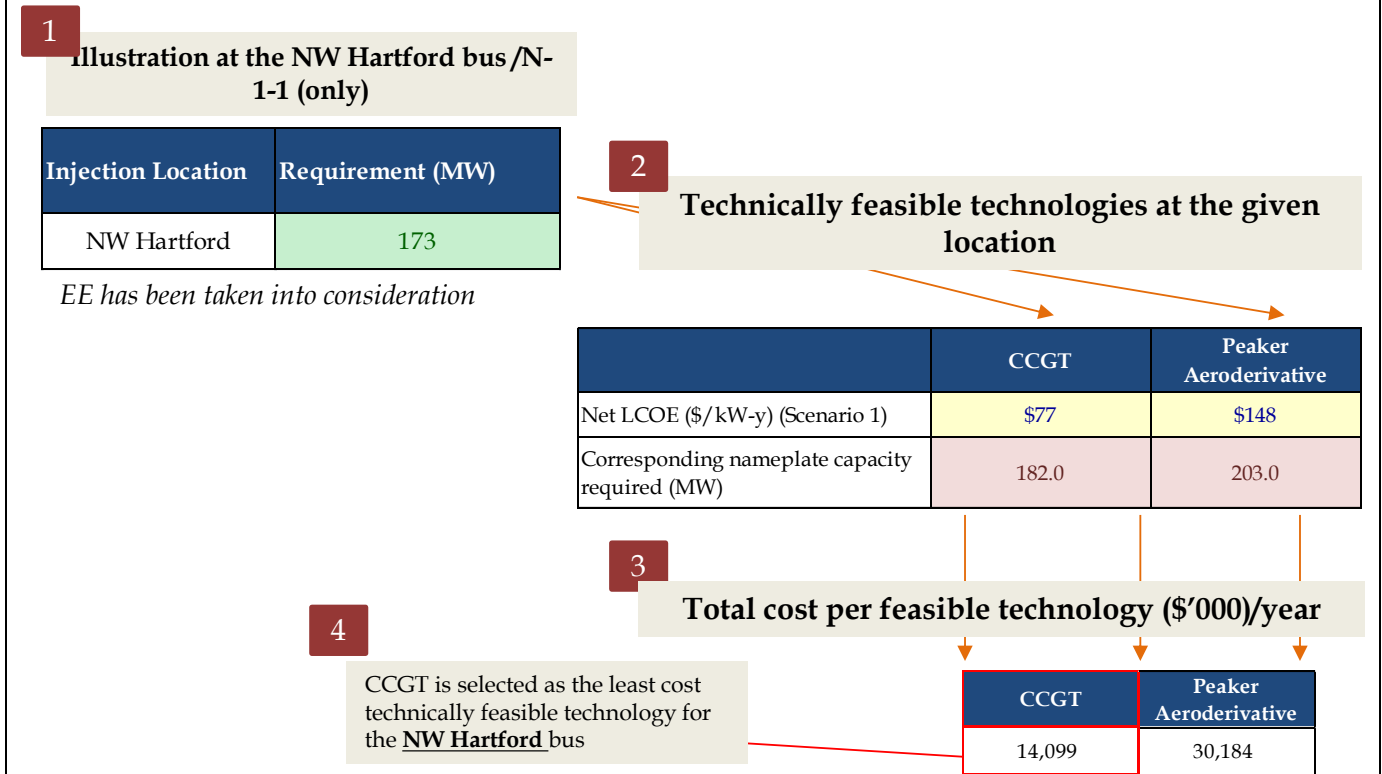
## 5.1 Cost estimates

The goal of the cost analysis is to evaluate the net direct cost of implementing NTA technologies for Connecticut ratepayers as opposed to building the components of the GHCCRP transmission solution. The analysis begins with the evaluation of total cost of technically feasible technologies based on gross LCOE and nameplate capacity, followed by a net LCOE analysis which leads to an estimate of the net direct costs to ratepayers.

### 5.1.1 Gross cost estimates for ratepayers

Under the base line gross LCOE, gross cost for ratepayers is estimated at \$88 million a year for a hybrid NTA solution at the NW Hartford bus. This gross cost reflects 23 MW of EE, along with 182 MW of CCGT technology. When adding a +/- 20% sensitivity, the resulting gross direct cost falls within a range of \$70 million to \$105 million a year. The cost analysis was done for all identified technically feasible NTA technologies based on the combination of their respective gross LCOE and total nameplate capacity requirements - adjusted for operating factors.<sup>32</sup> At the NW Hartford bus, we compared the resulting costs for all technically feasible NTA technologies to derive the least cost NTA technology LEI then tested both higher (+20%) and lower (-20%) gross LCOEs.

**Figure 20. Illustration (in four steps) of least cost technically feasible technologies selection**



<sup>32</sup> Operating factors include capacity factor, availability factor and ramping rates.

At the NW Hartford substation, EE in combination with a CCGT is the least cost technically feasible NTA technology.

It is worth noting that the successful development of 182 MW of gas-fired generation in NW Hartford might be challenged by a host of physical constraints such as land and fuel supply availability, access to cooling water and other factors, as discussed in Section 5.2. Therefore, the gross LCOE analysis of technically-feasible NTA technologies is not sufficient to determine whether a NTA solution is practical.

### 5.1.2 Net direct cost estimates of NTA solutions for ratepayers

As discussed in Section 4.3.1, the major revenue offsets for NTA technologies include energy and capacity revenues. However, capacity revenues are not certain for these NTAs. First of all, the capacity auction occurs three years in advance and new resources must apply to qualify a year in advance. Therefore, an NTA that is aiming to go into service in 2016 would not be able to secure capacity revenues until May 2021 at the earliest (assuming it has not yet applied in the Show of Interest window for the next FCA for the 2019-2020 deliverability period). In fact, if there is surplus capacity supply, a new resource may not clear, even if it qualified to participate in the capacity auction. Based on LEI's analysis of market developments and ISO-NE's load projections for the future, there may not be "room" in the near term future auctions for additional resources to clear. So NTA resources brought to market in order to serve as part of an NTA solution for GHCCRP would likely not get revenues from capacity sales for some of its operating years.<sup>33</sup> In fact, in the most recent auction (FCA#9), there was enough capacity to meet the system wide Installed Capacity Requirement ("ICR"). Going forward, we do not see an immediate need for new capacity resources as future capacity needs are expected to be met by other resources, including energy efficiency and other announced resources. As such, there will be no "room" in the capacity market for significant new gas-fired generation, unless existing resources decide to exit the market (i.e., delist and retire). Moreover, for a new generating resource to be accepted and qualified to participate in the FCM, it would not be able to use out-of-market funding (by customers) to gain a competitive advantage on other capacity suppliers. ISO-NE requires that all new resources offer into the FCA consistently with their fundamental costs of investment. Based on ISO-NE's published offer review trigger price ("ORTP") data, the minimum acceptable offer price for a generic gas-fired CCGT is \$9.170/kW-month and minimum acceptable offer price for a generic gas-fired peaker is \$13.820/kW-month.<sup>34</sup> Therefore, if the capacity price is lower than this minimum offer price, neither the new CCGT nor the new peaker would be able to compete with existing generation and therefore would not clear the FCA.

In addition, there is uncertainty regarding future capacity prices. Over time, when the ISO-NE capacity market is balanced, then capacity clearing prices in the FCA will tend to the net CONE. However, there may be years where prices are significantly below that price level. And if all the resources in an NTA

---

<sup>33</sup> None of the technically feasible NTA technologies are currently being considered by investors for development at the NW Hartford substation in the GH subarea. Should gas-fired generation be built and interconnected with the NW Hartford substation, it would likely require out-of-market compensation, especially given the timetables of the Forward Capacity Market vis-à-vis the timing of the required solution.

<sup>34</sup> Parameters for the Tenth Forward Capacity Auction (FCA #10), Capacity Commitment Period 2019-2020. [www.iso-ne.com/static-assets/documents/2015/05/parameters\\_for\\_the\\_tenth\\_forward\\_capacity\\_auction.pdf](http://www.iso-ne.com/static-assets/documents/2015/05/parameters_for_the_tenth_forward_capacity_auction.pdf).

solution were to clear the FCA, that would reduce the clearing price in the FCA (and the capacity revenue offsets in the net LCOE), which would then raise the net direct costs of the NTA solution to ratepayers. In light of these capacity market timing and pricing uncertainties, LEI calculated the net direct costs to ratepayers under two scenarios: (i) technically feasible resources would be able to clear FCAs for half the years % of their life span (or alternatively, one can view this scenario as one where capacity prices are depressed below net CONE levels); and (ii) technically feasible resources do not clear any FCA and consequently do not earn any capacity revenues throughout their life-cycle, to defray NTA direct costs to Connecticut ratepayers. Figure 21 summarizes the two scenarios considered by LEI.

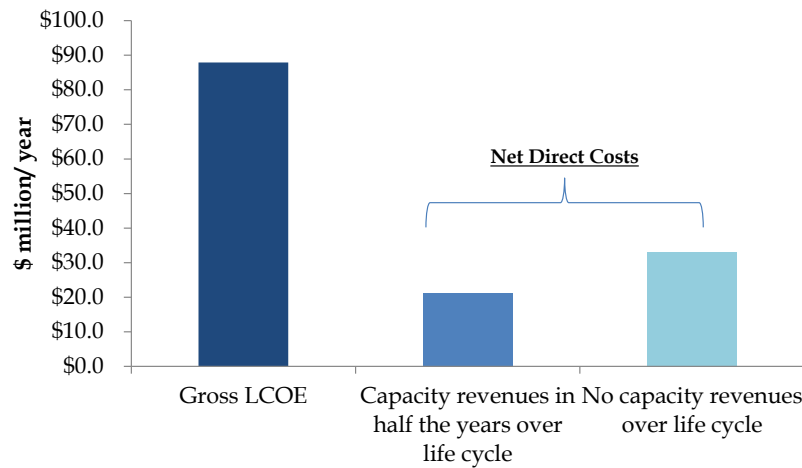
The total net direct cost (gross costs net of revenues offsets) of an NTA solution for the GH subarea payable by Connecticut ratepayers was determined to range between \$21 million and \$33 million a year. This cost range was based on the following combination of technically feasible NTA technologies: 23 MW of EE and 182 MW of CCGT.<sup>35</sup> The lowest net direct costs (\$21 million per year) to ratepayers materialize under Scenario 1, where we assume some capacity revenues over the lifetime of the NTA technology.

**Figure 21. Summary of LEI’s scenarios**

Scenario	Methodology	Key assumptions for net LCOE
<b>Scenario 1</b> (Capacity revenues in half the years over life cycle)	Net LCOE used to select the least cost technologies	We assumed that new resources such as CCGT and peakers would receive capacity payments over half the years of their life cycle
<b>Scenario 2</b> (No capacity revenues in years over life cycle)	Net LCOE used to select the least cost technologies	We assumed that none of the new resources would receive capacity payments over their respective life cycle

<sup>35</sup> Net LCOEs were derived from mid-range gross LCOE values.

**Figure 22. Estimated net direct costs of NTA solution for GHCCRP per annum based on varying assumptions regarding offsetting revenues and subsidies**



Greater Hartford	Scenario 1	Scenario 2	Newington to Southwest Hartford
Scenarios	Capacity revenues in half the years over life cycle	No capacity revenues over life cycle	Cost of the transmission solution shouldered by end-users
Total cost (\$ million/ year)	\$21.2	\$33.0	\$4.6

## 5.2 Qualitative discussion on feasibility of NTA solution in the GH subarea

There are several factors associated with each NTA technology that will have further bearing on its practical feasibility at the required interconnection point or node. The scope of this analysis does not presume to identify and evaluate all criteria for successful development of technically feasible, least cost NTA technologies at the NW Hartford bus. However, we have considered general development requirements associated with each NTA technology and a macro-level assessment of feasibility of the necessary NTAs in the GH subarea.

A community’s enthusiasm towards a project is usually a key determinant to a project success. Some of the community’s major concerns relate to the project’s impact on the environment (emission of pollutants), and the impact on life quality (potential for noise disturbance or irreversible changes in the landscape). Moreover, the costs associated with developing accompanying infrastructure are prone to increase the financial burden for the community. All of these concerns can weight on a project’s permitting process, as well as eventual completion. Some of the important practical considerations for all the technologies reviewed (including those not considered technically feasible) are summarized in Figure 23 below. The discussion of these considerations in the following paragraph is however focused on the technically feasible NTA technologies identified in LEI’s analysis.



**Figure 23. Qualitative review of NTA technologies**

NTA Resource	Land requirement	Enabling infrastructure	Pollution
Combined Cycle Gas Turbine (CCGT)	Sizeable footprint	Gas lateral/pipeline; access to water; interconnection costs	Noise; pollutants
Peaker Aero-derivative Unit	Small footprint	Gas lateral/pipeline; interconnection costs	Noise; pollutants
Peaker Frame Unit	Sizeable footprint	Gas lateral/pipeline; interconnection costs	Noise; pollutants
Dual-fuel Jet Engine	Small footprint	Gas lateral/pipeline; on-site fuel storage	Noise; pollutants
Solar Utility Scale (with storage)	Sizeable footprint	Interconnection costs	N/A
Solar DG (with storage)	Sizeable footprint	Interconnection costs	N/A
Slow Discharge Battery	Small footprint	Interconnection costs	N/A
Active DR - Emergency Generation	Small footprint	N/A	Noise; pollutants
Passive DR (Energy Efficiency)	N/A	N/A	N/A
Fuel Cells	Small footprint	Gas lateral/pipeline; interconnection costs	N/A

**Market limitations**

No gas-fired unit is currently operating or has been proposed in the ISO-NE’s interconnection queue for development at the NW Hartford substation. ISO-NE’s load growth projections coupled with LEI’s analysis of market developments suggest there is not likely to be sufficient “room” in the capacity market or a market need for additional gas-fired generation in the next few upcoming capacity markets auctions. Therefore, securing these resources without sustained capacity revenues will require out-of-market funding, exposing Connecticut ratepayers to greater cost.

**End-use customers mix**

In our analysis we conservatively assumed a load reduction rate not greater than 15% for all EE programs above and beyond existing and planned programs. This penetration rate depends a great deal on the mix of customer types in the region. A zone dominated by industrial facilities is likely to feature the best load reduction rates; whereas zones dominated by residential customers could achieve load reduction rates as low as 1 to 2%, in which case, demand resources would not be effective as NTA.

**Land requirements**

The development of NTA technologies such as CCGTs and peakers is contingent upon the availability of buildable space (measured in acres) at or near the proposed hypothetical injection point in order to

be a practically feasible solution. The least cost technically feasible NTA technologies for the GH subarea is a 182 MW CCGT plant to be built in at the NW Hartford substation. The area surrounding the NW Hartford substation is heavily developed and zoned for residential use.

### *Enabling infrastructure*

In addition to land, some NTA technologies also need other enabling infrastructure to be practically feasible at a given hypothetical injection point. For example, a CCGT would require access to water (for cooling). There needs to be sufficient transmission infrastructure to interconnect a generation unit and provide for the delivery of the energy into the bulk power system.<sup>36</sup> In addition, gas-fired resources will require access to fuel supply through pipeline infrastructure, while dual-fuel jet engines would also require a reliable supply of fuel oil (and permits to allow for oil storage on-site). Some CCGTs and peaking units can be co-located alongside existing generation facilities (if there are sufficient land resources for zoning and permitting) or on-site of retired generation or other former industrial facilities, which could reduce the costs of installation. The NW Hartford substation is not situated immediately next to a major gas pipeline.<sup>37</sup> The closest pipelines are located approximately 4 miles away from NW Hartford substation. As such, any gas-fired technology in this location will require building additional gas pipelines (laterals) to secure access to gas supply. This would result in more than \$12 million<sup>38</sup> in additional costs.

---

<sup>36</sup> No interconnection study was performed to determine whether there may be transmission upgrade costs associated with interconnection and/or deliverability.

<sup>37</sup> Furthermore, there are no gas-fired plants currently in operation near the considered substation.

<sup>38</sup> We assumed a \$2.9 million per mile pipeline cost based on the average of \$/mile of natural gas lateral projects built in New England over the past years (Source: EIA Natural gas pipelines projects).

## 6 Conclusion

The least cost alternative to the GHCCRP transmission solution requires a total of 182 MW of additional new CCGT capacity and 23 MW of incremental demand response (in addition to what is currently planned to be built pursuant to ISO-NE's FCM, and above and beyond what is known publicly based on the current ISO-NE interconnection queue) by 2022 in the GH subarea. Although energy efficiency was considered a feasible NTA technology, it remains a marginal contributor to the overall NTA solution, because of the inherent load at the NW Hartford substation and reasoned expectations regarding incremental penetration rates (beyond the level of EE already funded and planned for). Many NTA technologies are simply not technically feasible from a planning perspective. Certain NTA technologies such as solar DG do not possess the operating characteristics required to meet the reliability needs under N-1-1 contingencies and therefore could not provide the same reliable service as the preferred GHCCRP transmission solution. Other technologies, like utility scale solar, could not be developed in these particular geographical areas in sufficient quantities to meet the NTA requirement amount.

Although there are technically feasible NTA technologies that could meet the reliability needs in the GHCCRP subarea at the specific nodes identified by ISO-NE in their supply-side NTA study, these NTA solutions are estimated to be more costly than the preferred transmission solution. In fact, the least cost technically feasible NTA solution was estimated to cost Connecticut ratepayers more than five times the annual cost of the transmission solution payable by Connecticut end-use customers. Furthermore there are a host of practical impediments to developing and bringing to fruition an NTA solution. Such practical hurdles include the siting challenges related to land availability, and build out of the requisite fuel supply infrastructure (as well as negotiating fuel supply contracts). There are also questions related to the development process itself, as no private developer to date has shown interest in bring to market an NTA that would fit the technological requirements and geographical requirements of the necessary NTA solution.

## 7 Appendix A: LEI's Qualifications

London Economics International LLC ("LEI") is a global economic, financial, and strategic advisory professional services firm specializing in energy and infrastructure. The firm combines detailed understanding of specific network and commodity industries, such as electricity generation, transmission and distribution, with a suite of proprietary quantitative models to produce reliable and comprehensible results. The firm has its roots in advising on the initial round of privatization of electricity, gas, and water companies in the UK. Since then, LEI has advised private sector clients, market institutions, and governments on privatization, asset valuation, deregulation, tariff design, market power, and strategy in virtually all deregulating markets worldwide.

LEI's areas of expertise straddle both the deregulated/market environments (including for example, price forecasting and asset valuation; wholesale power market analysis; market design (ISO market rules); and competitive procurement) and application of regulatory economics (such as regulated tariff design; cost of service ratemaking and performance based ratemaking; productivity analysis; policy design for incentivizing renewable energy and new technologies; and transmission and distribution network analysis). Provided below is a sample of previous LEI work showcasing its considerable experience, notably in the analysis of transmission projects and Non-Transmission Alternatives.

### **Sample of projects relating to Non-transmission alternatives, cost-benefit analysis of transmission projects**

*Non-transmission Alternatives analysis for the Greater Boston area:* LEI was engaged by National Grid and Eversource Energy ("the Utilities") to determine the economic viability of non-transmission alternatives ("NTAs") to replace a combination of three transmission solutions designed to address reliability and performance issues in the Greater Boston area starting in 2018. More specifically, LEI's scope of work consisted of determining the least cost combination of technologies that could be integrated to the New England transmission system and provide the same reliability benefits as the proposed transmission lines. A combination of supply-side and demand-side resources were considered for the study, this included: distributed solar PV, utility-scale solar PV, energy efficiency and active demand response, conventional generation (gas CCGT and peakers), as well as energy storage devices. LEI started the analysis by screening prospective NTA technologies based on their technical characteristics, their relevance in the New England market and their technical applicability with regards to the operational criteria required by the grid to address contingency events (i.e volume of available capacity/energy, time of response, duration of response, flexibility etc...). Next, LEI conducted a comparative cost analysis to estimate the levelized cost per kW-month over the economic life of each of the technologies. Through his selection process, we retained technically feasible NTAs that are materially less expensive than other comparable options at the same locations (substations). Finally the most probable combinations of NTA technologies identified in the selection process were further evaluated based on their probability of materialization taking into account a spectrum of criteria including physical constraints such as land availability, siting issue, financing hurdle, etc...

*White paper on Non-transmission Alternatives (NTAs):* London Economics International LLC ("LEI") was engaged by WIRES to prepare a White Paper on Market Resource Alternatives ("MRAs") which provides external parties with a clear understanding of MRAs and a concise description of how MRAs

can work effectively alongside transmission investment in US power markets to support market development, reliability, and cost-effective supply. The structure of the White Paper specifically has the goal of “education” in mind. It started with the definition of MRAs, and then LEI presented case studies and lessons learned from several regional markets. The White Paper also recommended a conceptual analytical framework for proper and effective consideration of MRAs in transmission planning processes.

***Cost-benefit analysis of a proposed transmission line:*** For a utility in the northeastern US, LEI prepared a cost-benefit analysis of a proposed transmission line with the potential to change existing market arrangements. In the analysis, LEI developed a base case and multiple project cases based on different configurations of the transmission project. Using its proprietary modeling tool, POOLMod, LEI simulated energy and capacity prices in each configuration over a 15-year timeframe, and compared the price differences against various cost allocation scenarios for the transmission line's construction. LEI also tested the statistical significance of the project case results against the base case results, and conducted further analysis on the economic effects of additional renewable generation projects that construction of the transmission line would make possible.

***CHPE application for siting -*** Julia Frayer led LEI's team regarding the detailed cost-benefit analysis and macroeconomic impact analysis in support of the Champlain Hudson Power Express (“CHPE”) application for siting approval at the New York Department of Public Service (“DPS”). LEI's analysis on economic effects was the cornerstone of the settlement agreement reached between Transmission Developers, Inc. (“TDI”) and a number of New York agencies. Julia acted as independent expert on behalf of TDI and prepared updated study results on energy market impacts, capacity market impacts and also macroeconomic benefits stemming from the operation of the CHPE project. Julia's testimony was used in the DPS proceeding in the summer of 2012.

***Lake Erie HVDC transmission project - cost /benefit analysis:*** LEI was hired by a private developer to assess the economics of the proposed Lake Erie HVDC transmission project and determining the additional revenue streams or value adders of the Lake Erie HVDC transmission project (“LEP”) from the perspective of third-party shippers. The LEP is a 100-km long 1,000 MW bi-directional HVDC transmission line that will connect the Ontario energy market with the PJM market. LEI prepared a comprehensive report that includes a review of the Ontario and PJM markets, a 20-year (2017 to 2036) market outlook and prices for electricity, capacity and renewable energy credits in Ontario and the relevant zone/s in PJM; the total gross arbitrage value for the energy congestion rents, the capacity revenue potentials for PJM, and the renewable energy credits revenue potential in PJM.

***Forecast the impact of a 1,000 MW DC transmission line on New England market prices:*** LEI prepared a 10-year energy market price outlook for the New England wholesale power market and forecast the impact of a proposed project on New England market prices. The project proposes to build a 1,000 MW DC-based transmission line that between Quebec and Vermont and import energy into Vermont. LEI modeled the long-term price forecast for Vermont and the rest of ISO-NE over the 2019-2028 period, and examined the price differentials. Two cases were modeled: a Base Case (without the HVDC project), and the Project Case (with the HVDC project). Analysis was done under the assumption that the transmission capacity on the project will accommodate low-cost hydro imports from Quebec. LEI also determined the benefits of the proposed transmission project on employment, economic activity,

and tax revenues in New England. LEI utilized the dynamic input-output (“I/O”) economic model developed by Regional Economic Models, Inc. (“REMI”) to measure the economic benefits to Vermont and other New England states from the project on employment, economic activity, and tax revenues. LEI separated the economic impact caused by the construction of the project, and the impact caused by the reduction in energy prices due to the commercial operation of the project, taking into account issues such as usage of electricity in residential, commercial, and industrial sectors in the region, and also existing long-term energy contracts that would limit the impact of the project.

***Assess the potential economic benefits of a New England transmission project:*** LEI was commissioned by Northeast Utilities to determine the potential economic benefits of the proposed NEEWS transmission project. Using detailed hourly simulation modeling of future power market conditions, LEI studied the potential market implications of NEEWS for ten years from a notional expected date of commercial operation of 2014. LEI reached the following conclusions: New England ratepayers could expect cumulative energy cost savings attributable to NEEWS over ten years under normal operating conditions; NEEWS would create regional energy market impacts; each phase of NEEWS would create energy market benefits over the ten-year modeling horizon; NEEWS would reduce LFRM costs each year; NEEWS would provide an insurance hedge against stressed system events; and NEEWS would offer market access to renewable resources in Northern New England/Canada.

***Forecast the impact of a proposed transmission interconnection on Maine customers:*** LEI was engaged by a US power utility to perform a 15-year simulation analysis to estimate the market impacts resulting from a new transmission interconnection (covering the timeframe 2015-2029) and project the impact on Maine customers (including Northern Maine customers). LEI evaluated the market evolution with and without the interconnection and described the potential ramifications for purchasing electricity for Northern Maine customers. The analysis also estimated the potential impact on ratepayers from the re-allocation of the ISO-NE Pool Transmission Facility rate to incorporate the Northern Maine load and franchise area under a pro forma 10-year transitional agreement. LEI performed the modeling using our up-to-date ISO-NE simulation model (which covers the energy and capacity markets), extended to represent in detail the Maritimes control area.

***Analysis of congestion rents and forecasted impact on energy and capacity prices due to a proposed transmission line:*** In connection with a proposed transmission line from Hydro Quebec to New York City, LEI Managing Director Julia Frayer led a team that forecasted 10-year energy and capacity prices of the New York market using POOLMod. The team also conducted analysis on congestion rents to support the client’s negotiation with potential shippers. In support of the client’s filing at the NYPS&C, the LEI team conducted analyses on generation and production cost savings, emission reductions and sensitivities.

***MA Energy Facilities Siting Board (“EFSB”):*** in response to NU retaining LEI, New England wholesale electricity markets were simulated in order to determine whether the Greater Springfield Reliability Project (“GSRP”) would produce economic benefits to the New England region. In order to ensure that economic benefits were not subject to the forced outage and availability schedule of the simulated energy markets, LEI simulated the energy market with 30 different random forced outage and availability schedules. Using these simulations, a distribution of results was used to calculate confidence intervals and hypothesis tests run on the results, hence increasing the robustness of our

findings. The study results introduced as testimony to the EFSB, which is scheduled to be presented in October. (2009) [MA EFSB, EFSB 08-2/DPU 08-105/DPU 08-106].

*Assess the economic value of a proposed transmission project:* LEI was hired by a transmission developer to conduct an independent rigorous modeling exercise to determine the potential revenues for the proposed transmission project wheeling power from western MISO to East MISO (and eventually PJM). LEI evaluated both the revenue opportunities to the investors (e.g., private benefits of the line based on market price differences and the market value of the transmission) as well as social benefits to the MISO system (i.e., wholesale price reductions and capacity market price differences); and evaluated the incremental value of the business strategy of selling the energy (and capacity) out of East MISO to third parties who will serve customers ultimately in PJM. LEI's modeling exercise entailed evaluating intrinsic revenues (originating from power markets), extrinsic revenue (originating from price volatility), along with the green value of the Project (originating from the purchase of low cost renewable energy). LEI's overall analysis was comprehensive and included a series of sensitivity scenarios testing key value drivers.

## **Sample of projects in Connecticut**

### **Connecticut**

*Connecticut Siting Council ("CSC") - NU/GSRP:* LEI simulated the New England wholesale electricity markets in order to compare the economic benefits between Greater Springfield Reliability Project ("GSRP") and responses to the Connecticut Energy Advisory Boards' ("CEAB") RFP for a non-transmission alternative ("NTA") to GSRP. The NTA consisted of modeling a new CCGT plant to be placed in Southwestern Connecticut. In order to ensure that economic benefits were not subject to the forced outage and availability schedule of the simulated energy markets, LEI simulated the energy market with 30 different random forced outage and availability schedules. In effect these 30 different simulations added further robustness to our results because it captured the flexibility of the New England energy market under several different normal operating conditions. Furthermore the simulations created a distribution of results which was used to calculate confidence intervals and hypothesis tests, hence further increasing the robustness of our findings. The study results were used to produce written testimony to the CSC, oral testimony was provided in late August and early September 2009. (2008-2009) [CSC, Docket 370].

*NU-NSTAR merger:* in support of a client's opposition of a proposed NU-NSTAR merger, LEI analyzed the potential competitive market effects on a vertical scale and considered the extent of buyer market power for the purchase of standard service (full requirements) products. The testimony was submitted to the Public Utility Regulatory Authority (PURA). In a later submission, LEI also analyzed the settlements reached or proposed in a number of recent utility mergers. (2012) [PURA Docket No. 12-01-07].

*Impact analysis of transmission project:* LEI advised a major transmission company on financial implications of proposed new 400kV transmission line to New York City and Connecticut. LEI analyzed the impact of new transmission, assuming it delivered 100% carbon-free energy, on electricity prices and emissions levels in New York and New England.

**2006 “All Source” RFP:** LEI served as the economic advisor to the Connecticut Department of Public Utility Control (DPUC), helping them design and implement an “all source” RFP for new capacity in the state in order to mitigate the exposure to ratepayers from Federally Mandated Congestion Costs. As economic advisor and RFP Coordinator, LEI was responsible for managing all aspects of the RFP, including design of innovative financial contracts for capacity, administration of RFP process, and evaluation of bids submitted by project sponsors, and recommendation to the DPUC for selection of winning projects. The selection of projects is based on a proprietary set of models that LEI staff designed to estimate the cost-benefit to ratepayers from long term contracts with new capacity, based on reduction in wholesale market costs across three different ISO New England power markets. LEI also submitted significant written testimony during the 18 months of this engagement, and LEI staff also testified orally on numerous occasions. (2006-2007) [DPUC, Docket No. 05-07-14PH02; FERC, ER03-563-000].

**DPUC auction oversight:** the DPUC retained the services of LEI to assist it in monitoring the power procurement processes for Connecticut Light & Power’s (CL&P) Transitional Standard Offer auction in November 2004 for services in 2005 and 2006, and in September 2005 to monitor the November 2005 auction for services in 2006. LEI ‘s mandate included providing advisory services to the DPUC, including guidance on communications protocols, design of sales contract agreement (between CL&P and winning bidders), and also valuation of final bids vis-à-vis the forward market alternatives available to the utility. LEI filed affidavits after the completion of each auction process which the Commissioners used to approve the process and the contracts between CL&P and the winning bidders. (2004 and 2005) [DPUC, Docket No. 03-07-18PH02].

### **Sample of projects in New England**

**Projection of retail rates for commercial customers in New England:** LEI performed a market study reviewing historical electric rates (and projecting forward electric rates) for large commercial customers in the New England market. The electric rates analysis was composed of a number of components, such as the commodity costs of electricity, compliance costs for certain state programs (like RPS), delivery charge for delivering electricity, and ancillary services and administrative supply charges. LEI created projections for each of these components and considered state retail sales requirements for renewables and other factors.

**New England energy price outlook and economic impacts:** LEI prepared a 10-year energy market price outlook for the New England wholesale power market and forecast the impact of a proposed transmission project on New England market prices. LEI also determined the benefits of the proposed transmission project on employment, economic activity, and tax revenues in New England. LEI utilized the dynamic input-output (“I/O”) economic model developed by Regional Economic Models, Inc. (“REMI”) to measure the economic benefits to various New England states from the project on employment, economic activity, and tax revenues. LEI took into account issues such as usage of electricity in residential, commercial, and industrial sectors in the region, and also existing long-term energy contracts that would limit the impact of the project.

**Review of NESCOE study:** LEI conducted a comprehensive review of the NESCOE Gas Electric Phase Three study in order to ensure that the appropriate economic models and techniques were being used to accurately model the hydro and gas solutions. LEI also aided the client in identifying any



assumptions and modeling approaches which may be suboptimal, and communicated how these issues can be addressed and improved in future studies.

## **Maine**

***Advisory to Maine Public Utilities Commission on RPS:*** LEI presented a written report on the state of renewable portfolio standard (RPS) requirements in Maine and regionally across New England. LEI also testified at the Maine legislature. The report was commissioned by the Maine Public Utility Commission to fulfill a statutory requirement to provide research on the issue of RPS and its impact on generators and consumers.

***Advisory to Maine Public Utilities Commission on transmission cost allocation:*** LEI advised Maine Public Utilities Commission on methodologies for transmission cost allocation by comparing and contrasting alternative planning approaches and pricing models employed within the US and one international jurisdiction, the United Kingdom. The final report will provide a 'strawman' recommendation for an effective cost allocation methodology. (2010) [**Docket No. RM10-23-000**].

***Advisory to the Maine Public Utilities Commission on RFP:*** LEI assisted the Commission on the RFP related to the procurement of electricity in response to statutory mandates and state policy preferences. LEI provided economic analyses of bid proposals by estimating the benefits and costs to the ratepayers, and is currently supporting Commission staff in negotiations with short-listed bidders. (2009).

***Development of an Electric Resource Adequacy Plan in Maine:*** in Docket No. 2008-104, LEI assisted the Maine Public Utilities Commission in developing an electric resource adequacy plan to aid MPUC in the development of a strategy for the pursuit of the long-term contracts. LEI submitted a report that builds up a set of recommendations for a long-term investment strategy based on an analysis of the current supply-demand situation, a review of the existing wholesale market rules for energy and the Forward Capacity Market, an examination of historical price trends, and review of the investment needs assessments prepared by the utilities and ISO-NE, as well as relevant sub-regional planning studies. (2008) [**Maine PUC, Docket No. 2008-104**].

***Maine renewable portfolio requirement:*** LEI was engaged by the Maine Public Utilities Commission to conduct an in-depth analysis of the renewable portfolio standards ("RPS") required by a legislative Act. This analysis supported a Commission study and report to the Legislature. Julia led the team in preparation of the report, which was submitted to the Commission and later testified at the state legislature on the key findings of that report.

## **New Hampshire**

***Testimony describing wholesale market dynamics and benefits of Northern Pass in averting supply risks associated with generation "at risk" for retirement:*** On behalf of Public Service of New Hampshire, LEI testified in front of the new Hampshire Senate Committee on issue of eminent domain generally and more specifically, on the power market context and near term outlook for the New England power market and reasons for the development of a new proposed transmission project known as Northern Pass.

## Vermont

***Testimony on proposed merger between Central Vermont Public Service and Green Mountain Power:*** for a small independent power producer, LEI prepared a testimony on the potential harms of the proposed merger to the client and proposed certain conditions for the Vermont Public Service Board to consider. (2012) [PSB Docket No. 7770].

***ISO-NE tariff design:*** LEI submitted testimony on behalf of ISO New England to the FERC to help defend ISO New England's self-funding tariff. LEI first defined the basic underlying economic principles for specifying the tariff, and then undertook to show how the tariff should be applied to various system users. The engagement involved an intensive financial modeling effort, and frequent interaction with stakeholders. (2000) [ER01-316-000].

### **Commercial litigation in New England**

***PPA contract dispute:*** LEI provided expert witness service for a private equity investor in matter related to a contractual dispute regarding a long term power purchase agreement between a municipal utility located in New England and a landfill gas generator. LEI analyzed the key contractual terms of the PPA and providing an expert's review of how those terms compared to the industry norm when the contract was signed and became effective. LEI will also be providing an independent estimate of potential contractual damages. (2010-2011) [Commonwealth of Massachusetts Superior Court Department, Civil Action No. PLCV2006-00651-B].

***Updated market power analysis:*** prepared for a US utility's triennial review of market-based rate authorizations for certain subsidiaries in the northeast region. LEI analyzed the company's market power in PJM and ISO-NE. (2010) [ER98-4159, et al.].

***Section 203 and 205 analysis in support of NRG's acquisition of certain Dynegy assets in CAISO and ISO-NE:*** LEI was engaged to provide testimony in support of a proposed acquisition. LEI performed a Delivered Price Test (DPT) for CAISO and ISO-NE energy markets as well as a standalone Herfindahl-Hirschman Index (HHI) analysis for the capacity markets. In addition, LEI discussed the impact of the acquisition of the ancillary services markets. (2010) [EC10-88-000]

***Confidential FERC investigation in 2009-2010 of market manipulation in New England:*** Julia and her team assisted the client with certain matters pertaining FERC investigation. Specifically, the scope of this retention included economic and market analysis in support of a market participant in ISO New England's day ahead load response program ("DALRP"). Julia also provided affidavits and deposed in connection with FERC investigation of behind-the-fence industrial generator and participation in a wholesale power market in New England. Julia helped the client to respond to assertions of market manipulation and estimate market benefit provided through its participation in demand response program.

## 8 Appendix B: Technical and operational characteristics of various NTA technologies

### *Operating size and capacity factor*

Each injection point has a specified amount of MW requirement that must be met by an eligible NTA. Each NTA under consideration has been selected based on whether previous examples of its successful operations have been documented in Connecticut. In addition, the minimum and maximum operating size for the short-listed NTAs were determined by evaluating typical operating size of similar technologies in New England, Connecticut and where available in the GH subarea. In addition, each NTA has a representative capacity factor which is based on actual data relevant to installations of that technology in Connecticut. Together these parameters help determine if a particular NTA can meet the injection requirements at a specific injection point.

### *NTA Performance Parameters*

Response time is an important criterion to determine eligible technologies under N-1-1 contingency events. Under an N-1-1 contingency event, eligible NTAs must be able to inject power in less than 30 minutes. In addition to response time and ramp rate, the duration for which a given NTA can inject power after it has been called into service during a contingency event is also a vital criterion. Based on its understanding of ISO-NE rules,<sup>39</sup> LEI modeled uses a conservative estimate of 12 hours as the minimum duration for which an NTA must remain online for N-1-1 contingency event in order to qualify as a technically feasible NTA.

Specific values for each of these criteria defined above are summarized in Figure 24. The second and third columns indicate the minimum and maximum MW size for each NTA. The column labeled ramp rates specifies how fast the corresponding NTA can ramp up to start producing at its maximum capacity. For example, a 14.3% of total size per minute ramp rate for dual-fuel jet engines implies that these units can start producing at their maximum capacity in about 7 minutes. Finally, the last column, duration refers to the length of time these NTAs can produce power without interruption. For fossil fuel powered NTAs, the underlying assumption is that the availability of fuel is not a constraint. For NTAs with storage technologies such as solar PV, we assume that the storage capacity is long enough to support the NTA for during nighttime hours.

---

<sup>39</sup> Subsection III of Part III – Procedure of ISO New England Operating Procedure No. 8 Operating Reserve and Regulation. May 2, 2014. Available at [http://www.iso-ne.com/rules\\_proceeds/operating/isone/op8/op8\\_rto\\_final.pdf](http://www.iso-ne.com/rules_proceeds/operating/isone/op8/op8_rto_final.pdf).

**Figure 24. Technical characteristics of NTA technologies**

MRA Resource	Installed Capacity range	Operations profile	Performance Rate	Duration (Hr.)
Combined Cycle Gas Turbine (CCGT)	100 to 700 MW range in CT	Baseload	95% availability factor	24
Peaker Aeroderivative Unit	1 to 125 MW range	Peaking load	85% availability factor	24
Peaker Frame Unit	20 to 250 MW range	Peaking load	83% availability factor	24
Dual-fuel Jet Engine	<1 to 50 MW	Peaking load	85% availability factor	24
Solar Utility Scale (with storage)	5 to 250 MW	Potential baseload depending on storage capacity	15% efficiency ratio	24
Solar Utility Scale	5 to 250 MW	Daytime peaking load during sunny days	15% efficiency ratio	12
Solar DG (with storage)	<1 to 5 MW	Potential peaking load depending on storage	15% efficiency ratio	12
Solar DG	<1 to 5 MW	Daytime peaking load during sunny days	15% efficiency ratio	8
Fast Discharge Battery	<1 to 10 MW	Can provide instantaneous power for short periods	Variable, depending on efficiency, charging time and storage capacity	2
Slow Discharge Battery	10 to 20 MW	Can provide steady supply of power for short periods	Variable, depending on efficiency, charging time and storage capacity	12
Active DR - Emergency Generation	Variable (based on type of equipment and load)	Peaking load	Assume 15% of peak load becomes available to respond	24
Passive DR (Energy Efficiency)	Variable (based on type of equipment and load)	Intermittent	Assume 15% of peak load becomes available to respond	24
Fuel Cells	2.8 MW to 63 MW	Baseload	95% availability factor	24

Note 1: Wind was not considered as a technically feasible NTA due to the lack of potential for sizeable wind capacity development in the Connecticut.

Note 2: Installed capacity range for utility scale fast and slow discharge batteries depends on the number of individual batteries connected together at a given site. The range indicated in the figure above is indicative, and LEI used variable sizes depending on requirements in order to ascertain the technical feasibility of using batteries as NTA technologies.

Note 3: Performance rates for CCGTs, Peaker Aeroderivative units, Peaker frame units and dual-fuel jet engines calculated based on the ISO New England EFORd Class Averages, sourced from: [http://www.iso-ne.com/static-assets/documents/genrtion\\_resrcs/gads/class\\_ave\\_2010.pdf](http://www.iso-ne.com/static-assets/documents/genrtion_resrcs/gads/class_ave_2010.pdf)

Note 4: Active DR emergency profile is sourced from ISO New England Operating Procedure No. 14 - Technical Requirements for Generators, Demand Resources, Asset Related Demands and Alternative Technology Regulation Resources." ISO-NE, November 7, 2014 [http://www.iso-ne.com/rules\\_proceeds/operating/isone/op14/op14\\_rto\\_final.pdf](http://www.iso-ne.com/rules_proceeds/operating/isone/op14/op14_rto_final.pdf).

Note 5: Size of fuel cells based on DFC3000 units from FuelCell Energy. The maximum size was based on the anticipated 63 MW fuel cells plant to be built in Connecticut (the largest yet in the world). Fuel Cells technology is baseload and can run 24/7 pending fuel availability. Given the limited information on availability factor, we assumed the same availability factor as a CCGT.

Figure 25. Technology parameter determination assumptions

	Parameter	Methodology	Source
CCGT	Minimum/Maximum Size	Based on typical observed installed capacities, capped at the maximum value of CCGT unit in Connecticut	Review of information provided by manufacturers (SIEMENS and GE) and actual data of operation in ISO-NE (based on new construction over the past 20 years)
	Ramp Rate	CCGTs are assumed already committed	Not applicable
	Performance Rate	CCGTs are assumed to have 95% availability factor	Based on ISO-NE EFORd Class Averages
	Duration	CCGTs are not energy limited resources	Not applicable
Peaker Frame Unit	Minimum/Maximum Size	Based on typical observed installed capacities	Review of information provided by manufacturers (SIEMENS and GE) and actual data of operation in ISO-NE
	Ramp Rate	Industry-standard ramp rates	Review of information provided by manufacturers and plants' operational data in ISO-NE
	Performance Rate	Peaker Aeroderivative units are assumed to have 85% availability factor	Based on ISO-NE EFORd Class Averages
	Duration	Frame units are not energy limited resources	Not applicable
Peaker Aeroderivative Unit	Minimum/Maximum Size	Based on typical observed installed capacities, with the assumption that several units can be installed together (capped at the value for which a peaker aeroderivative unit becomes a feasible technology)	Review of information provided by manufacturers (SIEMENS and GE) and actual data of operation in ISO-NE (based on new construction over the past 20 years)
	Ramp Rate	Industry-standard ramp rates	Review of information provided by manufacturers and plants' operational data in ISO-NE
	Performance Rate	Peaker Frame units are assumed to have 83% availability factor	Based on ISO-NE EFORd Class Averages
	Duration	Aeroderivative units are not energy limited resources	Not applicable
Dual-Fuel Jet Engines	Minimum/Maximum Size	Based on typical observed installed capacities	Review of information provided by manufacturers (Wärtsilä) and actual data of operation in ISO-NE
	Ramp Rate	Industry-standard ramp rates	Review of information provided by manufacturers and plants' operational

	Parameter	Methodology	Source
			data in ISO-NE
	Performance factor	Dual fuel jet engines are assumed to have 85% availability factor	Based on ISO-NE EFORD Class Averages
	Duration	Jet Engines are not energy limited resources	Not applicable
Solar Utility-Scale	Minimum/Maximum Size	Based on typical observed installed capacities and ISO's definition	Review of utilities' new installations in CT and external sources such as "Utility-Scale Concentrating Solar Power and Photovoltaic Projects: A Technology and Market Overview." (National Renewable Energy Laboratory)
	Ramp Rate	Not applicable	Not applicable
	Performance factor	Utility scale solar units have a conversion efficiency comparable to standard solar PV unit in CT	System Advisory Model ("SAM") from National Renewable Energy Laboratory ("NREL") for Connecticut
	Duration	Limited to daytime	Not applicable
Solar Utility-Scale with storage	Minimum/Maximum Size	Based on typical observed installed capacities and ISO's definition	Similar assumptions as for "utility scale solar"
	Ramp Rate	Not applicable	Not applicable
	Performance factor	Utility scale solar units have a conversion efficiency comparable to standard solar PV unit in CT	System Advisory Model ("SAM") from National Renewable Energy Laboratory ("NREL") for Connecticut
	Duration	Storage capacity assumed sufficient to deliver energy equivalent to solar capacity factor at night [needed for a minimum of 12 hours to last through a contingency]	Not applicable
Solar DG	Minimum/Maximum Size	Based on typical observed installed capacities and ISO's definition	Connecticut and external sources such as "Utility-Scale Concentrating Solar Power and Photovoltaic Projects: A Technology and Market Overview." National Renewable Energy Laboratory. April 2012. <a href="http://www.nrel.gov/docs/fy12osti/51137.pdf">http://www.nrel.gov/docs/fy12osti/51137.pdf</a>
	Ramp Rate	Not applicable	Not applicable
	Performance factor	Utility scale solar units have a conversion efficiency comparable to standard solar PV unit in New England	System Advisory Model ("SAM") from National Renewable Energy Laboratory ("NREL") for Connecticut
	Duration	Limited to daytime	Not applicable

	Parameter	Methodology	Source
Fast-Discharge Batteries	Minimum/Maximum Size	Based on typical observed installed capacities, with the assumption that batteries can be installed in banks (capped in the model to total installed capacity in the US in 2015)	Review of information provided by manufacturers (Flywheel (Beacon Power, NaS Batteries (NJK)) & Energy Storage Association
	Ramp Rate	Not applicable	Not applicable
	Performance factor	Based on typical charging-discharging cycle efficiency	Review of information provided by manufacturers, and Electric Power Research Institute
	Duration	Typical value for available technologies	Review of information provided by manufacturers, and Electric Power Research Institute (“EPRI”),
Slow-Discharge Batteries	Minimum/Maximum Size	Based on typical observed installed capacities, with the assumption that batteries can be installed in banks (capped in the model to total installed capacity in the US in 2015)	Review of information provided by manufacturers (Flywheel (Beacon Power, sodium sulfur (NaS) Batteries (NJK)) & Energy Storage Association
	Ramp Rate	Not applicable	Not applicable
	Performance factor	Based on typical charging-discharging cycle efficiency	Review of information provided by manufacturers, and Electric Power Research Institute
	Duration	Typical value for available technologies	Electric Power Research Institute (“EPRI”)
Fuel Cells	Minimum/Maximum Size	Based on DFC3000 unit size	FuelCell Energy (manufacturer)
	Ramp Rate	(baseload/running at all time)	Not applicable
	Performance factor	Assumed same as CCGT 95%	Not applicable
	Duration	Available at all times pending fuel availability	FuelCell Energy and EIA

## 9 Appendix C: Derivation of cost estimates for various NTA technologies

In this appendix we disclose gross and Net LCOE of all considered technologies (feasible and infeasible) and provide detailed information on all sources used. A summary of the sources utilized is documented in the following Figures.

**Figure 26. Gross and net LCOE per technology (\$/kW-year)**

	CCGT	Frame Peaker	Aero Peaker	Slow discharge batteries	Fast response energy storage	Utility-scale solar (with storage)	Solar DG (with storage)	Passive DR (EE)	Fuel Cell	Active DR (RTEG)	Active DR (RTDR)
Gross LCOE	418.0	231.2	323.4	181.4	154.3	415.9	523.3	513.0	382.7	371.0	480.0
Energy*	283.3	129.9	117.8	-	-	66.4	-	-	54.0	-	-
FCM	57.3	57.3	57.3	-	-	20.1	-	61.9	-	28.7	28.7
LFM	-	-	-	12.5	-	-	-	-	-	-	-
Regulation	-	-	-	33.0	33.0	-	-	-	-	-	-
Avoided retailed cost	-	-	-	-	-	-	21.5	143.3	-	0.2	0.2
Net LCOE	77.4	44.0	148.3	135.9	121.2	7.6	179.9	307.8	328.7	342.1	451.1

\* Includes fuel and variable operating and maintenance costs

**Figure 27. Overnight cost per technology (\$/kW-year)**

	CCGT	Aero Peaker	Slow discharge batteries	Fast response energy storage	Utility-scale solar (with storage)	Solar DG (with storage)	Passive DR (EE)	Fuel Cell	Active DR (RTEG)	Active DR (RTDR)
Overnight capital cost (\$/kW-year)	\$1,146	\$1,486	\$1,330	\$1,277	\$3,697	\$5,830	N/A	\$7,475	N/A	N/A

Sources: Summarized in Figure 28 below.



**Figure 28. Assumptions and sources on gross LCOE**

Technologies	Methodology	Sources
<b>Peaker (aeroderivative and frame units) and CCGT technologies</b>	Gross LCOE based on ISO-NE's estimates adjusted for O&M and fuel cost. Gross LCOE for CCGT was adjusted to reflect smaller than standard size of the required plant. The generic CCGT considered by ISO-NE in its analysis has a size ranging between 500 and 700 MW. CCGT qualified as smaller than usual will likely be more expensive due to the lack of scale. This is reflected by a 12% increase in gross LCOE based on the overnight cost difference between 400 MW and a 600 MW power plant	ISO New England's demand curve assumptions for the Forward Capacity Auction # 9  EIA <a href="http://www.iso-ne.com/regulatory/ferc/filings/2014/apr/er14-1639-000_demand_curve_c">http://www.iso-ne.com/regulatory/ferc/filings/2014/apr/er14-1639-000_demand_curve_c</a>
<b>Energy storage (slow discharge and fast operating response)</b>	Gross LCOE was estimated through LEI's proprietary LCOE model. Key inputs such as overnight capital cost and VOM and FOM were sourced from NREL and PNNL. Results were then cross-checked against industry's estimates (IEA)	National Assessment of Energy Storage for Grid Balancing and Arbitrage", Pacific Northwest National Laboratory <a href="http://energyenvironment.pnnl.gov/pdf/National_Assessment_Storage_PHASE_II_vol_2">http://energyenvironment.pnnl.gov/pdf/National_Assessment_Storage_PHASE_II_vol_2</a>  International Energy Agency <a href="http://www.iea.org/publications/freepublications/publication/TechnologyRoadmapEnergyStorage.pdf">http://www.iea.org/publications/freepublications/publication/TechnologyRoadmapEnergyStorage.pdf</a> and LEI
<b>Utility -scale solar</b>	Gross LCOE was estimated through LEI's proprietary LCOE model. Key inputs to such as overnight capital costs and O&M sourced from NREL, EIA and DOE. Results were then cross-checked against industry's estimates.	National Renewable Energy Laboratory ("NREL") <a href="http://www.nrel.gov/analysis/tech_lcoe_re_cost_est.html">http://www.nrel.gov/analysis/tech_lcoe_re_cost_est.html</a>  Sun Shot Initiative (US Department of Energy), SEIA - <a href="http://www.seia.org/research-resources/solar-market-insight-report-2014-q1">http://www.seia.org/research-resources/solar-market-insight-report-2014-q1</a> ; and LEI
<b>Solar DG</b>	Gross LCOE was estimated through LEI's proprietary LCOE model and industry's estimates -(from NREL and DOE)	NREL (PV system pricing trends, 2014 - <a href="http://www.nrel.gov/docs/fy14osti/62558.pdf">http://www.nrel.gov/docs/fy14osti/62558.pdf</a> and LEI
<b>Dual fuel jet engine</b>	Key inputs to LEI's proprietary LCOE model such as overnight capital costs and O&M sourced from NYISO's estimates (technologies reviewed to established cost of new entry) and Wärtsilä	Wärtsilä, NYISO Demand curves filing <a href="http://www.nyiso.com/public/webdocs/markets_operations/committees/bic_capwg/meeting_materials/2013-08-22/2013%20NYISO%20Demand%20Curve%20Recommendation_draft_8-18-13.pdf">http://www.nyiso.com/public/webdocs/markets_operations/committees/bic_capwg/meeting_materials/2013-08-22/2013%20NYISO%20Demand%20Curve%20Recommendation_draft_8-18-13.pdf</a>
<b>Active DR (RTEG and RTDR)</b>	Key inputs to LEI's proprietary LCOE model such as overnight capital costs and O&M sourced from EPRI (RTEG);  Cost estimates for RTDR determined based on VOLL for a 12 hour requirement (N-1 and N-1-1 criteria)	EPRI- <a href="http://www.publicpower.org/files/deed/finalreportcostsofutilitydistributedgenerators.pdf">http://www.publicpower.org/files/deed/finalreportcostsofutilitydistributedgenerators.pdf</a> LEI and ISO-NE <a href="http://www.iso-ne.com/markets-operations/system-forecast-status/current-system-status/op4-archiv">http://www.iso-ne.com/markets-operations/system-forecast-status/current-system-status/op4-archiv</a>
<b>Fuel Cell</b>	Gross LCOE was estimated through LEI's proprietary LCOE model. Key inputs to LEI's proprietary LCOE model such as overnight capital costs and O&M sourced from FuelCell Energy	FuelCell Energy <a href="http://www.fuelcellenergy.com/assets/PID000218_FCE_BFCP_Open-House-Spotlight_r2_HIRES.pdf">http://www.fuelcellenergy.com/assets/PID000218_FCE_BFCP_Open-House-Spotlight_r2_HIRES.pdf</a>

For market revenue information, we relied primarily on documents and market information made publicly available by ISO-NE and as relevant for the state of Connecticut. For technical and cost information, sources relied upon include mainly independent engineering reports and market research performed by US government sponsored laboratories and research institutes as well as US Government agencies and manufacturing companies when relevant.

**Figure 29. Assumptions and sources of revenue streams**

<b>Technologies</b>	<b>Methodology</b>	<b>Source</b>
<b>Energy</b>	Determined average annual revenue on the energy markets for a generic technology based on LEI's outlook of market prices	Based on LEI's ISO-NE wholesale price forecasts
<b>FCM</b>	Revenues calculated based on FCA#9 results	Based on FCA#9 - <a href="http://www.iso-ne.com/markets-operations/markets/forward-capacity-market">http://www.iso-ne.com/markets-operations/markets/forward-capacity-market</a>
<b>LFRM</b>	Revenues calculated using most recent clearing price (winter and summer) adjusted for participation time	Based on 2014 summer and winter results (net of capacity payments)  <a href="http://www.iso-ne.com/markets/mkt_anlys_rpts/annl_mkt_rpts/2013/2013_amr_final_050614.pdf">http://www.iso-ne.com/markets/mkt_anlys_rpts/annl_mkt_rpts/2013/2013_amr_final_050614.pdf</a>
<b>Regulation</b>	Revenue calculated based on regulation price adjusted for estimated market share	Based on 2013 clearing prices (ISO NE)
<b>Avoided retailed cost</b>	Avoided cost calculated based on average annual retail costs	EIA's statistics on CT's retail costs ; <a href="http://www.eia.gov/electricity/monthly/epm_table_grapher.cfm?t=epmt_5_6_a">http://www.eia.gov/electricity/monthly/epm_table_grapher.cfm?t=epmt_5_6_a</a>

## 10 Appendix D: Bibliography and Works Cited

1. *ABB products and references on Gas-fired power plants*, ABB Ltd. 2014, Sourced from: <http://new.abb.com/power-generation/gas-fired-power-plants>
2. *Average Tested Heat Rates by Prime Mover and Energy Source (2007-2012)*, EIA. 2014, Sourced from: [http://www.eia.gov/electricity/annual/html/epa\\_08\\_02.html](http://www.eia.gov/electricity/annual/html/epa_08_02.html)
3. *Cold Weather Operations*, ISO-New England, April 1, 2014. Sourced from: [http://www.iso-ne.com/pubs/pubcomm/pres\\_spchs/2014/winter\\_operations\\_technical\\_conference\\_april\\_2014.pdf](http://www.iso-ne.com/pubs/pubcomm/pres_spchs/2014/winter_operations_technical_conference_april_2014.pdf)
4. *Combustion Engine vs. Gas Turbine: Ramp Rate*. Wärtsilä Learning Center. Sourced from: <http://www.wartsila.com/fi/voimalat/learning-center/combustion-engine-vs-gas-turbine-ramp-rate>
5. *Costs of Utility Distributed Generators, 1 - 10 MW*. EPRI. Sourced from: <http://www.publicpower.org/files/deed/finalreportcostsofutilitydistributedgenerators.pdf>
6. *Distributed Generation Renewable Energy Estimate of Costs*, NREL. 2013. Sourced from: [http://www.nrel.gov/analysis/tech\\_lcoe\\_re\\_cost\\_est.html](http://www.nrel.gov/analysis/tech_lcoe_re_cost_est.html).
7. *Electric power sales, revenue, and energy efficiency Form EIA-861 detailed data files, IA*. October 29, 2013. Sourced from: <http://www.eia.gov/electricity/data/eia861/>
8. *Energy-Efficiency Forecast Report for 2018 to 2023*, ISO-NE. June 3, 2014. Sourced from: [http://www.iso-ne.com/static-assets/documents/2014/08/eef\\_report\\_2018\\_2023\\_final.pdf](http://www.iso-ne.com/static-assets/documents/2014/08/eef_report_2018_2023_final.pdf)
9. *Energy Storage Technologies*, ESA. 2014. Sourced from: <http://energystorage.org/energy-storage/energy-storage-technologies>
10. *FuelCell Energy Products and Services*. From. <http://www.fuelcellenergy.com/products-services/products/>
11. *GE Combined-Cycle Product Line and Performance*, GE Power Systems. Sourced from: <http://physics.oregonstate.edu/~hetheriw/energy/topics/doc/elec/natgas/cc/combined%20cycle%20product%20line%20and%20performance%20GER3574g.pdf>.
12. *Global Energy Storage Database*, DOE. May 20, 2014. Sourced from: <http://www.energystorageexchange.org/>
13. *How do wind turbines work*, US DOE - Office of Energy Efficiency & Renewable Energy. 2014. Sourced from <http://energy.gov/eere/wind/how-do-wind-turbines-work>
14. *Interconnection request for New England Control Area*, ISO-NE. January 1, 2015. Sourced from: [http://www.iso-ne.com/static-assets/documents/2014/09/interconnection\\_request\\_queue.pdf](http://www.iso-ne.com/static-assets/documents/2014/09/interconnection_request_queue.pdf)
15. *Introduction to New England's Energy & Ancillary Market*, ISO-NE. August 2014. <http://isonewengland.net/static-assets/documents/2014/08/iso101-t3-mktcore.pdf>
16. *ISO - New England - About the ISO's DG Forecast*, ISO-NE. 2014. 2014. Sourced from: [www.iso-ne.com/committees/planning/distributed-generation](http://www.iso-ne.com/committees/planning/distributed-generation)

17. *ISO - New England EFORd Class Averages*. ISO - New England. Sourced from: [http://www.iso-ne.com/static-assets/documents/genrtion\\_resrcs/gads/class\\_ave\\_2010.pdf](http://www.iso-ne.com/static-assets/documents/genrtion_resrcs/gads/class_ave_2010.pdf)
18. *ISO - New England - Demand Curve Changes*. ISO- New England. Sourced from: [http://iso-ne.com/regulatory/ferc/filings/2014/apr/er14-1639-000\\_demand\\_curve\\_chges\\_4-1-2014.pdf](http://iso-ne.com/regulatory/ferc/filings/2014/apr/er14-1639-000_demand_curve_chges_4-1-2014.pdf)
19. *ISO - New England - Demand Resource Registration and Performance Auditing*. Sourced from: <http://www.iso-ne.com/markets-operations/markets/demand-resources>
20. *ISO-New England - Interim Forecast of Solar Photovoltaic (PV) Resources*. ISO-New England. 2014. Sourced from: [http://www.iso-ne.com/static-assets/documents/2014/08/2014\\_final\\_solar\\_forecast.pdf](http://www.iso-ne.com/static-assets/documents/2014/08/2014_final_solar_forecast.pdf)
21. *ISO - New England - Offer Review Trigger Prices 2013 Study*, The Brattle Group, September 10, 2013
22. *ISO - New England Operating Procedure No. 14 - Technical Requirements for Generators, Demand Resources, Asset Related Demands and Alternative Technology Regulation Resources*. ISO-NE, Nov 7, 2014. [http://www.iso-ne.com/rules\\_proceeds/operating/isone/op14/op14\\_rto\\_final.pdf](http://www.iso-ne.com/rules_proceeds/operating/isone/op14/op14_rto_final.pdf)
23. *ISO - New England - Real time data*, ISO - New England. December 2014. Sourced from: [www.iso-ne.com](http://www.iso-ne.com)
24. *ISO- New England - Regional Electricity Outlook*, 2014. Sourced from: [http://www.iso-ne.com/aboutiso/fin/annl\\_reports/2000/2014\\_reo.pdf](http://www.iso-ne.com/aboutiso/fin/annl_reports/2000/2014_reo.pdf)
25. *ISO New England - Smart Grid report*. ISO - New England. Sourced from: [http://www.iso-ne.com/pubs/whtpprs/smart\\_grid\\_report\\_021709\\_final.pdf](http://www.iso-ne.com/pubs/whtpprs/smart_grid_report_021709_final.pdf)
26. *Karbone Broker*, February 17, 2015. [www.karbone.com](http://www.karbone.com)
27. *Land-Use Requirements for Solar Power Plants in the United States*. Sean Ong, Clinton Campbell, Paul Denholm, Robert Margolis, and Garvin Heath. National Renewable Energy Laboratory (NREL). Available at <http://www.nrel.gov/docs/fy13osti/56290.pdf>
28. *Market Resource Alternatives - an examination of new technologies in the Electric Transmission Planning Progress*. sourced from : WIRES Group  
[http://www.wiresgroup.com/docs/reports/WIRES%20Final%20NTA%20Report\\_September%202014.pdf](http://www.wiresgroup.com/docs/reports/WIRES%20Final%20NTA%20Report_September%202014.pdf)
29. *Milipore Case Study*, EnerNOC. Sourced from: <http://www.enernoc.com/our-resources/case-studies/global-life-sciences-innovator-boosts-ongoing-efficiency-with-enernoc-energy-intelligence-software>
30. *Mt. St. Mary's Solar Farm 2 (Franklin, MA)*, Kearsarge Energy. 2014. Sourced from: < <http://www.kearsargeenergy.com/mt-st-marys-solar-farm-2/>.
31. *National Assessment of Energy Storage for Grid Balancing and Arbitrage*. Pacific Northwest National Laboratory. Sourced from: [http://energyenvironment.pnnl.gov/pdf/National\\_Assessment\\_Storage\\_PHASE\\_II\\_vol\\_1\\_final.pdf](http://energyenvironment.pnnl.gov/pdf/National_Assessment_Storage_PHASE_II_vol_1_final.pdf)

32. *Operating Procedure No. 8 Operating Reserve and Regulation*. Subsection III of Part III. Procedure of ISO New England. May 2, 2014. Available at < [http://www.iso-ne.com/rules\\_proceeds/operating/isone/op8/op8\\_rto\\_final.pdf](http://www.iso-ne.com/rules_proceeds/operating/isone/op8/op8_rto_final.pdf)>
33. *PUCT Workshop on Energy Efficiency and Renewable Energy*, TREIA and PUCT, June 30, 2010. Sourced from: <http://www.treia.org/assets/documents/35792TREIA.Wiese.500MWhearing.6.30.10.pdf>
34. *PV system pricing trends, 2014*. National Renewable Energy Laboratory. Sourced from: <http://www.nrel.gov/docs/fy14osti/62558.pdf>
35. *Regional System Plan 2013*. Section 5.5: Information on Critical Load Level. ISO- New England. Sourced from: [http://iso-ne.com/static-assets/documents/trans/rsp/2013/rsp13\\_final.docx](http://iso-ne.com/static-assets/documents/trans/rsp/2013/rsp13_final.docx)
36. *Solar Market Insight Report 2014*. Sun Shot Initiative (US Department of Energy). Sourced from: <http://www.seia.org/research-resources/solar-market-insight-report-2014-q1>
37. *Solar Photovoltaics in New England*, Planning Advisory Committee Meeting ISO-NE. May 16, 2012. Sourced from: [http://www.iso-ne.com/committees/comm\\_wkgrps/prtcpnts\\_comm/pac/mtrls/2012/may162012/solar\\_photovoltaics.pdf](http://www.iso-ne.com/committees/comm_wkgrps/prtcpnts_comm/pac/mtrls/2012/may162012/solar_photovoltaics.pdf)
38. *SIEMENS turbines*, SIEMENS. Sourced from: [http://www.energy.siemens.com/hq/pool/hq/power-generation/gas-turbines/downloads/Industrial%20Gas%20Turbines/Industrial\\_Gas\\_Turbines\\_EN\\_new.pdf](http://www.energy.siemens.com/hq/pool/hq/power-generation/gas-turbines/downloads/Industrial%20Gas%20Turbines/Industrial_Gas_Turbines_EN_new.pdf).
39. *Uprate Options for the MS6001 Heavy-Duty Gas Turbine*, GE Energy. Sourced from: [http://site.ge-energy.com/prod\\_serv/products/tech\\_docs/en/downloads/GER-4217B.pdf](http://site.ge-energy.com/prod_serv/products/tech_docs/en/downloads/GER-4217B.pdf)
40. *Utility-Scale Concentrating Solar Power and Photovoltaics Projects: A Technology and Market Overview*, NREL, 2012. Sourced form: <http://www.nrel.gov/docs/fy12osti/51137.pdf>
41. *US Annual Average Wind Speed*, NREL. Sourced from: <http://www.nrel.gov/gis/wind.html>
42. *US Continuous Emissions Monitoring Systems ("CEMS")*, EPA. Sourced from: <http://www.epa.gov/airmarkets/emissions/>

***Note: This page intentionally left blank.***