



# Criminal Justice Information System Governing Board Meeting

July 22, 2021



# Agenda

## PROJECT UPDATE AND STRATEGY

- SUCCESS – Disposition and Case Update messages from Judicial flowing to connected downstream Agencies
- Workflow Deployment Strategy and Integration Update
- Search Deployment and Training Update
- Integration with RMS Vendor System Update
- Additional CJIS Projects and Analytics

## CJIS OPERATIONAL SUPPORT & FINANCIALS Overview of Financials

- Integration, Deployment, and Enterprise Architecture
- Integrated Project Plan Gantt Chart
- Budget for FY 22-23
- Key Success Factors for CISS Deployment
- Program Risks & Mitigations



# CJIS Information Sharing System

## Workflows

- **Goals for CJIS state-wide criminal justice information sharing system**
  - Facilitate immediate, seamless information sharing between Connecticut Criminal Justice Agencies
  - Improve the efficiency of Criminal Justice Agencies as they carry out their daily data sharing processes

### Latest Accomplishments

- Search Deployment and Training Update
  - Estimated Search users confirmed at 13K
  - Router connectivity and deployment efforts continuing
- RMS Vendor Updates
  - NexGen – Integrated Testing
  - Accucom – Level 2 Sprint
  - IMC – Working through Level 1
  - Central Square - CJIS meetings
- End-to-End Message Transmission Monitoring
- Continued successful full End to End Arrest processing with all Stakeholder agencies (Judicial/DCJ/CJIS/DESPP/NexGen) are currently undergoing full integration testing in the UAT environment
  - Full Arrest Packages workflow elements are now in place with all agencies now receiving test data End-to-End Message Transmission Monitoring



# CJIS Information Sharing System Workflows

## CJIS Level Two: Arrest Packet Message Processing

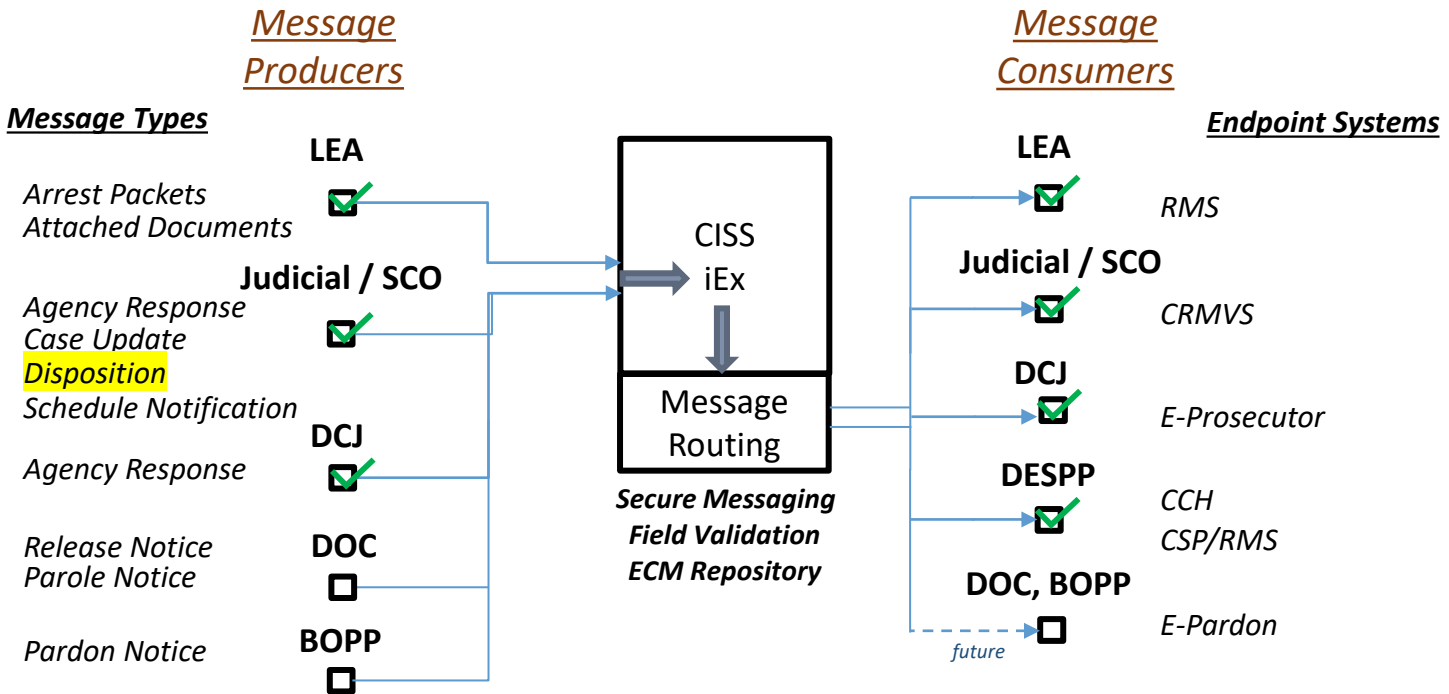



# Partner Agency Updates

## JUDICIAL

- Tech Team status (Required prior to September 24<sup>th</sup> Go Live):
  - Document handling updates related to Arrest Processing (90% Developed)
  - FTA, FTPP and VOP, VOCD Arrest Processing for July 30, 2021 (85% Developed)
  - CIB dispositions inclusion in disposition exchange replacement (In Progress)
  - DESPP change requests (In progress – in conjunction with CISS Releases 11.3 and 11.4)
- Business Team Status (Required prior to September 24<sup>th</sup> Go Live):
  - Training material is being written and is almost complete
  - Arrest Processing Queue demo was given to the Deputy Chief Clerk in GA9
  - Business process change is being reviewed and the new process will be implemented during the testing and Pilot phases
  - A full demo for the GA 9 clerks office staff is planned for early August.
  - Training of the GA 9 staff is scheduled for mid August
  - Support will be given on site during the UAT Pilot beginning at the end of August 2021
  - Support will be given on site when the Arrest Processing goes live at the end of September 2021
  - Full training schedule for the rest of the state is being produced
- Post Production Work -
  - Reconciliation Automation for the daily data transfer process
  - CISS Replacement of the CRMVS Friday File processing



# Partner Agency Updates

## DCJ

### Achievements:

- Transparency in Prosecution – DCJ will have an entire year’s worth of data for 2021. Every new case is now being tracked in eProsecutor
- Scanning case related documents and uploading to eProsecutor
- Redaction Testing
- Publishing of documents by DCJ to other Criminal Justice agencies via CISS exchanges
- Participation in Testing of Document Security
- Provided tablets to every prosecutor in every District
- Installed access to the DCJ network to prosecutors in every District across the state

### EProsecutor Deployment:

- Part A & Part B Cases have been Deployed Statewide
- Ten years of data initially populated from Judicial

### Specialized Units and Bureaus

- Juvenile Cases
- Civil Litigation – Habeas Cases

### Integration with CISS

- Pilot District will be the Middletown Judicial District
- Deployment will follow the CISS Schedule until deployed statewide.



# Partner Agency Updates

## DESPP

- Currently considerable resources from CJIS, NexGen and Judicial are allocated to support July 26, 2021 LiveScan and CCH implementation date.
- All impacted CJIS agencies are fully committed to supporting DESPP deployment schedule.



# Partner Agency Updates

## AGENCY UPDATES

- BOPP – Restarting effort for full workflow integration, new Case Management System
- DOC – CISS Delivery of Dispositions using the MVP Portal
- DMV Integration
  - - CISS Delivery of Dispositions to PERU Group using the MVP Portal
  - - CISS Delivery of Arrest A-44 forms to PERSE Group using the MVP Portal
  - - CISS Search replaces the CRMVS Search for Driver Services
  - - CISS Subscription alerts of new arrests to Driver Education

## RMS VENDORS

- NexGen
  - Workflow integration testing with full arrest packages in UAT
  - DESPP LiveScan Integration Testing
- Accucom
  - Programming Level 2 arrest package generation in RMS (SYSTEST environment)
- Central Square
  - IMC RMS integration with CISS with Level 1 is progressing
  - Executive Level agreements with Central Square's 3 other RMS systems used in CT





# GA9 Deployment

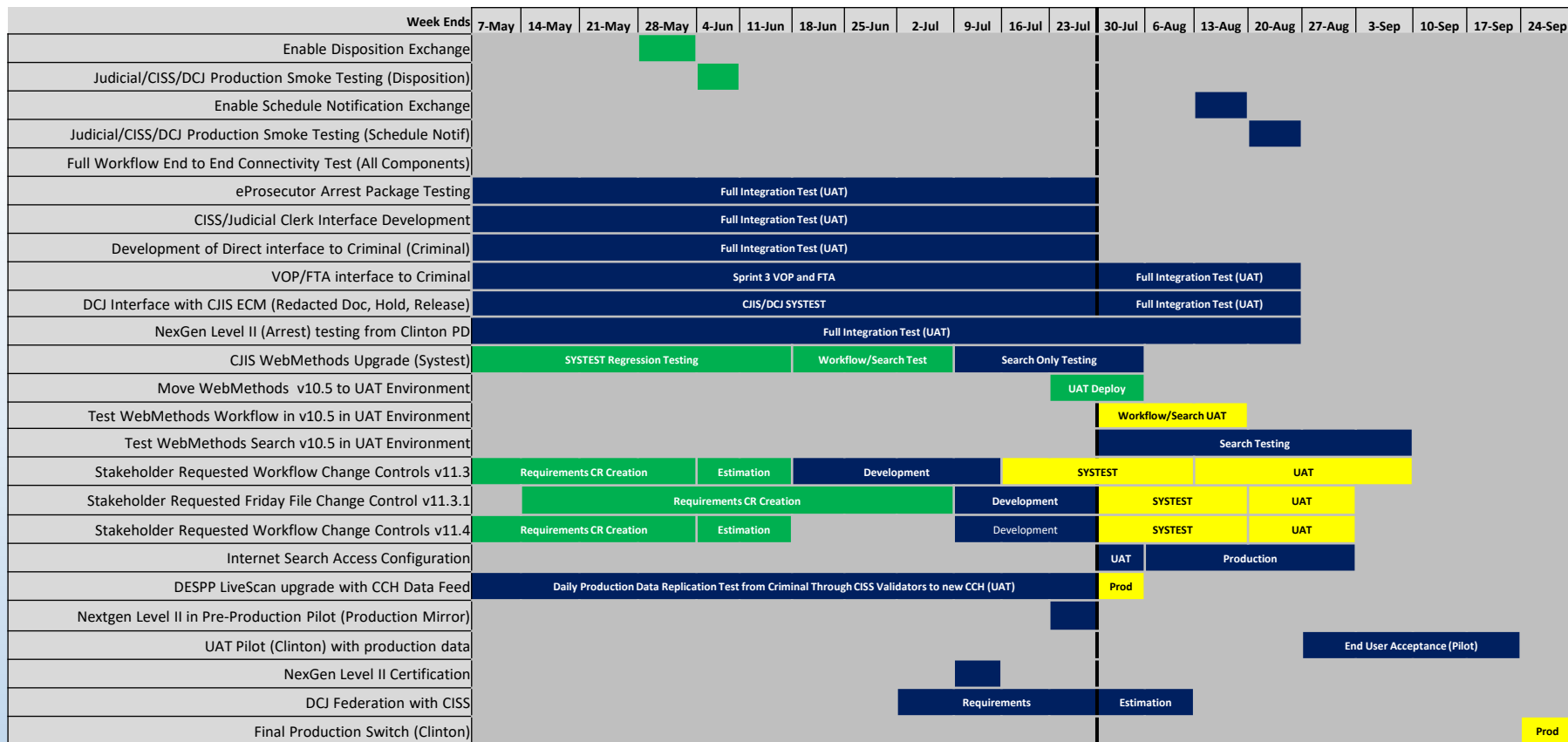

- GA9 Police Departments in scope are Chester, Clinton, Cromwell, Deep River, Durham, East Haddam, East Hampton, Essex, Haddam, Killingworth, Middlefield, Middletown, Old Saybrook, Portland, and Troop F in Westbrook



# Statewide JD Workflow Deployment

Seq #	JD	Team	GA	Begin	End
1	Middlesex	Team A	GA 9 – Middletown	8/27/2021	10/29/2021
2	Tolland	Team A	GA-19 Tolland	11/5/2021	2/4/2022
3	Windham	Team A	GA-11 Windham	2/11/2022	5/6/2022
4	Waterbury	Team A	GA-4 Waterbury	5/13/2022	8/5/2022
5	Ansonia/Milford	Team A	GA-5 Derby	8/12/2022	10/7/2022
5	Ansonia/Milford	Team B	GA-22 Milford	8/12/2022	9/30/2022
6	New London	Team A	GA-10 New London	10/7/2022	12/2/2022
6	New London	Team B	GA-21 Norwich	10/7/2022	11/25/2022
7	Stamford	Team A	GA-1 Stamford	12/9/2022	2/3/2023
7	Stamford	Team B	GA-20 Norwalk	12/9/2022	2/3/2023
8	Litchfield	Team A	GA-18 Torrington	2/10/2023	5/5/2023
9	New Britain	Team B	GA-15 New Britain	2/10/2023	4/28/2023
10	New Haven	Team A	GA-23 New Haven	5/5/2023	7/14/2023
10	New Haven	Team B	GA-7 Meriden	5/5/2023	7/14/2023
11	Fairfield	Team A	GA-2 Bridgeport	7/21/2023	9/29/2023
12	Hartford	Team B	GA-12 - Manchester	7/21/2023	9/29/2023
12	Hartford	Team A	GA-13 Enfield	10/6/2023	12/15/2023
12	Hartford	Team B	GA-14 Hartford	10/6/2023	12/15/2023
13	Danbury	Team A	GA-3 Danbury	12/22/2023	3/1/2024

Table represents Police Departments using NexGen RMS software. Accucom and IMC police departments will be provided as the RMS systems are integrated with CISS.



# CISS Workflow Tracking, Delivery & Recovery



## Benefits

- Reporting and notification of message successes and failures
- Service Level Agreements for message delivery
- Message Tracking and Recovery Dashboard
- Automated data validations, reconciliation, and auto recovery
- Full transparency of the workflow process

## Project Status

- Draft requirements completed and in the process of vetting them with CJIS Stakeholders for their input and approvals
- Next Steps:
  - Stakeholder approval of requirements
  - CJIS develops Design Document
  - Project schedule and resource plan for development, testing and implementation



# CISS Workflow Deployment – Level 1

## EARLY ARREST NOTIFICATION (EAN) - RMS

### • EAN DEPLOYMENT

- Dispositions are now sending in Production
  - DMV
  - DOC
  - Original Sending PD
- 16 PDs currently sending Early Arrests
- 28 additional - Dispositions enabled
  - 26 from NexGen ready (of 72)
  - 2 from AccuCom

### • ABSTRACTS SFTP SOLUTION –

- CJIS is creating a replacement CRMVS data feed
  - Judicial (SCO) - can move to shutdown the legacy CRMVS Service immediately
  - Allow PDs and Agencies to receive Abstracts “Friday File” throughout transition

### • CJIS ACCESS TO STATUTE TABLE SERVICE

- Resolved Statute Table update issues at PDs
- Previously - CPCA notified 8 PDS who are now on new solution + 5 additional expected
- CSP has implemented new solution
- NexGen Indicated 5 Additional

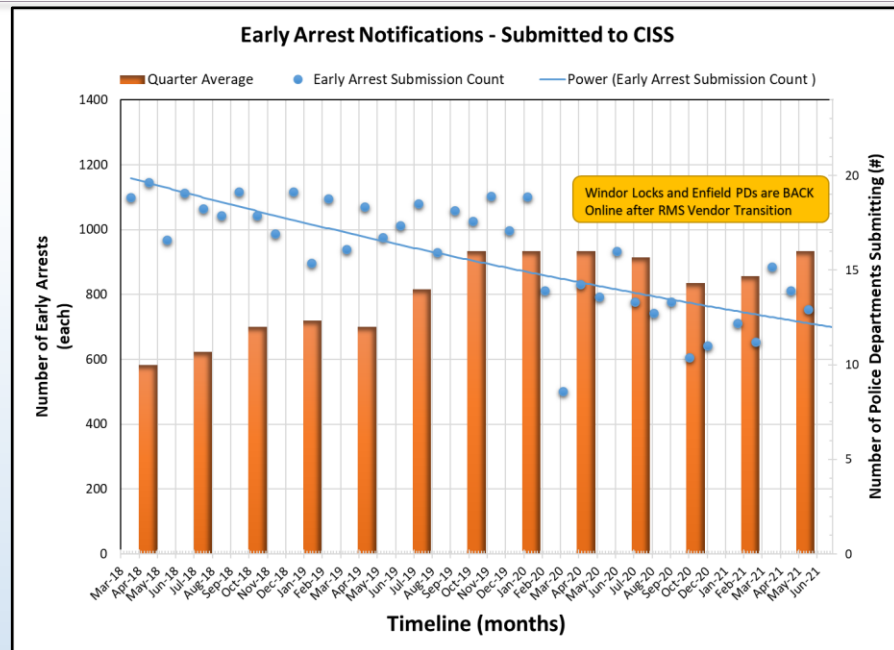



# Arrest Paperwork UAT Pilot – Level 2

## ELECTRONIC ARREST PACKAGE – RMS (detailed summary in Appendix)

- Integrated Multi-Agency Testing in progress
  - Daily Testing Arrest Submissions in UAT
  - Clinton PD Pseudo-Prod Server is 100%
    - Arrest Packages (data)/Transmittals
    - Arrest Documents and Forms
    - Training of Officers
  - CT State Police – Planning a Pseudo-Prod Server
    - Recent CSP and DESPP Organizational changes are expected to impact CISS Workflow Deployment efforts
- UAT –
  - Multi-Agency Testing Program with Production Data is currently running
  - Live UAT Pilot - All Agencies will have compatible versions of software

		Mar-2021	Apr-2021	May-2021	Jun-2021	Jul-2021	Aug-2021	Sep-2021	Oct-2021	Nov-2021	Dec-2021	Jan-2022	
RMS Deploy- ment	<b>GA-9 DEPLOYMENT</b>												
	<i>PSUEDO-PROD SERVER Clinton PD</i>	PRODUCTION READY	PRODUCTION READY	PRODUCTION READY	PRODUCTION READY		LIVE UAT PILOT	PRODUCTION	INTEGRATION CERTIFICATION				
	<i>Middletown PD</i>									PRODUCTION			
	<i>State Police Troop F</i>											PRODUCTION	



# CJIS Special Projects & Analytics



Connecticut Department of Social Services

Making a Difference



Agency Name	CISS Search	CISS Workflow	CJIS Analytics	Current Status
Departments of DCP, DSS, DRS (SIM-SAM)	✓			Active
DMV - Driver Services IB-53/Judicial CR-39	✓		✓	Complete
DMV - Monitoring Driver Instructors	✓		✓	Project Initiation
Combined CJIS/COLLECT Routers	✓	✓		Deployment (98% +) PD LANs - Active
DOC & DMV MVP Dispositions		✓	✓	Complete Deployment - Active
OPM – New Arrests Report & DCJ - Docket Reports			✓	Complete - Ended
CT Sentencing Commission (SA 19-17) – Study Disparities in Pretrial & Sentencing Outcomes			✓	Part 1 Complete Part 2 - Active
State Marshals Self Service Portal (C.G.S §14-10 & C.G.S §6-38a)			✓	Ver. 1 LIVE - Complete Ver. 1.5 - Active
Criminal Record Erasure Reporting (HB 5019 & SB 403)			✓	Initiation
Police Use of Force Transparency (PA 19-90 )		✓	✓	Phase 1 Complete Phase 2 - Active
CISS Search Available via Internet	✓			Active
DOL – Incarceration Validation Portal (DOC)	✓		✓	Requirements - Active
DMHAS – Misdemeanor Competency Evaluations		TBD	✓	Judicial (SCO) Handoff
Digital Evidence	TBD	✓	TBD	Researching Grant Possibilities

\* Other Notables: Racial Profiling, BOPP & DESPP Data Exchanges



# CISS Search Strategy (Current & Future Customers)

## CISS ONBOARDING STRATEGY (Per Calendar Quarter)



### Positive Outcomes

- Number count for Municipal PD Staff to be onboarded onto CISS Search increased on average of 102% of former numbers received by Municipal PDs

### Risks & Mitigations

- CJIS was notified of a significant amount of imminent retirements, promotions, and re-assignments AFTER those more current numbers were reported.
- CJIS is working to continue the Service Excellence Initiative to assist with staff transitions and changes.
- CJIS is working to hire more onboarding staff.

**\*I.M.P.A.C.T. Sessions = Joint Command Staff Sessions that cover:**

*I*.dentification of each PD Service Foci. *M*.anagement Concerns, *P*.articipation in CISS. *A*.ction Requested. *C*.ustomer Service *T*.raining.)

**\*\* CSE- Continual Service Excellence continues.**

Service excellence = Customer (Partner) & Not-Yet Customer (Partner) Service Support Focused on 13 PDs per Calendar Quarter. Other times, it is as requested/needed. 15



# CISS Service Excellence Calendar Q2 Final Results

## GROUP A: QUARTER 1 END RESULTS

POLICE DEPARTMENT	Q1 Focus	CONNECTED	
		COMCNNX	LCNNX
AVON PD	TRAINING		
BRISTOL PD	SEARCHES		
DMV	TRAINING		
EAST LYME PD	TRAINING   SEARCHES   ROUTER CONNECTED		
NEW HAVEN PD	TRAINING		
SOUTHINGTON PD	NEW ROUTER DEPLOYMENT		
WEST HARTFORD PD	NEW ROUTER DEPLOYMENT		
WESTPORT PD	SEARCHES		

## GROUP A: CURRENT UPDATES

POLICE DEPARTMENT	Current Update 6/29/2021	CONNECTED	
		COMCNNX	LCNNX
AVON PD	COMPLETED		
BRISTOL PD	COMPLETED (LEGACY)		
DMV	TRAINING		
EAST LYME PD	TRAINING   SEARCHES   ROUTER CONNECTED		
NEW HAVEN PD	TRAINING		
SOUTHINGTON PD	TRAINING		
WEST HARTFORD PD	ROUTER CONNECTED		

## GROUP B: QUARTER 2 END RESULTS

POLICE DEPARTMENT	Q2 Focus	CONNECTED FOR CISS SEARCH		TN#
		COMCNNX	LCNNX	
Coventry PD	ROUTER CONNECTED		N/A	9/17
Cheshire PD	ROUTER CONNECTED	Awaiting Validations	Received but not connected	1/48
Cromwell PD	ROUTER CONNECTED (LCCNX)			30/34
Naugatuck PD	ALL ONBOARDING COMPLETE		N/A	73/75
South Windsor PD	ROUTER CONNECTED		Router now disabled	20/36
Troop F	CONNECTIVITY - COMPLETE	N/A	N/A	
Bridgeport PD	ROUTER CONNECTED	PD is redesigning network		9/17
Groton Town	ROUTER CONNECTED   TRAINING		N/A	42-43*/72





# CISS Service Excellence Tentative Schedule

## “Service Excellence” Initiative Tentative Schedule:

### Group A: Jan-Mar 2021-5

1. Avon PD
2. Branford- [COM-CNNX] [AW] [T]
3. Capitol Police [C] New Router Received
4. New Haven PD
5. East Lyme
6. Southington PD- [COM-CNNX] [AW] [T]
7. West Hartford PD [COM-CNNX] [AW- T]
8. Westport PD
9. Windsor PD [LEG-CNNX] [AW-Increase Searches]
10. Wolcott PD [AW]
11. Bristol PD [LEG-CNNX]
12. DMV [AW] [T-Ongoing for more groups]

### Group B: Apr-June 2021

1. Cheshire PD New Router Received [Awaiting Validation B]
2. Coventry PD [COM-CNNX] [T]
3. Cromwell PD New Router Received [C] [AW]
4. Groton Town [COM-CNNX] [T]
5. Naugatuck PD
6. South Windsor PD [COM-CNNX] [T]
7. Suffield PD New Router Received [C]
8. North Branford New Router Received [AW]
9. Troop F [T]
10. Bridgeport PD New Router Received [PD Redesigning Network]

### Group C: July-Sep 2021

1. Clinton- GA9
2. Deep River GA9
3. Durham GA9
4. East Haddam GA9
5. East Hampton GA9
6. Essex GA9
7. Haddam GA9
8. Killingworth GA9
9. Middlefield GA 9
10. Old Saybrook GA9
11. Portland GA9
12. Middletown PD
13. Middletown ECC

### Group D: Oct-Dec 2021\*

1. Ansonia-
2. Danbury
3. Darien PD
4. East Hartford
5. East Windsor
6. Enfield PD
7. Hamden
8. Simsbury PD
9. Waterbury
10. Wilton PD
11. Woodbridge PD
12. Yale
13. Berlin PD

### Group E: Jan-Mar 2022\*

1. CTIC-Counter Terrorist & Intelligence (TBD)
2. Greenwich PD
3. New London
4. Northwest Public
5. Norwich PD
6. Stonington PD
7. Torrington PD
8. Trumbull
9. Canton PD
10. Brookfield
11. CCSU\* [C]
12. Stamford PD

### Group F: Apr-June 2022\*

1. Hartford PD
2. Manchester PD
3. Meriden PD
4. Norwalk PD
5. Stratford PD
6. Wethersfield PD
7. Bridgeport PD
8. East Haven
9. Waterford
10. Fairfield PD
11. Willimantic PD
12. Vernon PD

\* Tentative Schedule subject to change. Additional arresting agency deployments to be scheduled beyond June 2022.

**Green:** Training, Connectivity to CISS Search [COM-CNNX=New COMBINED Router or LEG-CNNX=Legacy Router], & Customer Service Complete

**Brown:** [C]Pending Connectivity to New COMBINED (COLLECT/CJIS) , [AW] Awaiting Response from PD, [T] Training, or [M]May Be Moved to an Earlier Group

**Black=** 2021 Season for Service Excellence Initiative has not begun



# Historical Trend: Monthly Statistics

FY 2021 Q4

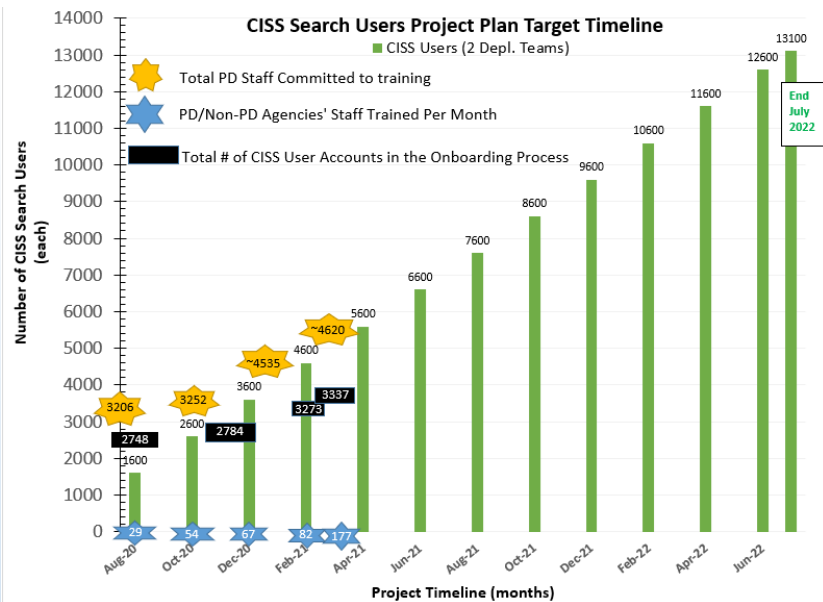

## CJIS Validates 13,000 Number

- With contributions from CPCA | CSP | Municipal PDs | CJ Agencies, CJIS confirms 13,000 onboarding number remains the same
- Updated 13,000 is an evolving number as agencies recently reported significant & imminent #s of:
  - Retirements
  - Assignment Changes
  - Promotions
- Updated 13,000 is a current result of 102% increase:
  - Municipal PDs' expected onboarding # increased to 155% of the old.
  - CJ Agencies' expected onboarding # decreased by 50% of the old.

## Accomplishments, Risks, & Mitigations

**Risks:** With CJIS' current onboarding rate, ideal conditions, & current staff:

- It would take at least 8.5 more years starting from January 2021 to fully service every PD.
- To accomplish at minimum one major required task (either new router cutover complete, new router received, OR/AND all training complete for the set season, it would take at minimum until June 2024 to onboard every PD.

### Mitigation:

- CJIS plans to hire two (2) customer service liaisons and potentially an additional engineer to help meet the time requirements.
- CJIS is working with LEAs and CJ Agencies to received updated onboarding numbers as transitions occur.



# Router Connectivity & Upgrades – Calendar Year 2021 Service Excellence Initiative: (Connectivity Only)

## PD Sites:

Validating 2021  
Current Connectivity  
Status of

**57 of 95**

PDs that received Legacy  
Standalone CJIS routers prior  
to 3<sup>rd</sup> and 4<sup>th</sup> Calendar Quarter  
Year 2020.

Additional arresting agencies  
are expected to be added.

## CJIS Revalidates PDs Connectivity

### Considering:

- PD network redesigns
- Consolidating & relocating Dispatch Centers
- New Equipment Deployments
- Elapsed time since original CISS deployment

### CISS RMS, Workflow, CISS Search Connectivity

\*(L)=LEGACY (C)= COMBINED

Police Department	RMS Vendor	Workflow Connectivity	CISS Search (L) (C)	RMS Early Arrest Submissions	Status
Ansonia	NexGen				
Avon	NexGen	☺	☺ (C)		
Berlin	NexGen	☺	☺ (L)	☐	
Bethel	Computer Info Systems				
Bloomfield	NexGen				
Branford	NexGen	☺	☺ (C)		
Bridgeport	NexGen	☺	Pending		
Bristol	NexGen	☺			
Brookfield	Central Square IMC	☺			
Canton	NexGen	☺			
State Capitol Police	NexGen	☺	Pending		
CCSU - Central CT SU	NexGen	Pending	Pending		
Cheshire	NexGen	☺	Pending		
Clinton	NexGen	☺	☺ (L)	☺	Complete
Coventry	Accucom	☺	☺ (C)	☺	Complete
Cromwell	NexGen	☺	☺ (L)		
CT State Police	NexGen		Pending		
Danbury	NexGen	☺			
Darien	Central Square Inform	Pending			
Derby	Accucom				
East Hampton	NexGen	☺			
East Hartford	NexGen	☺			
East Haven	NexGen	☺			
East Windsor	NexGen	☺	☺ (L)		
Easton	Accucom	☺		☺	



# CJIS Reports, KPIs and Dashboards

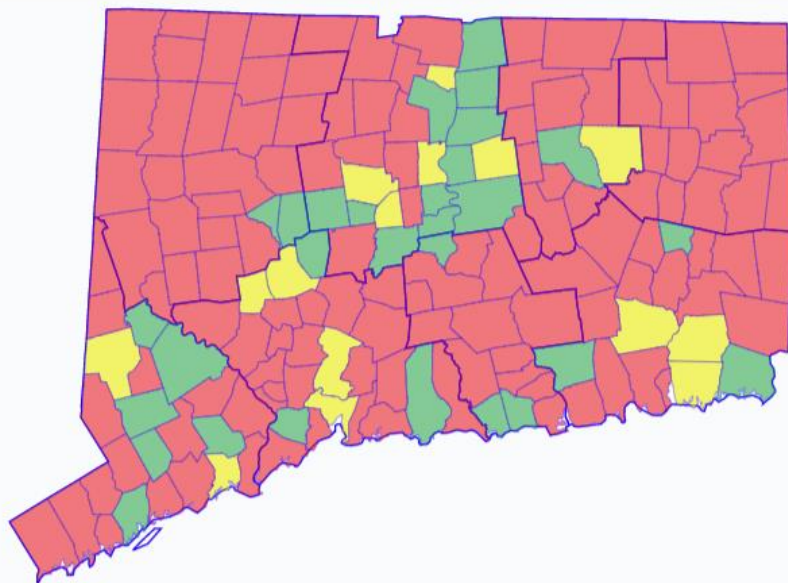

June 2020

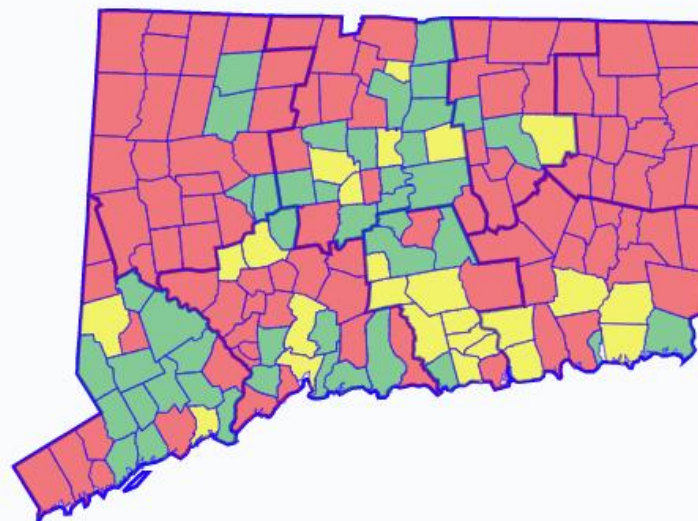

June 2021\*

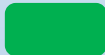

- PSDN Connected Routers – 95 (↑11)
- PD LAN Connectivity – 57\*\* (↑ 21)

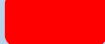
-  Access to CISS Search
-  Connectivity to CISS in progress
-  No access to CISS Search

\* Additional PDs are being added for completed CISS Search Connectivity during FY Q4

\*\*2021 Service Excellence Initiative validating that CJIS Standalones are still properly connected from deployments prior to 2020.

Connectivity Map URL - <https://dashboard.cjis-ciss.ct.gov/Map>



# CISS Workflow and Search Statewide Deployment Scope

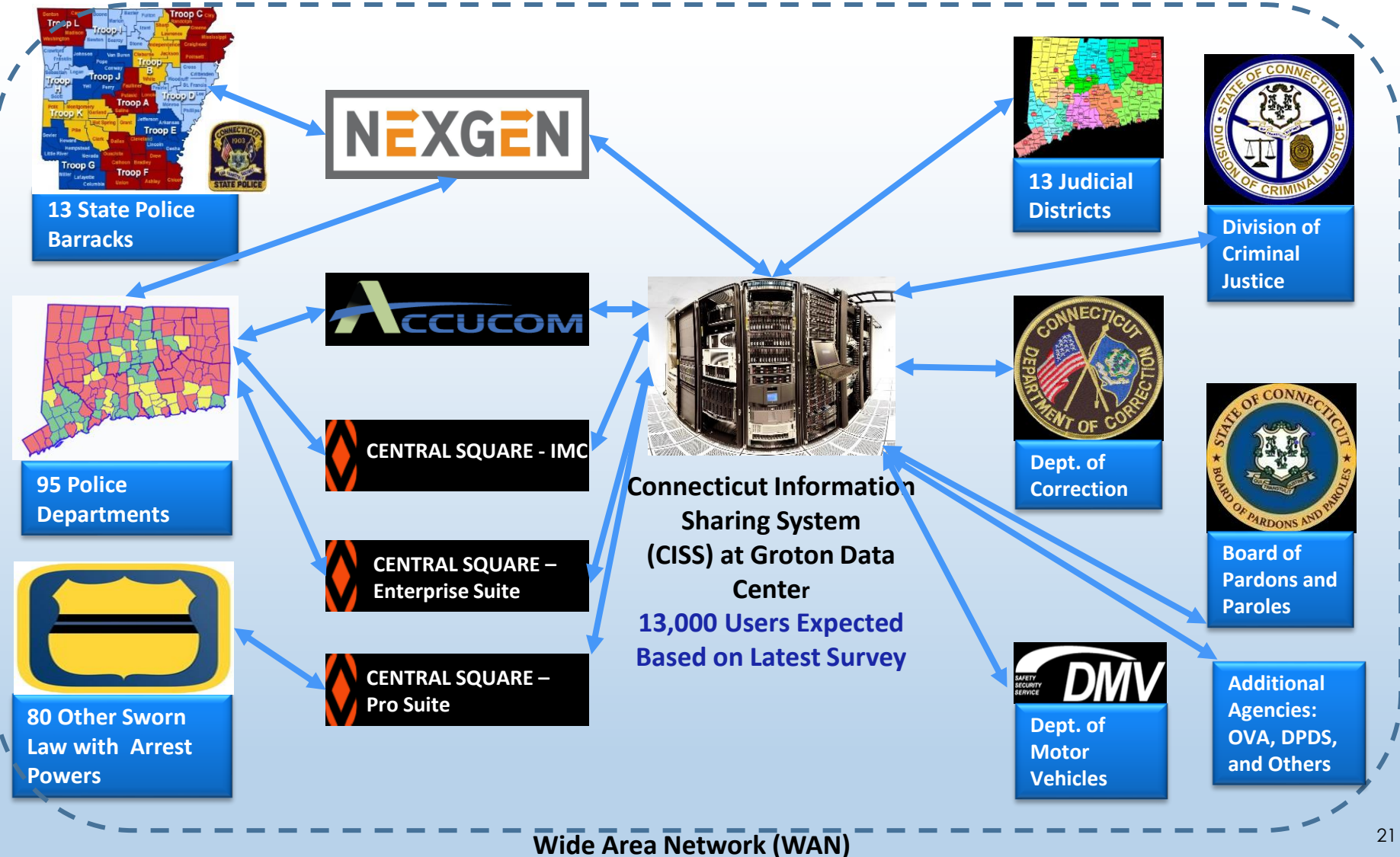



# CISS Project Portfolio Gantt Chart

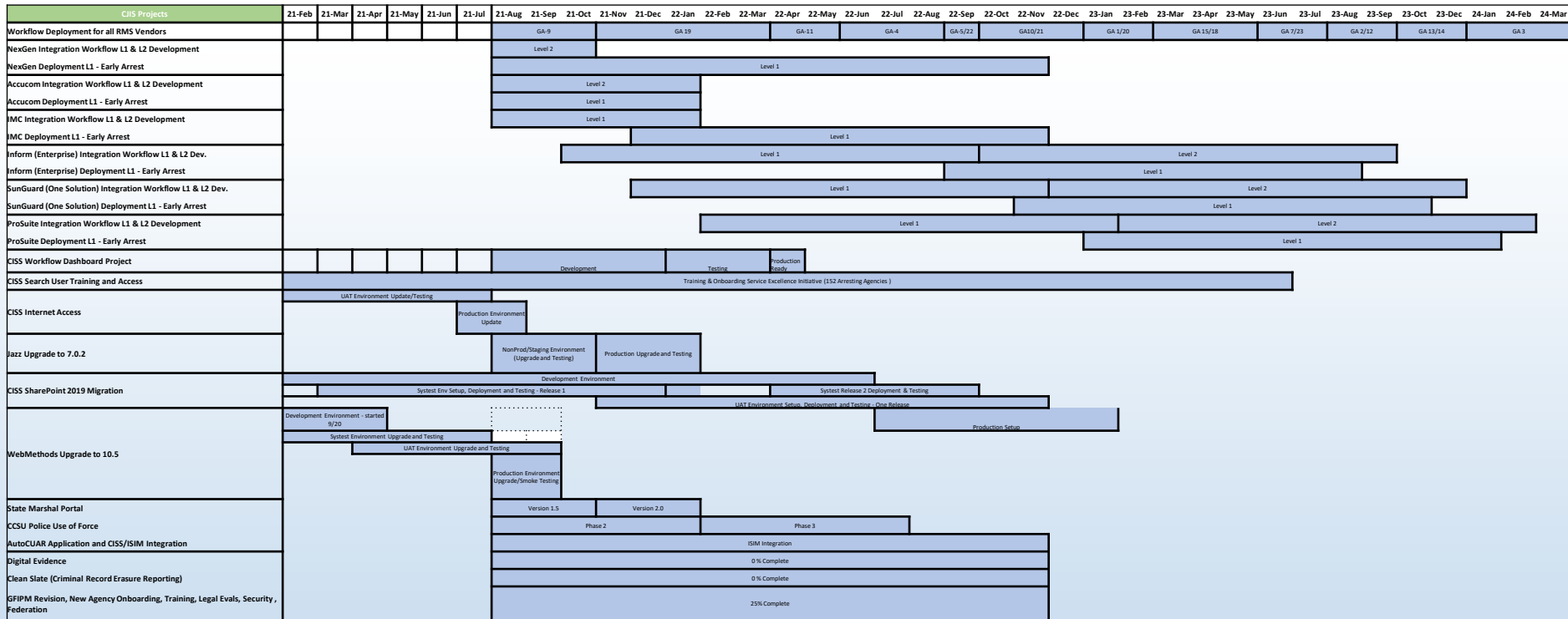

## Key Points:

- CISS Workflows with ALL RMS Vendors – Start September 2021 and Target end date is March 2024
- NexGen, Accucom, IMC, RMS Vendors - Target end date for full arrest package is March 2024
- Inform, SunGuard, and ProSuite RMS Vendors – Target date to negotiate and execute contract to build and deploy CISS API for workflows is March 2024
- CISS Search – 2,263 users currently trained, expect to train 13K users by June 2023



# CJIS Capital Budget

## CISS FY22 CAPITAL BUDGET SUMMARY

<u>CAPITAL INVESTMENT</u>	Amounts
<b>Bond Funds Provided from June 2011 to June 2020 Inclusive for Phase 1*</b>	\$ 60,920,000
<b>CJIS Appropriated Bond Funds for CISS Phase-2 Out of the \$8.9M*</b>	\$ 4,998,000
<b>Total Bond Funds Received for Phase 1 and Appropriations for Phase 2</b>	<b>\$ 65,918,000</b>
<u>CAPITAL EXPENSES</u>	
<b>CISS Phase 1 Expenses</b>	\$ 57,762,963
<b>Bond Funds Expended from July 2020 - June 2021 Inclusive for Phase 2</b>	\$ 4,183,830
<b>Total Costs for CISS Phase 1 and Phase 2 as of June 30 2021</b>	<b>\$ 61,946,793</b>
<b>Remaining Bond Funds to for Phase 2 Deployment*</b>	<b>\$ 3,971,207.00</b>

Note: \*Total Bond Funds Received for Phase 1 are 60,920,000. Approved Bond Funds for Phase-2 are \$8,924,328.



# CJIS Operational Budget for FY22-23

## CISS GENERAL FUND OPERATIONAL BUDGET SUMMARY

<u>FISCAL YEAR</u>	<u>FY22</u>	<u>FY23</u>
General Fund Budget	\$ 3,196,772	\$3,212,881
General Fund FY19 Rollover Funds for FY 22 Requested	\$ 434,020	\$455,721
<b>Total Funding for General Funds<sup>1</sup></b>	<b>\$3,630,792</b>	<b>\$3,668,602</b>
Inmate Phone Revenue Budget for State Positions and Maint. & Support	\$ 5,097,152	\$ 5,097,152
<b>Total Expected Annual Operational Budget</b>	<b>\$8,727,943</b>	<b>\$8,765,753</b>
<b>Notes:</b> 1 - CJIS is working to reduce annual costs. Software AG Costs Reduced from \$520K to \$180K Annually for FY22 and FY23		





# CISS Scope Completion & Deployment Phase

## Key Success Factors

### Secure CJIS Funding

Funding for Operational Support and Implementation of Phase 2

### Status



### Notes

FY22 and FY23 budgets are in place. General Fund with FY19 Rollover to cover FY22 and FY23 gaps if needed. Bond funds of \$8.9M received and used for deployment of CISS.

### CISS Operational Support

State Employee Hiring



State employee hiring on hold. Consultants used to supplement operational support needs.

Maintenance and Support Vendor



Contract for support started July 1, 2019. Funded from Inmate Phone Revenue.

CJIS Consultants



Bond Funding in place. Plan being executed to complete CISS state-wide deployment.

NEW - Cost Reduction and Right Sizing



CISS is negotiating with vendors to reduce costs significantly. We are also updating our "end state" organizational needs for more efficiency, effectiveness and stakeholder satisfaction.

### Other Factors

- Federal Grant Opportunities for CJIS Projects



# CISS Key Project Risks & Mitigation

## #1 RMS Vendor Participation Does Not Provide 90% + of All Arrests to CISS

### Mitigation:

- Contract largest RMS vendors with CISS to get 90%+ arrest information in the state. NexGen, Accucom and now IMC started connectivity work as well. CJIS is negotiating with Central Square to connect three more RMS vendors Systems to CISS.
- Support Law Enforcement Agencies (LEAs) to migrate to RMS vendors connected to CISS.
- CISS Connectivity required to be Standard in CT Contracts and add in new legislation.
- Provide solution(s) for LEAs with non-CISS connected RMS.

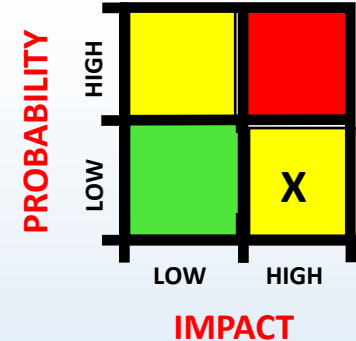

## #2 Stakeholder Support. Current CJIS Agency state budgets do not include funding for resources to implement the CISS.

### Mitigation:

- Tiger Teams - CJIS will continue to provide technical and logistical resources support to Agencies for CISS implementation.

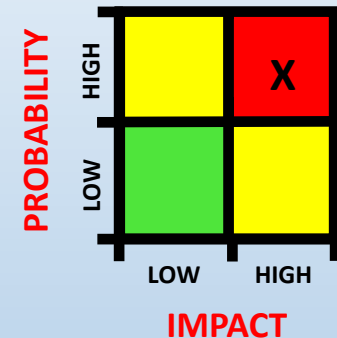



# CISS Key Project Risks & Mitigation

## #3 COVID-19 pandemic will cause delays and increase costs in the deployment of CISS Workflows and Search.

### Mitigation:

- CJIS is working with each Stakeholder impacted by the COVID-19 to help with any CISS deployment work by offering resources that may be needed.
- We are also moving CISS scope from the future to the present that must be completed in order to successfully deploy CISS with the funding and schedule planned.

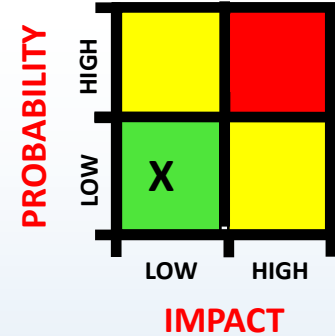

## #4 SharePoint, Software AG, MultiVue and Other Key Applications in CISS need to be upgraded over the next 24 months or significant issues will occur.

### Mitigation:

- Plans are in place to do the upgrades but this will add some delays to the deployment phase.

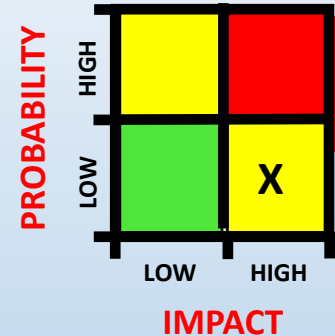



# CJIS Governing Board 2021 Meeting Schedule

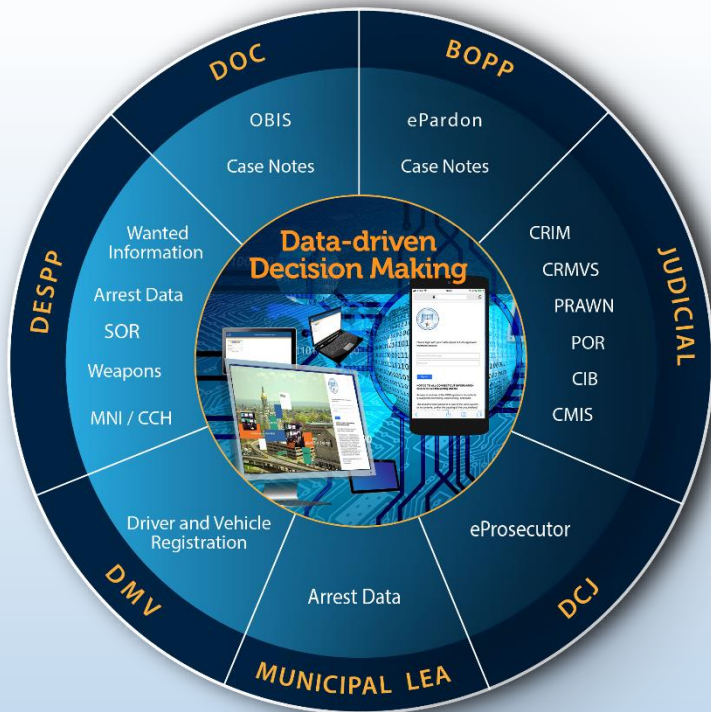

## Next Meeting

**October 28, 2021**

**Location To be determined**

**For questions and comments email**

**[CJIS.HelpDesk@ct.gov](mailto:CJIS.HelpDesk@ct.gov)**

**CISS Dashboard**

**<https://dashboard.cjis-ciss.ct.gov>**



# Appendix Slides

Appendix Slides follow



# RMS Vendor Development Level 1 & 2

## NEXGEN



- Level 1 – Early Arrest Notifications resume deployment (26 PDs)
- Level 2 – A Full Arrest Package (Arrest Packet, Docs., Transmittal) Approved
- Clinton Pseudo-Prod Server – Sending Live Arrest Packages and Receiving Agency Messages – Integrated Testing
- CT State Police Pseudo-Prod Server – Stand-alone system for Workflow Integration and Testing

		Mar-2021	Apr-2021	May-2021	Jun-2021	Jul-2021	Aug-2021	Sep-2021	Oct-2021	Nov-2021	Dec-2021	Jan-2022	Feb-2022	Mar-2022	Apr-2022									
RMS Work- Flow Develop- ment	<b>NexGen</b>																							
	Level I (EAN)																							
	Level II (Arrest Packet)	Full End to End Testing			"PRODUCTION READY"				UAT PILOT	PRODUCTION														
	<b>Accucom</b>																							
	Level II (Arrest Packet)	DEV	DEV	DEV	DEV	DEV	DEV	DEV	DEV	DEV	DEV	DEV	DEV	DEV	DEV	DEV	UAT	Level II (Arrest Package)	Full End to End Testing	"PRODUCTION READ"	UAT PILOT	PRODUCTION		
	<b>Central Square (IMC)</b>																							
Level I (EAN)	DEV	DEV	DEV	DEV	DEV	DEV	DEV	DEV	DEV	DEV	DEV	DEV	DEV	DEV	DEV	UAT	Level I (Early Arrest Notifica	Full End to End Testing	"PRODUCTION REA	PRODUCTION				
Level II (Arrest Packet)	DEV	DEV	DEV	DEV	DEV	DEV	DEV	DEV	DEV	DEV	DEV	DEV	DEV	DEV	DEV									

## ACCUCOM



- Level 1 – Early Arrest Notification submission can resume deployment (2 PDs)
- Final Level 2 Arrest Packet submitted and Document attachments – Validated May 2021
- Working on Transmittal logic and Bond Fund rules

## CENTRAL SQUARE



- IMC – Level I Kickoff was on Oct. 8<sup>th</sup>, 2020 – Development for Level 1 is now active, Target L1 completion 12/1/21
  - Development is on track – currently ramping up CISS testing submissions
- Central Square Corporate Executive Team has indicated there will be a consolidation to 4 RMS Products in CT
  - INFORM, Pro Suite - (New Britain), One Solution
  - Final Stages Executive Level Meetings in Process for Kickoff (6/30/21 and 7/28/21 Meetings)
  - Initial Stages of Contract and MOU completion via sponsoring customer Police Departments



# RMS Vendor Deployment Level 1 & 2

## INTEGRATED RMS AND ANALYTICS PROJECTS DEPLOYMENT PLANNING

- RMS Vendor Level 1 and 2 Development
- RMS Vendor Level 1 and 2 Deployment
- Active Special Projects and Analytics Projects

CJIS Projects	21-Aug	21-Sep	21-Oct	21-Nov	21-Dec	22-Jan	22-Mar	22-Apr	22-May	22-Jun	22-Jul	22-Aug	22-Sep	22-Oct	22-Nov	22-Dec	23-Jan	23-Feb	23-Mar	23-Apr	23-May	23-Jun	23-Jul	23-Aug	23-Sep	23-Oct	23-Dec	24-Jan	24-Feb	24-Mar		
Level 2 Workflow Deployment	GA-9		GA 19			GA-11		GA-4		GA-5/22		GA10/21		GA 1/20		GA 15/18		GA 7/23		GA 2/12		GA 13/14		GA 3								
NexGen Integration Workflow L1 & L2 Development	Level 2																															
NexGen Deployment L1 - Early Arrest	Level 1																															
Accucom Integration Workflow L1 & L2 Development	Level 2																															
Accucom Deployment L1 - Early Arrest	Level 1																															
IMC Integration Workflow L1 & L2 Development	Level 1																															
IMC Deployment L1 - Early Arrest	Level 2																															
Inform (Enterprise) Integration Workflow L1 & L2 Development	Level 1																															
Inform (Enterprise) Deployment L1 - Early Arrest	Level 2																															
SunGuard (One Solution) Integration Workflow L1 & L2 Development	Level 1																															
SunGuard (One Solution) Deployment L1 - Early Arrest	Level 2																															
ProSuite Integration Workflow L1 & L2 Development	Level 1																															
ProSuite Deployment L1 - Early Arrest	Level 2																															
State Marshal Portal	Version 1.5		Version 2.0																													
CCSU Police Use of Force	Phase 2																															
AutoCUAR Application and CISS/ISIM Integration	Phase 3																															
Digital Evidence	ISIM Integration																															
Clean Slate (Criminal Record Erasure Reporting)	0 % Complete																															
GFIPM Revision, New Agency Onboarding, Training, Legal Evals, Security, Federation	0 % Complete																															
	25% Complete																															