

OPM - Criminal Justice Policy & Planning Division

Monthly Indicators Report

Highlights

- CT prisons and jails held 15,161 prisoners on August 1, 2016. A year ago, there were 16,156 people incarcerated in the state, an annual decline of 6.2%
- The prison population shrank by 182 inmates during July. The sentenced population declined by 111 prisoners during the month. The number of pre-trial detainees fell by 75 (see table 2).
- Staff with CSSD’s Jail Re-interview Program (JRI), conducted 47% fewer prisoner interviews in July than they did in June. JRI releases were down 25% compared to the previous month. This comes in the wake of layoffs at the Judicial Branch forcing some JRI staff to be reassigned to other tasks.
- Admissions to prison during July were down 16% compare to a year ago. Sentenced admits were down 17%, pre-trial admits were down 15% (see table 3). Although total remands to prison were down by 11%, special parole remands were up 16% from July 2015 and up 55% from June 2016.
- The number of new parole hearings has held constant, at 164, for the last three months. The parole approval rate has ranged from 55% to 60%. Parole grants since May have exceeded last year’s level in each of the last three months (see table 4).
- The number of offenders on special parole status continues to grow, unabated. During the last year, the number of special parolees occupying slots in the DOC’s limited, residential-bed network was up by 42%, from 191 to 271. Offenders in Community Release slots declined by 29%, from 613 to 435, during the same period (see table 3).

Prison Population Forecast

On August 1, the inmate count was down by almost 1,000 prisoners compared to the last year’s figure. As a result, OPM’s forecast is now off by 452 prisoners – in other words – the projection is off by the size of a small prison. Despite the mood of our forecaster, this is very good news.

Producing accurate forecasts, over the long term, depends on several factors including 1) a reliable system model 2) limited system volatility 3) accurate and timely operational data, and 4) the ability to adapt and recalibrate the forecast model to account for change.

If history is a guide, the loss of 1,000 prisoners, during a single 12-month period, is far from typical. The last time we saw such a drop was after the

implementation of RREC in 2011. In this instance, sentenced prisoners accounted for 82% of the entire drop. While legislative changes, like raise-the-age, decriminalization of small amounts of marijuana and the reduction of drug possession from a 7-year felony to a 1-year misdemeanor, will inevitably reduce the prison population, it is difficult to quantify the exact the impact on the system, or how quickly the impact will be observed. .

Better efficiency at BOPP, measured by 1) the number of hearings, and 2) increasing parole caseloads, has clearly contributed to this fall-off in the number of sentenced prisoners. So too has centralization of the process for reviewing and approving discretionary prisoner releases. From its inception last year, the Community Release Unit (CRU) has introduced consistency and accountability to a once-murky and somewhat disjointed effort. Recent positive trends for both community supervision caseloads and sentenced-prisoner counts are tightly aligned with Commissioner Semple’s decision to create CRU in early 2015.

TABLE 1 – Prison Population Forecast

	Avg. Daily Count	OPM 2016 Forecast	Inmate difference
JAN '16	15,556	-	-
FEB	15,852	15,860	8
MAR	15,664	15,659	-5
APR	15,517	15,604	87
MAY	15,418	15,579	161
JUN	15,279	15,567	288
JUL	15,290	15,588	298
AUG	15,153	15,605	452
SEP	-	15,613	-
OCT	-	15,644	-
NOV	-	15,639	-
DEC	-	15,480	-
JAN '17	-	15,227	-
FEB	-	15,451	-

Avg. Daily Count (ADC) for 1st week of month

Chart 1 – Actual prison population against the OPM forecasts
January 1, 2015 through February 1, 2017

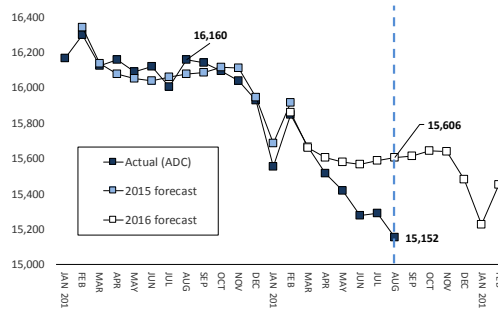

Chart 2 - Criminal justice, monthly counts and flows

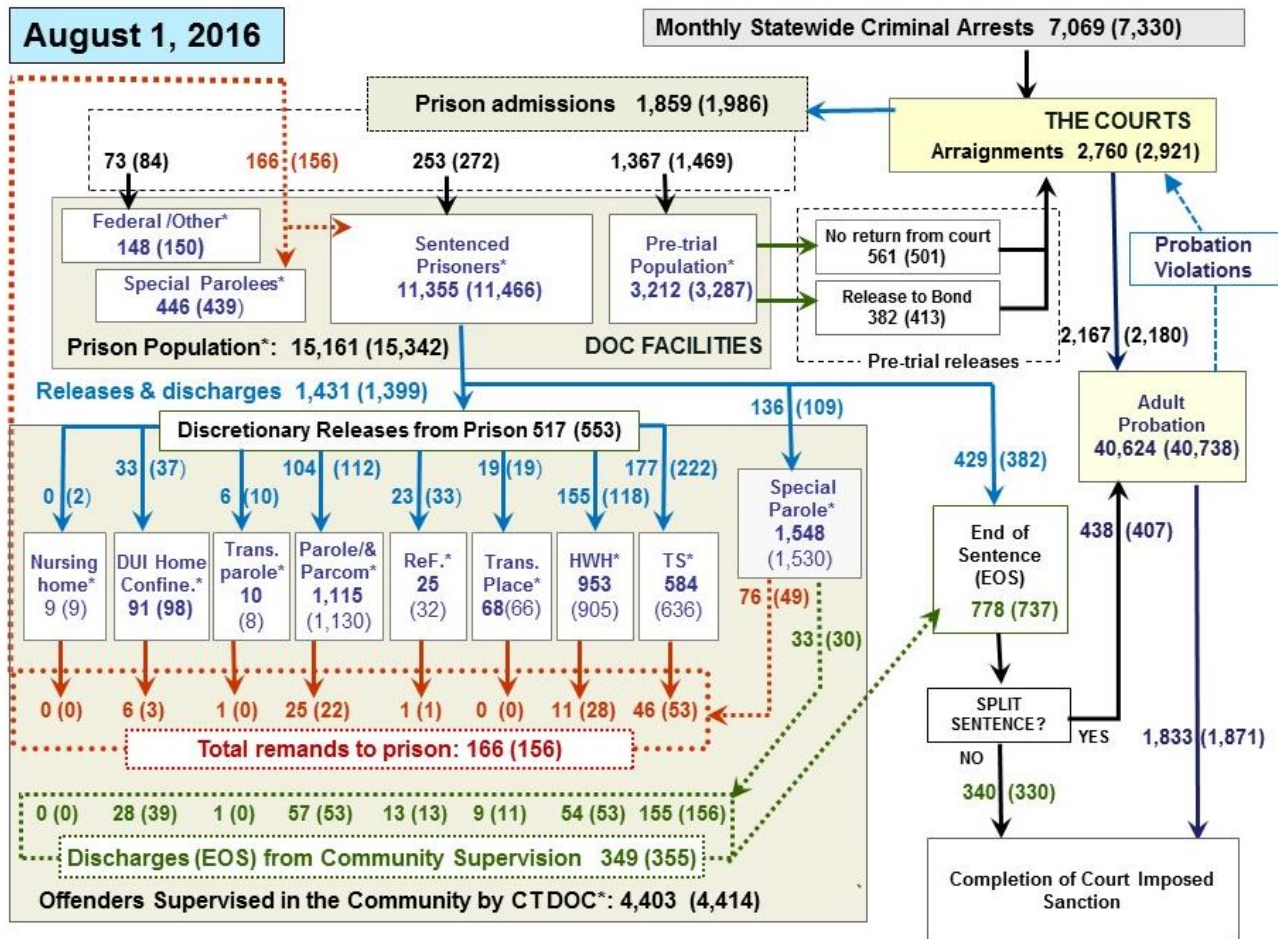
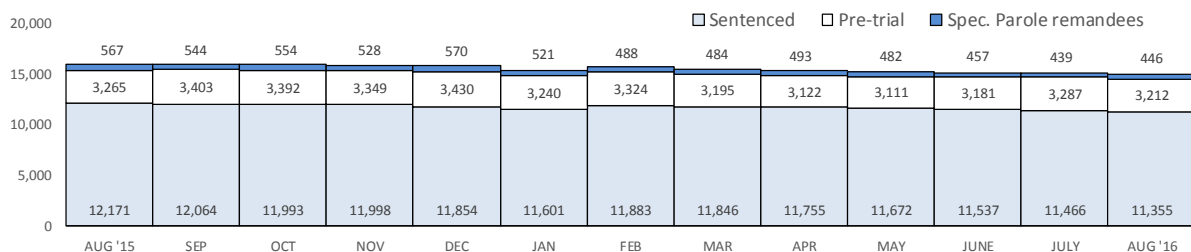

Chart 2 contains monthly operations data for July 2016 and daily counts reported on August 1, 2016. Asterisks (*) indicate the daily count on August 1st. Figures for last month are enclosed by parentheses. Sources: Arrests - OBTS, Court and probation data - CSSD, all other data - CT DOC.

Chart 2a – Prison population drops by 1,000 prisoners in a year



On August 1, the state's prisons held 15,161 inmates, 995 fewer than they did a year ago. The scale of this year-long population decline was not anticipated by OPM, and the causes have not been definitively established. Shifts, of this magnitude are generally associated with large policy or legislative changes that affect the flow of offenders either into, or out of, the DOC. The last time we observed such a rapid and sustained drop in the prison population was in the months following the implementation of RREC in 2011 and 2012.

The data indicates that 94% of this past year's drop can be accounted for by a 6.7% decline in the number of sentenced prisoners and a 21.3% reduction in the number of special parole

remandees. The number of federal and pre-trial prisoners remained, essentially, flat.

OPM has watched recent declines in the number of sentenced prisoners with great interest. The creation of a Community Release Unit combined and a much-improved reporting capability supplied by the DOC MIS Division, has introduced transparency to the case review and approval process that was once confounding opaque and dispersed. Until the last year, it was impossible to determine just how many prisoners were eligible for release, and how many actually had their cases reviewed. OPM is now confident that cases of release-eligible offenders are being reviewed quickly and efficiently. The cumulative impact of this improved efficiency is a falling count.

Table 2 – The first-of-month totals

	2016	2016	2016	2015	% Change	
	June 1	July 1	Aug. 1	Aug. 1	Monthly	Annual
DOC Facilities						
Federal/Other	147	150	148	153	-1.3%	-3.3%
Sentenced	11,537	11,466	11,355	12,171	-1.0%	-6.7%
Special Parole	457	439	446	567	1.6%	-21.3%
Pre-trial	3,181	3,287	3,212	3,265	-2.3%	-1.6%
Total	15,322	15,342	15,161	16,156	-1.2%	-6.2%
DOC Community						
Transfer Parole	2	8	10	0	-	-
Parole/ Parcom Total	1,117	1,130	1,115	940	-1.3%	18.6%
Parole	934	947	934	768	-1.4%	21.6%
Parcom @ CT	183	183	181	172	-1.1%	5.2%
Furlough	35	32	25	34	-	-
Trans Placement	64	66	68	70	3.0%	-2.9%
DUI/Home confine.	111	98	91	98	-7.1%	-7.1%
Halfway House Total	934	905	953	963	5.3%	-1.0%
Comm Release	442	404	435	613	7.7%	-29.0%
TS	47	53	59	55	11.3%	7.3%
Parole	170	182	183	104	0.5%	76.0%
Transfer Parole	1	2	5	0	-	-
Special Parole	274	265	271	191	2.3%	41.9%
TS	622	636	584	517	-8.2%	13.0%
Nursing home	8	9	9	8	-	-
Special Parole	1,500	1,530	1,548	1,301	1.2%	19.0%
Total	4,393	4,414	4,403	3,931	-0.2%	12.0%

Table 3 – Admissions, releases & discharges*

	2016	2016	2016	2015	% Change	
	May	June	July	July	Monthly	Annual
Admissions						
Federal/Other	76	84	73	110	-13.1%	-33.6%
Remands	168	156	166	187	6.4%	-11.2%
DUI	8	3	7	4	-	-
Parole	27	22	25	29	13.6%	-13.8%
Trans Plac/Furlough	1	1	1	3	-	-
HWH	36	28	11	36	-60.7%	-69.4%
TS	41	53	46	50	-13.2%	-8.0%
Special Parole	55	49	76	65	55.1%	16.9%
New Sentence	296	277	253	306	-8.7%	-17.3%
VOP	101	71	71	106	0.0%	-33.0%
Pre-trial	1415	1469	1367	1611	-6.9%	-15.1%
Total	1,955	1,986	1,859	2,214	-6.4%	-16.0%
Releases and discharges						
Transfer Parole	3	10	6	0	-	-
Parole	116	112	104	100	-7.1%	4.0%
Furlough	33	33	23	31	-30.3%	-25.8%
Trans. Placement	19	19	19	20	0.0%	-5.0%
Home Confinement DUI	30	37	33	29	-10.8%	13.8%
HWH	123	118	155	180	31.4%	-13.9%
TS	224	222	177	194	-20.3%	-8.8%
Special Parole	141	109	136	104	24.8%	30.8%
Nursing home	0	2	0	1	-	-
End of Sentence	783	737	778	809	5.6%	-3.8%
Total	1,472	1,399	1,431	1,468	2.3%	-2.5%
Pre-trial Releases*						
From Court	505	501	561	547	12.0%	2.6%
Release to Bond	360	413	382	425	-7.5%	-10.1%

* Totals reflect events, not individual offenders

DOC - Community Release Unit

Table 3a – Case reviews and release metrics

	Cases				Approval
	Reviewed	Approved	Denied	Continued	Rate
May	821	403	107	118	49%
June	833	398	112	121	48%
July'16	888	434	138	106	49%
July'15	829	381	152	136	46%

Board of Pardons and Paroles

Table 4 – Parole hearings, new cases

	Paroles			Paroles granted, 2015	Paroles granted, 2014
	Parole Hearings	granted, 2016	Grant rate		
May	164	95	58%	83	73
June	164	90	55%	70	98
July	164	99	60%	84	125

Table 4a – Other Board actions

	Reparole from revocation	Reparole from rescission	Closed interest cases	Special parole cases	Transfer parole cases
May	51	6	13	38	22
June	41	4	29	43	2
July'16	40	10	27	36	11
July'15	46	8	56	41	0

The pre-trial population

Table 5 – Bond ranges for pre-trial detainees

Bond amount	June 1, 2016	July 1, 2016	Aug. 1, 2016	Aug. 1, 2015
Less than \$20K	592	603	596	651
\$20K to < \$50K	534	593	557	535
\$50K to < \$100K	624	646	675	724
\$100K or higher	1,501	1,532	1,488	1,460
Offenders w/bonds	3,251	3,374	3,316	3,370
Over \$1M	159	155	149	180

Table 5a – Pre-trial, weeks since admission

Weeks since last DOC admit	June 1, 2016	July 1, 2016	Aug. 1, 2016	Aug. 1, 2015
< 1 week	407	432	495	511
1 to < 3 weeks	374	409	364	417
3 to < 10 weeks	841	856	799	877
10 to < 30 weeks	919	950	935	826
30 wks or more	712	730	725	742
Pre-trial prisoners	3,253	3,377	3,318	3,373

Table 5b – Pre-trial admits, new offenders

	Apr. 2016	May 2016	June 2016	July 2016
Arraignments	2,746	2,933	2,921	2,760
Pre-trial Admits	1,345	1,415	1,469	1,367
New to DOC	337	377	415	375
% New	25%	27%	28%	27%

Court Support Services Division

Table 6 – The Jail Re-interview Program

	Pre-trial admissions	Offender interviews	Offenders released	Releases last year
May	1,415	1,616	774	832
June	1,469	1,412	711	778
July	1,367	743	529	873

Table 6a – Pre-Trial & split-sentence starts

	Pre-trial Bail Case Starts	Client Supv. Starts	Split Sentence Starts
May	2,393	2,332	458
June	2,319	2,180	407
July '16	2,289	2,167	438
July '15	2,518	2,297	431

Note: Figures published here are based on the operational data available at publication. Data in subsequent issues may not agree.

Chart 3 – Prison population

First week of the month, and ADC

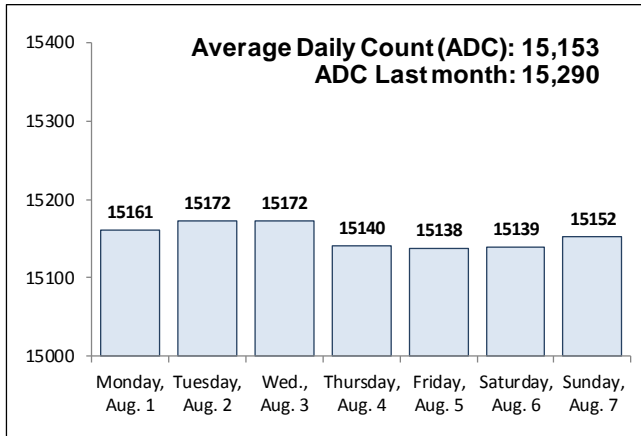

Chart 6 – Monthly DOC Admissions

June 2015 through July 2016

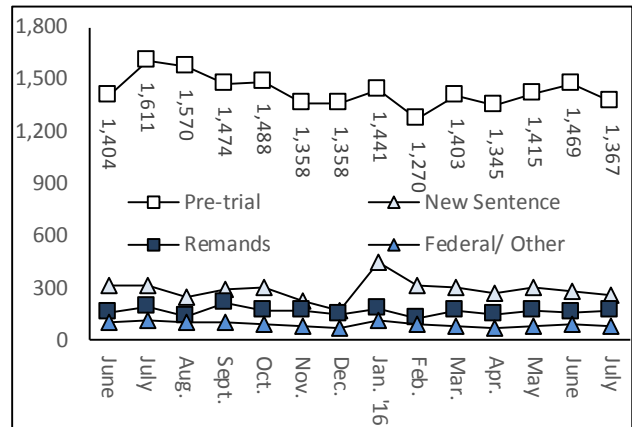

Chart 4 – Prison population, first-of-month

2014, 2015 and 2016

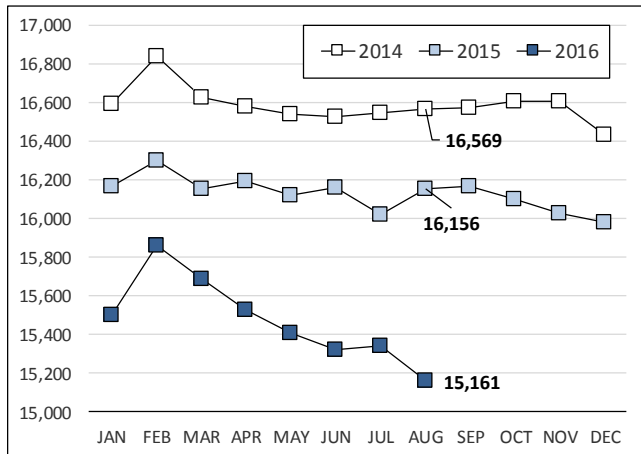

Chart 7 – Remands from community release

July 2016

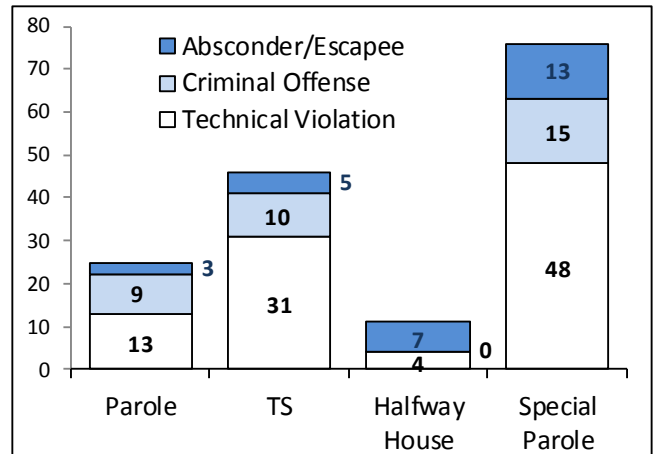

Chart 5 – Statewide criminal arrests

2015 and 2016

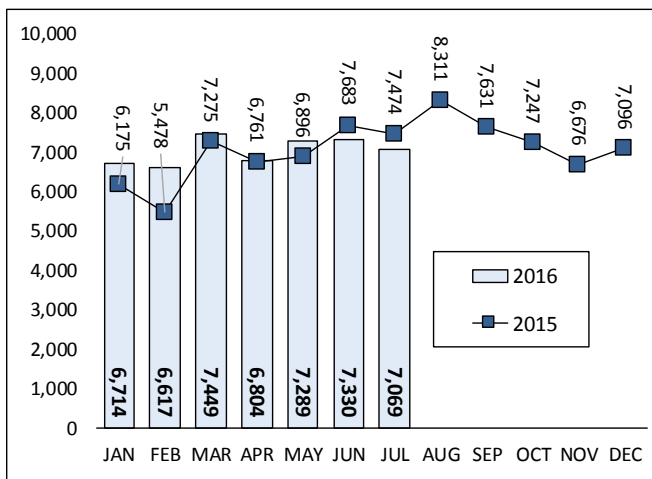
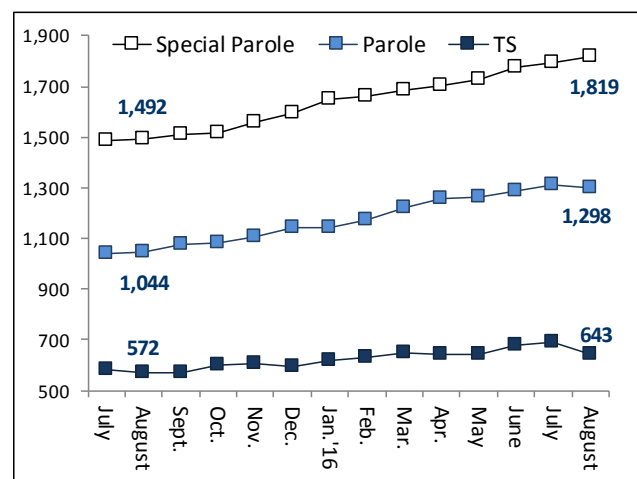

Chart 8 – DOC community supervision

July 1, 2015 through August 1, 2016



Note: Data for all charts, with the exception of Chart 5, was supplied by CT DOC. Data for Chart 5 are for new case starts in the state Offender-Based Tracking System (OBTS). Chart 8 includes offenders in halfway houses.