

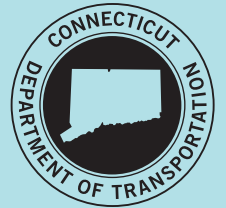

Workzone Safety

— with —
TERRI THE TURTLE



2024 Coloring
& Activity Book

Meet Terri

Terri is a Turtle who reminds us to SLOW DOWN and to be safe drivers especially near work zones! Terri is the official Mascot of the Connecticut Department of Motor Vehicles, Workzone Safety Division.

Reminding Drivers to Obey the Orange

Wear Your Seatbelt.

It is your best defense in a crash and it's the law.

Be patient.

Don't ever distract a driver when they're driving. Let them focus on the road so they can keep you and the workers in work zones safe.

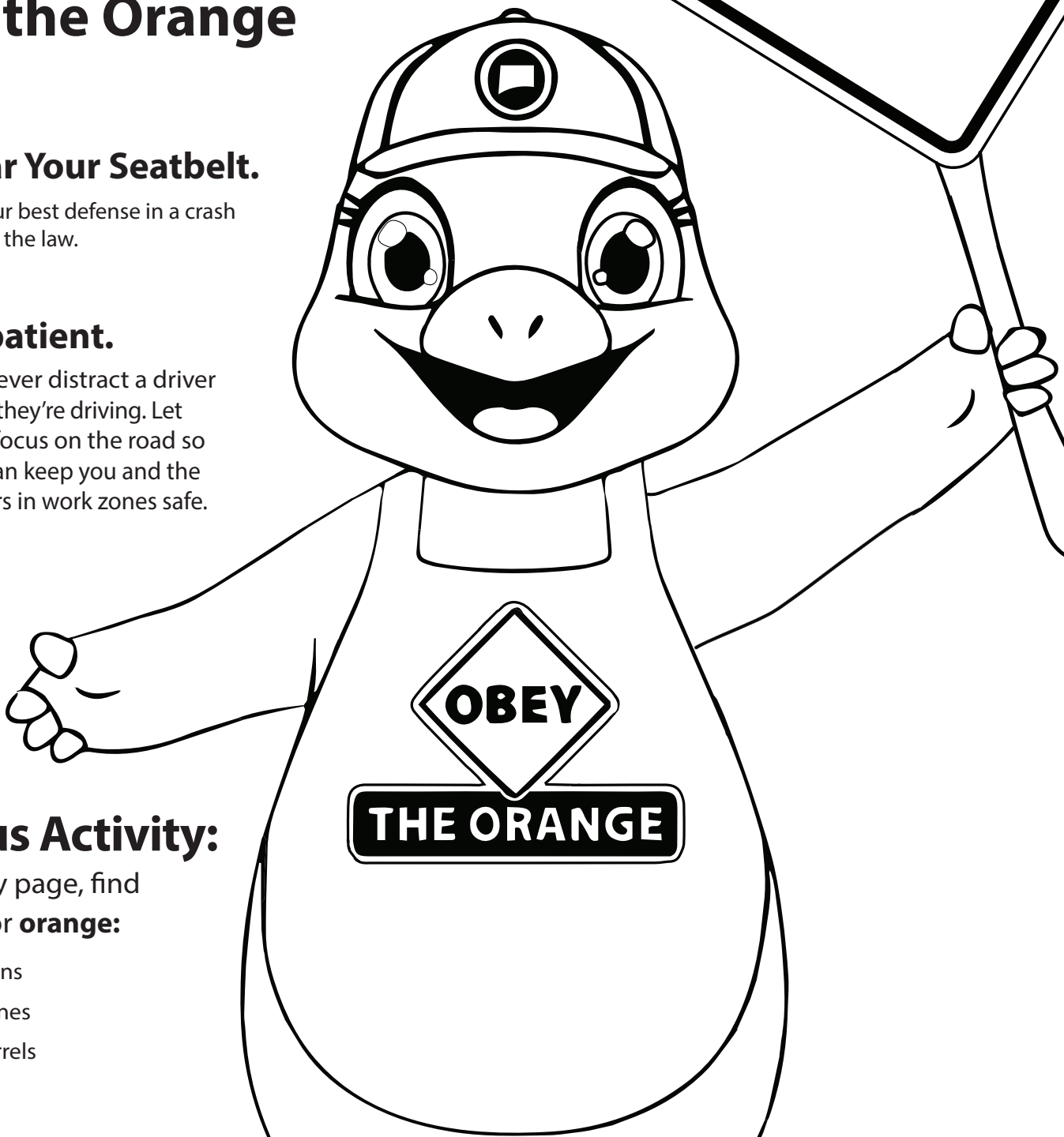

★ **Bonus Activity:**

On every page, find and color **orange**:

- Signs
- Cones
- Barrels



Tips from Terri

for Traveling Safely in Work Zones

Share with Your Parents or Caregivers:

Expect the Unexpected.

Things like speed limits, traffic lanes and road closures may change on the roads drivers travel every day!

Stay Alert.

Avoid distractions while driving/walking/biking in a work zone. Construction signs are there to help everyone move safely through the work zone.

Keep a Safe Distance.

Drive defensively by keeping distance between you and the car ahead of you to avoid accidents.

Obey Speed Limit.

Driving slower means you can react quicker and avoid workzone accidents!

Keep Up with Traffic Flow.

Don't slow down to look at road work.

Obey Road Crew Flaggers.

The flagger knows what is best for moving all road users safely through the work zone.

Know Before You Go.

Check radio, TV, and websites for traffic info; and schedule enough time so you can reach your destination on time and safely.

Be Patient and Stay Calm.

Remember, the crew members are working to improve the transportation system you use every day.

Obey the Signs.

There are signs at the beginning AND the end of the work zone. Obey the signs all the way through to the end of the work zone.

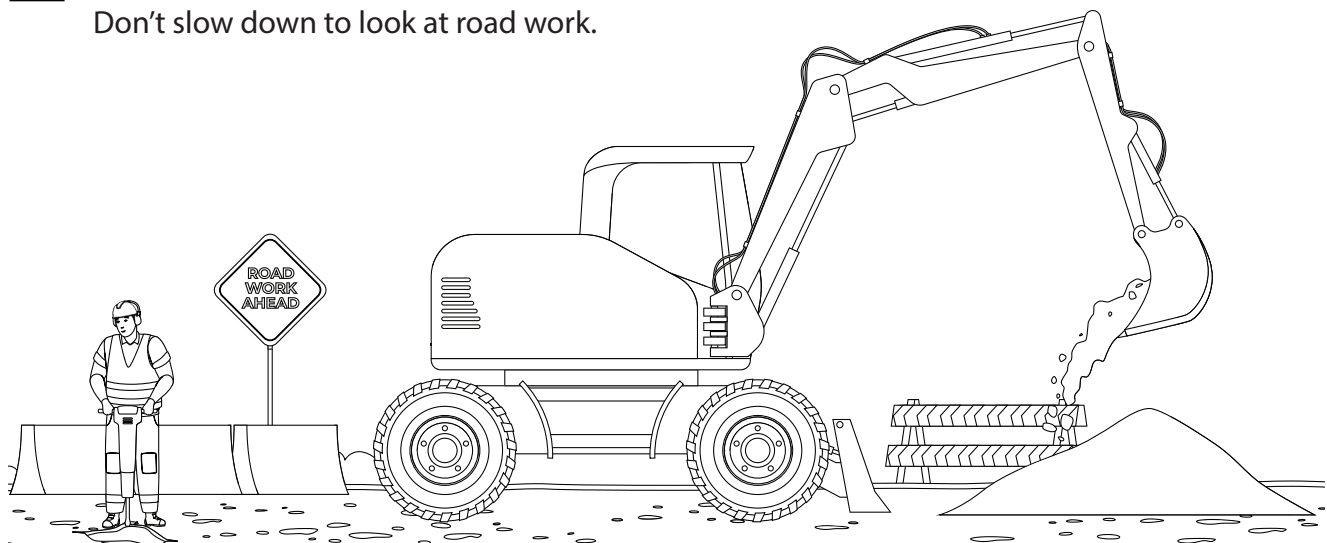

Color

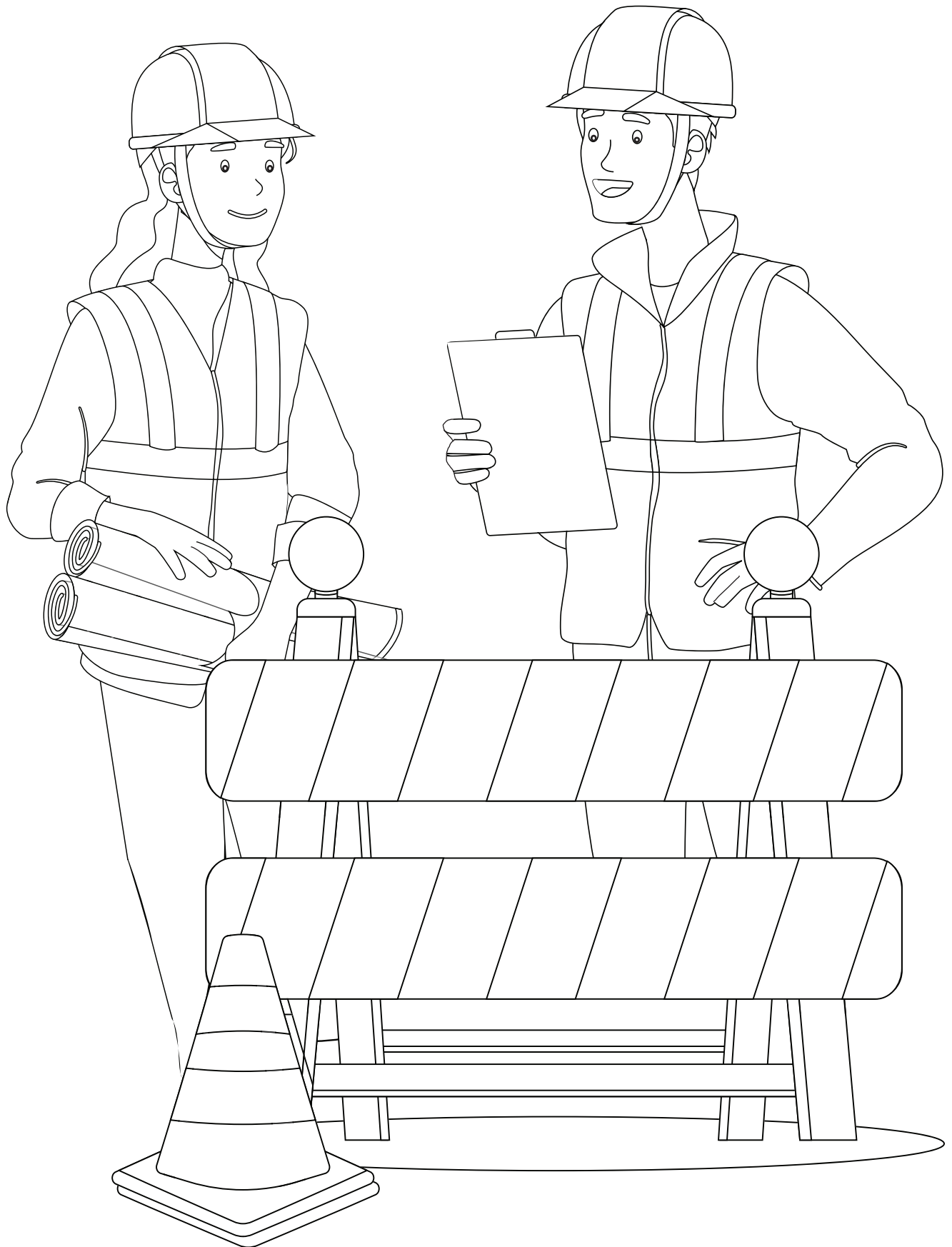

Get Terri's Friends through the Work Zone Safely

Find

- Work Zone Wally
- Darryl the Barrel
- Work Zone Crew

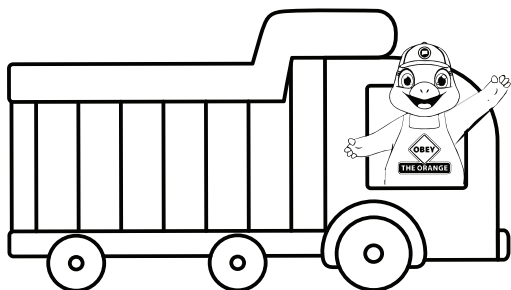

START

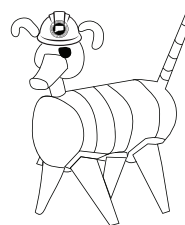

Darryl the Barrel

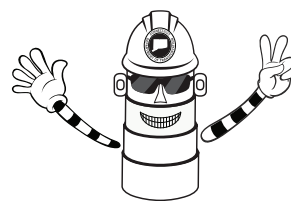

Work Zone Wally



Work Zone Crew



FINISH



Word Search

W N C L O S E D P A S S E N G E R S N L
 O R Y K Z V H E L M E T S I D E W A L K
 R P A T I E N C E S E A T B E L T O W M
 K U G Q B M N R E R E J X E F E W W G T
 E F G V B A H L I M I T B I K E L P W C
 R S I S X X O L D I Q A A A X G X M G O
 S L Q V D I U R E W O J L J C V I A C N
 S O C A R S C O N S T R U C T I O N K E
 P W J J W O R K Z O N E S A F E T Y B O
 E S A K X J L P S Q I C A X X H Y M J R
 E I B G W H I G H W A Y F L A G G E R A
 D G V D N V Z F P J Y W O Z Y F O Y R N
 S N B Q F R M I C B Y Y I S L U P C L G
 R S N X O M H D G Q F R J P Q A I B X E
 H A R D H A T O B E Y T H E O R A N G E
 P M O T O R C Y C L E S H A Z A R D S B
 I N Z C K Y F I B Y X H M D A B O L M T
 A G A L E R T R O A D W A Y Y D L X H N
 Y B U T R A F F I C T E R R I G O C N N
 R W R E C S Y G K J Z O R X J W Q R E Y

- | | | |
|--|-----------------------------------|--------------------------------------|
| <input type="checkbox"/> TRAFFIC | <input type="checkbox"/> SEATBELT | <input type="checkbox"/> MOTORCYCLES |
| <input type="checkbox"/> CONE | <input type="checkbox"/> ALERT | <input type="checkbox"/> SLOW |
| <input type="checkbox"/> ORANGE | <input type="checkbox"/> ROADWAY | <input type="checkbox"/> SIGNS |
| <input type="checkbox"/> TERRI | <input type="checkbox"/> LIMIT | <input type="checkbox"/> PATIENCE |
| <input type="checkbox"/> HARDHAT | <input type="checkbox"/> BIKE | <input type="checkbox"/> HAZARDS |
| <input type="checkbox"/> WORK ZONE | <input type="checkbox"/> HELMET | <input type="checkbox"/> CARS |
| <input type="checkbox"/> SAFETY | <input type="checkbox"/> SIDEWALK | <input type="checkbox"/> TRUCKS |
| <input type="checkbox"/> HIGHWAY | | |
| <input type="checkbox"/> FLAGGER | | |
| <input type="checkbox"/> CLOSED | | |
| <input type="checkbox"/> PASSENGERS | | |
| <input type="checkbox"/> CONSTRUCTION | | |
| <input type="checkbox"/> OBEY THE ORANGE | | |
| <input type="checkbox"/> SPEED | | |

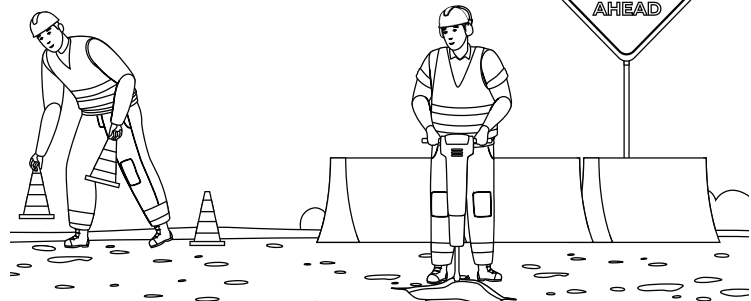

Complete the Sign:

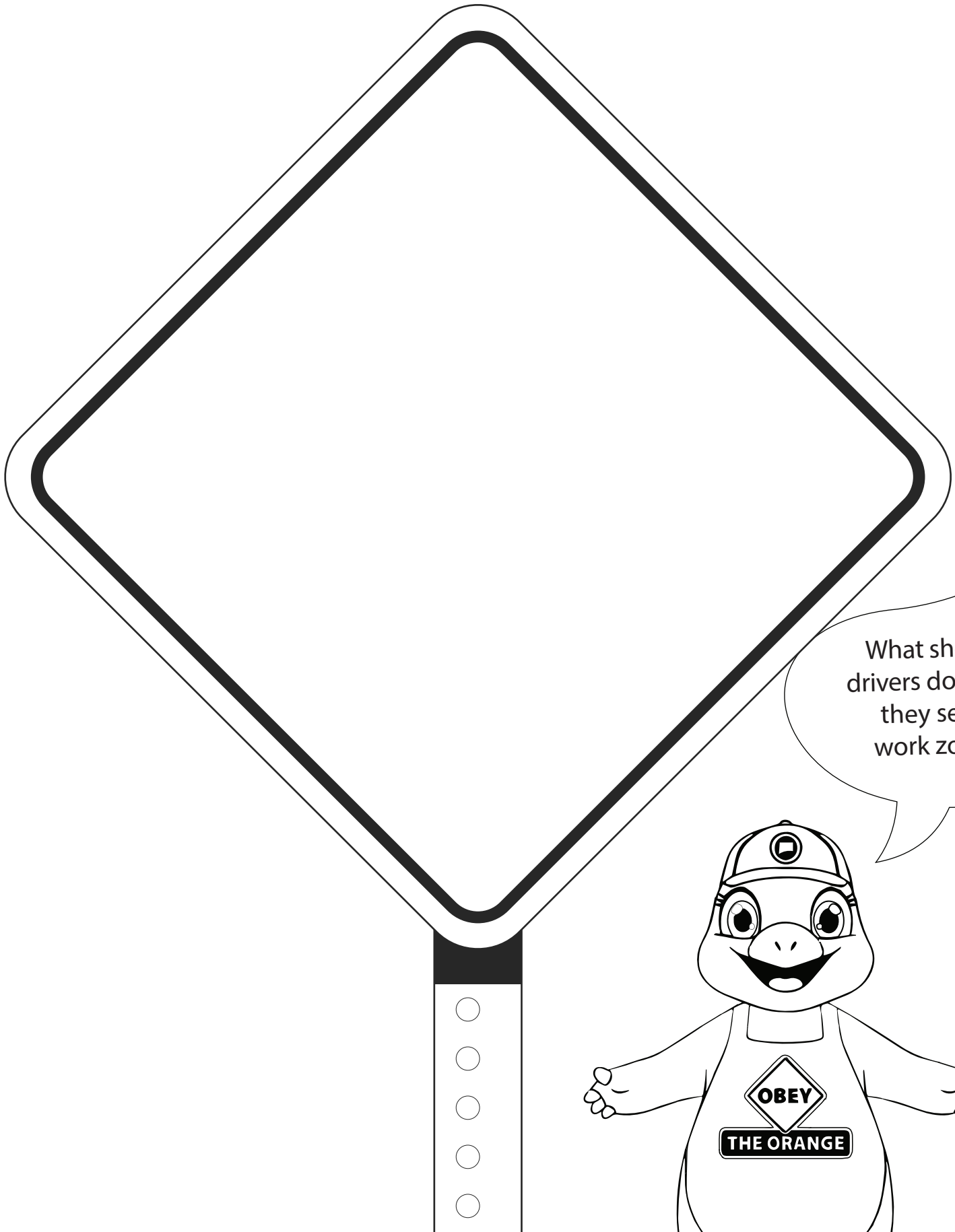

What should drivers do when they see a work zone?

OBEEY
THE ORANGE



Spot the Difference

Can you find all 12 differences in the scene?

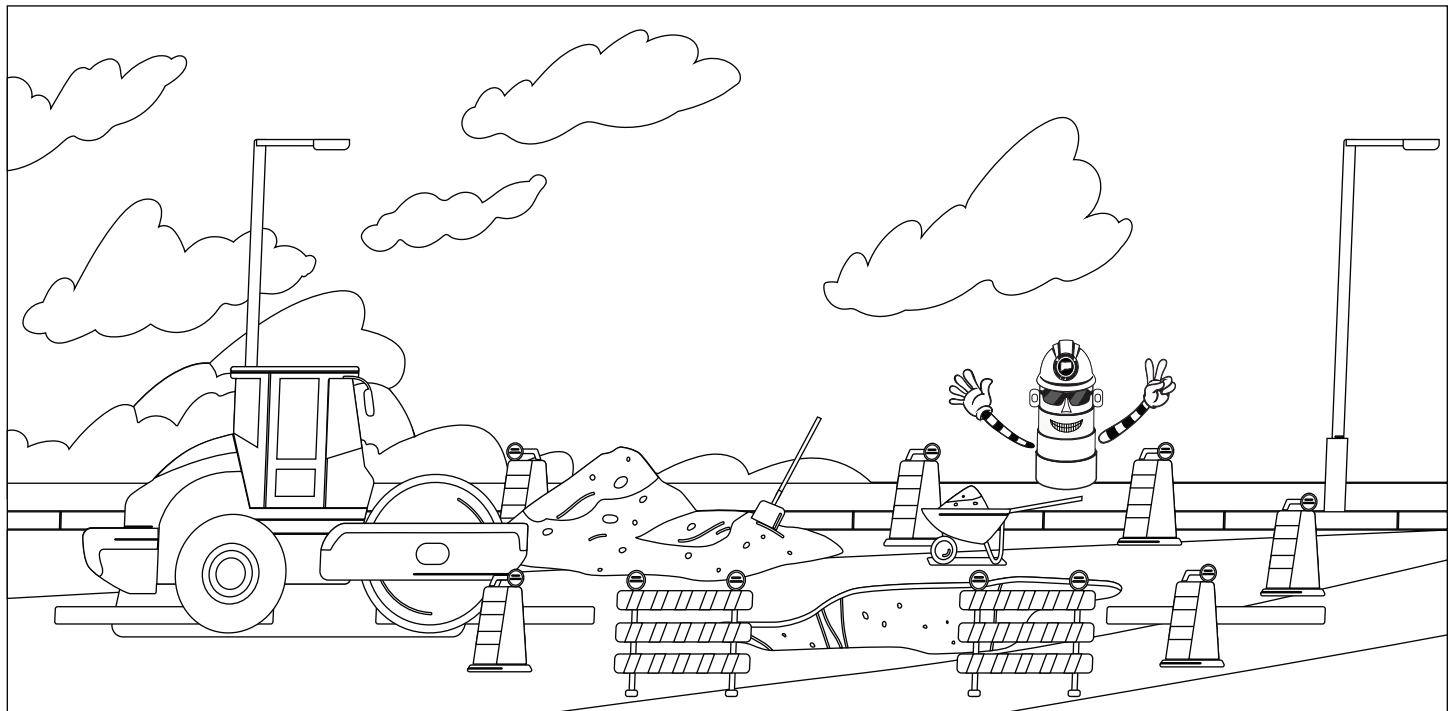
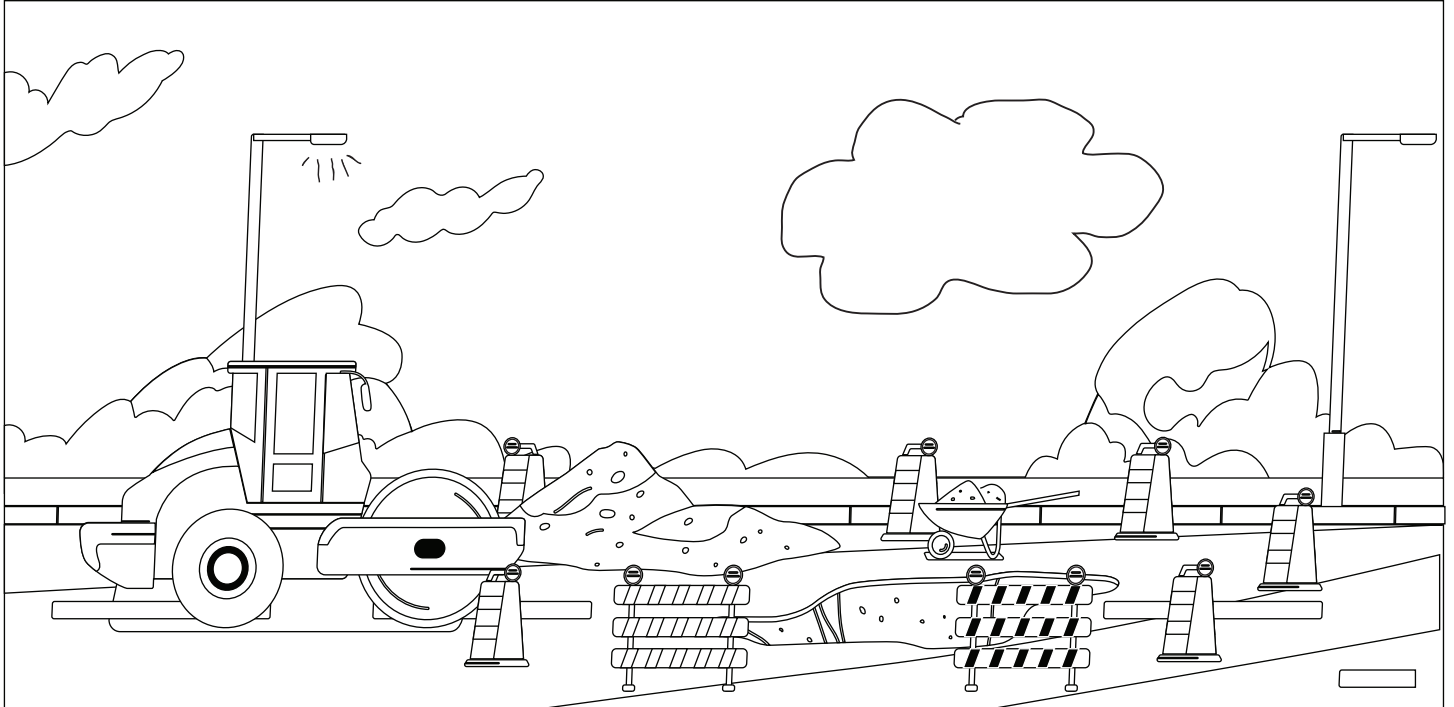

Unscramble the Names

Use the numbered clues to finish the missing sentence.

R E R T I H E T L U E T T R

— 13 — — — — — 6 — — 5 — — — — — 7

E V I R D Y S W O L L

— — — — — 3 — — — — — 1 — — — — — 4

L E B R A R

2 10 — — — 9 — — —

R E G N A O E O N C S

8 — — — — — 12 — — — — — — — — — — 11 — — — — —

What does Terri remind drivers to do?

1 2 3 4 5 6 7 8 9 10 11 12 13



Sign Match

Draw a line from the sign to its meaning.

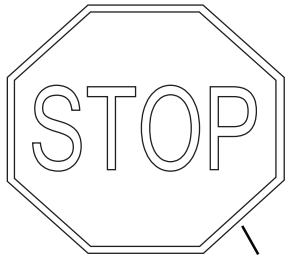

No U-Turns

An Alternate Route
to Take if a Road is
Closed or Roadwork

Slippery When Wet

Stop, Look & Wait for
the Road to be Clear
Before Driving

People at Work



Color the Work Zone Objects

Which of these are usually orange?

Safety Vest

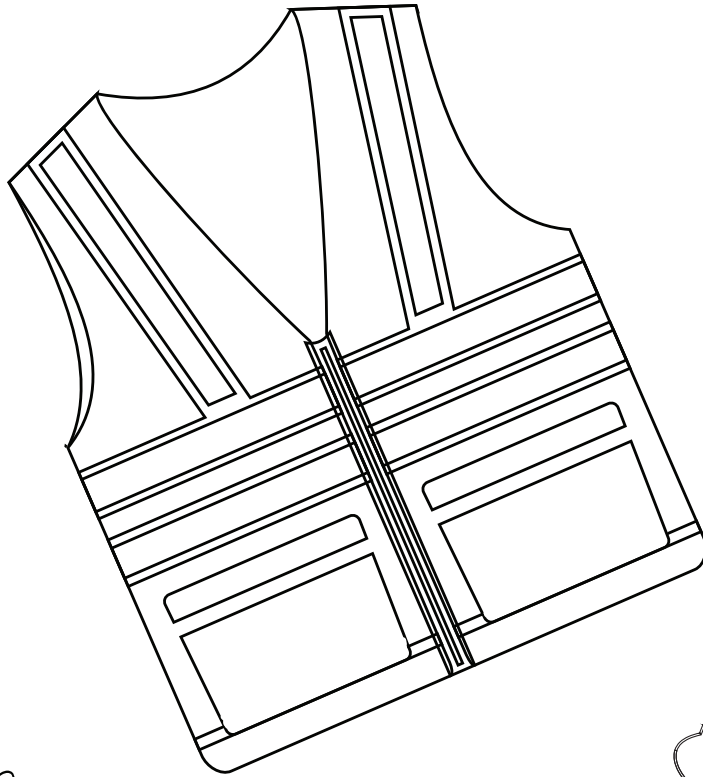

Safety Cone



Work Glove

Hard Hat

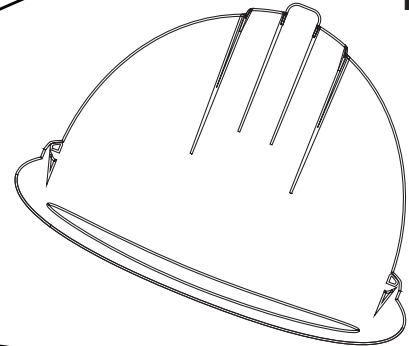

Cement Mixer

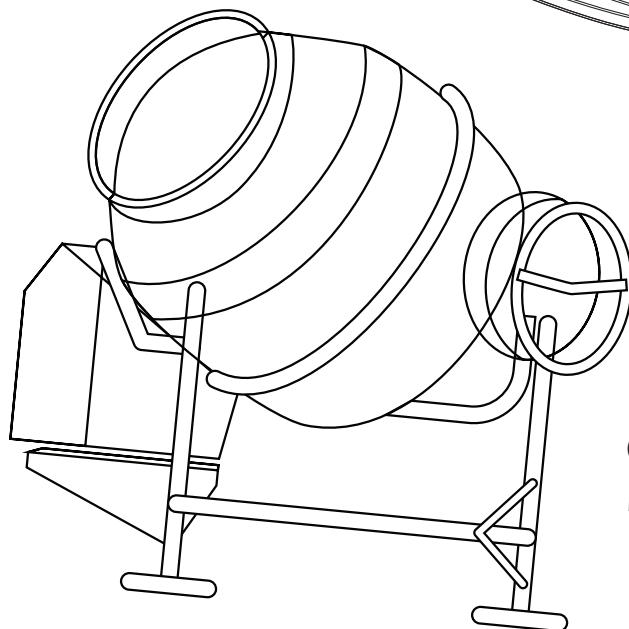

Jack Hammer

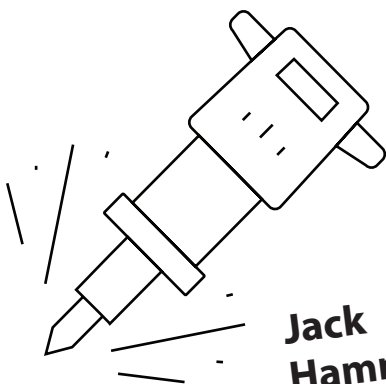

DOT to DOT

Connect the dots to find the hidden picture.

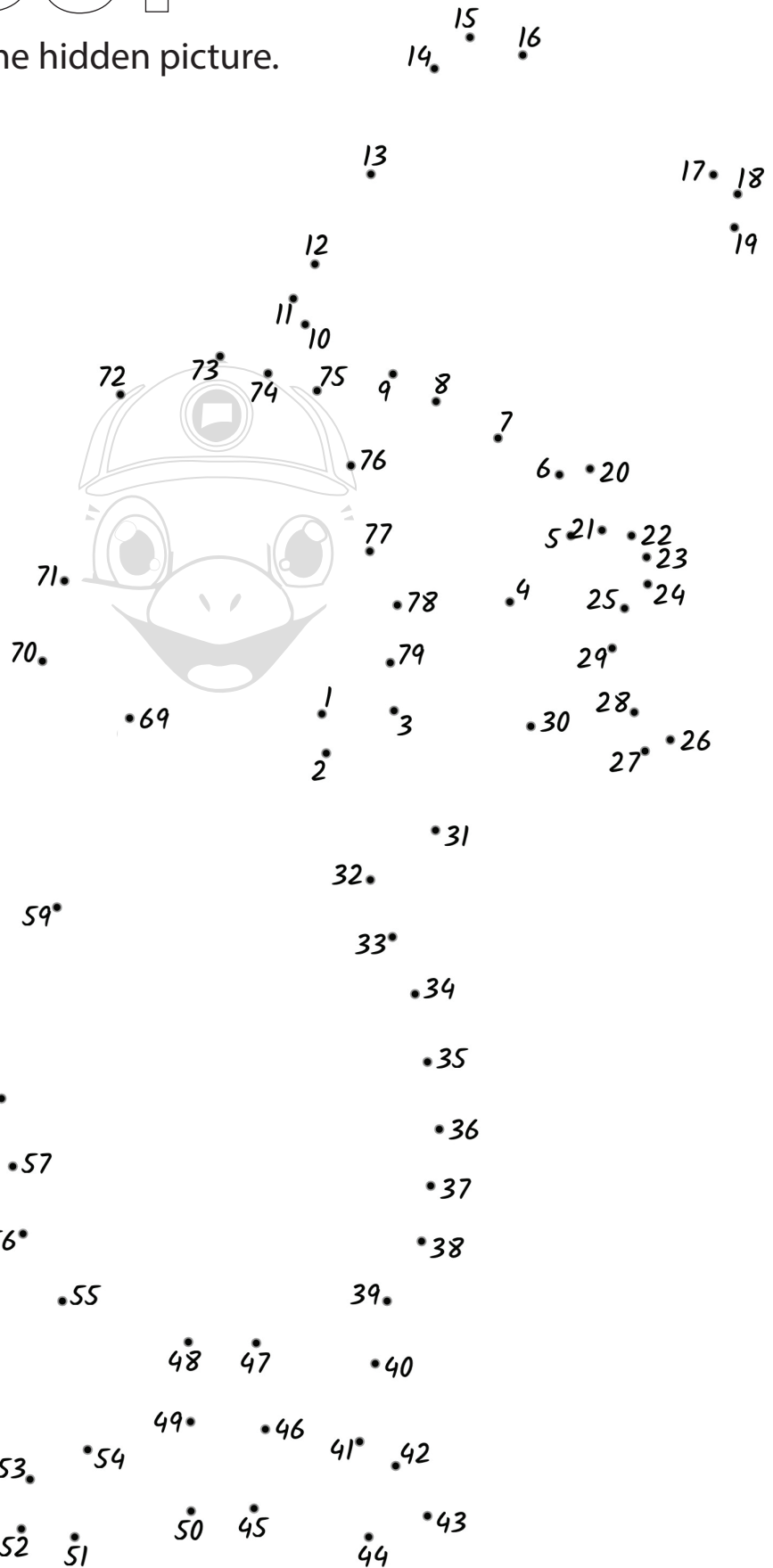

Draw a Work Zone

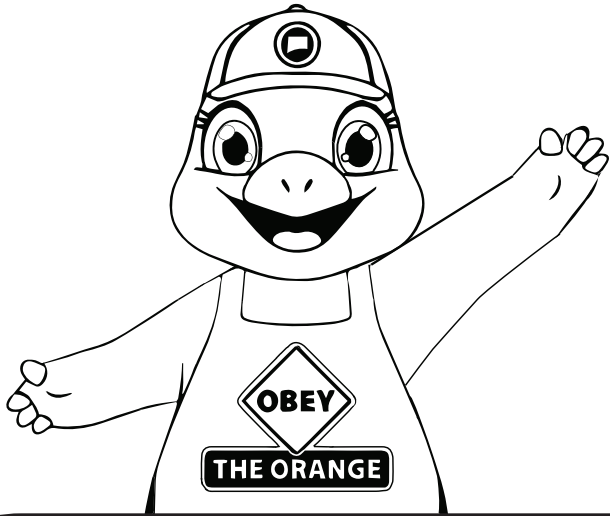

Draw a picture of what you think a safe work zone looks like.

(Remember safety cones, hard hats and safe drivers!)

A large, empty rounded rectangle with a thick black border, intended for drawing a safe work zone.

Game

————— **Cut**
- - - - - **Fold**

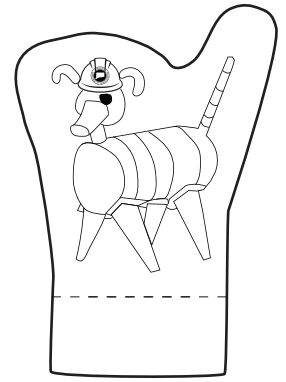
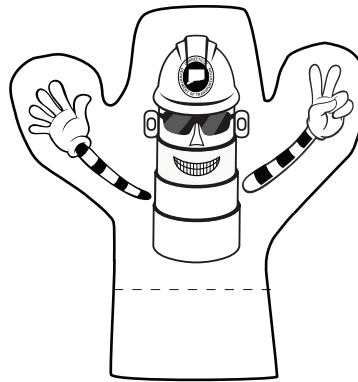
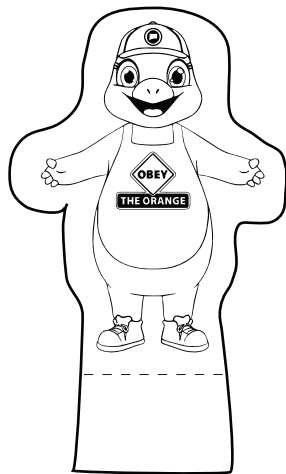

Dice

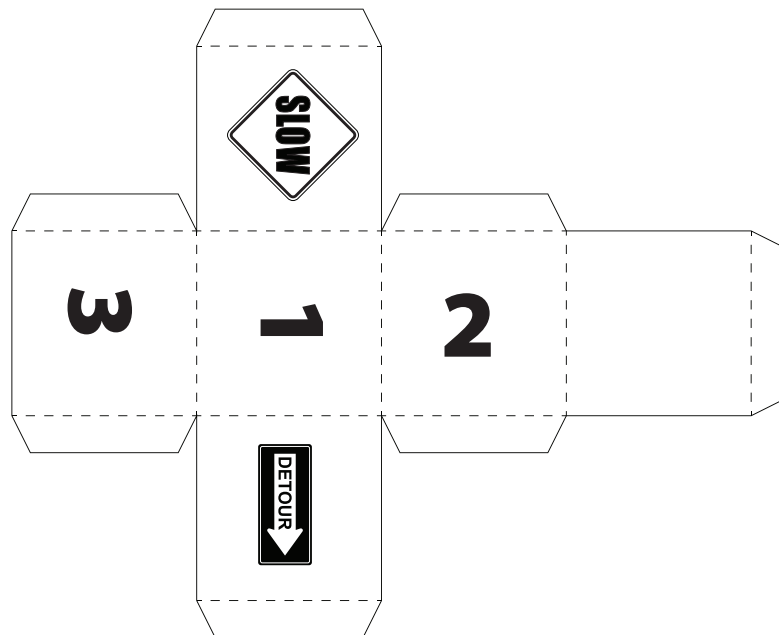

Game Setup:

Color and cut along the dotted lines to make your game pieces and dice. Fold along the dashed line on your game pieces to make them stand up. Fold the dice along the dotted line and glue/tape edges together.

How to Play:

Place your player on the **Start** space. Roll the dice and move your player as many spaces as the number on the die. If you roll a "detour," move to the nearest detour space. If you roll a "slow," skip a turn. If you land on a space with a detour, follow the arrow and stop at that space. The first player to reach the work zone safely wins.



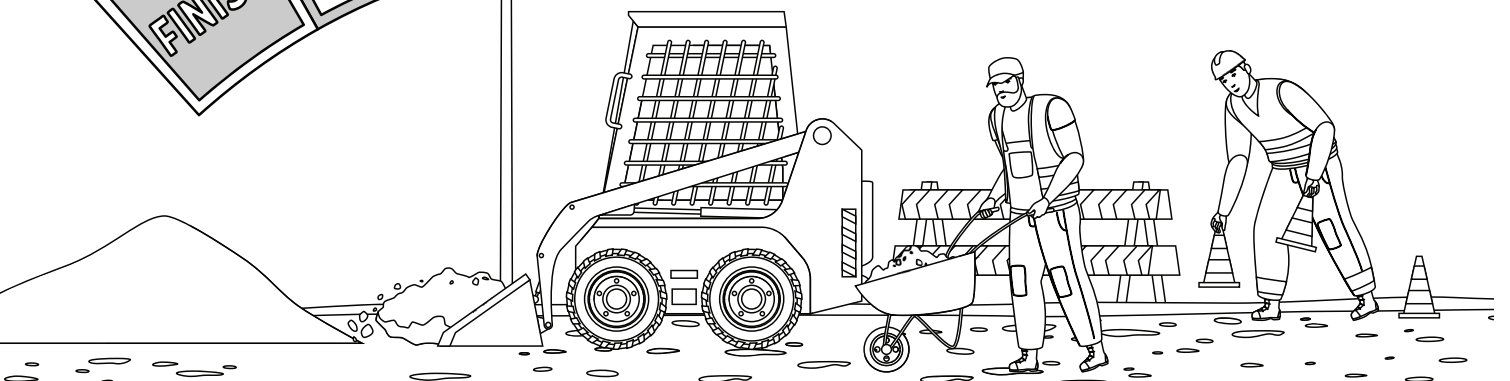
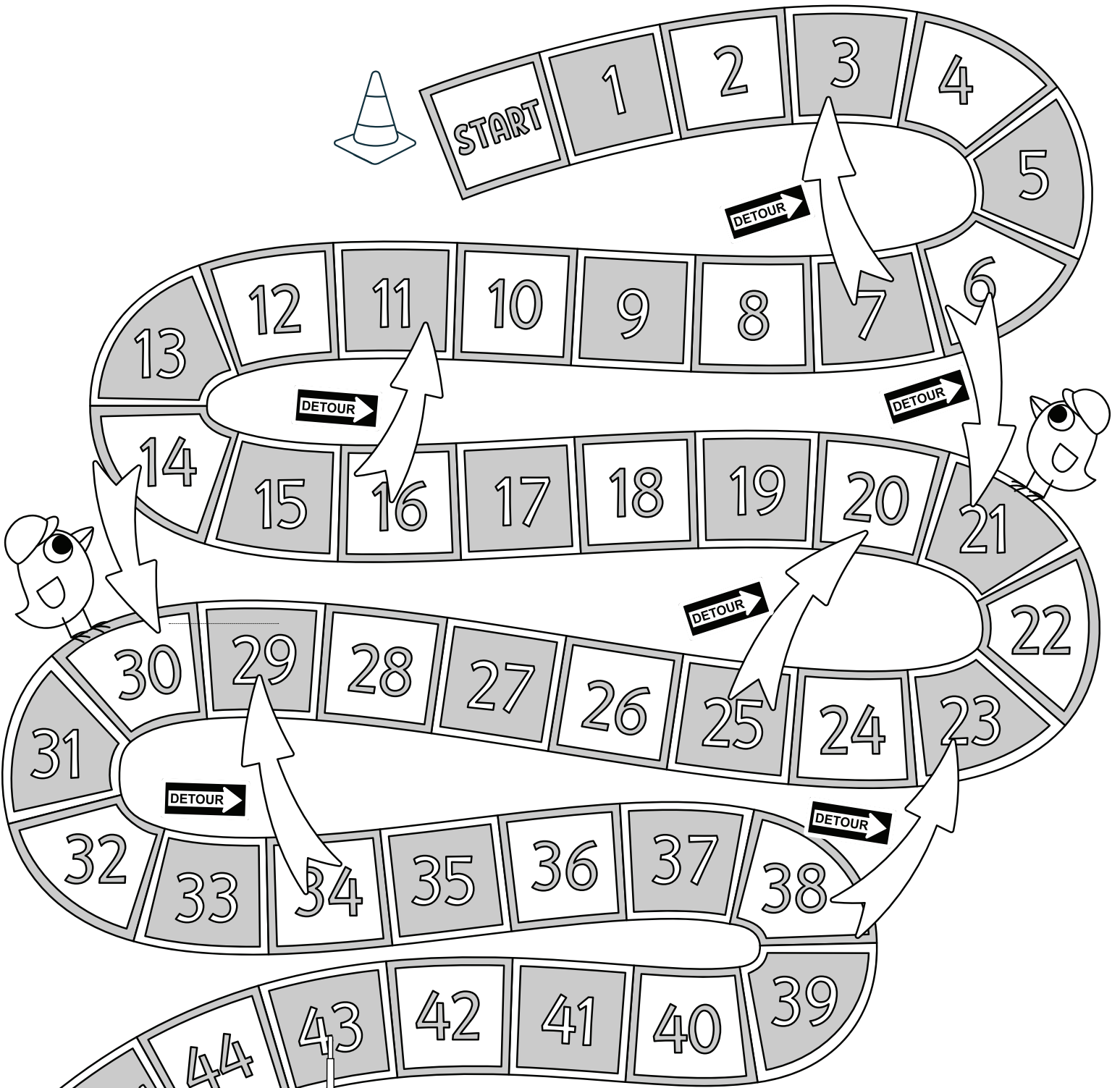

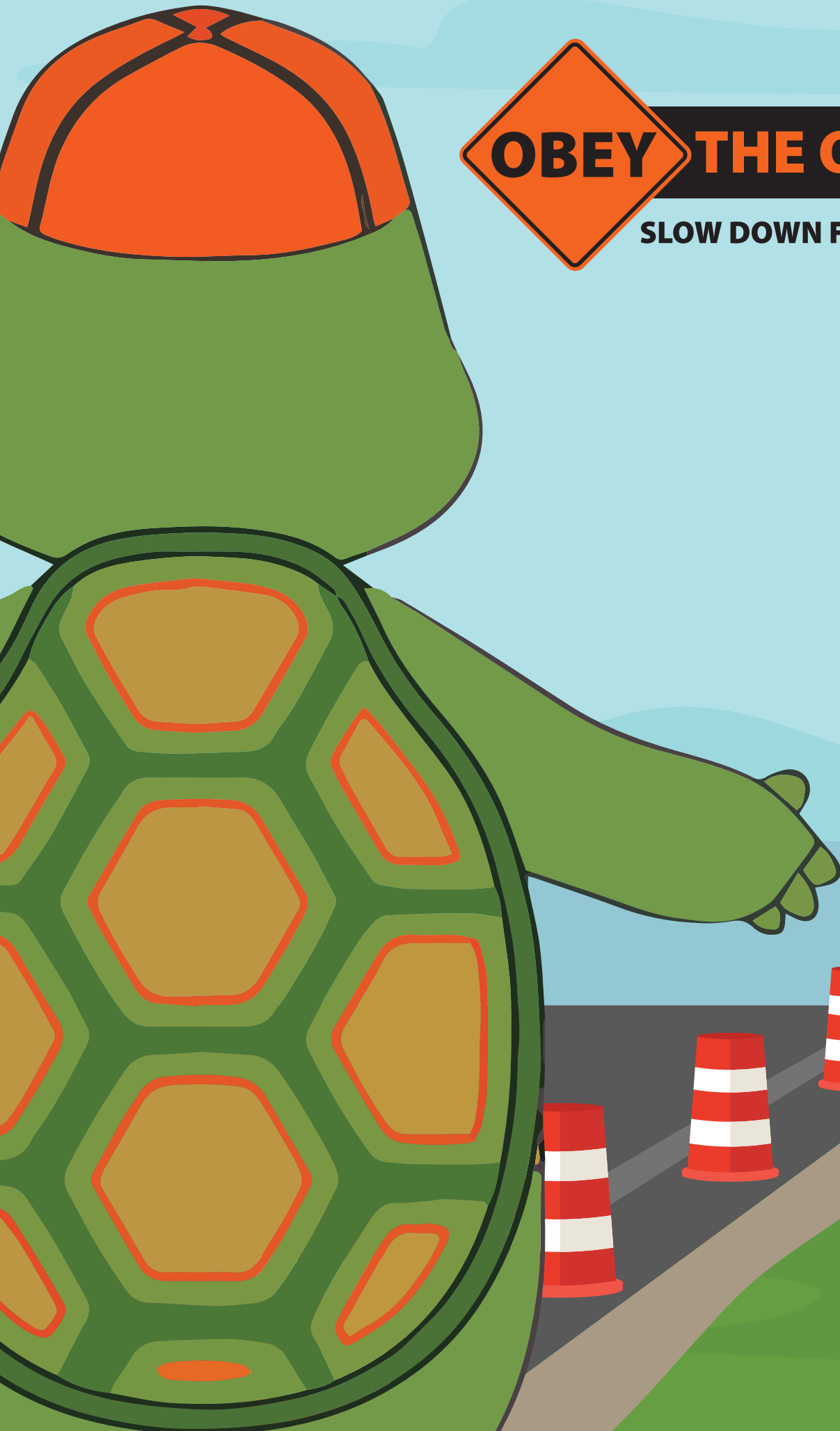

THE ORANGE

SLOW DOWN FOR WORK ZONES

