

Masonry Chimneys and Fireplaces

*Presented by
Brian Platz, BO, Town of New Canaan
for the*

*Office of Education and Data Management
Spring 2016 Career Development Series*

Sec. R1003 Masonry Chimneys

- R1003.1 Definition
- A masonry chimney is a chimney constructed of **solid** masonry units, hollow masonry units grouted **solid**, stone or concrete, hereinafter referred to as masonry.







Sec R1001.2

Footings and Foundations

- Footings for masonry fireplaces and their chimneys shall be constructed of concrete or **solid** masonry at least 12" thick and shall extend at least 6" beyond the face of the fireplace or foundation wall on all sides. Footings shall be founded on natural, undisturbed earth or engineered fill below frost depth.

Sec R1001.2.1 Ash dump cleanout

- Cleanout openings located within foundation walls below fireboxes, when provided, shall be equipped with ferrous metal or masonry doors and frames constructed to remain tightly closed except when in use. Cleanouts shall be accessible and located so that ash removal will not create a hazard to combustible materials.





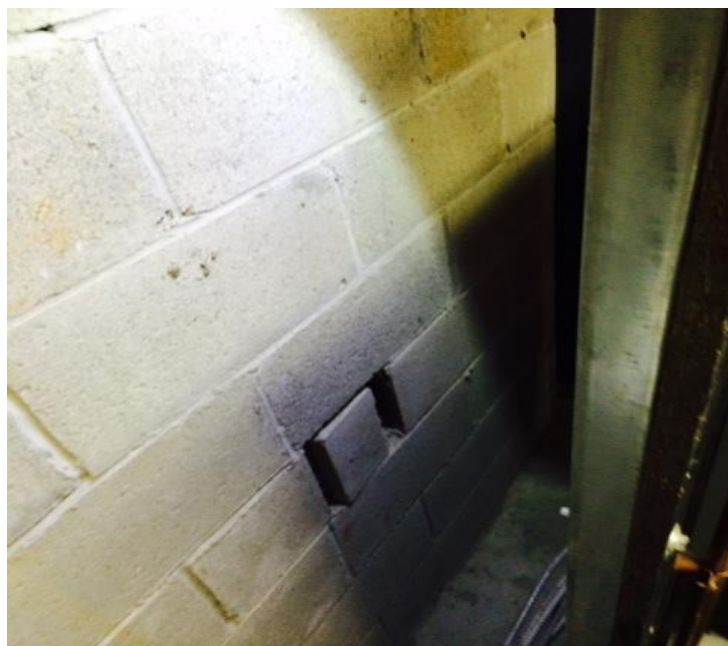

note

- Ash dumps **CAN** be used to run gas lines provided the ash dump at the floor of the firebox is sealed to prevent the escape of any leaked gas into the building. Keep in mind that the code governs other issues regarding fuel gas piping in concealed locations one of which is protecting the line from being in contact with corrosive material.

Sec R1001.5 Firebox walls

- Masonry fireboxes shall be constructed of **SOLID** masonry units, hollow masonry units grouted **SOLID**, stone or concrete. The minimum thickness of back and side walls shall be 8 inches of **SOLID** masonry.
- Note this dimension refers to the firebox walls **NOT** the entire chimney or walls surrounding the length of the flue.





Sec R1001.6 Firebox dimensions

- The firebox of a concrete or masonry fireplace shall have a minimum depth of 20 inches. The throat shall be not less than 8 inches above the fireplace opening. The throat opening shall not be less than 4 inches deep. The cross-sectional area of the passageway above the firebox including the throat, damper, and smoke chamber, shall not be less than the cross-sectional area of the flue.



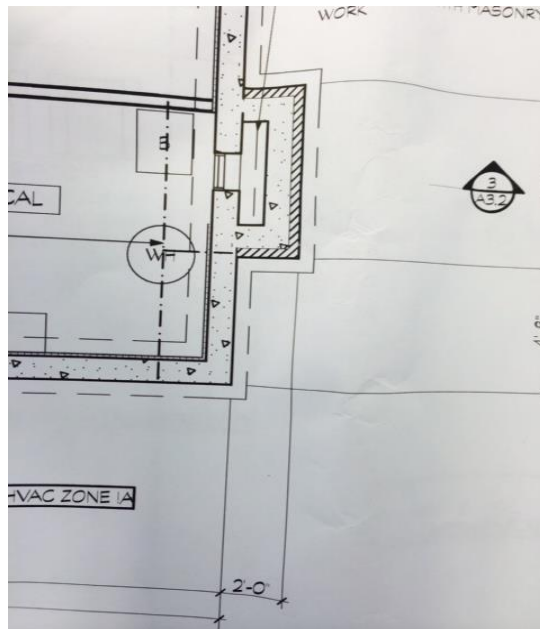

Exception

- Rumford fireplaces shall be permitted provided the depth of the fireplace is at least 12 inches and at least one-third of the width of the fireplace opening.

Rumford Fireplace

...Components by Superior Clay Corp.

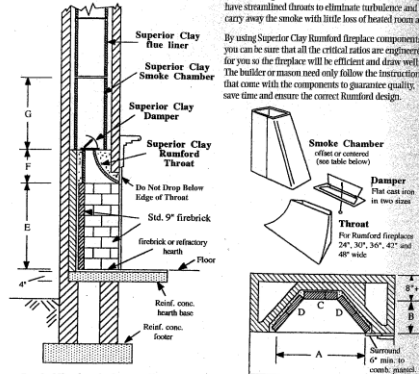

Rumford Fireplaces by Superior Clay

FIREPLACE SIZE	THROAT (H x W)	DAMPERS (H x W)	SMOKE CHAMBER (H x W)	HEARTH (H x W)	OTHER DIMENSIONS					
					A	B	C	D	E	F
24\"/>										

Sec R1001.8 Smoke chamber

- Smoke chamber walls shall be constructed of **SOLID** masonry units, hollow masonry units grouted **SOLID**, stone or concrete. The total minimum thickness of front, back and side walls shall be 8 inches of **SOLID** masonry. The inside surface shall be parged smooth with refractory mortar conforming to ASTM C 1261.

Sec R1001.9 Hearth & hearth ext.

- Masonry fireplace hearth & hearth ext. shall be constructed of concrete or masonry, supported by noncombustible materials, and reinforced to carry their own weight and all imposed loads. No combustible material shall remain against the underside of hearths and hearth extensions after construction.
- R1001.9.1 Hearth thickness min 4 inches
- R1001.9.2 Hearth ext. thickness min 2 inches





NOTE

- The code does not give a specific design criteria regarding the construction of the hearth ext. for the size or spacing of rebar etc.

Sec R1001.10 Hearth ext. dimensions

- Hearth extensions shall extend at least 16" in front of and at least 8" beyond each side of the fireplace opening. Where the fireplace opening is 6 square feet or larger, the hearth ext. shall extend at least 20" in front of and at least 12" beyond each side of the fireplace opening.



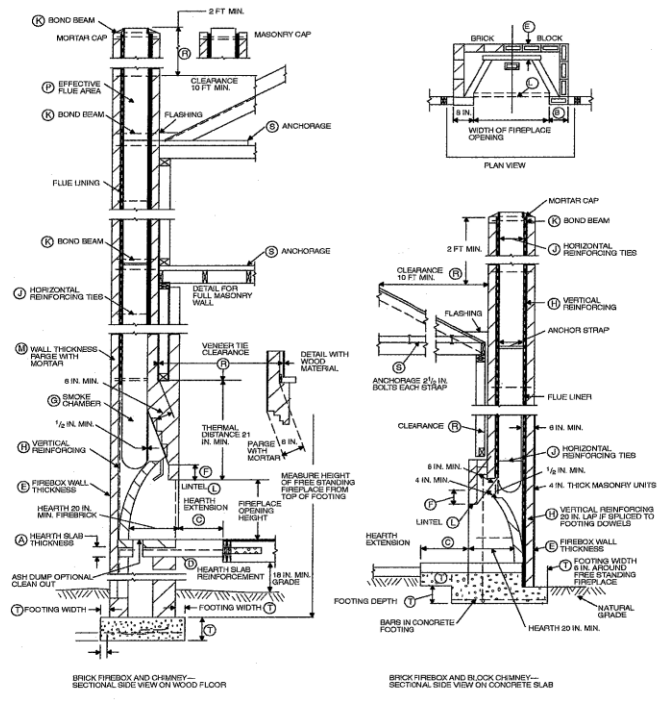
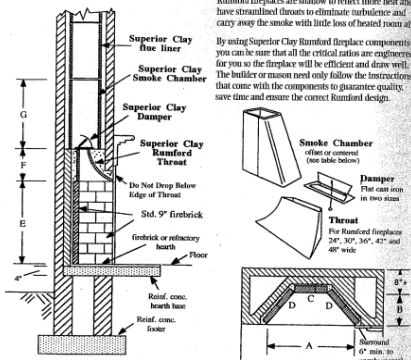

TABLE R1001.1
SUMMARY OF REQUIREMENTS FOR MASONRY FIREPLACES AND CHIMNEYS

ITEM	LETTER ^a	REQUIREMENTS
Hearth slab thickness	A	4"
Hearth extension (each side of opening)	B	8" fireplace opening < 6 square foot. 12" fireplace opening ≥ 6 square foot.
Hearth extension (front of opening)	C	16" fireplace opening < 6 square foot. 20" fireplace opening ≥ 6 square foot.
Hearth slab reinforcing	D	Reinforced to carry its own weight and all imposed loads.
Thickness of wall of firebox	E	10" solid brick or 8" where a firebrick lining is used. Joints in firebrick 1/8" maximum.
Distance from top of opening to throat	F	8"
Smoke chamber wall thickness Unlined walls	G	6" 8"
Chimney Vertical reinforcing ^b	H	Four No. 4 full-length bars for chimney up to 40' wide. Add two No. 4 bars for each additional 40' or fraction of width or each additional flue.
Horizontal reinforcing	J	1/4" ties at 18" and two ties at each bend in vertical steel.
Bond beams	K	No specified requirements.
Fireplace lintel	L	Noncombustible material.
Chimney walls with flue lining	M	Solid masonry units or hollow masonry units grouted solid with at least 4 inch nominal thickness.
Distances between adjacent flues	—	See Section R1003.13.
Effective flue area (based on area of fireplace opening)	P	See Section R1003.15.
Clearances: Combustible material Mantel and trim Above roof	R	See Sections R1001.11 and R1003.18. See Section R1001.11, Exception 4. 3' at roofline and 2' at 10'.
Anchorage ^b Strap Number Embedment into chimney Fasten to Bolts	S	3/16" x 1" Two 12" hooked around outer bar with 6" extension. 4 joists Two 1/2" diameter.
Footing Thickness Width	T	12" min. 6" each side of fireplace wall.

For SI: 1 inch = 25.4 mm, 1 foot = 304.8 mm, 1 square foot = 0.0929 m².
 Note: This table provides a summary of major requirements for the construction of masonry chimneys and fireplaces. Letter references are to Figure R1001.1, which shows examples of typical construction. This table does not cover all requirements, nor does it cover all aspects of the indicated requirements. For the actual mandatory requirements of the code, see the indicated section of text.
 a. The letters refer to Figure R1001.1.
 b. Not required in Seismic Design Category A, B or C.

Rumford Fireplace ...Components by Superior Clay Corp.



Tall and elegant... the fireplace that keeps you warm. Rumford fireplaces are shallow to reflect more heat and have streamlined flues to eliminate turbulence and carry away the smoke with little loss of heated room air.

By using Superior Clay Rumford fireplace components you can be sure that all the critical ratios are engineered for you so the fireplace will be efficient and draw well. The builder or mason need only follow the instructions that come with the components to guarantee quality, save time and ensure the correct Rumford design.

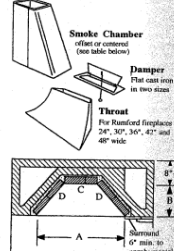

FIREPLACE SIZE	THROAT SIZE	DAMPER THROAT	SMOKE CHAMBER THROAT	FLUE TILE SIZE	OTHER DIMENSIONS						
					A	B	C	D	F		
24" wide	24" x 12"	5.5" x 11"	8.5" x 20" x 18"	8.5" x 13"	20"	12"	13.5"	11.5"	24" x 28"	12"	13"
30" wide	30" x 12"	5" x 24"	13" x 20" x 18"	13" x 13"	30"	12"	13.5"	11.5"	30" x 32"	12"	16"
36" wide	36" x 18"	5" x 24"	13" x 30" x 18"	13" x 13"	36"	18"	13.5"	18"	36" x 38"	14"	18"
42" wide	42" x 12"	5" x 30"	13" x 30" x 18"	13" x 18"	42"	12"	15"	21"	36" x 42"	15"	20"
48" wide	48" x 18"	5" x 30"	16" x 36" x 18"	16" x 20"	48"	18"	18"	22.5"	42" x 48"	16"	20"

Sec R1001.11 Fireplace clearance

- All wood beams, joists, studs and other combustible material shall have a clearance of not less than 2" from the front faces and sides, and not less than 4" from the back faces of masonry fireplaces (change from CABO.) The air space shall not be filled, except to provide fire blocking in accordance with sec R1001.12

Note

- There is no mention of a clearance to combustibles for the front or sides of the hearth extension.

Exceptions

- 1) Masonry fireplaces listed and labeled for use in contact with combustibles in accordance with UL 127 and installed in accordance with the manufacturer's installation instructions.
- 2) When masonry fireplaces are part of masonry or concrete walls, combustible materials shall not be in contact with the masonry or concrete walls less than 12" from the inside surface of the nearest firebox lining.

Exceptions continued

- 3) Exposed combustible trim and the edges of sheathing materials such as wood siding, flooring and drywall shall be permitted to abut the masonry fireplace side walls and hearth extension in accordance with R1001.11, provided such combustible trim or sheathing is a minimum of 12" from the nearest firebox lining.







Exceptions continued

- 4) Exposed combustible mantels or trim may be placed directly on the masonry fireplace front surrounding the fireplace opening providing such combustible materials are not placed within 6" of a fireplace opening. Combustible material within 12" of the fireplace opening shall not project more than 1/8" for each 1-inch distance from such an opening.

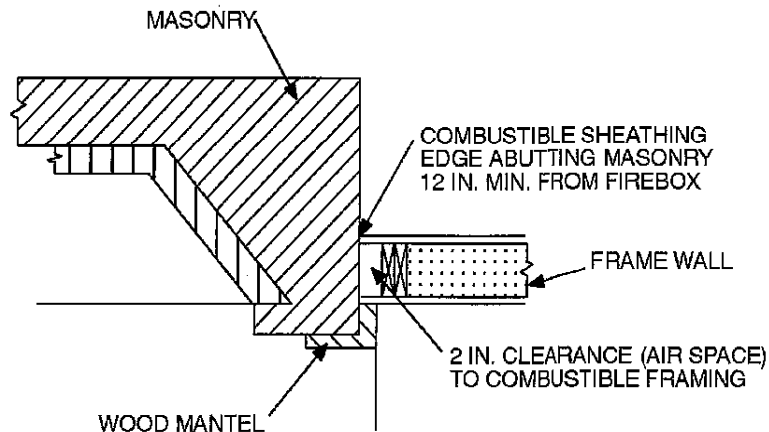

**FIGURE R1001.11
CLEARANCE FROM COMBUSTIBLES**

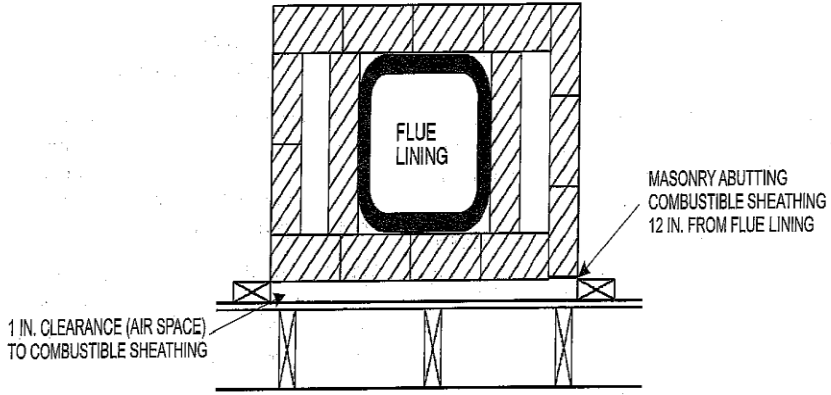

For SI: 1 inch = 25.4 mm.





Sec R1001.12 Fireplace fire blocking

- You're gonna love this!!!!!!!!!!!!!!
- Fireplace fire blocking shall comply with the provisions of sec R602.8

Sec R602.8 Fire blocking required

- Fire blocking shall be provided in accordance with sec R302.11

Sec R302.11 Fire blocking

- In combustible construction, fire blocking shall be provided to cut off all concealed draft openings (both vertical & horizontal) and to form an effective fire barrier between stories, and between a top story and the roof space.
 - Fire blocking shall be provided in wood frame construction in the following locations;
#5. For fire blocking of chimneys and fireplaces, see section R1003.19

Sec R1003.19 Chimney fire blocking

- **FINALLY WE'VE ARRIVED**
- **All spaces between chimneys and floors and ceilings through which chimneys pass shall be fire blocked with noncombustible material securely fastened in place. The fire blocking of spaces between chimneys and wood joists, beams, or headers shall be self-supporting or be placed on strips of metal or metal lath laid across the spaces between combustible material and the chimney.**

Note

- The code offers several code compliant methods, it is not our function to tell them how to achieve compliance.





Sec R1003.8 Additional load

- Chimneys shall not support loads other than their own weight unless they are designed and constructed to support the additional load. Construction of masonry chimneys as part of the masonry walls or reinforced concrete walls of the building shall be permitted.
- This brings us back to R1001.11 fireplace clearance exception #2 which reads “when masonry fireplaces are part of masonry or concrete walls, combustible materials shall not be in contact with the masonry or concrete walls less than 12” from the inside surface of the nearest firebox lining.”
- This language is repeated in sec R1003.18 exception 2.









Sec R1003.8 Commentary (not code)

- Chimneys are subject to considerable stress resulting from thermal effects and therefore should not support any structural load other than their own weight, unless specifically designed as a supporting member for the additional load. Also because of its heavy mass, a chimney will tend to settle more than the building structures. As a consequence the chimney and any part of the building that it supports will settle at a greater rate and to a greater degree than the rest of the building, resulting in damage.





Note

- We do **NOT** determine whether or not they can impose additional loads this should be referred to the design professional of record and you should get his/her approval in writing.

Sec R1003.9 Termination

- Chimneys shall extend at least 2 feet higher than any portion of the building within 10 feet, but shall not be less than 3 feet above the highest point where the chimney passes through the roof.

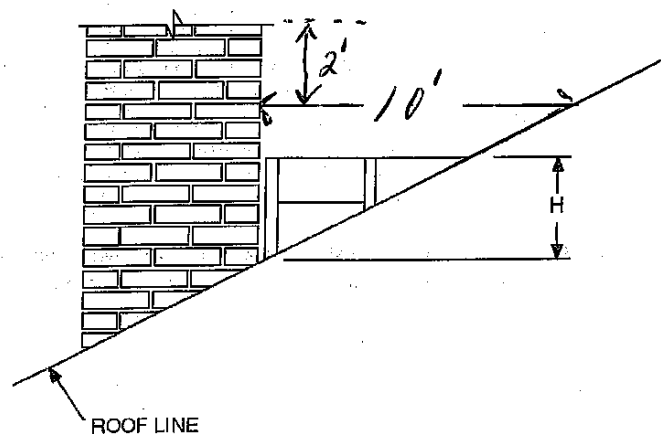

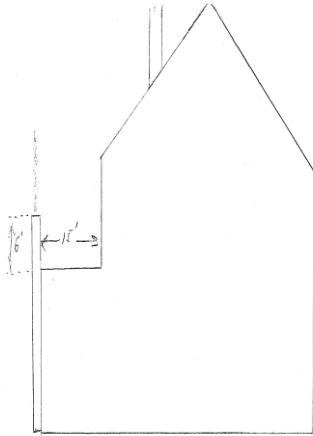

Sec R1003.10 Wall thickness

- Masonry chimney walls shall be constructed of **solid** masonry units or hollow masonry units grouted **solid** with not less than a 4-inch nominal wall thickness.

Sec R905.2.8.4 Other Flashing

- Flashing against a vertical front wall, as well as soil stack, vent pipe and chimney flashing, shall be applied according to the asphalt shingle manufacturer's printed instructions.
- Note; the code does not require flashing to the flue unless the manufacturer specifies such. In my limited research most manufacturer's **DO NOT**.

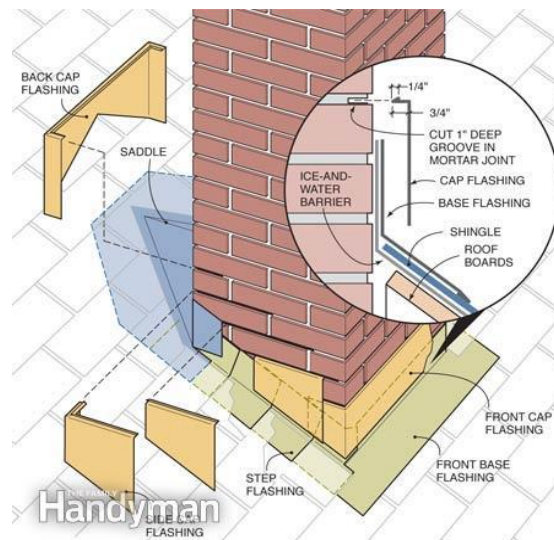

Cedar Shake & Shingle Bureau (referenced standard)

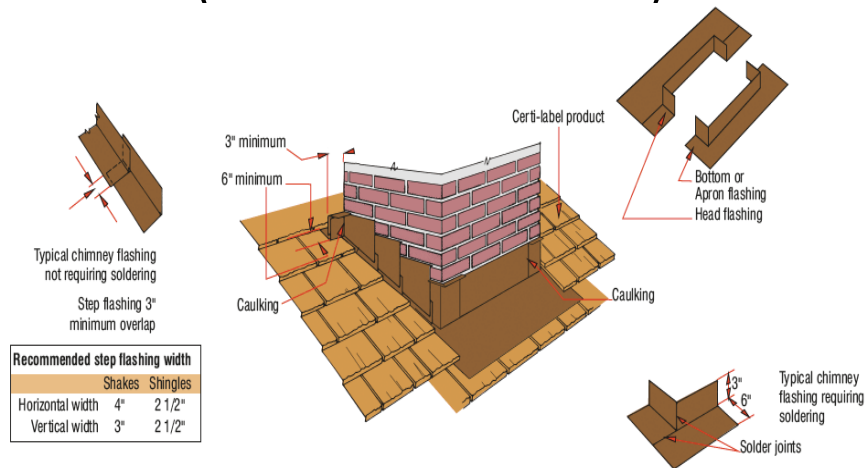

Figure 14c: Typical Projection Flashing

Figure 14c: Typical Projection Flashing

R1003.20 Chimney Crickets

- Chimneys shall be provided with crickets when the dimension parallel to the ridgeline is greater than 30 inches and does not intersect the ridgeline. The intersection of the cricket and chimney shall be flashed and counter-flashed in the same manner as normal roof-chimney intersections. Crickets shall be constructed in compliance with Figure R1003.20 and Table R1003.20

Sec R1003.20 Commentary **NOT CODE**

- ❖ Chimney crickets are required when the chimney width parallel to the ridgeline is more than 30 inches (762 mm), provided the chimney does not intersect the ridgeline. The cricket diverts the flow of water from the roof around the chimney. Flashing is required between the cricket and the chimney, as it is in other roof-chimney intersections.

Table R1003.20

**TABLE R1003.20
CRICKET DIMENSIONS**

ROOF SLOPE	H
12 - 12	$\frac{1}{2}$ of W
8 - 12	$\frac{1}{3}$ of W
6 - 12	$\frac{1}{4}$ of W
4 - 12	$\frac{1}{6}$ of W
3 - 12	$\frac{1}{8}$ of W

- ❖ Table R1003.20 establishes the height of chimney crickets as depicted in Figure R1003.20. For example, a cricket installed at the face of a chimney that is 4 feet wide (1219 mm) on a 6:12 roof slope, would need to be 1 foot high (305 mm) ($\frac{1}{4}$ of 4 feet).

Figure R1003.20

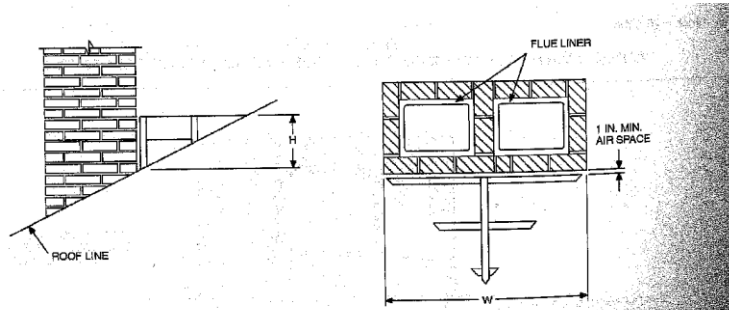

For SI: 1 inch = 25.4 mm.

FIGURE R1003.20
CHIMNEY CRICKET

❖ Figure R1003.20 depicts the height of chimney crickets and the clearance of combustibles to the chimney.

Sec R1003.12 Clay flue lining

- Clay flue liners shall be installed in accordance with ASTM C 1283 and extend from a point not less than 8" below the lowest inlet or, in the case of fireplaces, from the top of the smoke chamber to a point above the enclosing walls. The lining shall be carried up vertically, with a maximum slope no greater than 30 degrees from the vertical.

Sec R1003.12 Continued

- Clay flue liners shall be laid in medium-duty water insoluble refractory mortar conforming to ASTM C 199 with tight mortar joints left smooth on the inside and installed to maintain an air space or insulation not exceed the thickness of the flue liners from the interior face of the chimney masonry walls. Only enough mortar shall be placed to make the joint and hold the liners in position.





Sec R1003.13 Multiple flues

- When two or more flues are located in the same chimney, masonry wythes shall be at least 4 inches thick and bonded into the walls of the chimney.

Sec R1003.13 exception

- When venting only one appliance, two flues may adjoin each other in the same chimney with only the flue lining separation between them. The joints of the adjacent flue linings shall be staggered at least 4 inches.



- **Wythe**
- From Wikipedia, the free encyclopedia
- A **wythe** is a continuous vertical section of [masonry](#) one unit in thickness. A wythe may be independent of, or interlocked with, the adjoining wythe(s). A single wythe of [brick](#) that is not structural in nature is referred to as a veneer.
- A multiple-wythe masonry wall may be composed of a single type of masonry unit layered to increase its thickness and structural strength, or different masonry units chosen by function, such as an economical concrete block serving a structural purpose and a more expensive brick chosen for its appearance.
- **wythe** (*plural* [wythes](#))
- A unit of thickness in [masonry](#) construction defined by the quantity of masonry units 4" or greater. *That wall has to be at least three wythes of brick to support your load.*



Note

- Keep in mind we have three or more dissimilar materials in masonry chimney construction. These materials react very differently to temperature, time, and moisture.
- CMU's
- Mortar
- Brick
- Clay tile
- Stone and or marble veneers



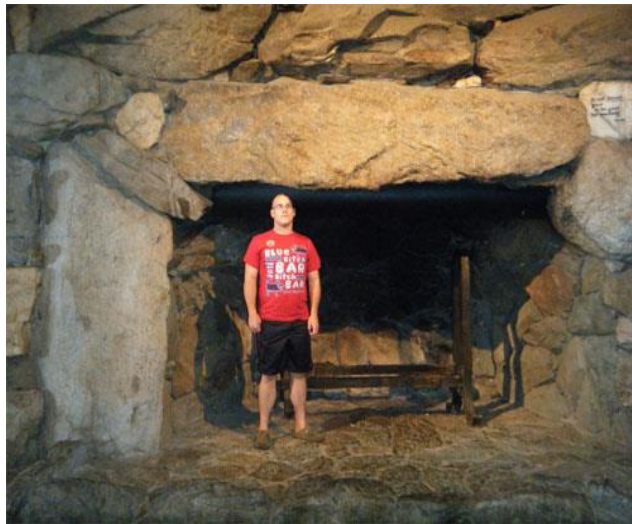
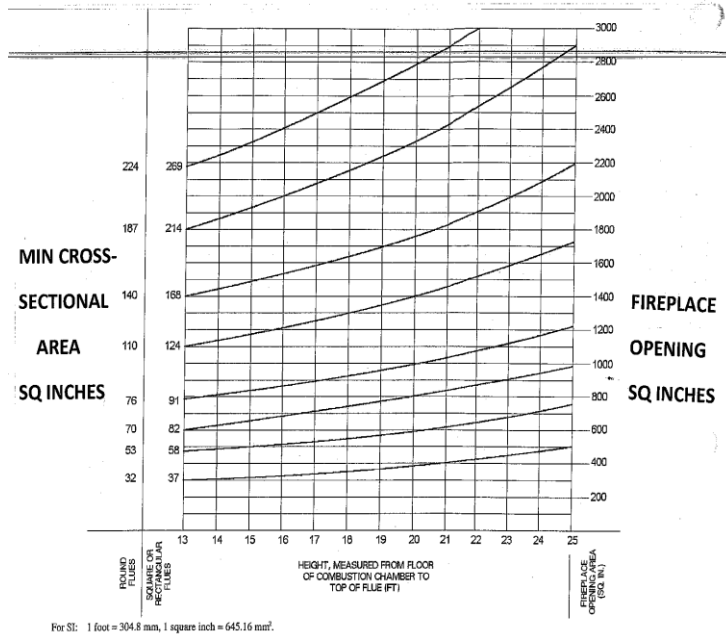

TABLE R1003.14(1)
NET CROSS-SECTIONAL AREA OF ROUND FLUE SIZES^a

FLUE SIZE, INSIDE DIAMETER (inches)	CROSS-SECTIONAL AREA (square inches)
6	28
7	38
8	50
10	78
10 ³ / ₄	90
12	113
15	176
18	254

For SI: 1 inch = 25.4 mm, 1 square inch = 645.16 mm².

a. Flue sizes are based on ASTM C 315.

TABLE R1003.14(2)
NET CROSS-SECTIONAL AREA OF SQUARE AND
RECTANGULAR FLUE SIZES

FLUE SIZE, OUTSIDE NOMINAL DIMENSIONS (inches)	CROSS-SECTIONAL AREA (square inches)
4.5 × 8.5	23
4.5 × 13	34
8 × 8	42
8.5 × 8.5	49
8 × 12	67
8.5 × 13	76
12 × 12	102
8.5 × 18	101
13 × 13	127
12 × 16	131
13 × 18	173
16 × 16	181
16 × 20	222
18 × 18	233
20 × 20	298
20 × 24	335
24 × 24	431

For SI: 1 inch = 25.4 mm, 1 square inch = 645.16 mm².

- From Wikipedia, the free encyclopedia
- Jump to: [navigation](#), [search](#)
- Basic principle of corbeled arch design.
- Comparison of a *corbel arch* (right) and a generic "true" stone [arch](#) (left).
- A **corbel arch** (or **corbeled / corbelled arch**) is an arch-like construction method that uses the [architectural](#) technique of [corbeling](#) to span a space or void in a structure, such as an entranceway in a wall or as the span of a bridge. A **corbel vault** uses this technique to support the superstructure of a building's roof.
- A corbel arch is constructed by offsetting successive courses of stone (or brick) at the springline of the walls so that they project towards the archway's center from each supporting side, until the courses meet at the apex of the archway (often, the last gap is bridged with a flat stone). For a corbeled vault covering the technique is extended in three dimensions along the lengths of two opposing walls.

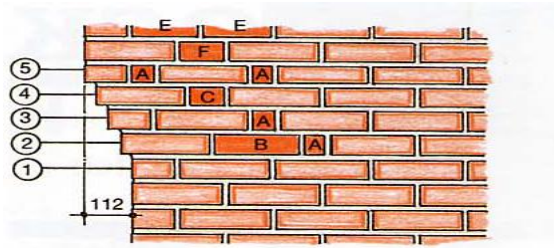

Elevation A

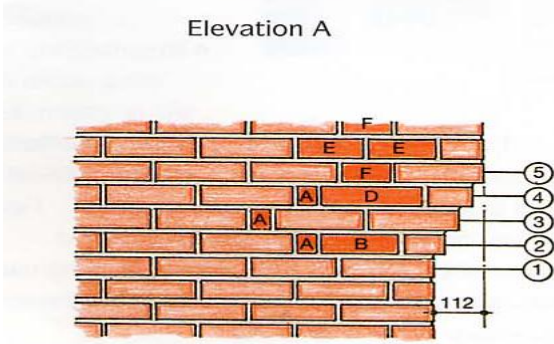

Elevation B



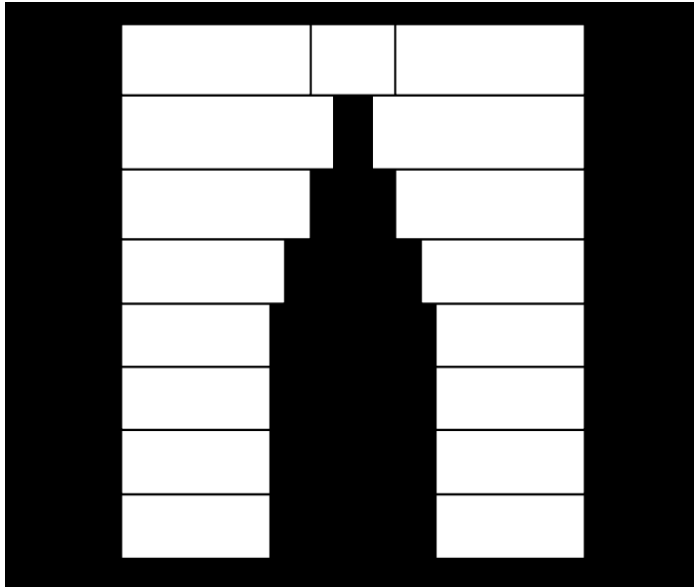

Sec R1006.0 Exterior air

- Factory built or masonry fireplaces covered in this chapter shall be equipped with an exterior air supply to assure proper fuel combustion unless the room is mechanically ventilated and controlled so that the indoor pressure is neutral or positive.



Sec R1006.1.2

- Listed combustion air ducts for masonry fireplaces shall be installed according to the terms of their listing and the manufacturer's instructions.

Sec R1006.2 Exterior air intake

- The exterior air intake shall be capable of supplying all combustion air from the exterior of the dwelling or from spaces within the dwelling ventilated with outside air such as non mechanically ventilated crawl or attic spaces. The exterior air intake shall **NOT** be located within the garage or basement of the dwelling nor shall the air intake be located at an elevation higher than the firebox (see sec R1006.5.) The exterior air intake shall be covered with a corrosion-resistant screen of ¼" mesh.

Sec R1006.3 Clearance

- Unlisted combustion air ducts shall be installed with a minimum 1-inch clearance to combustibles for all parts of the duct within 5 feet of the duct outlet.

Sec R1006.4 Passageway

- The combustion air passageway shall be a minimum of 6 square inches ($(\pi (3.14) \cdot R^2)$) and not more than 55 square inches, except that combustion air systems for listed fireplaces shall be constructed according to the fireplace manufacturer's instructions.

Sec R1006.5 Outlet

- Locating the exterior air outlet in the back (change from CABO) or sides of the firebox chamber or within 24 of the firebox opening on or near the floor is permitted. The outlet shall be closable and designed to prevent burning material from dropping into concealed combustible spaces.

Sec. N1102.4.2 Fireplaces

- New wood burning fireplaces shall have tight-fitting flue dampers and outside combustion air.

Table N1102.4.1.1

Air barrier & insulation installation

- An air barrier shall be installed on fireplace walls. Fireplaces shall have gasketed doors.

ENERGY EFFICIENCY

Sections 6 through 8 for vertical fenestration, and 0.75 in. for skylights. The area-weighted average U-factor for fenestration shall be 0.50. Fenestration U-factor permitted using windows from Section N105 in Zones 1 through 3 shall be 0.50.

**SECTION N1103
SYSTEMS**

N1103.1 (R402.4.2) Controls (Mandatory). At least one thermostat shall be provided for each separate heating and cooling system.

N1103.1.1 (R402.4.2.1) Programmable thermostat. Where the primary heating system is a forced-air furnace, at least one thermostat per dwelling unit shall be capable of controlling the heating and cooling system on a daily schedule to maintain different temperature set points at different times of the day. This thermostat shall include the capability to set back or temporarily operate the system to maintain zone temperatures down to 55°F (13°C) or up to 85°F (29°C). The thermostat shall initially be programmed with a heating temperature set point no higher than 68°F (20°C).

**TABLE N1103.4.1.1 (R402.4.1.1)
AIR BARRIER AND INSULATION INSTALLATION**

COMPONENT	CONCRETA
Air barrier and thermal barrier	A continuous air barrier shall be installed in the building envelope. Exterior thermal envelope contains a continuous air barrier. Breaks or joints in the air barrier shall be sealed. Air-permeable insulation shall not be used as a sealing material.
Acoustic	The air barrier in any dropped ceiling/ceiling shall be aligned with the insulation and any gaps in the air barrier sealed.
Attic	Access openings, drop-down stairs or knee wall doors to unconditioned attic spaces shall be sealed.
Basement	Corers and headers shall be insulated and the junction of the foundation and sill plate shall be sealed.
Chimney	The junction of the top plate and top of exterior walls shall be sealed.
Exterior	Exterior thermal envelope insulation for framed walls shall be installed in substantial contact and continuous alignment with the air barrier.
Knee walls	Knee walls shall be sealed.
Windows, skylights and doors	The space between window/door jamb and framing and skylights and framing shall be sealed.
Rim joists	Rim joists shall be insulated and include the air barrier.
Roofs	Insulation shall be installed to maintain permanent contact with underside of eave/soffit decking.
Roofs (including above-garage and cantilevered floors)	The air barrier shall be installed at any exposed edge of insulation.
Crawl space walls	When provided in lieu of floor insulation, insulation shall be permanently attached to the crawlspace walls.
Crawl space walls	Exposed earth in unvented crawl spaces shall be covered with a Class I vapor retarder with overlapping joints taped.
Shafts, penetrations	Door shafts, entry penetrations, and flue shafts opening to exterior or unconditioned space shall be sealed.
Narrow cavities	Batts in narrow cavities shall be cut to fit, or narrow cavities shall be filled by insulation that on installation readily conforms to the available cavity space.
Storage separation	Air sealing shall be provided between the garage and conditioned spaces.
Recessed lighting	Recessed light fixtures installed in the building thermal envelope shall be air tight, IC rated, and sealed to the drywall.
Plumbing and wiring	Batt insulation shall be cut steady to fit around wiring and plumbing in exterior walls, or insulation that on installation readily conforms to available space shall extend behind piping and wiring.
Showers on exterior wall	Exterior walls adjacent to showers and tubs shall be insulated and the air barrier installed separating them from the showers and tubs.
Electrical/phone box on exterior walls	The air barrier shall be installed behind electrical or communication boxes or air-sealed boxes shall be installed.
HVAC register boots	HVAC register boots that penetrate building thermal envelope shall be sealed to the sub-floor or drywall.
Fireplaces	An air barrier shall be installed on fireplace walls. Fireplaces shall have gasketed doors.

485

2012 INTERNATIONAL RESIDENTIAL CODE®

2012 IECC Sec. R402.4.2 Fireplaces

- New wood burning fireplaces shall have tight-fitting flue dampers and outdoor combustion air.



First flue inspection

- Depth of the firebox.
- Fresh air intake, material and inlet/outlet.
- Smoke chamber, parged smooth.
- Clearance to combustibles.
- **Solid** masonry where required.
- Offset of damper to flue.
- Air space between combustible sheathing & chimney.
- Hearth extension dimensions.
- These are tough violations to correct if not noted until the C of O inspection!

Final inspection

- Veneer is solidly grouted and sealed to face of fireplace.
- Hearth extension.
- Remove combustibles from underside of hearth extension.
- Access to ash dump cleanout.
- Combustible mantel and trim.
- Smoke curtain 8" from damper opening to firebox opening.
- Gasketed doors.



THANK YOU